



# Slush/Chilled Drinks Dispenser Instruction Manual



**Model  
GF489**

## Safety Tips

- Position on a flat, stable surface.
- A service agent/qualified technician should carry out installation and any repairs if required. Do not remove any components on this product.
- Consult Local and National Standards to comply with the following:
  - Health and Safety at Work Legislation
  - BS EN Codes of Practice
  - Fire Precautions
  - IEE Wiring Regulations
  - Building Regulations
- DO NOT immerse the appliance in water, or use jet/pressure washers to clean the appliance
- Do not use the appliance for anything other than its intended use.
- Always switch off and disconnect the power supply to the appliance when not in use.
- Not suitable for outdoor use.
- Keep all packaging away from children. Dispose of the packaging in accordance to the regulations of local authorities.
- If the power cord is damaged, it must be replaced by a POLAR agent or a recommended qualified technician in order to avoid a hazard.
- This appliance is not intended for use by persons (including children) with reduced physical, sensory or mental capabilities, or lack of experience and knowledge, unless they have been given supervision or instruction concerning the use of the appliance by a person responsible for their safety.
- Children should be supervised to ensure that they do not play with the appliance

## Introduction

Please take a few moments to carefully read through this manual. Correct maintenance and operation of this machine will provide the best possible performance from your POLAR product.

## Pack Contents

The following is included:

- POLAR Slush / Chilled Drinks Dispenser
- Instruction Manual

POLAR prides itself on quality and service, ensuring that at the time of packaging the contents are supplied fully functional and free of damage.

Should you find any damage as a result of transit, please contact your POLAR dealer immediately

# Installation

**Note: If the appliance has not been stored or moved in an upright position, let it stand upright for approximately 12hours before operation. If in doubt allow the appliance to stand.**

1. Remove the appliance from the packaging and remove the protective film from all surfaces.
2. When positioning the dispenser, maintain a distance of 20cm (7 inches) between the appliance and walls or other objects for ventilation. Increase the distance if the obstacle is a heat source.
3. If necessary, adjust the screw feet of the dispenser to stabilise it.

## Control Panel

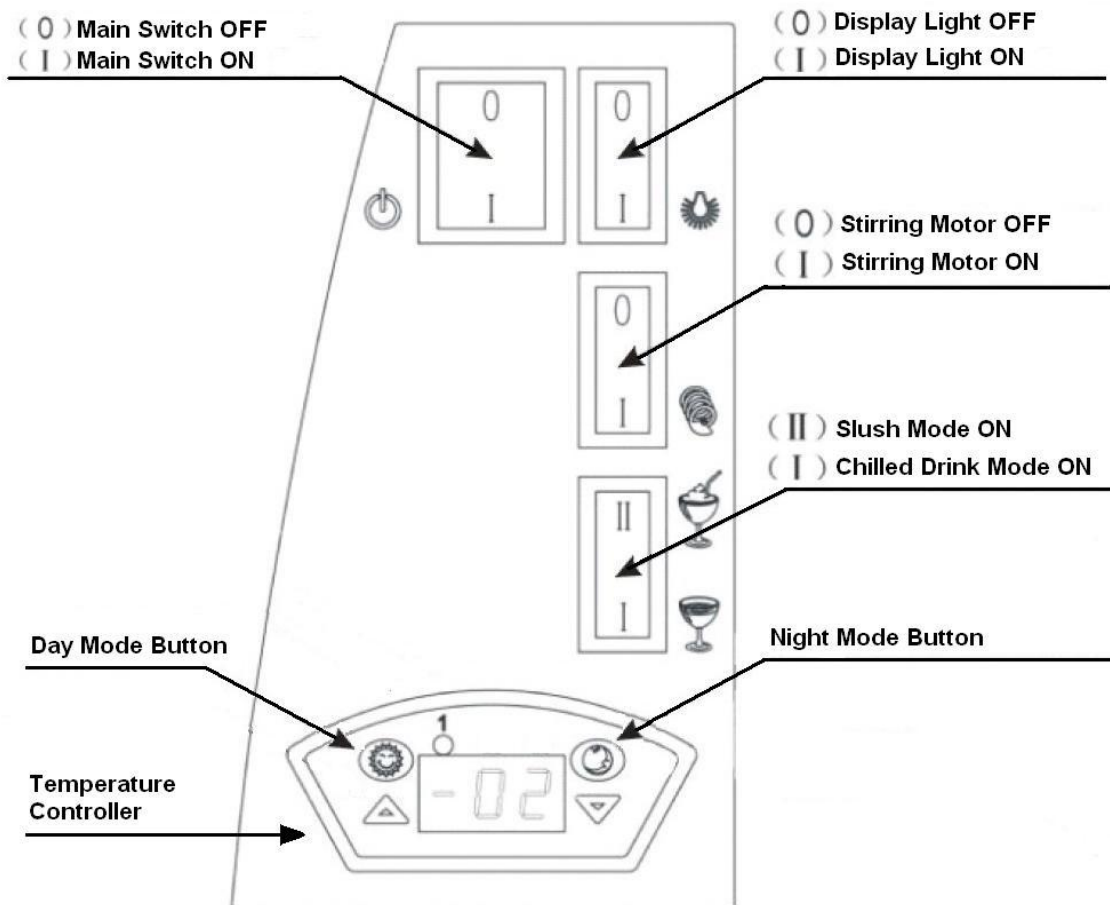

Fig. 1

# Operation

**NOTE: When in Slush mode this machine is designed for use with products with at least 12% sugar. It is the sugar content which stops the product from freezing solid in the bowl. While products with lower sugar content may run well in the machine they are more likely to cause freeze up of the machine and consequential damage to the unit. Such damage is not covered by warranty.**

**NOTE: Never mix the product in the bowl.**

**NOTE: Maintain the product at or above the minimum level marked on the bowl to prevent damage.**



## Filling

1. Switch off the main switch (see Fig 1)
2. Remove the lid and pour the liquid into the tank
3. Replace the lid

**NOTE: Do not fill the tank with hot liquid**

**NOTE: Do not let the level exceed the Max level line on the tank**

## Using the Dispenser for Slush

1. Turn on the main switch on the side of the dispenser (see Fig 1)
2. Switch the stirring motor to the On position (see Fig 1)
3. Switch controller to Daytime working mode by pressing  on the temperature controller (see Fig 1)
4. Ensure the mode selector switch is set to Slush setting  (see Fig 1)

**NOTE: Slush can only be produced in Daytime working mode.**

## Adjusting the Slush Consistency

The thickness of the slush consistency may be adjusted (+/-) using the screw located at the rear of the dispenser (see below). + for thicker consistency, - for thinner consistency (see Fig 2)

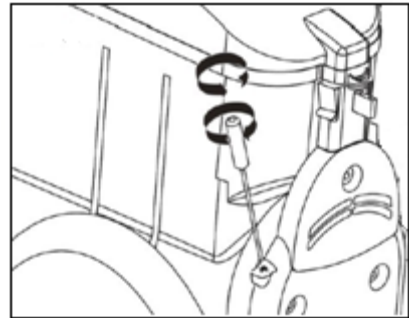



Fig 2

## Using the Dispenser for Chilled Drink

1. Turn on the main switch on the side of the dispenser (see Fig 1)
2. Switch the stirring motor to the On position (see Fig 1)
3. Switch controller to Daytime working mode by pressing  on the temperature controller (see Fig 1)
4. Ensure the mode selector switch is set to the Chilled Drink setting  (see Fig 1)



## Dispensing Product

To dispense product pull the tap lever.

**Note: During inactivity in Slush mode product may become frozen in tap. To clear tap open and close tap lever repeatedly until blockage clears and product can be dispensed. In extreme situations it may be necessary to allow product to warm in Chilled drinks mode until blockage is cleared**

## Day / Night Mode

The dispenser is fitted with a Night Mode for energy saving during non-serving periods.

1. Press  button on timer. The dispenser will enter energy saving mode. The product in the bowl will be held between 1C and 4C as chilled beverage.
2. Press  button to return dispenser to Day Mode.

## Display Lighting

The LED display lighting can be switched ON/OFF by pressing the  button (see Fig 1)

## Cleaning and Maintenance

- Always switch off and disconnect the power supply before cleaning
- Warm soapy water is recommended for cleaning. Cleaning agents may leave harmful residues. DO NOT wash the base unit, instead wipe the exterior with a damp cloth.
- Empty and clean the drip tray regularly.
- A POLAR agent or qualified technician should carry out repairs if required.

### Removing / dis-assembling the Tap for Cleaning

1. Remove the handle pin (A)
2. Remove the handle (B)
3. Remove the spring (C)
4. Remove the handle seat from the tap
5. Remove the tap piston and guide

To re-assemble and fit the tap reverse above

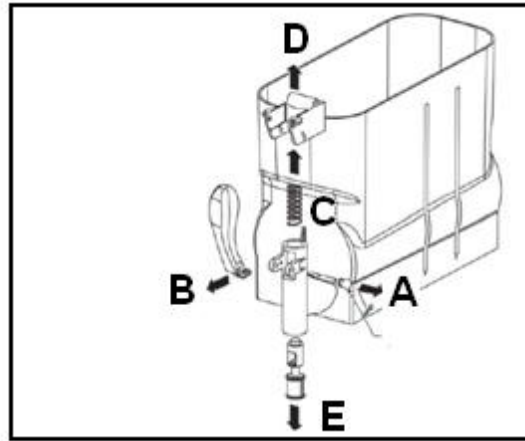

### Removing the Bowl

### Removing Lid

1. Lift rear of lid
2. Slide lid and remove

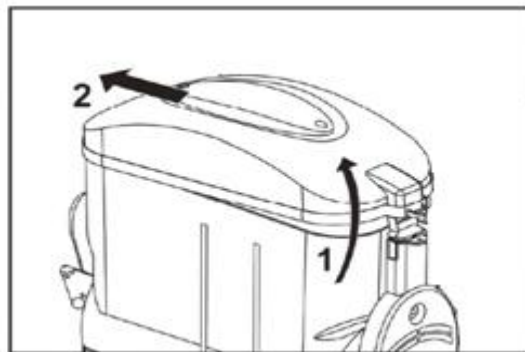

DO not submerge lid in liquid as this will damage the Display Light housed in the underside of the lid. Wipe clean with a damp cloth and sanitizing solution







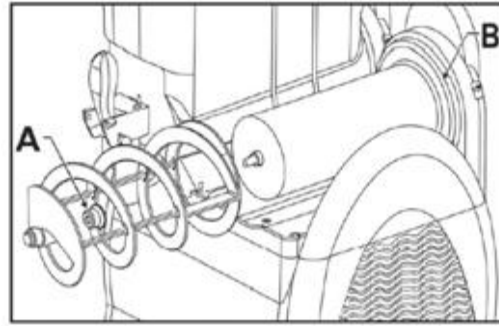
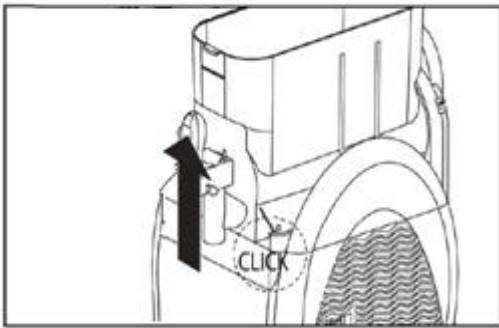

## Removing and Cleaning the Bowl and Stirring paddle

Ensure Lid and Tap are removed

1. Raise the front part of the bowl to release it
2. Remove the bowl from its seat by pushing and tapping lightly on the rear
3. Remove the stirring paddle and sealing gaskets (A and B)
4. Reverse steps 1-3 to reassemble. Lubricate the gaskets with water if the gaskets are too tight,
5. Fill the tank with clean water
6. Switch machine ON, select Chilled drinks mode and stirrer motor ON.
7. Run for 5 minutes then empty tank.



## Changing the Parameter Settings

1. Press  and  for three seconds to enter parameter setting mode. "E1" will flash.
2. Press button  to until desired parameter to change is displayed.
3. Press button  or  to increase / decrease value of the parameter.
4. Once parameter is changed wait 6 seconds to return to normal working mode
5. To lock parameters press button  and  till the code "888" flashes. Once the parameters are locked, they can be read, but cannot be modified.
6. To unlock parameters press button  and  until the code "ON" flashes.

Parameters	Function	Range	Factory Settings
E1	Temperature to be controlled for slush of Bowl One	-10 to +10°C/14°F to +50°F	-6°C/22F°
E2	Temperature to be controlled for slush of Bowl two (if fitted)	-10 to +10°C/14°F to +50°F	-6°C/22F°
E3	Temperature to be controlled for slush of Bowl three (if fitted)	-10 to +10°C/14°F to +50°F	-6°C/22F°
F1	Temperature to be controlled for cold beverage of Bowl One	-10 to +10°C/14°F to +50°F	1°C /33.8F°
F2	Temperature to be controlled for cold beverage of Bowl Two (if fitted)	-10 to +10°C/14°F to +50°F	1°C /33.8F°
F3	Temperature to be controlled for cold beverage of Bowl Three (If fitted)	-10 to +10°C/14°F to +50°F	1°C /33.8F°
C1	Probe correction for Bowl One	-10 to 10°C/-18°F to 18°F	0°C /0F°
C2	Probe correction for Bowl Two	-10 to 10°C/-18°F to 18°F	0°C /0F°
C3	Probe correction for Bowl Three	-10 to 10°C/-18°F to 18°F	0°C /0F°
C4	Time Delay	0-10 mins	2mins
C5	Temperature Contrast	-10 to 10°C/-18°F to 18°F	3°C
CF	Temperature Unit	°C/ °F	As desired



# Trouble Shooting

Fault	Probable Cause	Action
The appliance is not working	Power Supply	Check power supply
	Main switch is not set to I	Set main switch to I (see fig 1)
	Fuse in the plug has blown	Replace the plug fuse
	Plug and Lead are damaged	Call POLAR agent or qualified technician
	Internal Wiring Fault	Call POLAR agent or qualified technician
The appliance is not cooling	Coolant Leak	Call POLAR agent or qualified technician
	Fan Motor Failed	Call POLAR agent or qualified technician
	Airflow to the condenser obstructed	Increase the gap between appliance and obstacles/heat source and clean condenser
The Stirring paddle does not turn	The motor stirring switch is set to 0	Set motor stirring switch to 1 (see Fig 1)
	Bowl blocked with Ice	Switch off the machine and allow the ice to melt
The tap leaks	The tap is not fitted correctly	Re-fit the tap
	The tap is defective	Call POLAR agent or qualified technician
The bowl leaks	The bowl is not fitted correctly	Re-fit the bowl
	The bowl seal is defective	Replace bowl seal
The machine works but does not make slush	The machine is in 'Night mode'	Press 'Day mode' button (see fig 1)
	Mode switch is not set to slush	Set mode switch to slush (see fig 1)
	Airflow to the condenser obstructed	Increase the gap between appliance and obstacles/heat source
	Condenser Blocked	Call POLAR agent or qualified technician
Tap will not dispense slush	Tap blocked by Ice	Open and close tap lever several times in quick succession. If tap still not clear turn off the machine and allow ice to melt
<b>If the machine malfunctions due to causes other than those listed or the proposed corrective actions do not solve the problem please call a Polar agent or qualified technician</b>		

# Technical Specifications

Model	Voltage	Power	Current	Capacity (Litres)	Refrigerant	Dimensions H x W x D mm	Weight (KG)
GF489	230v 50Hz	558W	3.2A	10	R404a 200g	810 x 270 x 510	31

## Electrical Wiring

This appliance is supplied with a 3 pin, moulded, BS1363 plug and lead, with a 13 amp fuse as standard.

The plug is to be connected to a suitable mains socket.

This appliance is wired as follows:

- Live wire (coloured brown) to terminal marked L
- Neutral wire (coloured blue) to terminal marked N
- Earth wire (coloured green/yellow) to terminal marked E

This appliance must be earthed, using a dedicated earthing circuit.

If in doubt consult a qualified electrician.

Electrical isolation points must be kept clear of any obstructions. In the event of any emergency disconnection being required they must be readily accessible.

## Compliance

The WEEE logo on this product or its documentation indicates that the product must not be disposed of as household waste. To help prevent possible harm to human health and/or the environment, the product must be disposed of in an approved and environmentally safe recycling process. For further information on how to dispose of this product correctly, contact the product supplier, or the local authority responsible for waste disposal in your area.

POLAR parts have undergone strict product testing in order to comply with regulatory standards and specifications set by international, independent, and federal authorities.

POLAR products have been approved to carry the following symbol:



**All rights reserved. No part of these instructions may be produced or transmitted in any form or by any means, electronic, mechanical, photocopying, recording or otherwise, without the prior written permission of POLAR.**

**Every effort is made to ensure all details are correct at the time of going to press, however, POLAR reserve the right to change specifications without notice**

# DECLARATION OF CONFORMITY

• Conformiteitsverklaring • Déclaration de conformité • Konformitätserklärung • Dichiarazione di conformità •  
• Declaración de conformidad • Declaração de conformidade

**Equipment Type** • Uitrustingstype • Type d'équipement • Gerätetyp •  
Tipo di apparecchiatura • Tipo de equipo • Tipo de equipamento

**Model** • Modèle • Modell • Modello • Modelo • Malli

**Application of Council Directives(s)**  
Toepassing van Europese Richtlijn(en) • Application de la/des directive(s) du  
Conseil • Anwendbare EU-Richtlinie(n) • Applicazione delle Direttive • Aplicación  
de la(s) directiva(s) del consejo • Aplicação de directiva(s) do Conselho

**Standards**  
Standaarden • Normes • Normen • Standard • Estándares • Normas

**Producer Name** • Naam fabrikant • Nom du producteur • Name des Herstellers  
• Nome del produttore • Nombre del fabricante • Nome do fabricante

**Producer Address** • Adres fabrikant • Adresse du producteur • Anschrift des  
Herstellers • Indirizzo del produttore • Dirección del fabricante • Endereço do  
fabricante

**Slush Machine**

**GF489**

**LVD Directive 2006/95/EC  
EMC Directive 2004/108/EC  
RoHS Directive 2011/65/EU  
Food Contact Directive  
EC/1935/2004**

**EN 60335-1:2002  
EN 60335-2-75:2004  
EN 62233:2008  
EN 55014-1:2006  
EN 55014-2:1997  
EN 61000-3-2:2006  
EN 61000-3-3:2008  
IEC 62321:2008  
LFGB 30 & 31**

**Polar**

**Fourth Way,  
Avonmouth,  
Bristol,  
BS11 8TB  
United Kingdom**

**I, the undersigned, hereby declare that the equipment specified above conforms to the above Directive(s) and Standard(s).**

Ik, de ondergetekende, verklaar hierbij dat de hierboven gespecificeerde uitrusting goedgekeurd is volgens de bovenstaande Richtlijn(en) en Standaard(en).

Je soussigné, confirme la conformité de l'équipement cité dans la présente à la / aux Directive(s) et Norme(s) ci-dessus  
Ich, der/die Unterzeichnende, erkläre hiermit, dass das oben angegebene Gerät der/den oben angeführten Richtlinie(n) und Norm(en) entspricht.

Il sottoscritto dichiara che l'apparecchiatura di sopra specificata è conforme alle Direttive e agli Standard sopra riportati.  
El abajo firmante declara por la presente que el equipo arriba especificado está en conformidad con la(s) directiva(s) y estándar(es) arriba mencionadas.

Eu, o abaixo-assinado, declaro que o equipamento anteriormente especificado está em conformidade com a(s) anterior(es) Directiva(s) e Norma(s)

**Date** • Data • Date • Datum • Data • Fecha • Data

**17/12/12**

**Signature** • Handtekening • Signature • Unterschrift  
Firma • Firma • Assinatura

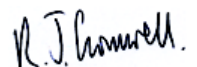

**Full Name** • Volledige naam • Nom et prénom • Vollständiger Name •  
Nome completo • Nombre completo • Nome por extenso

**Richard Cromwell**

**Position** • Functie • Fonction • Position • Qualifica • Posición • Função

**Commercial Director**



GF489\_UK\_v1