

User Manual
Compact Signal Calibrator
AMETEK JOFRA CSC101

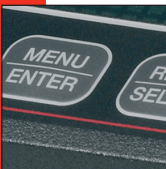

Contents

1. Introduction	1
1.1 Contacting Ametek	1
1.2 Standard Equipment	1
1.3 Safety information	2
2. Calibrator Interface	4
2.1 Inputs and Primary User Interface	4
2.2 Calibrator Configuration	5
3. Operation in the Current Mode (4mA to 20mA)	9
3.1 Sourcing Current	9
3.2 Simulating Current	9
3.3 Measuring Current	10
3.4 Measuring Current with Loop Power	10
4. Operation in the Voltage Mode	11
4.1 Measuring Volts (30VDC max)	11
5. Advanced Features	12
5.1 Step and Ramp Operation	12
5.2 Valve Test	12
5.3 Flow Calculation	12
5.4 Hart 250Ω Resistor	13
6. Specifications	13
7. Maintenance	14
7.1 Replacing Batteries	14
7.2 Cleaning the Unit	14
7.3 Service Center Calibration or Repair	14
7.4 Replacement Parts & Accessories	14

1. Introduction

The Ametek Jofra CSC101 is a handheld Compact Signal Calibrator, primarily designed to calibrate and verify 4 to 20mA process loops and precision voltage signal conditioning equipment. The CSC101 can both source and measure current over a 0 to 24mA range and measure voltage from zero to 30VDC. The calibrator has the following features and functions:

- A digital "knob" along with selectable decade control allows quick and easy adjustment of the desired output.
- A large easy to read display used to display electrical parameters.
- Measurement and sourcing capabilities for current.
- Flow Calculation and Valve Test Capabilities.
- Voltage measurement capabilities.
- An interactive menu
- All input and output jacks are protected through internal self resetting fuses providing protection to 240VAC.

1.1 Contacting Ametek

US, Canada, Latin America
Europe, Africa, Middle East
Asia

AMETEK TCI at **1-800-527-9999**
AMETEK Denmark A/S at + 45 4816 8000
AMETEK Singapore Pte. Ltd. at
+ 65 (64) 842 388

1.2 Standard Equipment

Inspect the unit carefully upon receipt. Save packing carton in case re-shipment is necessary. If there appears to be any damage, equipment missing or if there are any questions about the unit, contact AMETEK.















Check to see if your calibrator is complete. It should include:

- CSC101 Calibrator
- Instruction Manual
- Test Leads

1.3 Safety information

Symbols Used

The following table lists the International Electrical Symbols. Some or all of these symbols may be used on the instrument or in this manual.

Symbol	Description
	AC (Alternating Current)
	AC-DC
	Battery
	CE Complies with European Union Directives
	DC
	Double Insulated
	Electric Shock
	Fuse
	PE Ground
	Hot Surface (Burn Hazard)
	Read the User's Manual (Important Information)
	Off
	On
	Canadian Standards Association



This calibrator must be recycled or disposed of properly (2002/96/EC).

The following definitions apply to the terms “Warning” and “Caution”.

- “Warning” identifies conditions and actions that may pose hazards to the user.
- “Caution” identifies conditions and actions that may damage the instrument being used.

Use the calibrator only as specified in this manual, otherwise injury and damage to the calibrator may occur.



Warning

To avoid possible electric shock or personal injury:

- Do not apply more than the rated voltage. See specifications for supported ranges.
- Follow all equipment safety procedures.
- Do not use the calibrator if it is damaged. Before you use the calibrator, inspect the case. Look for cracks or missing plastic. Pay particular attention to the insulation surrounding the connectors.
- Select the proper function and range for your measurement.
- Make sure the battery cover is closed and latched before you operate the calibrator.
- Remove test leads from the calibrator before you open the battery door.
- Inspect the test leads for damaged insulation or exposed metal. Check test leads continuity. Replace damaged test leads before you use the calibrator.
- When using the probes, keep your fingers away from the probe contacts. Keep your fingers behind the finger guards on the probes.
- Do not use the calibrator if it operates abnormally. Protection may be impaired. When in doubt, have the calibrator serviced.
- Do not operate the calibrator around explosive gas, vapor, or dust.
- Disconnect test leads before changing to another measure or source function.
- To avoid false readings, which could lead to possible electric shock or personal injury, replace the battery as soon as the battery indicator appears.
- To avoid personal injury or damage to the calibrator, use only the specified replacement parts and do not allow water into the case.

Caution

To avoid possible damage to calibrator or to equipment under test:

- Disconnect the power and discharge all high-voltage capacitors before testing resistance or continuity.
- Use the proper jacks, function, and range for your measurement or sourcing application.
- To avoid damaging the plastic lens and case, do not use solvents or abrasive cleansers.

Clean the calibrator with a soft cloth dampened with water or water and mild soap.

2. Calibrator Interface

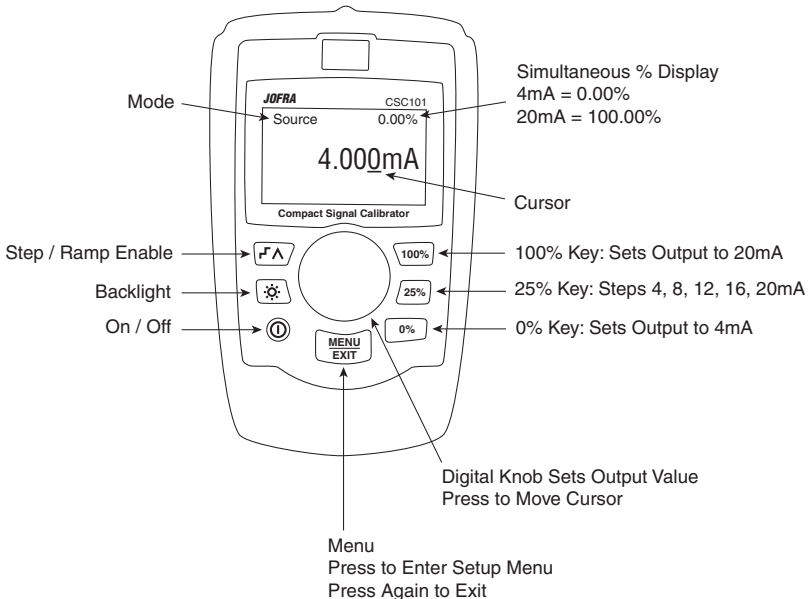

Figure 1

2.1 Inputs and Primary User Interface

The Calibrator has two numeric displays. The main display area displays the signal which is being sourced or measured. The smaller numeric display area is used in the mA modes to display the percent of range. Normally values in the 4mA to 20mA range correspond to a percentage from 0% to 100%. The unit can also be configured for 0 to 20 mA fullscale.

The CSC101 has one input terminal located on the top of the unit. These terminals are provided for all milliamp functions and voltage functions. The terminals will accommodate standard banana plugs.

The CSC101 has a knob and a series of key used to operate and configure the unit.

Figure 1 shows the layout of the calibrator keypad while Table 1 lists the calibrator's components and describes their functions.

2.2 Calibrator Configuration

2.2.1 Main Menu

The Main Menu is used to configure the primary mode of the calibrator and allow access to the calibrator set-up.

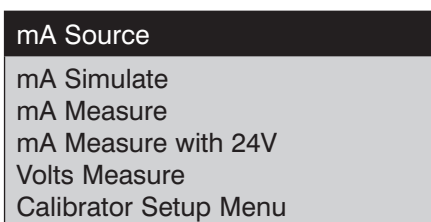

The knob is used to highlight the menu selection in reverse video. Pressing the knob executes the highlighted action. If the user can exit without making a change by pressing the Menu/Exit key.

2.2.2 Calibrator Setup Menus

The Calibrator Setup consists of two menu screens.

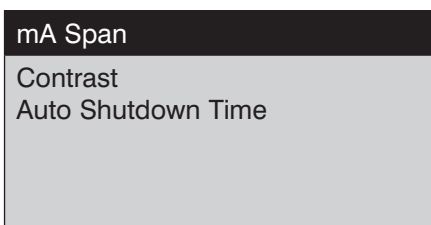
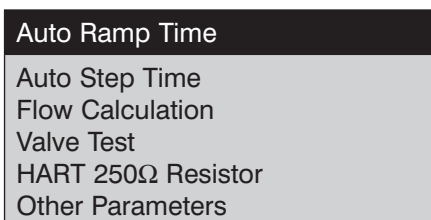

The knob is used to highlight the menu selection in reverse video. Pressing the knob executes the highlighted action. The user can exit without making a change by pressing the Menu/Exit key.

Setting Auto Ramp Time

Auto Ramp Time
1 <u>0</u> SEC.
Press & hold to Save

This is the time for the mA ramp function (See Section 5 Advanced Features). The value can be set from 5 to 300 seconds. The knob is used to adjust the value. When the desired value is attained press and hold the knob to save it. If you wish to revert to the previous value press the menu exit key.

Setting Auto Step Time

Auto Step Time
1 <u>0</u> SEC.
Press & hold to Save

This is the time for the mA Auto Step Feature (See Section 5 Advanced Features). The value can be set from 5 to 300 seconds. The knob is used to adjust the value. When the desired value is attained press and hold the knob to save it. If you wish to revert to the previous value press the menu exit key.

Enabling Valve Test

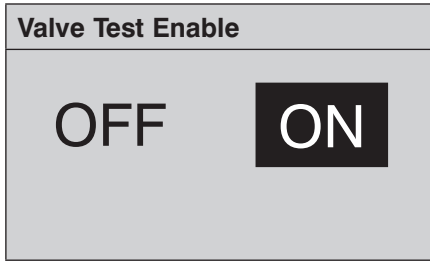

Use the knob to highlight the selection. Press the knob to store the highlighted selection. If you wish to revert to the previous setting press the menu exit key.

Enabling Flow Calculation

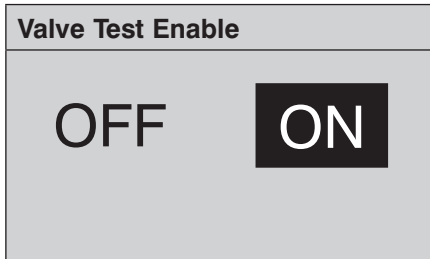

Use the knob to highlight the selection. Press the knob to store the highlighted selection. If you wish to revert to the previous setting press the menu exit key.

Enabling Hart Resistor

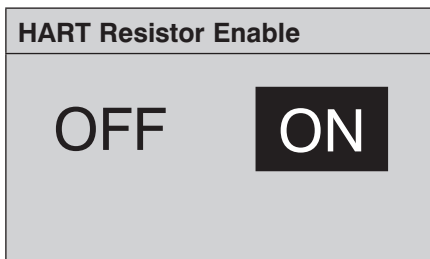

Use the knob to highlight the selection. Press the knob to store the highlighted selection. If you wish to revert to the previous setting press the menu exit key.

Selecting mA Span



Use the knob to highlight the selection. Press the knob to store the highlighted selection. If you wish to revert to the previous setting press the menu exit key.

Contrast Adjustment

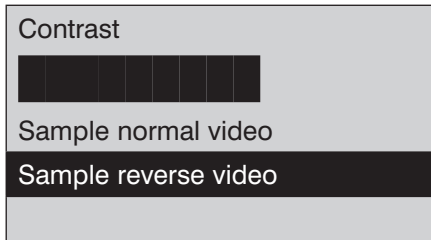

Use the knob to adjust the contrast. The range of values is shown by the bar graph, with higher contrast shown by a longer bar. The sample normal and reverse video text lines allow evaluation of both text modes. Press the knob to store contrast value. If you wish to revert to the previous setting press the menu exit key.

Configuring Auto Shutdown

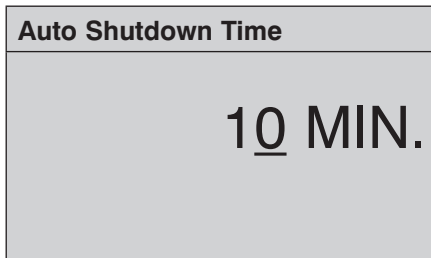

Use the knob to adjust the time before the unit with shutdown if the user interface is not used. Auto shutdown can also be disabled is disable by turning the knob counter clockwise until "Disabled" is displayed on the screen.

3. Operation in the Current Mode (4mA to 20mA)

The CSC101 offers four (4) different operational functions when operated in the current or milliamp mode. These functions are:

1. mA Source - Current can be sourced from the CSC101 over a 0 to 24mA range into loads of up to 1000 ohms.
2. mA Simulate - The CSC101 can act like a 2-wire transmitter by controlling the loop current when power comes from an external power supply.
3. mA Measure - The CSC101 displays input current over a range of 0 to 24mA.
4. mA Measure with Loop Power - Displayed as mA Measure 24V, this mode measures current while simultaneously supplying 24 volts to the loop.

3.1 Sourcing Current

Figure 2 shows how to connect the CSC101 to source current.

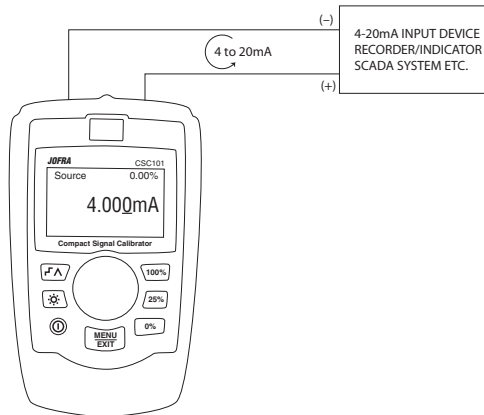

Figure 2

3.2 Simulating Current

Figure 3 shows how to connect the CSC101 to simulate current (2-wire mode) using an external power supply.

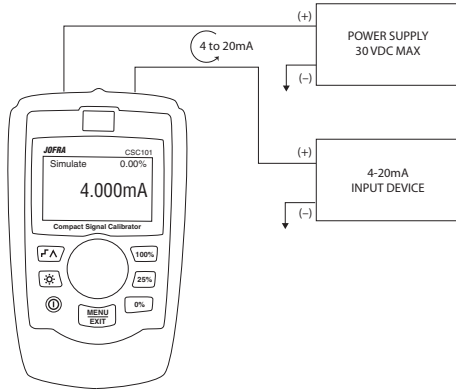

Figure 3

3.3 Measuring Current

Figure 4 shows how to connect the CSC101 to measure 4 to 20mA.

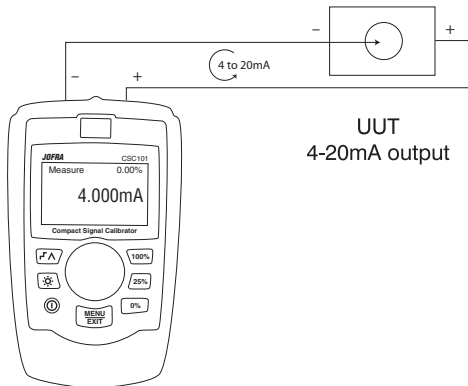

Figure 4

3.4 Measuring Current with Loop Power

Figure 5 shows the CSC101 connected to a 2-wire transmitter where the CSC101 is providing 24 volt loop power while reading the resultant current.

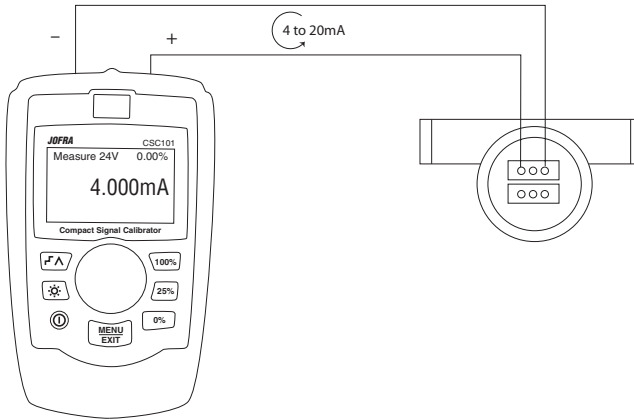

Figure 5

4. Operation in the Voltage Mode

The CSC101 can measure voltage up to 30 VDC.

4.1 Measuring Volts (30VDC max)

Figure 6 shows how to connect the CSC101 to measure volts.

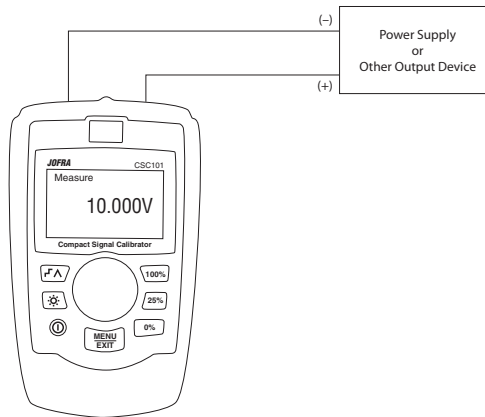

Figure 6

5. Advanced Features

The CSC101 has many advanced features that are available through the Calibrator Setup Menus. How the features are enabled and what they do is described below.

5.1 Step and Ramp Operation

The CSC101 has several unique features that are helpful aids when doing milliamp calibrations. The percent keys allow the user to the output to 0% of scale, 100% of scale or in 25% steps from 0 or 4 to 20 mA. The "Step/Ramp" allows hands free operation by automatically stepping or ramping the milliamp output.

5.1.1 Manual Stepping

1. Use the main menu to set the CSC101 to source or simulate current.
2. Press the "25%" key to step the output in 25% increments from 4mA to 20mA and 20mA to 4mA.

5.1.2 Automatic Stepping & Ramping

1. Set the CSC101 to source or simulate current. See figures 2 & 3.
2. The CSC101 has separate Auto ramp and step times. Use the menu system to set the step or ramp time. (see section 2.2 Calibrator Configuration)
3. Once the desired times are set use the {ramp/step} to continually ramp or step the value from 0% to 100% and back.

5.2 Valve Test

The has CSC101 has a Valve Test mode for verifying proper operation of valves. In Valve Test user can step the output to the following values: 3.8 mA, 4.0mA, 4.2mA, 8.0 mA, 12.0 mA, 16.0 mA, 19.8 mA, 20.0 mA, 20.2 mA.

1. Use the main menu to set the CSC101 to source or simulate current.
2. If Valve Test is not enabled use the menu system to enable it. (see section 2.2 Calibrator Configuration)
3. The Press the Automatic Stepping Function or the "25%" key to step the output to verify the proper valve operation.

5.3 Flow Calculation

The has CSC101 has a Flow Calculation mode for displaying flow (0-100%) as a function of mA. Flow is displayed in the percent display. Flow Calculation can be enabled through the menu system. (see section 2.2 Calibrator Configuration)

5.4 Hart 250Ω Resistor

The has CSC101 has the ability to insert a 250Ω resistor in series with the power supply in order to facilitate the use or a Hart communicator. The Hart resistor can be enabled through the menu system. (see section 2.2 Calibrator Configuration)

6. Specifications

Functions:	mA source, mA simulate, mA read, mA read/loop power, and volts read.
Ranges:	mA (0 to 24mA) and Volts (0 to 30VDC)
Resolution:	1uA on mA ranges and 1mV on voltage range
Accuracy (1 year):	± 0.01% RDG +/- 2LSD, all ranges (@ 23° ±5°C)
Operating Temp range:	-10°C to 55°C
Humidity range:	10 to 95% non-condensing
Stability:	20ppm of F.S. /°C from -10°C to 18°C and 28°C to 55°C
Display:	128 x 64 pixels, LCD Graphic w/backlight, .34" high digits
Power:	6AAA alkaline, lithium, or NiMH batteries
Battery Life:	≥ 40 hours continuous use (measure mode)
Loop Compliance Voltage:	24VDC @ 20mA
Loop Drive Capability:	1200Ω without HART resistor, 950 Ω with HART resistor
Over-Voltage Protection:	240VAC
Overload Current Protection:	28mA DC
EMC:	EN61326 Annex A (Portable Instruments)
Dimensions (L x W x D):	6" x 3.6" x 1.3" (15 cm x 9 cm x 3 cm)
Weight:	9.5 ounces (0.3 kg)
Included Accessories:	NIST traceable calibration certificate with data, batteries, test leads, and manual

7. Maintenance

7.1 Replacing Batteries

Replace batteries as soon as the battery indicator turns on to avoid false measurements.

7.2 Cleaning the Unit

Warning

To avoid personal injury or damage to the calibrator, use only the specified replacement parts and do not allow water into the case.

Caution

To avoid damaging the plastic lens and case, do not use solvents or abrasive cleansers.

Clean the calibrator with a soft cloth dampened with water or water and mild soap.

7.3 Service Center Calibration or Repair

Only qualified service personnel should perform calibration, repairs, or servicing not covered in this manual. If the calibrator fails, check the batteries first, and replace them if needed.

Verify that the calibrator is being operated as explained in this manual. If the calibrator is faulty, send a description of the failure with the calibrator. Be sure to pack the calibrator securely, using the original shipping container if it is available.

7.4 Replacement Parts & Accessories

Order Number Description

SPK-CSC-004 Operating Manual

104203 Test Lead Set

AMETEK Calibration Instruments

is one of the world's leading manufacturers and developers of calibration instruments for temperature, pressure and process signals as well as for temperature sensors both from a commercial and a technological point of view.

JOFRA Temperature Instruments

Portable precision thermometers. Dry-block and liquid bath calibrators: 5 series, with more than 25 models and temperature ranges from -90° to 1205°C / -130° to 2200°F. All featuring speed, portability, accuracy and advanced documenting functions with JOFRACAL calibration software.

JOFRA Pressure Instruments

Convenient electronic systems ranging from -25 mbar to 1000 bar (0.4 to 15,000 psi) - multiple choices of pressure ranges, pumps and accuracies, fully temperature-compensated for problem-free and accurate field use.

JOFRA Signal Instruments

Process signal measurement and simulation for easy control loop calibration and measurement tasks - from handheld field instruments to laboratory reference level bench top instruments.

JOFRA / JF Marine Instruments

A complete range of calibration equipment for temperature, pressure and signal, approved for marine use.

FP Temperature Sensors

A complete range of temperature sensors for industrial and marine use.

M&G Pressure Testers

Pneumatic floating-ball or hydraulic piston dead weight testers with accuracies to 0.015% of reading.

M&G Pumps

Pressure generators from small pneumatic "bicycle" style pumps to hydraulic pumps generating up to 1,000 bar (15,000 psi).



TEST & CALIBRATION INSTRUMENTS

UK

Lloyd Instruments Ltd
Tel +44 (0)1243 833 370
uk-far.general@ametek.co.uk

France

AMETEK S.A.S.
Tel +33 (0)1 30 68 89 40
general.lloyd-instruments@ametek.fr

Germany

AMETEK GmbH
Tel +49 (0)2159 9136 510
info.mct-de@ametek.de

Denmark

AMETEK Denmark
Tel +45 4816 8000
jofra@ametek.com

USA

AMETEK MCT
Tel +1 (727) 536 7831
chatillon.fl-lar@ametek.com

India

AMETEK Instruments India Pvt Ltd.
Tel +91 22 2836 4750
jofra@ametek.com

Singapore

AMETEK Singapore Pte Ltd
Tel +65 6484 2388
aspl@ametek.com.sg

China

AMETEK Inc. - Shanghai
Tel +86 21 5868 5111

AMETEK Inc. - Beijing
Tel +86 10 8526 2111

AMETEK Inc. - Guangzhou
Tel +86 20 8363 4768
lloyd@ametek.com.cn

www.jofra.com