

Agilent E2925B PCI Analyzer

User's Guide



Agilent Technologies



Important Notice

This document contains propriety information that is protected by copyright. All rights are reserved. Neither the documentation nor software may be copied, photocopied, reproduced, translated, or reduced to any electronic medium or machine-readable form, in whole or in part, without the prior written consent of Agilent Technologies.

© Copyright 1998, 2000 by:
Agilent Technologies
Herrenberger Straße 130
D-71034 Böblingen
Germany

The information in this manual is subject to change without notice. Agilent Technologies makes no warranty of any kind with regard to this manual, including but not limited to the implied warranties of merchantability and fitness for a particular purpose.

Agilent Technologies shall not be liable for errors contained herein or direct, indirect, special, incidental, or consequential damages in connection with the furnishing, performance, or use of this manual.

Brand or product names are trademarks or registered trademarks of their respective companies or organizations.

Authors: Stephan Greisinger and Stefan Kunzi, t3 medien GmbH

Contents

System Overview	7
<hr/>	
A Window To The System	8
User Interface	10
Test Setup Overview	11
Analyzer Overview	11
Exerciser Overview	13
Hardware and Interfaces	14
Running A Sample PCI Analyzer Session	17
<hr/>	
PCI Analyzer Scenarios	18
Preparing for the Guided Tour	18
Guided Tour: Analyzing PCI Traffic to a Graphics Controller	20
Setting Up the Trigger	20
Setting Up the Storage Qualifier	22
Running the PCI Analyzer	23
Analyzing the Captured Waveforms	24
Analyzing the Captured Bus Cycles	25
Analyzing the Captured Transactions	26
Getting Help	27
Guided Tour: Analyzing Protocol and Timing Violations	28
Setting Up the Protocol Observer	28
Triggering on Protocol Errors	29
Analyzing the Captured Waveforms	30
Detecting Setup/Hold Timing Violations	31
Guided Tour: Using the State Sequencer	33
Changing to Sequencer Mode	33
Setting Up the Trigger Sequencer	34
Guided Tour: PCI Performance Analysis	36
Identifying Overall System Performance	37

Setting Up a PCI Analyzer Test	39
Possible PCI Analyzer Configurations	39
Dedicated Control PC	40
Software Running on System Under Test	41
Concealing the Card from the System	42
Connecting to the Testcard	43
How to Select the Connection	44
Connection Troubleshooting	45
Analyzing Protocol Violations	47
Protocol Observation	47
How to Set Up the Protocol Observer	48
Watching the Protocol Observer	49
How to Upload Protocol Observer Results	49
How to Reset the Protocol Observer	50
Analyzing Timing Violations	51
Observed Timing Rules	51
Timing Check Limitations	52
Adapting the Timing Checker	53
How to Set Up the Timing Checker	54
How to Modify Timing Limits	55
Watching the Timing Checker	56
How to Upload Timing Checker Results	56
How to Reset the Timing Checker	56
How to Debug Timing Violations	57
Analyzing PCI Performance	59
Predefined Performance Measures	60
How to Select Predefined Performance Measures	61
How to Run a Performance Measurement	62
Advanced Performance Measures	64
Sample Advanced Performance Setup	66
How to Set Up the Measures for the Example	67
How to Program the Counter Sequencer for the Example	68

Capturing Data In The Trace Memory	71
Data Stored In The Trace Memory	72
Capture Mode	74
Setting Up the Data Capture	75
How to Select the Capture Mode	75
How to Set Up the Trigger	76
How to Specify a Trigger Pattern	77
How to Set Up the Storage Qualifier	79
How to Specify Transactions and States	80
Setting Up the Trigger Sequencer	81
Sample Sequencer Setup	83
How to Set Up the Trigger Sequencer	85
Running the Data Capture	87
Viewing And Processing The Trace Memory Capture	89
Using the Waveform Lister	90
How to Arrange the Signal Display	91
Adjusting Range and Resolution	92
Using the Markers	92
How to Synchronize the Listers	94
Using the Bus Cycle Lister	94
Browsing Through the Cycles	95
Using the Transaction Lister	96
Processing the Captured Data	97
Saving and Re-Using the Setups	99
Re-Using Test Setups	99
How to Overwrite the Power Up Defaults	100
Upgrading the PCI Analyzer	101
How to Install Software Options	101
Upgrading the Testcard Hardware	102

Updating the Testcard	103
How to Check the Hardware	103
How to Update the Testcard Hardware	103
Analyzer Reference	105
List of Rules Observed by the PCI Analyzer	105
Sample Timing Diagrams	112
Application Interfaces	115
Static I/O Port	115
Trigger I/O Connector	117
LEDs on the Testcard	119
Glossary	121



System Overview

Before going into the details of the PCI Analyzer, take a look at the features and interfaces of the Agilent E2925B testcard and its options:

- *“A Window To The System” on page 8* describes the use models and scenarios in which the testcard and its options are intended to be used.
- *“User Interface” on page 10* provides an overview of the user interface software coming with the testcard, and, thus, lists the card’s basic features.
- *“Hardware and Interfaces” on page 14* identifies the most important elements on the testcard.

A Window To The System

The Agilent E2925B testcard is your window on the system during product development, giving you access to almost all of the system components located on the PCI bus, as well as devices and adapters on secondary buses such as ISA.

The options available for the testcard support you in all phases of the design cycle—and all along the value chain of the computer industry.

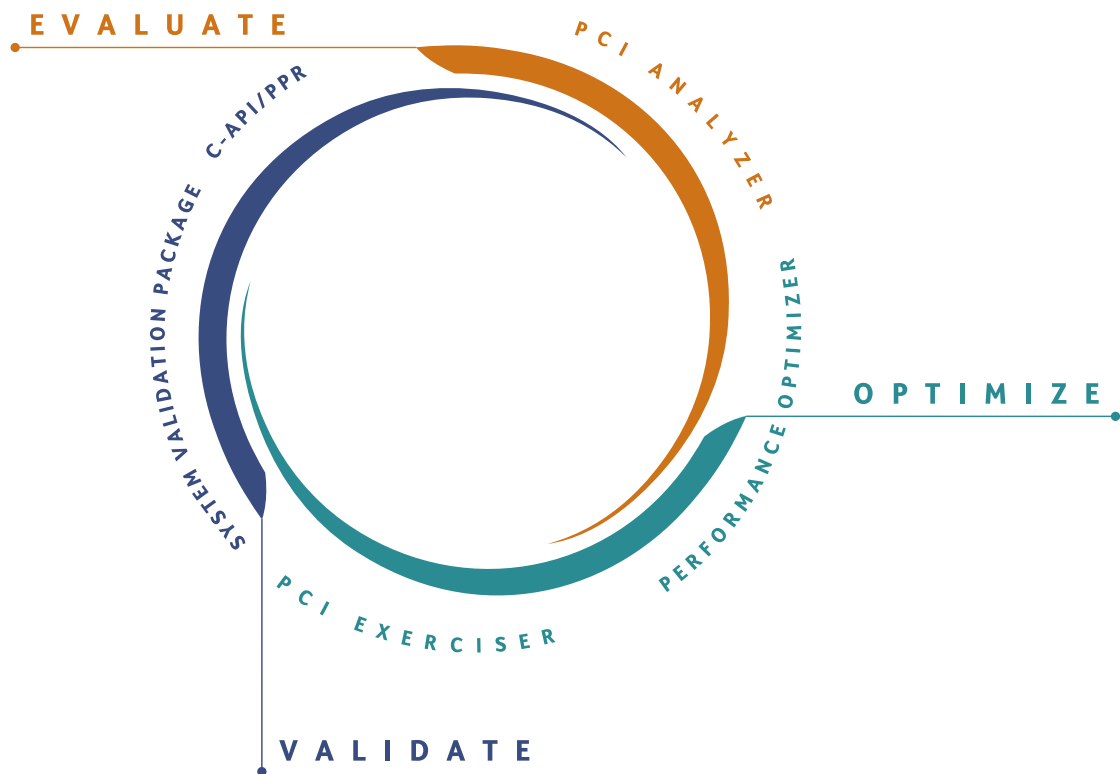

This is how you can use the card in the individual phases:

- When bringing up and debugging a PCI-based system, device, or firmware, the **PCI Analyzer** coming with the card lets you **evaluate** its behavior on the PCI bus.

While tools like oscilloscopes and logic analyzers focus on problems *on your device* (for example, timings, signal integrity), the PCI Analyzer allows you to examine the device's behavior *on the bus*, as well as to perform functional tests like data compares.

For example, when testing LAN interface cards, you can sample the data packages and compare incoming and outgoing data.

The PCI Analyzer also features real-time performance measurement, using predefined, standardized measures like efficiency, throughput, and utilization. It also allows to set up user-defined measures.

- When optimizing a system or a device to improve its performance, the **Performance Optimizer** (option #200) gives you in-depth post-processed performance analysis and hints for performance optimization.
- The **PCI Exerciser** (option #300) allows you to overcome the passive role in monitoring the PCI bus. With the PCI Exerciser, the testcard can be programmed to behave as a master and/or target device. With the PCI Exerciser you can set up complex PCI scenarios and worst case test patterns quickly and in a repeatable way. Using these features, you can **optimize for reliability**, by ensuring that your system or device will handle even worst PCI conditions. You can also run functional tests, directing the PCI Exerciser to generate and transmit large blocks of data in specified time intervals, thus testing how much PCI traffic your device can handle.
- To proceed even further and validate that your PCI design works under all real-life conditions, the **System Validation Pack** (option #310) provides a sophisticated user interface and pre-defined tests.
- Finally, the **C-API / PPR** (option #320) programming interface provides full flexibility for integrating the testcard into existing test environments and controlling all details on the testcard. Agilent's unique **PCI Protocol Permutator and Randomizer** (PPR) prepares the PCI Exerciser to transfer a single block of data with as many protocol variations as possible, giving you the **optimum test coverage** in the minimum amount of time.

User Interface

The Agilent E2925B testcard comes with a graphical user interface software providing a basic framework and the controls for the PCI Analyzer. The options available for the testcard also use this framework, expanding it by their own specific features.

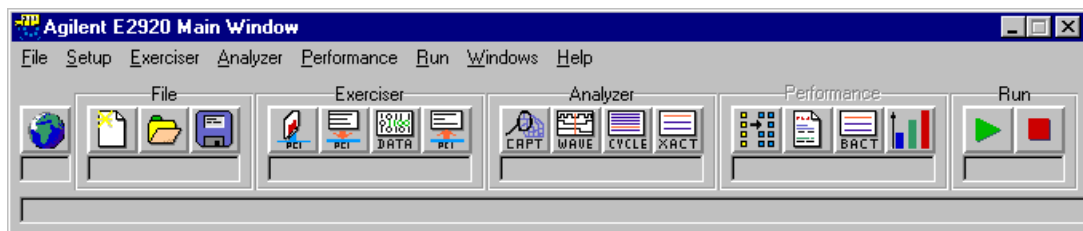

Buttons The most important features are available via the framework buttons. For example, for the PCI Analyzer you can set up the data capture and display the results in different formats—all by means of the buttons.

Menus All these features and more are available via the menus of the framework window, as well.

Overview Windows As a third possibility, there are the overview windows provided by the user interface. These windows provide process-oriented access to the individual features.

Test Setup Overview

The test setup overview shows the basic test configuration.

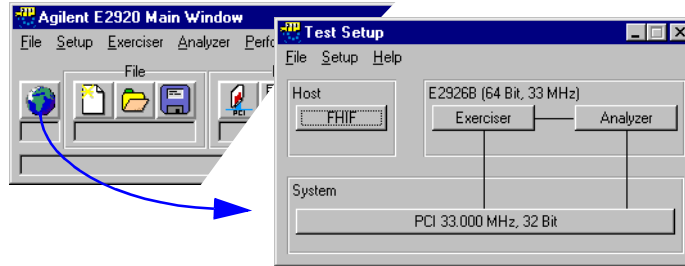

The test setup is described by the following aspects:

- The *Host* group identifies the type of connection between the user interface software and the testcard. Clicking the button allows you to change the current settings in the Testcard Configuration dialog box.
- To the right, there is a group showing the detected testcard and its capabilities. The *Exerciser* and *Analyzer* buttons open the respective overview windows (if registered).
- The *System* group describes the properties of the detected PCI bus.

Analyzer Overview

Clicking the *Analyzer* button in the Test Setup window shows the Analyzer Overview window.

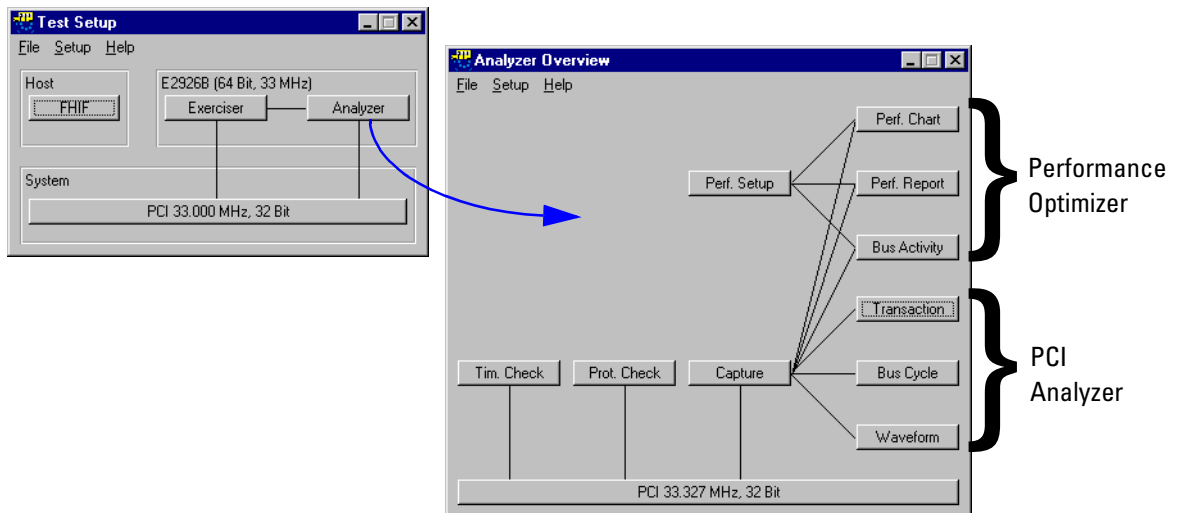

The Analyzer Overview window shows the individual components of the PCI Analyzer (and the Performance Optimizer), how they interact, and how they act on the bus. Clicking the buttons brings up the respective setup or result windows.

For the PCI Analyzer, there is

- the Timing Check
The timing checker continuously monitors the PCI bus to detect timing violations.
- the Protocol Check
The protocol observer continuously monitors the PCI bus to detect protocol errors.
- the Capture control
The PCI Analyzer allows you to specify exactly when and which data is to be captured from the PCI bus, thus making optimum use of the available trace memory.
- the result windows: waveform lister, bus cycle lister, and transaction lister
The result windows interpret and display the captured data using different levels of abstraction (from signal level to transaction level).

Additionally, the PCI Analyzer provides features for real-time performance measurements.

If the Performance Optimizer option has been installed and enabled, there are additional features available for post-processed performance analysis and optimization:

- the Performance Setup
For the Performance Optimizer you can set up the structure of the report to be generated, identify master and target devices to be considered, and control the capture for performance analysis.
- the Performance Chart
The performance charts show graphical representations of the performance-relevant aspects found in the captured PCI traffic.
- the Performance Report
The performance report summarizes the results in a hierarchical way, so you can focus on your level of detail.
- the Bus Activity Lister
The bus activity lister summarizes all transactions found in the captured data. However, for each bus activity, only those properties are displayed that are of interest in a performance analysis.

Exerciser Overview

Clicking the *Exerciser* button in the Test Setup window shows the Exerciser Overview window. Both button and window are only available if the PCI Exerciser option has been installed.

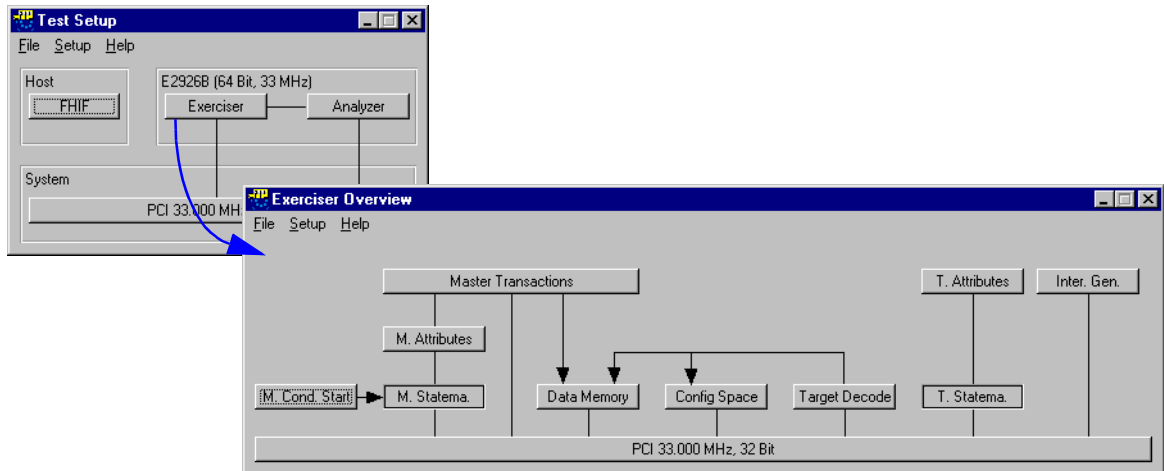

The Exerciser Overview window shows the individual components of the PCI Exerciser, how they interact, and how they act on the bus. Clicking the buttons brings up the respective setup windows.

The Agilent E2925B testcard can act as a master or a target device on the PCI bus. You have full control over the testcard's **configuration space**.

For the **master** you can specify,

- transactions to be performed,
- protocol attributes to be used with the transactions,
- data to be used for the transactions,
- conditions to be fulfilled before the transactions are started.

For the **target** you can specify

- which addresses are to be decoded (target decode and configuration space),
- how received data is to be handled,
- the data to be transferred on request,
- the protocol attributes to be used during transactions.

Furthermore, the Agilent E2925B testcard is able to generate any **PCI interrupt** INTA# ... INTD#.

Hardware and Interfaces

The following figure shows an overview of the interfaces provided by the Agilent E2925B testcard.

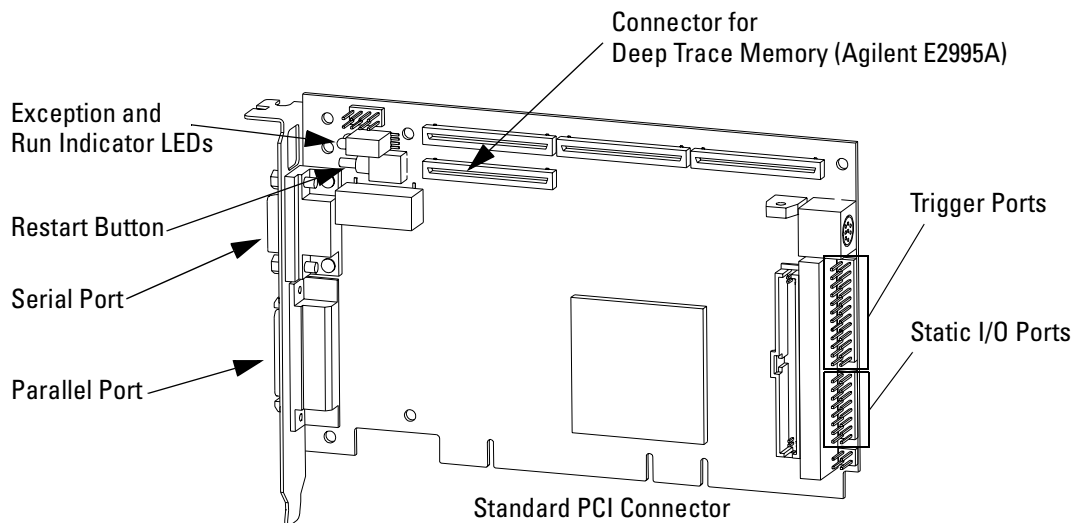

The following list roughly describes the most important interfaces of the card. For information on the other connectors to be found on the card, please refer to your supplementary information.

- The **restart button** allows you to restart the current test. For example, if your test is to trigger on a certain event after power up, but the event has already occurred during power up, you can easily restart the test with the restart button. The card will then be ready to trigger on the event again.

The restart button restarts the trace memory and performance counters, the protocol observer and the timing checker (and master and target if the PCI Exerciser option has been installed).

- The **exception and run indicator LEDs** show the card's status and are visible even if the card is plugged into a closed system. For more details, refer to *"LEDs on the Testcard"* on page 119.
- The **parallel and serial ports** are the control interfaces used to connect the card to the user interface software running on a host PC. The parallel port is the preferred interface, used in combination with the Fast Host Interface card plugged into the host PC. For more details, refer to *"Connecting to the Testcard"* on page 43.

- The **trigger ports** provide access to the card's trigger I/O lines. For more details, refer to "*Trigger I/O Connector*" on page 117.
- The **static I/O ports** can be used to transfer data (for example, status information) between the testcard and the test environment during execution of a test provide. For more details, refer to "*Static I/O Port*" on page 115.
- The **PCI connector** is used to plug the card into the system under test. If the user interface software is running on the system under test, this connector can also be used as control interface.



Running A Sample PCI Analyzer Session

The following application examples explain how the testcard can be used in various analyzing tasks. After introducing the major scenarios for the PCI Analyzer and showing how to prepare for the sample sessions, you will find guided tours covering the following topics:

- Guided Tour: Analyzing PCI Traffic to a Graphics Controller
- Guided Tour: Analyzing Protocol and Timing Violations
- Guided Tour: Using the State Sequencer
- Guided Tour: PCI Performance Analysis

NOTE The examples given here are also part of the *Agilent E2920 Software Demo guide*. If you have already worked through this guide, you may skip these guided tours.

PCI Analyzer Scenarios

If you are

- designing a PCI chip and you need to do bring-up or debugging,
- using a third party PCI chip on your motherboard or adapter card that you need to evaluate,
- trying to find the root cause of a failure that occurred during your chip or system level validation,
- writing and debugging low level software (for example, BIOS code, device drivers),

you probably need to monitor the PCI bus to find out whether your software generates the correct PCI transactions, and also whether your device under test reacts correctly, both at the protocol and the data level. Monitoring the PCI transactions of your device also allows you to judge its performance in relation to other devices.

The built-in 64k state PCI logic analyzer (optional 4M state) allows you to capture PCI traffic and view it as a state waveform, a bus cycle listing or as a transaction listing. The following examples show you how to set up the PCI Analyzer and how to interpret the results.

Preparing for the Guided Tour

The examples described in the guided tours are designed to be performed in Offline/Demo Mode—without hardware. All the setup files (*.bst) and logic analyzer trace files (*.wfm) that are mentioned in the following text can be found under

<your_installation_directory>\samples\demo. If you did not change the default setting during installation, <your_installation_directory> will be C:\Program Files\Agilent\E2920 PCI Series <release_number>.

To prepare for the guided tour:

- 1 Launch the Agilent E2920 software.
- 2 From the *Setup* menu, choose *Testcard Configuration*.

- In the Testcard Configuration window, select the *Offline/Demo Mode* radio button.

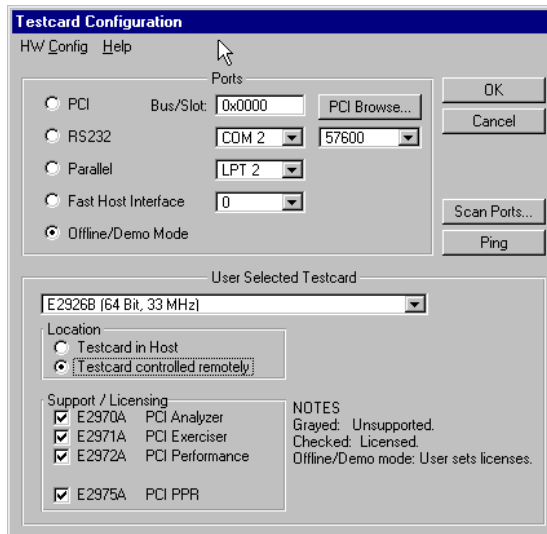

- Now choose *E2926B (64 bit, 33 MHz)* from the *User Selected Testcard* listbox, and check all license boxes in the *Support/Licensing* group.

Your display should look like the window shown above.

- Click *OK* and the main window should look like this.

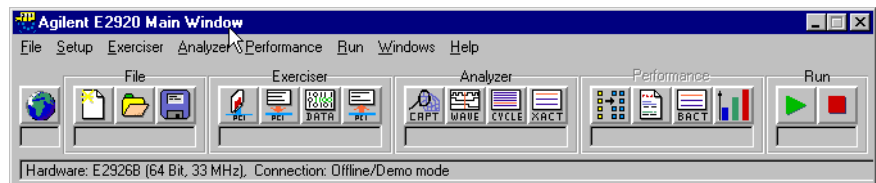

You are now ready to start the guided tours.

NOTE The examples in the guided tours use an Agilent E2926B (64 bit, 33 MHz) testcard, but also apply to all other testcards of the Agilent E2920 series.

Guided Tour: Analyzing PCI Traffic to a Graphics Controller

This example shows how to set up the testcard to trigger on a particular address range and capture PCI traffic that occurs around this triggerpoint. Afterwards, the captured data can be viewed at various levels of abstraction to analyze the PCI behavior of the participating devices (in this case a Host-PCI bridge and a PCI graphics controller).

For this example, the built-in logic analyzer will be set up to trigger on a PCI address phase with an address in the range between 0xFB000000 and 0xFBFFFFFF, which corresponds to the video frame buffer. All PCI cycles will be stored, including idle cycles.

Setting Up the Trigger

To set up a trigger and storage qualifier for the built-in logic analyzer:

- 1 Use the Capture button  in the icon bar of the main window, or choose *Capture* from the *Analyzer* menu.

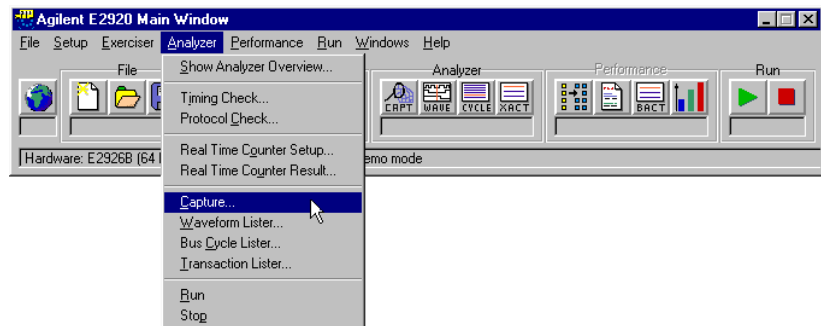

- 2 In the Capture dialog box, select the *Trigger* tab, choose trigger on *Pattern*, and select the *Occurred Once* radio button.
- 3 Click the *Edit* button next to the pattern term and set the *AD32* field to `FBxxxxxx\h`.
- 4 Now click on the text field to the right of the signal *b_state* to open a Selection List dialog box.

- 5 Highlight **Addr** and click the right-arrow button to place it in the right (*Selected*) box and press *OK*. You can use the left-arrow button to remove the “DON’T CARE” entry from the *Selected* list.

The **b_state** signal is internally generated by the testcard to provide easy trigger setup for the multiplexed PCI bus.

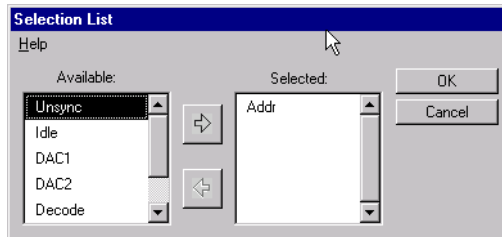

The Pattern editor window should now look like this.

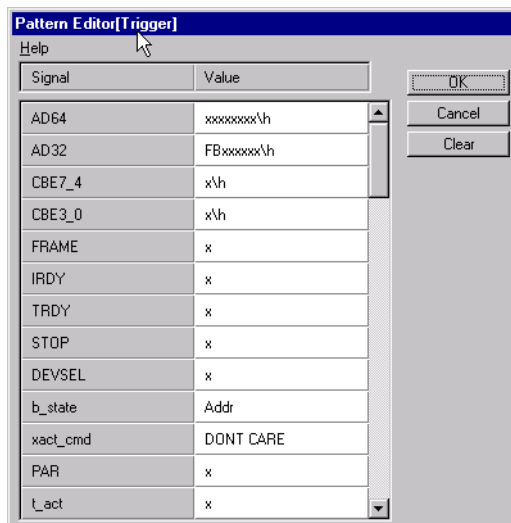

6 Click *OK*.

The Capture window should now look like this.

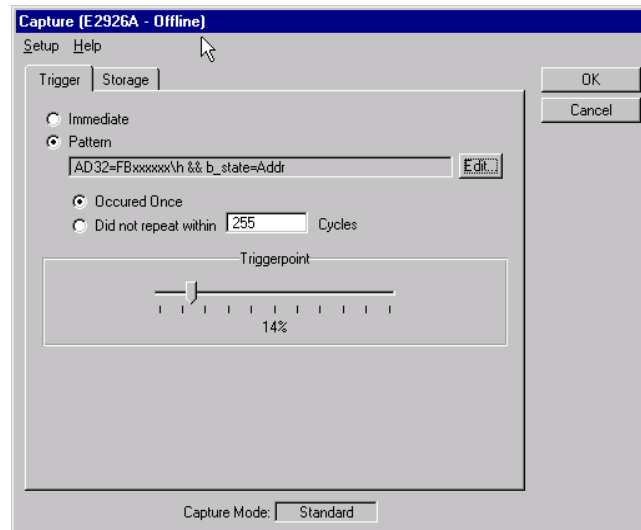

Setting Up the Storage Qualifier

Now, take a look at the *Storage* tab of the Capture window. On this tab, you can define the storage qualifier. The default is *All*, which instructs the built-in logic analyzer to unconditionally capture one sample per PCI clock. Alternatively, you can choose *Selected Transactions/States*, which allows you, for example, to suppress idle cycles between transactions and/or wait states during a transaction (that is, PCI transactions are stored back-to-back).

With the pattern fields, you can further restrict what is captured in the trace memory by storing only particular transaction types (for example, only memory writes) or storing only transactions where the testcard is participating as a master or target.

- 1 In the Capture window, select the *Storage* tab.

For this example, the default *All* can be used.

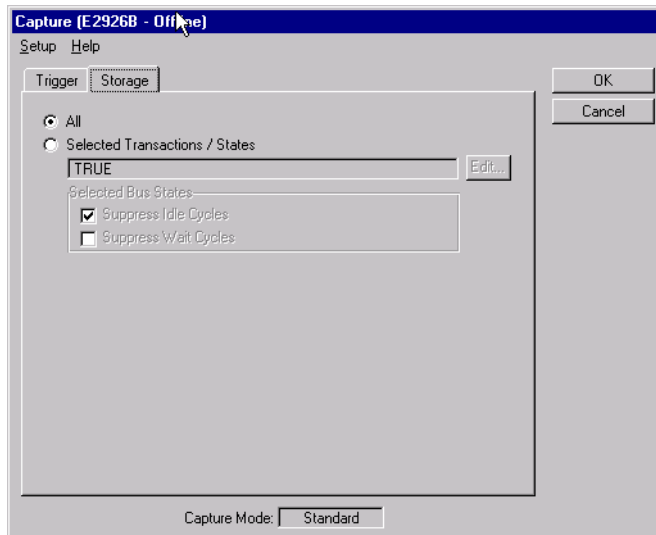

- 2 Press *OK* in the Capture window, and the built-in logic analyzer is ready to run.



Running the PCI Analyzer

Starting the PCI Analyzer in offline mode results in an error, but this would be the next step in our procedure if we were connected to a testcard.

This is normally done by pressing the Run button in the main window (the large green arrow, which also starts the PCI Exerciser if installed) or by selecting the *Run* from the *Analyzer* menu. When connected to a testcard, the status bar of the Analyzer group in the main window changes to *Running...* to indicate that the Analyzer is running and waiting for a trigger signal.

Analyzing the Captured Waveforms

The captured data can be analyzed at different levels of abstraction. We start by using the waveform viewer:

- 1 Click the Waveform Viewer button  in the main window (or use the *Waveform Lister* item from the Analyzer menu) to open the waveform viewer.
- 2 From the *File* menu in the Waveform Viewer window select *Load from file* and load the trace file video1.wfm.
- 3 To navigate within the waveform viewer,
 - press the Goto Trigger button  to view data at the trigger,
 - enter a sample number in the left or right boxes below each corner of the waveform display, or
 - use the scroll bar to move the viewed data.

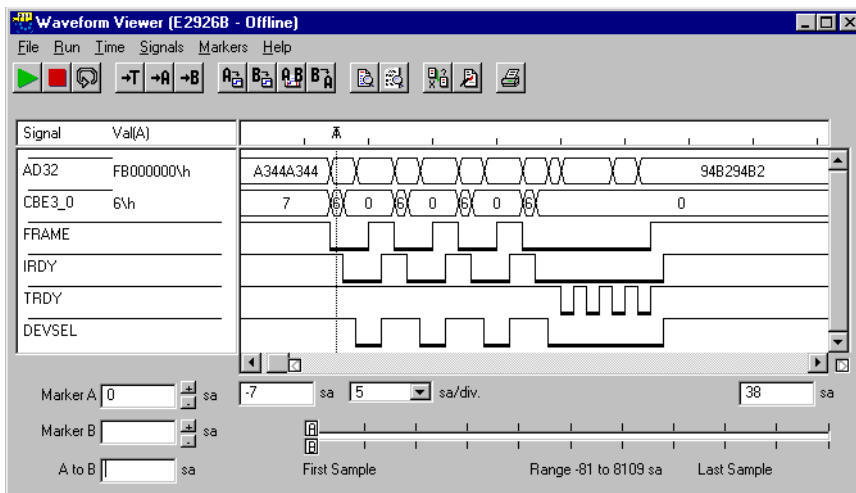

Markers A and B can also be moved just by grabbing them with the mouse or through numeric entry.





If you need more information about the buttons and other controls in the waveform viewer, drag your mouse over the control icons to view the tool tips.

Analyzing the Captured Bus Cycles

Although the waveform viewer is appropriate for analyzing single transactions or when you need to check the state of individual control signals, it is tedious to “read” PCI transactions by looking at the waveform viewer. This is where the bus cycle lister helps.

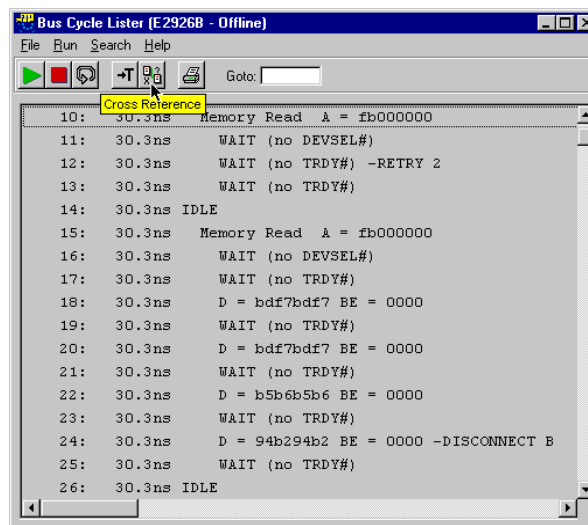
- 1 Click the Bus Cycle Lister button  in the main window (or use the *Bus Cycle Lister* item from the Analyzer menu) to open the bus cycle lister.
- 2 In the Bus Cycle Lister window, press the Goto Trigger button  to go to the triggerpoint. Scroll around to see how it works.



- 3 If you want to view the waveform for a given set of lines in the bus cycle lister, highlight the desired lines in the bus cycle lister and press the Cross Reference button  (make sure that the waveform viewer is still open or minimized).

Analyzing the Captured Transactions

To get a more compressed overview of the transactions that occurred on the bus:

- 1 Click the Transaction Lister button  in the main window (or use the *Transaction Lister* item from the Analyzer menu).

The transaction lister removes idles from the display and summarizes the number of waits for each data phase, just showing useful information such as address and data phases. Address reconstruction is also done during bursts.

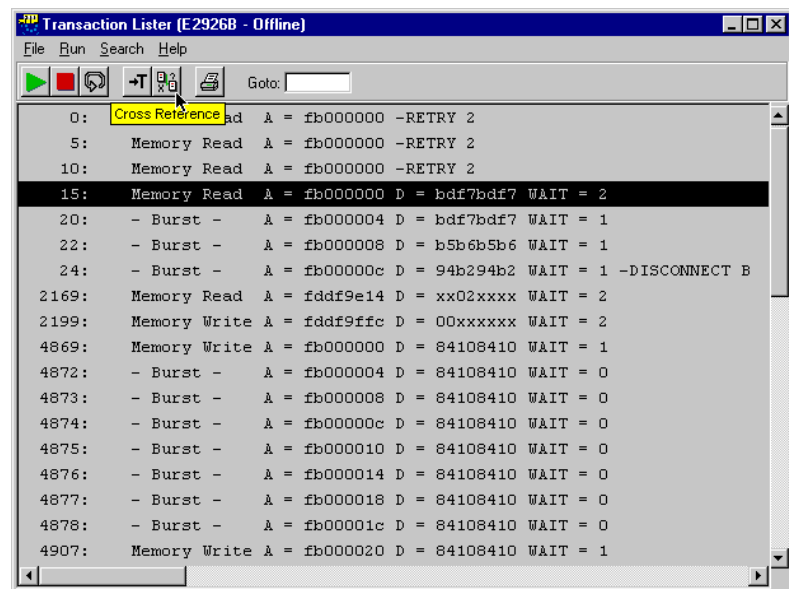

Getting Help

With the cursor in any Analyzer window, pressing the keyboard's **F1** key brings up context sensitive help.

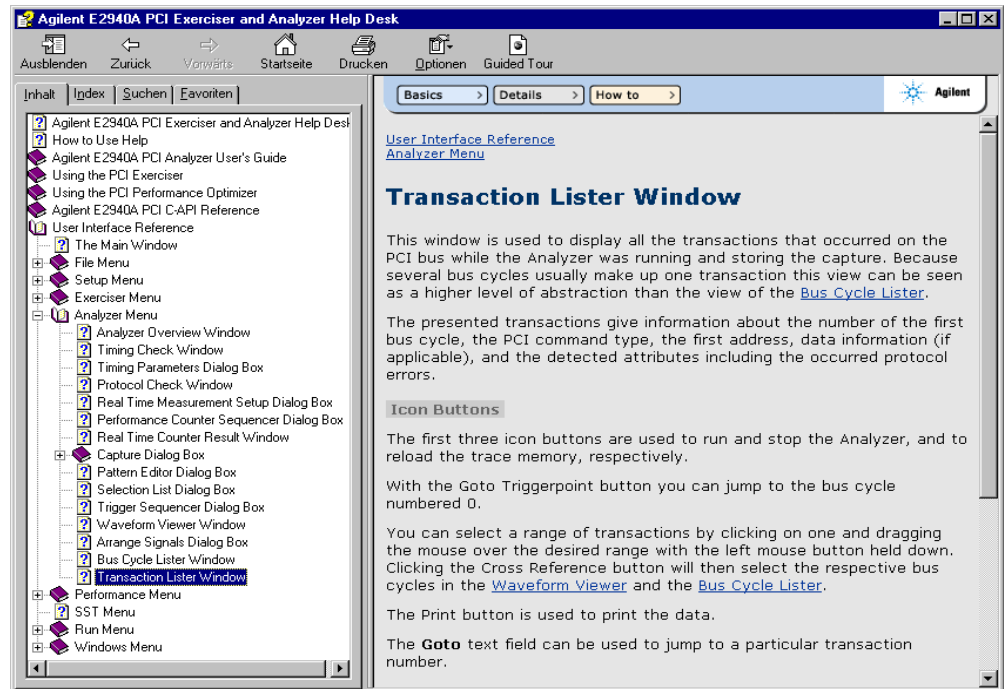

Starting from here, you can use the signposts on top of the topic to find more information:

- Use the *Basics* signpost to find related basic and background information.
- Use the *Details* signpost to find more advanced information and reference data.
- Use the *How to* signpost to find procedural information and instructions for using the currently selected window.

NOTE The online help requires Internet Explorer 4.0 or higher to work. The on-line help is also currently focussed on Analyzer and Exerciser functions. Additional on-line help will be added for other features in future software releases.

Guided Tour: Analyzing Protocol and Timing Violations

In this example, the protocol observer of the testcard is used in conjunction with the built-in logic analyzer to trigger on a protocol violation that occurred during an access to a device's I/O space. You can load the setup for this example from `video2.bst`, and the trace data from `video2.wfm` (load `video2.bst` with *Load* from the *File* menu in the main window, and `video2.wfm` with *Load* from the *File* menu in the waveform viewer).

The protocol observer of the Agilent PCI Analyzer monitors 53 protocol rules from Appendix C of the PCI Spec. 2.1 in real time and flags the violation of an error with an LED on the rear panel of the board.

At the end of this tour, we will also take a glance at the timing checker.

Setting Up the Protocol Observer

From the user interface, the status of the protocol observer can be checked by opening the protocol check window:

- 1 From the *Analyzer* menu select *Protocol Check*.

The Protocol Check window indicates the first rule that was violated, as well as the total number of violated rules. Each rule can be individually enabled or disabled to prevent flagging of known errors.

In demo mode, the software displays random errors to give you an idea of how it works.

You can double-click on any rule name field to get an explanation of what that rule checks.

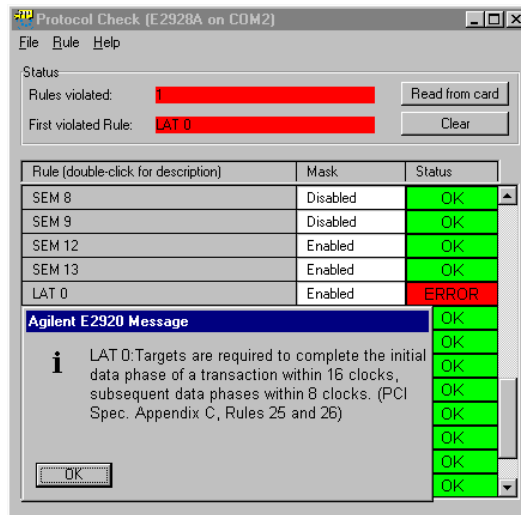

Triggering on Protocol Errors

In order to analyze a protocol violation and find out which PCI device caused the violation, you can use the protocol observer's output *berr* to trigger the built-in logic analyzer. The *berr* signal is asserted when any one of the enabled protocol rules has been violated.

- 1 Open the Capture window, select *Pattern*, and press the *Edit* button next to the pattern term.
- 2 In the Pattern Editor window press the *Clear* button to reset all pattern terms to "x" (= don't care), then set the *berr* field to 1.

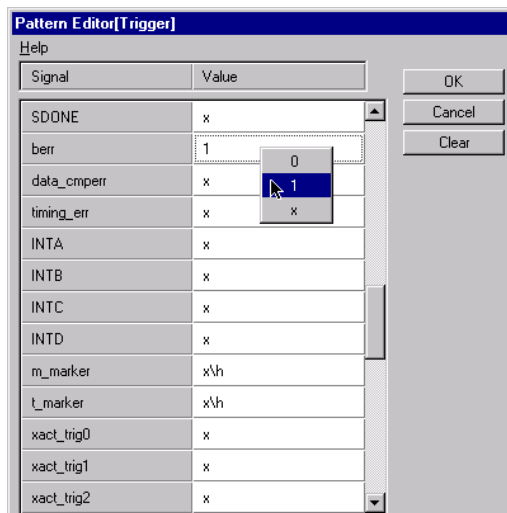

- 3 Run the analyzer to trigger on protocol errors.

Analyzing the Captured Waveforms

When the analyzer is started and the above mentioned device is accessed, the analyzer triggers when the violation occurs. To view the results, proceed as follows:

1 Open the waveform viewer.

Your display will look different than that shown, but you can add and move signals within the display using the *Arrange* item from the *Signals* menu.

Note that the *berr* signal is labeled *prot_rule* in the waveform viewer and is asserted at the triggerpoint. The error in this particular case is that the target did not respond with the first word of data within 16 clocks (LAT0).

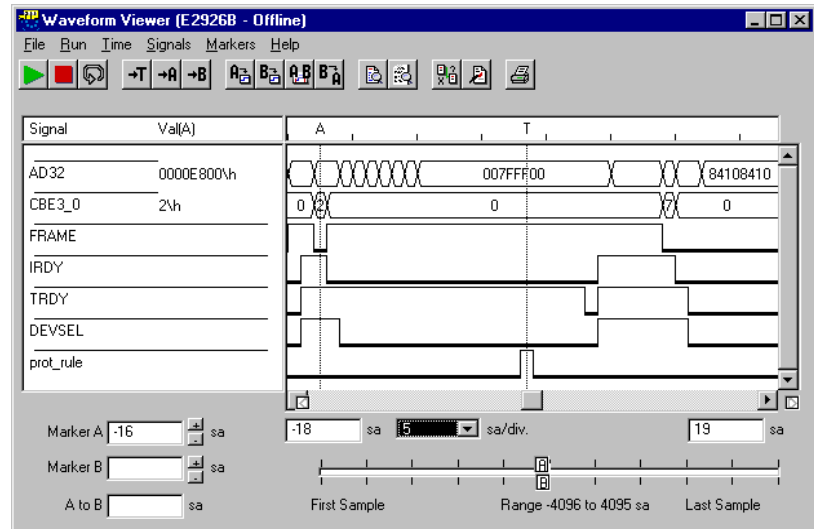

The bus cycle lister shows the associated transaction, along with the protocol error message.

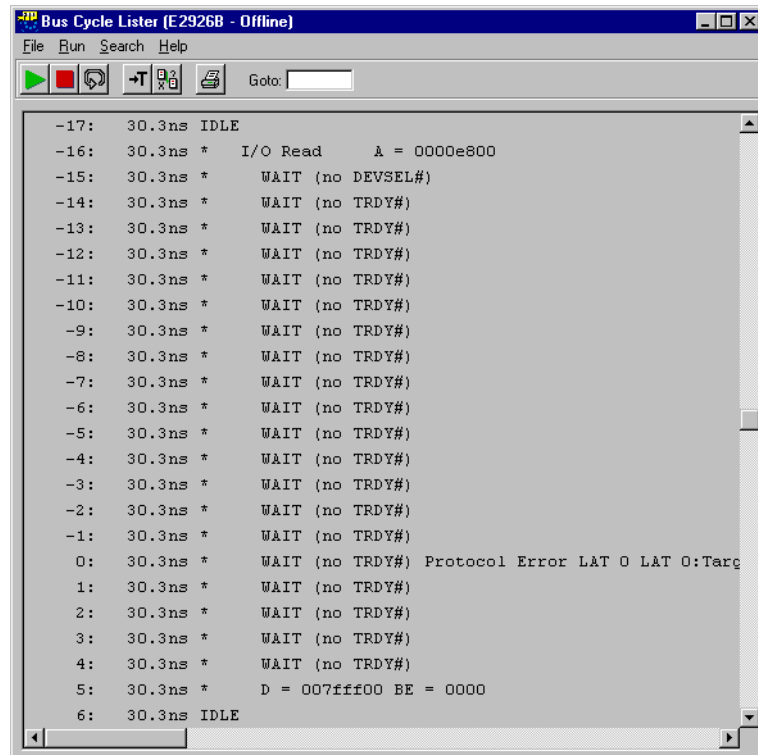

Detecting Setup/Hold Timing Violations

Independent of the Protocol Check, the Agilent PCI testcard's Timing Check can also examine all relevant 32/64-bit PCI signals for setup/hold time violations.

The Timing Check window is invoked by selecting *Timing Check* from the *Analyzer* menu. In this window, each signal that violates timing is marked separately, making it very quick and easy to identify those signals to probe first with an oscilloscope.

Once a bad signal has been identified, the timing check can be used to trigger the oscilloscope from the testcard's trigger I/O signals when the violation occurs. An adjustable measurement window allows up to 2 ns variation from the PCI timing specification to check timing margins.

The timing check feature currently operates at speeds from 26 MHz to 35 MHz.

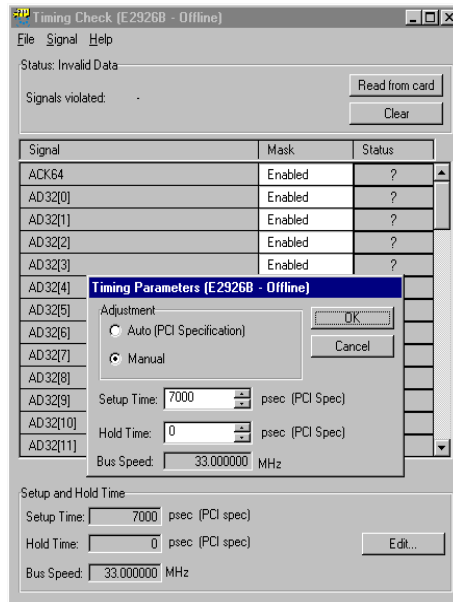

Guided Tour: Using the State Sequencer

For some analysis tasks, a single level trigger is not sufficient. The Agilent PCI testcard provides very sophisticated trigger capabilities for advanced triggering needs.

- The *Performance* mode is used to capture traces for post-processed performance measurements. It allows you to set up an arbitrary trigger pattern but has a fixed storage qualifier that is optimized to capture performance-related information.
- The *Sequencer* mode allows you to set up a sophisticated trigger sequence that can consist of up to 8 sequence states and 255 transitions. The transition, trigger, and storage qualifier conditions can be specified individually for each transition.

The conditions are specified as boolean expressions built with up to 4 pattern terms. In addition, a counter is available that can be loaded and decremented under sequencer control. The terminal count signal of this counter is available in the conditions.

NOTE When the testcard is used through the Command Line Interface or with the C-API, up to 8 pattern terms are available, depending on the number of states used.

Changing to Sequencer Mode

The PCI Analyzer can be changed to sequencer mode using the *Mode* command from the *Setup* menu to get a list of analyzer options. The trace memory depth can also be decreased from the actual size on the hardware to optimize the size and speed for uploaded trace files.

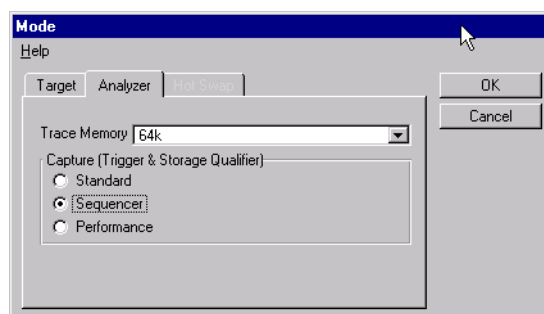

Setting Up the Trigger Sequencer

After you have set the trigger mode to *Sequencer*, open the Capture window to set up a trigger sequence. You can find the sample sequencer setup file shown below in seq.bst and the sample data in seq.wfm.

This example shows how to set up the trigger sequencer to trigger on 16 consecutive I/O transfers that are terminated with Target Retry before a successful one completes. The storage qualifier is set to store all cycles within transactions and ignore IDLE cycles.

The trigger sequencer is a user-programmable state-machine. In order to fill out the fields in the trigger sequencer window, it is helpful to draw a bubble diagram of the states and transitions first. The preload value of the feedback counter is set to 15 because the terminal count is -1.

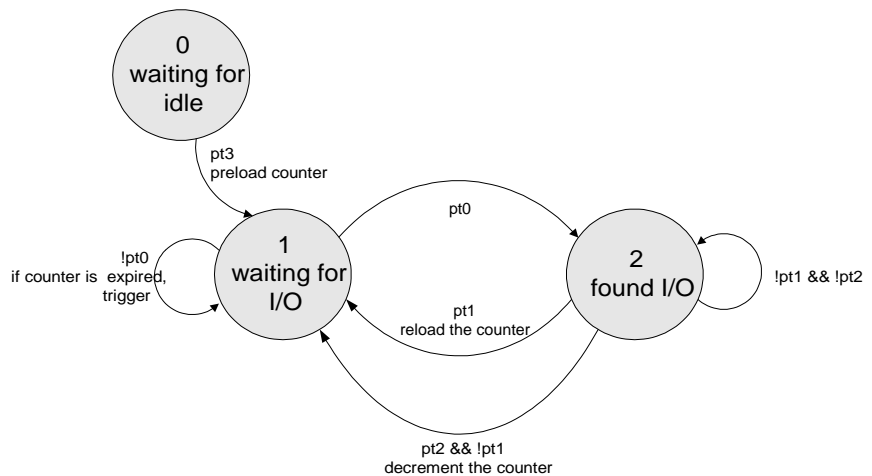

where: pt0 = the address phase of an I/O cycle
 pt1 = a data transfer
 pt2 = a target indicating Retry
 pt3 = IDLE state

And this is how the bubble diagram is implemented in the trigger sequencer:

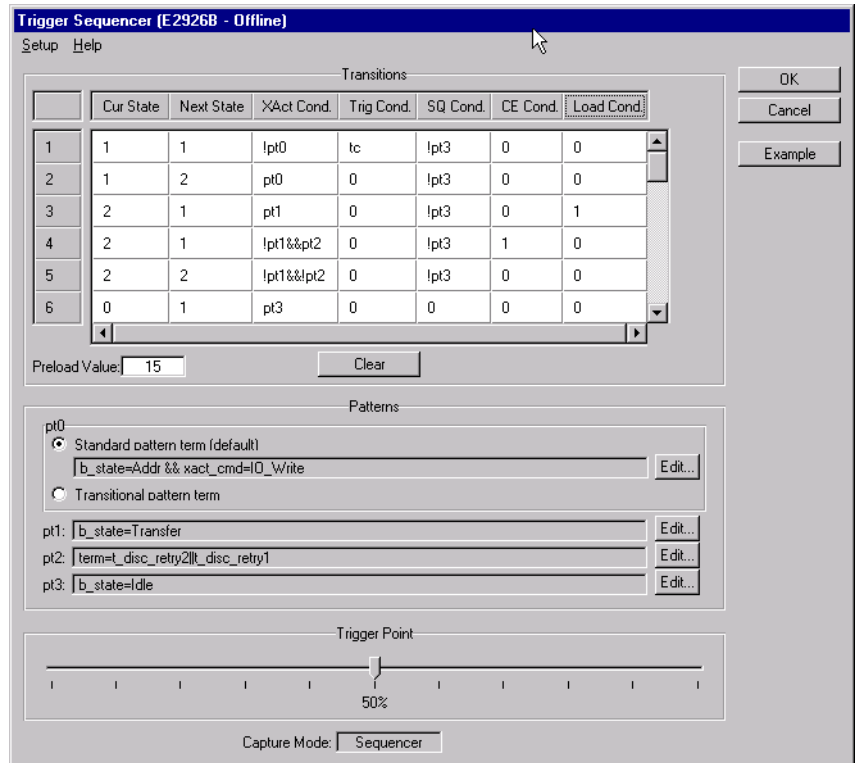

Guided Tour: PCI Performance Analysis

When PCI was initially used in the PC, it was a lot faster than previous buses (ISA, EISA) and there was no need to optimize PCI performance. This has changed. Now PCI is often the performance bottleneck, especially in high-performance servers that deal with lots of disk and network traffic. Due to the complex protocol there are many ways to improve PCI performance both on a component level as well as on a system level.

If you are:

- designing a chip or an add-in card,
- integrating a system and you need to select between different add-in cards on the market,
- tuning system parameters in order to optimize overall performance,

you need a powerful, yet easy-to-use way to analyze the PCI performance to find out bottlenecks in your system and isolate the “bad guy” that potentially ruins the overall system performance.

There are two different approaches to PCI performance analysis and it depends on the application which one to use.

- **Real-Time Analysis**

Real-time analysis is based on programmable counters and provides long term average measurements of performance numbers, latencies, etc. This method provides valuable information over long time periods about *what* the performance of your system is. It is limited, however, in its ability to provide meaningful insight to track down the root cause of performance issues.

The real-time analysis capabilities are available with the PCI Analyzer.

- **Post-Processed Analysis**

Post-processed analysis is based on 1 or more captured traces in the 64K/4M trace memory and provides detailed analysis of all performance aspects like bus utilization, command usage, burst efficiency, wait histograms for the whole bus as well as for a specific master/target pair. This information helps you to quickly determine *why* your performance problems may exist by allowing you to identify poorly performing PCI devices, drivers, or mismatched master/target pairs.

The post-processed analysis capabilities are available with the PCI Performance Optimizer (option 200).

This guided tour introduces the real-time analysis features provided by the PCI Analyzer.

Identifying Overall System Performance

Using the real-time performance measures of the Agilent PCI testcard provides very quick insight into what your overall system performance is.

- 1 From the *Analyzer* menu select *Real Time Counter Result*.
- 2 Click the *Start* button.

Now you should see a simulation that shows a PCI Utilization and Efficiency measurement varying over time.

- The *Momentary* tab shows the actual measurement values calculated from the performance counters after each update interval.

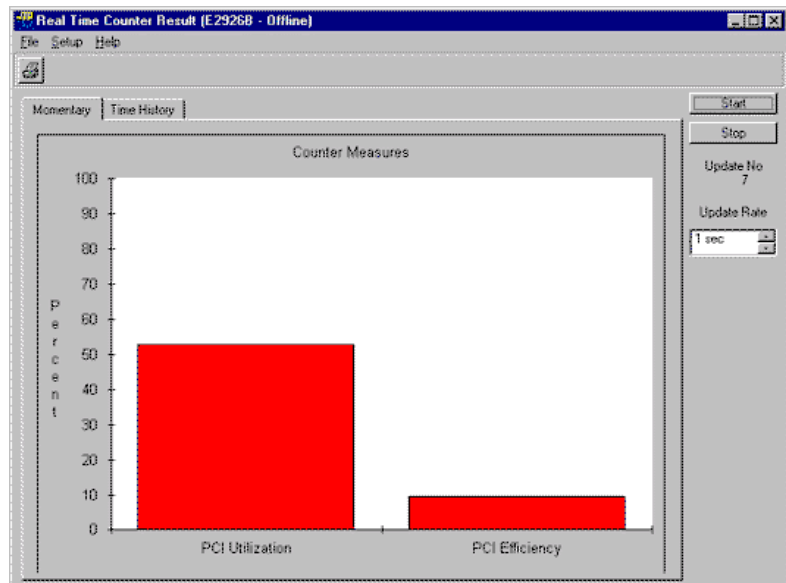

- The *Time History* tab shows a running history of the counter values. Both performance measures can be set up with pre-defined measures or custom measures using a programmable sequencer.

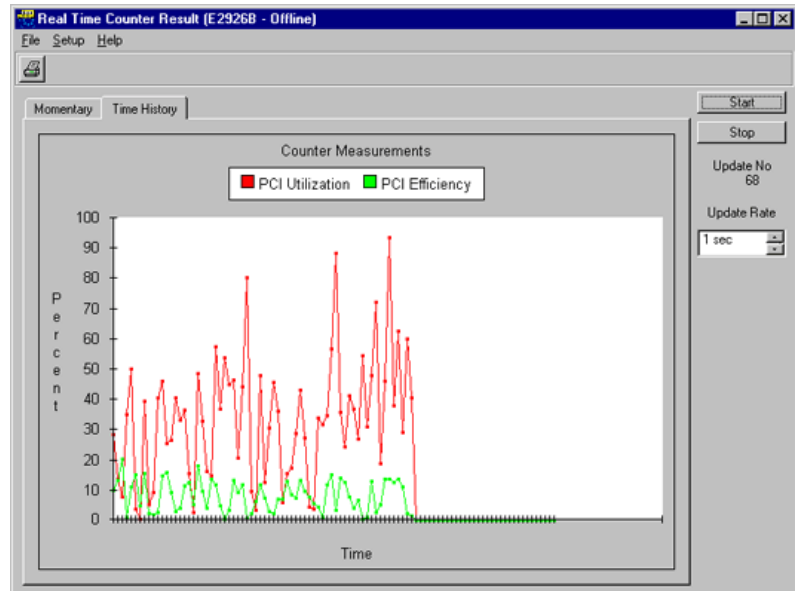

NOTE The performance sequencers (one for each performance measure) have the same capabilities as the trigger sequencer, except that its outputs control the three counters that are available for each measure.

The graphical user interface provides access to two of the eight performance measures. The others can be accessed through the C-API.

Setting Up a PCI Analyzer Test

Setting up a PCI Analyzer test includes the following steps:

- According to your test requirements you need to decide for one of the basic PCI Analyzer configurations (see “*Possible PCI Analyzer Configurations*” on page 39).
- To debug any problems in the power up phase of a system, you can completely hide the testcard from the system (see “*Concealing the Card from the System*” on page 42).
- You need to establish the connection between the user interface software and the testcard (see “*Connecting to the Testcard*” on page 43).

NOTE For information on how to insert the testcard into the system under test, please refer to the installation instructions shipped with the testcard.

Possible PCI Analyzer Configurations

The Agilent E2925B PCI Analyzer basically consists of two components:

- the testcard
- the graphical user interface software

The *testcard* plugs into the PCI bus of the system to be tested—or of the system hosting the device to be tested. The *software* can be run either on a remote system (a dedicated Control PC) connected via a fast host interface, or directly on the system under test.

The former configuration provides the following benefits:

- The user interface software does not interfere with the traffic generated to examine the system or device behavior.
- You can easily switch between different systems under test by just moving the testcard from one system to another.
- Different devices under test can easily be exchanged without changing the setup of the Control PC.

Dedicated Control PC

The following figure shows a typical configuration where the user interface software is running on the Control PC and controls the testcard plugged into the system under test.

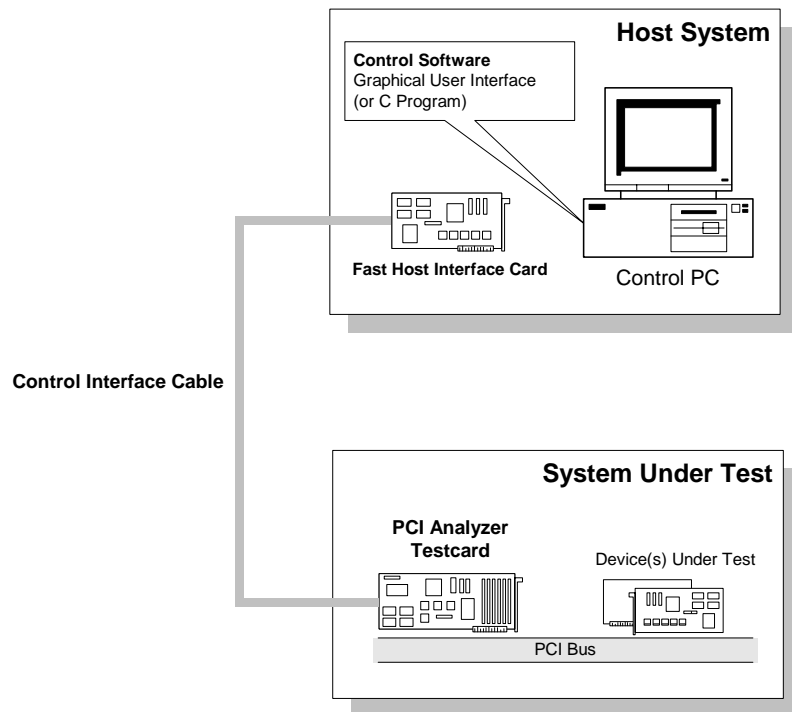

When running extensive tests using more than one testcard, you only need one Control PC, which can be connected to the individual cards one after the other. There is no need for a permanent connection between testcard and user interface software. While the test on one testcard is still running, the Control PC can get connected to another testcard.

Software Running on System Under Test

The following figure shows a configuration where the user interface software is running on the system under test itself. Thus, there is no extra Control PC required.

The PCI Analyzer software usually connects to the testcard directly via the PCI bus. However, you can also use the fast host interface—or the serial interface—for connection.

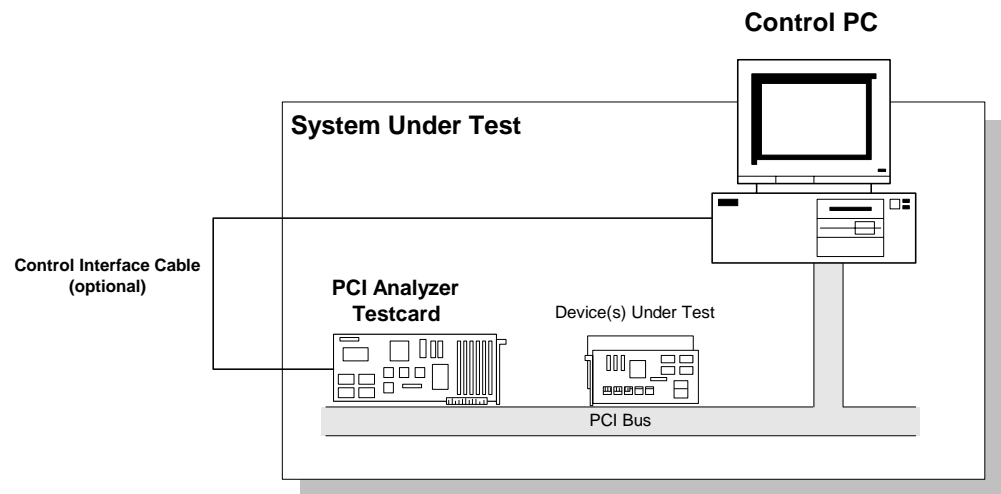

If there is more than one testcard installed in the system, all cards can be reached directly via the PCI bus.

Concealing the Card from the System

Concealing the card is useful, for example, for debugging a system that does not boot properly. You can run the PCI Analyzer to see what is happening on the PCI bus.

A jumper allows you to conceal the Agilent E2925B testcard from the system under test before you run your test. The card will not reply to any configuration access from BIOS and will, therefore, be completely invisible for the system.

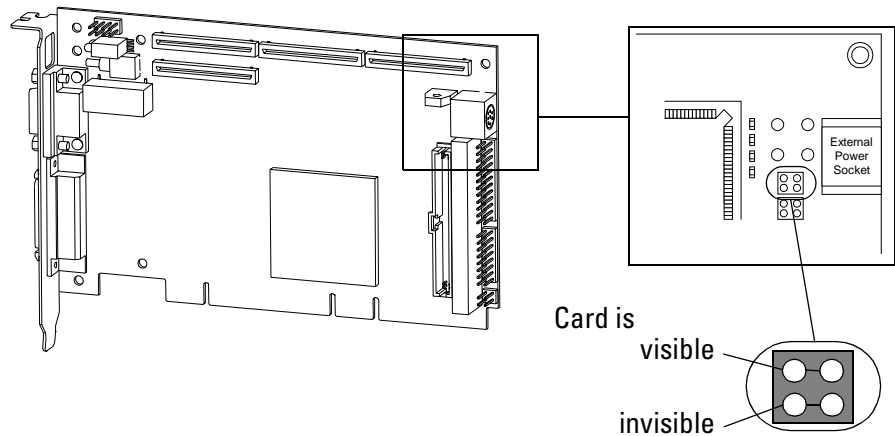

NOTE If the card is invisible for the PCI system, you cannot control the card via the PCI port.

Connecting to the Testcard

To transfer control information between control software and card, the card's control interfaces are used. The Agilent E2925B testcard features the following control interfaces:

- **Fast Host Interface**

This is the fastest connection to a testcard plugged into a remote system under test. The Fast Host Interface card coming with the PCI Analyzer must be plugged into the Control PC and connected to the parallel port on the testcard using the included bi-directional Centronics cable.

- **PCI Port**

The PCI port can be used for in-system analysis (when the software is running on the system under test). No cable or hardware required.

- **RS-232 Port**

The RS-232 port of the testcard can be connected to the serial interface of the Control PC using the included RS-232 cable.

The Agilent E2925B testcard supports baud rates up to 57600 Bit/s.

The actual value depends on the maximum baud rate supported by the serial interface of the Control PC.

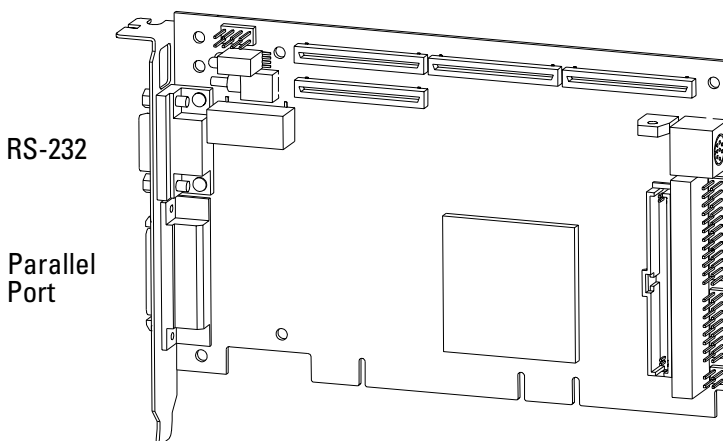

Different testcards can be connected to the control software simultaneously using different control interfaces, and be activated alternately.

NOTE The user interface software also provides an Offline/Demo Mode. In this mode, all features of the software can be used without hardware, for example, for analysis of previously stored data or test preparation without hardware. No connection is established in this case.

How to Select the Connection

After the hardware connection has been established, the user interface software supports you in identifying the available testcards and selecting the connection.

To connect to a testcard:

- 1 From the *Setup* menu, select *Testcard Configuration*.

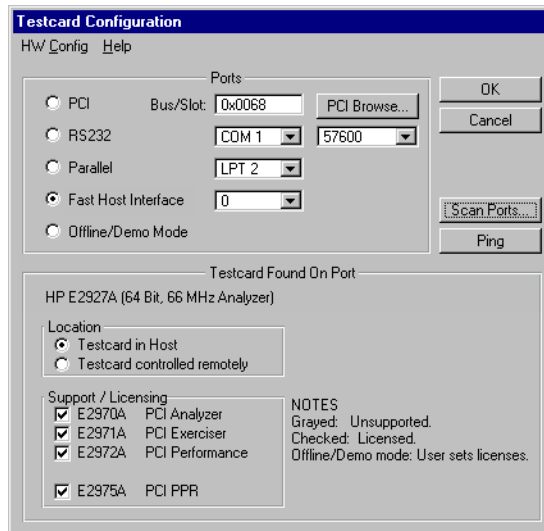

- 2 Click the *Scan Ports* button.

The software scans all available control interfaces and lists the testcards available at the associated ports.

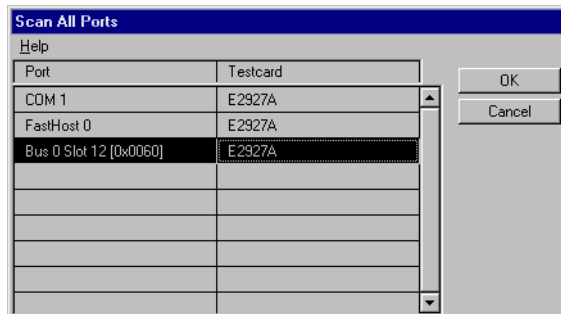

3 Select one of the listed ports by double-clicking the entry in the list.

If no error messages occur, the connection has been established successfully, and your selection will be displayed in the Testcard Configuration dialog box.

In case of any problem, refer to “*Connection Troubleshooting*” on page 45.

NOTE Using the *PCI Browse* button in the Testcard Configuration dialog box, you can select from a list of devices found on the PCI bus of the Control PC.

Using the *Ping* button, you can check the connection between the user interface software and the testcard on the selected port.

Connection Troubleshooting

If the selected connection cannot be established, an error message is displayed. Read the error message carefully and follow the steps described in the error message to eliminate the problem.

The following table provides additional information:

Table 1 Troubleshooting Tips

Error Mes- sage	Reason	Help
Version mismatch ...	Version conflict.	Refer to “ <i>Updating the Testcard</i> ” on page 103.
Port is not connected ...	Cable loose or disconnected.	Ensure that the cable is properly connected.
	Wrong type of RS-232 cable or adapter.	Use a adapter shipped with the testcard.
	Wrong bi-directional centronics cable.	Use the cable shipped with the testcard.
	Wrong port settings.	Correct the port settings in the Testcard Configuration dialog box.
	Wrong setting of user jumper.	Correct the setting of the user jumper, refer to Agilent E2925B User’s Manual, “ <i>Concealing the Card from the System</i> ”.

You can check the connection at any time while tracking down the error by selecting *Check Connection* from the *Setup* menu.

Analyzing Protocol Violations

When bringing up or debugging devices or complete systems, you have to check whether all devices keep to the protocol rules defined by the PCI Specification.

The PCI Analyzer provides an onboard protocol observer that monitors the PCI bus in real time to detect any protocol violations.

Protocol Observation

The Agilent E2925B testcard provides an hardware-implemented protocol observer that monitors the PCI bus to detect protocol violations.

Operation Principles The protocol observer monitors the PCI bus in real time with 100 % observation time. The PCI bus is monitored continuously while the testcard is powered.

The protocol observer monitors 53 protocol rules simultaneously. These rules refer to the rules of the PCI specification. Each rule can be individually masked to disable its observation (for a list of monitored protocol rules, refer to “*List of Rules Observed by the PCI Analyzer*” on page 105).

Multiple violations may occur in a sequence because a protocol violation of a PCI device will often cause malfunctions of other devices. Therefore, the protocol observer stores the first protocol violation and also counts and lists subsequent violations.

Processing Protocol Violations A detected protocol violation can be used as input for pattern terms (*bert* signal), for example, to trigger a data capture.

How to Set Up the Protocol Observer

The protocol observer is controlled from the Protocol Check window. This window allows you to mask and unmask rules, and displays the contents of the error register.

To set up the protocol observer:

- 1 From the *Analyzer* menu, select *Protocol Check*.

The current observation settings and results are uploaded from the testcard and displayed in the window.

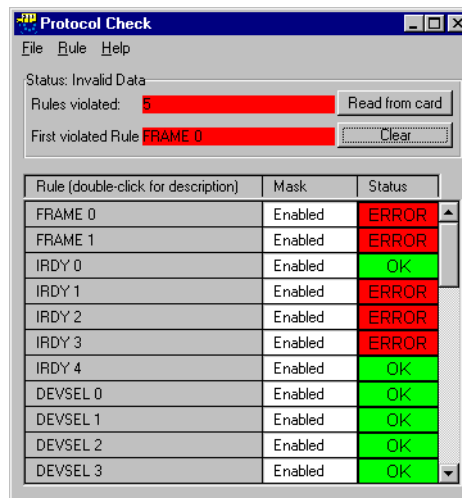

The *Status* group provides a result summary, showing the number of rules that have been violated and identifying the rule that has been violated first. The *Status* column in the *Rule* table shows error flags for each individual rule.

- 2 Select the rules to be monitored for your test by masking those rules that are not relevant.

The current status for the individual rules is shown in the *Mask* column. To modify the mask:

- Click an entry in the *Mask* column to toggle its state (enabled/disabled).
- From the *Rule* menu, select *Enable All* or *Disable All* to set the state for all rules at once.

- 3 After changing the rule mask, click the *Clear* button to reset the protocol observer.

NOTE Double-clicking an entry in the Rule column pops up a description of that rule.

Watching the Protocol Observer

The protocol observer monitors the PCI bus continuously while the testcard is powered. The results displayed in the Protocol Observer window, however, are only updated on demand. Therefore, there is the need to upload the result data from the testcard, and maybe to reset the observer (this is, to clear the results).

How to Upload Protocol Observer Results

The results of the protocol observer are not automatically uploaded to be displayed in the Protocol Observer window.

To upload the current state of the testcard registers to the display:

- 1 If the Protocol Check window is not displayed yet, select *Protocol Check...* from the *Analyzer* menu.
- 2 Click the *Read from card* button.

The current data will be uploaded from the testcard and be displayed in the window.

How to Reset the Protocol Observer

To restart a test, for example after changing the masking of protocol rules or for detecting the repeated occurrence of a protocol violation, you can reset the protocol observer.

To reset the protocol observer:

- 1 If the Protocol Check window is not displayed yet, select *Protocol Check...* from the *Analyzer* menu.
- 2 Click the *Clear* button.

This sets all rule states to OK, the total of *Rules violated* to 0, and the *First violated* rule to none. The protocol observer continues immediately. If a protocol violation cannot be cleared, this indicates that the violation still is present on the bus.

NOTE You can set the run options to clear the protocol check results with each start of a data capture.

Analyzing Timing Violations

When bringing up or debugging devices or complete systems, you have to check whether all devices keep to the timing rules defined by the PCI Specification.

The PCI Analyzer provides an onboard timing checker that monitors the PCI bus in real time to detect any timing violations. The timing check indicates an error when a PCI signal change is detected at a moment at which the PCI Specification calls for stable signals.

NOTE At the time being the timing check is only available for 33 MHz PCI busses.

Observed Timing Rules

Operation Principles When checking for timing violations, the Agilent E2925B testcard uses the set-up time t_{su} and the hold time t_h of each synchronous bus signal to determine the time window in which a PCI signal must be stable.

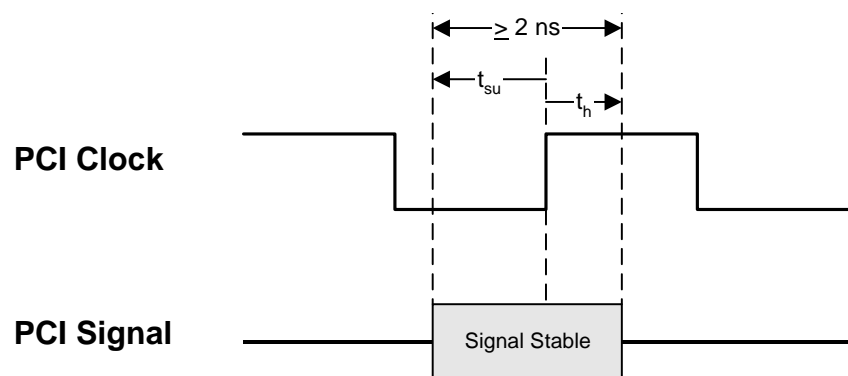

The permissible values of set-up and hold time are given by the PCI Specification.

The timing check automatically measures the bus clock frequency and checks against the permissible values. This is the default behavior. However, you can also adapt the timing check to special requirements by changing the range of permissible values.

Processing Timing Violations A detected timing violation can be used as input for pattern terms (*timing_err* signal), for example, to trigger a data capture.

Timing Check Limitations

Keep the following in mind when checking for timing violations:

- **List of checked signals**

Some signals are excluded from timing checks due to their particular timing behavior. For a list of checked signals refer to “*b_signaltype (for Timing Check)*” in the *C-API/PPR Reference*.

- **Typical measurement accuracy**

The typical measurement accuracy is below 250 ps.

However, the measurement accuracy can be guaranteed only if both setup and hold time values are set to the default values given by the PCI Specification.

The measurement accuracy also depends on the clock frequency and the environmental temperature.

- **Clock frequency**

The PCI clock must be lower or equal than 33 MHz and is not allowed to vary more than 0.5 %. Note that “Green PCs” may switch down clock frequency to decrease power consumption. When this happens during a timing check, it will result in a timing error.

The best measurement accuracy can be guaranteed only if the clock frequency is 33 (calibration point).

- **Environmental temperature**

The environmental temperature must be between 20 and 30 °C, otherwise the typical measurement accuracy cannot be guaranteed.

Adapting the Timing Checker

You can adapt the timing check to your test requirements by adjusting the permissible values, thus relaxing or tightening the measurement constraints.

The following table shows the PCI Specification values and the value ranges of the timing check:

Table 2 Timing Parameter Values

Timing Parameter [ns]	33 MHz PCI Bus (29 ... 35 MHz)	
	PCI Spec	Timing Check Range
t_{su}	7	5 ... 9
t_h	0	-2 ... +2

The following expression must apply:

$$2 \text{ ns} \leq t_{su} + t_h \leq \frac{1}{2 \times f} - 2 \text{ ns} \quad (f = \text{frequency in Hz})$$

Within the timing check ranges, you can vary the values in steps of 250 ps.

How to Set Up the Timing Checker

The timing checker is controlled from the Timing Check window. This window allows you to mask and unmask signals, and displays timing check results.

To set up the timing checker:

- 1 From the *Analyzer* menu, select *Timing Check*.

The current settings and results are uploaded from the testcard and displayed in the window.

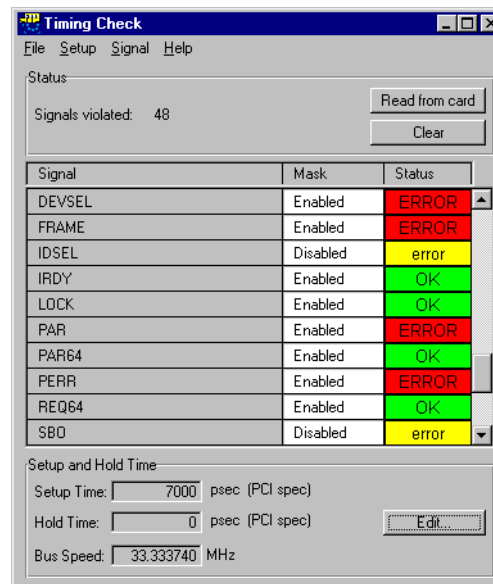

The *Status* group provides a result summary, showing the number of signals that have violated timing rules. The *Status* column in the *Signal* table shows error flags for each individual signal.

- 2 Select the signals to be checked for your test by masking those signals that are not relevant.

The current status for the individual signals is shown in the *Mask* column. To modify the mask:

- click an entry in the *Mask* column to toggle its state (enabled/disabled), or
- from the *Signal* menu, select *Enable All* or *Disable All* to set the state for all signals at once.

- 3 After changing the signal mask, click the *Clear* button to reset the timing checker.

NOTE The mask only affects the trigger—the status of a disabled signal is still displayed.

How to Modify Timing Limits

By default, the timing checker checks against the permissible values of set-up and hold time as given by the PCI Specification. These values can be adapted to meet custom testing requirements.

The current values and the measured PCI bus clock are displayed in the Timing Check window (see “*How to Set Up the Timing Checker*” on page 54).

To modify the timing limits:

- 1 In the Timing Check window click the *Edit* button.

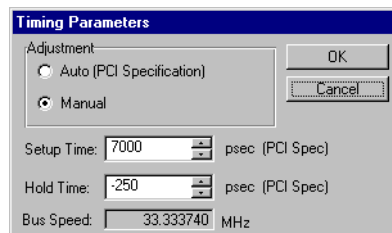

- 2 In the *Adjustment* group, select *Manual* and edit the parameter values,

or

select *Auto* to select the default values defined in the PCI Specification (depending on the PCI bus speed).

- 3 Click *OK*.

The accumulated error registers of the timing checker are cleared automatically, and the timing check continues with the new values.

Watching the Timing Checker

The timing checker monitors the PCI bus continuously while the testcard is powered. The results displayed in the Timing Check window, however, are only updated on demand. Therefore, there is the need to upload the result data from the testcard, and maybe to reset the checker (this is, to clear the results).

How to Upload Timing Checker Results

The results of the timing checker are not automatically uploaded to be displayed in the Timing Check window.

To upload the testcard registers to the display:

- 1 If the Timing Check window is not displayed yet, select *Timing Check...* from the *Analyzer* menu.
- 2 Click the *Read from card* button.

The current data will be uploaded from the testcard and displayed in the window.

How to Reset the Timing Checker

To restart a test, for example after changing the signal mask, you can reset the timing checker by clearing the results.

To reset the timing checker:

- 1 If the Timing Check window is not displayed yet, select *Timing Check...* from the *Analyzer* menu.
- 2 Click the *Clear* button.

This sets the results for all signals to *OK* and the total of *Signals violated* to 0.

The timing check is restarted immediately. Therefore, a displayed timing error will not disappear by clicking the *Clear* button, if the error is still present.

NOTE You can set the run options to clear the timing check results with each start of a data capture.

How to Debug Timing Violations

If a timing violation has been detected, you can use the trigger I/O on the Agilent E2925B testcard and an oscilloscope for in-depth analysis:

1 Select a signal

Use the Timing Check window to set the focus on a signal line on which a timing violation has been detected. Enable this signal and disable all remaining signals.

2 Set up the trigger I/O sequencer

A command line script shipped with the Agilent E2925B testcard software sets up the trigger I/O sequencer. When the script runs, a positive pulse is issued on trigger I/O 0 after a timing error.

To run the script, enter the following in the command line interface:

```
do ..\samples\gui\tmgchktr.cli
```

3 Connect an oscilloscope

Connect an oscilloscope's trigger input to the Agilent E2925B testcard's trigger I/O line 0, and connect the oscilloscope's inputs to the PCI signal of interest and to the PCI clock.

4 Run the Timing Check

Generate traffic and run the PCI Analyzer of the Agilent E2925B testcard.

5 Analyze the waveform

Watch the oscilloscope. Look for glitch, overshoot, undershoot, ringing, marginal voltage levels, and so on. Try also various locations on the signal's PCI trace, such as locations close to the driver or to the receiver of the signal.

Analyzing PCI Performance

In the bring-up and debug phase of a PCI device or a system (containing PCI bus and PCI devices), you need to evaluate the performance of the device or system under test.

The PCI Analyzer supports real-time performance measurement by providing predefined, standardized performance measures, such as PCI efficiency and PCI utilization.

These measures can be set up easily. The results are shown in graphical charts.

Performance measurement is based on counting certain events on the PCI bus. For the predefined measures, the counters are set up automatically.

For more advanced measurements, you can program the counters by yourself, providing full flexibility.

The Performance Optimizer (option #200) expands the possibilities of real-time performance measurements, by providing means for detailed post-processed analysis.

Generating PCI Traffic The PCI Analyzer can measure any kind of PCI traffic, regardless of how it was generated. However, it is useful to generate traffic in a controlled way for reproducibility in case of troubleshooting or root cause analysis. Typically, you will use benchmark tests to generate traffic for this purpose.

Predefined Performance Measures

For real-time performance measurements, the PCI Analyzer counts occurrences of predefined events or sequences of events on the PCI bus. The results are derived and displayed in real time.

Available Measures The following predefined measures are provided by the PCI Analyzer:

- **Throughput**

Throughput is the amount of transferred data per time. It is measured in Mbyte per second. When running a real-time measurement, this value is displayed in percent of the maximum value (for 33 MHz systems: 132 Mbyte per second in a 32-bit system, 264 Mbyte per second in a 64-bit system).

- **Utilization**

Utilization measures the relation between busy bus time and total bus time during a transfer.

- **Efficiency**

Efficiency is a measure of how well the bus is used. It is the most important value when considering PCI performance.

The efficiency of a transfer is the relation between the amount of data that was *really* transferred and the amount of data that could have been transferred by the used cycles of that transfer (busy clocks).

Efficiency is derived from throughput and utilization. An efficiency near 100 % means that a device made best use of the time it occupied the bus (utilization) by transferring as much data as possible during that time frame (high throughput).

- **Retry Rate**

This is the ratio between retry transactions and all transactions.

How to Select Predefined Performance Measures

The PCI Analyzer can calculate two real-time measures simultaneously. The test results are displayed side by side on screen.

To select the predefined performance measures to be used:

- 1 From the *Analyzer* menu, select *Real Time Counter Setup*.

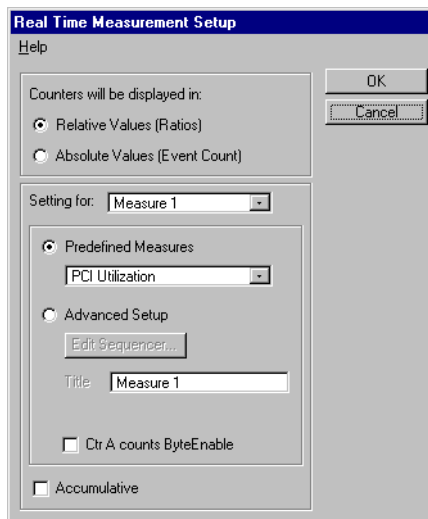

- 2 Check the *Relative Values (Ratio)* option (this is the default).
When selecting *Absolute Values (Event Count)*, the pure counter values will be displayed instead of the predefined measures.
- 3 From the *Setting for* selection list, select *Measure 1*.
- 4 From the *Predefined Measures* selection list, choose the predefined measure to be calculated and displayed for measure 1.
- 5 Make sure *Accumulative* is not checked.
The measured values will be reset after each measurement time interval. This allows you to better observe peaks. Otherwise the values will be accumulated over time.
- 6 Repeat steps 3 to 5 for *Measure 2*.
- 7 Click *OK*.

The new settings will be used the next time you start a performance measurement.

How to Run a Performance Measurement

After completing the setup the real-time performance measurement can be started.

To run a real-time performance measurement:

- 1 From the *Analyzer* menu select *Real Time Counter Result*.
- 2 To set the time interval in which the display is to be updated, enter an *Update Rate* between 1 and 60 seconds.
- 3 Click the *Start* button.

This shows the results of the selected measures per time interval. If you have selected *Accumulative* in the Real Time Measurement Setup, the results will be accumulated.

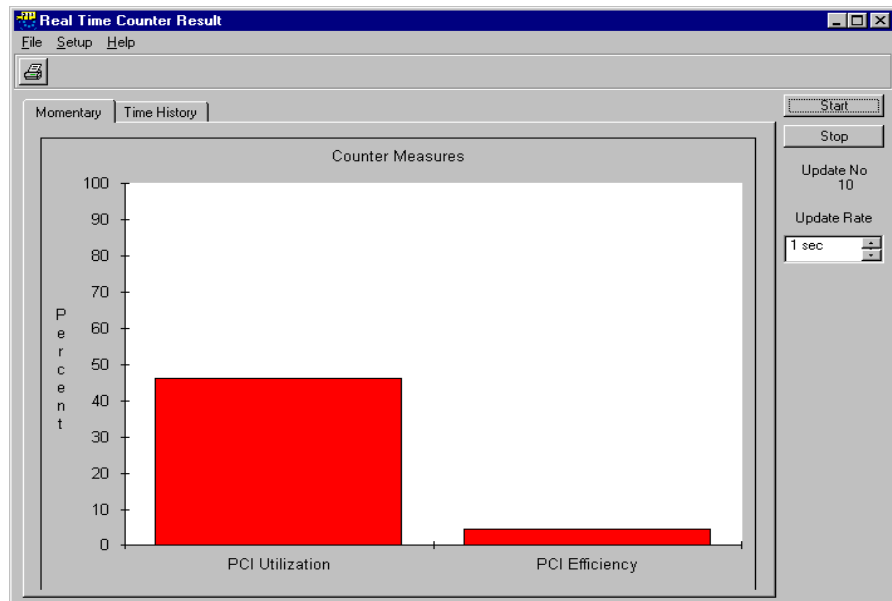

The diagram on the *Momentary* tab shows the current values of the selected measures.

- 4 To see the result history over time, select the *Time History* tab.
You can toggle between both tabs while the measurement is running.

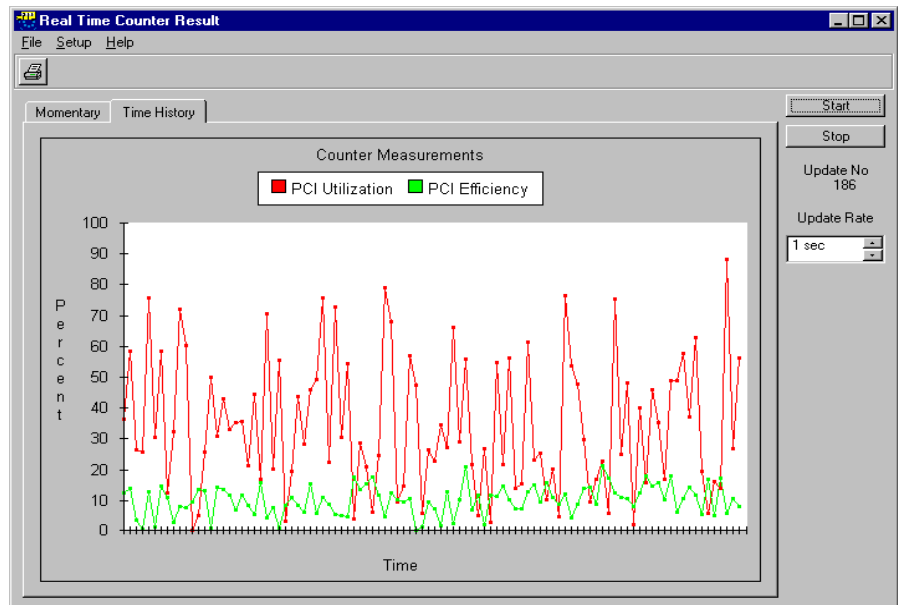

- 5 To stop the measurement, click the *Stop* button and close the window.

Advanced Performance Measures

The PCI Analyzer can calculate and display two performance measures simultaneously. Each measure can either show one of the predefined measures or be programmed manually for advanced performance measurements.

Operation Principles

The performance measures of the Agilent E2925B testcard employ programmable counters, which are controlled by sequencers to count signal states or sequences of signal states. For an advanced real-time measurement, you can *manually* specify the events to be counted and program the sequencers. For an example, refer to “*Sample Advanced Performance Setup*” on page 66.

For each performance measure there are two programmable counters. The following figure shows—for one performance measure—how the counters are controlled by the sequencer. Additionally, there is a reference counter counting the bus cycles.

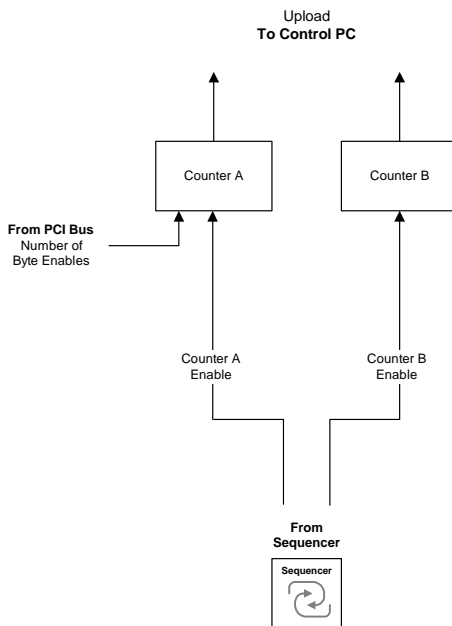

- Incrementing the Counters** By means of programmable conditions, the sequencer enables the counters to be incremented:
- If enabled, counter B is incremented by 1 per bus cycle.
 - If enabled, counter A is either incremented by 1 per bus cycle, or by the number of byte enables currently set (0...4 for 32-bit, 0 ... 8 for 64-bit accesses).
- This feature is controlled by the *Ctr A counts Byte Enable* check box in the Real Time Measurement Setup dialog box. Counting byte enables allows you to count actually transferred data (and not only data phases).
- Counter Sequencers** The behavior of the counter sequencers is determined by a sequencer description table and pattern terms in the same way as the data capture is controlled by the trace memory trigger sequencer.
- However, the sequencer's outputs are the count enables for the counters A and B. The count enables are changed while the sequencer switches through its states as described by the transitions. Its output conditions determine whether or not the referenced counter is incremented.
- If *Relative Values* is selected in the Real Time Measurement dialog box, the performance measure is calculated as the ratio of counter A and B, using counter A as *nominator* counter and counter B as *denominator* counter.
- NOTE** The counter C in the *Transitions* table in the Performance Counter Sequencer dialog box is a feedback counter, which can be used for programming sequencer loops.
- PCI Clock Reference Counter** The testcard also provides a 64-bit wide PCI clock reference counter. It counts PCI clocks only, and is started, stopped and updated together with the other counters. It is used as a time reference for the performance measures and is displayed only if *Absolute Values (Event Count)* is selected in the Real Time Measurement Setup dialog box.

Sample Advanced Performance Setup

To explain how to program an advanced performance measure, an example shows how to measure the proportion of non-idle cycles in PCI traffic.

The required sequencer setup is quite simple. It uses the **pattern term** pt4 as follows:

- pt4: b_state=Idle

This makes pattern term pt4 sensitive to idle cycles.

The **sequencer** of performance measure 1 is programmed to remain in state 0 only, incrementing counter A and B if their enable conditions are true:

- Counter A must be incremented with each non-idle cycle. Therefore, pattern term pt4 must be inverted.
- Counter B must be incremented with each clock cycle.

The sequencer description table must be set up as follows:

Table 3 Sample Sequencer Description Table

State	Next State	Transition Condition	Counter A Enable Condition (Output)	Counter B Enable Condition (Output)
0	0	1	!pt4	1

NOTE In the table above, only those columns are shown that need to be programmed for the example.

How to Set Up the Measures for the Example

To program the counter sequencer according to the example, proceed as follows:

- 1 From the *Analyzer* menu, select *Real Time Counter Setup*.

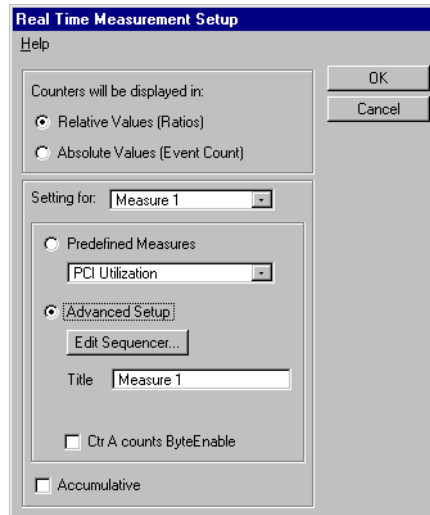

- 2 Check the *Relative Values (Ratios)* option.
Otherwise, the absolute values of the counters would be displayed.
- 3 From the *Setting for* selection list, select *Measure 1*.
- 4 Ensure that *Accumulative* is deactivated.
The software calculates the ratio of the two current counter values.
Otherwise, the software would calculate the ratio of the accumulated counter values over the testing time.
- 5 Select *Advanced Setup*.
- 6 If you wish to have a title for the measure on the Counter Result window, enter a name for your measurement in the *Title* text field.
- 7 Ensure that *Ctr A counts Byte Enable* is deactivated.
Otherwise, counter A will count byte enables to measure the amount of transferred data.

How to Program the Counter Sequencer for the Example

After basically setting up the measures for the example, go on to program the counter sequencer as required:

- 1 In the Real Time Measurement Setup dialog box, click the *Edit Sequencer* button.

The Performance Counter Sequencer dialog box will be opened.

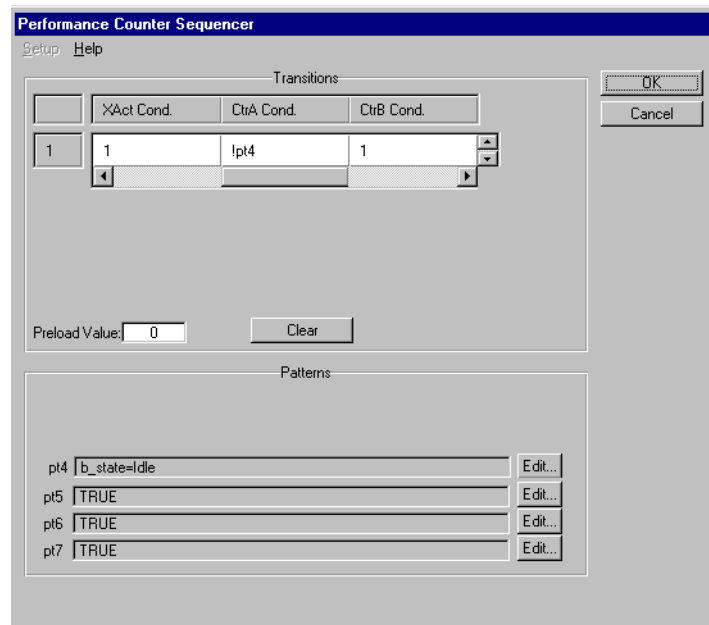

Now edit the sequencer description table and the pattern term:

- 1 Enter the required conditions and terms in the *Transitions* table.

You can scroll horizontally and vertically through the sequencer table.

- 2 Leave the *Preload Value* at its default value.

The preload value allows you to specify an initial value for the feedback counter C. This is used to wait for a certain number of events before transition output.

- 3 Click the *Edit...* button of pattern term pt4 to edit the pattern.

The Pattern Editor dialog box will be opened (see “*How to Specify a Trigger Pattern*” on page 77).

For the example, set `b_state=Idle` for pattern term pt4.

NOTE pt4 to pt7 are associated with Measure 1.
pt8 to pt11 are associated with Measure 2.

4 Click *OK* to close the Performance Counter Sequencer dialog box.

5 Click *OK* to close the Real Time Measurement Setup dialog box.

Now you can start the real-time measurement using your counter setup as described in “*How to Run a Performance Measurement*” on page 62.

Capturing Data In The Trace Memory

The PCI Analyzer records information like PCI signals and bus states in its trace memory. The information is stored in one trace memory line per PCI clock cycle. By default, the Agilent E2925B testcard stores 64 k lines. With the option #100, you can expand the trace memory to 4 M lines.

Controlling the Data Capture The PCI Analyzer provides all features required to make optimum use of the available memory depth.

- The trigger allows you to start capturing data when a programmable trigger event has occurred. Furthermore, by specifying the triggerpoint you can additionally control the number of bus cycles stored before and after the trigger event.
- Storage qualification allows you to selectively capture only certain types of data. For example, you can focus on accesses to a particular device, or on data transfers only.
- A heartbeat function allows you to implement a watchdog by triggering on a particular event that does *not* occur after a programmable time.
- Trigger and storage qualifier can be controlled by a programmable sequencer.

Using the Data Capture Data stored in the trace memory can be displayed at different levels of abstraction: as waveforms, bus cycles, or transactions.

You can not only analyze the data in terms of PCI behavior, but also implement functional tests like data compares. For example, if you are debugging a LAN interface, you could capture all of the blocks of data going into and coming out of the card. Once this data has been captured, you can analyze it further for debugging.

Data Stored In The Trace Memory

The trace memory on the Agilent E2925B testcard stores all PCI signals and bus states, the Exerciser states, and additional information. The trace data is stored in one trace memory line for each PCI clock cycle and can be used for low-level debugging and understanding of bus traffic.

Trace Memory Components

The capture is controlled by the trace memory *trigger* and the *storage qualifier*.

These are in turn controlled by the programmable *trace memory trigger sequencer*. This sequencer implements a state machine, allowing to define individual trigger and storage qualifier conditions for each state.

The sequencer is only available if the capture mode *Sequencer* has been selected.

The figure below gives an overview of the components building the trace memory.

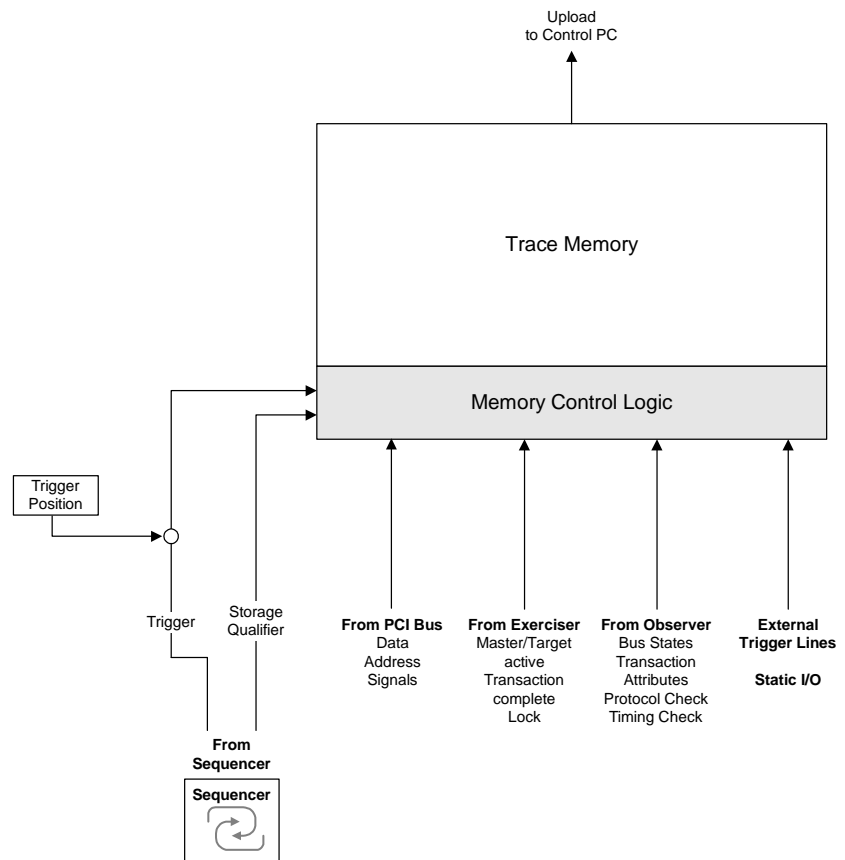

Recording Data The trace memory is a circular memory that is filled continuously while the Analyzer is running. The storage qualifier controls which bus states are recorded. If one or more lines are filtered, a gap information is stored instead.

Recording is stopped after the trigger event has occurred. The trigger position specifies the amount of pre-trigger and post-trigger data to be kept in the data capture.

The following figure illustrates these mechanisms:

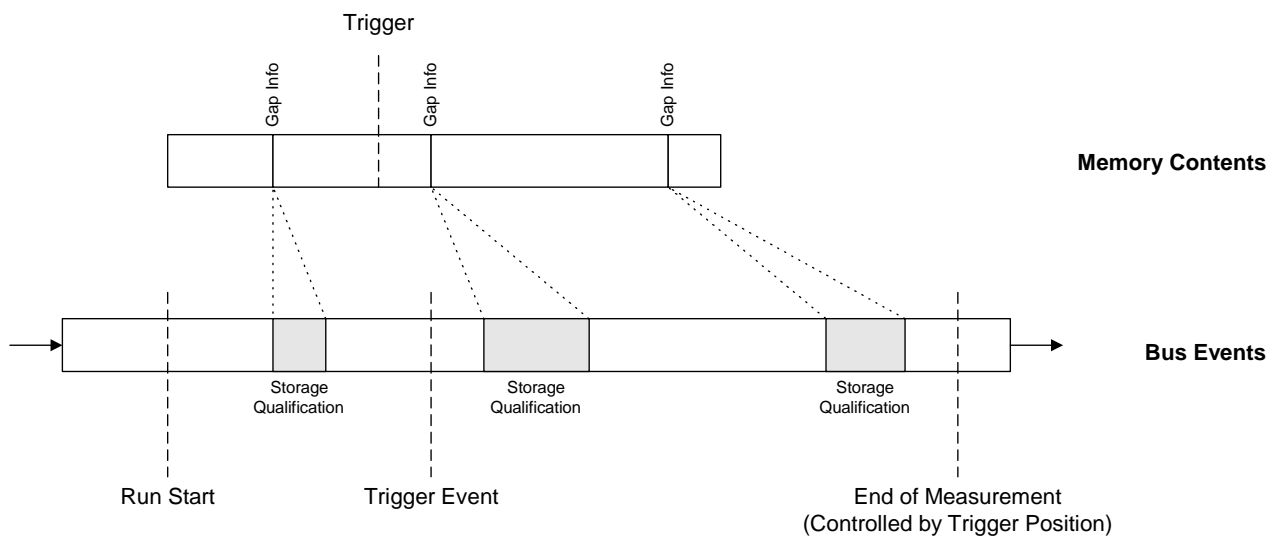

The lower bar in the figure represents events on the bus. Some of them do not meet the storage qualifier condition and are therefore filtered (gray areas). Gap information is stored instead of the events.

After the Analyzer has been started, the memory is filled. Because the trace memory is a circular memory, previously captured states will be overwritten until the trigger event occurs.

Stored data is represented by the upper bar in the figure: not suppressed bus events and gap information. When the trigger event occurs, the trace memory continues to be filled until the specified amount of post-trigger information is stored.

Uploading Data At this time, the measurement is complete, and the trace memory contents are uploaded. They can be displayed in the waveform viewer, the bus cycle lister, and the transaction lister.

To reduce the upload time you can specify the size of the trace memory to be uploaded. This does not reduce the amount of data that is recorded.

NOTE If the Analyzer is set up to fill the trace memory after a trigger event and the event does not occur, stopping the Analyzer sets an artificial triggerpoint. The trace memory will then contain 100 % pre-trigger history. The last captured state is the state before the Analyzer has been stopped.

Nevertheless, the trace memory can still be empty if no samples were taken because of the storage qualification.

Capture Mode

The availability of the sequencer depends on the selected capture mode. The Agilent E2925B testcard provides the following modes for capture control:

- **Standard**

In the standard mode, the trace memory trigger and storage qualifier are directly controlled by pattern terms. Pattern terms are programmable pattern recognizes. If the programmed pattern is found on the bus, the pattern term signals

- the trigger to initiate the sampling, or
- the storage qualifier to capture the current sample.

- **Sequencer**

In the sequencer mode, the trigger sequencer controls the trace memory's trigger and storage qualifier. The sequencer detects sequences of patterns. To detect the patterns, it uses pattern terms as input. Each state of the sequence can be used to control the sequencer's output, trigger and storage qualifier.

- **Performance**

The performance mode is only available if the PCI Optimizer (option #200) has been installed.

In the performance mode, the storage qualifier is automatically programmed as required for performance measurements. A trigger can be set up to start the measurement.

Setting Up the Data Capture

- Select the capture mode.
 - Set up the trigger.
If required, specify a trigger pattern.
- Set up the storage qualifier.
If required, select transactions and states to be stored in the trace memory.

For more advanced measurements the sequencer can be programmed as described in “*Setting Up the Trigger Sequencer*” on page 81.

How to Select the Capture Mode

Start setting up the data capture by specifying the amount of data to be uploaded after the trigger event, and by selecting the capture mode:

- 1 From the *Setup* menu, select *Mode* and then the *Analyzer* tab.

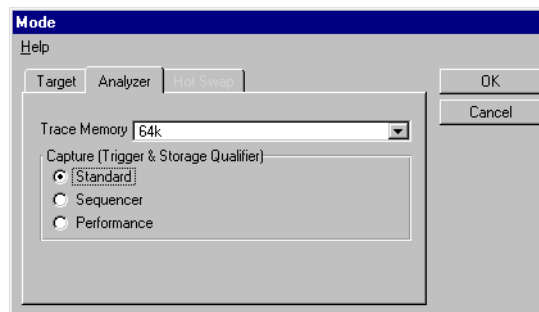

- 2 From the *Trace Memory* selection list, choose the amount of data to be uploaded to the user interface software after the trigger event.
Choose a small size in order to minimize uploading time.
- 3 In the *Capture (Trigger & Storage Qualifier)* section, select the required mode.
- 4 Click *OK*.

How to Set Up the Trigger

To set up the trigger in standard capture mode, program the pattern for the trace memory trigger. The sequencer is not available in this mode.

By default, the trigger is set to immediate. The data capture will be started as soon as the Analyzer is started.

To specify a trigger event:

- 1 In the main window, click the Capture button .

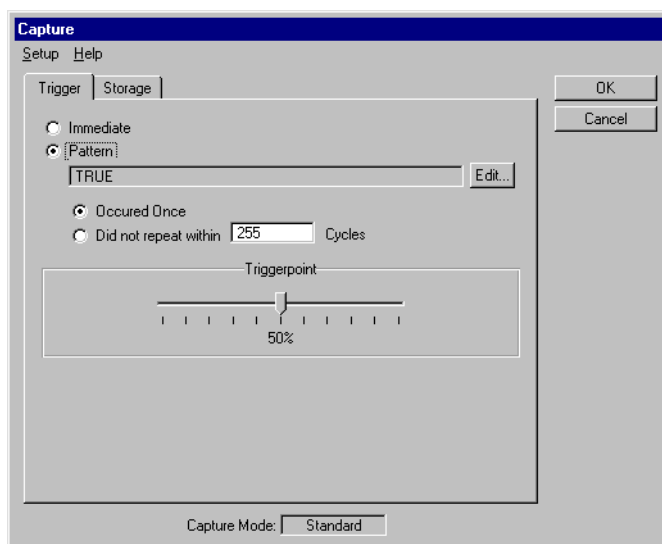

- 2 Select *Pattern* to start setting up the trigger event.
- 3 Click the *Edit* button to specify the pattern term describing the event. This opens the Pattern Editor dialog box where you can set up the pattern as described in “*How to Specify a Trigger Pattern*” on page 77. On return, the pattern term will be displayed in the text field. By default, the trigger will be fired after the first occurrence of the trigger event. However, you can also implement a kind of watchdog by triggering on the absence of the trigger event.
- 4 To trigger on the absence of the trigger event over a number of clock cycles, select *Did not repeat within ... cycles* and enter a number of clock cycles.

The number of clock cycles must be a decimal value in the 32-bit range, being a multiple of 256 minus 1 (the software automatically adjusts your value).

- 5 Move the slider to specify a *Triggerpoint*:
 - 0 % means: no pre-trigger history is stored
 - 100 % means: only pre-trigger history is stored
- 6 Now the trigger is set up. Click *OK* to store your settings or change to the *Storage* tab to set up the storage qualifier (see “*How to Set Up the Storage Qualifier*” on page 79).

How to Specify a Trigger Pattern

The Pattern Editor window supports you in setting up the conditional expressions describing, for example, the trigger event.

Specifying a pattern means selecting the signals and values of interest. Your selections will be AND-combined to build the pattern term.

To specify the trigger pattern:

- 1 Click the *Edit* button on the *Trigger* tab in the Capture dialog box to open the pattern editor.

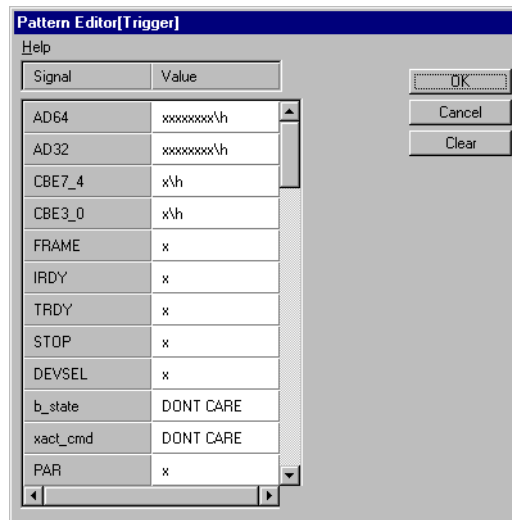

- 2 To assemble the pattern, click in the *Value* column of the required signals.

The method of entering the values depends on the type of the signal:

- If the signal is a **bit vector**, for example, the address and data bus signal *AD32*, you can enter the value directly into the value field. Possible formats are hexadecimal (entry ends with **\h**), decimal (**\d**) and binary (**\b**).
- If the signal is a **single bit**, for example the protocol violation signal *berr*, clicking on the value field will display a selection list containing 0, 1, and x (don't care).
- If the signal is of any other type that can take several different values, as for example the bus state *b_state* or the transaction command *x_act*, clicking the value field opens the Selection List dialog box presenting the possible options.

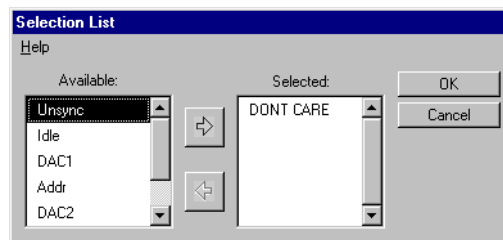

Select from the list of available states and use the arrow buttons to move them between both lists. If you select more than one state, the states will be OR-combined.

To return to the pattern editor, click *OK*.

- 3 After you have included all required signals, click *OK*.

The signals of the pattern will be AND-combined automatically to build the conditional expression. For example, setting the *FRAME* and *IRDY* values to 1, will result in this logical expression: “*FRAME=1 && IRDY=1*”.

How to Set Up the Storage Qualifier

To set up the storage qualifier in standard capture mode, program a pattern to specify the transactions and states to be stored. Furthermore, you can select to suppress certain cycles if they are irrelevant for your test. By default, all cycles will be captured.

To specify the storage qualifier:

- 1 From the *Analyzer* menu, select *Capture* and change to the *Storage* tab.

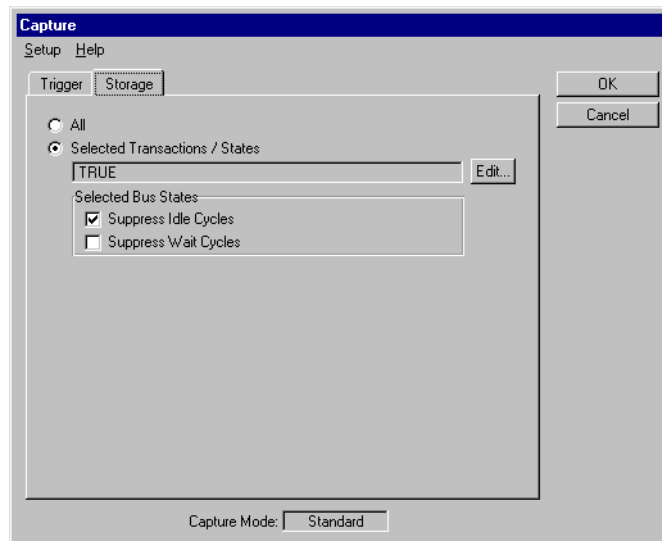

- 2 Select *Selected Transactions/States* to start setting up the storage qualifier.
- 3 Click the *Edit* button to specify the pattern term describing the storage qualifier condition.

This opens the Pattern Editor dialog box where you can set up the pattern as described in “*How to Specify Transactions and States*” on page 80. On return, the pattern term will be displayed in the text field.

- 4 In the *Selected Bus States* section, check the bus states you wish to suppress from being stored (idle and/or wait cycles).
- 5 Click *OK*.

How to Specify Transactions and States

If you wish to exclude transactions or bus states from being stored in the trace memory, you need to specify a conditional expression for the storage qualifier. The pattern editor supports you in setting up this expression.

NOTE The storage qualifier condition identifies the transactions and states to be stored and, thus, suppresses all others.

To specify the conditional expression to select transactions and states:

- 1 Click the *Edit* button on the *Storage* tab in the Capture dialog box to open the pattern editor.

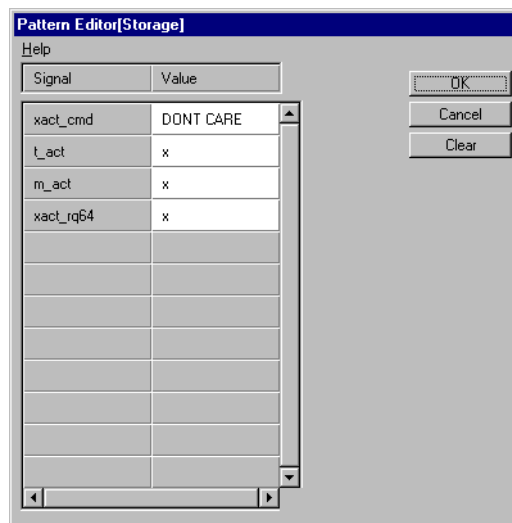

- 2 To assemble the pattern, click in the *Value* column of the required signals.

The method of entering the values depends on the type of the signal: If you keep the mouse button pressed, a box appears listing suitable values for selection.

- **xact_cmd**: select commands to store only transactions using these commands
- **t_act**: set this to 1 to store only transactions in which the *target* of the Agilent E2925B testcard is involved, or set it to 0 to suppress these transactions
- **m_act**: set this to 1 to store only transactions in which the *master* of the Agilent E2925B testcard is involved, or set it to 0 to suppress these transactions

- **xact_rq64**: set this to 1 to store only transactions with a 64-bit request, or set it to 0 to suppress these transactions

3 After you have included all the required signals, click *OK*.

The assembled transactions and state settings are automatically AND-combined to build the storage qualifier condition.

NOTE The signals `t_act` and `m_act` are only valid if the PCI Exerciser option has been installed.

Setting Up the Trigger Sequencer

For more advanced measurements you can program the Agilent E2925B testcard's trigger sequencer to implement sophisticated trigger and storage qualifier conditions.

Goals of the Sequencer The sequencer is designed to detect sequences of bus states. It is implemented with a state machine that compares bus states with programmable pattern terms to recognize these sequences.

The trigger sequencer controls the *trigger* and the *storage qualifier* for the trace memory. The trigger is fired after a specified sequence of bus states has been detected. After the trigger has been fired, the trace memory is filled with sampled states under the control of the storage qualifier.

The following figure details the trace memory trigger sequencer.

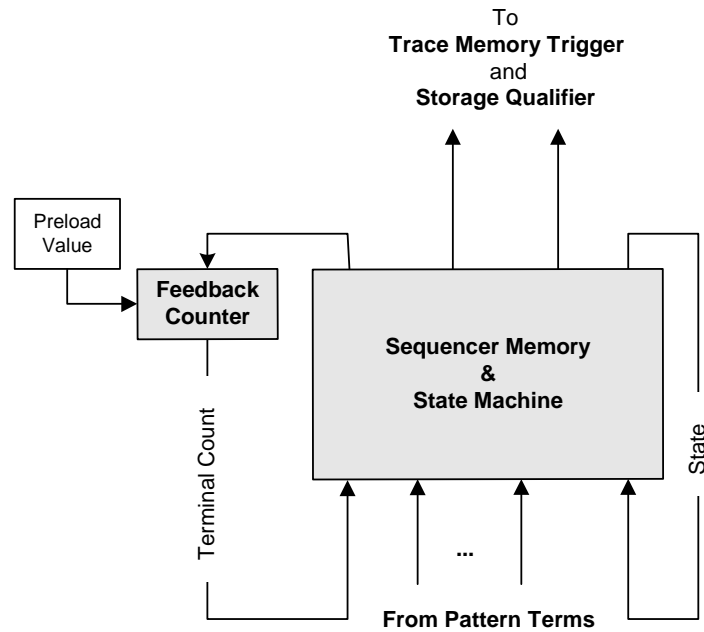

Sequencer Internals The sequencer provides an internal memory, a state machine, and a 32-bit feedback counter. The state machine controls the operation of the sequencer.

For each state, *transition conditions* specify when to switch to the next state. The transition conditions can be built from pattern terms and the terminal count of the sequencer’s feedback counter.

Feedback Counter A feedback condition is used to decrement a loop variable that starts counting at the preload value. The preload value is set if a specified preload condition is met. If the loop variable reaches zero, the terminal count signal (tc) is set, which can be used within a pattern term.

Sequencer Description Table The sequencer is controlled by a *sequencer description table* consisting of a number of transitions. Each transition is defined by a table row, holding a state number, the number of the next state, and the condition defining when to switch to the next state.

In addition, each transition defines output conditions:

- the feedback counter enable
- the feedback counter preload condition
- the trigger signal
- the storage qualifier

NOTE All actions take place on a state transition. There are no inherent actions by being in any state.

Sample Sequencer Setup

Example Task To show the basic principles of programming the trigger sequencer let us consider an example. The following sequence is to be detected:

1. Wait for the address phase of an access to video memory.
2. When the address phase is detected, trigger and store all the transfers.
3. Stop storing if an idle cycle occurs.
4. Wait for the next access to video memory.

Pattern Terms For this sequence, the following patterns need to be detected and are therefore assigned to pattern terms:

- `pt1 = AD32==b8xxx && b_state=Addr`

This programs pattern term pt1 to detect address phases of video memory accesses.

- `pt2 = b_state==Transfer`

This programs pattern term pt2 to detect transfers.

- `pt3 = b_state==Idle`

This programs pattern term pt3 to detect idle cycles.

Building a State Diagram The next step is to determine the sequence in which the patterns are to be detected and what is to happen to the trigger and storage qualifier. Especially when planning for long and difficult sequences, it is recommended that you use a state diagram like the following:

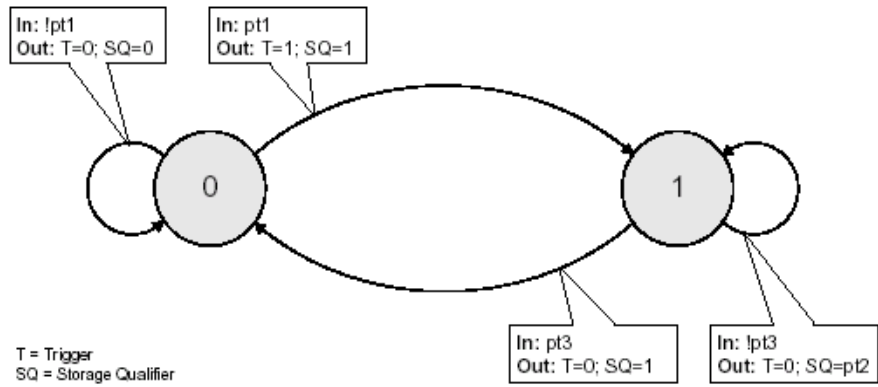

This state diagram can easily be translated into a sequencer description table.

Each transition (arrow) in the state diagram requires a row in the table. The sequencer description table for the example is as follows:

Table 4 Example Sequencer Description Table

State	Next State	Transition Condition	Trigger Condition	Storage Qualifier Condition
0	0	!pt1	0	0
0	1	pt1	1	1
1	1	!pt3	0	pt2
1	0	pt3	0	1

How to Set Up the Trigger Sequencer

Setting up the trigger sequencer can be quite complicated, depending on the test requirements. The following instructions only outline the basic steps. Use this sample sequencer setup to make yourself familiar with the principles of sequencer programming.

To set up the trigger sequencer:

- 1 From the *Setup* menu, select *Mode* and then the *Analyzer* tab.

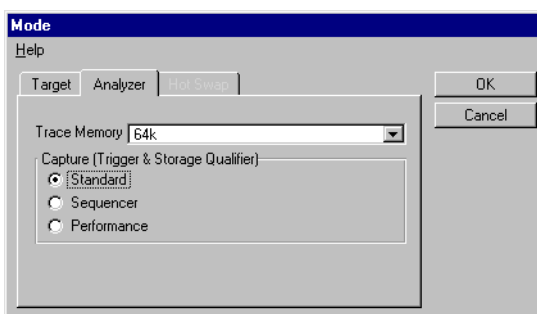

- 2 In the *Capture (Trigger & Storage Qualifier)* section, select the *Sequencer* mode.
- 3 Click *OK*.
- 4 From the *Analyzer* menu, select *Capture*.

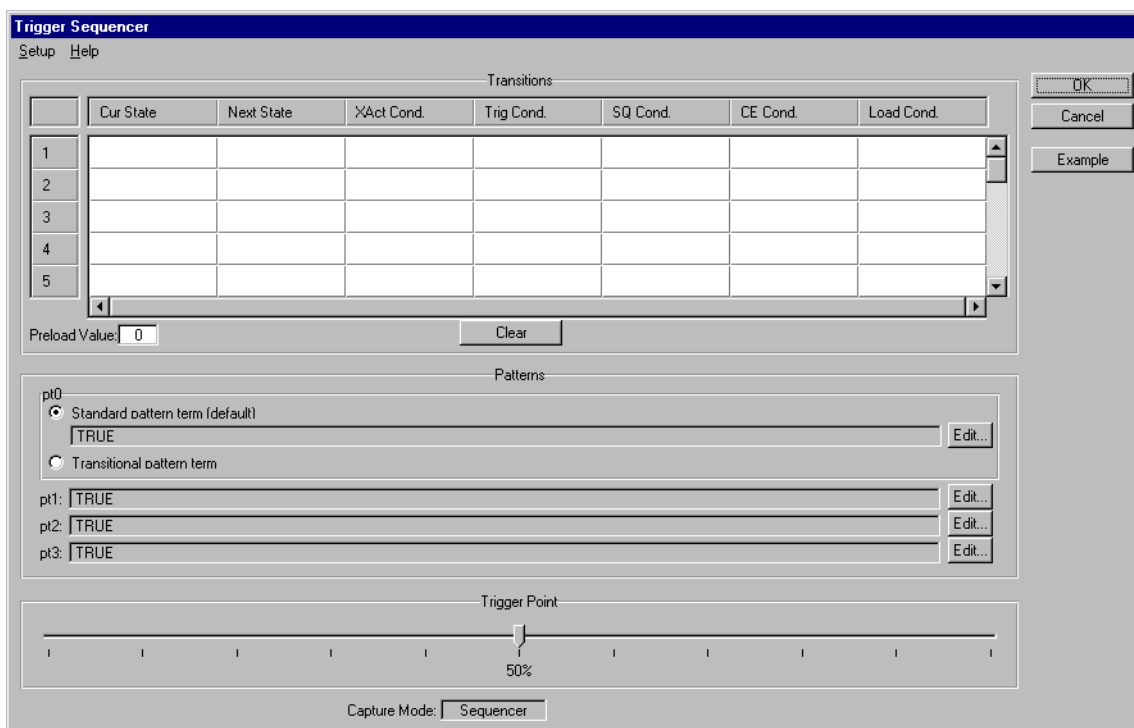

To load the sequencer description table for the sample sequencer setup, you may simply click the *Example* button, and the values will be filled in automatically.

In general, proceed as follows to enter the sequencer setup you have developed on your own:

- 1 Enter your sequencer description table into the *Transitions* table.
- 2 Set the *Preload Value* of the sequencers's feedback counter (not used in the example).

The preload value of the sequencer's feedback counter determines how often a sequence must occur before an output signal is set or a transition is made.

- 3 Assemble the patterns pt0 to pt3 as described for the trigger patterns in "*How to Specify a Trigger Pattern*" on page 77.

To detect signal changes instead of signal states, set up pt0 as a *Transitional pattern term*. It then detects any signal change.

- 4 Move the slider to specify a *Triggerpoint*:
 - 0 % means: no pre-trigger history is stored
 - 100 % means: only pre-trigger history is stored
- 5 Now the trigger sequencer is set up. Click *OK* to store your settings.

NOTE All transition conditions of one state must be exclusive. This means, that one—and only one— transition condition of a state must turn true at a time. Otherwise, the software will not accept the table because the table does not uniquely define the sequencer's behavior.

Running the Data Capture

After setting up the trigger and storage qualifier or programming the sequencer, the testcard is ready to run the data capture.

Starting the PCI Analyzer enables the pattern terms and the trigger or trigger sequencer to recognize patterns and to react according to your setup.

The analysis requires traffic on the PCI bus under examination. Therefore, load traffic onto the bus when running the PCI Analyzer. This traffic can be generated by application-level test programs (benchmarks etc.) or by means of one or more Agilent PCI Exercisers.

Running the Analyzer There is more than one way to start the PCI Analyzer:

- The Run button  and the *Start* item from the *Run* menu start the testcard. The components to be started can be specified in the Run Options window (select *Options* from the *Run* menu):



The number of available options depends on the installed software and hardware options.

Note that you can direct the software to clear all pending protocol and timing errors when the testcard is started.

- To start the PCI Analyzer only, select *Run* from the *Analyzer* menu.

Monitoring the Test While the test is running, messages appear in the PCI Analyzer status bar displaying its current status.

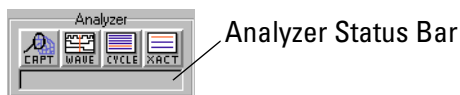

Stopping the Analyzer When the trigger event occurs, the Analyzer continues to write post-trigger history to the trace memory as specified by the triggerpoint and then stops.

You can stop the PCI Analyzer manually as well, for example, if the trigger pattern does not occur or if the test runs over an unexpectedly long time.

Stop the PCI Analyzer by

- selecting *Stop* from the *Analyzer* menu to stop only the PCI Analyzer, or
- clicking the Stop button  to stop both, Exerciser and Analyzer.

Viewing And Processing The Trace Memory Capture

The Three Listers The PCI Analyzer provides three tools to view and evaluate the captured PCI traffic at different levels of abstraction:

- **Waveform Lister**

At the lowest abstraction level the waveform lister displays the state of each signal (0 or 1) and the bus conditions (addresses and data on address/data lines, byte enables, and commands on the C/BE lines) at each clock cycle of the capture.

- **Bus Cycle Lister**

The bus cycle lister derives information on the type of each bus cycle and displays a list of the detected signals and states per bus cycle. For example, the state of the C/BE lines during an address phase is evaluated to display the referring command.

- **Transaction Lister**

At the highest abstraction level the transaction lister shows a list of the transactions found in the captured data. It summarizes the clocks of each transaction in one line and lists certain attributes or parameters that are detected during the transaction (for example, address, waits, retries).

Synchronizing the Listers The listers can be used in parallel and be synchronized to view the same range of samples of the capture at the same time.

Processing the Information The information shown in the listers can be saved and restored for later analysis (see “*Processing the Captured Data*” on page 97).

NOTE If the captured data is not uploaded from trace memory after the trigger event has occurred (for example, if the testcard has been run in stand-alone mode), click the Reload button  to upload the current capture.

Using the Waveform Lister

The waveform lister displays the state of each signal (0 or 1) and the bus conditions (addresses and data on address/data lines, byte enables, and commands on the C/BE lines) at each clock cycle of the capture.

To call the waveform lister:

- 1 In the main window, click the Waveform Viewer button .

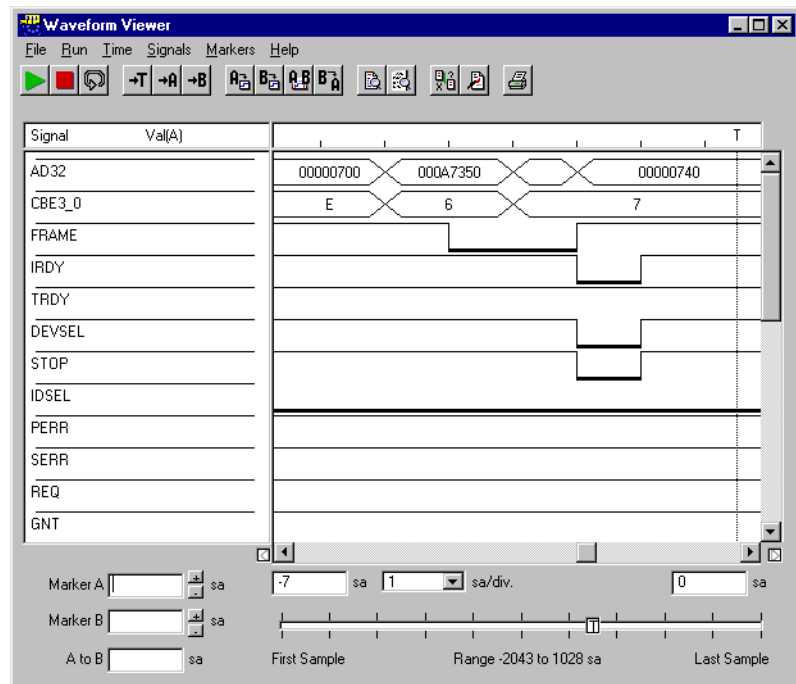

The waveform lister supports you in analyzing the captured data by allowing you to

- restrict the display to show only the signals and bus states relevant for your test (see *“How to Arrange the Signal Display”* on page 91),
- improve the view by specifying the range and resolution of the displayed clock cycles (see *“Adjusting Range and Resolution”* on page 92),
- set markers, for example, to toggle between two locations within the sample in order to compare them (see *“Using the Markers”* on page 92).

To analyze the captured data at the different abstraction levels at the same time, you can synchronize the currently displayed listers (see *“How to Synchronize the Listers”* on page 94).

How to Arrange the Signal Display

To optimize the signal display in the waveform lister to show only signals relevant for your test, you can exclude all irrelevant signals and arrange the order in which the signals are displayed. Proceed as follows:

- 1 From the *Signals* menu of the waveform lister, select *Arrange*.

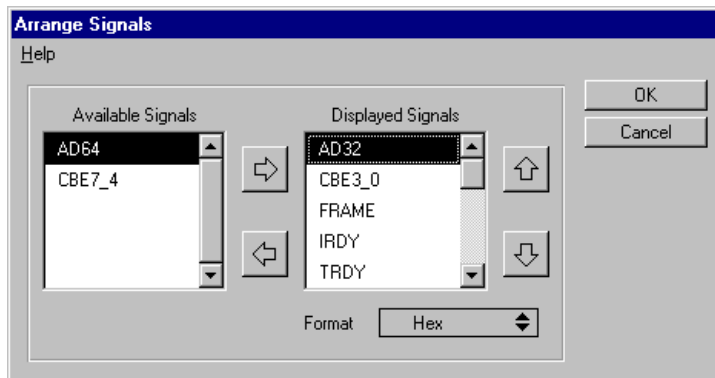

- 2 Click on the horizontal arrow buttons to exclude or include signals (the signals shown in the left area will not be displayed in the lister).
- 3 Click on the vertical arrow buttons to move up and down the signals to arrange them as they should appear in the lister.
- 4 For the address/data and byte enable signals, determine whether they are displayed in decimal or hexadecimal format.
- 5 Click *OK*.



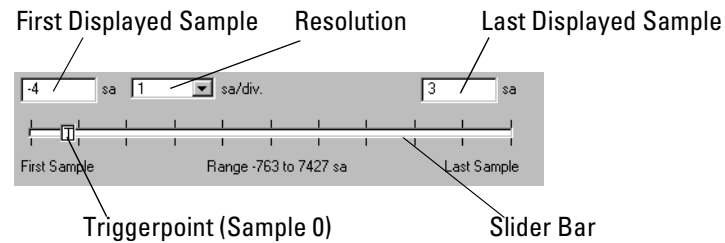

NOTE Using the *Signals* menu of the waveform lister, you can also adjust the height of the displayed signals.

Adjusting Range and Resolution

Below the signal display the waveform lister provides information on the currently selected view: first and last displayed sample and zoom factor (resolution). The slider bar represents the complete capture and shows the location of the triggerpoint and of the markers (if set). The samples are always numbered so that the triggerpoint is located at sample 0.



The waveform lister provides full flexibility to adjust the view to your needs:

- To enlarge the display, resize the Waveform Viewer window.
- Scroll horizontally so that the area you wish to focus on is in the center of the view.
- Click the Goto Trigger button  to move the view to the triggerpoint.
- Click the Goto Marker A and B buttons  to move the view to the respective marker.
- Click the Zoom buttons  to zoom in or out.
- The resolution tells the number of samples between two division marks (top row of diagram).
- Click the Redraw button  to refresh the display.

Using the Markers

The waveform lister provides two markers A and B. With these markers you can

- mark two particular samples of your interest
- set the visible range in the lister's display
- set a begin and end marker when using the cross reference function.

The following buttons allow you to control the markers:

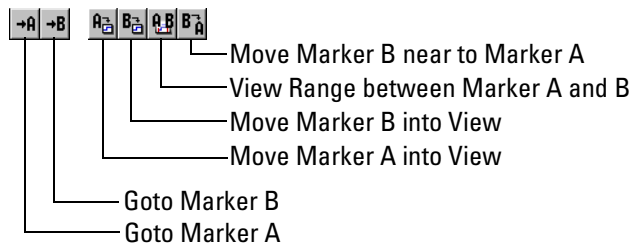

Placing the Markers To place the markers, proceed as follows:

- 1 Scroll horizontally so that the location where to place marker A is in the center of the view.
- 2 Click the Move Marker A into View button.
Marker A is set in the center of the lister's display.
- 3 Repeat these steps for marker B.

Moving the Markers To move the markers, you can

- use the sliders A and B on the slider bar
- drag and drop the marker symbols in the header of the lister's display
- enter values in the *Marker A*, *Marker B*, or *A to B* text fields
- click on the *Move Marker B near to Marker A* button

Using the Markers When you have finished placing the markers A and B, you can

- move the view to A or B by clicking the Goto Marker A or Goto Marker B button
- set the visible range between A and B by clicking the View Range between Marker A and B button.

The markers A and B of the waveform lister are also used by the cross-reference function (see “*How to Synchronize the Listers*” on page 94).

How to Synchronize the Listers

The displays of all three listers—waveform lister, bus cycle lister, and transaction lister—can be synchronized by means of the *cross-reference* function. This function is available in any lister. It allows you to view the same samples in all open listers for examination on different abstraction levels.

To synchronize the listers:

- 1 Open the desired listers.
- 2 If no capture is loaded, upload the trace memory (after an Analyzer run) or load a file.
- 3 In one of the listers, select the range to be viewed:
 - in the **transaction lister** and **bus cycle lister**: keep the left mouse button pressed while moving the mouse cursor over the samples
 - in the **waveform lister**: set marker A and B. The samples between them are considered as “selected”.
- 4 Click the Cross Reference button  to synchronize all open listers.

Using the Bus Cycle Lister

The bus cycle lister derives and displays information on the type of each bus cycle, for example:

- If it is an address cycle: which is the transferred address and which command is in use?
- If it is a cycle of a data phase within a burst: what is the data and which byte enable signals are set?
- Is it a wait cycle?
- Is it an idle cycle?

The lister provides a search feature allowing you to search for errors and strings in the list and an export feature to store the textual list or parts of it as a text file.

To call the bus cycle lister:

- 1 In the main window, click the Bus Cycle Lister button .

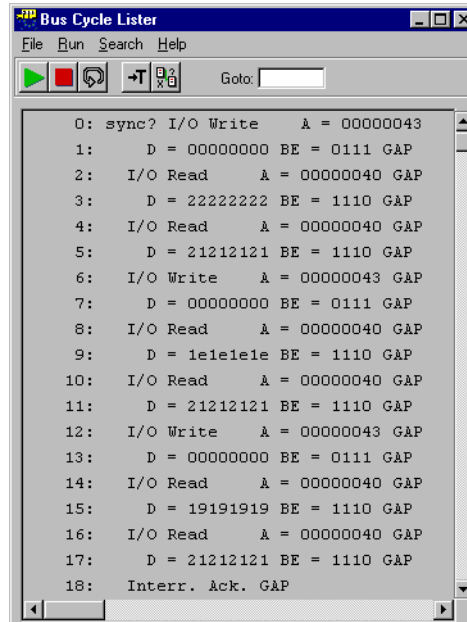

Each line in the list represents one bus cycle. For each cycle, its type (transaction, idle, etc.) and detected attributes are stated.

Browsing Through the Cycles

The bus cycle lister supports several methods of browsing through the cycles:

- You can move in the capture using the scroll bars.
- You can move to the triggerpoint by clicking the Goto Trigger button .
- You can move to a particular sample by entering a sample number in the *Goto* text field and pressing return.
- You can use the *Search* menu items to search for strings or errors.

Using the Transaction Lister

The transaction lister shows a list of the transactions found in the captured data. It summarizes the clocks of each transaction in one line and lists certain attributes or parameters that are detected during the transaction.

The lister provides a search feature allowing you to search for errors and strings in the list and an export feature to store the textual list as a text file.

To call the transaction lister:

- 1 In the main window, click the Transaction Lister button .

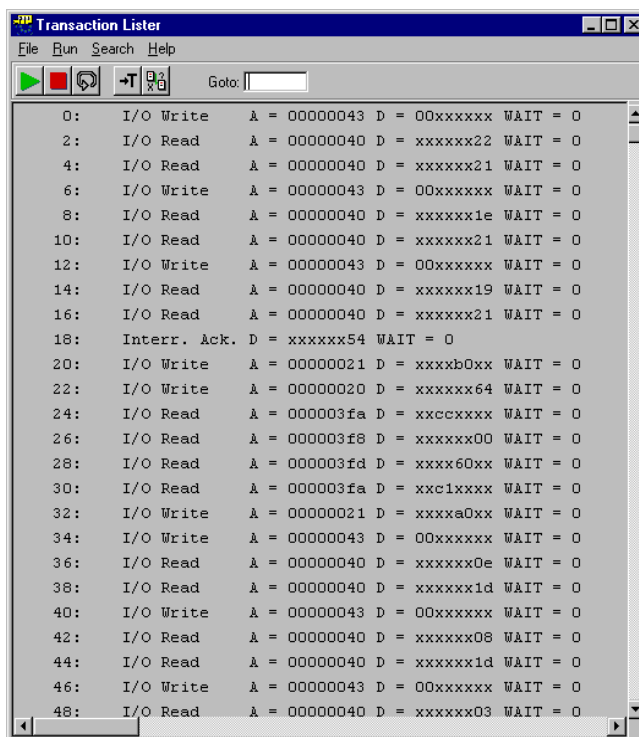

Each line in the list represents a complete transaction and states information about the transaction:

- start sample number
- bus command
- bus address
- data (if any)
- detected attributes



The transaction lister provides the same scrolling, moving, searching, and storing features as the bus cycle lister. Please refer to “*Browsing Through the Cycles*” on page 95.

Processing the Captured Data

Normally, the data captured in the trace memory is uploaded automatically after the trigger event has occurred so that you can view it directly in the listers. You can analyze the data, save them to disk and load them again for later analysis.

However, if the PCI Analyzer has been run in stand-alone mode or under control of a C program (without using the graphical user interface), you will have to upload the captured data.

The listers provide the following functions for processing the captured data:

- The Reload button  allows you to upload the current capture from the card's trace memory into the user interface software.
- The Print button  allows you to print the captured data as currently displayed by the respective lister.
- The *File* menu in each lister provides menu items to save the contents of the trace memory to a waveform file (.wfm) and to load data from a file.
- The *File* menu in the Bus Cycle Lister and in the Transaction Lister provides the *Export to File* item, allowing you to save the lists as a text file.
- The *File* menu in the Bus Cycle Lister provides the *Export selected Range* item, allowing you to save only the selected range of bus cycles as a text file.

Saving and Re-Using the Setups

The setups entered during a session can be saved to disk when exiting the program.

Because you might need different settings for different tests, you can also store the settings in separate test setup files.

When testing the power up behavior of your device or system under test, you can save your setups as power up defaults on the Agilent E2925B testcard.

Re-Using Test Setups

The test setup files (.bst) contain all information required to repeat a test later-on, for example,

- the trigger sequencer programming,
- the performance counter setup,
- the run options,
- the testcard configuration,
- and the setups for the PCI Exerciser's master and target devices if the PCI Exerciser option has been installed.

The functions for handling setup files can quickly be accessed via the icon buttons in the *File* section.

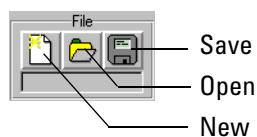

How to Overwrite the Power Up Defaults

If you wish to test the power up behavior of a device or system under test, you can save your test setups and additional properties as power up defaults on the Agilent E2925B testcard. These settings will then affect the testcard's behavior on restart.

To save the current setups as power up defaults:

- 1 From the *File* menu, select *Save as Power Up Defaults*.

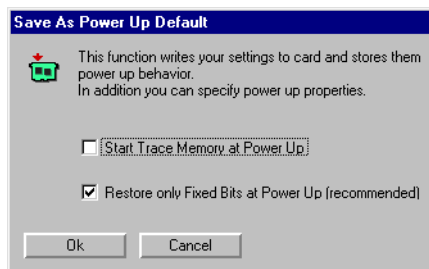

- 2 Select the additional power up properties as required. Possible choices are:

- *Start Trace Memory at Power Up*. This option will start the trace memory after a reset of the testcard is made. Here the PCI bus traffic can be recorded and evaluated. Protocol rule violations and timing errors can be used to trigger the trace memory.
- *Restore only Fixed Bits at Power Up (recommended)*. This option causes only the fixed bits in the configuration space header to be reset on restart. Fixed bits are the ones that BIOS has no access to. All other bits will be set by the BIOS in the configuration phase after a restart.

- 3 Click *OK*.

Upgrading the PCI Analyzer

If you have purchased software options for your PCI Analyzer, they need to be enabled after installation.

If you have added the PCI Exerciser option and/or the C-API/PPR option subsequently, the testcard hardware needs to be upgraded.

How to Install Software Options

To enable software options for the PCI Analyzer:

- 1 From the *Setup* menu, select *Testcard Configuration*.
- 2 From the *HW Config* menu, select *Register Product Options*.

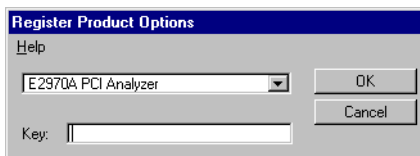

Repeat the following steps for each software add-on to be enabled:

- 1 Select the software option from the list.
- 2 Enter the license key printed on the software certificate in the *Key* text field.

3 Click *OK*.

The software options providing additional user interface features will become visible in the main window:

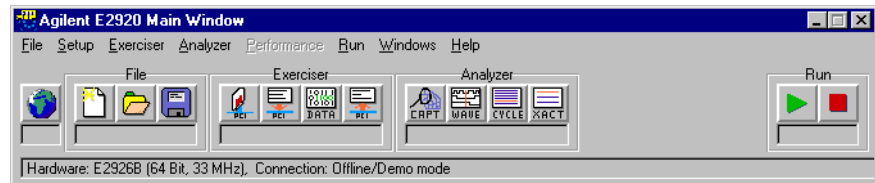

NOTE Store the software certificates in a safe place.

Upgrading the Testcard Hardware

If you have added the PCI Exerciser option and/or the C-API/PPR option subsequently, the testcard hardware needs to be upgraded.

For upgrading the testcard hardware, send the testcard to the address specified in the papers shipped with your testcard.

After upgrading the hardware you need to enable the new software options as described in *“How to Install Software Options”* on page 101.

Updating the Testcard

After a software update, a version conflict with the onboard firmware can occur. In this case, the hardware must be updated.

How to Check the Hardware

When connecting to the card and during program start, the hardware check is performed automatically. You can also start the hardware check on your own (for example, if you changed to another card without restarting the software):

- ◆ From the *Setup* menu, select *Check Hardware*.

A message shows whether or not a hardware update is required.

How to Update the Testcard Hardware

To perform the hardware update:

- 1 From the *Setup* menu, select *Update HW*.
- 2 In the *Port* section, select the control interface to be used and enter the required parameters for that control interface.
- 3 Click *OK*.

The flashing red/green indicator will show the progress of the update. A message will appear after the hardware update has been completed successfully.

- 4 From the *Setup* menu, select *Check Hardware* to verify that hardware and software are compatible now.

Analyzer Reference

This reference provides bus states, protocol rules, etc. and briefly defines the predefined performance measures.

List of Rules Observed by the PCI Analyzer

The following tables shortly describe all the rules that are observed by the PCI Analyzer's protocol observer. The rules are defined by the PCI specification, where you may find more details.

The provided links refer to PCI specification, Revision 2.1, June 1, 1995.

The rules are assorted as follows:

- *"FRAME# Usage Rules" on page 106*
- *"IRDY# Usage Rules" on page 106*
- *"DEVSEL# Usage Rules" on page 107*
- *"TRDY# Usage Rules" on page 107*
- *"STOP# Usage Rules" on page 108*
- *"LOCK# Usage Rules" on page 108*
- *"64-Bit Handling Rules" on page 108*
- *"Arbitration Handling Rules" on page 109*
- *"Parity and Parity Error Handling Rules" on page 109*
- *"Cache Handling Rules" on page 110*
- *"Semantic Rules" on page 110*
- *"Latency Rules" on page 111*

Table 5 FRAME# Usage Rules

Abbrev.	Description	PCI Specification Section
FRAME_0	Whenever STOP# is asserted, the master must deassert FRAME# as soon as IRDY# can be asserted.	Appendix C, Rule 12 e
FRAME_1	Fast Back-To-Back is only allowed after a write transaction or a master abort.	3.4.2. Fast Back-to-Back Transaction

Table 6 IRDY# Usage Rules

Abbrev.	Description	PCI Specification Section
IRDY_0	IRDY# must not be asserted on the same clock edge that FRAME# is asserted, but one or more clocks later.	3.3.1. Read Transaction (see timing diagram)
IRDY_1	FRAME# cannot be deasserted unless IRDY# is asserted. IRDY# must always be asserted on the first clock edge that FRAME# is deasserted.	Appendix C, Rule 8 c
IRDY_2	IRDY# must be deasserted after last transfer or when FRAME# is high and STOP was asserted.	3.3.3.1. and 3.3.3.2.1, Rule 1
IRDY_3	A transaction starts when FRAME# is sampled asserted for the first time—IRDY# must not go low when FRAME# is high.	Appendix C, Rule 7
IRDY_4	Once a master has asserted IRDY#, it cannot change IRDY# or FRAME# until the current data phase is completed. Especially when FRAME# has been deasserted, it cannot be reasserted during the same transaction.	Appendix C, Rules 8 b and 8 d
IRDY_5	IRDY# must not be asserted during the second address phase of a Dual Address Cycle.	3.10.1 64-bit Addressing

Table 7 DEVSEL# Usage Rules

Abbrev.	Description	PCI Specification Section
DEVSEL_0	DEVSEL# must not be asserted during a special cycle or if a reserved command has been used.	3.7.2. Special Cycle
DEVSEL_1	DEVSEL# must not be asserted when FRAME# is high or was sampled high on last clock edge (for DAC, DEVSEL# must be delayed by one cycle).	3.1.1. Command Definition
DEVSEL_2	Once DEVSEL# has been asserted, it cannot be deasserted until the last data phase has completed, except to signal target abort.	3.3.1. Read Transaction (timing diagram)
DEVSEL_3	If not already deasserted, TRDY#, STOP# and DEVSEL# must be deasserted with the clock following the completion of the last data phase and must be tri-stated at the next clock.	Appendix C, Rule 15
		Appendix C, Rule 12 f

Table 8 TRDY# Usage Rules

Abbrev.	Description	PCI Specification Section
TRDY_0	DEVSEL# must be asserted with or prior to the edge at which the target enables its outputs. (TRDY#).	Appendix C, Rule 14
TRDY_1	TRDY# must not go low at the first clock after assertion of FRAME# in a read transaction (a turnaround cycle is necessary).	3.3.1. Read Transaction (timing diagram)
TRDY_2	Once a target has asserted TRDY#, it cannot change DEVSEL#, TRDY#, STOP# until the current data phase completes.	Appendix C, Rule 12 d

Table 9 STOP# Usage Rules

Abbrev.	Description	PCI Specification Section
STOP_0	DEVSEL# must be asserted with or prior to the edge at which the target enables its outputs (STOP#).	Appendix C, Rule 14
STOP_1	Once asserted, STOP# must remain asserted until FRAME# is deasserted; whereupon, STOP# must be deasserted.	Appendix C, Rule 12 c
STOP_2	Once a target has asserted STOP#, it cannot change DEVSEL#, TRDY#, STOP# until the current data phase is completed.	Appendix C, Rule 12 d

Table 10 LOCK# Usage Rules

Abbrev.	Description	PCI Specification Section
LOCK_0	LOCK# must be asserted at the clock following the (first) address phase and kept asserted to maintain control.	Appendix C, Rule 32 e
LOCK_1	The first transaction of a locked access must be a READ.	Appendix C, Rule 32 d
LOCK_2	LOCK# must be released if RETRY is signaled before a data phase has completed and lock has not been established, or whenever an access is terminated by target abort or master abort.	Appendix C, Rules 32 f and 32 g

Table 11 64-Bit Handling Rules

Abbrev.	Description	PCI Specification Section
W64_0	REQ64# mirrors FRAME# in a 64-bit transaction. REQ64# may only be asserted when FRAME# is asserted. Once asserted, it must stay low as long as FRAME#.	3.10. 64-Bit Bus Extension
W64_1	ACK64# mirrors DEVSEL# in a 64-bit transaction. ACK64# may only be asserted when DEVSEL# is asserted. Once asserted, it must stay low as long as DEVSEL#.	3.10. 64-Bit Bus Extension

Table 11 64-Bit Handling Rules

Abbrev.	Description	PCI Specification Section
W64_2	REQ64# must not be used with special cycle or interrupt acknowledge command. Only memory commands support 64-bit data transfers (no config commands, no I/O commands).	3.10. 64-Bit Bus Extension
W64_3	ACK64# may only be asserted, when REQ64# was asserted before (ACK64 is a response to REQ64#).	3.10. 64-Bit Bus Extension

Table 12 Arbitration Handling Rules

Abbrev.	Description	PCI Specification Section
ARB_0	When the current transaction is terminated by the target either by Retry or Disconnect, the master must deassert its REQ# signal for a minimum of two clocks.	Appendix C, Rule 10
ARB_1	One GNT# can be deasserted coincidentally with another GNT# being asserted only if the bus is not in idle state.	Appendix C, Rule 23 b
ARB_2	Only one GNT# must be asserted on any rising clock.	3.4. Arbitration

Table 13 Parity and Parity Error Handling Rules

Abbrev.	Description	PCI Specification Section
PARITY_0	PERR# may never be asserted two clocks after the address phase (or earlier in a transaction) or during a special cycle. During WRITE, PERR# may be asserted two clocks after IRDY#, during READ, PERR# may be asserted two clocks after TRDY#.	3.8.2. Error Reporting
PARITY_1	AD[31:0] address parity error.	Appendix C, Rule 37 b
PARITY_4	AD[63:32] address parity error.	Appendix C, Rule 37 c
PARITY_2	AD [31:0] data parity error occurred but was not signaled.	Appendix C, Rule 37 b

Table 13 Parity and Parity Error Handling Rules

Abbrev.	Description	PCI Specification Section
PARITY_5	AD[63::32] data parity error occurred but was not signaled.	Appendix C, Rule 37 c
PARITY_3	AD[31::0] data parity error occurred.	Appendix C, Rule 37 b
PARITY_6	AD[63::32] data parity error occurred.	Appendix C, Rule 37 c

Table 14 Cache Handling Rules

Abbrev.	Description	PCI Specification Section
CACHE_0	After HITM, CLEAN must be signaled before STANDBY.	3.9.2 Cache State Transitions
CACHE_1	HITM must only be signaled after STANDBY.	3.9.2 Cache State Transitions

Table 15 Semantic Rules

Abbrev.	Description	PCI Specification Section
SEM_0	A master can terminate a transaction with master abort but not until 4 clocks after an entire address phase.	3.3.3.1. Master Initiated Termination
SEM_1	Only certain combinations of AD[1:0] and C/BE#[3:0] are allowed during I/O transfers.	3.10.1. 64-bit Addressing on PCI
SEM_2	A master that supports 64-bit addressing must generate a SAC instead of a DAC, when the upper 32 bits of the address are zero.	3.2.2. Addressing
SEM_3	Reserved commands are reserved for future use.	3.10.1. 64-bit addressing on PCI
SEM_4	DAC is not allowed immediately after a DAC.	3.1.1. Command Definition
SEM_5	A master must keep the byte enables stable during the complete data phase.	3.10.1. 64-bit Addressing on PCI
SEM_6	An INTx signal has been asserted and deasserted before an Interrupt Acknowledge cycle has occurred.	Appendix C, Rule 3 b
		3.7.5 Interrupt Acknowledge

Table 15 Semantic Rules

Abbrev.	Description	PCI Specification Section
SEM_7	Targets must signal disconnect with or after completion of the first data phase, when a reserved burst mode is used during memory command transactions.	3.2.2 Addressing
SEM_8 (default = off)	A delayed transaction (retries) has not been repeated within 2^{14} clocks.	Agilent Rule to detect potential deadlocks.
SEM_9 (default = off)	A delayed transaction has not terminated within 2^{15} clocks.	Agilent Rule to detect potential deadlocks.
SEM_10	During a Dual Address Cycle, a 64-bit master has to drive the high address on AD[63:32] in the initial and in the second address phase.	3.10.1 64-bit Addressing on PCI
SEM_11	During a Dual Address Cycle, a 64-bit master has to drive the bus command on C/BE[7:4]# in the initial and the second address phase.	3.10.1 64-bit Addressing on PCI
SEM_12	The Memory Write and Invalidate command can only use the linear incrementing burst mode.	Part 2.1, 3.2.2 Addressing
SEM_13	When using the Memory write and invalidate command, the transaction must begin at the start of a cacheline.	Part 2.1, 3.2.2 Addressing

Table 16 Latency Rules

Abbrev.	Description	PCI Specification Section
LAT_0	Targets are required to complete the initial data phase of a transaction within 16 clocks, subsequent data phases within 8 clocks.	Appendix C, Rules 25 and 26
LAT_1	A master must complete all cycles within 8 clocks.	Appendix C, Rules 27

Sample Timing Diagrams

The following figures show examples of some events on the PCI bus, and which states are detected by the PCI Analyzer in the various phases of the event.

In the figures, the following abbreviations are used to identify the signals:

Table 17 Abbreviations used in Sample Timing Diagrams

Signal	Abbreviation	Meaning
b_state[]	i	Idle
	A	Single address cycle
	A1	First of a dual address cycle
	A2	Second of a dual address cycle
	d	Decoding
	w	Wait
burst[]	T	Transfer
	S	Single phase
	F	First data phase of the burst
	M	Data phase within the burst
	L	Last data phase of the burst
term[]	-	Invalid
	n	No termination in this phase
	MA	Master abort
	C	Master completion
	A	Target disconnectA
	B	Target disconnectB
	1	Target disconnect1
	2	Target disconnect2
TA	Target abort.	

Figure 1 Master Completion of Single Transfer and Burst

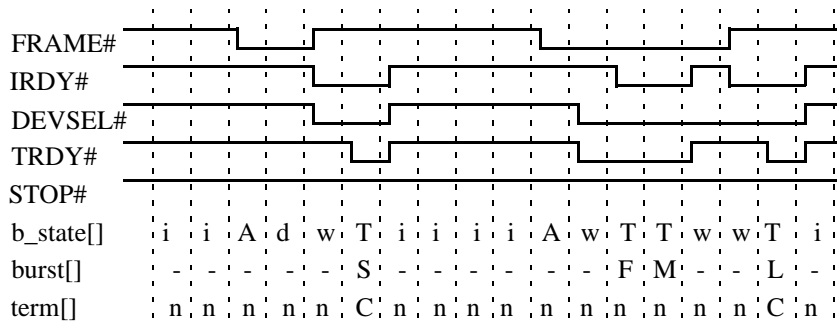

Figure 2 Master Completion with STOP# asserted

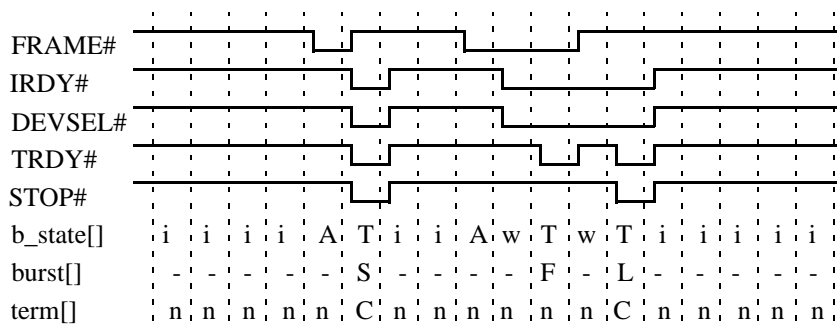

Figure 3 Target Disconnect A (with data transfer)

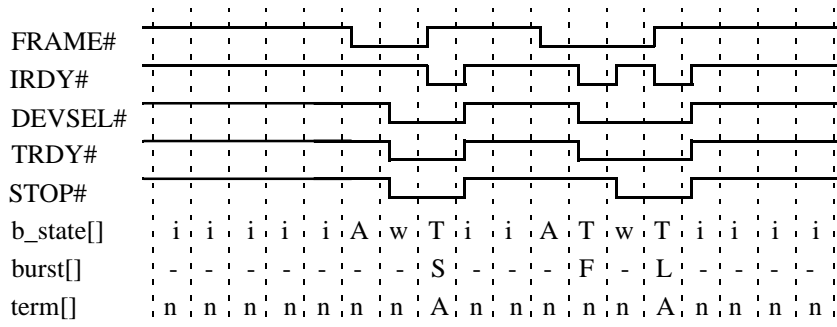
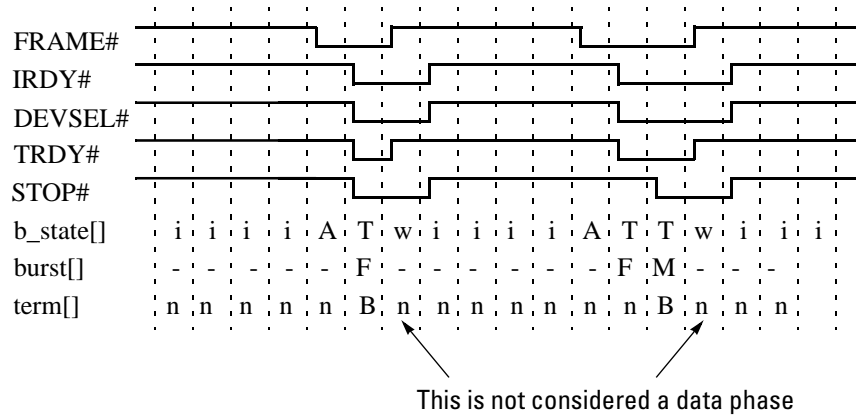

Figure 4 Target Disconnect B (with data transfer)



Note that the last cycle of a disconnect B is not considered as a meaningful data phase, although IRDY# and STOP# are low, because this is just a MUST signal toggling due to burst termination protocol rules.

Figure 5 Target Retry 1 and 2 (without data transfer)

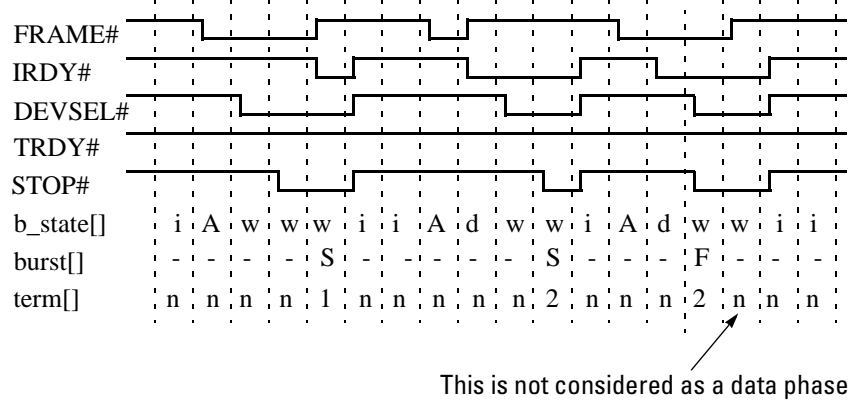
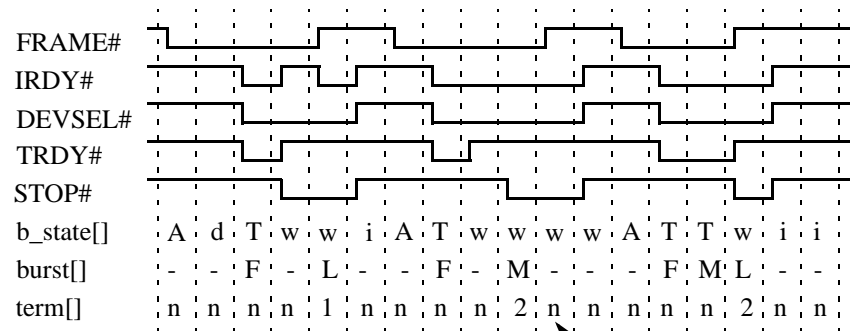

Figure 6 Target Disconnect 1 and 2 (without data transfer)

This is not considered as a data phase

Application Interfaces

The application interfaces can be used to exchange data between the Agilent E2925B testcard and external devices.

The testcard provides the following application interfaces:

- Static I/O Port
- Trigger I/O Connector
- LEDs on the Testcard

Static I/O Port

The static I/O port can transfer data (for example, status information) between the testcard and the test environment during execution of a test. The static I/O port features the following:

- 8 data lines
- 3.3V CMOS outputs driven by 74LVT (can also drive 5V TTL inputs)
- 3.3V CMOS inputs connected to 74LVT (can also understand 5V TTL outputs)

The outputs of the static I/O port can withstand a short.

Static I/O Port Connector and Pin Configuration

The following figure shows the connector and pin configuration:

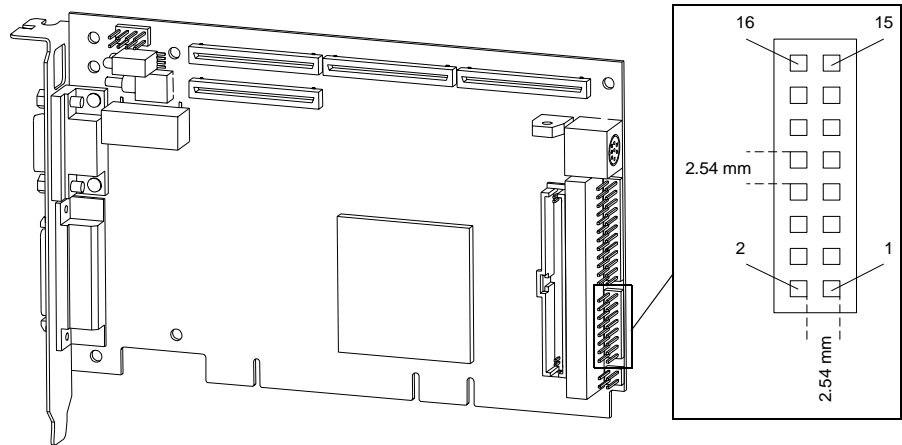
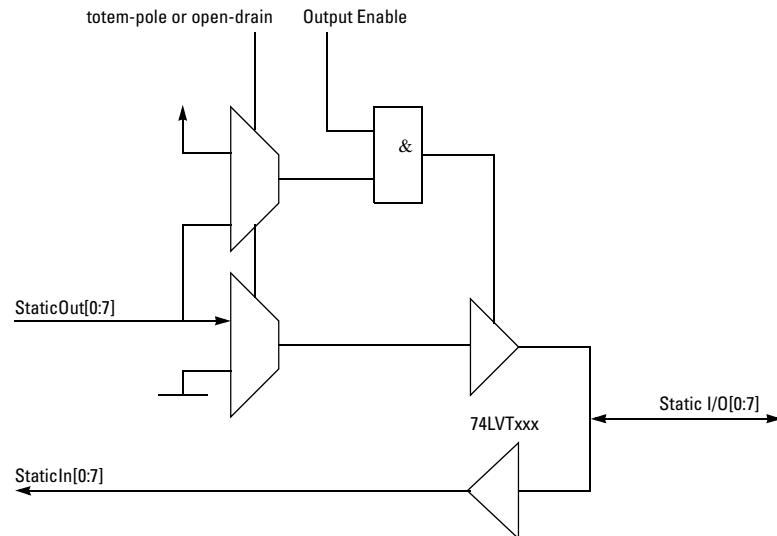

Table 18 Static I/O Port Pin Configuration

Pin	Signal	Pin	Signal
1	Static[0]	2	GND
3	Static[1]	4	GND
5	Static[2]	6	GND
7	Static[3]	8	GND
9	Static[4]	10	GND
11	Static[5]	12	GND
13	Static[6]	14	GND
15	Static[7]	16	GND

Static I/O Port Block Diagram

The following figure shows the block diagram of the static I/O port:



Trigger I/O Connector

The Agilent E2925B testcard provides a connector with 12 external trigger lines (trigger port). The trigger lines can be used to synchronize the card and other parts of the test environment on the basis of the PCI clock, for example:

- observing and influencing the REQ# and GNT# lines of other devices:
 - generate REQ# for other devices
 - observe the GNT# of other devices
 - sweep other REQ# with respect to own transactions
- generating and observing signals within or outside the system under test
- cross triggering between PCI test cards
- triggering oscilloscope or logic analyzer
- triggering functions of the testcard by means of a logic analyzer

The trigger port features the following:

- 3.3V CMOS outputs driven by 74LVT (can also drive 5V TTL inputs)
- 3.3V CMOS inputs connected to 74LVT (can also understand 5V TTL outputs)

The outputs of the trigger port can withstand a short and are disabled after power up or board reset.

NOTE PCI reset RST# has no effect on the trigger port.

Trigger Port Connector and Pin Configuration

The following figure shows the connector and pin configuration:

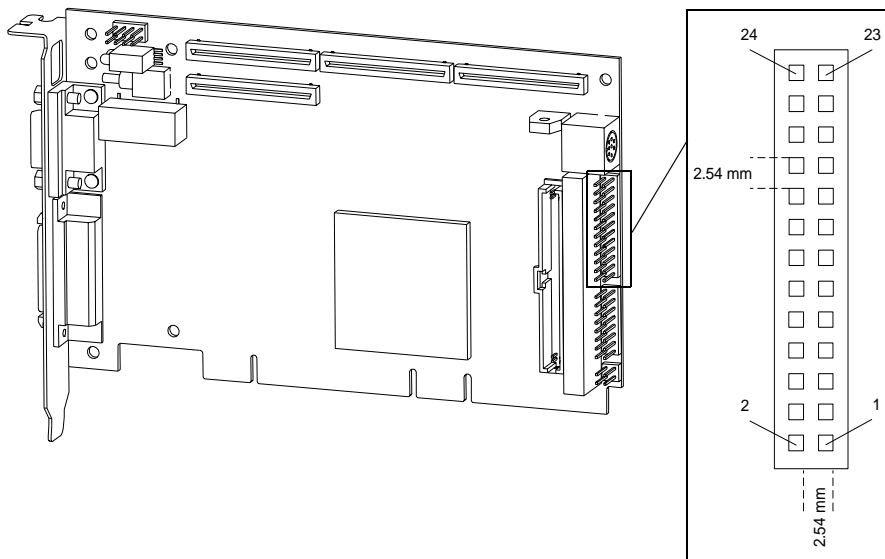
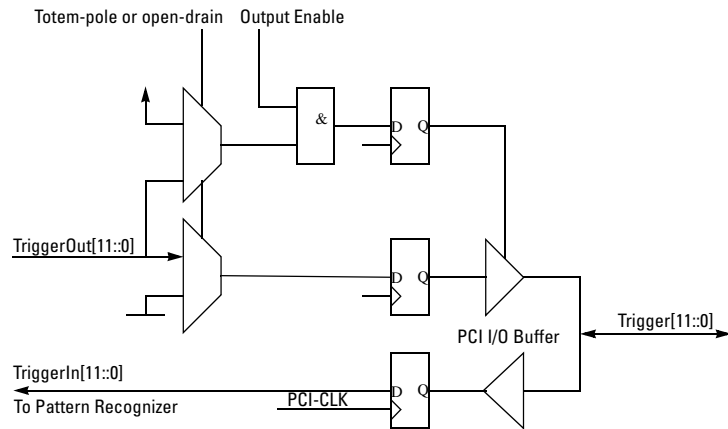

Table 19 Trigger I/O Pin Configuration

Pin	Signal	Pin	Signal	Pin	Signal	Pin	Signal
1	Trigger[0]	2	GND	3	Trigger[1]	4	GND
5	Trigger[2]	6	GND	7	Trigger[3]	8	GND
9	Trigger[4]	10	GND	11	Trigger[5]	12	GND
13	Trigger[6]	14	GND	15	Trigger[7]	16	GND
17	Trigger[8]	18	GND	19	Trigger[9]	20	GND
21	Trigger[10]	22	GND	23	Trigger[11]	24	GND

Trigger Port Block Diagram

The figure below shows the block diagram of the trigger port.



LEDs on the Testcard

The LEDs on the Agilent E2925B testcard show the card's status and are visible even if the card is plugged into a closed system.

The following figure shows the position of the LEDs on the card:

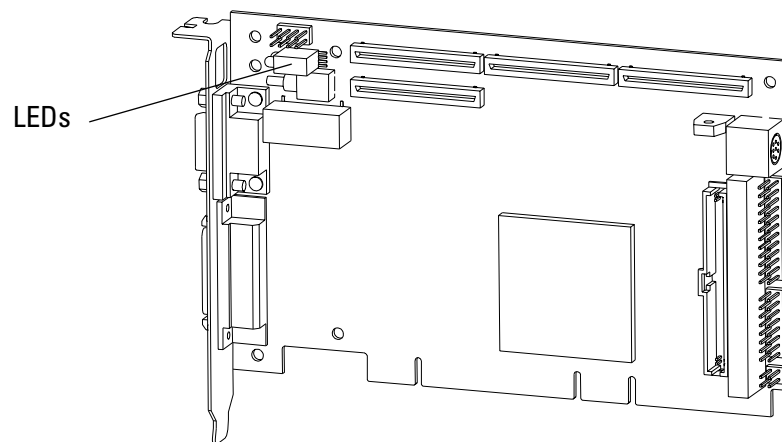

The following table shows the meaning of the LEDs:

Table 20 Meaning of the LEDs

LED	State	Information
Exception LED (red)	off	No violation, no test failed.
	on	Protocol violation found.
	slowly flashing (1 Hz)	Test failed.
Run Indicator LED (green)	off	No power.
	on	Power good.
	slowly flashing (1 Hz)	Master/test running.
	fast flashing (3 Hz)	Trace memory triggered.

If the red LED and the green LED are alternately flashing with 3 Hz, a **fatal error** has occurred. Both LEDs also flash after use of the Ping button in the Testcard Configuration dialog box (simultaneously, 1 Hz).

Glossary

This glossary contains terms used to describe and explain the functions and capabilities of the testcard—not only the PCI Exerciser. It contains a short explanation of each term, and in many cases, a reference to more information.

If you do not find a term in this glossary, look up the term in the index of this manual, or in the glossary of the PCI Specification.

A Alignment

Alignment occurs in multiple contexts:

- **Sample alignment in the trace memory**

The samples in the trace memory are aligned to ensure that information that occurred simultaneously (that is: in the same PCI clock) is aligned timewise. For example, command and address are latched, and aligned to data.

- **PCI bus address alignment**

When transferring data via the PCI bus, the address alignment must often meet certain requirements for certain transfers. For example, when using cacheable resources, data must be aligned to cache line size.

When accessing the testcard's data memory via the PCI bus for fast transfers, the internal address and the PCI bus address are to be aligned equally.

Application Interface

The application interfaces are used by applications (external software or hardware) for exchanging information with the testcard.

Attribute

See Protocol Attribute.

B Block Transfer

See Master Block Transfer.

C Clock Cycle

A PCI clock cycle is the smallest granularity in the PCI protocol.

Control Interfaces

These are the card's interfaces for transferring control data and test results between the software and the testcard. The card can be controlled via the parallel port (using the Fast Host Interface card), RS-232, or by programming registers from PCI, which can be mapped into user configuration space or into another PCI address space.

See *"Connecting to the Testcard"* on page 43.

Control PC

This PC runs the software controlling the testcard.

D Data Memory

See Memory.

Data Transfer

See Transfer.

Decoder

The decoders of the testcard determine whether or not the card's target should claim a transaction on the bus. The decoders recognize programmed address ranges, translate them into an internal address range of an internal resource (such as data memory) and call the card's target unit to process the transaction.

E Exerciser

The PCI Exerciser functions enable the testcard to emulate a PCI master or target:

- As a **master**, it initiates data transfers on the PCI bus, allowing it to test target devices by exposing them to the master's attempts to transfer data to or from them.
- As a **target** device, it reacts to a master's attempts to transfer data to or from it.

H Host

Same as Control PC.

I Interrupt

The PCI bus provides dedicated PCI interrupt lines. The testcard both recognizes and issues PCI interrupts.

M Master Block Transfer

A master block transfer specifies a master operation for the testcard's Exerciser. The Exerciser needs the following information to execute a master operation:

- bus command
- bus address
- internal address
- some optional data, such as block length, and references to an attribute page or to a series of byte enables

A block transfer may need one or more transactions to complete, depending on the specified master and target attributes, for example, disconnect or retry.

The block transfer settings are stored in the master block transfer memory, which contains a linear series of block transfers for the master.

Memory

The testcard provides different types of memory:

- **Data Memory**

The data memory holds received test data, and data to be transferred by the testcard. It is shared between the PCI master and target, and it can be setup or read out with host access functions. It also provides a data compare unit to compare incoming data with previously stored reference data.

- **Trace Memory**

The trace memory is part of the testcard's Analyzer. It stores all PCI signals along with extensive bus state and Exerciser state information. All this information is aligned to each other.

See *"Data Stored In The Trace Memory"* on page 72.

Furthermore, the card provides memory to store test setups, programming parameters, etc. (for example, attribute memories and block transfer memory).

P Pattern Term

The pattern terms are programmable for recognizing bus events (signal patterns on the bus). They are part of the testcard's Analyzer. They can, for example, detect an access using the Memory Write & Invalidate command with a Disconnect.

The output of pattern terms (always 1 or 0) can be used in Analyzer functions, for example, to trigger trace memory or to count bus events.

PCI Analyzer

The testcard's Analyzer queries for information on the PCI bus, the state of the Exerciser, or the external trigger inputs, so that it can check timing and protocol rules, capture traffic and measure performance.

PCI Status

The testcard queries the status of the PCI bus and provides registers to request information about the life status, reset, clock frequency, bus activity, the involvement of the card's Exerciser, and error states.

Performance Measure

The performance measures are circuits consisting of sequencer-controlled counters. They count different bus events and calculate specified ratios. For example, *busy cycles* of transfers can be counted and divided by *all cycles* thereby calculating the bus utilization.

See "*Predefined Performance Measures*" on page 60.

Protocol Attribute

The PCI transfers performed by the testcard can be equipped with protocol attributes, for example, parity errors. This allows you to see whether the system under test can handle these attributes. How the attributes are to be applied is stored in the attribute memories of the testcard.

The attributes are programmed per intended data transfer or per data phase. There are address phase attributes and data phase attributes. Whenever a new transaction must be started to complete the intended master block transfer, an address phase is generated with the command and address of the block transfer, and with the (address phase) attributes of the next pending data transfer.

The attribute memories contain a series of attributes for the address phases and data phases of the card's master and target. The attributes are used sequentially, and can be programmed to contain random protocol variations (only with C-API/PPR option).

S Sequencer

The sequencers of the testcard recognize sequences of patterns on the PCI bus. They are used by the testcard's Analyzer.

A sequencer can be programmed to change between internal states with the occurrence of certain patterns. On each state change it can issue certain output signals. To recognize these patterns, pattern terms are used.

Storage Qualifier

Storage qualifiers are used by the Analyzer when storing samples in the trace memory. The trace memory stores samples of bus states for post-processed analysis. To exclude unnecessary samples from being stored, the Analyzer provides storage qualifiers.

See *“Setting Up the Trigger Sequencer” on page 81.*

System under Test

The system under test is the PCI system into which the testcard is plugged.

T Transaction

A transaction consists of an address phase and a series of one or more data phases (burst).

Transfer

Data transfers are those clocks within a data phase in which data is actually transferred: when IRDY# and TRDY# are both asserted.

Trigger

The testcard provides different types of triggers:

- **Trace Memory Trigger**

The trace memory trigger is part of the Analyzer. The trace memory stores samples of bus states for post-processed analysis. To control the start of the sampling, the Analyzer provides the trace memory trigger.

See *“Setting Up the Data Capture” on page 75.*

- **External Trigger (Trigger Input and Output)**

The testcard provides input lines to be used as trigger input and output.

As input, they can be used in pattern terms just like PCI signals. The trigger I/O sequencer enables them to detect trigger pattern sequences.

As output they can be used to trigger other devices. Again, the trigger I/O sequencer allows you to build sequences.

Index

#

64-Bit Handling Rules 108

A

Advanced Performance Setup 66

Alignment 121

Arbitration Handling Rules 109

B

berr Signal 30

Bus Cycle Lister 94

 button 95

 window 31

Buttons 10

C

Cache Handling Rules 110

C-API / PPR 9

Capture

 Button 76

 Window 76

Captured Data, processing 97

Capturing Data, Setup 75

Checking the Hardware 103

Clock Cycle 122

Components

 of the PCI Analyzer 39

 of the Trace Memory 72

Configurations of the PCI Analyzer 39

Control Interfaces 43

Control PC Configurations 39

Counter Increment 65

Counter Sequencer 65

 Programming 68

Cross Reference (button) 94

D

Data Capture

 Processing 97

 Setup 75

 Uploading 73

Data Memory

 Definition 123

Data Recording 73

Debugging of Timing Violations 57

Decoder 122

"Details" signpost (help) 27

Detecting Signal Changes 86

DEVSEL# Usage Rules 107

Did not repeat in ... cycles (trigger setup) 76

E

Efficiency 60

Examples. See Guided Tours

Exception and Run Indicator LEDs 14

F

Fast Host Interface 43

Feedback Counter 82

Format (hex/decimal) in Waveform Lister 91

FRAME# Usage Rules 106

G

Goto Trigger (button) 24

Guided Tours

 Analyzing PCI Traffic to a Graphics
 Controller 20

 PCI Performance Analysis 36

 Using the State Sequencer 33

H

Hardware Check 103

Hardware Update 103

Hold Time 51

Host 122

"How to" signpost (help) 27

I

Incrementing the Counters 65

Installation of Software Options 101

Interfaces

 Control Interfaces 43

 Hardware 14

 User Interface 10

Interrupt 123

IRDY# Usage Rules 106

L

Latency Rules 111

LEDs 119

 Exception and Run Indicators 14

Listers

 Bus Cycle 94

 Transaction 96

 Types 89

 Waveform 90

LOCK# Usage Rules 108

M

m_act 80

Markers

 Waveform Lister 92

Master Block Transfer 123

Memory 123

Menus 10

Modifications of the Timing Limits 55

Momentary (tab) 62

O

Offline/Demo Mode (radio button) 19

Overview of the PCI Analyzer 7

Overview Windows 10

 Analyzer Overview 11

 Exerciser Overview 13

 Test Setup Overview 11

Overwriting the Power Up Defaults 100

P

Parallel Ports 14

Parity and Parity Error Handling Rules 109

Pattern Editor (window) 77

Pattern Term 86

PCI Analyzer 124

 Configurations 39

 List of Rules Observed 105

 Overview 7

 Status Bar 87

 Test Setup 39

PCI Analyzer, Components 39

PCI Clock Reference Counter 65

PCI Connector 15

PCI Exerciser 9

PCI Performance

 Running a Measurement 62

PCI Port 43

PCI Protocol Permutator and Randomizer
(PPR) 9

PCI Status 124

Performance Counter Sequencer
(window) 68

Performance Measures 124

 Predefined 60

Performance Optimizer 12

Performance Setup 66

- Ports
 - Parallel/Serial 14
 - Static I/O 15
 - Trigger 15
 - Post-Processed Analysis 36
 - Power Up Defaults, Overwriting 100
 - Preload Value 86
 - Programming the Counter Sequencer 68
 - Protocol Attribute 124
 - Protocol Check (window) 48
 - Protocol Errors 29
 - Protocol Observer
 - Reset 50
 - Setup 48
 - Uploading of Results 49
 - Watching Results 49
 - Protocol Violations 47
- R**
-
- Range 92
 - Real Time Counter Result (window) 62
 - Real Time Counter Setup (window) 61
 - Real-Time Analysis 36
 - Recording Data 73
 - Reference Counter 65
 - Register Product Options (window) 101
 - Relative Values (ratio) 67
 - Reset
 - Protocol Observer 50
 - Timing Checker 56
 - Resolution 92
 - Restart (button) 14
 - Retry Rate 60
 - RS-232 Port 43
 - Rules
 - 64-Bit Handling 108
 - Arbitration Handling 109
 - Cache Handling 110
 - DEVSEL# Usage 107
 - FRAME# Usage 106
 - IRDY# Usage 106
 - Latency 111
 - LOCK# Usage 108
 - Parity and Parity Error Handling 109
 - Semantic 110
 - STOP# Usage 108
 - TRDY# Usage 107
 - Run (button) 87
- S**
-
- Scan Ports (button) 44
 - Selected Transactions/States (Storage Qualifier Setup) 79
 - Selecting
 - Connection 44
 - Predefined Performance Measures 61
 - Selection List (dialog box) 78
 - Semantic Rules 110
 - Sequencer
 - Description Table 82
 - Internal 82
 - Mode 74
 - Mode (State Sequencer) 33
 - Serial Ports 14
 - Setup 81
 - of the Protocol Observer 48
 - of the Sample Sequencer 83
 - of the Storage Qualifier 79
 - of the Timing Checker 54
 - of the Trigger 76
 - of the Trigger Sequencer 81
 - Setup Time 51
 - Signal Display 91
 - Signals
 - Changes 86
 - Software Options, Installation 101
 - Specifying
 - Transactions and States 80
 - Trigger Patterns 77
 - State Diagram 84
 - State Sequencer 33
 - States, Specifying 80
 - Static I/O
 - Port Block Diagram 117
 - Ports 15
 - Status Bar 87
 - Status group
 - Protocol Check 48
 - Timing Check 54
 - Stop (button) 88
 - STOP# Usage Rules 108
 - Stopping the Analyzer 88
 - Storage (tab) 79
 - Storage Qualifier Setup 79
 - Synchronizing the Listers 94
 - System Performance 37
 - System Validation Package 9
- T**
-
- t_act 80
 - Test Setup
 - Re-Use 99
 - Testcard 8
 - Concealed from the System 42
 - Control Interfaces 43
 - Hardware Interfaces 14
 - Hardware Update 103
 - Hardware Upgrade 102
 - LEDs 119
 - Software Connection 44
 - Testcard Configuration (window) 44
 - Throughput 60
 - Time History (tab) 63
 - Timing Check (window) 54
 - Timing Checker
 - Adaptation 53
 - Reset 56
 - Setup 54
 - Uploading Results 56
 - Timing Diagrams 112
 - Timing Limits, Modifications 55
 - Timing Parameter Values 53
 - Timing Rules 51
 - Timing Violations 51
 - Debugging 57
 - Trace Memory 123
 - Components 72
 - Stored Data 72
 - Trigger 125
 - Trigger Sequencer 82
 - Transaction Lister
 - Button 96
 - Window 96
 - Transactions, Specifying 80
 - Transfer 125
 - Transitional Pattern Term 86
 - Transitions 86
 - TRDY# Usage Rules 107
 - Trigger 125
 - I/O 57
 - Pattern Specification 77
 - Point 77
 - Ports 15
 - Setup 76
 - Trigger (tab) 20
 - Trigger Sequencer 81
 - Window 35
 - Troubleshooting 45
- U**
-
- Update Rate (performance measure) 62
 - Updating the Testcard Hardware 103
 - Uploading
 - Captured Data 73
 - Protocol Observer Results 49
 - Timing Checker Results 56
 - Utilization 60
- W**
-
- Waveform Lister 90
 - Waveform Viewer
 - Button 90
 - Window 24

X

xact_cmd 80

xact_rq64 81

Z

Zoom 92

Publication Number: 5988-5041EN

