



**EASY
TRAVEL™**

Elite

USER'S MANUAL

Table of contents:

	Page
1. Introduction	4
2. Safety	4
3. System Components	5
4. Assembly and Folding Instructions	7
5. Operating Your EasyTravel Elite	11
6. Moving and Transporting Your EasyTravel Elite	15
7. Helpful Hints for Everyday Use	16
8. General Maintenance and Inspection	17
9. EMI – Electromagnetic interference	19
10. Fault Finding	22
11. Disposal and Recycling	23
12. Technical Data	23

NOTE: Design details may change without notice.

1. INTRODUCTION

The **EasyTravel Elite** is a “Class A” Electrically powered scooter. It is intended to be used by individuals that are able to walk, but suffer from mild mobility limitations. The user must have sufficient arm and leg strength to get on and off the **EasyTravel Elite** alone and to safely steer under all driving conditions.

The **EasyTravel Elite** is intended for indoor and restricted outdoor use on pavements or paved footpaths only during daylight hours. The **EasyTravel Elite** does not have lights and reflectors and therefore must not be used in the dark or in limited visibility conditions.

CAUTION: Failure to follow the instructions contained in this manual may result in injury to the user or to other persons.

2. SAFETY

During your initial use of the **EasyTravel Elite** we recommend caution as you practice operating the unit in various situations. Keep the speed at a reduced level until you are comfortable controlling the scooter. Follow the safety tips and instructions and you will be comfortable manoeuvring through doorways, on and off lifts, over moderate terrain and up and down ramps.

These safety considerations and tips will help you to operate the **EasyTravel Elite** safely. The **EasyTravel Elite** is a powerful electric vehicle; these rules will help you prevent personal injury and damage to your scooter.

1. Read this manual and all labels before operating.
2. Do not carry passengers or exceed the maximum weight capacity.
3. Do not mount or dismount the **EasyTravel Elite** unless it has come to a full stop and is turned off.
4. Do not back up on to uneven inclines or surfaces.
5. Always switch the speed selector to low when driving in a confined space.
6. Always reduce speed when turning.

7. Do not operate your scooter when under the influence of alcohol, medications or drugs that may impair your safety.
8. Always keep your feet on the foot platform when driving.
9. Do not sit on the scooter while being transported in a moving vehicle. Always fold down and secure your **EasyTravel Elite** and transfer yourself to a vehicle seat.

3. SYSTEM COMPONENTS AND DETAILS

3.1. **EasyTravel Elite** parts – (Figure 1)

- | | |
|---------------------------------|---|
| 1. Battery pack (detachable) | 11. Rear wheel |
| 2. Front column (detachable) | 12. Folded frame lock/release pin |
| 3. Column lock/release triggers | 13. Unfolded frame lock/release pin |
| 4. Controller cover | 14. Utility basket (holding capacity 20lbs/9kg) |
| 5. Charging socket (Fig. 1A) | 15. Charger and connecting cables (Fig. 1B) |
| 6. Front drive wheel | 16. Control Panel |
| 7. Foot platform | 17. Freewheel switch |
| 8. Seat shell | |
| 9. Seat cushions | |
| 10. Foldable armrests | |

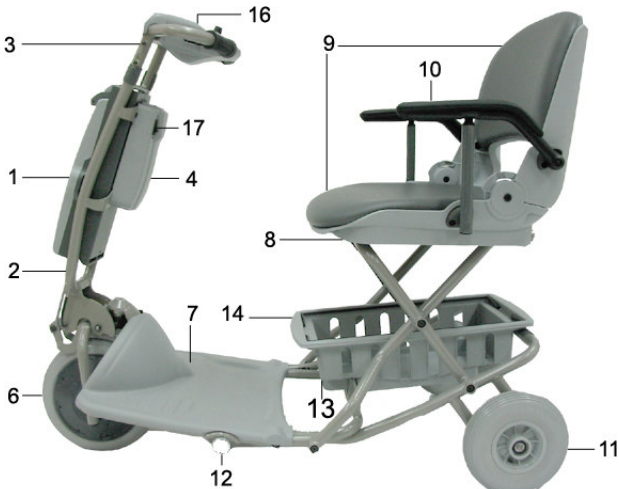

Figure 1

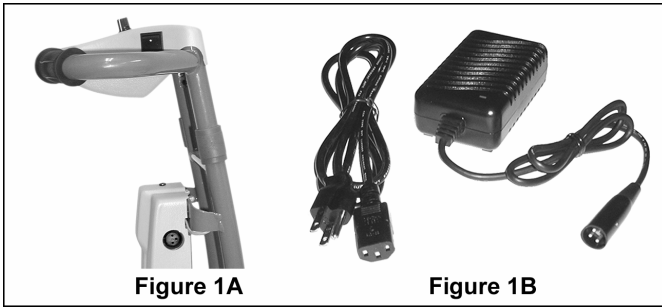

Figure 1A

Figure 1B

3.2. Control Panel – (Figure 2)

1. Switch
2. Hand control lever (right and left)
3. Speed adjusting knob
4. Indicator light (LED)
5. Battery Gauge
6. Hand-grips

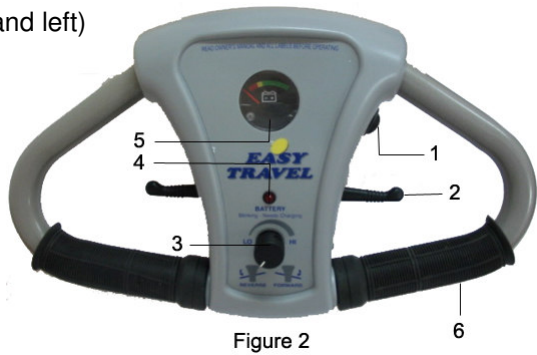

Figure 2

3.3. *EasyTravel Elite* Optional Accessories:

1. Extra battery pack

BELL: If the user requires an audible warning device, a standard bicycle bell can be attached to the handlebar.

4. ASSEMBLY AND FOLDING INSTRUCTIONS

4.1. Assembling your *EasyTravel Elite*.

Unfolding Rear Frame

Pull on the folded frame lock pin ring (Fig. 4/1) to release the foot platform and unfold the frame. Pull the seat backrest (Fig. 4/2) and lift it to the upright position. Ensure that the unfolded frame lock pin secures the platform in the horizontal position.

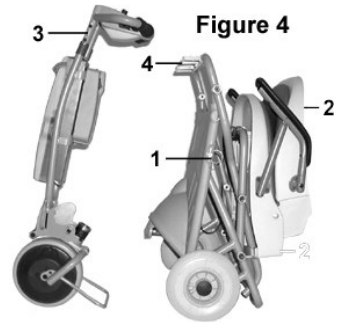

Unfolding Front Column

Pull the column lock triggers (Fig. 4/3) upward towards the handle to release the tilt lock. Move the drive unit away from the column (all the way) to open the quick-release housing.

This is the column “detach” position.

Connecting the Front Column to the Rear Frame

Position the column in the “detach” position. Lift the front of the Foot platform and insert connection pin into the quick-release housing on the drive unit. This may be done without bending down by lifting the front of the seat “lip” while holding the front column hand-grip as shown in Fig. 5.



Front Column Adjustment (Figure 6)

To adjust the angle of the front column, pull the column lock triggers upward. Move the column into the desired position and release. Push lightly back and forth on the column to ensure that it is locked in the desired position.

1. For driving the **EasyTravel Elite**, adjust column to one of the two the rear-most positions.
2. For getting in and out of the **EasyTravel Elite** seat comfortably, the column may be moved away from the seat to the entry/exit position.
3. For detaching the front column from the rear frame, adjust the column fully forward to the detach position (Fig. 6/3); remove battery before adjusting the column to the detach position.

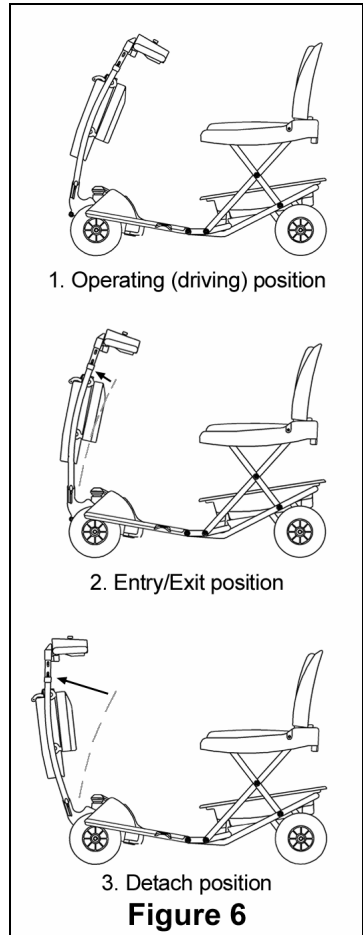

CAUTION: When getting in and out of the **EasyTravel Elite** seat, step only on **CENTER** of foot platform. **DO NOT STEP ON SIDE OF FOOT PLATFORM** to avoid tipping the **EasyTravel Elite**.

NOTE: The rear frame, when folded, can be lifted by the handles (Fig 4/4).

4.2. Folding and Unfolding your *EasyTravel Elite*

Folding the EasyTravel Elite

Step 1: Fold backrest of seat down and ensure it is locked (Fig. 7/1)

Step 2: Hold handgrip of front column (Fig. 7/2) in the “Operating” or “Entry/Exit” position and push forward away from seat to fold platform upwards.

Step 3: Grasp platform handle (Fig. 7/3) and pull column lock triggers (Fig. 7/4) to fold column towards the platform. Fold together until folded frame lock pin (Fig. 7/5) and column latch (Fig. 7/6) click into place and hold *EasyTravel Elite* in folded position.

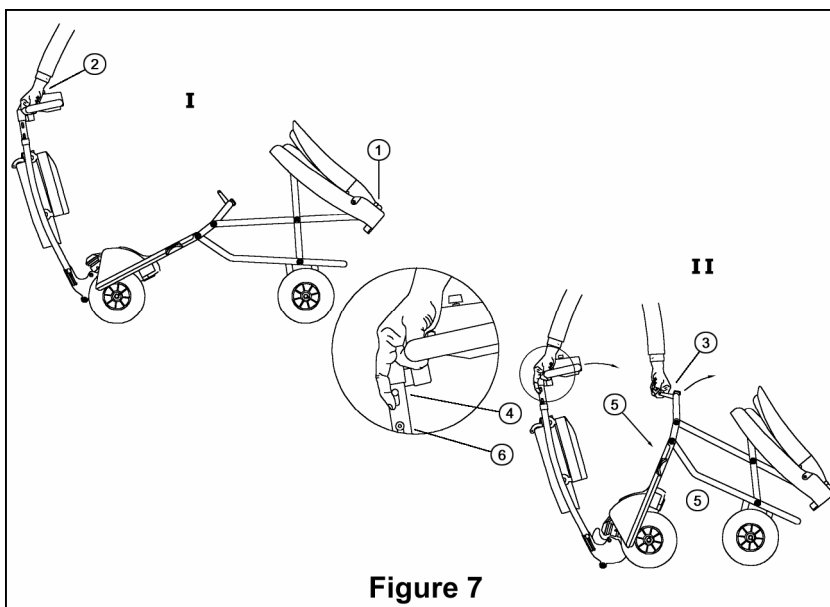

Figure 7

Unfolding the *EasyTravel Elite*

Step 1: Pull on the frame lock pin ring (Fig. 8/1) to release platform and rest front wheels on floor.

Step 2: Pull the seat backrest and lift it upright. (Fig. 8/2)

Step 3: Grasp top of seat backrest (Fig. 8/3) and pull column lock triggers (Fig. 8/4) to release column from platform. Pull outwards to unfold *EasyTravel Elite* until platform and column lock into the operating position.

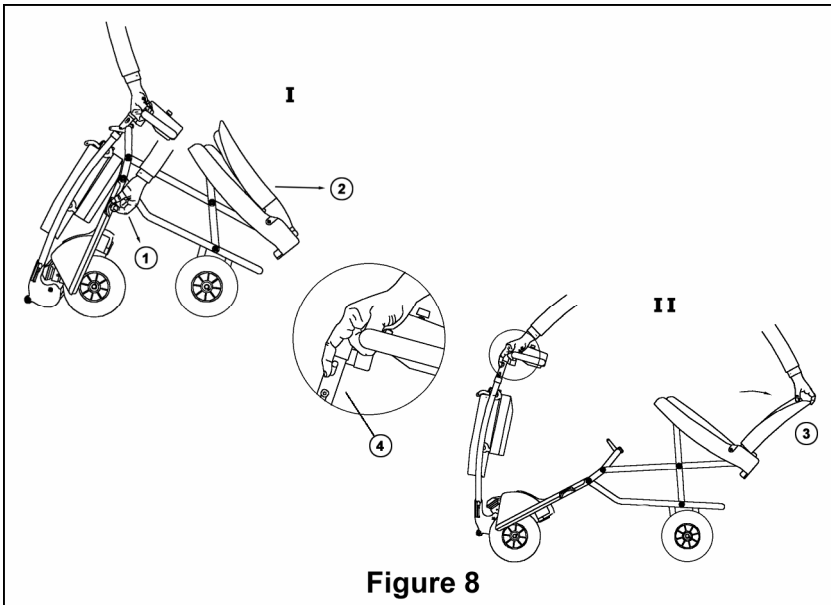

5. OPERATING YOUR *EasyTravel Elite*

5.1. Control Panel operation features

The switch located on the right side of the control panel (Fig. 9/1), will turn the power of the *EasyTravel Elite* ON or OFF.

NOTE: Turn your *EasyTravel Elite* switch to the OFF position when not in use in order to conserve battery power, and prevent unintentional operation.

The top speed may be adjusted by turning the Speed-adjusting knob (fig 9/3). By turning the knob to the HI position, your *EasyTravel Elite's* top speed will be up to 3.7mph/6kph. When the knob is set to the Lo position, the speed will be reduced to a slow crawl, ideal for less experienced drivers and for operating indoors.



Figure 9

5.2. Indicator light (Fig. 9/4)

The light, located at the bottom of the handle control cover, displays battery status and fault indications as follows:

- ❑ **Indicator light steady** - This indicates that all is well.
- ❑ **Indicator light flashes slowly** - The controller is functioning correctly but batteries should be charged as soon as possible. The Battery Gauge (Fig. 9/5) shows the charge that is left.
- ❑ **Indicator light flashes rapidly** - This indicates that there is a fault. Please follow the following procedure:

1. Switch off the *EasyTravel Elite*
2. Make sure that the *EasyTravel Elite* is not in the FREEWHEEL position.
3. Make sure that the charger is not connected to the *EasyTravel Elite*.
4. Make sure that the control lever is in the middle position.

CAUTION: If control lever does not return by itself to the middle position – do not operate. Contact your service agent.

5. Switch the *EasyTravel Elite* on again and try to drive. If the indicator light flashes rapidly again, switch off and do not operate. Contact your service agent!

5.3. Battery Gauge (Fig. 9/5)

The Battery Gauge (Fig. 9/5) shows the battery charge that is left.

5.4. Driving your *EasyTravel Elite*

To drive forward, pull the right side of the hand control lever towards you (Fig. 10/1). You can also move forward by pushing the left side of the control lever away from you. By releasing the control lever, you will gradually come to a stop, and the *EasyTravel Elite* brake will be applied automatically. To operate in reverse, pull the left side of the hand control lever towards you (Fig. 10/2).

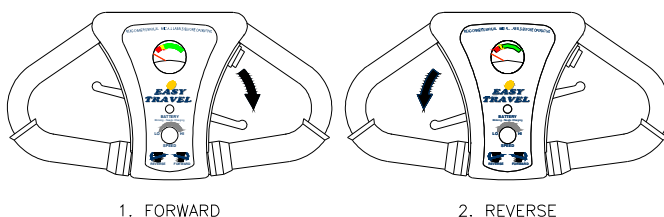

Figure 10

5.5. Safety considerations when driving your *EasyTravel Elite*

- ❑ Footpaths and sidewalks appear to be level but are usually slightly sloped for drainage of rainwater. Counter-steering may be necessary for overcoming excessive slopes. In such cases the speed should be reduced as necessary.
- ❑ When approaching ditches, bumps or similar obstacles – reduce speed as necessary.
- ❑ Do not operate *EasyTravel Elite* in places or on surfaces where a loss of wheel grip could be hazardous, for example on wet grassy slopes.

5.6. Armrests

To enable easier entry to and exit from your *EasyTravel Elite* the armrest can be lifted, see Fig. 10A.



Figure 10 A

5.7. Batteries

Battery information

The **EasyTravel Elite** is designed to use sealed lead acid, maintenance-free, 12V batteries.

Always turn your **EasyTravel Elite** OFF before removing and installing batteries. To get the maximum out of your batteries, it is recommended to fully charge the batteries overnight after every day of use. **Reconnecting the charger when the batteries are partially discharged or fully charged will not harm them.** Extended charging is good for the batteries and you cannot overcharge them.

Battery range depends on operator weight, terrain and the condition of batteries used. Charge your batteries daily and/or overnight when the **EasyTravel Elite** is not in use.

Battery Recharging Instructions

To recharge, turn off **EasyTravel Elite**. It is possible to either charge the battery while connected on the **EasyTravel Elite** (see instruction 1 below) or directly (instruction 2).

1. Plug the charging connector into the **EasyTravel Elite** charging socket and then connect the charger to an electrical outlet socket.
2. Plug the charging connector in the back of the battery pack and then connect the charger to an electrical outlet socket.

During charging, the indicator light on the charger will be orange. When the battery is approaching full charge the indicator light will turn green. In order to achieve the maximum battery capacity and efficiency, it is advised to charge them overnight, and at least four hours after the indicator light has turned to green.

Safety Instructions

CAUTION: Failure to follow these instructions may result in personal injury or property damage.

1. Never smoke or allow an open flame in the vicinity of the batteries.
2. Use the charger for charging lead acid batteries only. It is not intended to supply power to an extra-low-voltage electrical system or to charge dry cell batteries.
3. Never charge a frozen battery.

4. Do not operate the charger in a closed-in area or restrict ventilation.
5. Prevent external damage to AC and DC cords. Do not use charger if cords are damaged.
6. Connect DC charging cord to the Charging Socket before connecting charger AC supply cord to the electrical outlet, and disconnect the AC cord from the electrical outlet before disconnecting charge cord.
7. Be extra cautious not to drop a metal object onto the battery case.
8. Remove jewellery.

Battery Storage

Before storage, battery packs should be fully charged, and should be recharged at least once every three months.

Store batteries indoors in a dry environment.

Storage temperature range: -20°C (-4°F) to 40°C (104°F)

Charging temperature range: 0°C (32°F) to 40°C (104°F)

Operating temperature range: -20°C (-4°F) to 50°C (122°F)

WARNING: Store batteries in the 'correct' position. (See Fig. 14).

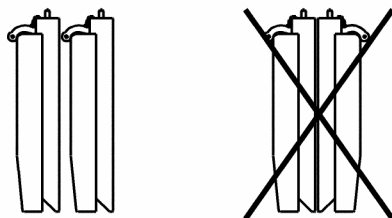

Figure 14

Battery Replacement and Disposal

The EasyTravel Elite battery pack contains two 12V maintenance-free batteries. Replacement of the batteries is only permitted to an authorized dealer.

Battery cells may emit minor acid fumes.

Batteries must be recycled. Disposals of potentially damaged batteries present hazards of injury from acid leakage and environmental pollution.

NOTE: When removing a battery, always set it on cardboard, newspaper, or surfaces that cannot be damaged by acid fumes or liquid from the battery.

6. MOVING AND TRANSPORTING YOUR *EasyTravel Elite*

6.1. Moving Your *EasyTravel Elite* in Freewheel Mode when unfolded:

The Freewheel switch (Fig. 1/17) is used for releasing the brake and moving the *EasyTravel Elite* without operating the motor. Before activating, make sure your *EasyTravel Elite* is switched on. Turn Freewheel switch to the "freewheel" position and push or pull the *EasyTravel Elite* manually.

NOTE: The Freewheel mode can only be activated **after** the battery is in place and the power switch (Fig.9/1) is turned on. Doing otherwise will cause a fault situation indicated by rapid flashing of the Indicator light (Fig. 9/4). See section 4.2.

WARNING: The Freewheel switch should never be engaged on a slope.

CAUTION: The seat back must remain in the upright position.

6.2. "Walking" your *EasyTravel Elite* in the folded position

The folded *EasyTravel Elite* may be pulled along suitcase style. The battery should be carried separately (Fig. 11) or in the utility basket. See folding instructions on page 8.

6.3. Transporting Your *EasyTravel Elite* Quickly And Easily

Your *EasyTravel Elite* can be disassembled and transported in most car trunks.

When disassembling for transportation or storage:

1. Disconnect battery pack and place in Utility basket (Fig. 12/1)
2. Disconnect front column (Fig. 12/2) and fold rear frame separately (Fig. 12/3)
3. For storage – set down front column in a stable position.
4. For transportation, place *EasyTravel Elite* components in car trunk as shown in figure 13.

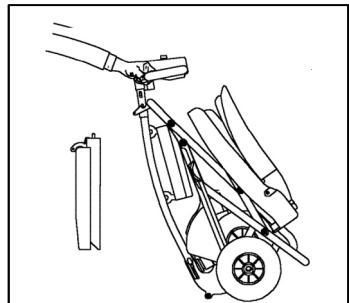

Figure 11



Figure 12



Figure 13

7. HELPFUL HINTS FOR EVERYDAY USE

Before using your **EasyTravel Elite** take the following precautions:

- Ensure that the front column and rear frame are locked together.
- Ensure that the rear frame is locked open.

Speed Controls

Always operate your **EasyTravel Elite** at a reasonable speed for both your personal safety and others.

CAUTION: Reduce speed when turning.

Stopping

Dynamic braking will gradually bring your **EasyTravel Elite** to a stop when hand control lever is released.

Ramps and Inclines

Lean forward and carefully manoeuvre your **EasyTravel Elite** up a ramp or incline. Be aware that not all ramps are constructed according to Government standards. The Government standard for wheelchair ramps is 2.5 cm (1 inch) rise per 30 cm (1 foot).

Lower the speed setting to a slow speed when descending inclines.

Using an elevator

Backing into an elevator allows you to exit forward. Be sure that the elevator is level with the floor.

Opening Doors

When a door opens towards you, approach at an angle and just off to one side. Adjust the speed knob to a low setting. Grasp the doorknob, reverse and pull the door open. For doors that open away from you, position the front roller against the door, close to the doorjamb on the doorknob side of the door. After you release the latch, use the roller to push the door open.

WARNING: Be careful with glass doors to avoid personal injury!

8. GENERAL MAINTENANCE AND INSPECTIONS

Minimum maintenance should prevent unnecessary repairs.

Keep Your *EasyTravel Elite* Shining

Wipe the seat clean with a damp cloth. Protect the painted parts with a coat of auto wax.

WARNING: Water or Excessive moisture around the controller unit or electrical connections may cause contamination of electrical circuitry, damage and malfunction as well as personal injury. Do not leave your *EasyTravel Elite* in the rain or in excessively humid locations.

Daily Checks

With the *EasyTravel Elite* switched off, check that the hand control lever mechanism returns to the rest position when you push and release. If there is a problem do not use the *EasyTravel Elite* and contact your authorized dealer.

Weekly Checks

1. **Throttle test:** Pull the throttle to the full speed position and switch ON the Power switch. The *EasyTravel Elite* should not move and the LED on the panel should flash. If the *EasyTravel Elite* does move – do not use your *EasyTravel Elite*. Contact your authorized dealer.
2. **Automatic brake and drive test:** This test should be carried out on a level surface with at least 3' / 1 m. clear space around the *EasyTravel Elite*:
 - Switch the *EasyTravel Elite* on.
 - Move the control lever only slightly in the forward direction until you hear a “click” when the brake disengages. The *EasyTravel Elite* should start to move forwards slowly.
 - Immediately release the throttle. You must be able to hear a “click” when the brake engages back, within a few seconds.
 - Repeat the test in the reverse direction.

If you do not hear the brake operating, or the *EasyTravel Elite* does not move slowly in the expected direction – do not use your *EasyTravel Elite*. Contact your authorized dealer.

Monthly Care

Clean upholstery, plastic and metal parts with a mild surface cleaner.

CAUTION: Keep cleaning solvents away from electrical wires and connectors.

Half-Year Care

1. Apply a lubricant/cleaner (such as WD40 or similar) these locations:
 - Column tilt lock pin and housing.
 - Unfolded lock pin and housing.
 - Battery pack lock pins.
2. Lightly apply Vaseline or similar lubricant to battery contact pins and springs on front column.
3. Check for tire wear.

Overload Fuses

The electric circuits of the **EasyTravel Elite** are provided with two overload protection fuses. Replacement of the fuses is only permitted to an authorized technician. Both fuses are commercially available automotive-blade type.

Location of the fuses

- Battery Pack fuse 20A, - Within Battery pack
- Control circuit fuse 1A, – Underneath controller cover

NOTE: Fuses of a different rating should not be used!

WARNING: Do not attempt to repair or service the **EasyTravel Elite** or any of its components, as this will void your warranty.

SERVICE AND REPAIR: CONTACT YOUR AUTHORIZED DEALER.

9. EMI – ELECTROMAGNETIC INTERFERENCE

CAUTION: It is important that you read this information regarding the possible effects of electromagnetic interference on your *EasyTravel Elite*.

Electromagnetic Interference (EMI) From Radio Wave Sources

Motorized scooters may be susceptible to electromagnetic interference (EMI), which is interfering electromagnetic energy (EM) emitted from sources such as radio stations, TV stations, amateur radio (HAM) transmitters, two-way radios, and cellular phones. The interference (from radio wave sources) can cause scooters to release their brakes, come to a sudden stop, or move in an uncontrolled manner. It can also permanently damage a scooter's control system. The intensity of the interfering EM energy can be measured in volts per motor (V/m). Each Motorized scooter can resist EMI up to a certain intensity. This is called its "immunity level". The higher the immunity level, the greater the protection. The FDA has stated that all newly manufactured electric mobility vehicle models should have a resistance of at least 20 V/m, which would provide a reasonable degree of protection from the more common sources of radiated EMI.

Your *EasyTravel Elite* as shipped, with no further modification, has an immunity level of 20 V/m. This immunity was tested with the inclusion of these accessories: a utility basket with a spare battery-pack and the charger unit carried inside it.

There are a number of sources of relatively intense electromagnetic fields in the everyday environment. Some of these sources are obvious and easy to avoid. Others are not apparent and exposure is unavoidable. However, we believe that by following the warnings listed below, your risk to EMI will be minimized.

The sources of radiated EMI can be broadly classified into three types:

- 1) **Hand-held portable transceivers** (transmitters-receivers) with the antenna mounted directly on the transmitting unit. Examples include citizens band (CB) radios, "walkie-talkies", security, fire, and police transceivers, cellular telephones, and other personal communication devices.
**NOTE: Some cellular telephones and similar devices transmit signals while they are ON, even when not being used;
- 2) **Medium-range mobile transceivers**, such as those used in police cars, fire trucks, ambulances, and taxis. These usually have the antenna mounted on the outside of the vehicle; and
- 3) **Long-range transmitters and transceivers**, such as commercial broadcast transmitters (radio and TV broadcast antenna towers) and amateur (HAM) radios.

NOTE: Other types of hand-held devices, such as cordless phones, laptop computers, AM/FM radios, TV sets, CD players, and cassette players, and small appliances, such as electric shavers and hair dryers, so far as we know, are not likely to cause EMI problems to motorized scooters.

Motorized scooter Electromagnetic Interference (EMI)

Because EM energy rapidly becomes more intense as one moves closer to the transmitting antenna (source), the EM fields from hand-held radio wave sources (transceivers) are of special concern. It is possible to unintentionally bring high levels of EM energy very close to the motorized scooter's control system while using these devices. This can affect the scooter's movement and braking. Therefore, the warnings listed below are recommended to prevent possible interference with the control system of your **EasyTravel Elite**.

WARNINGS

Electromagnetic interference (EMI) from sources such as radio and TV stations, amateur radio (HAM) transmitters, two-way radios, and cellular phones can affect motorized scooters. Following the warnings listed below should reduce the chance of unintended brake release or powered wheelchair movement, which could result in serious injury.

- 1) Do not operate hand-held transceivers (transmitters-receivers), such as citizens band (CB) radios, or turn ON personal communication devices, such as cellular phones, while your **EasyTravel Elite** is turned ON;
- 2) Be aware of nearby transmitters, such as radio or TV stations, and try to avoid coming close to them;
- 3) If unintended movement or brake release occurs, turn your **EasyTravel Elite** power switch OFF as soon as it is safe to do so;
- 4) Be aware that adding accessories or components, or modifying your **EasyTravel Elite**, may make it more susceptible to EMI (Note: There is no easy way to evaluate their effect on the overall immunity of your **EasyTravel Elite**);
- 5) Report all incidents of unintended movement or brake release to your Authorized **EasyTravel Elite** dealer or service centre, and note whether there is a source of EMI nearby.

10. FAULT FINDING

Hereunder are some types of disorders, which can usually be repaired rather simply. If these following measures are unsuccessful, contact your authorized dealer!

Problem		Check Point
The driving of the wheelchair is too slow or insufficient, the status indicator lamp flashes slowly		Batteries are exhausted and need to be recharged
<p>The EasyTravel Elite does not function, the Battery/Status indicator flashes rapidly.</p> <p>Count the number of flashes:</p>	1 flash	The battery needs charging or there is a bad connection to the battery. Check the connections to the battery or charge batteries.
	2 flashes	There is a bad connection to the motor. Check all connections between the motor and the controller.
	3 flashes	The motor has a short circuit to a battery connection.
	4 flashes	Freewheel is engaged.
	5 flashes	Not used.
	6 flashes	The controller is being inhibited from driving; this may be because the battery charger is connected.
	7 flashes	A throttle fault is indicated. Make sure that the throttle is in the rest position before switching on the scooter
	8 flashes	A controller fault is indicated. Make sure the controller connections are secure.
	9 flashes	The parking brakes have a bad connection. Check the parking brake and motor connections. Make sure the controller connections are secure.
	10 flashes	An excessive voltage has been applied to the controller. This is usually caused by a poor battery connection. Check the battery packs and controller connections.

11. DISPOSAL AND RECYCLING

- ❑ The packing material must be separated to plastic and paper/cardboard components and submitted to authorized recycling locations.
- ❑ The **EasyTravel Elite** device consists of electronic components, cables, plastic parts, steel and aluminium frame and adapter parts. Do not discard of any components to normal garbage facilities. When **EasyTravel Elite** is no longer operational, it is to be dismantled and separated into above material groups and submitted to authorized recycling facilities.

12. TECHNICAL DATA

Speed	Continuously adjustable, up to 6 km/h (3.7 mph)
Power Supply	24 V from two rechargeable maintenance-free sealed lead/acid batteries Standard size: 12V – 7.2 Ah Jumbo size: 12V-12 Ah
Charging time	7 – 10 hours
Max. admissible slope	6° (10 %)
Max. negotiable curb height	5 cm / 2"
Range approx.*	Standard battery 6.5 - 8 km / 4 - 5 Miles Jumbo battery 11 – 13 km / 6.5 – 8 Miles
Tires	Flat-free PU 200 x 50
Dimensions:	57 X 104 X 86 cm / 22"X41"X34"
Weights:	
Rear frame	12 Kg / 26 Lb
Front column (without battery)	10.0 Kg / 22.0 Lb
Battery Pack	Standard: 5.0 Kg / 11 Lb. Jumbo: 8 Kg. / 17 Lb.
Total weight	27 Kg / 59 Lb.
Maximum users weight	115 Kg. / 250 lb.

*The actual range depends on the operation conditions and the load

WARRANTY

The warranty period for the **EasyTravel Elite** is twelve months and covers faulty materials and workmanship (consumables not covered: tyres, upholstery, lamp bulbs, plastic coverings and batteries). Worn parts damaged as a result of excessive loading, improper handling, intentional damage or unauthorized maintenance or modification are not covered by the warranty.

For safety and for warranty assurance reasons, any modifications and repair of the **EasyTravel Elite** or its components must be performed exclusively by authorized personnel and exclusively with original spare parts.

The **EasyTravel Elite** and its accessories have been designed, manufactured and tested in accordance with the specification of the following:

DIRECTIVE: Medical devices 93/42 EEC



Manufactured by:



EC Authorized Representative:

Medical Specialities Ltd.
Blackburn, BB2 4HT UK

Distributed by:

