User's Manual

Model CA51/71
HANDY CAL
(Calibrator)

IM CA71-E

Introduction

Thank you for purchasing the CA51/71 HANDY CAL Calibrator. This User's Manual explains the functions of the CA51/71, as well as the operating methods and handling precautions. Before using the CA51/71, read this manual thoroughly to ensure correct use of the instrument. When you have finished reading this manual, store it in the carrying case for future reference.

■ Notes

- This manual exclusively describes the CA71, which is more multifunctional than the CA51. The CA51 has no temperature measurement and communication functions.
- The contents of this manual are subject to change without prior notice for reasons of improvements in performance and/or functionality.
- Every effort has been made to ensure the accuracy of this manual. If you notice any errors or have any questions, however, please contact the vender from which you purchased the instrument.
- The content of this manual may not be transcribed or reproduced, in part or in whole, without prior permission.

■ Trademark Acknowledgments

- All other company and product names appearing in this document are trademarks or registered trademarks of their respective holders.

■ Revision Information

February 2002: First edition

December 2006: 2nd edition

Checking Items in the Package

After opening the package, check the product as follows before use. If the delivered product is the wrong model, any item is missing, or there are visible defects, contact the vendor from which you purchased the product.

Main Unit

Check the model (specifications) codes in the MODEL and SUFFIX fields of the nameplate at the back of the instrument to ensure that the instrument is exactly as specified in your purchase order.

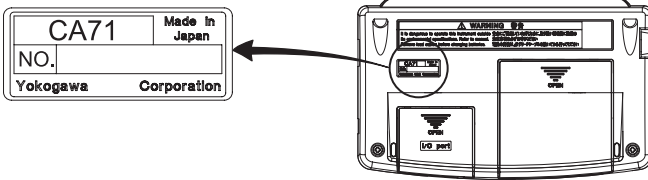

- Model Codes

Model	Specification
CA51	Basic model
CA71	Provided with temperature measurement and communication functions

- NO. (Serial Number)
Refer to this serial number on the nameplate when contacting the vendor about the instrument.

Standard Accessories

Make sure that the package contains all the accessories listed below and that they are all free from any damage.

Lead cables for source (98020)



Lead cables for measurement (RD031)

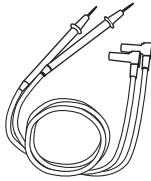

Carrying case (93016)

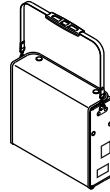

Fuse (A1501EF)

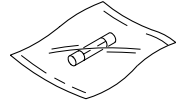

Terminal adapter (99021)

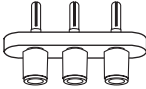

AA-size (LR6) alkaline batteries (four units)

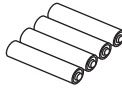

User's manual (IM CA71-E)

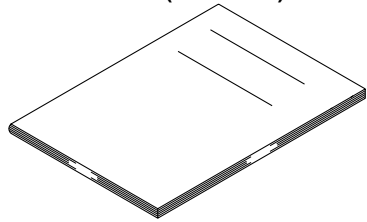

Optional Accessories

The products listed below are available as optional accessories. If you purchased some of the optional accessories, make sure the delivered package is complete with the ordered items and they are free from any damage. For technical and ordering inquiries concerning the accessories, contact the vendor from which you purchased the instrument.

Product	Part Number	Remarks
AC adapter	A1020UP	For 100 V AC
AC adapter	A1022UP	For 120 V AC
AC adapter	B9108WB	For 220 to 240 V AC
RJ sensor	B9108WA	For reference junction compensation
Accessories case	B9108XA	
Communication cable (RS232)	91017	(For CA71 only)

Checking Items in the Package

Optional Spare Parts

Product	Part Number	Remarks
Lead cable for source	98020	
Lead cable for measurement	RD031	
Carrying case	93016	
Terminal adapter	99021	Used for temperature measurement
Fuse	A1501EF	10 units as a kit

Accessories case



RJ sensor

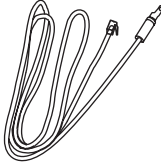

Communication cable

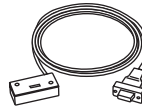

AC adapter

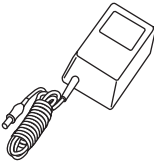

Precautions for Safe Use of the Instrument

For the correct and safe use of the instrument, be sure to follow the cautionary notes stated in this manual whenever handling the instrument. Yokogawa Meters & Instruments Corporation shall not be held liable for any damage resulting from use of the instrument in a manner other than prescribed in the cautionary notes.

The following symbols are used on the instrument and in the User's Manual to ensure safe use.



Danger! Handle with Care.

This symbol indicates that the operator must refer to an explanation in the User's Manual in order to avoid the risk of injury or loss of life of personnel or damage to the instrument.



This symbol indicates DC voltage/current.



This symbol indicates AC voltage/current.



This symbol indicates AC or DC voltage/current.



WARNING

Indicates that there is a possibility of serious personal injury or loss of life if the operating procedure is not followed correctly and describes the precautions for avoiding such injury or loss of life.



CAUTION

Indicates that there is a possibility of serious personal injury or damage to the instrument if the operating procedure is not followed correctly and describes the precautions for avoiding such injury or damage.



NOTE

Draws attention to information essential for understanding the operation and features.

TIP

Provides additional information to complement the present topic.

Damage to the instrument or personal injury or even loss of life may result from electrical shock or other factors. To avoid this, follow the precautions below.

WARNING

- Use in gases

Do not operate this instrument in areas where inflammable or explosive gases or vapor exists. It is extremely hazardous to use the instrument under such environments.

- Defects in protective features

Do not operate this instrument if any defect seems to exist in such protective features as fuses. Before operating the instrument, make sure the protective features are free from any defect.

- External connection

When connecting the instrument to the object under test or an external control circuit, or if you need to touch any external circuit, cut off the power to the circuit and make sure no voltage is being supplied.

- Fuses

In order to prevent a possible fire, use a fuse with ratings (current, voltage, and type) specified for the instrument. Do not short-circuit the fuse holder.

- Correctly use the lead cables for measurement (P/N: RD031) and source (P/N: 98020) without mistaking one for the other. For high-voltage measurement, always use the lead cable for measurement.

- Opening of the case

No person other than our service personnel is allowed to open the case since the instrument contains high-voltage parts.

For the safe use of the optional AC adapter, follow the precautions given below.

WARNING

- Power supply

Before turning on the instrument, always make sure the voltage being supplied matches the rated supply voltage of the instrument.

Contents

Introduction	i
Checking Items in the Package	ii
Precautions for Safe Use of the Instrument	v
1. Functions	1-1
2. Names and Functions of Parts	2-1
3. Before Starting Source/Measurement	3-1
4. Source	4-1
4.1 Connecting Cables to Terminals	4-2
4.2 Sourcing DC Voltage, DC Current or SINK Current Signal	4-3
4.2.1 Sourcing DC Voltage or DC Current Signal	4-3
4.2.2 4–20 mA Function	4-4
4.2.3 20 mA SINK Function	4-5
4.2.4 Using As 24-V Loop Power Supply	4-6
4.3 Sourcing Resistance or RTD Signal	4-7
4.4 Sourcing Thermocouple (TC) Signals	4-9
4.4.1 When RJ Sensor Is Used (Making Use of Reference Junction Compensation)	4-9
4.4.2 When No RJ Sensor Is Used	4-11
4.5 Sourcing Pulse Signals	4-12
4.5.1 Sourcing a Continuous Pulse Train	4-12
4.5.2 Sourcing the Preset Number of Pulses (Pulse Cycle) ...	4-14
4.5.3 Using the Contact Output	4-16
4.6 Divided Output Function (n/m)	4-18
4.7 Sweep Function	4-20
4.8 Auto Step Function	4-20
4.9 Temperature Monitor Function	4-20
5. Measurement	5-1
5.1 Connecting Cables to Terminals	5-2
5.2 Measuring 300 V AC-range Voltage, DC Voltage, AC Voltage or DC Current	5-4
5.2.1 Measuring 300 V AC-range Voltage	5-4
5.2.2 Measuring DC or AC Voltage	5-4
5.2.3 Measuring DC Current	5-4
5.3 Measuring Resistance or RTD (CA71 only) Signal	5-6

Contents

5.4	Measuring Temperature with Thermocouple (TC) - CA71 only - ...	5-7
5.5	Measuring Frequency or Pulses	5-8
5.5.1	Operating the Calibrator for Frequency Measurement	5-8
5.5.2	Operating the Calibrator for Measuring Number of Pulses ...	5-8
6.	Memory Functions	6-1
6.1	Saving Data into Memory	6-2
6.1.1	Saving Data in the Order of Memory Numbers	6-2
6.1.2	Saving Data by Selecting Desired Memory Number	6-4
6.1.3	Overwriting Data in Memory	6-4
6.2	Reading Data from Memory	6-5
6.3	Clearing Data in Memory	6-6
6.3.1	Clearing Data by Selecting Desired Memory Number	6-6
6.3.2	Clearing All In-Memory Data Globally	6-7
6.4	Sending Out Data from Memory - CA71 only -	6-7
7.	Functions Provided by DIP Switch	7-1
7.1	Sweep Function	7-2
7.2	Auto Step Function	7-4
7.3	Selecting the INT RJ Function	7-6
7.4	Selecting the IPTS-68 Function	7-6
7.5	Switch Not Used	7-7
7.6	Temp Switch	7-7
7.7	Selecting the Contact In Function (Contact Input for Pulse Measurement)	7-7
7.8	Disabling the Automatic Power-off Feature	7-7
8.	Communication Function - CA71 only -	8-1
8.1	Cables Connection and Interface Specifications	8-1
8.2	Setting the Mode	8-2
8.3	Types of Mode	8-2
8.4	Data Format	8-3
8.5	Data Structure	8-3
8.6	Commands	8-4
8.7	Detailed Description of Commands	8-5
9.	Troubleshooting	9-1
10.	Method of Calibrator Adjustment	10-1
10.1	Calibration Standard Selection and Environmental Requirements	10-1

10.2	Adjusting Source Functions	10-3
10.3	Adjusting Measurement Functions	10-6
10.3.1	Adjusting DC Voltage and DC Current Ranges	10-6
10.3.2	Adjusting AC Voltage and Resistance (400 Ω) Ranges	10-8
10.4	Notes on the Adjustment of Temperature Ranges	
	- CAL71 only -	10-9
10.5	Post-adjustment Verification	10-9
11.	Using Accessories	11-1
12.	Specifications	12-1

1. Functions

■ Block Diagram

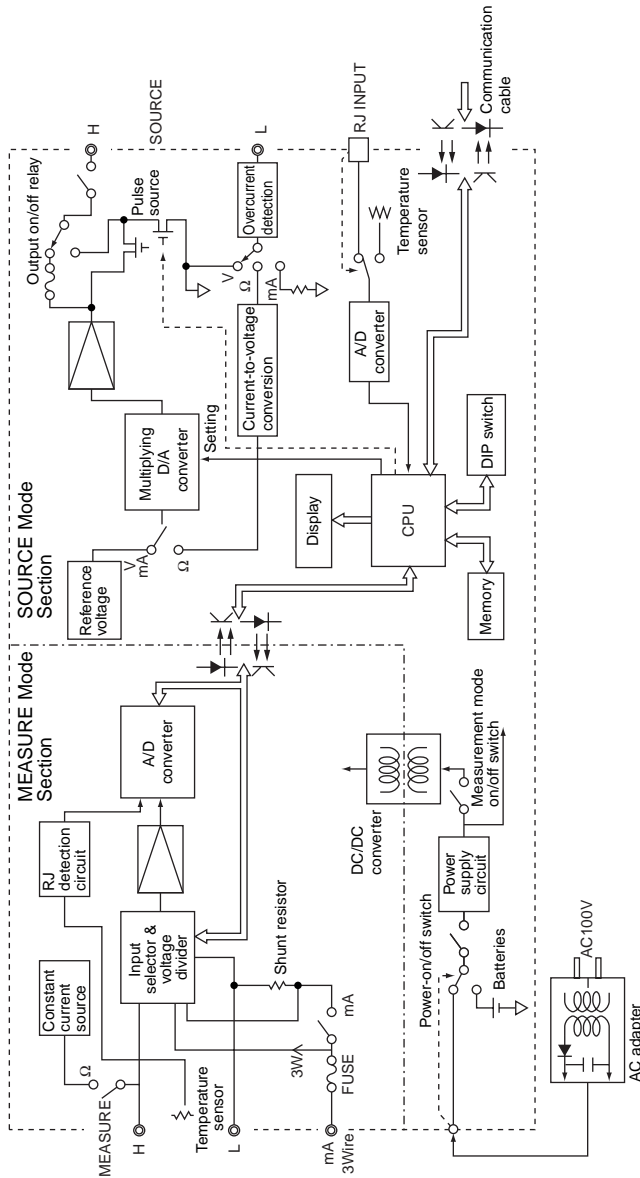

1. Functions

■ Main Functions

- **Source**

The calibrator sources a voltage, current, resistance, thermocouple (TC), RTD, frequency or pulse signal at a preset level.

Function	Description
DC voltage	Sources a DC voltage signal in the 100 mV, 1 V, 10 V or 30 V range.
DC current	Sources a DC current signal in the 20 mA range.
SINK current	Draws a sink current from an external power source in the 20 mA range.
Resistance	Sources a resistance signal in the 400 Ω range.
Thermocouple (TC)	Sources a thermoelectromotive force corresponding to the temperature detected by a type-K, E, J, T, R, B, S, N, L or U thermocouple.* ¹
RTD	Sources resistance corresponding to the temperature detected by a Pt100 or JPt100 RTD.* ²
Frequency and pulse	Sources a continuous pulse train with frequency in the 500 Hz, 1 kHz or 10 kHz range. This function also sources the preset number of pulses defined by the frequency mentioned above.

- **Measurement**

Independent of the source function, the calibrator measures DC voltage, AC voltage, DC current and resistance signals, a temperature signal based on a thermocouple (TC) or RTD, as well as frequency and the number of pulses.

Function	Description
DC voltage	Measures a DC voltage signal in the 100 mV, 1 V, 10 V or 100 V range.
AC voltage	Measures a DC voltage signal in the 1 V, 10 V, 100 V or 300 V range.
DC current	Measures a DC current signal in the 20 mA or 100 mA range. The current terminals are equipped with a built-in overrange input protection fuse.
Resistance	Measures a resistance signal in the 400 Ω range.
Thermocouple (TC)	Measures temperature according to the type of thermocouple – K, E, J, T, R, B, S, N, L or U.* ¹ (CA71 only)
RTD	Measures temperature according to the type of RTD – Pt100 or JPt100. * ² (CA71 only)
Frequency and pulse	Measures frequency in the 100 Hz, 1 kHz or 10 kHz range. For pulse signals, this function measures the number of pulses as a CPM (count per minute) or CPH (count per hour) reading.

You can also select and configure the following functions.

Function	Description
Divided output function(n/m)	Sources a “setpoint $\times (n/m)$ ” output signal, where the variables m and n are defined as $m = 1$ to 19 and $n = 0$ to m .
Memory	Stores up to 50 sourced and measured values as a set.
Sweep	Changes the output signal in a linear manner.
Auto step	Automatically changes the value of n in a setpoint $\times n/m$ output in a step-by-step manner.

1. Functions

- **Power Supply**

The calibrator operates on AA-size (LR6) alkaline batteries or the optional AC adapter.

*1: The thermocouples comply with the Japanese Industrial Standard JIS C1602-1995 (ITS-90), except for the type-L and U thermocouples that comply with DIN.

*2: The RTD comply with the Japanese Industrial Standard JIS C1604-1997 (ITS-90). The internal DIP switch can be configured so that the detectors comply with IPTS-68 instead.

■ Front Panel

- 1 POWER Key
Turns on/off the power supply.
- 2 LIGHT Key
Turns on/off the backlight of the LCD.

MEASURE Mode – Functions for Measurement

- 3 DC Voltage, AC Voltage, Resistance and Pulse Input Terminals
Serve as H (positive) and L (negative) input terminals when you measure DC voltage, AC voltage, resistance, and pulse signals.
- 4 DC Current Input Terminals
Serve as H (positive) and L (negative) input terminals when you measure a DC current signal. Also serve as L' terminals when you carry out 3-wire resistance measurement.
- 5 Three-wire Input Terminals
- 6 Function Selector Switch
Selects a measurement function and its range.
- 7 RANGE DC/AC Key
Used to further select from range options within the selected function.
 - If you have selected the 1 V, 10 V or 100 V range, use this key to toggle between the DC and AC options.
 - If you have selected the FREQ range, use this key to select the range of frequency measurement, as the key cycles through the 100 Hz, 1 kHz, 10 kHz, CPM and CPH options.
 - If you have selected the mA range, use this key to select from the 20 mA and 100 mA ranges.
 - If you have selected the 100 mV TC range, use this key to select the voltage range or the type of thermocouple, as the key cycles through the 100 mV, K, E, J, T, R, B, S, N, L and U options. (CA71 only)
 - If you have selected the Ω RTD range, use this key to select the resistance range or the type of RTD, as the key cycles through the 400 Ω , Pt100 and JPt100 options. (CA71 only)

If you have selected the TC or RTD range in the source mode of display, the TC or RTD type options on the SOURCE function side precede those on the MEASURE mode side.

- 8 MEASURE OFF Key
Turns on/off the MEASURE mode. Turning off the mode causes the measured value shown on the LCD to disappear. If the MEASURE mode is not in use and therefore turned off, the power to the measurement circuit within the calibrator is also turned off. This strategy saves on battery power if the calibrator is running on batteries.
- 9 HOLD Key
Holds the measured value being displayed. Also used to start CPM or CPH measurement or communication.
- 10 MEM Key
Used to turn on/off the memory function.

SOURCE Mode – Functions for Generation

- 11 Output Terminals
These terminals are common to all of the source functions.
- 12 Function Selector Switch
Selects a source function and its range.
- 13 RANGE Key
Used to further select from range options within the selected function.
 - If you have selected the 100 mV TC range, use this key to select the voltage output or the type of thermocouple, as the key cycles through the 100 mV, K, E, J, T, R, B, S, N, L and U options.
 - If you have selected the 400 Ω RTD range, use this key to select the resistance range or the type of RTD, as the key cycles through the 400 Ω , Pt100 and JPt100 options.
 - If you have selected the PULSE range, use this key to select the frequency range, as the key cycles through the 500.0 Hz, 1000 Hz and 10 kHz options.
- 14 SOURCE ON Key
Turns on/off the source output.
- 15 PULSE SET Key
If you have selected the PULSE range, use this key to cycle through the frequency, amplitude and pulse count options for pulses being generated.
- 16 TEMP Key
Allows you to monitor temperature by selecting from the room temperature ($^{\circ}\text{C}$), reference junction temperature ($^{\circ}\text{C}$), thermocouple (mV) and RTD (Ω) options.

2. Names and Functions of Parts

17 *n/m* Key

Turns on/off the divided output function (*n/m*).

18 ▲ and ▼ Output Setting Keys

Set the output value of a source function. Each pair of ▲ and ▼ keys corresponds to each digit of the reading, thus increasing/decreasing the digit in units of 1s. Increasing the digit from 9 or decreasing it from 0 causes the digit to overflow or underflow, allowing you to set the output value without interruption. Holding down the ▲ or ▼ key continuously changes the digit in question.

If your choice is the 4–20 mA function, see Section 4.2, “Sourcing DC Voltage, DC Current or SINK Current Signal,” for further details. Note that ▲ and ▼ keys are also used in the following ways:

- The ▲ and ▼ keys labeled *n* and *m* serve as keys for setting the variables *n* and *m* when you have selected the divided output function (*n/m*). (See Section 4.6, “Divided Output Function (*n/m*),” for further details.)
- The ▲ and ▼ keys labeled MEM NO., SAVE and READ serve as keys for working with the memory when you have selected the memory function. (See Chapter 6, “Memory Function,” for further details.)

19 CLEAR Key

Initializes the output setpoint, causing the on-screen reading to revert to 0000 for functions other than PULSE and 20 mA SINK, though the number of digits depends on function selected. This key serves as a key for clearing the memory when the memory function is selected.

■ Side and Rear Panels

20 FUSE

A holder for housing a fuse that protects the input during DC current measurement.

21 R.J.INPUT

A connector to which the external reference junction compensation sensor is connected.

22 AC Adapter Connection Jack

23 Battery Holder

Opening the cover reveals the battery holder and DIP switch.

24 I/O Port Cover

Open this cover to connect the RS232 communication cable (P/N: 91017). (CA71 only)

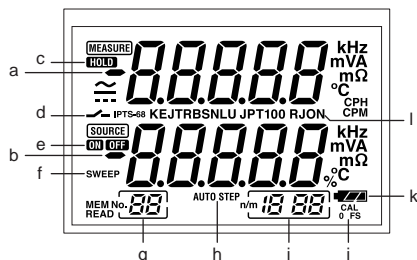

■ LCD Unit

- a. Measured value
- b. Setpoint for source
- c. HOLD indicator
Indicates the on-screen measured value is in a hold state.
- d. CONTACT input
Indicates the contact input is selected when your choice is pulse measurement.
- e. ON/OFF indicators for output
ON: Indicates the output is on.
OFF: Indicates the output is off.
- f. SWEEP indicator for sweep function
Comes on when the sweep function is selected using the DIP switch.
- g. MEM NO. indicator
Shows a memory number when the memory function is selected.
- h. AUTO STEP indicator
Comes on when the auto step function is selected.
- i. Divided output function (n/m) indicator
Comes on when the divided output function (n/m) is selected. The most significant two digits "18" denote the value of n , while the least significant two digits "88" mean the value of m .
- j. CAL mode selection indicator
The 0 and FS indicators below this indicator denote zero point and full scale adjustments, respectively.

2. Names and Functions of Parts

- k. Battery replacement indicator
Shows the battery level in three steps according to the level of remaining electricity.
- l. RJON indicator
Indicates reference junction compensation is active when thermoelectromotive force is being sourced. The thermoelectromotive force output when this indicator is off represents the 0°C-based output.

3. Before Starting Source/Measurement

■ Operating Precautions

Precautions for Safe Use of the Instrument

- When using the instrument for the first time, be sure to read the instructions given on pages iv and v of the section, “Precautions for Safe Use of the Instrument.”
- Do not open the instrument’s case.
Opening the case is extremely hazardous, as the instrument contains high-voltage parts. Contact the vendor from which you purchased the instrument, for a service of inspecting or adjusting the internal assembly.
- In case of failure
Should the instrument begin to emit smoke, give off an unusual odor, or show any other anomaly, immediately turn off the POWER key. If you are using an AC adapter, disconnect the plug from the wall outlet. Also cut off power to the object under test that is connected to the input terminals. Then, contact the vendor from which you purchased the instrument.
- AC adapter
Use an AC adapter dedicated to the instrument. Avoid placing any load on the AC adapter, or prevent any heat-emitting object from coming into contact with the adapter.

General Handling Precautions

- Before carrying around the instrument turn off power to the object under test, and then the POWER key of the instrument. If you are using an AC adapter, disconnect the power cord from the wall outlet. Finally, detach all lead cables from the instrument. Use a dedicated carry case when transporting the instrument.
- Do not bring any electrified object close to the input terminals, since the internal circuit may be destroyed.
- Do not apply any volatile chemical to the instrument’s case or operation panel. Do not leave the instrument in contact with any product made of rubber or vinyl for a prolonged period. Be careful not to let a soldering iron or any other heat-emitting object come into contact with the operation panel, as the panel is made of thermoplastic resin.

3. Before Starting Source/Measurement

- Before cleaning the instrument's case or operation panel disconnect the power cord plug from the wall outlet if you are using an AC adapter. Use a soft, clean cloth soaked in water and tightly squeezed to gently wipe the outer surfaces of the instrument. Ingress of water into the instrument can result in malfunction.
- If you are using an AC adapter with the instrument and will not use the instrument for a prolonged period, disconnect the power cord plug from the wall outlet.
- For handling precautions regarding the batteries, see "Installing or Replacing the Batteries" on page 3-3.
- Never use the instrument with the cover of the battery holder opened.

■ Environmental Requirements

Use the instrument in locations that meet the following environmental requirements:

- Ambient temperature and humidity
 - Ambient temperature range: 0 to 50°C
 - Ambient humidity range: 20 to 80% RH. Use the instrument under non-condensing condition.
- Flat and level locations

Do not use the instrument in locations that are:

- exposed to direct sunlight or close to any heat source;
- exposed to frequent mechanical vibration;
- close to any noise source, such as high-voltage equipment or motive power sources;
- close to any source of intensive electric or electromagnetic fields;
- exposed to large amounts of greasy fumes, hot steam, dust or corrosive gases;
- unstable; or
- exposed to a risk of explosion due to the presence of flammable gases.

NOTE

- Use the instrument under the following environmental conditions if precise source or measurement is your requirement:

Ambient temperature range: $23\pm 5^{\circ}\text{C}$; ambient humidity range: 20 to 80% RH (non-condensing)

When using the instrument within a temperature range of 0 to 18°C or 28 to 50°C , add a value based on the temperature coefficient shown in Chapter 12, “Specifications (page 12-1),” to the given accuracy rating.

- When using the instrument at an ambient humidity of 30% or lower, prevent electrostatic charges from being produced, by using an antistatic mat or any other alternative means.
 - Condensation may occur if you relocate the instrument from places with low temperature and humidity to places with high temperature and humidity, or if the instrument experiences any sudden temperature change. In that case, leave the instrument under the given ambient temperature for at least one hour to ensure that the instrument is free from condensation, before using the instrument.
-

■ Installing or Replacing the Batteries

WARNING

- To avoid electrical shock, always remove the source or measurement lead cables from the object under test, as well as from the instrument itself.
-

CAUTION

- To avoid the risk of fluid leakage or battery explosion, install batteries with their positive and negative electrodes correctly positioned.
 - Do not short-circuit the batteries.
 - Do not disassemble or heat the batteries or throw them into fire.
 - When replacing batteries, replace all of the four batteries at the same time with new ones from the same manufacturer.
 - If the instrument will not be used for a prolonged period, remove the batteries from the instrument.
-

3. Before Starting Source/Measurement

Step 1: Remove the lead cables and AC adapter and turn off the calibrator before you begin installing batteries.

Step 2: Remove the battery holder cover by sliding it in the direction indicated by →OPEN.

Step 3: Install four AA-size (LR6) alkaline batteries in the battery holder with their positive and negative electrodes positioned correctly as indicated on the holder.

Step 4: After replacement, reattach the battery holder cover.

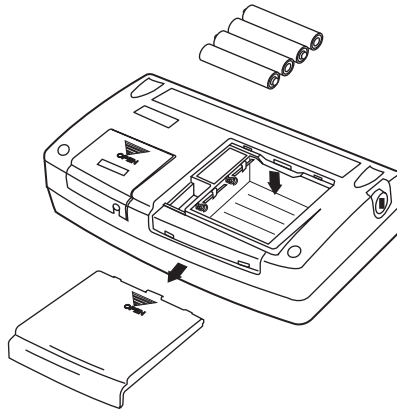

Indication of Battery Level

The battery replacement indicator shows the battery level in three steps according to the measured voltage of the batteries.

▣ (lit constantly) The battery level is normal.

▣ (lit constantly) The battery level is below 50% full, but still allows for normal operation.

▣ (flashing) Replace the batteries.

Note that the battery replacement indicator is driven by directly measuring the battery voltage when the calibrator is in actual operation. Consequently, the indicator may read differently depending on the battery load condition (e.g., the load condition of the source output or on/off state of the measurement function) if the batteries are too low.

If the calibrator will be used under a wide variety of conditions, it is advisable that the battery replacement indicator be verified under heavy loads (MEASURE mode is on and the SOURCE mode is set to the 20 mA/10 V output).

■ Connecting the AC Adapter

WARNING



- Make sure the voltage of the AC power source matches the rated supply voltage of the AC adapter, before connecting the AC adapter to the AC power source.
 - Do not use any AC adapter other than the dedicated AC adapter from Yokogawa M&C Corporation.
-
-

Step 1: Make sure the calibrator is turned off.

Step 2: Insert the plug of the optional AC adapter into the AC adapter connection jack.

■ Turning On/Off the Power

Turning On/Off the POWER Switch

- Pressing the  key once when the power is off turns on the calibrator. Pressing the  key once again turns off the calibrator.

NOTE

Before disconnecting the AC adapter from an AC power source, turn off the calibrator by pressing the  key.

NOTE

When operating the calibrator on batteries, disconnect the AC adapter plug from the instrument. Once you connect the AC adapter plug to the instrument, the instrument no longer operates on batteries. Thus, the instrument will not turn on unless the AC adapter is connected to an AC power source.

3. Before Starting Source/Measurement

Turning On/Off MEASURE Mode

Pressing the  key after power-on turns off the MEASURE mode.

- If the MEASURE mode is not needed and therefore turned off, power to the measurement circuit is also turned off within the calibrator. Thus, you can save on battery power if the calibrator is running on batteries.
- Turning off the MEASURE mode causes the on-screen measured value to disappear.
- To resume measurement when the MEASURE mode is off, press the  key once again.

TIP

One to two seconds are taken for the LCD to turn on after the MEASURE mode is turned on.

■ Automatic Power-off

- When the calibrator is running on batteries and no key is operated for approximately nine minutes, all elements on the LCD begin to blink. The calibrator gives off a buzzer sound to alert you. If you still do not operate any key for another 30 seconds, the calibrator automatically turns off. The automatic power-off feature is factory-set to ON.
- To continue using the calibrator after the LCD has begun blinking, press any key other than the  key. The LCD stops blinking and lights steady, allowing you to continue from the original status of the calibrator.
- The automatic power-off feature is disabled if the calibrator is operated on the AC adapter.
- To disable the automatic power-off feature when the calibrator is battery-operated, see Section 7.8, “Disabling the Automatic Power-off Feature.”

■ Turning On/Off the Backlight

The LCD can be back-lit. Pressing the  key turns on the backlight, while pressing the key once again turns it off. This feature makes it easier for you to view the LCD when operating the calibrator in dark places or when carrying out source or measurement. Note that battery life shortens when the calibrator is operated on batteries.

NOTE

The backlight automatically turns off approximately one minute later. To turn on the backlight again, press the  key once again.

3. Before Starting Source/Measurement

■ Operating Environment

Operating Environment

Ambient Temperature and Humidity

Use the CA51/71 in the following environment:

- Ambient temperature: 0 to 50°C
- Ambient humidity: 20 to 80 % RH (no condensation)

Operating Altitude

2000 m max. above sea level.

Location

Indoors

Measurement Category (CAT.)

The measurement category of the CA51/71 is III (300 Vrms max.).



WARNING

Do not use the CA150 for measurements in locations falling under Measurement Categories IV.

Measurement Category

Measurement Category	Description	Remarks	
I	CAT. I	For measurement performed on circuits not directly connected to MAINS.	
II	CAT. II	For measurement performed on circuits directly connected to the low voltage installation.	Appliances, portable equipments, etc.
III	CAT. III	For measurement performed in the building installation.	Distribution board, circuit breaker, etc.
IV	CAT. IV	For measurement performed at the source of low-voltage installation.	Overhead wire, cable systems, etc.

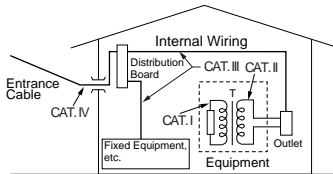

Pollution Degree

Pollution Degree applies to the degree of adhesion of a solid, liquid, or gas which deteriorates withstand voltage or surface resistivity.

The pollution degree of the CA150 in the operating environment is 2. Pollution Degree 2 applies to normal indoor atmospheres. Normally, only non-conductive pollution is emitted. However, a temporary electrical conduction may occur depending on the concentration.

4. Source

From the calibrator, you can source a DC voltage, DC current, SINK current, resistance, thermocouple, RTD, frequency or pulse signal.

WARNING

- To avoid electrical shock, do not apply any voltage above 30 V to the output terminals. Always use the calibrator in locations with a voltage to ground below 30 V.

CAUTION

- Do not apply any voltage to the output terminals for ranges other than 20 mA SINK. Otherwise, the internal circuitry may be damaged.
- The instrument has been calibrated without taking into account a voltage drop due to the resistance component of the lead cables for source. Care must be taken therefore when drawing a load current since the voltage drop due to the resistance component (approximately 0.1 Ω on a round-trip basis) of the lead cables serves as an error.

4.1 Connecting Cables to Terminals

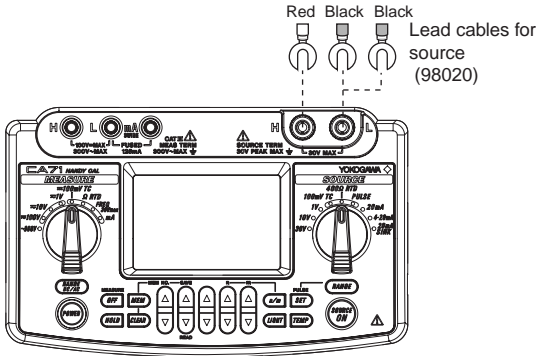

For DC voltage, DC current, thermocouple or pulse output















- Step 1:** Connect the red lead cable for source (P/N: 98020) to the H output terminal and the black lead cable to the L output terminal.
- Step 2:** Connect the two clips of the cables to the input of equipment under test while making sure the polarities are correct.

For 3-wire connection resistance or RTD signal

- Step 1:** Connect the red lead cable for source (P/N: 98020) to the H output terminal, and both black lead cables to the L output terminal. (The two black lead cables should be fastened together to the L output terminals.)
- Step 2:** Connect the three leading clips of the cables to the input of equipment under test while making sure the polarities are correct.

4.2 Sourcing DC Voltage, DC Current or SINK Current Signal

4.2.1 Sourcing DC Voltage or DC Current Signal

- Step 1:** Using the Function selector switch, select the desired source function from *100mV TC*, *1V*, *10V*, *30V* and *20mA*.
- Step 2:** The LCD shows the default value and unit of the source function.
- Step 3:** Set the output value digit by digit using each pair of  and  output setting keys. Each pair of  and  keys corresponds to each digit of the LCD reading. Each press of the  and  key increases or decreases the digit. Increasing the digit from 9 or decreasing it from 0 causes the digit to overflow or underflow, allowing you to set the output value without interruption. Holding down the  or  key continuously changes the digit in question. Pressing the  key initializes the output setpoint to the default value (0).
- Step 4:** Pressing the  key causes the  indicator on the LCD to change from  to . The calibrator sources the preset DC voltage or current signal between the output terminals.
- Step 5:** To turn off the output, press the  key once again. The  appears on the LCD and the output terminals are open-circuited.

4.2 Sourcing DC Voltage, DC Current or SINK Current Signal

TIP





If either of the following cases applies, the protection circuit works to turn off the output.



- The output terminals or the lead cables for source connected to the output terminals are short-circuited or an excessive load current has flowed through the cables when a voltage is being output.
 - The output terminals or the lead cables for source connected to the output terminals are open-circuited or an excessive load voltage has been sourced between the output terminals when a current is being output.
-

4.2.2 4–20 mA Function

You can set a 4–20 mA signal in 4 mA increments.

Step 1: Using the function selector switch, select *4-20mA*.

Step 2: Using each pair of  and  output setting keys, which correspond to each digit of a value from 4 to 20, set the signal in a step-by-step manner. You can set the signal in 4 mA increments or decrements in the order 4 ↔ 8 ↔ 12 ↔ 16 ↔ 18 ↔ 20 mA. Use the pairs of  and  keys for the decimals to make fine adjustments, as the keys let you set the decimals in normal resolution. Pressing the  key initializes the signal setpoint to the default value (4.00).

Step 3: Pressing the  key causes the  indicator on the LCD to change from **OFF** to **ON**. The calibrator sources the preset 4–20 mA current signal between the output terminals.

Step 4: To turn off the output, press the  key once again. The **OFF** appears on the LCD and the output terminals are open-circuited.

TIP



If the signal setpoint is 3 mA or less, no step-by-step setting is possible even if you operate the higher-order output setting keys.

4.2.3 20 mA SINK Function

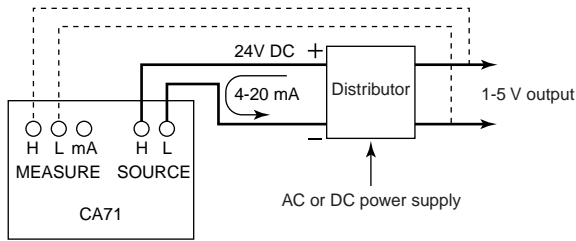
The 20 mA SINK function can draw a preset amount of current from an external voltage source to the H terminal. Thus, you can use the calibrator in a loop test, for example, as a simulator for two-wire transmitters. In that case, use this function within the 5 to 28 V range of applied voltages. The minimum value of the range for the 20 mA SINK function is 0.1 mA. You can test the I/O signals of a distributor by wiring the calibrator as indicated by the dashed lines in the following figure.



Drawing SINK Current

- Step 1:** Before connecting to the terminals, select 20mA SINK with the source range setting rotary switch.
- Step 2:** Connect the positive terminal of an external power source to the H output terminal and the negative terminal to the L output terminal.
- Step 3:** Turn on the external power source and press the  key. The **SOURCE** indicator on the LCD changes from **OFF** to **ON**. The calibrator sources the preset current value of the 20 mA SINK function between the output terminals.
- Step 4:** To turn off the output, press the  key once again. The **OFF** appears on the LCD and the output terminals are open-circuited.

4.2.4 Using As 24-V Loop Power Supply

A maximum load current of 22 mA can be drawn from the calibrator by selecting the 30 V range and setting the sourced voltage to 24 V. With this function, you can use the calibrator as a loop power supply in place of the distributor in a two-wire loop, as shown in the following figure. Thus, you can measure a 4–20 mA current signal. Using the supplied terminal adapter (P/N: 99021) makes it easy to wire the calibrator for this application.

NOTE

Since the function discussed above requires a significant amount of DC current (22 mA), operation on batteries will reduce the battery life considerably. To avoid this problem, operate the calibrator on the AC adapter. In this application, no source output other than 24 V can be taken at the same time.

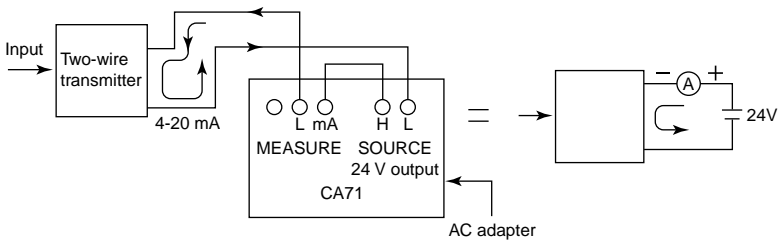

Using As a Loop Power Supply

4.3 Sourcing Resistance or RTD Signal







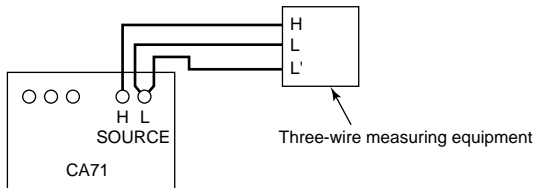





- The calibrator sources a resistance signal by 1) receiving the resistance-measuring current I supplied from the device being calibrated, such as a resistance meter or RTD thermometer, and 2) delivering the voltage $V = R \times I$ proportional to the preset resistance R between the output terminals, and 3) thus producing the equivalent resistance $R = V/I$. Consequently, the calibrator sources the signal correctly only for such devices that employ this method of measurement.
- The allowable range of the resistance measuring current I that the calibrator receives from a resistance measuring device under calibration is rated as 0.1 to 5 mA. Note, however, that accuracy lowers for resistance measuring currents smaller than 0.5 mA. For further details, see Chapter 12, “Specifications.”
- Any resistance signal being sourced does not include the resistance component of the lead cables for source. The calibrator is adjusted so that the signal has a resistance value as viewed from the output terminals. The whole resistance, when measured at the ends of the lead cables for source, is given by adding the resistance of the lead cables themselves (approximately 0.1Ω on a round-trip basis) to the sourced resistance signal. For source of precise resistance signals, use three-wire connection.
- If capacitance between the terminals of a device under calibration is greater than $0.1 \mu\text{F}$, the calibrator may fail to source correct resistance signals.

◆ Output Method Based on Three-wire Connection

Attach another lead cable to the L output terminal, as shown in the following figure. The output is provided through the three wires, H, L and L'. Connect these three wires to the device being calibrated.













4.3 Sourcing Resistance or RTD Signal

- Step 1:** Using the function selector switch, select *400Ω RTD*.
- Step 2:** Using the  key, select the range. Pressing the  key cycles through the 400 Ω, PT100 and JPT100 options.
- Step 3:** Set the output value digit by digit using each pair of  and  keys. Each press of the  or  key increases or decreases the digit. Increasing the digit from 9 or decreasing it from 0 causes the digit to overflow or underflow, allowing you to set the output value without interruption. Holding down the  or  key continuously changes the digit in question. Pressing the  key initializes the output setpoint to the default value (0).
- Step 4:** Pressing the  key causes the  indicator on the LCD to change from **OFF** to **ON**. The calibrator sources the preset resistance value between the output terminals.
- Step 5:** To turn off the output, press the  key once again. The **OFF** appears on the LCD and the output terminals are open-circuited.

4.4 Sourcing Thermocouple (TC) Signals

4.4.1 When RJ Sensor Is Used (Making Use of Reference Junction Compensation)

To calibrate a device with built-in reference junction temperature compensation by sourcing a thermoelectromotive force with the calibrator without using any external 0°C reference junction compensation means, use the optional RJ sensor (P/N: B9108WA).

- Step 1:** Insert the RJ sensor into the R.J.INPUT connector of the calibrator. Insert the sensor until the locking claw in the bottom of the sensor connector locks with a click. To unplug the sensor connector, unlock the connector by gently pushing the locking claw.
- Step 2:** Using the function selector switch, select *100mV TC*.
- Step 3:** Using the  key, select the type of thermocouple. Select the type from K, J, E, T, R, B, S, N, L and U. The selected type of thermocouple is shown on the LCD.
- Step 4:** When the RJ sensor is connected, the calibrator goes into the RJ ON status and the **RJON** symbol appears on the LCD.
- Step 5:** Set the output value digit by digit using each pair of  and  output setting keys. Each pair of  and  keys corresponds to each digit of the LCD reading. Each press of the  or  key increases or decreases the digit. Increasing the digit from 9 or decreasing it from 0 causes the digit to overflow or underflow, allowing you to set the output value without interruption. Holding down the  or  key continuously changes the digit in question. Pressing the  key initializes the output setpoint to the default value (600°C for a type-B thermocouple).

4.4 Sourcing Thermocouple (TC) Signals

Step 6: Pressing the  key causes the **SOURCE** indicator on the LCD to change from **OFF** to **ON**. A thermoelectromotive force based on the temperature detected by the RJ sensor develops between the output terminals.

Step 7: To turn off the output, press the  key once again. The **OFF** appears on the LCD and the output terminals are open-circuited.



NOTE

- **When you have attached the RJ sensor to the device being calibrated, wait until the detected temperature stabilizes before you begin using the calibrator.**
 - **If no reference junction compensation is required, be sure to remove the RJ sensor from the calibrator.**
-
-

TIP



As a means of easily providing reference junction compensation without using any external RJ sensor, you can use the temperature sensor within the calibrator. For further details on how to work the temperature sensor, see Section 7.3, “Selecting the INT RJ Function.”







4.4.2 When No RJ Sensor Is Used





From the output terminals, the calibrator sources a thermoelectromotive force corresponding to the preset temperature of a selected thermocouple. The thermoelectromotive force is sourced with reference to 0°C.



Step 1: Using the function selector switch, select *100mV TC*.

Step 2: Using the  key, select the type of thermocouple. Select the type from K, J, E, T, R, B, S, N, L and U. The selected type of thermocouple is shown on the LCD.

Step 3: Set the output value digit by digit using each pair of  and  output setting keys.

Each pair of  and  keys corresponds to each digit of the LCD reading. Each press of the  or  key increases or decreases the digit. Increasing the digit from 9 or decreasing it from 0 causes the digit to overflow or underflow, allowing you to set the output value without interruption. Holding down the  or  key continuously changes the digit in question. Pressing the  key initializes the output setpoint to the default value (600°C for a type-B thermocouple).

Step 4: Pressing the  key causes the  indicator on the LCD to change from  to . A thermoelectromotive force (mV) equivalent to the preset temperature develops between the output terminals.

Step 5: To turn off the output, press the  key once again. The  appears on the LCD and the output terminals are open-circuited.

4.5 Sourcing Pulse Signals

You can source a preset type of continuous pulse train, a pulse signal with a preset frequency, or the preset number of pulses.

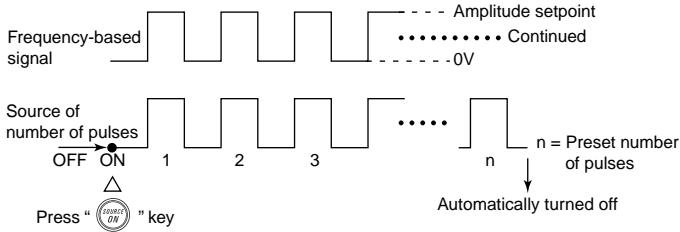

Providing Pulse Output

4.5.1 Sourcing a Continuous Pulse Train

















Step 1: Using the function selector switch, select *PULSE*. The LCD shows the default frequency 10 Hz .

Step 2: Using the **RANGE** key, set the frequency range. Pressing of the **RANGE** key cycles through the 500.0 Hz, 1000 Hz and 10 kHz options.



Step 3: Set the output value digit by digit using each pair of **▲** and **▼** output setting keys.

Each pair of **▲** and **▼** keys corresponds to each digit of the LCD reading. Each press of the **▲** or **▼** key increases or decreases the digit. Increasing the digit from 9 or decreasing it from 0 causes the digit to overflow or underflow, allowing you to set the output value without interruption. Holding down the **▲** or **▼** key continuously changes the digit in question. Pressing the **CLEAR** key initializes the output setpoint to the default value (differs depending on the frequency range).

Step 4: Pressing the **PULSE SET** key once switches to amplitude setting mode. The LCD provides a reading of 1 V .













- Step 5:** Set the output value digit by digit using each pair of  and  output setting keys. Each pair of  and  keys corresponds to each digit of the LCD reading. Each press of the  or  key increases or decreases the digit. Increasing the digit from 9 or decreasing it from 0 causes the digit to overflow or underflow, allowing you to set the output value without interruption. Holding down the  or  key continuously changes the digit in question. Pressing the  key initializes the output setpoint to the default value (0.1 V).
- Step 6:** Press the  key once again to show *cont* on the LCD. Then, press the  key one more time to revert to frequency setting mode.
- Step 7:** Pressing the  key causes the  indicator on the LCD to change from  to . The calibrator sources a continuous pulse train with the preset frequency and amplitude between the output terminals.
- Step 8:** To turn off the output, press the  key once again. The  symbol appears on the LCD and the output terminals are open-circuited.

TIP

To change the frequency range, place the calibrator in frequency setting mode with the  key. Then, change the frequency range using the  key.

4.5.2 Sourcing the Preset Number of Pulses (Pulse Cycle)

- Step 1:** Using the function selector switch, select *PULSE*. The LCD shows the default frequency 10 Hz .
- Step 2:** Using the **RANGE** key, set the frequency range. Each press of the **RANGE** key cycles through the 500.0 Hz, 1000 Hz and 10 kHz options.
- Step 3:** Set the output value digit by digit using each pair of **▲** and **▼** output setting keys.
Each pair of **▲** and **▼** keys corresponds to each digit of the LCD reading. Each press of the **▲** or **▼** key increases or decreases the digit. Increasing the digit from 9 or decreasing it from 0 causes the digit to overflow or underflow, allowing you to set the output value without interruption. Holding down the **▲** or **▼** key continuously changes the digit in question. Pressing the **CLEAR** key initializes the output setpoint to the default value (differs depending on the frequency range).
- Step 4:** Pressing the **PULSE SET** key once switches to amplitude setting mode. The LCD provides a reading of 10 V .
- Step 5:** Set the output value digit by digit using each pair of **▲** and **▼** output setting keys.
Each pair of **▲** and **▼** keys corresponds to each digit of the LCD reading. Each press of the **▲** or **▼** key increases or decreases the digit. Increasing the digit from 9 or decreasing it from 0 causes the digit to overflow or underflow, allowing you to set the output value without interruption. Holding down the **▲** or **▼** key continuously changes the digit in question. Pressing the **CLEAR** key initializes the output setpoint to the default value (0.1 V).
- Step 6:** Press the **PULSE SET** key once again to show *count* on the LCD. Then, press the **▲** key. The source setpoint reading of the LCD changes to a numeric value, which represents the number of pulses.

- Step 7:** Set the number of pulses value digit by digit using each pair of  and  output setting keys. Each press of the  or  key increases or decreases the digit. Increasing the digit from 9 or decreasing it from 0 causes the digit to overflow or underflow, allowing you to set the output value without interruption. Holding down the  or  key continuously changes the digit in question. Pressing the  key initializes the output setpoint to the default (*cont*), thus reverting to the mode of sourcing continuous pulse trains.
- Step 8:** Pressing the  key causes the  indicator on the LCD to change from  to . The calibrator sources the preset number of pulses with the preset frequency and amplitude between the output terminals.
- Step 9:** When source is complete, the calibrator automatically turns off the output and ceases operation. The  appears on the LCD and the output terminals are open-circuited.

TIP

To stop sourcing pulses halfway, press the  key when pulse output is in progress. The  appears on the LCD and the output terminals are open-circuited.

4.5.3 Using the Contact Output

You can turn on or off the output terminals. This setting is possible for both the mode of sourcing a continuous pulse train and the mode of sourcing a given number of pulses. An FET is used as the contact switching device. Since the way of using the contact output is the same for both the source of continuous pulse trains and the source of a number of pulses, this subsection only refers to the procedure for continuous pulse trains.

- Step 1:** Using the function selector switch, select *PULSE*. The LCD shows the default frequency 10 Hz .
- Step 2:** Using the RANGE key, set the frequency range. Each press of the RANGE key cycles through the 500.0 Hz, 1000 Hz and 10 kHz options.
- Step 3:** Set the output value digit by digit using each pair of Δ and ∇ output setting keys.
Each pair of Δ and ∇ keys corresponds to each digit of the LCD reading. Each press of the Δ or ∇ key increases or decreases the digit. Increasing the digit from 9 or decreasing it from 0 causes the digit to overflow or underflow, allowing you to set the output value without interruption. Holding down the Δ or ∇ key continuously changes the digit in question. Pressing the CLEAR key initializes the output setpoint to the default value (differs depending on the frequency range).
- Step 4:** Pressing the PULSE SET key once switches to amplitude setting mode. The LCD provides a reading of 10 V .
- Step 5:** Changing the reading of 10 V to 00 V with the ∇ key causes the calibrator to enter contact output mode.
- Step 6:** Press the PULSE SET key once again to show *cont* on the LCD. Then, press the PULSE SET key one more time to revert to frequency setting mode.

Step 7: Pressing the  key causes the **SOURCE** indicator on the LCD to change from **OFF** to **ON**. The output terminals turn on and off at the preset frequency.

Step 8: To turn off the output, press the  key once again. The **OFF** appears on the LCD and the output terminals are open-circuited.

 **NOTE**

-
-
- **The contact has polarities. Always connect the positive side to the H output terminal of the calibrator and the negative side to the L output terminal.**
 - **Exercise the utmost care not to allow the contact current to exceed 50 mA.**
-
-

4.6 Divided Output Function (n/m)

The divided output function (n/m) outputs a value n/m times the setpoint of a voltage, current, resistance, thermocouple or RTD signal.

Thus, the output value is defined as:

Output value = Main setpoint \times (n/m)

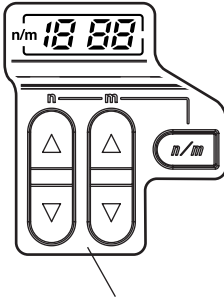

Keys and labels related to divided output function (n/m)

For details on how to set the sourced signal level of each range, see Sections 4.2, “Sourcing DC Voltage, DC Current or SINK Current Signal,” to 4.4, “Sourcing Thermocouple (TC) Signal.” Follow the steps shown below with the calibrator output turned off.



Step 1: When the setting of the sourced signal level of each range is complete, follow step 2 and later steps.

Step 2: Using each pair of Δ or ∇ keys, set the main setpoint.

Step 3: Press the $\boxed{n/m}$ key to enter the divided output (n/m) mode. The LCD shows $n/m \quad ! \square !$. The higher-order two digits represents the value of n and the lower-order two digits the value of m .

Step 4: Using a pair of Δ or ∇ keys, set the value of m . The variable m can be set to a value from 1 to 19.

Step 5: Using a pair of Δ or ∇ keys, change the value of n . An output value n/m times the main setpoint can be obtained according to the setpoint of n . The variable n can be set to a value from 0 to m .

- Step 6:** Pressing the  key causes the **SOURCE** indicator on the LCD to change from **OFF** to **ON**. The calibrator sources a (main setpoint) $\times (n/m)$ signal between the output terminals for each range selected.
- Step 7:** To turn off the output, press the  key once again. The **OFF** appears on the LCD and the output terminals are open-circuited.
- Step 8:** Pressing the  key one more time cancels the divided output (n/m) mode.

TIP

To change the main setpoint, temporarily cancel the divided output (n/m) mode. Set the main setpoint once again. Then, place the calibrator in the divided output (n/m) mode once again.

4.7 Sweep Function

The sweep function varies the output in a linear manner. For further details, see Section 7.1, “Sweep Function.”

4.8 Auto Step Function

The auto step function varies the output in a step-by-step manner. For further details, see Section 7.2, “Auto Step Function.”



4.9 Temperature Monitor Function

Using the  key, you can show the monitored temperature on the LCD, as described below.

◆ **When the Voltage, Current, Resistance or Pulse (Continuous Pulse Train or Number of Pulses) Range Is Selected**

The reading of a sourced signal remains changed to the temperature detected by the built-in temperature sensor of the calibrator as long as the  key is kept held down. Thus, you can monitor the room's temperature.

◆ **When the Temperature (Thermocouple or RTD) Range Is Selected**

- Pressing the  key once allows you to monitor the electromotive force (mV) or resistance (Ω) equivalent to the preset temperature. The monitored value does not reflect the correction made by the RJ sensor.
- Pressing the  key once again changes to the temperature detected by the RJ sensor connected to the calibrator or the internal temperature of the calibrator.
- Pressing the  key one more time reverts to the initial normal setting mode.

TIP



- In approximately 10 seconds, the temperature monitor function automatically returns to the initial normal setting mode.
 - The reading of internal temperature may become higher than the room's temperature because of a temperature rise within the calibrator. With an external RJ sensor, it is possible to measure the room's temperature more precisely.
 - For a reading of monitored temperature, the unit symbol (mV, Ω or $^{\circ}\text{C}$) blinks. Thus, you can discriminate between a setpoint and a monitored value.
-

5. Measurement

WARNING

- In an application where the calibrator is used together with the supplied lead cables for measurement, the allowable voltage to ground of the input terminals is 300 V maximum. To avoid electrical shock, do NOT use the calibrator at any voltage exceeding the maximum voltage to ground.
- The allowable voltage to ground when the supplied terminal adapter is attached to the input terminals is 30 V_{peak} maximum. To avoid electrical shock, do not use the terminal adapter for measuring any circuit voltage exceeding the maximum voltage to ground.

TIP

- With the  key, you can hold the measured value.
- When no measurement needs to be made, turn off the MEASURE mode by pressing the  key. The measured value shown on the LCD disappears and power to the internal measuring circuit is cut off. This strategy saves on battery power.
- The reading of a measured value is updated at approximately one-second intervals. If the input is overranged, the measured value on the LCD reads as - - - -.

5.1 Connecting Cables to Terminals

For DC voltage, AC voltage, resistance, frequency or pulse signal

Step 1: Connect the red lead cable for measurement (P/N: RD031) to the H input terminal and the black lead cable to the L input terminal.

Step 2: Connect the two clips of the cables to the measuring terminals of equipment under test while making sure the polarities are correct.

For DC current signal

Step 1: Connect the red lead cable for measurement (P/N: RD031) to the mA input terminal and the black lead cable to the L input terminal.

Step 2: Connect the two clips of the cables to the measuring terminals of equipment under test while making sure the polarities are correct.

For thermocouple signal (CA71 only)

Step 1: Connect the terminal adapter (P/N: 99021) to the input terminals. This will help you connect the cables easily.

Step 2: Connect between TC RTD terminals. The positive output leadwire of the thermocouple to the H terminal of the terminal adapter and the negative output leadwire to the L terminal.

For RTD signal (CA71 only)

Step 1: When using the terminal adapter (P/N: 99021), connect the H, L and L terminals of the terminal adapter to the H, L and mA terminals of the three-wire input terminal block of the calibrator, respectively.

Step 2: Connect the A, B and B output leadwires of the RTD to the H, L and L terminals of the terminal adapter, respectively.

CAUTION

- Before connecting the calibrator to the device under test, cut off the power to the device.
- Do not apply any voltage or current exceeding the allowable voltage (300 V) or current (120 mA). Otherwise, there will be a danger of not only damage to the instrument but also personal injury due to electrical shock.
- Mistaking the H voltage input terminal for the mA current input terminal, and vice versa, when wiring is extremely dangerous. NEVER make this mistake.
- The current input terminals are equipped with a built-in current input protection fuse. Overcurrent input to the terminals will cause the fuse to blow. If the fuse is blown, replace it with one (P/N: A1501EF) with the specified ratings. For details on fuse replacement, see subsection 5.2.3, "Measuring DC Current."

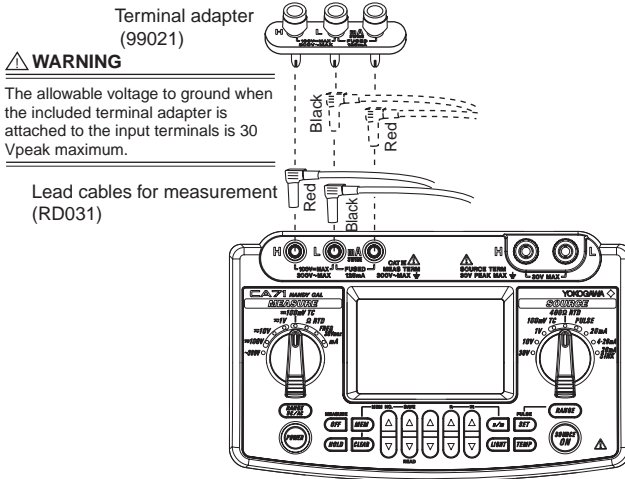

5.2 Measuring 300 V AC-range Voltage, DC Voltage, AC Voltage or DC Current

5.2.1 Measuring 300 V AC-range Voltage

 **CAUTION**

If you make a mistake in wiring or in the operating procedure in this measurement task, there will be a danger of not only damage to the instrument but also personal injury due to electrical shock. Exercise the utmost care when carrying out the measurement task.

Step 1: Make sure the lead cables for measurement are not connected to the measuring instrument under test.

Step 2: Using the function selector switch, select $\sim 300V$.

Step 3: Connect the lead cables for measurement to the measuring terminals of the measuring instrument under test.

5.2.2 Measuring DC or AC Voltage

Step 1: Using the function selector switch, select the measurement function you want to use from $\overline{\sim}100mV TC$, $\approx 1V$ $\overline{\sim}10V$ and $\approx 100V$.

Step 2: Using the  key, select either DC or AC. The DC $\overline{\sim}$ or AC \sim symbol appears on the LCD.

5.2.3 Measuring DC Current

Step 1: Using the function selector switch, select mA .

Step 2: Using the  key, select either 20 mA or 100 mA. The decimal point of the measured value shown on the LCD is repositioned.

5.2 Measuring 300 V AC-range Voltage, DC Voltage, AC Voltage or DC Current

◆ Replacing the Fuse

The current input protection fuse in the mA/3WIRE terminal is housed inside the fuse holder (labeled FUSE) on one side panel of the calibrator. To replace the fuse, first remove the fuse holder labeled FUSE by turning the holder counterclockwise with a flatblade screwdriver. Then, replace the fuse and insert the fuse holder back in place. Fasten the fuse holder by turning it clockwise. The replacement fuse is described below.

Part Number	Rating
A1501EF	125 mA/250 V, fast-acting

5.3 Measuring Resistance or RTD (CA71 only) Signal

Step 1: Using the function selector switch, select Ω *RTD*.

Step 2: Using the  key, select the range. Pressing the key cycles through the 400 Ω , Pt100 and JPt100 options.

TIP

- If you select the 400 Ω RTD range of the SOURCE mode at the same time, the RTD selected on the SOURCE mode side precedes the one selected on the MEASURE mode side. Thus, you cannot select any RTD for the Ω *RTD* range of the MEASURE mode. (CA71 only)
 - To carry out measurement based on three-wire connection, use the 3WIRE terminal.
-

5.4 Measuring Temperature with Thermocouple (TC) - CA71 only -

NOTE

Use the terminal adapter in locations where any voltage higher than 30 V will never be imposed on the measuring circuit.

Step 1: Using the function selector switch, select $\approx 100\text{mV TC}$.

Step 2: Using the  key, select the type of thermocouple. Pressing the key cycles through the 100 mV, K, E, J, T, R, B, S, N, L and U options.

TIP

- If you select the 100 mV TC range of the SOURCE mode at the same time, the thermocouple selected on the SOURCE mode side precedes the one selected on the MEASURE mode side. Thus, you cannot select any thermocouple for the 100 mV TC range of the MEASURE mode.
 - If there has been a sudden change in the operating ambient temperature of the calibrator, wait until the built-in reference junction compensation stabilizes. Avoid using the calibrator in locations exposed to wind from such apparatus as an air-conditioner.
 - If the thermocouple has burnt out, the LCD shows the $-bD-$ symbol.
-

5.5 Measuring Frequency or Pulses

5.5.1 Operating the Calibrator for Frequency Measurement

Step 1: Using the function selector switch, select *FREQ 30Vmax*.

Step 2: Using the  key, select 100 Hz, 1000 Hz or 10 kHz. Pressing the key cycles through the 100 Hz, 1000 Hz, 10 kHz, CPM and CPH options. Note however that the range reading of the LCD is given as shown below (when no signal is present).

LCD Reading	Range
000Hz	100Hz
00Hz	1000Hz
0000kHz	10kHz

5.5.2 Operating the Calibrator for Measuring Number of Pulses

The CPM option in this measurement counts pulses per minute, while the CPH option counts pulses per hour.

Step 1: Using the function selector switch, select *FREQ 30Vmax*.

Step 2: Using the  key, select either **CPM** or **CPH**. Pressing the key cycles through the 100 Hz, 1000 Hz, 10 kHz, CPM and CPH options.

Step 3: The **HOLD** indicator turns on and the calibrator goes into a standby-for-counting state. The calibrator begins counting pulses the moment the  key is pressed to cancel the hold state.

NOTE

- If you press the **⏸** key after the completion of counting while the **HOLD** indicator is lit, the calibrator restarts counting from 0.
 - If you press the **⏸** key halfway before the selected time (one minute or one hour) expires, the calibrator stops counting at that moment. The LCD shows the number of pulses counted up to the moment.
 - If the count exceeds the limit, the calibrator shows the maximum number and stops counting.
 - When counting pulses, the calibrator disables the automatic power-off feature.
-

TIP

To measure contact input, switch to that measurement function with the DIP switch in the battery holder. For further details, see Section 7.7, "Selecting the Contact In Function (Contact Input for Pulse Measurement)."

6. Memory Functions

The built-in memory has the following four functions. With a pair of sourced and measured signal values in a set, the calibrator can handle a maximum of 50 sets of data (hereinafter simply referred to as data) by means of its built-in memory.

1. Saving to Memory (MEM SAVE)

You can save data to memory.

2. Reading from Memory (MEM READ)

You can show data in memory on the LCD. When data is being read from memory, the source output remains turned off. Thus, you cannot do any source task using data stored in memory.

3. Clearing Memory (MEM CLEAR)

You can clear data stored in memory.

4. Sending Data from Memory - CA71 only -

You can send data in memory to an external personal computer using the communication function. This function requires use of the optional RS232 communication cable (P/N: 91017). For further details, see Chapter 8, "Communication Function."

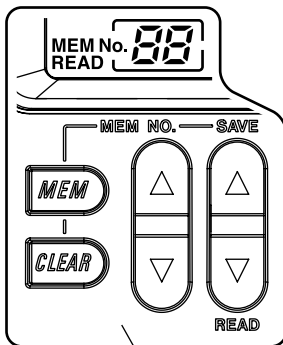



Keys and labels related to memory function

6.1 Saving Data into Memory

6.1.1 Saving Data in the Order of Memory Numbers

Step 1: Press the  key. The MEM No. indicator on the LCD turns on. At this point, the indicator shows a memory number immediately following the one most recently used to save data.

Step 2: Pressing the  key saves the sourced and measured (currently on-display) signal values at that moment into the area with that memory number (address). Executing the MEM SAVE function cancels the state of selecting memory, reverting to normal setting mode.

Step 3: To save the next data item into the area with the next memory number, press the  key once again. Now the MEM No. indicator shows a memory number one count larger than the previous one.

Step 4: Pressing the  key saves the sourced and measured (currently on-display) signal values at that moment into the area with that memory number (address) – the previous memory number (address) + 1.

TIP

To cancel the memory mode (saving/reading), press the  key one more time. (Executing the MEM SAVE function automatically cancels the memory mode.)

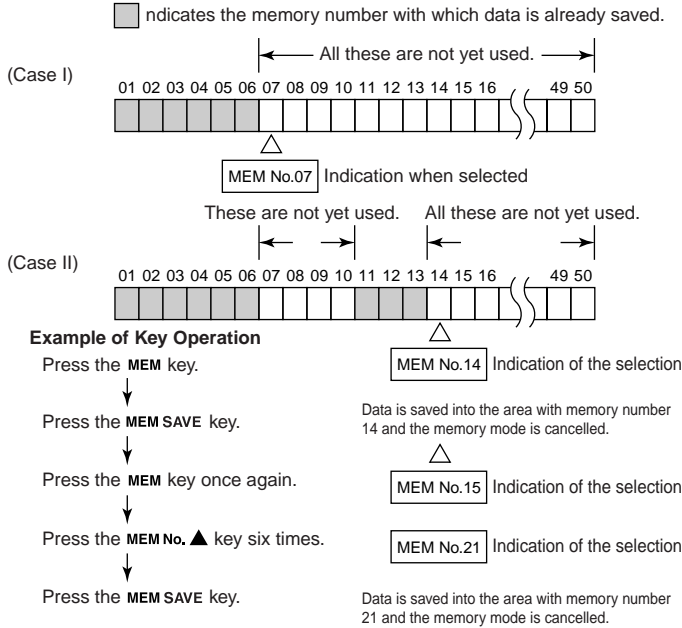

Working with the MEM SAVE Function

NOTE

- In memory mode, some of the and keys change to those for working with memory. Consequently, you cannot do the regular task of setting output values for source.
- The MEM No. indicator begins with if no data has been saved into memory. If memory contains any saved data already, a memory number immediately following the largest of the already used memory numbers is allocated to the next data, as shown in the figure discussed above, even if there is any not-yet-used memory address at some midpoint.
- In the case of the divided output function (n/m), the output value "setpoint $\times n/m$ " for source is stored in memory.

6.1.2 Saving Data by Selecting Desired Memory Number

Step 1: Press the **MEM** key. The **MEM No.** indicator on the LCD turns on.

Step 2: Using the pair of **MEM NO.** **▲** **▼** key, select the desired memory number (address).

Step 3: Pressing the **SAVE** **▲** key saves the sourced and measured (currently on-display) signal values at that moment into the area with the selected memory number (address).

TIP

To cancel the memory mode (saving/reading), press the **MEM** key one more time. (Executing the MEM SAVE function automatically cancels the memory mode.)

6.1.3 Overwriting Data in Memory

Step 1: Press the **MEM** key.

Step 2: Using the pair of **MEM NO.** **▲** **▼** key, select the desired memory number (address).

Step 3: Press the **SAVE** **▲** key. The LCD shows **rEPLACE** to alert you.

Step 4: Pressing the **SAVE** **▲** key once again overwrites the data in that memory number.

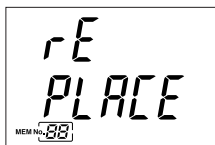

Alarm indication for memory overwriting





 **NOTE**

- To stop overwriting the data, press the  key one time. This cancels saving data, reverting to the original state of being able to save/read data to/from memory.



TIP

To cancel the memory mode (saving/reading), press the  key one more time. (Executing the MEM SAVE function automatically cancels the memory mode.)

6.2 Reading Data from Memory

- Step 1:** Press the  key once. The LCD shows MEM No. xx. At this point, the MEM No. indicator shows a memory number immediately following the one most recently used to save data. (Memory is ready for data saving.)
- Step 2:** Pressing the  key causes the on-screen READ indication to blink, indicating the calibrator is reading from memory.
- Step 3:** Using the pair of   key, select the memory number whose data you want to read. The LCD shows the data thus read out of memory. The items of the read data are shown on their respective measured-value and generated-value display areas. If the area with the memory number contains no saved data, the LCD shows - - - - .

TIP

- To cancel reading from the memory mode, press the  key or the  key one more time.
- To save data anew while reading from memory, overwrite the existing data by following step 2 in subsection 6.1.3, "Overwriting Data in Memory."

6.3 Clearing Data in Memory

6.3.1 Clearing Data by Selecting Desired Memory Number

Step 1: Press the  key once. The MEM No. indicator on the LCD turns on.

Step 2: Using the pair of MEM No.   key, select the memory number whose data you want to clear.



Step 3: Pressing the  key causes the LCD to show the alarm indication *no.88 CLEAR*.
(no.88 indicates object MEM No.)

Step 4: Pressing the  key once again clears the data with the selected memory number.

TIP

-
- To cancel clearing the data after the *CLEAR* alarm indication is given, press the  key. The calibrator reverts to memory mode (saving/reading).
 - You can also clear the data after having read it from memory.
-

6.3.2 Clearing All In-Memory Data Globally

- Step 1:** Press the  key once. The MEM No. indicator on the LCD turns on.
- Step 2:** Hold down the  key for at least five seconds. The LCD shows the ALL CLEAR alarm indication.
- Step 3:** Pressing the  key once again clears all of the data in memory.



ALL CLEAR alarm indication

TIP

- To cancel clearing the data after the ALL CLEAR alarm indication is given, press the  key. The calibrator reverts to memory mode (saving/reading).

6.4 Sending Out Data from Memory - CA71 only -

See Chapter 8, "Communication Function."

7. Functions Provided by DIP Switch

By configuring the DIP switch, you can use the functions listed below. The DIP switch can be found by removing the battery holder cover at the back of the calibrator.

CAUTION

Turn off the calibrator before you change the DIP switch configuration.

DIP Switch Position	Description	Factory Setting	
		OFF (left-side)	ON (right-side)
1 Sweep	Selects the sweep or auto-step function.	✓	
2 Speed	Changes the speed setpoint of the sweep or auto-step function.	✓	
3 INT RJ	Selects the internal reference junction compensation for TC signal generation.	✓	
4 IPTS-68	Selects the IPTS-68 temperature scale for temperature signal generation or measurement.	✓	
5 No use	Denotes the position is not used.	✓	
6 Temp	OFF	✓	
7 Contact In	Selects contact input based operation for pulse measurement.	✓	
8 Auto P off	Cancel the automatic power-off feature during battery-driven operation.	✓	

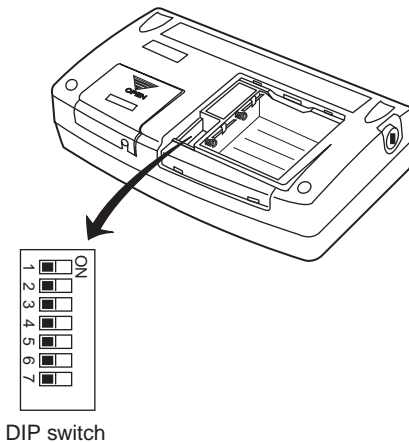





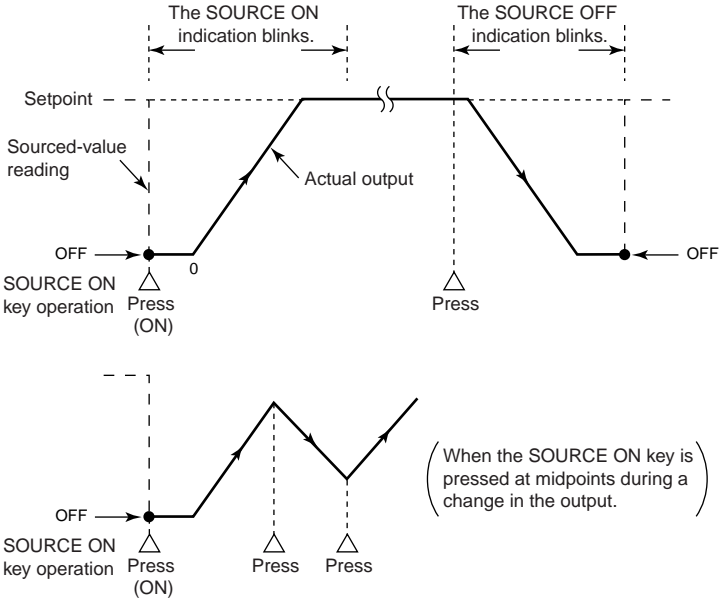



7.1 Sweep Function

The sweep function lets you linearly change the calibrator output as shown in the following figure.





Sweep Mode Operation

- Step 1:** Press the  key to turn off the calibrator.
- Step 2:** Place switch 1 (Sweep switch) in the ON (right-side) position.
- Step 3:** By setting the position of switch 2 (Speed switch), change the sweep speed.
OFF (left-side): 16 sec; ON (right-side): 32 sec
- Step 4:** Press the  key to turn on the calibrator. The LCD shows SWEEP.
- Step 5:** Using the function selector switch, select the function (voltage, current, resistance, thermocouple, or RTD) for which you want to source a signal. In the case of pulse source, the sweep function is disabled.

- Step 6:** Using the pair of  and  keys, set the upper limit of the signal to be output. The lower limit is set to a value predetermined depending on the selected range.
- Step 7:** Pressing the  key initiates sweeping and the output value begins to increase.
- The LCD shows  and the lower limit (default) for approximately two seconds. The calibrator outputs the default.
 - Then, the LCD reading and the output value begin to increase in fixed increments, up to the upper limit, in the sweep time set in the preceding steps.
 - When the output reaches the setpoint, the calibrator retains the output as is, and automatically holds sweep operation.
- Step 8:** Pressing the  key once again causes the output value to begin decreasing. The output value decreases down to the lower limit in the same amount of time it took to increase up to the upper limit. When the output reaches the lower limit, the calibrator retains the output as is for approximately three seconds, and then automatically turns it off. Thus, one cycle of sweeping is completed.
- Step 9:** To quit the sweep function, turn off the calibrator by pressing the  key.
- Step 10:** Place switch 1 back in the OFF (left-side) position to disable the sweep function.

NOTE



- When the output reaches the lower limit, the calibrator retains the output as is for three seconds, and then turns it off. Thus, one cycle of sweeping is completed.
- To alter the direction in which the output changes, press the  key when sweeping is in progress (LCD reading is changing). The calibrator alters the direction of change and continues sweep operation. For example, pressing the  key during an increase in the output causes the output to begin decreasing.

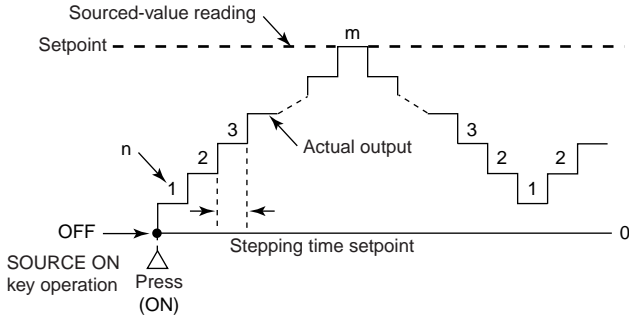

7.2 Auto Step Function

The auto step function automatically changes the variable n of the n/m output in a step-by-step manner, as shown in the following figure, when the divided output function (n/m) is selected.



Auto Step Operation (when the default of n is set to 1)

- Step 1:** Press the  key to turn off the calibrator.
- Step 2:** Place switch 1 (Sweep switch) in the ON (right-side) position.
- Step 3:** By setting the position of switch 2 (Speed switch), set the time of one step.
OFF (left-side): 2.5 sec/step; ON (right-side): 5 sec/step
- Step 4:** Press the  key to turn on the calibrator.
- Step 5:** Using the function selector switch, select the function (voltage, current, resistance, thermocouple, or RTD) for which you want to source a signal. In the case of pulse source, the auto step function is disabled.
- Step 6:** Set the output value.
- Step 7:** Press the  key. The SWEEP indication on the LCD changes to AUTO STEP and the n/m symbol turns on.

Step 8: Using each pair of  and  keys, set the value of the denominator m and the starting setpoint of the enumerator n . (See Section 4.6, "Divided Output Function (n/m)", for further details.) The starting setpoint is the minimum of the variable n for auto step operation.



Step 9: Pressing the  key initiates the automatic stepping of the divided output (n/m), as described below.

Assuming the starting value of the variable n is 1, the output cyclically changes with the variable n as n changes in the following manner.

$$n = 1 \rightarrow 2 \rightarrow 3 \rightarrow \dots (m-1) \rightarrow m \rightarrow (m-1) \rightarrow \dots \rightarrow 2 \rightarrow 1 \rightarrow 2 \rightarrow 3 \rightarrow \dots$$

Step 10: To quit the auto step function, turn off the calibrator by pressing the  key. Place switch 1 back in the OFF (left-side) position. Note that disabling the divided output mode (n/m) before placing switch 1 back in the OFF position enters sweep mode.

TIP

- Pressing the  key to change to the SOURCE OFF state pauses the auto step operation.
- To execute the auto step function again, press the  key. The auto step operation resumes from the value of n shown on the LCD.

7.3 Selecting the INT RJ Function

The INT RJ function provides reference junction compensation for thermoelectromotive force source in a simplified manner by means of the calibrator's built-in temperature sensor. For more precise reference junction compensation, it is advisable that you use the optional RJ sensor (P/N: B9108WA).

Step 1: Press the  key to turn off the calibrator.

Step 2: Place switch 3 (INT RJ switch) in the ON (right-side) position. The calibrator detects temperature using its built-in temperature sensor and outputs reference junction-compensated thermoelectromotive force appropriate for the detected temperature.

Step 3: To disable the INT RJ function, turn off the calibrator by pressing the  key.

Step 4: Place switch 3 back in the OFF (left-side) position.

TIP

Even when the INT RJ function is selected, the temperature detected by an external RJ sensor precedes any other measured temperature if you plug the sensor into the RJ INPUT connector.

7.4 Selecting the IPTS-68 Function

By placing switch 4 (IPTS-68 switch) in the ON (right-side) position, you can select the IPTS-68 temperature scale when you choose the type-K, E, J, T, N, R, S or B thermocouple or the Pt100 RTD. Placing the switch in the OFF position results in the selection of the ITS-90 temperature scale.

TIP

When you have selected a type of thermocouple or RTD, the LCD shows IPTS-68.

7.5 Switch Not Used

Although switch 5 (No Use switch) of the DIP has no effect on calibrator operation, the switch should be placed in the OFF (left-side) position.

7.6 Temp Switch

Check that the switch should be placed in the OFF position.

7.7 Selecting the Contact In Function (Contact Input for Pulse Measurement)

By placing switch 7 (Contact In switch) in the ON (right-side) position, you can measure transistor contact on-off signals. If you select the contact input function, the  (contact) symbol appears on the LCD. By placing the switch in the OFF position, you can measure normal pulse.

7.8 Disabling the Automatic Power-off Feature

By placing switch 8 (Auto P Off switch) in the ON (right-side) position, you can disable the automatic power-off feature and continue using the calibrator. (See the paragraph "Automatic Power-off" in Chapter 3, "Before Starting Source/Measurement," for further details.)

NOTE

If you have disabled the automatic power-off feature, be sure to turn off the POWER switch when you finish using the instrument in order to prevent unusual battery power consumption.

8. Communication Function - CA71 only -

You can configure the calibrator from a personal computer just as you do with the calibrator's panel keys (except for turning on/off the power, configuring the function selector switch, and setting the communication function). You can also verify the setpoint, measured value and status of the calibrator.

NOTE

- With the optional communication cable (P/N: 91017), you can use the RS232 serial port (9-pin D-sub) of a personal computer or any other equipment.
- In talk-only or printer mode, you can output the source setpoint and measured value at preset intervals.

8.1 Cables Connection and Interface Specifications

◆ Connecting Communication Cable

Remove the I/O port cover at the back of the calibrator and connect the communication cable (P/N: 91017) to the I/O port.

◆ Setting RS232 Parameters

Baud rate:	9600 baud
Parity:	None
Stop bits:	2
Data length:	8 bits
Flow control:	None (Xon/Xoff control for printing only)
Delimiter:	Fixed to CrLf

8.2 Setting the Mode

- Step 1:** Press the **SET** key while simultaneously holding down the **HOLD** key. The LCD shows *Chan* in its upper section and either *nor*, *talk* or *Print* in its lower section.
- Step 2:** Using the pair of **▲** and **▼** keys, select *nor*, *talk* or *Print*.
- Step 3:** Press the **SET** key to confirm your mode selection. If you set the mode to *talk* or *Print*, the LCD shows *SEC 0*. When the *SEC 0* is indicated, each press of the **HOLD** key outputs one data item.
- Step 4:** If you set any value using the pair of **▲** and **▼** keys with *SEC 0* shown, the calibrator outputs data using the value thus set as the time interval (sec). The value should be set within the range from 0 to 3600.

TIP

- To close the communication setting screen, press the **SET** key once again while simultaneously holding down the **HOLD** key.
 - Even if you turn off the calibrator, the communication mode and interval you have set are saved internally until you replace the batteries or reconfigure the communication function. Thus, communication will take place with the previous settings.
-

8.3 Types of Mode

- nor*: Normal mode – Permits normal transmission and reception.
- talk*: Talk-only mode – Outputs the source setpoint and measured value at preset intervals (0* to 3600 sec).
- Print*: Printer mode – Outputs the source setpoint and measured value to a printer at preset intervals (0* to 3600 sec).

- *: For a 0-second interval, each press of the **HOLD** key outputs one data item. For other intervals, pressing the **HOLD** key initiates or terminates communication.

TIP

When communication is in progress, the **HOLD** indicator blinks, telling you data is being output. Care must be taken therefore, since the hold function of the MEASURE mode is disabled if you select *tAnLy* or *PrInT*.

8.4 Data Format

Data is output from the calibrator in the following format.

Source:	Function	1V
	Range	DC V
	Data	1.0000
Measure:	Function	100 mV
	Range	k
	Data	25.5C

8.5 Data Structure

The calibrator's program has the following data structure.

Command + Parameter + Delimiter

Command: Defined by one to three alphabetical upper-case letters.

Parameter: A string of ASCII-code numerals or characters.

Delimiter: Fixed to CrLf.

8.6 Commands

BL	Turns the back lighting on and off /queries the current setting.
DW	Moves down the "m-th" digit of the sourced setpoint by one digit.
UP	Moves up the "m-th" digit of the sourced setpoint by one digit.
H	Enables/Disables the output data header /queries the current setting.
HD	Enables/Disables data hold mode/queries the current setting.
MF	Queries the measurement function.
MO	On/Off of measurement/queries the current setting.
MR	Sets the measuring range/queries the current setting.
OD	Outputs measured value.
OE	Outputs error information.
OR	Queries whether an external RJC sensor is connected.
OS	Outputs the setting information.
SD	Sets sourced setpoint/queries the current setting.
SF	Queries the source function.
SO	On/Off of source output/queries the current setting.
SR	Sets the sourcing range/queries the current setting.
SY	Switches between the normal and adjustment modes/queries the current setting.
CD	Sets the sourced setpoint/queries the current setting.
CL	Sets the adjustment item/queries the current setting.
CP	Sets the adjustment point.
CW	Saves the adjusted data.
CMF	Queries the measurement function.
CSF	Queries the source function.
OM	Queries memory data.
NM	Sets divided output (<i>n/m</i>) mode/queries the current setting.
ND	Sets <i>n/m</i> values in divided output (<i>n/m</i>) mode/queries the current setting.
TE	Sets the temperature monitor display for sourced TC/RTD range/queries the current setting. (TC, RTD mode only)
PU	Sets the display for sourced pulse range/queries the current setting.

8.7 Detailed Description of Commands

BL	Turns the back lighting on and off /queries the current setting.	When normal condition
Syntax for setting BLm<delimiter>		
Syntax for query BL?<delimiter> ⇒ Response: BLm<delimiter>		
Description of parameter m=0: Off m=1: On		
DW	Moves down the "m-th" digit of the sourced setpoint by one digit.	When normal condition
Syntax for setting DWM<delimiter>		
Description of parameter m: Specifies a digit 1 (the lowest digit) to 5 (the highest digit)		
UP	Moves up the "m-th" digit of the sourced setpoint by one digit.	When normal condition
Syntax for setting UPm<delimiter>		
Description of parameter m: Specifies a digit 1 (the lowest digit) to 5 (the highest digit)		
H	Enables/Disables the output data header/queries the current setting.	When normal condition/adjustment
Syntax for setting Hm<delimiter>		
Syntax for query H?<delimiter> ⇒ Response: Hm<delimiter>		
* For details on the header, see the OD command.		
Description of parameter m: Enables/Disables the header m=0: Disabled m=1: Enabled		
HD	Enables/Disables data hold mode/queries the current setting.	When normal condition
Syntax for setting HDm<delimiter>		
Syntax for query HD? <delimiter> ⇒ Response: HDm (delimiter)		
Description of parameter m: Specifies data hold m=0: Hold Off m=1: Hold On		

8.7 Detailed Description of Commands

MF	Queries the measurement function.	When normal condition
Syntax for query MF? <delimiter> ⇒ Response: MFm<delimiter>		
Description of parameter m: Measurement function m=0: 300V AC m=1: 100V m=2: 10V m=3: 1V m=4: 100mV m=5: Resistance m=6: Frequency m=7: Current		
MO	On/Off of measurement/queries the current setting.	When normal condition/adjustment
Syntax for setting MOm<delimiter>		
Syntax for query MO?<delimiter> ⇒ Response: MOm<delimiter>		
Description of parameter m: On/Off condition m=0: Off m=1: On		
MR	Sets the measuring range/queries the current setting.	When normal condition/adjustment
Syntax for setting MRm<delimiter>		
Syntax for query MR? <delimiter> ⇒ Response: MRm<delimiter>		
Description of parameter m: Measuring range [100V] m=0: DC m=1: AC [10V] m=0: DC m=1: AC [1V] m=0: DC m=1: AC [100mV] (When normal condition) m=0: 100mV DC m=1: TcK m=2: TcE m=3: TcJ m=4: TcT m=5: TcR m=6: TcB m=7: TcS m=8: TcN m=9: TcL m=10: TcU [100mV] (When adjustment) m=0: 100mV DC m=1: TcK m=2: TcE m=4: TcT [Ω] m=0: 400 Ω m=1: Pt100 m=2: JPt [Freq] m=0: 100Hz m=1: 1kHz m=2: 10kHz [mA] m=0: 20mA m=1: 100mA		

8.7 Detailed Description of Commands

OD	Outputs measured value.	When normal condition/adjustment
Syntax for setting OD<delimiter> ⇒ Response: ODabcde<delimiter>		
Description of parameter <Header section> (Output only when the header is set to "enabled".) a= V: Voltage A: Current O: Resistance T: Temperature F: Frequency b= DC: Direct current AC: Alternating current c= N: Normal O: Overrange E: No data <Data section> d = Measured value, mantissa part (7 digits) e = Measured value exponent part (E-3 / E+0 / E+3) de = 99999. E+3 when overrange occurs or no data reside.		
OE	Outputs error information.	When normal condition/adjustment
Syntax for setting OE<delimiter> ⇒ Response: ERRm<delimiter>		
Description of parameter m: Error information m=00: No error m=11: Received command not used in this instrument m=12: Specified parameter value is outside allowed range. m=13: Attempt made to execute a command that is not permitted in a certain status of the instrument. m=16: An error was received during adjustment.		
OR	Queries whether an external RJC sensor is connected.	When normal condition
Syntax for query OR<delimiter> ⇒ Response: m		
Description of parameter m: Connecting condition of external RJC m=0: Not connected m=1: Connected		
OS	Outputs the setting information.	When normal condition
Syntax for setting OS<delimiter> Response Measure m<CrLf> m= On/Off Function m<CrLf> m= Measurement function Range m<CrLf> m= Measuring range Source m<CrLf> m= On/Off Function m<CrLf> m= Source function Range m<CrLf> m= Source range Data m<CrLf> m= Sourced setpoint Light m<CrLf> m= On/Off		

8.7 Detailed Description of Commands

SD	Sets sourced setpoint/queries the current setting.	When normal condition
Syntax for setting SDm<delimiter> Syntax for query SD?<delimiter> ⇒ Response: SDm<delimiter>		
Description of parameter m: Sourced setpoint (7 digits) ex. +1.0000		
SF	Queries the source function.	When normal condition
Syntax for query SF? <delimiter> ⇒ Response: SFm<delimiter>		
Description of parameter m: Function m=0: 30V m=1: 10V m=2: 1V m=3: 100mV m=4: Resistance m=5: Pulse m=6: 20mA m=7: 4 to 20mA m=8: 20mASINK		
SO	On/Off of source output/queries the current setting.	When normal condition/adjustment
Syntax for setting SOM<delimiter> Syntax for query SO? <delimiter> ⇒ Response: SOM<delimiter>		
Description of parameter m: Condition of generation m=0: Off m=1: On		
SR	Sets the sourcing range/queries the current setting.	When normal condition/adjustment
Syntax for setting SRm<delimiter> Syntax for query SR?<delimiter> ⇒ Response: SRm<delimiter>		
Description of parameter m: sourcing range [100mV] (When normal condition) m=0: DC 100mV m=1: TcK m=2: TcE m=3: TcJ m=4: TcT m=5: TcR m=6: TcB m=7: TcS m=8: TcN m=9: TcL m=10: TcU [100mV] (When adjustment) m=0: DC 100mV m=1: TcK [Ω] m=0: 400Ω m=1: Pt100 m=2: JPt [Freq] m=0: 500Hz m=1: 1kHz m=2: 10kHz		

8.7 Detailed Description of Commands

SY	Switches between the normal and adjustment modes/queries the current setting.	When normal condition/adjustment
Syntax for setting SYm<delimiter> Syntax for query SY?<delimiter> ⇒ Response: SYm<delimiter>		
Description of parameter m: Mode m=0: Normal mode m=1: Adjustment mode		
CD	Sets the sourced setpoint/queries the current setting.	When adjustment
Syntax for setting CDm<delimiter> Syntax for query DC? <delimiter> ⇒ Response: DCm<delimiter>		
Description of parameter m: Sourced setpoint (8 digits) ex. +1.00003		
CL	Sets the adjustment item/queries the current setting.	When adjustment
Syntax for setting CLm<delimiter> Syntax for query CL?<delimiter> ⇒ Response: CLm<delimiter>		
Description of parameter m: Adjustment item m=3: Adjustment of source m=4: Adjustment of measurement		
CP	Sets the adjustment point.	When adjustment
Syntax for setting CPm<delimiter>		
Description of parameter m: Adjustment point m=0: FS adjustment m=1: Zero adjustment		
CW	Saves the adjusted data.	When adjustment
Syntax for setting CW<delimiter> Be sure to execute CW command after adjustment for each function/range. Without executing CW command, the adjusted value will be deleted when the power is turned off.		

8.7 Detailed Description of Commands

CMF	Queries the measurement function.	When adjustment
Syntax for query CMF?<delimiter> ⇒ Response: CMFm<delimiter>		
Description of parameter m: Measurement function m=0: AC 300V m=1: 100V m=2: 10V m=3: 1V m=4: 100mV m=5: Resistance m=6: Frequency m=7: Current		
CSF	Queries the source function.	When adjustment
Syntax for query CSF?<delimiter> ⇒ Response: CSFm<delimiter>		
Description of parameter m= Function m=0: 30V m=1: 10V m=2: 1V m=3: 100mV m=4: Resistance m=5: Pulse m=6: 20mA m=7: 4-20mA m=8: 20mASINK		
OM	Queries memory data.	When normal condition
Syntax for query OMm<delimiter> Response: abcde, fghij [, fghij] <delimiter> <Header section of measured value> a= V: Voltage A: Current O: Resistance T: Temperature F: Frequency b= DC: Direct current AC: Alternating current c= N: Normal O: Overrange E: No data <Data section of measured value> d = Measured value, mantissa part (7 digits) e = Measured value exponent part (E-3 / E+0 / E+3) <Header section of sourced setpoint> f= V: Voltage A: Current O: Resistance T: Temperature F: Frequency g= DC: Direct current AC: Alternating current h= N: Normal E: No data i = Sourced setpoint, mantissa part (7 digits) j = Sourced setpoint exponent part (E-3 / E+0 / E+3)		
Description of parameter m: Number of memory 1 to 50		

9. Troubleshooting

■ Failure Checklist

Troubleshoot the cause of any problem using the following checklist. Should the problem persist even if you have taken the given corrective action or if you notice any problem not listed herein, contact the vender from which you purchased the instrument.

Problem	Corrective Action
The LCD shows nothing even if the POWER switch is turned on.	<ul style="list-style-type: none">– When the calibrator is operated on batteries<ul style="list-style-type: none">• Make sure the batteries are securely housed in the holder.• Check if the batteries are too low.• Check if the AC adapter plug is inserted to the calibrator but the adapter is not connected to the AC power source.– When the calibrator is operated on AC adapter<ul style="list-style-type: none">• Check if the AC adapter is reliably supplied with electricity.
The LCD shows everything except for the measured value.	<ul style="list-style-type: none">• Check if the MEASURE OFF key for turning on/off the MEASURE mode is set to OFF.
The SOURCE indicator remains set to OFF even if the SOURCE ON key is operated for signal source.	<ul style="list-style-type: none">• When in voltage signal source, check if the load current is beyond the specified limits.• When in current signal source, check if the load resistance is too large.
The output cannot be turned on for signal source, or no signal is output even if the output is turned on.	<ul style="list-style-type: none">• The built-in fuse may blow off if any abnormal voltage level is applied to the output terminals. If this is the case, the calibrator needs repair.
The measured and sourced signal values are abnormal.	<ul style="list-style-type: none">• Check if the signal carries noise.• When in resistance signal source, check if the input stage of the device under test contains a capacitor with an excessively large capacitance.
The calibrator cannot be configured or controlled via RS232 interface-based communication.	<ul style="list-style-type: none">• Make sure the communication parameter settings are correct.
The hold function of the MEASURE mode does not work at all.	<ul style="list-style-type: none">• Check if the communication mode is set to <i>tonLy</i> or <i>Print</i>.
The LCD shows Err60 at power-on.	<ul style="list-style-type: none">• The calibrator needs repair.

10. Method of Calibrator Adjustment

To maintain the calibrator at high accuracy levels, it is advisable that the calibrator be calibrated once a year. If the calibrator needs to be readjusted, follow the procedure described below. For a service of calibration or readjustment, contact the vender from which you purchased the instrument.

10.1 Calibration Standard Selection and Environmental Requirements

◆ Selection of Calibration Standard

Select an appropriate calibration standard having the ranges shown in the following table and accuracy levels equal to or higher than those shown in the table.

Source Functions

Function to Be Adjusted	Standard's Name	Range to Be Adjusted	Measuring Range	Accuracy	Remarks
DCV	Digital multimeter (DMM)	100 mV 1 V 10 V 30 V	110 mV 1.1 V 11 V 33 V	$\pm(0.002\% + 1.5 \mu\text{V})$ $\pm(0.002\% + 10 \mu\text{V})$ $\pm(0.002\% + 100 \mu\text{V})$ $\pm(0.002\% + 1 \text{ mV})$	
DCA	Note: Also use a 100 Ω standard resistor for the DCA and SINK functions and a high-precision 5 mA current source for the $\Omega/5$ mA function.	20 mA	22 mA	$\pm(0.002\% + 0.3 \mu\text{A})$	Measure the current with the DMM's mA range or measure the voltage drop across the 100 Ω standard resistor with the DMM's voltage range.
SINK		20 mA	20 mA	$\pm(0.002\% + 0.3 \mu\text{A})$	DMM's resistance range (1 mA)
$\Omega/1$ mA		400 Ω	440 Ω	$\pm(0.0025\% + 0.01 \Omega)$	High-precision current source (5 mA)
$\Omega/5$ mA		400 Ω	2.2 V/5 mA	$\pm(0.0025\%)$ $\pm(0.0025\%)$	DMM's voltage range

10.1 Calibration Standard Selection and Environmental Requirements

Measurement Functions

Function to Be Adjusted	Standard's Name	Range to Be Adjusted	Measuring Range	Accuracy	Remarks
DCV	High-precision calibrator	100 mV	100 mV	$\pm(0.0025\% + 1 \mu\text{V})$	
		1 V	1 V	$\pm(0.0025\% + 20 \mu\text{V})$	
DCA		10 V	10 V	$\pm(0.0025\% + 0.2 \text{ mV})$	
		30 V	30 V	$\pm(0.005\% + 2 \text{ mV})$	
DCA		20 mA	20 mA	$\pm(0.0025\% + 0.4 \mu\text{A})$	
		100 mA	100 mA	$\pm(0.004\% + 3 \mu\text{A})$	
Ω	Decade resistance box	—	400 Ω	$\pm(0.01\%)$	
ACV	AC calibrator or AC voltage source	1 V	1 V	$\pm(0.08\% + 0.015\%)$	
		10 V	10 V		
		100 V	100 V		
		300 V	300 V		

◆ Environmental Requirements

Ambient temperature: $23 \pm 1^\circ\text{C}$

Relative humidity: 45 to 75%

Warm-up: Before use, warm up the calibration standard for the period of time specified for the standard.

The **SOURCE** indicator blinks when any source function is being operated.

Auxiliary-digit indicator
(The value should be read as 400.000.)

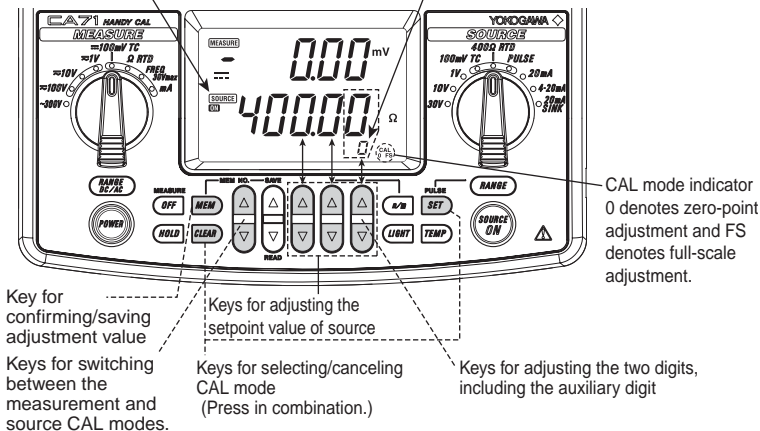

CAL-mode Operation keys and Display Indications

10.2 Adjusting Source Functions

Table 10.1 Adjustment Points of Source Functions

Range	Adjustment Points ^{*1}		Remarks
	CAL 0	CAL FS	
100 mV	0	100 mV	
1 V	0	1 V	
10 V	0	10 V	
30 V	0	30 V	
20 mA	0	20 mA	See the figure below.
20 mA SINK	0.1 mA	20 mA	See the figure below.
400 Ω/1 mA	0	400 Ω	Four-wire connection
400 Ω/5 mA	0	400 Ω	See the figure below.

*1: Adjust the source functions so that the readings of the calibration standard (output values of the CA51/71) match the adjustment points listed above.

TIP

- You can also select only the range in need of readjustment to adjust it separately.
- Always make zero-point (0) adjustments together with full-scale (FS) adjustments.

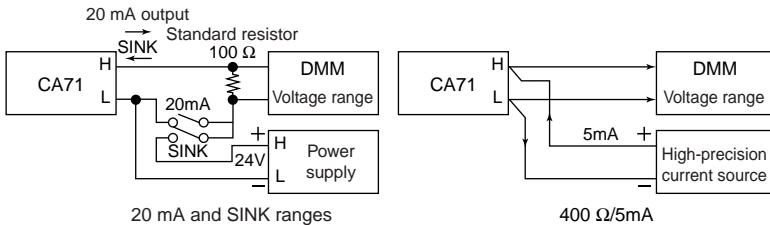

20 mA and SINK ranges

400 Ω/5mA

Hook-ups for Adjustment

Step 1: Press the **SET** key while simultaneously holding down the **CLEAR** key. The LCD shows **CAL SRC**.

Step 2: Pressing the **SET** key enters the source CAL mode. The **SOURCE** indicator blinks on the LCD and the **CAL** symbol appears. The calibrator is now ready for the zero-point adjustment of source functions.

Step 3: From Table 10.1, select the range you want to adjust. Then, point the function selector switch to that range and press the



key.

10.2 Adjusting source Functions

- Step 4:** Conform that the 0^{CAL} symbol is appearing on the LCD.
- Step 5:** Read the calibrator output on the calibration standard. Then, using the lowest-order pair of Δ and ∇ keys, adjust the reading so that it matches the given CAL 0 adjustment setpoint in Table 10.1. In the CAL mode, the lowest-order pair of Δ and ∇ keys are used to increase or decrease the least-significant two digits, including the auxiliary digit. Adjust the value measured with the calibration standard to the given adjustment setpoint in Table 10.1.
- Step 6:** Press the \boxed{MEM} key to confirm the CAL 0 adjustment setpoint. The CAL indicator on the LCD changes to 0^{CAL} , setting the calibrator ready for full-scale adjustment.
- Step 7:** Using the lowest-order pair of Δ and ∇ keys, adjust the reading of the calibration standard so that it matches the given CAL FS adjustment setpoint in Table 10.1.
- Step 8:** Press the \boxed{MEM} key to confirm the CAL FS adjustment setpoint. The **0** and **FS** symbols on the LCD blink.
- Step 9:** Pressing the \boxed{MEM} once again saves the adjustment setpoint in memory.
- Step 10:** The **0** and **FS** symbols stop blinking, causing the calibrator to return to the state discussed in step 4. Using the function selector switch, select the next range. By repeating steps 4 to 9, you can adjust the source function assigned to that range.

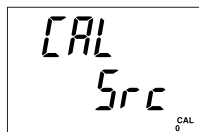

NOTE

-
- **Saving to memory results in the overwriting of existing data. Be extremely careful since the previous adjustment setpoints are cleared.**
 - **Both the thermocouple and RTD ranges are adjusted at the same time when the 100 mV and 400 Ω ranges are adjusted.**
-

TIP

With the CAL mode selected, press the **[OFF]** key while holding down the **[ZLDR]** key. This key operation cancels the CAL mode (the same key operation as for selecting the CAL mode). You can use the same key operation to cancel the CAL mode during adjustment, before saving to memory.

CAUTION

– Precautions when adjusting the 400 Ω range for resistance signal source

(1) Internal Offset Adjustment

When setting a resistance of 0.00 Ω , make sure the voltage between the H and L terminals is within $\pm 20 \mu\text{V}$. If the voltage is beyond the limits, internal adjustments must be made. Contact the vendor from which you purchased the instrument.

(2) Notes on Resistance-measuring Current

Adjusting the 400 Ω range requires drawing two types of resistance-measuring current – 1 mA and 5 mA – from an external device. Adjust the range separately for each of these currents.

Adjustment for 1 mA

This adjustment is possible with the resistance measuring range of the calibration standard (digital multimeter). At this point, make sure the resistance-measuring current is 1 mA.

Adjustment for 5 mA

Like the method of adjusting the 400 Ω /5 mA range shown in the figure (Hook-ups for Adjustment) on page 10-3, you can make this adjustment by applying the reference current of 5 mA from the external device and then measuring the resulting voltage drop.

10.3 Adjusting Measurement Functions

Table 10.2 Adjustment Setpoints of Measurement Functions

Range	Adjustment Setpoint ^{*2}		Remarks
	CAL 0	CAL FS	
DC 100 mV	–	100 mV	
DC 1 V	–	1 V	
DC 10 V	–	10 V	
DC 100 V	–	100 V	
DC 20 mA	–	20 mA	
DC 100 mA	–	100 mA	
400 Ω	0 Ω	380 Ω	Three-wire connection
AC 1 V	0 V	1 V/50-60 Hz	
AC 10 V	0 V	10 V/50-60 Hz	
AC 100 V	0 V	100 V/50-60 Hz	
AC 300 V	0 V	300 V/50-60 Hz	

*2: Apply the reference input signals listed above from the calibration standard.

TIP

- You can also select only the range in need of readjustment to adjust it separately.
- Always make zero-point (0) adjustments together with full-scale (FS) adjustments.

10.3.1 Adjusting DC Voltage and DC Current Ranges



Step 1: Press the **SET** key while simultaneously holding down the **CLEAR** key. The LCD shows *CAL SRC*.

Step 2: Pressing the highest-order **Δ** key causes the LCD to show *CAL nERS*.

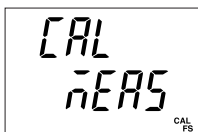

Step 3: Pressing the **SET** key enters the measurement CAL mode. The **MEASURE** indicator blinks on the LCD and the ^{CAL}FS symbol appears. The calibrator is now ready for the defining the CAL FS setpoint of measurement functions.



CAL-mode Operation Keys and Display Indications



- Step 4:** Apply the CAL FS adjustment setpoint input of each range in Table 10.2 from the calibration standard to the H and L input terminals of the calibrator.
- Step 5:** Pressing the  key confirms the CAL FS adjustment setpoint. At this point, the CAL_{FS} symbol blinks.
- Step 6:** Pressing the  once again saves the adjustment setpoint in memory.

NOTE

- Range adjustments are made automatically within the calibrator so that the LCD reading matches the adjustment setpoint in question given in the table with reference to the input applied as described above. Therefore, you need not make any range adjustment with  and  keys.
 - Saving the adjustment setpoint results in the overwriting of existing data. Be extremely careful since the previous adjustment setpoints are cleared.
-

- Step 7:** The CAL_{FS} symbol stops blinking, causing the calibrator to return to the state discussed in step 4. Using the function selector switch, select the next range. By repeating steps 4 to 6, you can adjust the measurement function assigned to that range.

TIP

Press the  key while holding down the  key. This key operation cancels the CAL mode. You can use the same key operation to cancel the CAL mode during calibration, before saving to memory.

When adjusting DC current range, using the  key, change DC 20 mA → DC 100 mA.

10.3.2 Adjusting AC Voltage and Resistance (400 Ω) Ranges

- Step 1:** Press the **SET** key while simultaneously holding down the **CLEAR** key. The LCD shows *CAL SRC*.
- Step 2:** Pressing the highest-order **Δ** key causes the LCD to show *CAL RERS*.
- Step 3:** Pressing the **SET** key enters the measurement CAL mode. The **MEASURE** indicator blinks on the LCD and the CAL symbol appears. The calibrator is now ready for defining the CAL 0 setpoints of measurement functions.
- Step 4:** Using the function selector switch, select the range to be adjusted.
- Step 5:** Pressing the **MEM** key confirms the CAL 0 adjustment setpoint. The **CAL** indicator on the LCD changes to CAL_{FS} , setting the calibrator ready for full-scale calibration.
- Step 6:** Apply the CAL FS adjustment setpoint input of each range in Table 10.2 from the calibration standard to the H and L input terminals of the calibrator.
- Step 7:** Pressing the **MEM** key confirms the CAL FS adjustment setpoint. At this point, the **0** and **FS** symbol blinks.
- Step 8:** Pressing the **MEM** once again saves the adjustment setpoint in memory.

NOTE

- Range adjustments are made automatically within the calibrator so that the LCD reading matches the adjustment setpoint in question given in the table with reference to the input applied as described above. Therefore, you need not make any range adjustment with **Δ** and **▽** keys.
 - Saving the adjustment setpoint results in the overwriting of existing data. Be extremely careful since the previous adjustment setpoints are cleared.
 - The temperature measuring ranges of the RTD function are adjusted at the same time when the 400 Ω range is adjusted.
-
-

Step 9: The **0** and **FS** symbols stop blinking, causing the calibrator to return to the state discussed in step 4. Using the measurement range setting rotary switch, select the next range. By repeating steps 4 to 8, you can adjust the measurement function assigned to that range.

TIP

Press the **SET** key while holding down the **CLEAR** key. This key operation cancels the CAL mode. You can use the same key operation to cancel the CAL mode during calibration, before saving to memory.

10.4 Notes on the Adjustment of Temperature Ranges - CAL71 only -

Adjusting the temperature measuring ranges of the thermocouple function involves using special equipment to make reference junction compensation adjustments. For this reason, contact the vendor from which you purchased the instrument to perform this adjustment.

10.5 Post-adjustment Verification

When adjustment work is done, test the calibrator to ensure that adjustments have been made correctly and adjustment setpoints have been saved into memory correctly. To do this test, turn off the calibrator once and turn it back on again. Then, place the calibrator in normal source or measurement mode and check the setpoints using the same calibration standard.

11. Using Accessories

When attaching accessories to the calibrator, refer to the following figure. When connecting the included terminal adapter, make sure the adapter is positioned in the correct orientation.

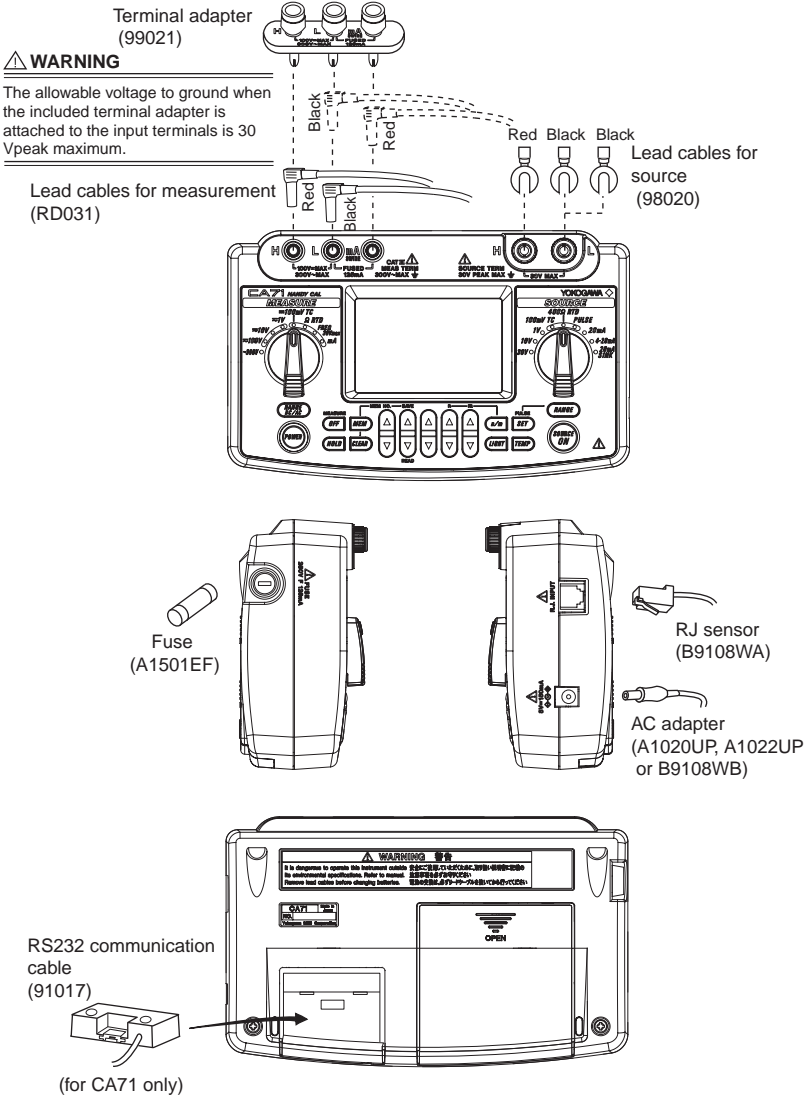

12. Specifications

(1) Signal sourcing unit range and accuracy (for both CA51 and CA71)

±(setting percentage plus μV , mV , mA , Ω or $^{\circ}\text{C}$)

Parameter	Reference	Range	Accuracy (23:5°C per year)	Resolution	Remarks
DC voltage	100 mV	-10.00–110.00 mV	$\pm(0.02\% + 15 \mu\text{V})$	10 μV	
	1 V	0–1.1000 V	$\pm(0.02\% + 0.1 \text{ mV})$	0.1 mV	Maximum output: 5 mA
	10 V	0–11.000 V	$\pm(0.02\% + 1 \text{ mV})$	1 mV	Maximum output: 10 mA
	30 V	0–30.00 V	$\pm(0.02\% + 10 \text{ mV})$	10 mV	Maximum output: 10 mA *1
DC current	20 mA	0–24.000 mA	$\pm(0.025\% + 3 \mu\text{A})$	1 μA	Maximum load: 12 V
	4–20 mA	4/8/12/16/20 mA		4 mA	
mA SINK	20 mA	0.1–24.000 mA	$\pm(0.05\% + 3 \mu\text{A})$	1 μA	External power supply: 5–28 V
Resistance	400 Ω	0–400.00 Ω	$\pm(0.025\% + 0.1 \Omega)$	0.01 Ω	Excitation current: 0.5–5 mA *3
RTD	Pt100 *2	-200.0–850.0°C	$\pm(0.025\% + 0.3^{\circ}\text{C})$	0.1°C	If 0.1 mA, add 0.25 Ω or 0.6°C. Subject device input capacitance: 0.1 μF or less
	JPt100	-200.0–500.0°C			
TC *4	K	-200.0–1372.0°C	$\pm(0.02\% + 0.5^{\circ}\text{C})$	0.1°C	TC source accuracy does not include RJ sensor accuracy. RJ sensor specs Measurement range: -10–50°C Accuracy (when combined with main unit) 18–28°C: $\pm 0.5^{\circ}\text{C}$ Other than the above: $\pm 1^{\circ}\text{C}$
	E	-200.0–1000.0°C	(-100°C or greater)		
	J	-200.0–1200.0°C	$\pm(0.02\% + 1^{\circ}\text{C})$ (-100°C or less)		
	T	-200.0–400.0°C	$\pm(0.02\% + 0.5^{\circ}\text{C})$		
	N	-200.0–1300.0°C	(0°C or greater)		
	L	-200.0–900.0°C	$\pm(0.02\% + 1^{\circ}\text{C})$		
	U	-200.0–400.0°C	(0°C or less)		
	R	0–1768°C	$\pm(0.02\% + 2.5^{\circ}\text{C})$ (100°C or less)	1°C	
	S		$\pm(0.02\% + 1.5^{\circ}\text{C})$ (100°C or greater)		
	B		$\pm(0.02\% + 2^{\circ}\text{C})$ (1000°C or less) $\pm(0.02\% + 1.5^{\circ}\text{C})$ (1000°C or greater)		
Frequency, pulse	500 Hz	1.0–500.0 Hz	$\pm 0.2 \text{ Hz}$	0.1 Hz	Output voltage: +0.1–+15 V (zero base waveform) Amplitude accuracy: $\pm(5\% + 0.1 \text{ V})$ Maximum load current: 10 mA Contact output (with 0.0 V amplitude setting, FET switch ON/OFF) Maximum open/close voltage/current: +28 V/50 mA
	1000 Hz	90–1100 Hz	$\pm 1 \text{ Hz}$	1 Hz	
	10 kHz	0.9 kHz–11.0 kHz	$\pm 0.1 \text{ kHz}$	0.1 kHz	
	Pulse cycle *5	1–99,999 cycles	–	1 cycle	

Temperature coefficient: Accuracy shown above $\times (1/5)^{\circ}\text{C}$

*1: Output up to 24 V/22 mA is possible when using the AC adapter.

*2: As per JIS C 1604-1997 (ITS-90). IPTS-68 may be selected through internal settings (DIP switch).

*3: Excitation current: If less than 0.1 mA to 0.5 mA, then add $[0.025/\text{Is (mA)}] \Omega$ or $[0.06/\text{Is (mA)}]^{\circ}\text{C}$.

*4: As per JIS C 1602-1995 (ITS-90) (L and U are DIN specs).

K, E, J, T, N, R, S, and B may be switched to IPTS-68 through internal settings (DIP switch) (L and U are not switched).

*5: Frequency (interval between one pulse and another) and amplitude during pulse cycle source may have the same range as during frequency source.

12. Specifications

(2) Measurement unit range and accuracy (for both CA51 and CA71)

Accuracy: \pm (reading percentage plus μ V, mV, μ A, Ω or dgt (digit))

Parameter	Reference	Range	Accuracy (23 \pm 5°C per year)	Resolution	Remarks	
DC voltage	100 mV	0 \pm 110.00 mV	\pm (0.025% + 20 μ V)	10 μ V	Input resistance: 10 M Ω or greater	
	1 V	0 \pm 1.1000 V	\pm (0.025% + 0.2 mV)	0.1 mV		
	10 V	0 \pm 11.000 V	\pm (0.025% + 2 mV)	1 mV	Input resistance: Approximately 1 M Ω	
	100 V	0 \pm 110.00 V	\pm (0.05% + 20 mV)	0.01 V		
DC current	20 mA	0 \pm 24.000 mA	\pm (0.025% + 4 μ A)	1 μ A	Input resistance: Approximately 14 Ω	
	100 mA	0 \pm 100.00 mA	\pm (0.04% + 30 μ A)	10 μ A		
Resistance	400 Ω	0 \pm 400.00 Ω	\pm (0.05% + 0.1 Ω)	0.01 Ω	Accuracy during 3-wire measurement	
AC voltage	1 V	0 \pm 1.100 V	\pm (0.5% + 5 dgt)	1 mV	Input resistance: Approximately 10 M Ω /10 pF	Input frequency: 45–65 Hz Input voltage range: 10%–100%
	10 V	0 \pm 11.00 V		0.01 V		
	100 V	0 \pm 110.0 V		0.1 V	Input resistance: Approximately 1 M Ω /10 pF	Measurement method: Average value rectification
	300 V	0 \pm 300 V	\pm (0.5% + 2 dgt)	1 V		
Frequency, pulse	100 Hz	1.00–100.00 Hz	\pm 2 dgt	0.01 Hz	Maximum input: 30 V peak Input resistance: 200 k Ω or greater Sensitivity: 0.5 V peak or greater Contact input: Maximum 100 Hz Notes CPM: Counts per minute CPH: Counts per hour	
	1000 Hz	1.0–1000.0 Hz		0.1 Hz		
	10 kHz	0.001–11.000 kHz		0.001 kHz		
	CPM	0–99,999 CPM		1 CPM		
	CPH	0–99,999 CPH		1 CPH		

Temperature coefficient: Accuracy shown above \times (1/5) $^{\circ}$ C

(3) Measurement unit (temperature; CA71 only) range and accuracy

Accuracy: \pm (reading percentage + $^{\circ}$ C)

Parameter	Reference	Range	Accuracy (23 \pm 5°C per year)	Resolution	Remarks
TC *7	K	-200.0–1372.0 $^{\circ}$ C	\pm (0.05% + 1.5 $^{\circ}$ C) (-100 $^{\circ}$ C or greater)	0.1 $^{\circ}$ C	
	E	-200.0–1000.0 $^{\circ}$ C			
	J	-200.0–1200.0 $^{\circ}$ C			
	T	-200.0–400.0 $^{\circ}$ C			
	N	-200.0–1300.0 $^{\circ}$ C			
	L	-200.0–900.0 $^{\circ}$ C	\pm (0.05% + 2 $^{\circ}$ C) (-100 $^{\circ}$ C or less)		
	U	-200.0–400.0 $^{\circ}$ C			
	R	0–1768 $^{\circ}$ C		1 $^{\circ}$ C	
	S	0–1768 $^{\circ}$ C			
B	600–1800 $^{\circ}$ C				
RTD	Pt100 *6	-200.0–850.0 $^{\circ}$ C	\pm (0.05% + 0.6 $^{\circ}$ C)	0.1 $^{\circ}$ C	Accuracy during 3-wire measurement
	JPt100	-200.0–500.0 $^{\circ}$ C			

Temperature coefficient: Accuracy shown above \times (1/5) $^{\circ}$ C

*6: As per JIS C 1604-1997 (ITS-90). IPTS-68 may be selected through internal settings (DIP switch).

*7: As per JIS C 1602-1995 (ITS-90) (L and U are DIN specs).

K, E, J, T, N, R, S, and B may be switched to IPTS-68 through internal settings (DIP switch) (L and U are not switched).

■ General specifications (for both CA51 and CA71)

Signal sourcing unit response time	: Approximately 1 second (time between start of voltage change and when voltage enters accuracy range)
Signal sourcing unit voltage limiter	: Approximately 32 V
Signal sourcing unit current limiter	: Approximately 25 mA
Divided output (n/m) function	: Output = setting × (n/m) n = 0–m; m = 1–19; n ≤ m
Auto-step output function	: n value sent automatically when n/m function selection is selected (two options: approximately 2.5 seconds/step or approximately 5 seconds/step)
Sweep function	: Sweep time (two options: approximately 16 seconds or approximately 32 seconds)
Memory function	: 50 value sets (sourced and measured values are stored as value sets with the same address (up to 50 value sets can be stored))
Measuring unit maximum input	: Voltage terminal: 300 V AC Current terminal: 120 mA DC
Current terminal input protection	: Fuses: 125 mA/250 V
Measuring unit ground voltage	: Maximum 300 V AC
Measurement display updating rate	: Approximately once per second
Serial interface	: Enabled when communication cable (RS232) is connected; sold separately as optional accessory (CA71 only)
Display	: Segmented LCD (approximately 76 mm × 48 mm)
Backlight	: LED backlight; auto-off after one minute (from when LIGHT key is turned on)
Power supply	: Four AA-size (LR6) alkaline batteries, or special AC adapter (sold separately)
Battery life	: Measurement off, output 5 V DC/10 kΩ or greater: Approximately 40 hours Simultaneous signal source/measurement, output 5 V DC/10 kΩ or greater: Approximately 20 hours Simultaneous signal source//measurement, output 20 mA/5 V: Approximately 12 hours (using alkaline batteries, with backlight off)
Consumed power	: Approximately 7 VA (using 100 V AC adapter)
Auto-power-off function	: Approximately 10 minutes (auto-power-off can be disabled through a DIP switch setting)
Applicable standards	: IEC61010-1, IEC61010-2-31 EN61326-1: 1997 + A1: 1998 EN55011: 1998, Class B, Group 1
Insulation resistance	: Across input terminal and output terminal, 500 V DC, 50 MΩ or greater
Withstand voltage	: Across input terminal and output terminal, 3.7 kVAC, for one minute
Operating temperature and humidity ranges	: 0–50°C, 20–80% RH (no condensation)
Storage temperature and humidity ranges	: -20–50°C, 90% RH or less (no condensation)

12. Specifications

External dimensions (WHD)	: Approximately 190 × 120 × 55 mm
Weight	: Approximately 730 g (including batteries)
Standard accessories	: All of the following are included: Lead cables for source (one red, two black): 98020 Lead cables for measurement (one red, one black): RD031 Carrying case: 93016 Terminal adapter for CA71: 99021 User's manual: IM CA71-E Fuse: A1501EF (for current terminal input protection) Four AA-size (LR6) alkaline batteries: A1070EB × 4
Optional accessories (sold separately)	: AC adapter: A1020UP (100 V AC power supply) AC adapter: A1022UP (120 V AC power supply) AC adapter: B9108WB (220–240 V AC power supply) RJ sensor: B9108WA (For reference junction compensation) Accessory carrying case: B9108XA Communication cable: 91017
Spare parts	: Lead cables for source (one red, two black): 98020 Lead cables for measurement (one red, one black): RD031 Carrying case: 93016 Terminal adapter: 99021 Fuse: A1501EF (for current terminal input protection)
Safety standards	: EN61010-1, EN61010-2-031 Class II Measurement category III (300Vrms max.) Pollution degree 2
EMC	: EN61326 Class B; EN61000-3-2; EN61000-3-3 EN55011 Class B Group1 Performance criterion under immunity test environments: B (self-returnable performance deterioration) Conditions of EMC: Use AC adapter (B9108WB) for AC220-240V, Lead cable for source (98020), Lead cable for measurement (RD031), RS232 Communication cable (91017) and RJ sensor (B9108WA): attach a sleeve clamp ferrite core (YOKOGAWA B9108WC, Morimiya electric Co. MSFC6KEX) toward the main body of the instrument.

■ External

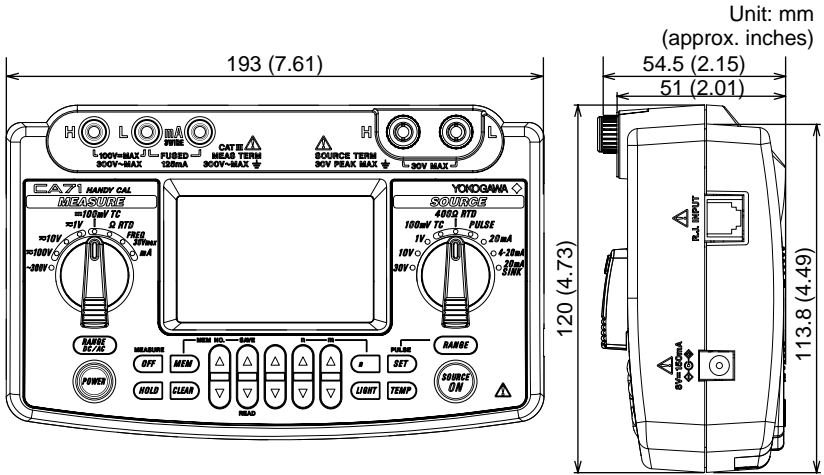

Note: This figure shows the CA71, but there is no difference in exterior from the CA51.



Yokogawa Meters & Instruments Corporation

Yokogawa Meters & Instruments Corporation

International Sales Dept.

Tachihi Bld. No.2, 6-1-3, Sakaecho, Tachikawa-shi, Tokyo 190-8586 Japan
Phone: 81-42-534-1413, Facsimile: 81-42-534-1426

YOKOGAWA CORPORATION OF AMERICA (U.S.A.)

Phone: 1-770-253-7000 Facsimile: 1-770-251-2088

YOKOGAWA EUROPE B. V. (THE NETHERLANDS)

Phone: 31-334-64-1611 Facsimile: 31-334-64-1610

YOKOGAWA ENGINEERING ASIA PTE. LTD. (SINGAPORE)

Phone: 65-6241-9933 Facsimile: 65-6241-2606

YOKOGAWA AMERICA DO SUL S. A. (BRAZIL)

Phone: 55-11-5681-2400 Facsimile: 55-11-5681-1274

YOKOGAWA MEASURING INSTRUMENTS KOREA CORPORATION (KOREA)

Phone: 82-2-551-0660 to -0664 Facsimile: 82-2-551-0665

YOKOGAWA AUSTRALIA PTY. LTD. (AUSTRALIA)

Phone: 61-2-9805-0699 Facsimile: 61-2-9888-1844

YOKOGAWA INDIA LTD. (INDIA)

Phone: 91-80-4158-6000 Facsimile: 91-80-2852-1441

YOKOGAWA SHANGHAI TRADING CO., LTD. (CHINA)

Phone: 86-21-6880-8107 Facsimile: 86-21-6880-4987

YOKOGAWA MIDDLE EAST E. C. (BAHRAIN)

Phone: 973-358100 Facsimile: 973-336100

LTD. YOKOGAWA ELECTRIC (RUSSIAN FEDERATION)

Phone: 7-095-737-7868 Facsimile: 7-095-737-7869
