

[查询VFD-L供应商](#)

[捷多邦, 专业PCB打样工厂, 24小时加急出货](#)



5011604303

20030522



LE03

# User Manual

# VFD-L

VARIABLE SPEED AC MOTOR DRIVE

115V/230V 25W – 100W

HIGH PERFORMANCE / EASY CONTROL AC DRIVE



**ASIA**  
**DELTA ELECTRONICS, INC.**  
**TAOYUAN Plant/**  
31-1, SHIEN PAN ROAD,  
KUEI SAN INDUSTRIAL ZONE  
TAOYUAN 333, TAIWAN  
TEL: 886-3-362-6301  
FAX: 886-3-362-7267  
<http://www.deltaww.com/acdrives>

**NORTH/SOUTH AMERICA**  
**DELTA PRODUCTS**  
**CORPORATION**  
**Sales Office/**  
P.O. BOX 12173  
5101 DAVIS DRIVE  
RTP, NC 27709 U. S. A.  
TEL: 1-919-767-3813  
FAX: 1-919-767-3969  
<http://www.deltaww.com/acdrives>

**EUROPE**  
**DELTRONICS (Netherlands) B.V.**  
**Sales Office/**  
Industriegebied Venlo Nr. 9031  
Columbusweg 20  
NL-5928 LC Venlo  
The Netherlands  
TEL: 31-77-324-1930  
FAX: 31-77-324-1931

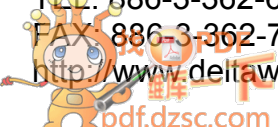

## Preface

Thank you for choosing Delta's high-performance VFD-L Series. VFD-L Series are manufactured by adopting high-quality components, material and incorporating the latest microprocessor technology available.

This manual will be helpful in the installation, parameter setting, troubleshooting, and daily maintenance of the AC motor drives. To guarantee safe operation of the equipment, read the following safety guidelines before connecting power to the AC motor drives. Keep this operating manual handy and distribute to all users for reference.

## Receiving and Inspection

This VFD-L AC drive has gone through rigorous quality control tests at the factory before shipment. After receiving the AC motor drive, please check for the following:

### Receiving

- ✓ Check to make sure that the package includes an AC drive and the User Manual.
- ✓ Inspect the unit to insure it was not damaged during shipment.
- ✓ Make sure that the part number indicated on the nameplate corresponds with the part number of your order.

### Nameplate Information: Example of 100W 230V AC drive

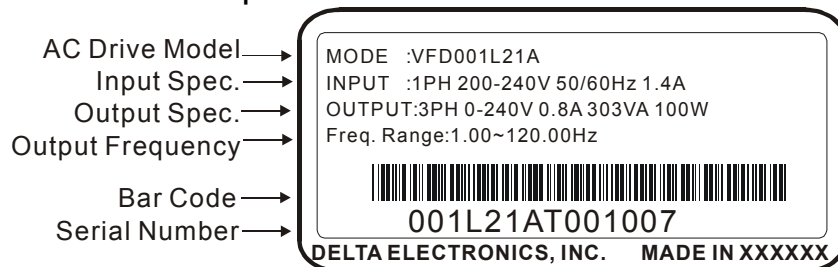

### Model Explanation and Series Number Explanation:

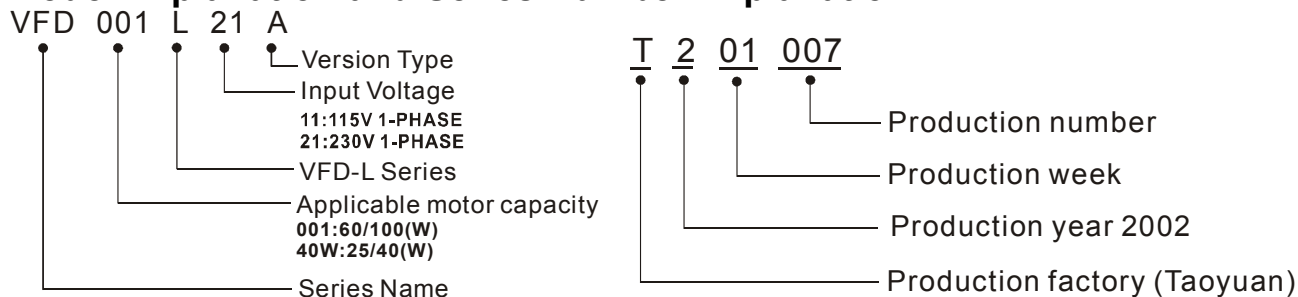

If there is any nameplate information not corresponding to your purchase order or any problem, please contact your supplier.

**⚠ DANGER!** AC input power must be disconnected before any maintenance. Do not connect or disconnect wires and connectors while power is applied to the circuit.

**⚠ CAUTION!** There are highly sensitive MOS components on the printed circuit boards. These components are especially sensitive to static electricity. Do not touch these components or the circuit boards with metal objects or your bare hands.

**⚠ CAUTION!** Ground the VFD-L using the ground terminal. The grounding method must comply with the laws of the country where the AC drive is to be installed.

**⚠ CAUTION!** Heat sink may heat up over 70°C (158°F), during the operation. Do not touch the heat sink.

## 2

### Storage and Installations

#### Storage:

The AC drive should be kept in the shipping carton before installation. In order to retain the warranty coverage, the AC drive should be stored properly when it is not to be used for an extended period of time.

#### Ambient Conditions:

<b>Operation</b>	Air Temperature:	-10° C to +40° C (14° F to 122° F)
	Atmosphere pressure:	86 to 106 kPa
	Installation Site Altitude:	below 1000m
	Vibration:	Maximum 9.86 m/s <sup>2</sup> (1G) at less than 20Hz Maximum 5.88 m/s <sup>2</sup> (1G) at 20Hz to 50Hz
<b>Storage</b>	Temperature:	-20° C to + 60° C (-4° F to 140° F)
	Relative Humidity:	Less than 90%, no condensation allowed
	Atmosphere pressure:	86 to 106 kPa
	Temperature:	-20° C to +60° C (-4° F to 140° F)
<b>Transportation</b>	Relative Humidity:	Less than 90%, no condensation allowed
	Atmosphere pressure:	86 to 106 kPa
	Vibration:	Maximum 9.86 m/s <sup>2</sup> (1G) at less than 20Hz Maximum 5.88 m/s <sup>2</sup> (1G) at 20Hz to 50Hz

#### Installations and Connection:



The control, power supply and motor leads must be laid separately. They must not be fed through the same cable conduit / trucking.

High voltage insulation test equipment must not be used on cables connected to the drive.

Wait five minutes for DC bus capacitors discharge.

***Any Electrical or mechanical modification to this equipment without prior written consent of Delta Electronics, Inc. will void all warranties and may result in a safety hazard in addition to voiding the UL listing.***

#### Short Circuit Withstand:

Suitable for use on a circuit capable of delivering not more than 5,000 rms symmetrical amperes, for 230V Models, the maximum is 240 Volts.

Improper installation of the AC drive will greatly reduce its life. Be sure to observe the following precautions when selecting a mounting location. **Failure to observe these precautions may void the warranty!**

- ◆ **Do not mount the AC drive near heat-radiating elements or in direct sunlight.**
- ◆ **Do not install the AC drive in a place subjected to high temperature, high humidity, excessive vibration, corrosive gases or liquids, or airborne dust or metallic particles.**
- ◆ **Mount the AC drive vertically and do not restrict the airflow to the heat sink fins.**
- ◆ **The AC drive generates heat. Allow sufficient space around the unit for heat dissipation as shown in the figure shown next page:**

3

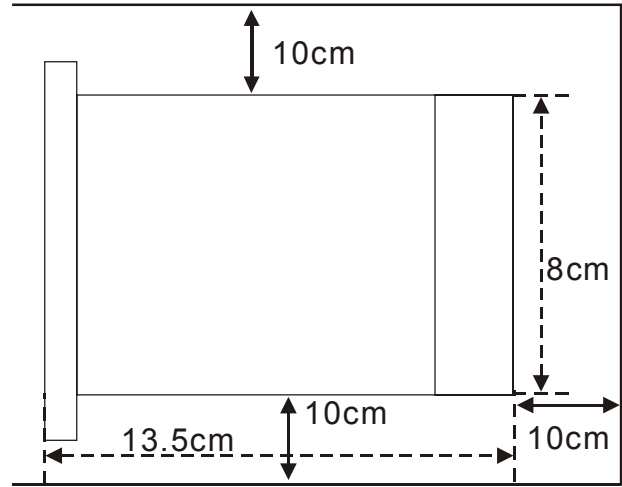
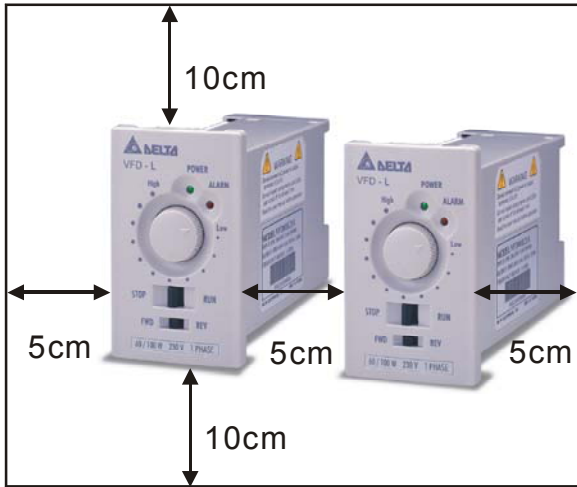

### Connections:

Installations intended to meet UL and CUL requirements must follow the instructions provided in “Wiring Notes” section below as a minimum standard. Where local codes exceed these requirements, they must also be followed. Refer to the technical data label affixed to the AC drive and the motor nameplate for electrical data.

### Basic Wiring Diagram

Users must connect wiring according to the following circuit diagram shown below.

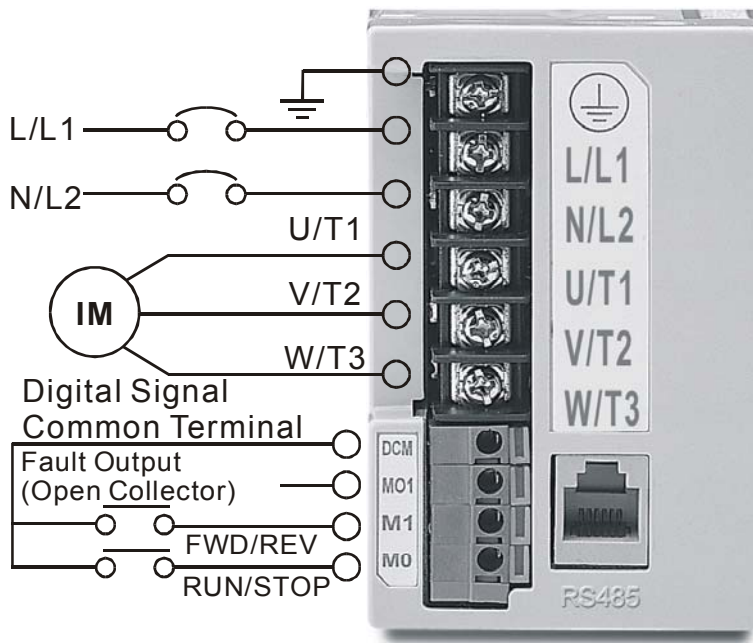

Wire Gauge: 22-14 AWG  
Torque: 10kgf-cm  
(8.7 in-lbf)

### RS-485 Serial Interface

1 : +EV  
2 : GND  
3 : SG-  
4 : SG+  
PIN 1 & 2 are the power source for the digital keypad and should not be used while using RS-485 communication.

**\*NOTE\*:** Do not plug a Modem or telephone line to the RS-485 communication port, permanent damage may result. Terminals 2 & 5 are the power sources for the optional copy keypad and should not be used while using RS-485 communication.

# 4

## Main Circuit Terminals: wire gauge 22-14AWG, torque 10kgf-cm (8.7 in-lbf)

Terminal Symbols	Terminal Functions
L/L1, N/L2	AC line input terminals
U/T1, V/T2, W/T3	Motor connections
	Earth Ground

## Control Circuit Wiring: wire gauge 22-14AWG, torque 10kgf-cm (8.7 in-lbf)

Terminal symbols	Terminal names	Remarks
M0	RUN/STOP	Normally Open contact, AC drive starts operation when closes.
M1	FWD/REV	Normally Open contact, AC drive starts reverse motion when closes.
MO1	Fault Indication	When error is detected, MO1 will close.
RS-485	Serial Communication Port	When DIP Switch 7 is ON, the drive is controlled by RS-485.
DCM	Digital Signal Common	Ground for M0, M1 and MO1

### ◆ Front Panel Control Diagram

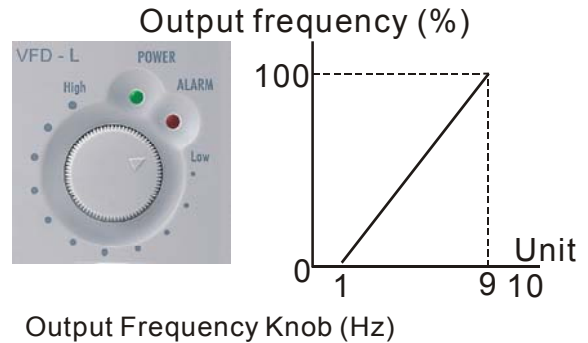
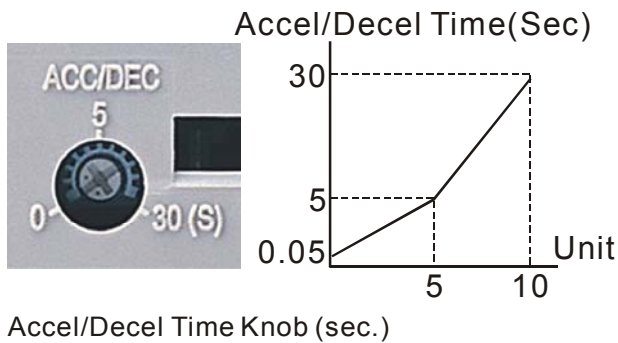
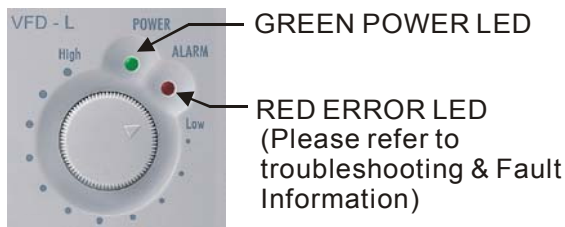





# 5

## Switch Setting Descriptions:

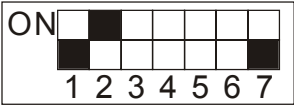
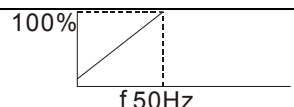
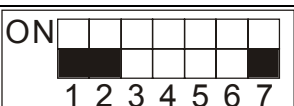
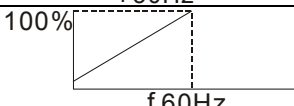
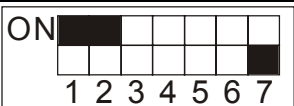
The DIP Switches can only be changed when AC drive is in a stopped mode.

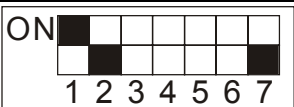
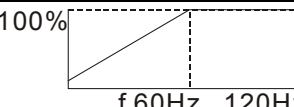
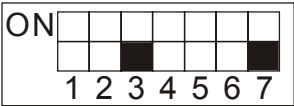
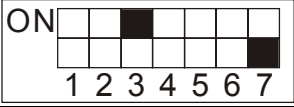
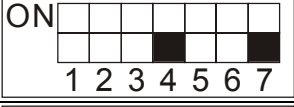
■ Indicates the position of the switch (ON/OFF).

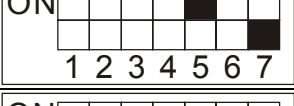
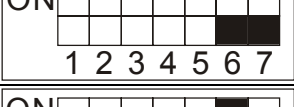
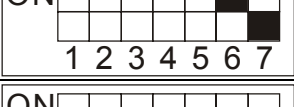
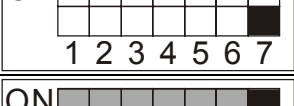
DIP Switch	Switch Name	Switch Setting	Parameter Descriptions	
1	Max. Output Frequency	ON 	Maximum Output Frequency	V/F Curve
		50Hz		
2	Max. Output Frequency	ON 	60Hz	
		ON 	100Hz	
3	Reverse Inhibit	ON 	Reverse enable	
		ON 	Reverse disable	
4	Torque Setting	ON 	Low torque output	
		ON 	High torque output	
5	Electronic Thermal Setting	ON 	Applicable for 40/100W motor	
		ON 	Applicable for 25/60W motor	
6	Operation Command Source Select (1)	ON 	Operation command controlled by potentiometer.	
		ON 	Operation command controlled by external terminal	
7	Operation Command Source Select (2)	ON 	Operation command controlled by external terminal (can be monitored by communication mode)	
		ON 	Switch 7 is ON, indicates the communication mode is enabled; switches 1 to 6 are address settings.	



## 6

### Communication

There is three control modes: RS-485 communication, AC drive front panel, and external terminals. Only one mode can be used at a time and is selected by DIP Switch 6 and 7. Programming can only be done **when the AC drive is in stopped mode**.

DIP switch settings for control

- ◆ DIP Switch 6 determines if control is via the AC drives front panel or external terminals. Set DIP switch 6 to OFF for AC drive front panel control and ON for external terminal control
- ◆ DIP Switch 7 determines if control is local or via RS-485 communication. When DIP Switch 7 is OFF, the AC drive front panel or external terminals control the drive.

Note: The parameters set via RS-485 communication will remain in memory. Users can still read the status of the AC drive via RS-485 communication, but cannot send any control commands.

When DIP Switch 7 is ON, the drive is controlled by RS-485 communication. Please verify the AC drive is fully stopped prior to turn DIP Switch 7 ON. If DIP Switch 7 is turned ON during operation, the error LED will illuminate.

### Computer Controls

Each VFD-L AC Drive has a pre-assigned communication address specified by DIP Switch pins 1 to 6 (Refer to the description of setting up address). VFD-L type Communication agreement: Modbus ASCII mode, protocol <7, N, 2>, Baud rate 9600. The computer then controls each AC Drive according to its communication address.

- ◆ ASCII Modes:

Each 8-bit data is the combination of two ASCII characters. For example, a 1-byte data: 64 Hex, shown as '64' in ASCII, consists of '6' (36Hex) and '4' (34Hex).

Character	'0'	'1'	'2'	'3'	'4'	'5'	'6'	'7'
ASCII code	30H	31H	32H	33H	34H	35H	36H	37H
Character	'8'	'9'	'A'	'B'	'C'	'D'	'E'	'F'
ASCII code	38H	39H	41H	42H	43H	44H	45H	46H

- ◆ Data Format

10-bit character frame (For 7-bit character): ❖ (7, N, 2)

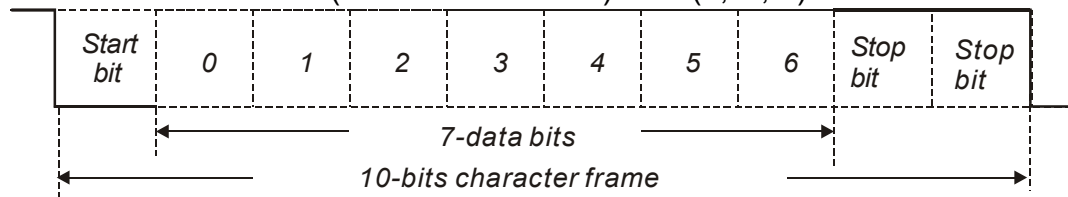

### AC Drive Addresses for RS-485 Communication

VFD-L series communication addresses are 1 to 63, since 0 means broadcast to all AC drives. A DIP Switch sets to ON for equal to 1 and OFF for equal to 0.

If DIP Switch 7 is OFF during power up, the communication address for the drive is 0008H, this is address 1 (factory default).

If DIP Switch 7 is ON during power up, the address settings are determined by the ON/OFF positions of DIP Switches 1 to 6. Address 1 is when all switches are set to the OFF position. Switch "1" is the upper bit and switch 6 is the lower bit.

(A) The addresses will remain in memory when the control mode changes to AC drive panel or external terminals.

# 7

(B) The addresses will remain in memory when parameters are reset.

To save new addresses, remove power from the drive, set DIP switch 7 to ON and reapply power to the drive, at this time the new addresses will be read.

Examples of setting up the address (Black block means ON or OFF of DIP SWITCH):

ON <table border="1"> <tr><td>1</td><td></td><td></td></tr> <tr><td>2</td><td></td><td></td></tr> <tr><td>3</td><td></td><td></td></tr> <tr><td>4</td><td></td><td></td></tr> <tr><td>5</td><td></td><td></td></tr> <tr><td>6</td><td></td><td></td></tr> <tr><td>7</td><td>■</td><td></td></tr> </table>	1			2			3			4			5			6			7	■		ON <table border="1"> <tr><td>1</td><td>■</td><td></td></tr> <tr><td>2</td><td>■</td><td></td></tr> <tr><td>3</td><td>■</td><td></td></tr> <tr><td>4</td><td>■</td><td></td></tr> <tr><td>5</td><td>■</td><td></td></tr> <tr><td>6</td><td>■</td><td></td></tr> <tr><td>7</td><td>□</td><td>■</td></tr> </table>	1	■		2	■		3	■		4	■		5	■		6	■		7	□	■	ON <table border="1"> <tr><td>1</td><td>■</td><td></td></tr> <tr><td>2</td><td>■</td><td></td></tr> <tr><td>3</td><td>■</td><td></td></tr> <tr><td>4</td><td>■</td><td></td></tr> <tr><td>5</td><td>■</td><td></td></tr> <tr><td>6</td><td>□</td><td>■</td></tr> <tr><td>7</td><td>□</td><td>■</td></tr> </table>	1	■		2	■		3	■		4	■		5	■		6	□	■	7	□	■	ON <table border="1"> <tr><td>1</td><td>■</td><td></td></tr> <tr><td>2</td><td>■</td><td></td></tr> <tr><td>3</td><td>■</td><td></td></tr> <tr><td>4</td><td>■</td><td></td></tr> <tr><td>5</td><td>□</td><td>■</td></tr> <tr><td>6</td><td>■</td><td>□</td></tr> <tr><td>7</td><td>□</td><td>■</td></tr> </table>	1	■		2	■		3	■		4	■		5	□	■	6	■	□	7	□	■	ON <table border="1"> <tr><td>1</td><td></td><td>■</td></tr> <tr><td>2</td><td></td><td>■</td></tr> <tr><td>3</td><td></td><td>■</td></tr> <tr><td>4</td><td></td><td>■</td></tr> <tr><td>5</td><td></td><td>■</td></tr> <tr><td>6</td><td></td><td>■</td></tr> <tr><td>7</td><td></td><td>■</td></tr> </table>	1		■	2		■	3		■	4		■	5		■	6		■	7		■
1																																																																																																													
2																																																																																																													
3																																																																																																													
4																																																																																																													
5																																																																																																													
6																																																																																																													
7	■																																																																																																												
1	■																																																																																																												
2	■																																																																																																												
3	■																																																																																																												
4	■																																																																																																												
5	■																																																																																																												
6	■																																																																																																												
7	□	■																																																																																																											
1	■																																																																																																												
2	■																																																																																																												
3	■																																																																																																												
4	■																																																																																																												
5	■																																																																																																												
6	□	■																																																																																																											
7	□	■																																																																																																											
1	■																																																																																																												
2	■																																																																																																												
3	■																																																																																																												
4	■																																																																																																												
5	□	■																																																																																																											
6	■	□																																																																																																											
7	□	■																																																																																																											
1		■																																																																																																											
2		■																																																																																																											
3		■																																																																																																											
4		■																																																																																																											
5		■																																																																																																											
6		■																																																																																																											
7		■																																																																																																											
Communication Inhibits	Communication address is 01	Communication Address is 01	Communication Address is 02	Communication Address is 63																																																																																																									

## Communication Protocol

Communication Data Frame:

STX	Start character ':' (3AH)
ADR 1	Communication address: 8-bit address consists of 2 ASCII codes
ADR 0	
CMD 1	Command code: 8-bit command consists of 2 ASCII codes
CMD 0	
DATA (n-1)	Contents of data: n×8-bit data consist of 2n ASCII codes. n≤25, maximum of 50 ASCII codes
To	
DATA 0	
LRC CHK 1	LRC check sum: 8-bit check sum consists of 2 ASCII codes
LRC CHK 0	
END 1	End characters: END1 = CR (0DH), END0 = LF (0AH)
END 0	

### ◆ ADR (Communication Address)

Valid communication addresses are in the range of 1 to 63. Communication address equal to 0, means broadcast to all AC drives. In this case, the AMD will not reply any message to the master device.

### ◆ CMD (Command code) and DATA (data characters)

The format of data characters depends on the command code. The available command codes are described as followed:

Command code: 03H, read N words. The maximum value of N is 12. For example, reading continuous 2 words from starting address 2102H of AMD with address 01H				Command code: 06H, write 1 word For example, writing 6000 (1770H) to address 2001H of AMD with address 01H.			
Command message:		Response message:		Command message:		Response message:	
STX	:	STX	:	STX	:	STX	:
ADR 1	'0'	ADR 1	'0'	ADR 1	'0'	ADR 1	'0'
ADR 0	'1'	ADR 0	'1'	ADR 0	'1'	ADR 0	'1'
CMD 1	'0'	CMD 1	'0'	CMD 1	'0'	CMD 1	'0'
CMD 0	'3'	CMD 0	'3'	CMD 0	'6'	CMD 0	'6'



8

Starting data address	'2'	Number of data (byte)	'0'	Data address	'2'	Data address	'2'	
	'1'		'4'		'0'		'0'	
	'0'		Content of starting data address 2102H		'1'		'0'	'0'
	'2'				'7'		'1'	'1'
Number of data (Count by word)	'0'	Content of data address 2103H	'0'	Data content	'1'	Data content	'1'	
	'0'		'0'		'7'		'7'	
	'0'		'0'		'7'		'7'	
	'2'		'0'		'0'		'0'	
LRC CHK 1	'D'	LRC CHK 1 LRC CHK 0	'7'	LRC CHK 1 LRC CHK 0	'5'	LRC CHK 1 LRC CHK 0	'5'	
LRC CHK 0	'7'		'1'		'1'		'1'	
END 1 END 0	CR	END 1 END 0	CR	END 1 END 0	CR	END 1 END 0	CR	
	LF		LF		LF		LF	

◆ CHK (check sum)

LRC (Longitudinal Redundancy Check) is calculated by summing up the values of the bytes from ADR1 to last data character then calculating the hexadecimal representation of the 2's-complement negation of the sum. For example, using the command message of above:

STX	':'
ADR 1	'0'
ADR 2	'1'
CMD 1	'0'
CMD 2	'3'
STARTING DATA ADDRESS	'2'
	'1'
	'0'
	'2'
NUMBER OF DATA	'0'
	'0'
	'0'
	'2'
LRC CHK 1	'D'
LRC CHK 0	'7'
END 1	CR
END 0	LF

$01H+03H+21H+02H+00H+02H=29H$ , the 2's-complement negation of 29H is D7H.

9

Parameters (saved in the EEPROM) ★: the parameter can be set during the operation.

Parameter	Parameter Function	Parameter Setting	Factory Setting	Customer Setting
0	Identity code of Drive	Depend on drive		Read only
1	Rating current	Depend on drive	1	Read/Write
2	Parameter Reset	10: Reset	0	Read/Write
3	Max. Operation Freq.	0: 50 Hz 1: 60 Hz 2: 100 Hz 3: 120 Hz	1	Read Only
★4	Accel/Decel Time	0.05 to 30.00 sec	5.00	Read/Write
5	Reverse Inhibit	0: Reverse disable 1: Reverse enable	1	Read/Write
6	Torque Increase	0: High Torque 1: Low Torque	1	Read/Write
7	Electronic Thermal	0: 25/60 w 1: 40/100 w	1	Read/Write
8	Communication Addresses	01 to 63	1	Read/Write
9	Software Version	Read only	##	Read Only

Address List:

The contents of available addresses are shown as below:

Content:	Address:	Function:	
AC drive Parameters	nnnnH	nnnn means parameter number, for example, the address of 0004 is 0004H. When reading parameter by command code 03H, only one parameter can be read at one time.	
Command Write only	2000H	Bit 0 to 1	00B: No function 01B: Stop 10B: Run 11B: No function
		Bit 2 to 3	Reserved
		Bit 4 to 5	00B: No function 01B: FWD 10B: REV 11B: Change direction
		Bit 6 to 15	Reversed
	2001H	Frequency command	
	2002H	Bit 0	1: Reversed
		Bit 1	1: Reset
	Bit 2-15	Reserved	

Content:	Address:	Function:		
Status monitor (Read only)	2100H	Error Codes 00: No error occurred 01: Over-current (oc) 02: Over-voltage (ov) 03: Overheat (oH) 04: Overload (oL) 05, 06: Reserved 07: CPU failure (cF3) 08 to 13: Reserved 14: Low voltage (Lv) 15: CPU failure 1 (cF1) 16: CPU failure 2 (cF2) 17 to 19: Reserved 20: Software protection 21: Operation error 22: OH Hardware failure cF3.1 23: OV Hardware failure cF3.2 24: LV Hardware failure cF3.3 26: Hardware failure cF3.5 (current detection) 30: Hardware failure hpf.2 31: Hardware failure hpf.3		
		2101H	Bit 0 to 1	00: STOP 01: Ramp stop 10: Zero speed 11: Operation
			Bit 2	Reserved
			Bit 3 to 4	00: Forward motion 01: from Reverse to Forward motion 10: from Forward to Reverse motion 11: Reverse motion
			Bit 5 to 9	Reserved
			Bit 10	1: Operation commands are controlled by communication interface.
			Bit 11 to 15	Reserved
		2102H	Frequency Command F (XXX.XX)	
		2103H	Output Frequency H (XXX.XX)	
		2104H	Output Current A (X.XX)	
		2105H	DC-BUS Voltage (XXX)	
2106H	Output Voltage E (XXX.X)			

**Exception Responses:**

Except for broadcast messages, the AC drive is been expected to return a normal response after receiving command messages from the master device. The following depicts the conditions that no normal response is replied to the master device.

The AC drive does not receive the messages due to a communication error; thus, the AC drive has no response. The master device will eventually process a timeout condition. The AC drive receives the messages without a communication error, but cannot handle it, an exception response will return to the master device. In the exception response, the most significant bit of the original command code is set to 1, and an exception code explains the condition that caused the exception is returned. An example of exception response of command code 06H and exception code 02H:

STX	‘.’	3AH
ADDRESS 1	‘0’	30H
ADDRESS 0	‘1’	31H
FUNCTION (CMD) 1	‘8’	38H
FUNCTION (CMD) 0	‘6’	36H
EXCEPTION CODE	‘0’	30H
	‘2’	32H
LRC CHK 1	‘7’	43H
LRC CHK 0	‘7’	46H
END 1	CR	0DH
END 0	LF	0AH

The explanation of exception codes:

Exception codes:	Explanation
01	Illegal command code: The command code received in the command message is not available for the AC drive.
02	Illegal data address: The data address received in the command message is not available for the AC drive.
03	Illegal data value: The data value received in the command message is over range for the AC drive.
04	Slave device failure: The AC drive is unable to perform the requested action.
09	Check Sum Error: Check if the Check Sum is correct.
20	Watchdog Timer: The timer will reset to 0 after each valid MODBUS communication message is received.

# 12

## Maintenance and Inspections

Modern AC drives are based on solid state electronics technology, preventive maintenance is required to operate this AC drive in its optimal condition, and to ensure a long life. It is recommended to perform a monthly check up of the AC drive by a qualified technician. Before the check up, always turn off the AC Input Power to the unit. Wait at least 2 minutes after all display lamps have gone out, and then confirm that the capacitors have fully discharged.

### Periodic Inspection:

Basic check up items to detect if there were any abnormality during the operation.

1. Whether the motors are operating as expected.
2. Whether the installation environment is abnormal.
3. Whether the cooling system is operating as expected.
4. Whether any irregular vibration or sound occurred during the operation.
5. Whether the motors are overheated during the operation.
6. Always check the input voltage of the AC drive with Voltmeter.

### Periodic Maintenance:

It is necessary to stop the motor operation during the check up.

1. Tighten and reinforce the screws of the AC drive if necessary, cause it may loose due to the vibration or changing of temperatures.
2. Whether the conductors or insulators were corroded and damaged.
3. Check the resistance of the insulation with Megaohmmeter.
4. Often check and change the capacitors and relays.
5. If use of the AC drive is discontinued for a long period of time, turn the power on at least once every two years and confirm that it still functions properly. To confirm functionality, disconnect the motor and energize the AC drive for 5 hours or more before attempting to run a motor with it.
6. Clean off any dust and dirt with a vacuum cleaner. Place special emphasis on cleaning the ventilation ports and PCBs. Always keep these areas clean, as adherence of dust and dirt can cause unforeseen failures.

### Fuse and Fuse Breaker (NFB) Specifications:

Model	Ampere Rating (A)	Manufacturer (Reference)
40W 115V	6.0A	Busmann - JJN-6 300V
40W 230V	3.0A	Busmann - JJN-3 300V
100W 115V	10.0A	Bssmann - JJN-10 300V
100W 230V	6.0A	Bssmann - JJN-6 300V

# 13

## Troubleshooting and Fault Information

The AC drive has a comprehensive fault diagnostic system that includes several different alarms and fault message. Once a fault is detected, the corresponding protective functions will be activated to shut down the AC drive output. Below are the fault descriptions, for a fault shown on the AC drive digital keypad. After fault has been cleared, switch the Run/Stop key to stop mode to reset the drive.

Fault Display	Fault Descriptions	Corrective Actions
Alarm LED lightens after power on	Hardware failure	Return to the factory
Alarm LED flashes once in every two seconds	The AC drive detects an abnormal increase in current (Over-current)	<ol style="list-style-type: none"> <li>1. Increase the acceleration time</li> <li>2. Check whether the motor output power corresponds to the AC drive output power</li> <li>3. Check the wiring connection between the AC drive and motor for possible short circuit</li> <li>4. Check for possible over loading conditions at the motor</li> </ol>
Alarm LED flashes twice in every two seconds (Over-voltage)	The AC drive detects that the DC-BUS voltage has exceeded its maximum allowable value	<ol style="list-style-type: none"> <li>1. Check whether the input voltage falls within the rated AC Drive input voltage.</li> <li>2. Check for possible voltage transients.</li> <li>3. Bus over-voltage may be caused by motor regeneration, increase the accel/decel time.</li> </ol>
Alarm LED flash thrice in every two seconds (Overload)	Motor overload	<ol style="list-style-type: none"> <li>1. Check for possible motor overload.</li> <li>2. Adjust torque detection setting of the DIP SW4 to an appropriate setting.</li> <li>3. Increase the AC Drive's output capacity.</li> </ol>
Alarm LED flashes four times in every two seconds (Over-heating)	The AC drive temperature sensor detects excessive heat.	<ol style="list-style-type: none"> <li>1. Ensure that the ambient temperature falls within the specified temperature range.</li> <li>2. Make sure that the ventilation holes are not obstructed.</li> <li>3. Provide enough spacing for adequate ventilation.</li> </ol>
Alarm LED flashes five times in every two seconds (Low voltage)	The AC drive detects that the DC Bus Voltage has fallen below its minimum value.	Check whether the input voltage falls within the rated AC Drive input voltage.
Alarm LED flashes	Change DIP SW while drive is running	Switch the Run/Stop key to Stop mode to reset the AC drive.

## Standard Specifications

Voltage Class		115V Class				230V Class				
Model Number VFD□□□L□□A/B		40W		001		40W		001		
Weight g (lb) A (standard)		270 (0.60)		440 (0.97)		260 (0.57)		430 (0.95)		
Weight g (lb) B (build-in EMI filter)		350 (0.77)		525 (1.16)		340 (0.75)		510 (1.12)		
Max. Applicable Motor Output (W)		25/40		60/100		25/40		60/100		
Output Rating	Rated Output Capacity (VA)		106/152		212/303		106/152		212/303	
	Rated Output Current (A)		0.28/0.4		0.56/0.8		0.28/0.4		0.56/0.8	
	Maximum Output Voltage (V)		Two times proportion to Input Voltage				Proportional to Input Voltage			
	Rated Frequency (Hz)		1.00 to 120.00 Hz							
Input Rating	Rated Voltage/Frequency		Single phase 100 to 120 VAC 50/60 Hz				Single phase 200 to 240 VAC 50/60Hz			
	Voltage/Freq. Tolerance		Voltage: ±10%, Frequency: ±5%							
	Input Current (A)		1.1A	1.5A	2.2A	3.0A	0.5A	0.7A	1.0A	1.4A
Control Characteristics	Control Systems		SVPWM (Space Vector Pulse Width Modulation, carrier frequency 10kHz)							
	Torque Setting		High/Low, Switching							
	Overload Endurance		150% of rated current for 1 minute							
	Accel/Decel Time		0.05 to 30.0 seconds							
	Torque Promotion		Torque Boots: 0 or 8%							
Operation Characteristics	Frequency Setting		Potentiometer							
	Operation Setting Signal	Panel	RUN/STOP, FORWARD/REVERSE							
		Ext. Terminal	RUN/STOP, FORWARD/REVERSE, RS-485							
	Output Indiction	Panel	Fault Indication (LED Flash)							
Ext. Terminal		Fault Indication (Open Collector)								
Protection		Self-testing, Over Voltage, Over Current, Under Voltage, Overload, Overheating, Thermal.								
Cooling		Natural air-cooling								
Environment	Installation Location		Altitude 1,000m or lower, keep from corrosive gasses, liquid and dust							
	Pollution Degree		2							
	Ambient Temperature		-10°C to 40°C (Non-Condensing and not frozen)							
	Storage Temperature		-20°C to 60°C							
	Ambient Humidity		Below 90% RH (non-condensing)							
	Vibration		9.80665m/s <sup>2</sup> (1G) less than 20Hz, 5.88m/s <sup>2</sup> (0.6G) at 20 to 50Hz							



# 15 Dimensions

