



NVR User Manual

Document Version: 1.8

Date: 2013.10

www.videotrack.us

This document describes the installation, main features, and operations of the NVR.

Important Notices

Thanks for selecting our company's IPC. Before use, please read through the user's guide to avoid any unnecessary damage!

This document is applicable to built-in hard disk video recorders, such as the HVRxxxx and VSRxxxx series video recorders.

All functions depend on the actual product. Since the product is subject to updating, our company is not responsible for any difference from this guide and not liable for any dispute over different technical parameters from this guide. The product is subject to any change without notice.

Contents

1 Device Description.....	1
1.1 NVR Overview.....	1
1.2 Functions and Features	1
1.3 Hardware Environment.....	3
1.4 Software Environment	4
1.5 Network Protocols	4
1.6 Appearance.....	4
1.7 Technical parameters	6
1.8 Panels.....	7
1.8.1 Front Panel	7
1.8.2 Rear Panel.....	8
1.9 Mouse Functions	10
1.10 Input Methods.....	12
2 Installation and Cable Connection.....	13
2.1 Hardware Installation.....	13
2.2 Hard Disk Installation.....	13
2.3 Device Installation.....	15
2.4 Video Input and Output Connections	15
2.5 Audio Input and Output Connections (AIN and AOUT).....	16
2.6 Alarm Output Connections.....	16
3 System Menus.....	19
3.1 Main Menus	19
3.2 Shortcut Menus	21
3.2.1 Record Control.....	22
3.2.2 PTZ Control	23
3.3 Main Menu Operations	25
3.4 Record.....	26
3.4.1 Schedule.....	26
3.4.2 Record Playback	28
3.4.3 Backup	29
3.5 Alarm.....	30
3.5.1 Motion Detection	30
3.5.2 Alarm Input.....	31

3.5.3 Network Alarm.....	32
3.5.4 Alarm Output.....	32
3.5.5 Abnormity.....	33
3.5.6 Digital Alarm.....	33
3.6 Setting.....	34
3.6.1 General.....	34
3.6.2 Network.....	35
3.6.3 Display.....	38
3.6.4 Account.....	39
3.6.5 PTZ.....	41
3.6.6 Tour.....	41
3.7 Advanced.....	42
3.7.1 HDD Manage.....	42
3.7.2 Digital Channel.....	43
3.7.3 USB Update.....	44
3.7.4 Configuration.....	44
3.7.5 Maintenance.....	45
3.7.6 Default.....	45
3.7.7 Shut Down.....	45
3.8 Information.....	46
3.8.1 HDD Information.....	46
3.8.2 BPS.....	46
3.8.3 Log.....	47
3.8.4 Version.....	47
4 Quick Start.....	48
4.1 Startup.....	48
4.2 Login.....	48
4.3 Shutdown.....	48
4.4 Power Recovery.....	48
4.5 Battery Replacement.....	48
5 FAQ.....	49
6 Web Server Client.....	51
6.1 Internet Explorer Setting.....	51
6.2 Login.....	52
6.3 Web Server Client Screen.....	52

Contents

6.4 Menu Bar.....	53
6.5 Preview Mode.....	54
6.6 Video Connection	54
6.7 PTZ Control	55
6.8 Screen Settings and Others	56
6.9 System Information.....	57
6.10 System Setting.....	58
6.11 Alarm Function.....	59
6.12 Advance Option	59

1 Device Description

1.1 NVR Overview

NVR is short for network video recorder.

The NVR is a surveillance host connected to front-end audio/video acquisition devices and alarm devices over IP network and providing the functions of browsing, recording, playback, camera control, and alarming.

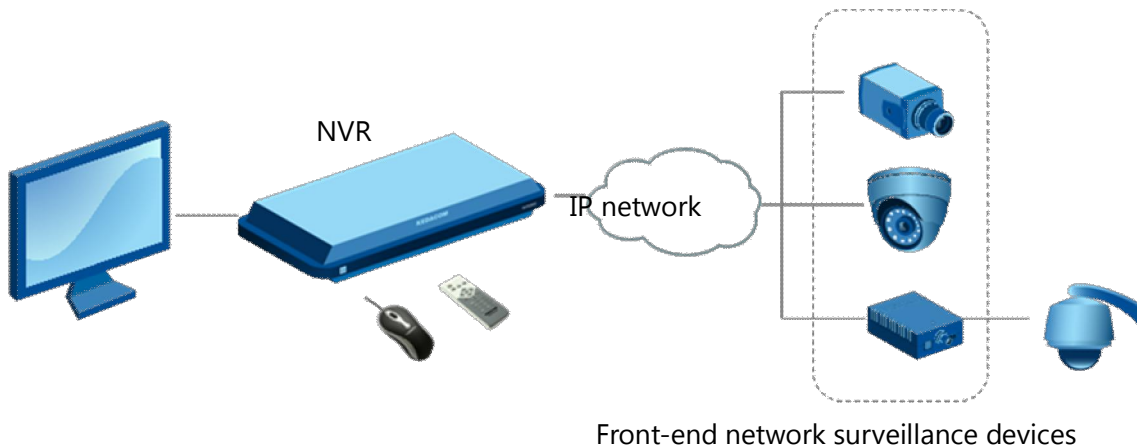

The core value of the NVR lies in that it is a type of video middleware compatible with the coding modes of various digital devices. This provides the advantages of distributed architecture and modular access over network.

1.2 Functions and Features

Basic functions

- Embedded Linux operating system.
- Real-time recording for four 720P digital video inputs with the NV0402S, or real-time recording for eight 720P digital video inputs with the NV0804S.
- One VGA video output, with VGA, CVBS, and HDMI (optional) outputs supported.
- One audio output.
- Synchronous recording and playback in one channel.
- Intercom.
- Built-in web server for remote control and management.
- Preview on mobile phones (iPhone, Android-based phones, and BlackBerry).
- Multiple DDNSs supported (Peanut Hull, 3322, and dyndns).
- TB-level large-capacity hard disks.
- Digital amplification in local areas by using a mouse.

- Multi-level user rights management, ensuring system security.

Storage and backup function

- Two built-in SATA disk interfaces on the NV0402S and four built-in SATA disk interfaces on the NV0804S, supporting TB-level hard disks.
- Backup based on USB interfaces (such as common USB flash drives and mobile hard disks).
- Download from hard disks over network and backup on a client.
- Non-working disks in hibernation, facilitating heat dissipation, reducing power consumption, and extending the service life of hard disks.
- Overwrite cyclic recording and non-cyclic recording for files on hard disks.
- Dedicated storage format for data, preventing tampering and ensuring data security.

Network function

- One 10M/100M Ethernet interface.
- Parameter setting, real-time video/audio signal browsing, and NVR status check on web pages
- Control over rotation of the pan tilt zoom (PTZ) and camera parameters (such as the aperture and focal length) on the web.
- Alarm handling and system logs check.
- Records search and real-time playback.
- Multi-level user management, enabling flexible and convenient settings of users and user groups with different rights.
- Powerful networking functions and multiple networking modes supported.
- Multi-screen display in remote access over Internet.

Record playback function

- Multiplexing, supporting independent real-time recording in each channel, multi-channel search, and single-channel playback at the same time.
- Multiple record modes (for example, manual mode and action with alarm) and pre-recording function.
- Quick search for record files and classification search based on record types.
- Multiple playback modes, including the slow motion, fast forward, reverse play, and frame-by-frame play modes.
- Display of the accurate event time during the playback of a record.
- Local amplification of any area on the screen during single-screen and full-screen playback
- Search for files on a digital video recorder over network during playback.

Real-time surveillance function

- High-definition, fine, and soft images on the system screen.

- Display of channel status (for example, recording and video loss) on the channel screen.
- Single-screen display, multi-screen display, and multi-channel tour.
- Free adjustment of the brightness, contrast, saturation, and tone of preview images.
- Display of the camera name, time, and date on the screen of each digital channel, and free adjustment of the positions of the preceding items.
- VGA output interfaces, providing the surveillance function with monitors.
- Real-time display of recording code streams and space occupied per hour.
- Check of local and remote system logs supported.

Voice function

- One audio output.
- Intercom.
- Synchronous audio and video storage in each channel.
- Synchronous audio and record playback.

Alarm function

- One relay alarm output.
- Pre-recording against alarms, pre-storing records collected before an alarm is generated, with configurable pre-recording time.
- Protective circuits for alarm output interfaces, protecting main devices against damage.

Intelligent operation function

- Operations with a mouse supported.
- Local amplification of any area on the screen during playback.
- Copy and paste of the same settings supported on the menu.

1.3 Hardware Environment

- **Power supply:** 12V DC.
- **Cable connection:** Cat 5 network cables and standard AV cables.
- **Temperature:** Keep the operating temperature within the range from 0°C to 50°C. The device may fail when the temperature exceeds the upper or lower limit. Do not install the device above a heat source.
- **Humidity:** Keep the humidity within the range from 10% to 90%. Do not expose the device to rain or damp environment. Moisture may damage internal components of the device. Do not install the device close to a water source.
- **Ventilation:** Install the device in a place with proper ventilation and take dustproof measures.
- **Installation mode:** Install the device horizontally or in a cabinet. Equip the device with a protective enclosure in outdoor environment.

1.4 Software Environment

- **Operating system:** embedded Linux.
- **Firmware:** The latest firmware shall conform to that published on the website. Customized firmware shall conform to the constraints.

1.5 Network Protocols

- Multiple network protocols, including TCP/IP, HTTP, TCP, UDP, ARP, SMTP, FTP, DHCP, DNS, DDNS, NTP, and UPNP.
- Standard ONVIF protocol.

1.6 Appearance

- **VSR0402/VSR0804**

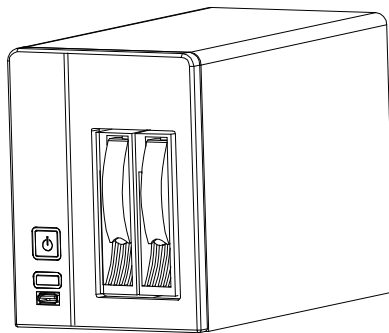

VSR0402

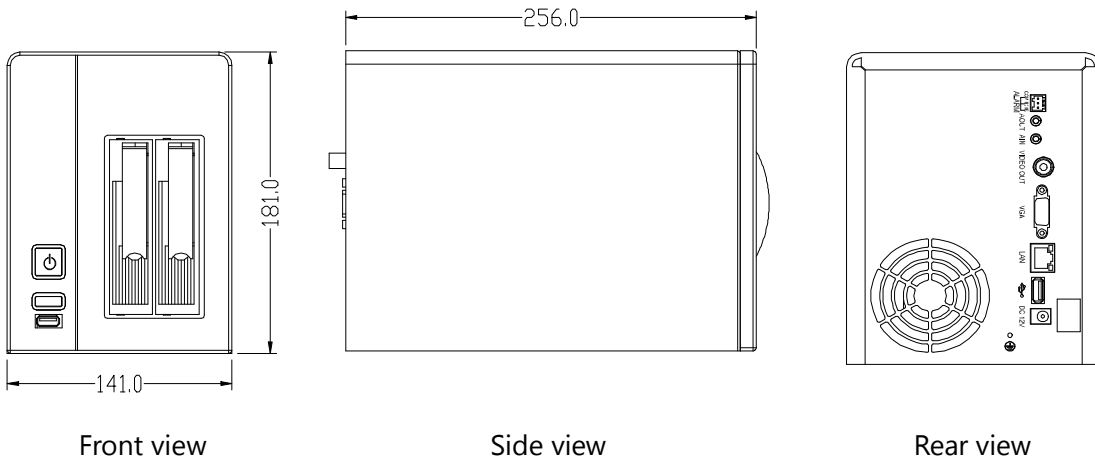

Front view

Side view

Rear view

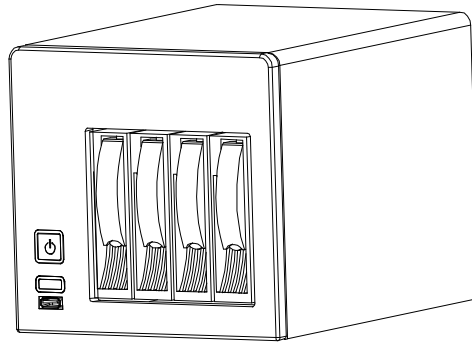

VSR0804

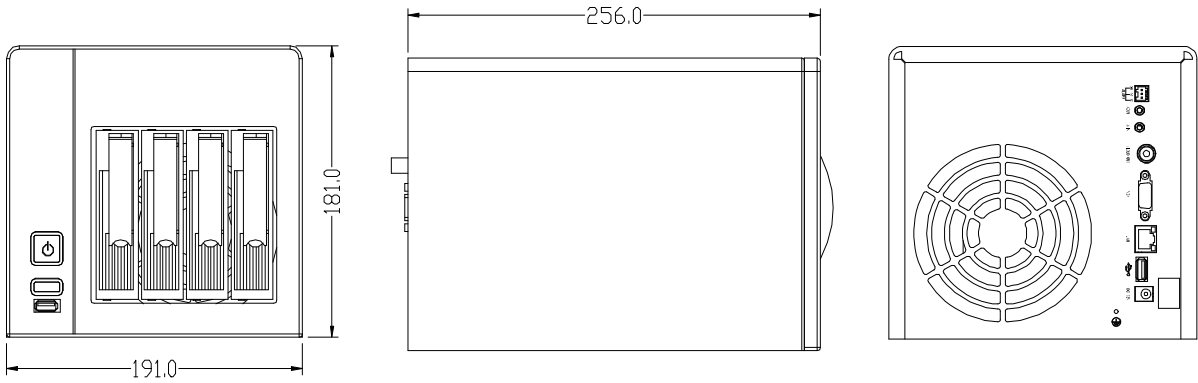

Front view

Side view

Rear view

● **HVR0402/HVR0804**

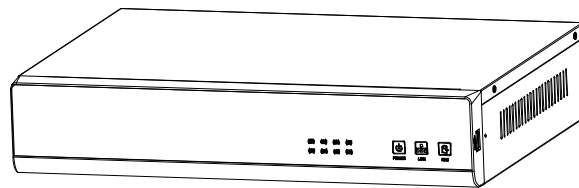

HVR0402 / HVR0804

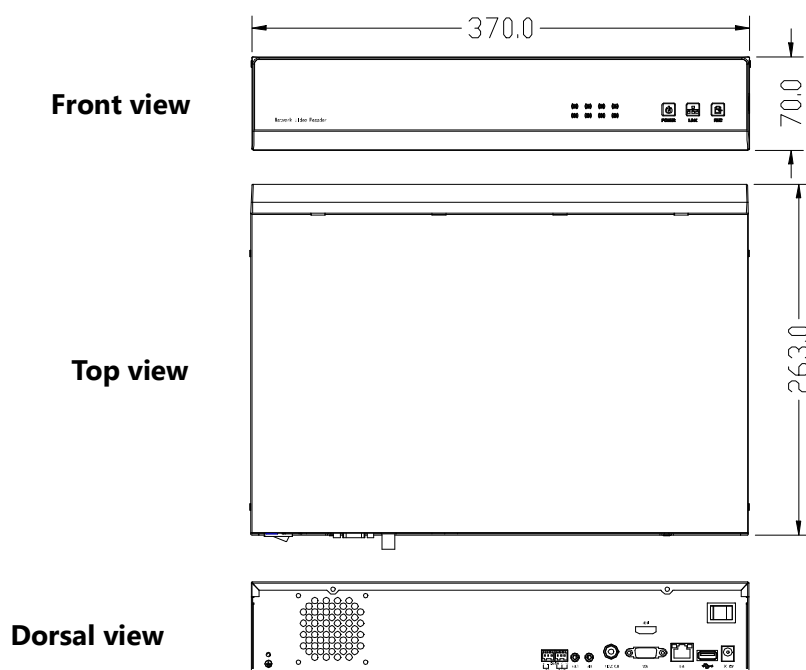

1.7 Technical parameters

Model	VSR0402	HVR0402	VSR0804	HVR0804
Main processor	Embedded micro-controller			
Operating system	Embedded Linux operating system			
Simplex/duplex/triplex	Pentaplex (recording, playback, backup, network, and preview)			
Operation method	Mouse			
Operating language	14 languages, such as Chinese Simplified, English, and Spain			
Display/preview	Display/preview resolution of screen 1 (1280 x 720 (720P)) and screen 4 (704 x 576 (D1))			
Record resolution	Four-channel recording: 1280 x 720 (720P)			
Playback resolution	Single-channel playback: 1280 x 720 (720P)			
Video/audio coding	H.264 (video) and G.711 (audio)			
Record mode	Manual, alarm, motion detection, and scheduled			
Record search mode	Time-based search, calendar-based search, event-based search, and channel-based search			
Record storage mode	Local hard disks and network			
Backup mode	Network and USB			
High-definition access	Four-channel, 720P		Eight-channel, 720P	
Video output	One BNC output and one VGA output (1280 x 1024)			
HDMI output	Optional			

Model	VSR0402	HVR0402	VSR0804	HVR0804
Audio input/output	No input and one output	2 input and 2 output	No input and one output	2 input and 2 output
Network interface	RJ45 10M/100M adaptive Ethernet interface			
485 interface	None	√	None	√
USB interface	Two USB 2.0 interfaces			
Hard disk	Two SATA interfaces Two 2 TB large-capacity hard disks		Four SATA interfaces Four 2 TB large-capacity hard disks	
Power supply	12 V DC±10% (external power supplies), 3 A			
Power consumption	< 20 W (without hard disks)			
Operating temperature	0°C to 50°C			
Operating humidity	10% to 90%			

1.8 Panels

1.8.1 Front Panel

- **VSR0402/VSR0804**

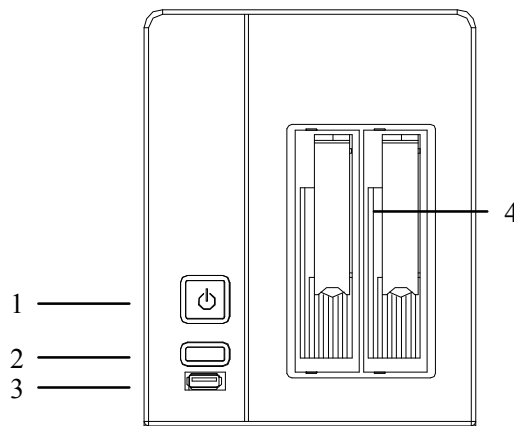

Front panel of the NV0402S

	Item	Description
1	Power button	Used to power on and power off the system
2	Reset button	Used to restart the device
3	USB interface	Used to connect a mouse
4	Disk slot	Used to hold a hard disk (A screw hole is available on the top of at the bottom of the slot. You can fix the hard disk by tightening the screw.)

- **HVR0402/HVR0804**

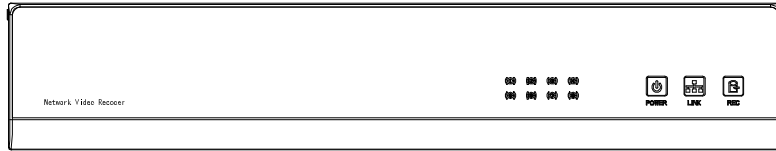

NVR Series Front Panel Diagram (Take NV0804 as an example)



Name/Mark	Instruction
①	Video connection indicators: Continuous blue light indicates successful video connection of corresponding channels.
②	
③	
④	
⑤	
⑥	
⑦	
⑧	
POWER	Power indicator: Continuous blue light indicates the power is ready.
LINK	Network indicator: Continuous blue light indicates the network is connected.
REC	Hard disk video recording indicator: Continuous blue light indicates the hard disk is recording.

1.8.2 Rear Panel

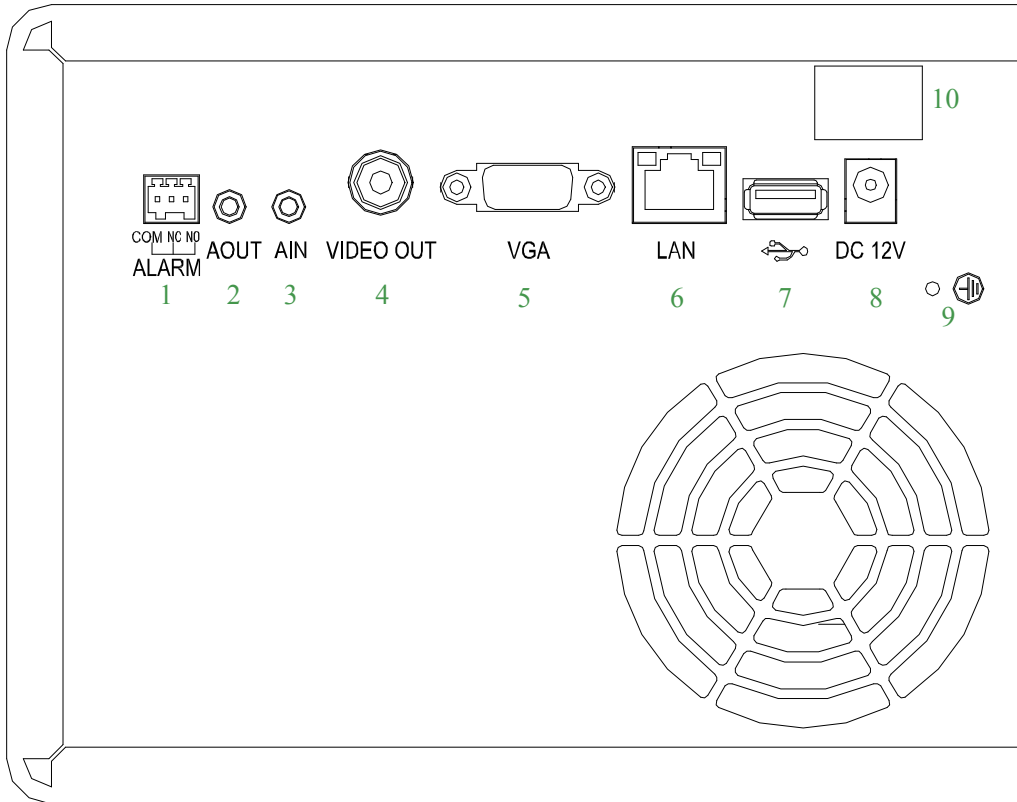
- VSR0402/VSR0804





Rear panel of the NV0402S

	Item	Description
1	ALARM (COM, NC, NO)	Alarm output interface COM: common terminal, NC: normally closed, NO: normally open
2	AOUT	Audio output interface
3	AIN	Voice input interface
4	VIDEO OUT	CBVS video output interface
5	VGA	VGA video output interface
6	LAN	RJ45 adaptive Ethernet interface
7		USB interface
8	DC 12V	12 V DC power interface
9		Grounding copper bar
10		Main power switch

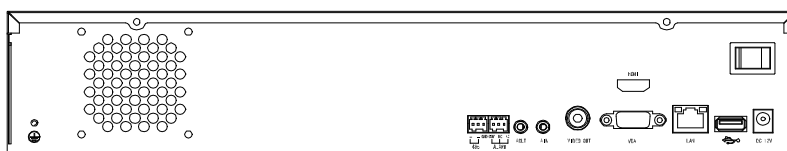
● HVR0402/HVR0804

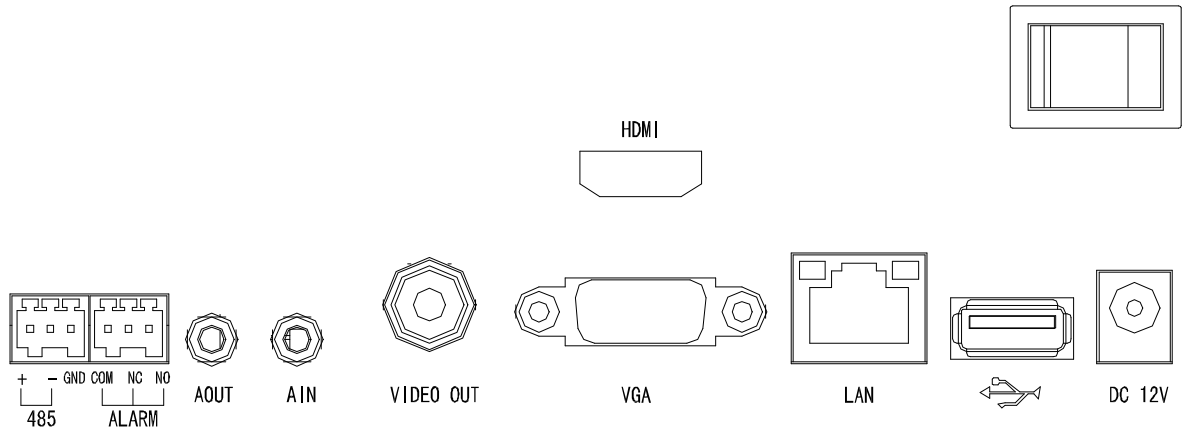



Name/Mark	Instruction
A1, GND	Alarm Input Interface 1
A2, GND	Alarm Input Interface 2
(485A, 485B)	485 Interface
(COM1, NO1, NC1)	Alarm Input Interface 1 COM1, NC1 Normal Close, NO1 Normal Open
(COM2, NO2, NC2)	Alarm Input Interface 2 COM2, NC2 Normal Close, NO2 Normal Open
ALARM (COM, NO, NC)	Alarm output interface COM indicates a common port; NC indicates being normally closed, and NO indicates being normally open.
AOUT	Audio output interface
AIN	Audio input interface
VIDEO OUT	CBVS video output interface
VGA	VGA video output interface
LAN	RJ45 auto negotiation Ethernet port
	USB interface
DC 12V	DC12V power interface
HDMI	HD video output interface
	Main power switch

1.9 Mouse Functions

***This document assumes that you operate the mouse with your right hand.**

To perform operations on menus by using a mouse, connect the mouse to the USB interface of the

device.

Description of mouse functions







Click	When you have not logged in to the system, a password text box is displayed after you click on the screen.
	A menu is displayed when you click a menu icon.
	This action allows you to perform operations instructed on the controls.
	This action allows you to change the status of a checkbox or a motion detection area.
	A drop-down list is displayed when you click a combo box.
	In a text box, you can select an input method, for example, numeric input, character input, uppercase/lowercase English letter input, or Chinese input. You can type a character by clicking it on the panel. ← indicates a backspace, and _ indicates a space. In an edit box, ← indicates the input of a space, and _ indicates the deletion of the character before the cursor. In a numeric box, ← indicates zeroing out, and _ indicates the deletion of the last digit. You can type only digits (for example, the standby time in common setting) in a numeric box. You can type any characters (for example, a channel name) in an edit box.
Double-click	This action allows you to perform special operations of controls. For example, you can double-click an option in a record file list to play back the record.
	In multi-screen mode, when you double-click a specific screen, the screen is displayed in full-screen mode. When you double-click the screen again, it returns to the multi-screen mode.
Right-click	When you right-click the screen during real-time surveillance, a shortcut menu is displayed, providing the multi-screen mode, image color, record search, manual recording, alarm input, alarm output, and main menu options. The multi-screen mode is relevant with the number of channels on the device. For example, a four-channel device displays only a single screen or four screens. The image color applies to the channel that the cursor indicates. In multi-screen mode, the system automatically switches to the single screen of the corresponding channel before the setting of the color image.
	This action allows you to exit the current menu without saving the settings.
Scroll	This action allows you to increase or decrease the number in a numeric box.
	This action allows you to switch between options in a combo box.
	This action allows you to page up and page down in a list box.
Move	You can select a control or a component of a control in the current coordinates and move it by using the mouse.
Drag	This action allows you to select motion detection areas, area settings, and area coverage.

 **Note:** If a mouse cannot be detected after you connect it to the NVR, the mouse is incompatible with the NVR. Replace the mouse.

1.10 Input Methods



In a text box, you can select an input method, for example, digit input, character input, uppercase/lowercase English letter input, or Chinese input. You can type a character by clicking it on the panel.

Icon	Description	Icon	Description
	Lowercase English letter input status		Numeric input status
	Uppercase English letter input status		Chinese (full spelling) input status
	Deletion key: to delete the character before the cursor		Space key
	Special character input status		

2 Installation and Cable Connection

Note the following during the installation:

1. Take out all materials required for the installation.
2. Connect cables (video signal input cables, audio signal input cables, and network cables) as required.
3. Connect the rear panel, front panel, and power supply in sequence.
4. Take out the regulated power adapter or power cable and connect the power supply.

2.1 Hardware Installation

Check After Unpacking

- After you receive the product, check the appearance to see whether it is damaged during the transportation.
- Open the packing box and check the accessories according to the packing list.
- Remove the protective film from the product.

Front Panel and Rear Panel

- Read the descriptions of buttons on the front panel and interfaces on the rear panel in the instruction.
- Check the model on the protective film of the front panel against the order contract.
- Keep the label on the rear panel intact. It is required for after-sales services. Do not tear down or discard the label. Otherwise, no warranty service will be provided. When you call after-sales personnel of the company, provide the serial number of the product.

Internal Check

Check for damage and scratches. Check whether data cables, power cables, and fan power supplies are connected to the main board on the front panel properly.

Precautions (Contact us if you have any doubt)

1. After unpacking, ensure that the materials are consistent with the packing list.
2. Check the voltage, avoiding device damage caused by improper voltage.
3. Check the installation environment. Do not use the device in damp or high-temperature environment. Ensure proper ventilation and keep the air vents unblocked. Lay the device horizontally. Do not install the device in environment with sharp vibration.

2.2 Hard Disk Installation

Check whether hard disks are installed when you install the device for the first time. The NVR supports

TB-level hard disks. Use recommended models of hard disks (7200 rpm or above high-speed hard disks) and SATA disk cables delivered with the device.

● **VSR0402/VSR0804**

To install a hard disk on the VSR0402, perform the following operations:

1. Press the button at the bottom of a disk slot to eject the disk slot.

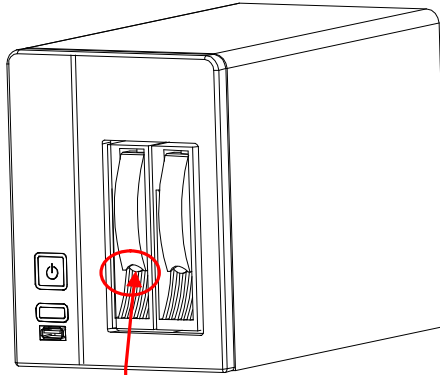

2. Pull the disk slot out of the shelf, install a hard disk in the disk slot, and fix the hard disk using two screws.

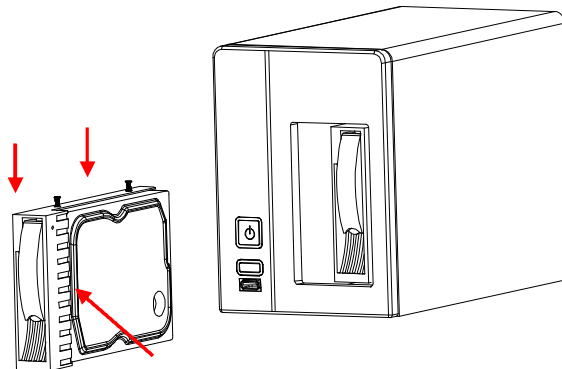

3. Insert the disk slot in the shelf. If a sound is generated, the disk slot is inserted properly.

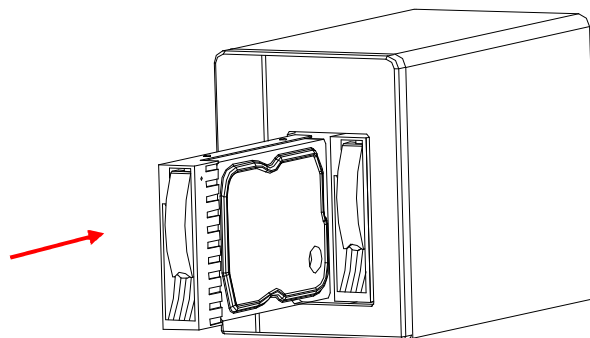

● **HVR0402/HVR0804**

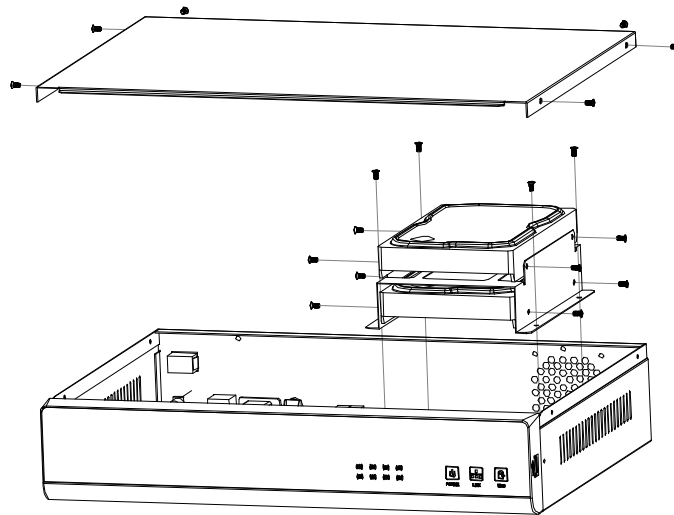

1. Unscrew the screws, and remove the cover.
2. Unscrew the hard disk slot screws, and take out the hard disk slot from the chassis.
3. Put a hard disk in the hard disk slot and fix the hard disk into the hard disk slot with screws.
4. Install the hard disk slot into the chassis, and fix it with screws.
5. Install the cover, and fix it with screws.

2.3 Device Installation

Procedure and precautions:

1. Lay the device on a flat and stable rack.
2. Ensure that the temperature in the room is below 35°C (95°F).
3. Leave a 15 cm (6 in.) space around the device for air circulation.
4. Install assemblies on the rack from bottom to top.
5. When multiple assemblies are installed on the rack, take proper measures to avoid overload of the power socket on the rack.

2.4 Video Input and Output Connections

Video input connections (LAN)

- Connect network cameras to the NVR. If only one network camera is available, connect it to the NVR directly through a network cable. If multiple network cameras are available, connect them to the NVR through a switch.

Video output connections (VGA, VIDEO OUT, HDMI)

- The NVR supports VGA and CVBS video outputs. You can use both output modes or use one of them.
- Dedicated monitors, computer displays, televisions, video matrixes, and high-definition large-screen

displays can be used as external display devices.

- To ensure the quality of images, use dedicated monitors.

Note the following when you use computer displays or televisions as monitors:

- Ensure proper grounding. Low-quality computer displays or televisions have electric leakage hazards, which may damage other devices.
- Perform degaussing regularly to ensure proper operating of the monitors.
- Keep the monitors away from devices that generate strong electromagnetic interference.
- Power off the device after operating for a period to extend the service life of the device.

2.5 Audio Input and Output Connections (AIN and AOUT)

Generally, the audio output signal parameter of the NVR is larger than 200 mV 1K. The NVR can be connected to external low-impedance headsets and active sound boxes directly or connected to other sound output devices through power amplification drives.

When the NVR is not isolated from external sound boxes or audio monitoring units, output squealing may occur. In this case, take the following measures:

- Adjust the volume of the sound box to be smaller than the threshold at which output squealing occurs.
- Adjust the layout of the audio monitoring units and sound boxes.
- Use sound-absorbing materials during decoration to reduce the reflection of sound and improve the acoustic environment.
- Use audio monitoring units with superb directionality.

2.6 Alarm Output Connections

1. Alarm output interface (one alarm output)

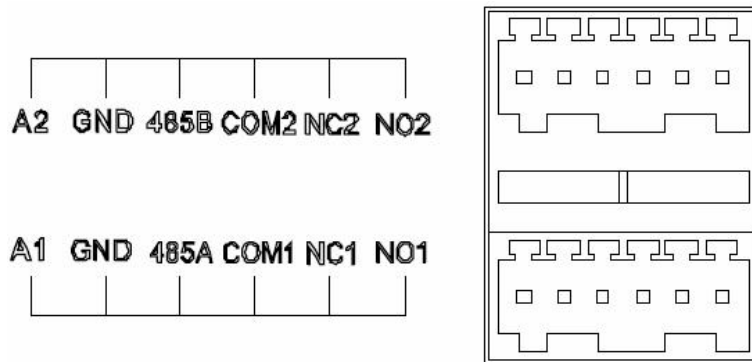

- As shown in the figure, COM1 is the common ground terminal, NC1 is the normally closed output terminal, and NO1 is the normally open output terminal.
- Power supplies must be connected to external alarm devices for the Boolean alarm output (NO contact).
- Grounding alarms are generated when the alarm circuit is directly connected to the ground.

- To protect the host against overload, read the relay parameters on the alarm output side in the following table before cable connection.

Model: HFD3		
Contact material	AgNi	
Rated values (Resistance load)	Rated switching capacity	30V DC 2A, 125VAC 0.5A
	Maximum switching power	60W/62.5VA
	Maximum switching voltage	220VDC, 250VAC
	Maximum switching current	2A
Insulation	Between contacts with the same polarity	1000 V AC, 1 minute
	Between contacts with different polarities	1500 V AC, 1 minute
	Between contacts and coils	2000 V AC, 1 minute
Surge voltage	Between contacts with the same polarity	1500 V AC (10 x 160 us)
Connection time	4ms max	
Disconnection time	4ms max	
Service life	Mechanical	100,000,000 times
	Electrical	100000 times (30 V DC, 2 A)
Operating temperature	-40°C to +85°C	

Parameters of relays on the alarm output side

2. Alarm output connection diagram

Generally, the alarm output terminal is disconnected. It is closed when an alarm needs to be reported. It does not provide voltage output, and external power supplies are required to ensure proper operating of external speakers, lights, and alarm devices. As shown in the following figure, the independent power supply terminal is connected to the positive and negative terminals of the external power supply.

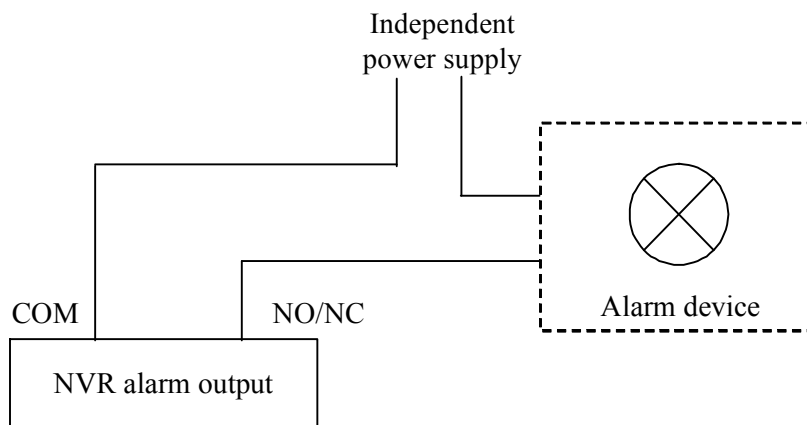

Precautions for alarm output connection:











- Do not connect the alarm output terminal of the NVR to high-power loads. (For details, see the relay













parameters on the alarm output side.)







- Protect relays again over current when you constitute an output circuit.
- Use contactors for isolation when high-power loads are connected.

3 System Menus

3.1 Main Menus

Main Menu	First-level Submenu	Description
Record 	Schedule 	It allows you to set the record mode (Timer , Motion , or Alarm) and set the time period for scheduled operations (recording, receiving external alarms, and enabling motion detection) everyday within a week.
	Search 	It allows you search for and play back records. You can search for a record based on the record type (All , Alarm , Motion , and All Alarms), channel, or time. The search results are displayed in a list. You can play back a record by double-clicking it. R indicates common records, A indicates alarm records, M indicates motion detection records, and H indicates manual records.
	Backup 	It allows you back up records. You can search for a record based on the record type (All , Alarm , Motion , and All Alarms), channel, or time. The search results are displayed in a list. You can click and back up a record.
Alarm 	Motion Detection 	It allows you to set the detection areas and sensitivity of the front-end IPC.
	Alarm Input 	It allows you to set the channel, enable switch, alarm input type, alarm time, output delay and mode, action with alarm, alarm record delay, and tour when alarm input signals are available on the NVR. You can copy parameter settings of channels.
	Network Alarm 	It allows you to set the channel, enable switch, alarm input type, alarm time, output delay and mode, action with alarm, alarm record delay, and tour when alarm input signals are available on the front-end IPC. You can copy parameter settings of channels.
	Alarm Output 	It allows you to set the alarm output mode, configurations, switch, and alarm state of the NVR.
	Abnormity	It allows you to set the enable switch and action with abnormality (such as alarm output, alarm output delay, screen prompt, and email).
	Digital Alarm 	It allows you to set the channel, enable switch, alarm time, output delay, action with alarm, alarm record delay, tour, and screen capturing when video signals are lost. You can copy parameter settings of channels.

Main Menu	First-level Submenu	Description
Setting 	General 	It allows you to set basic parameters, including the system time and date formats, language, record storage mode, device No., video format, display, and standby time.
	Network 	It allows you to set the IP address, subnet mask, default gateway, transmission terminal, and number of access users, email, DNS, DDNS, PPPoE, UPNP, IP privilege, NTP, FTP, RTSP, auto registration, and management of online users.
	Display 	It allows you to: set the channel names, time titles of analog and digital channels, channel titles, record state, and alarm state; adjust TVs; modify the transparency and the positions of time titles and channel titles.
	Account 	It allows you to maintain user groups and user accounts. You can add, modify, and delete users and modify passwords.
	PTZ 	It allows you to set PTZ parameters, such as the protocol, address, baud rate, data bits, stop bits, and parity.
	Tour 	It allows you to set the preview screen, tour type, and interval.
Advanced 	HDD Manage 	It allows you to manage hard disks and clear data from hard disks.
	Digital Channel 	It allows you to set the following parameters of a digital channel: enable switch, device type, decoding policy, audio/video, channel types and code stream types of remote devices, IP addresses and port IDs of remote devices, user accounts, and preset points. You can search for IP addresses of the devices on the LAN.
	USB Update 	It allows you to update the kernels, U-Boot, configurations, application programs, and file systems by using the upgrade file.
	Configuration 	It allows you to save system configurations as a configuration file and import/export system configurations for quick settings.
	Maintenance 	It allows you to set automatic system restart and file deletion.
	Default	It allows you to restore all or part of the configurations to default configurations.

Main Menu	First-level Submenu	Description
		Note: This function is not applicable to user accounts.
	Shut Down 	It allows you to log out of, shut down, and restart the system.
Information 	HDD Information 	It allows you to check the status of the SATA interface and the total space, free space, record start/end time, and record type of all hard disks or a specific hard disk.
	BPS 	It allows you to check the current code stream size of each channel and the estimated disk space occupied per hour.
	Log 	It allows you to check the logs of critical system events and specify the logs to be recorded.
	Version 	It allows you to check the hardware features and the software version and release date.

3.2 Shortcut Menus

Shortcut Menu	Description
Record Playback	It allows you to quickly access the record playback screen and play back records.
Record Control	It allows you to control the record mode, configure recording for each channel, and enable/disable recording.
Record Backup	It allows you to quickly access the record backup screen and back up records.
Alarm Output	It allows you to quickly access the alarm output setting screen, enable/disable alarm output, and set the alarm output status.
Pan/Tilt/Zoom	It allows you to quickly access the PTZ control screen and configure the preset points, tour routes, focus, and auxiliary operations.
TV Adjust	It allows you to quickly access the TV adjustment screen and set the top, bottom, left, and right edge spacing for TV output.
Logout	It allows you to quickly access the system shutdown screen and perform the shutdown, restart, log-out, and switchover operations.
Screen Switchover	It allows you to switch among single-screen, 4-screen, 8-screen, 9-screen, 16-screen, and 25-screen modes.
Mute	It allows you to disable the alarm buzzer. (The alarm buzzer is disabled by default.)

Notes:

For details about record playback, see section **3.4.2 Record Playback**.

For details about record backup, see section **3.4.3 Backup**.

For details about alarm output, see section **3.5.4 Alarm Output**.

For details about TV adjustment, see section **3.6.3 Display**.

For details about system shutdown, see section **3.7.7 Shut Down**.

3.2.1 Record Control



Channel: All channel numbers of the device are listed. The number of channel numbers is consistent with the maximum number of channels supported by the device.

Status: The current status of the corresponding channel is displayed. A channel may be in the **Always**, **Config**, or **Close** status. Selected channels are marked by ●.

- **Always:** This status has the top priority. After the **Always** status is enabled, common recording is enabled in corresponding channels despite the status of the channels.
- **Config:** It enables recording based on the **Timer**, **Motion**, and **Alarm** settings on the **Record Setting** screen.
- **Close:** It stops recording in all channels.

Start All: It enables recording in all channels.

Stop All: It stops recording in all channels.

1. Start/stop recording in one or more channels.

Before you start/stop recording in a channel, check the record state (○ or ●) of the channel. ○ indicates that the channel is not in the recording state, and ● indicates that the channel is in the recording state.

If **Always** is marked by ● for a channel, automatic recording is enabled for the channel. If **Close** is marked by ● for a channel, automatic recording is disabled for the channel.

If **Config** is marked by ● for a channel, scheduled recording is enabled for the channel. If **Close** is marked by ● for a channel, scheduled recording is disabled for the channel.

You can start/stop recording in other channels by repeating the preceding operations.

2. Start recording in all channels.

To enable automatic recording in all channels, select **Always** (●) for **All**. After automatic recording is enabled in all channels, the NVR starts recording based on the **Timer**, **Motion**, and **Alarm** settings on the **Record Setting** screen and provides automatic recording channels.

To enable scheduled recording in all channels, select **Config** (●) for **All**. After scheduled recording is enabled in all channels, the recording stops in all channels despite the scheduled settings on the **Record Setting** screen.

3. Stop recording in all channels.

To stop recording in all channels, select **Close** (●) for **All**. Recording then stops despite the status of the channels.

3.2.2 PTZ Control



Direction Control: Control the pan/tilt direction of the PTZ as instructed by the arrows (top, top right, top left, left, right, bottom right, bottom left, and bottom). You can control a direction by clicking the corresponding arrow and hold. When you release the mouse, the direction is not under control.

Speed: Control the speed when the PTZ moves up, down, left, and right or in tour mode. It ranges from 1 to 8. The larger the value, the higher the pan/tilt speed.

Zoom: When the camera lens provides the electric focusing function, click – to move the focus forward to obtain a clearer image and click + to move the focus backward to make the image blurry.

Focus: When the camera lens provides the electric zooming function, click – to zoom in to monitor remote scenes or click + to zoom out to monitor nearby scenes.

Iris: When the camera lens provides the electric iris function, click – to reduce the aperture or click + to enlarge the aperture.

Next Page: Click this button to go to the next page on the PTZ.

Set: Click this button to go to the PTZ Set screen. You can set **Preset**, **AutoScan**, **Pattern**, **Border**, and **Tour**.

Preset: Type a value for **Preset**. The PTZ then turns to the preset position.

Pattern: Type a value for **Pattern**. The tour track of PTZ cameras is invoked.

Tour: Type a value for **Tour**. The tour route of PTZ cameras is invoked.

AutoScan: Enable linear scanning for PTZ cameras.

AutoPan: Enable PTZ cameras to rotate horizontally.

Flip: Enable PTZ cameras to flip.

Reset: Reset the PTZ to the power-on state.

Direct Aux Oper: Start or shut down auxiliary devices. If a camera is connected to external lights, click **On** to turn on the lights or click **Off** to turn off the lights.

Aux Num Oper: If the PTZ is connected to multiple auxiliary devices, click **On** to start the auxiliary devices or click **Off** to shut down the auxiliary devices.



Preset: Set the No. of a preset point.

Name: Set the name of a preset point.

Set: Set the current position to a preset point by clicking this button.

Del Preset: Delete the current preset point by clicking this button.

Click a PTZ camera channel where you want to create a preset point. Control the horizontal and vertical positions of the PTZ camera. Type the No. and name of the preset point. Click **Set**. The preset point is created successfully. You can click **Del Preset** to delete the preset point.



Pattern: Set the number of the tour track.

Start: Set the start point of the tour track.

End: After you click **Start**, the PTZ starts pan/tilt. Return to the setting screen, click **End** and set the end point of the tour track.

Click a PTZ camera channel where you want to set the tour track. Control the horizontal and vertical positions of the PTZ camera. Type the No. of the tour track. Click **Start** and set the start point of the tour track. Make the PTZ move along the expected tour route. Click **End**. The tour track is set successfully.



Border: Set the number of the tour track.

Left: Set the left border of the tour track.

Right: Set the right border of the tour track.

Click a PTZ camera channel where you want to enable AutoScan. Set the left border and right border, that is, set an AutoScan route.



Patrol No.: Select the No. of a tour route.

Add Preset: Select a preset point that you want to add to the tour route.

Del Preset: Delete a preset point from the tour route.

Del Tour: Delete the current tour route.

3.3 Main Menu Operations

Right-click on the screen and choose **Main Menu** from the shortcut menu that is displayed. In the **SYSTEM LOGIN** dialog box that is displayed, set **User Name** and **Password** and click **OK**. Main menus are displayed, including **Record, Alarm, Setting, Advanced, and Information**.

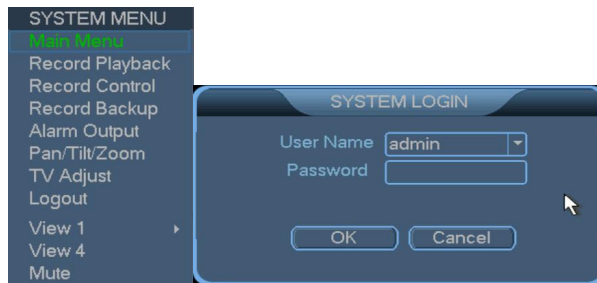



The following table describes common identifiers on menus.

Identifier	Name	Description
	Active page	Lower-level menus are displayed when you move the cursor on a menu icon.
	Check box	It is used to select or deselect a function. If it is filled, the function is selected. If it is not filled, the function is not selected.
	Drop-down list box	At least two options are available in a drop-down list box, and only one option can be selected.
	Edit box	Letters, texts, and symbols in an edit box are editable.
	Button	It is used to execute a function or go to a lower-level menu.

The following table describes common buttons on menus.

Button	Function
	To save parameter modifications on a menu
	To save the parameter settings on a menu and go to the upper-level menu.
	To go to the upper-level menu without saving the parameter settings on a menu.

Button	Function
	To restore the parameter settings on a menu to the default configurations.
	To copy the parameter settings of a channel.
	To paste the copied parameters settings to a channel.

 **Notes:**

(1) Two default users are available in the system: user **admin** and user **guest**. The default password of the two users is **123456**.

(2) Settings on sub menus take effect only after you click **Save** or **OK**.

3.4 Record

 **Note:** You are required to have the rights for recording. Before recording, ensure that hard disks are installed and formatted properly.

This function allows you to set and play back records. For example, you can set recording to the **Timer**, **Motion**, and **Alarm** mode. You can also search for records based on the record type (all, external alarms, video detection, all alarms, and manual records), channel, and time. The search results are displayed in a list.



3.4.1 Schedule

When you start the NVR for the first time, it works in 24-hour continuous recording mode by default. Choose **Main Menu** > **Record** > **Schedule**. You can set scheduled continuous recording, that is, continuous recording within a preset time period, including time settings for common records (R), motion detection records (M), alarm records (A), and manual records (H).



Channel: Select a channel No. and set the channel. To set all channels at a time, select **All**.

Pack Duration: Set the length of a single record file.

Pre-Record: Record the scenes before the specified action occurs.

Record Control: Only one option can be selected. The selected option is marked by ●. The **Config**, **Always**, and **Close** options are available.

Week Day: Select a date for channel settings. To apply the channel settings to all dates, select **All**.

Schedule: Enable a record state in the current channel within the schedule. The selected status is marked by ■. The **CMN**, **MD**, and **Alarm** statuses are available. You can select one or more statuses. Six schedules are provided. The time in different schedules can be the same for a record state. The time ranges from 00:00 to 24:00. Click **Save** after all channels are set properly.

Quick setting:

1. You can copy the record settings of one channel to another. For example, select channel 1, set the record state, clicks **Copy**, switch to channel 3, and click **Paste**. The record state of channel 5 becomes the same as that of channel 1.
2. You can save the settings of each channel independently or save the settings of all channels at a time.

Notes:

(1) You can copy the record settings of one channel to another. After screen modification, the **Copy**, **Paste**, and **Default** buttons are still available, but you can only copy or paste the same type of settings. For example, the copied video loss setting cannot be pasted to the block detection field, and the block detection setting of channel 1 can be copied and pasted only to the block detection field of other channels.

(2) Channel settings can be copied and pasted. However, during video detection setting, parameters in the motion detection area cannot be copied, because video contents in each channel are different.

(3) Channel types and detection types are varied. The **Default** operation applies only to the detection type of the current channel. For example, when you perform the **Default** operation on the block detection screen, the operation takes effect only on the current screen and does not affect the settings of other detection types.

3.4.2 Record Playback

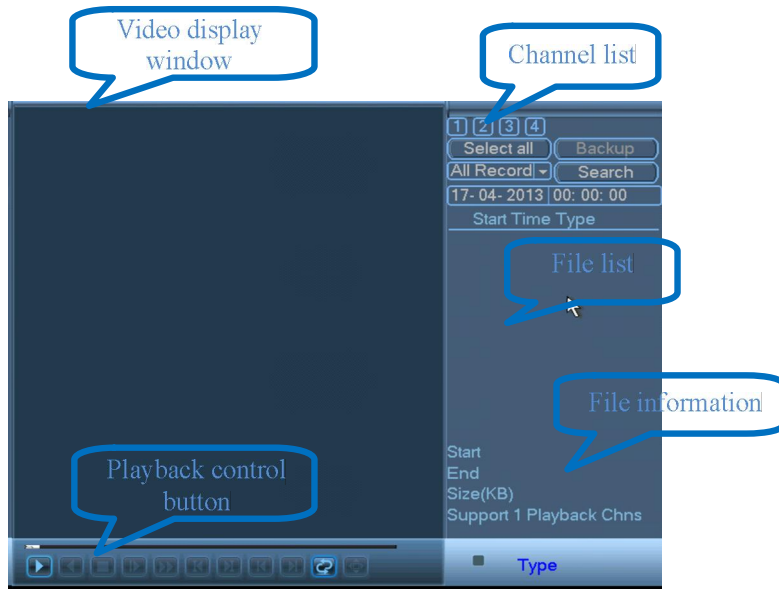

Record search

Record Search	Description
Record Playback menu	Choose Main Menu > Record > Record Playback . The Record Playback menu is displayed. Note: You need to type a password if you have logged out of the system.
Record playback operation (Local single-screen playback and multi-screen playback)	You can search for records based on the record type (all, external alarms, video detection, all alarms, manual records), channel, and time. The search results are displayed in a list. 128 record files are displayed on the screen. You can scroll the screen by using a mouse and view the files. You can play a record file by clicking it. Notes: 1. R indicates common records, A indicates external alarm records, M indicates motion detection records, and H indicates manual records. 2. You can select one or two channels for playback. If you select two channels, the record files in two windows can be played at the same time.
Playback operational area	The channel, date, time, play speed, and play progress are displayed on the screen during playback. You can control the play speed, enable cyclic play (automatic cyclic play of record files that meet the search criteria) and full-screen display, and hide or show the playback status bar. Note: In full-screen mode, control buttons are automatically hidden and are displayed when you move the mouse.
Local amplification	During single-screen playback in full-screen mode, you can select any area on the screen by using the left button of the mouse and amplify the selected area by clicking in it. To exit the local amplified screen, right-click it.

Fast forward and slow motion during playback

Button	Description
Fast forward ►►	During playback, you can click this button to switch between fast forward modes, such as fast forward 1 and fast forward 2. This button also serves as the reverse switchover button of the slow motion button.
Slow motion ►▶	During playback, you can click this button to switch between slow motion modes, such as slow motion 2 and slow motion 1. This button also serves as the reverse switchover button of the fast forward button.
Play/pause ►	In slow motion mode, you can click this button to play or pause a record.
Previous/next	This button is available only in playback. To play the previous or next record in the same channel, click ◀◀ or ▶▶.

Reverse play and frame-by-frame playback

Button	Description	Remarks
Reverse play (playback control button ◀◀)	When you click ◀◀ on the playback control bar during normal play of a record file, the record file starts to be played in reverse. When you click ◀◀ again, the reverse play stops.	In reverse play or frame-by-frame play mode, you can click ► to switch to the normal playback status.
Manual frame-by-frame playback	When you pause a record file, you can press the right arrow key to enable frame-by-frame playback and press the down arrow key to play back the I frame.	

3.4.3 Backup

You can directly back up records to a local mobile storage device. The mobile storage device is hot swappable. It supports the FAT32 and NTFS file formats and provides unlimited capacity. To access the **Backup** screen, choose **Main Menu > Record > Backup**.

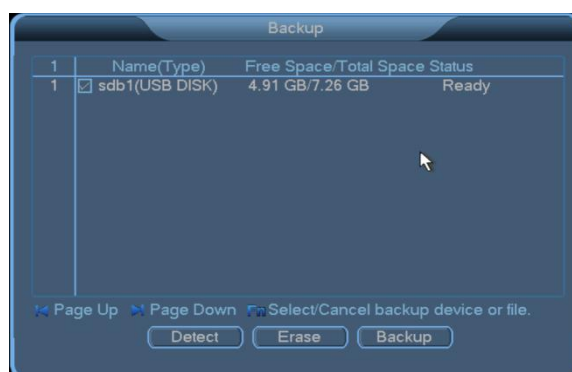

Detect: Detect the connected mobile storage device and display the name, type, free space, total space, and status of the device. You can move the cursor by using the up and down arrow keys and select/cancel backup by pressing the **FN** key.

Erase: Erase the data on the mobile storage device by formatting the device.

Backup: Click this button to access the **Backup** screen. The selected mobile storage device is displayed. You can set the record type, record channel, start time, and end time for the backup. You can move the cursor by using the up and down arrow keys and select/cancel backup by pressing the **FN** key.

 **Note:** On the **Record Playback** screen, you can back up a record file by selecting it and clicking **Backup**.

Clear: Clear the data in the storage space.

Start: Start the backup.

3.5 Alarm

The following sub menus are available: **Motion Detection**, **Alarm Input**, **Network Alarm**, **Alarm Output**, **Abnormity**, and **Digital Alarm**.



3.5.1 Motion Detection

To access the **Motion Detection** screen, choose **Main Menu > Alarm > Motion Detection**.

You can save the settings of each channel independently or save the settings of all channels at a time.



Channel: Select a channel for alarm setting.

Enable: It is used to enable a function. indicates that the function is enabled.

Schedule: Set the alarming time. Working days and non-working days can be selected. You can set six alarming time periods. Ensure that the alarming time periods are different. The alarming time periods are displayed in a straight line graph, and they can be copied to other dates.



Anti-dither: Set the anti-dither interval when alarm input occurs. It ranges from 0 second to 600 seconds.

Alarm Out: Start the device connected to the alarm output terminal when alarm input occurs. Select an alarm output channel.

Trigger Delay: Indicate that alarm output stops after alarm input stops for a while. It ranges from 10 seconds to 300 seconds.

Show Message: indicates that this function is enabled. Messages are automatically displayed on the screen when an alarm signal is generated.

Buzzer: indicates that this function is enabled. The buzzer (disabled by default) generates an alarm when an alarm signal is generated.

Send Email: indicates that this function is enabled. An email is sent to the specified address when an alarm signal is generated.

Record CHN: indicates that the action with alarm function is enabled. Select a channel to be enabled when an alarm signal is generated. Select **Motion** on the **Record Setting** screen and select **Always** on the **Record Control** screen.

PTZ Act: Set the alarming time for the PTZ when alarm signals are generated. Working days and non-working days can be selected. You can set six alarming time periods. Ensure that the alarming time periods are different. The alarming time periods are displayed in a straight line graph, and they can be copied to other dates.

Post-Record: Stop recording after alarm input stops for a while. It ranges from 10 seconds to 300 seconds.

Tour: indicates that a tour is enabled when an alarm is generated. Select a channel for the tour.

3.5.2 Alarm Input

To access the **Alarm Input** screen, choose **Main Menu > Alarm > Alarm Input**.

Connect alarm input devices and alarm output devices (such as lights and buzzers) properly according to appendix B.

You can save the settings of each channel independently or save the settings of all channels at a time.



Type: Set the type of alarm input devices to **Normal Open** or **Normal Closed**.

Note: Settings on the **Alarm Input** screen are similar to those described in section **3.5.1 Motion Detection**.

3.5.3 Network Alarm

To access the **Network Alarm** screen, choose **Main Menu > Alarm > Network Alarm**.



Type: Set the type of alarm input devices to **Normal Open** or **Normal Closed**.

Note: Settings on the **Network Alarm** screen are the same as those on the **Alarm Input** screen. For details, see section **3.5.1 Motion Detection**.

3.5.4 Alarm Output

To access the **Alarm Output** screen, choose **Main Menu > Alarm > Alarm Output**.



Alarm Type: Two alarm types are available. **All** indicates that all four outputs are selected. **1**, **2**, **3**, and **4** indicate outputs 1, 2, 3, and 4 respectively.

Config: ● indicates that the option is selected. If ● is marked for **All**, all four alarm outputs are configured. If ● is marked for **1**, **2**, **3**, or **4**, alarm output 1, 2, 3, or 4 is configured.

Always: ● indicates that the option is selected. If ● is marked for **All**, all four alarm outputs are always

enabled. If **•** is marked for **1, 2, 3, or 4**, alarm output 1, 2, 3, or 4 is always enabled.

Close: This option is used to disable alarm outputs.

Status: This option is used to display the alarm output status of the current device.

3.5.5 Abnormity

You can set the event type and associated actions on the **Abnormity** screen. Select **Enable**. When an abnormality occurs, the system automatically generates alarms, displays messages on the screen, and sends emails. To access the **Abnormity** screen, choose **Main Menu > Alarm > Abnormity**.

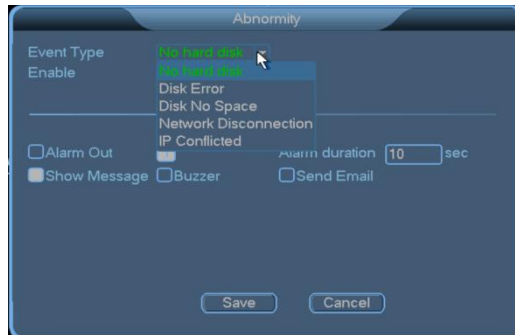

Event Type: Abnormity event types include **No hard disk, Disk Error, Disk No Space, Network Disconnection,** and **IP conflicted**.

No hard disk: No hard disk is installed on the NVR, or the hardware system is faulty and fails to detect hard disks.

Disk Error: Hard disks are faulty, or the system fails to detect hard disks.

Disk No Space: No storage space is available on the hard disks. (When **Event Type** is set to **Disk No Space**, the system prompts you to set the lower limit, that is, the percentage of the free disk space.)

Network Disconnection: The NVR is disconnected from the network, or network connection errors occur.

IP Conflicted: The NVR has a fixed IP address, which is the same as that of another device on the network.

Enable: It is used to enable a function. **■** indicates that the function is enabled.

Alarm Out: Start the device connected to the alarm output terminal when an abnormality occurs. Select one or more alarm output channels.

Show Message: **■** indicates that this function is enabled. Messages are automatically displayed on the screen when an alarm signal is generated.

Send Email: **■** indicates that this function is enabled. An email is sent to the specified address when an alarm signal is generated.

Alarm duration: set the alarm output delay. It ranges from 10 seconds to 300 seconds.

Buzzer: Enable the alarm buzzer. (The alarm buzzer is disabled by default.)

3.5.6 Digital Alarm

To access the **Digital Alarm** screen, choose **Main Menu > Alarm > Digital Alarm**.



Note: Settings on the **Alarm Input** screen are similar to those described in section **3.5.1 Motion Detection**.

3.6 Setting

The following sub menus are available: **General, Network, Display, Account, PTZ,** and **Tour**.

Note: You are required to have the rights for system setting.



3.6.1 General



System Time: It is used to modify the current system date and time of the NVR.

Date Format: It can be set to **yyyy mm dd**, **mm dd yyyy**, or **dd mm yyyy**.

Auto Logout: The standby time can be set to 0–60 minutes. **0** indicates that no standby time is specified. If the standby time is specified, you automatically log out of the system after the standby time elapses. To perform operations on the menus, you need to log in again.

Date Separator: Three types of separators are available.

Time Format: It can be set to **12-Hour** or **24-Hour**.

Language: At present, 14 languages are supported, including Chinese Simplified, English, and Spanish.

HDD Full: It can be set to **Stop** or **Overwrite**. The conditions for stopping recording are as follows: An overwrite operation is being performed on the current working disk, or the current working disk is full and the next disk is not empty. The conditions for overwriting are as follows: The current working disk is full, and the next disk is not empty. In this case, the earliest record file will be overwritten cyclically.

DVR No.: It indicates the number of the NVR. It allows you to control one or more NVRs by using a remote control. The address of the remote control must be corresponding to the value of **DVR No.**

DST: You can set the start time and end time by week or date.



Resolution: The resolution of videos can be set to **600*800**, **1024*768**, or **1280*720**.

3.6.2 Network



IP Address/Subnet Mask/Gateway: Set the IP address by using the numeric keys on the panel. Then set the subnet mark and gateway for the IP address.

 **Note:** The default IP address of the NVR is **192.168.1.88**, the default subnet mask is **255.255.255.0**, and the default gateway is **192.168.1.0**.

DHCP: indicates that dynamic address assignment is enabled, and fixed IP addresses are not used.

TCP Port: The default port ID is 34567. You can set the port as required.

HTTP Port: The default port ID is 80. You can set the port as required.

UDP Port: The default port ID is 37778. You can set the port as required.

Max Connection: It ranges from 0 to 50. If it is set to **0**, no access from users is allowed. A maximum number of 50 users can be connected.

ADVANCED SETTING: Double-click an option for further settings.

EMAIL



SMTP Server: Set an address for the SMTP server, for example, **smtp.xxxx.com**.

Port: Set a port ID for the mail server. The default value is **25**.

SSL: indicates that the Secure Sockets Layer (SSL) is required by the server.

User Name: It is used to log in to the mail server before you send an email from the mail server. It is verified during the login

Password: It is used to log in to the mail server.

Sender: It is an email address used to send alarm information.

Title: It is the title of alarm emails.

Receiver: It is an email address used to receive alarm information.

 **Note:** If the user name is a mailbox providing virtual functions, add the mailbox name extension when you type the user name, for example, xxx@yyy.com. If the user name is a mailbox not providing virtual functions, do not add the mailbox name extension when you type the user name, for example, xxx.

DNS

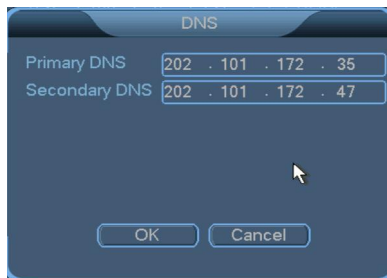

Primary DNS: It is set based on the local DNS address.

Secondary DNS: It is set based on the local DNS address.

DDNS

DDNS Type: It is the type of the DDNS service provider.

Enable: It is used to enable a function. indicates that the function is enabled.

Domain Name: It is the DDNS domain name bound to the device.

User Name: It is the user name that you use to register the DDNS domain name.

Password: It is the password that you use to register the DDNS domain name.

PPPoE

User Name: It is the ADSL user name.

Password: It is the ADSL password.

IP Address: It is assigned after the dialup is successful.

UPNP

External HTTP Port: It is an external access HTTP port mapped by the router and corresponding to the HTTP port of the device.

External TCP Port: It is an external access TCP port mapped by the router and corresponding to the TCP port of the device.

AutoReg Setting



Connect Type: It indicates the connection mode of the platform to be registered.

Reg Server IP: It is the IP address of the server.

Reg Server Port: It is the port of the server.

User: It is the user name used to access the server.

Password: It is the password used to access the server.

Device Id: It is the unique identifier of the NVR.

Online Users

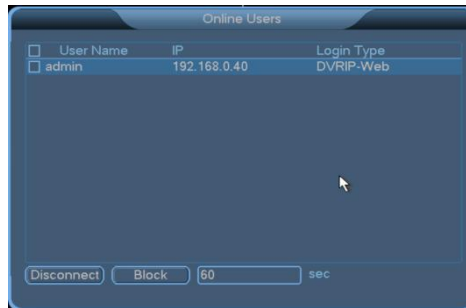

Disconnect: It is used to disconnect the user selected in the list. The disconnection time can be set.

Block: It is used to block the user selected in the list. The block time can be set.

3.6.3 Display

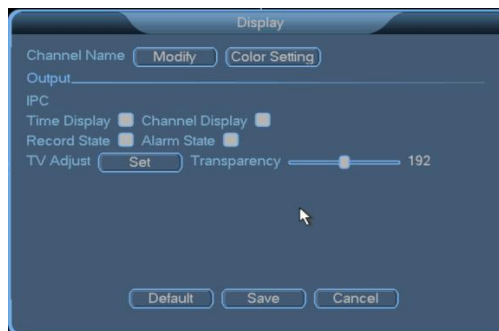

Channel Name: Click **Modify** and modify the channel name on the **Channel Name** screen.



Output: The **Time Display**, **Channel Display**, **Record State**, and **Alarm State** options are available. ■ indicates that the options are selected. The system time and date, channel No., record state, and alarm state are displayed on the surveillance screen.

Transparency: It ranges from 128 to 255. Set the transparency as required.

TV Adjust: You can set the top, bottom, left, and right edge spacing for video display.



3.6.4 Account



 **Notes:**

- (1) A user name or a group name consists of a maximum of six bytes. Spaces are invalid in the beginning or at the end of a string and are valid in the middle of a string. Letters, digits, underscores, minus marks, and dots are valid characters. Other characters cannot be used.
- (2) The number of users and groups is not limited. You can add or delete groups as required. Two levels of groups are available in default configurations: **USER** and **ADMIN**. You can set groups as required and assign rights to the group members based on the group rights.
- (3) Accounts are classified into two levels: groups and users. A group name or a user name must be unique. A user must be added to and can be added only to one group.

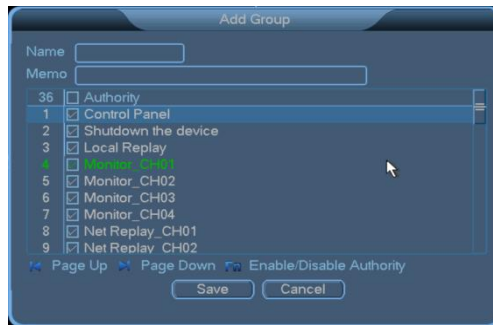

Add Group: You can add a group and set group rights.

On the **Add Group** screen, set the group name and group rights, including control panel, device shutdown, real-time surveillance, playback, network preview, recording, record backup, hard disk management, account management, system information check, alarm input/output setting, log check, log deletion, system upgrade, maintenance, general setting, coding setting, record setting, serial port setting, network setting, alarm setting, video detection, display, and default.

Modify Group: You can modify the properties of an existing group.



Add User: You can add users to a group and set user rights.

Two default users are available: user **admin** and user **guest**. User **admin** has the highest rights. User **guest** has lower rights, including control panel, surveillance, playback, and network preview. The default password of the two users is **123456**.

On the **Add User** screen, type the user name and password, select a group, and determine whether to reuse the user. If **Reusable** is selected, the account can be used on the local device or on the network. ■ indicates that the option is selected.

When a group is selected, rights assigned to the group members cannot exceed the group rights.

To facilitate account management, assign lower rights to common users than senior users.

Modify User: You can modify the properties of an existing user.

Delete User: You can delete an existing user.



Modify Password: You can modify the password of an existing user. Access the **Modify Password** screen, select a user name, type a new password in the **New Password** text box, confirm it, and click **Save**. A password consists of a maximum of six characters. Spaces are invalid in the beginning or at the end of a password and are valid in the middle of a password. User **admin** can modify the passwords of other users.

3.6.5 PTZ



Channel: Select a channel for which you want to set the PTZ parameters.

Protocol: It is a communication protocol for PTZ motor control. It can be set to **PELCOD** or **PELCOP** and must be consistent with the internal control protocol of the PTZ.

Address: It is used to distinguish between PTZs. It must be consistent with the address code of a PTZ. Ensure that the address codes of PTZs are not in conflict.

Baud rate: It is the transmission frequency of the 485 signal. It must be consistent with the internal baud rate setting of the PTZ.

Data Bits: It is a transmission parameter of the 485 protocol. Five to eight options are available.

Stop Bits: It is a transmission parameter of the 485 protocol. One or two options are available.

Parity: It is a transmission parameter of the 485 protocol. It can be set to **Odd**, **Even**, **Checkmark**, or **None**.

 **Note:** The default PTZ settings are common settings, with **Baud rate** set to **115200**, **Data Bits** set to **8**, **Stop Bits** set to **1**, and **Parity** set to **None**.

3.6.6 Tour

Set the tour type and time. The tour interval ranges from 5 seconds to 120 seconds. Screens can be displayed in the single-screen, 4-screen, 8-screen, 9-screen, 16-screen, and 25-screen mode.

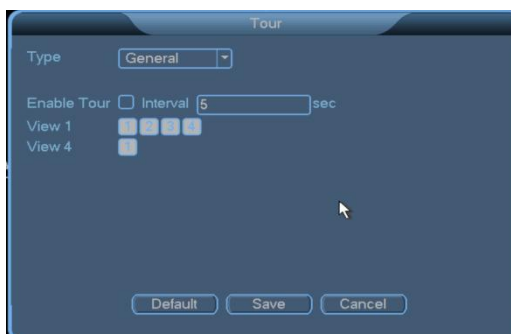

3.7 Advanced

The following sub menus are available: **HDD Manage**, **Digital Channel**, **USB Update**, **Configuration**, **Maintenance**, **Default**, and **Shut Down**.

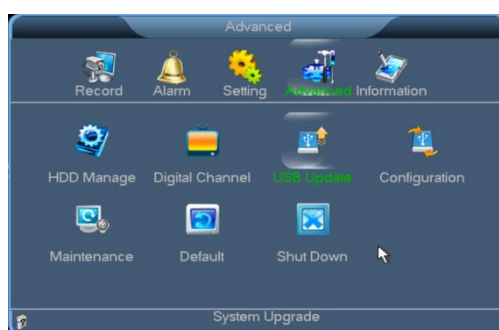

3.7.1 HDD Manage

The NVR supports SATA disks. To access the **HDD Manage** screen, choose **Main Menu>Advanced>HDD Manage**.



Type, **Capacity**, and **Record Time** show properties of the current hard disk. In the **Set** drop-down list, the **Read only**, **Read/Write**, **Redundant**, and **Format** options are available. The setting takes effective after you click **Execute**.

 **Note:** To enable the redundancy function, you can set one or more hard disks to the redundant disks. After the redundancy function is enabled on the **Record Setting** screen, record files are recorded in the read/write disk sequence and redundant disk sequence. The cyclic overwrite policy is always applied to redundant disks. If a redundant disk is full, old data on the disk will be overwritten by new data. Therefore, the number of redundant disks can be different from that of read/write disks. At least one read/write disk must be set. Otherwise, recording cannot be enabled even when redundant disks are

available. To search for data on a redundant disk, you need to set the redundant disk to a read-only or read/write disk. After you make modifications on the **HDD Manage** screen, the system prompts you to restart the device for the modifications to take effect. Alternatively, you can take out the redundant disk and play the records on another device.

3.7.2 Digital Channel

To access the **Digital Channel** screen, choose **Main Screen > Advanced > Digital Channel**.



Channel: It is the channel where you want to set the digital channel, that is, the digital channel **No.**

Enable: It is used to enable a function. indicates that the function is enabled.

Decode Policy: It use the decoding policy of the digital channel. It can be set to **Most Real-time, Real-time, Default, Fluent, or Most Fluent**. You can select a proper decoding policy based on the network conditions and your requirement.

Video Audio: It can be set to **Only Audio, Only Video, or Video and Audio**.

To access the **Remote Channel Config** screen, double-click in the **Config List** area.



Config Name: It is the name of the selected configuration. You can click and modify it.

Device Search: You can search for devices on the LAN. The devices are displayed on the screen. Select and double-click a device. The IP address of the device is automatically typed in the **IP Address** field.

Type: It is the type of the front-end device. It can be set to **IPC, RTSP, Onvif**

Protocol: It is the protocol of the front-end device. It can be set to **TCP or UDP**.

Channel: It is the channel for decoding the remote device.

Stream type: It is the code stream type for decoding the remote device. It can be set to **Main or Secondary**.

IP Address: It is the IP address of the remote device, that is, the front-end device.

Port: It is the HTTP port for decoding the remote device. The default IPC port ID is **9008**, the default RTSP port ID is **554**, the default Onvif port ID is **8080**, and the default port is 80.

Preset: It is the preset point of the remote device.

Name: It is the user name used to log in to the remote device.

Password: It is the password used to log in to the remote device.

3.7.3 USB Update

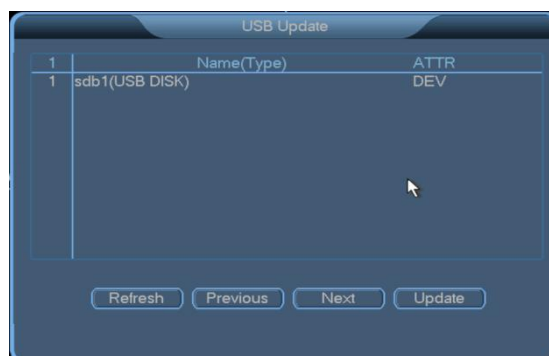

The update procedure is as follows: connect a USB device that stores the update file to the USB interface of the NVR, select the update file, and click **Update**. You can update the kernels, U-Boot, configurations, application programs, and file systems.

3.7.4 Configuration



EXPORT

Connect a USB device to the USB interface of the NVR and export system configurations as the **cfg.coi** file.

IMPORT

Connect a USB device that stores the configuration file to the USB interface of the NVR, select the configuration file, and click **IMPORT**.

3.7.5 Maintenance

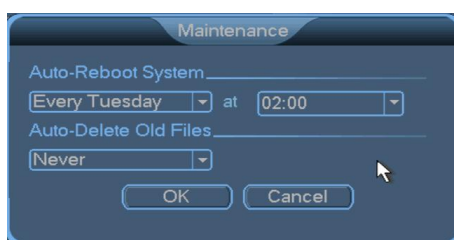

Auto-Reboot System: You can set the reboot period and time point of the system.

Auto-Delete Old Files: It can be set to **Never** or **User Defined**. You can set a policy for deleting files.

3.7.6 Default

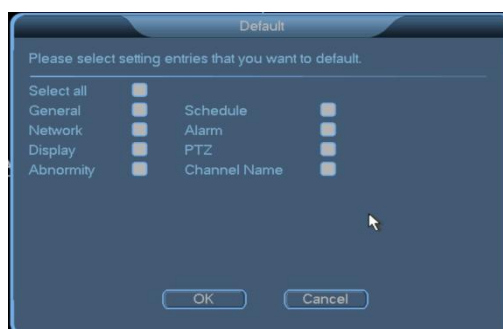

Select All: indicates that all of the following options are selected:

General, Schedule, Decode, Schedule, Network, Motion Detection, Alarm, PTZ, Display, Channel Name, and Abnormity.

3.7.7 Shut Down

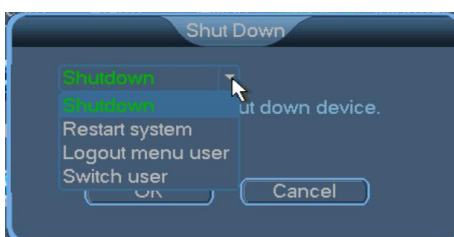

The **Shut Down** menu provides the **Logout menu user, Shutdown, and Restart system** functions.

When you press the shutdown button, the system displays a progress bar. The device is shut down after 3 seconds. You cannot cancel the shutdown operation in the process.

If you do not have the shutdown rights, you need to type the shutdown password.

Shutdown: It is used to log out of the system and power off the device.

Restart system: It is used to log out of and restart the system.

Logout menu use: It is used to exit the menu. You need to type the password again next time when you access the menu.

Switch user: It is used to log in to the system as another user.

3.8 Information

3.8.1 HDD Information



SATA	1	2			
1*-2	-	○			
All	-		465.38 GB	389.87 GB	-
1*-1	Record		93.14 GB	17.64 GB	Normal
1*-2	Picture		372.23 GB	372.23 GB	Normal

The **HDD Information** screen displays the SATA interface status of hard disks and the total space, free space, recording start time, and status of each hard disk.

 **Notes:** ○ indicates that the hard disk corresponding to the SATA interface is normal. **X** indicates that the hard disk is faulty. – indicates that the hard disk is not installed. To replace a faulty hard disk, shut down the device, remove the faulty hard disk, and install a new hard disk.





If the No. of a hard disk is marked by gray color (for example, ○), the hard disk is the current working disk. The **Status** column displays whether conflict occurs on a hard disk. If the hard disk is faulty, a question mark (?) is displayed in the **Status** column.

If conflict occurs, the system automatically switches to the **HDD Information** screen after startup. You are not required to handle the conflict, but you can check whether the system time overlaps with the disk time. If yes, access the **General** screen and modify the system time, or choose **Advanced**>**HDD Manage**, format the hard disk, and restart the NVR.

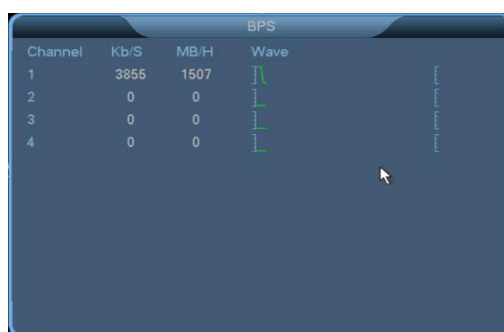
Hard disk arrangement rule: The hard disks are arranged based on the SATA interface sequence. For example, the hard disk corresponding to the SATA 1 interface is arranged in front of the hard disk corresponding to the SATA 2 interface.

3.8.2 BPS



Channel	Kb/S	MB/H	Wave
1	3855	1507	
2	0	0	
3	0	0	
4	0	0	

The **BPS** screen displays the code stream (**Kb/S**) and occupied disk space (**MB/H**) for each channel in real time. The waveforms show the code stream changes in an explicit manner.

3.8.3 Log

The **Log** screen displays system logs, allowing you to check login logs. Logs are classified into the following types: **System, Setting, Storage, Alarm, Record, Account, Clear,** and **Playback.**

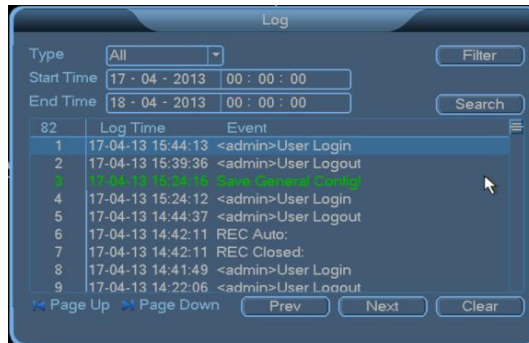

Filter: It allows you to set the types of logs to be saved.

Set **Type, Start Time,** and **End Time,** and click **Search.** The logs meeting the search criteria are displayed in a list (each page displays 10 logs). You can click **Page Up** or **Page Down** to view logs on other pages.

3.8.4 Version

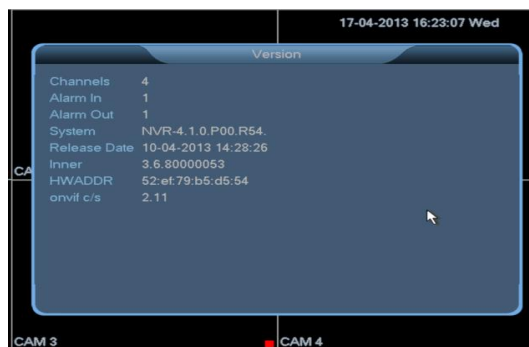

The hardware features and the software version and release date are displayed.

4 Quick Start

4.1 Startup

Connect the power cable and press the power button (in the ON state). The power indicator is lit, and the NVR starts. The multi-screen video output mode is enabled by default. If the startup time is within the scheduled record time, the system automatically enables the scheduled recording function and operates properly.

4.2 Login

After normal startup, right-click a menu and type the user name and password in the **Login** dialog box that is displayed.



Notes:

- (1) Two default users are available in the system: user **admin** and user **guest**. The default password of the two users is **123456**.
- (2) A password security policy is executed. You can try a password only five times within 30 minutes. After that, the account is locked.
- (3) To ensure account security, change the default password in time. To add groups and users or modify users, see section **3.6.4 Account**.

4.3 Shutdown



Note: Before you replace a hard disk, disconnect the external power supply and open the shelf.

Method 1: Turn the main power switch to the OFF position.

Method 2: Choose **SYSTEM MENU > Shut Down** and select **Shutdown**.

Method 3: Choose **SYSTEM MENU > Main Menu > Advanced > Shut Down** and select **Shutdown**.

4.4 Power Recovery

If the system power supply is disconnected or the NVR is forcibly shut down when the NVR is in the recording, scheduled recording, or alarm recording state, the NVR automatically saves the records generated before the power failure after power-on again and continues to work in the same state as that before the power failure.

4.5 Battery Replacement

Replace the button batteries of the NVR with batteries of the same model. Check the system time periodically and replace the batteries once a year to ensure the accuracy of the system time

5 FAQ

1. Why does the host fail to start after the power supply is connected?

- Check whether the power switch on the back of the host is turned on.
- Check whether the startup operation is correct.

2. Why is there no display on the monitor? Why does the screen jitter?

- Check whether the device is powered on. After power-on, the POWER indicator on the front panel will be lit.
- Check whether the VGA cable is connected properly.

3. Why do color casts occur on the screen?

- Check whether the VGA cable is connected properly and whether the VGA cable is intact.

4. Why does blank screen occurs after the host starts? Why is there no channel title on the screen?

- Access the channel setting screen and check whether local blocking is enabled. If yes, restore it to the default setting. Alternatively, access the default setting screen and restore all options to the default settings.

5. Why does the blocking effect occur during record playback on the host?

- Record parameters are not set properly, reducing the record quality.
- Bad sectors occur on the hard disks.

6. Why is there no record data available when manual recording is enabled?

- Check whether the search criteria are correct. Ensure that manual recording is selected before you search for and play a record.
- Ensure that hard disks are formatted into data areas.
- Ensure that at least one read/write disk is available.

7. Why cannot scheduled recording be enabled? Why is there no record data within the scheduled recording time period?

- The scheduled recording time period is not set properly. The start time must be earlier than the end time.
- The power supply is accidentally disconnected during in the scheduled recording time period.
- The required data is overwritten.
- Physical damage or logical errors occur on the hard disks. As a result, data cannot be displayed properly.

8. Why cannot alarm recording be enabled?

- The alarm recording time period is not set properly. The start time must be earlier than the end time.
- No channel is selected for alarm recording. Select a proper channel.
- The trigger settings are incorrect. Check alarm input connections and alarm trigger devices

9. Why is the record content discontinuous?

- If this problem occurs in manual recording or scheduled recording, check whether a power failure or a voltage abnormality occurs.
- If this problem occurs in alarm recording, check whether alarms are generated frequently. Recording is triggered when alarms occur and lasts for a certain period based on the preset recording time.

6 Web Server Client

6.1 Internet Explorer Setting

Ensure that Microsoft Internet Explorer 6.0 or later and DirectX 9.0 or later are installed.

- If the Internet Explorer blocks the download of controls, perform the following operations:

1. Open the Internet Explorer and click **Tools**.
2. Choose **Internet Options>Security**.

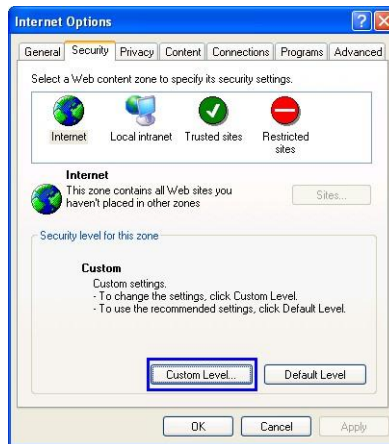

3. Click **Custom Level**. In the **Security Settings** window, select **Enable** for **Download unsigned ActiveX controls**, as shown in the following figure.

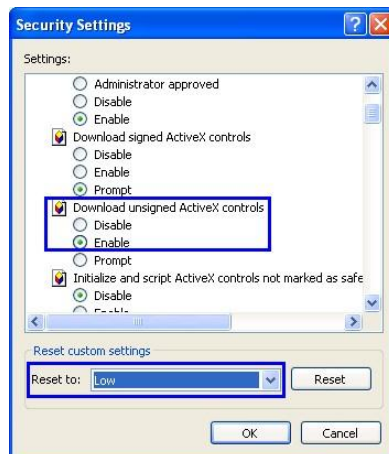

4. Click **OK** and **Apply**.

- If plug-ins or antivirus controls block the download of controls, disable the firewall and antivirus software.

 **Note:** If the commissioning is successful and all functions are normal when you log in to the NVR for the first time, you can restore the Internet security level to the default setting or set a custom security level to ensure the security of the Internet Explorer.

6.2 Login

Type the IP address (default IP address: **192.168.1.88**) of the NVR in the address box of the Internet Explorer, for example, **http://192.168.1.88**. Access the login page.

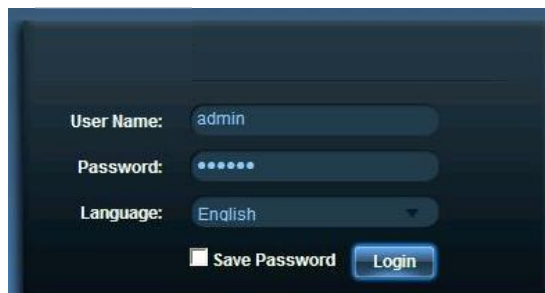

When you log in by using the Internet Explorer for the first time, the system prompts you to load and install plug-ins. The user name and password must be consistent with those used to log in to the software on the device. The default administrator user name for the administrator of the NVR is **admin**, and the default password is **123456**. You need to change the password in time.

Notes:

- (1) Check that the NVR is properly connected to the network based on the preceding descriptions of device connections and operations.
- (2) Set the IP address, subnet mask, and gateway for the host and NVR. If no routing device is available on the network, assign an IP address on the same network segment. If a routing device is available on the network, set the gateway and subnet mask as required. To view the network settings of the NVR, choose **Setting > Network**.
- (3) Check whether the network is connected properly by using the **ping ***.***.***.***** (IP address of the NVR) command. If the returned TTL value is 64, the network connection is normal.
- (4) Web controls are automatically identified and downloaded. After the update of a control, the previous control is deleted.

6.3 Web Server Client Screen

After you load in to the client, the main screen is displayed, as shown in the following figure.

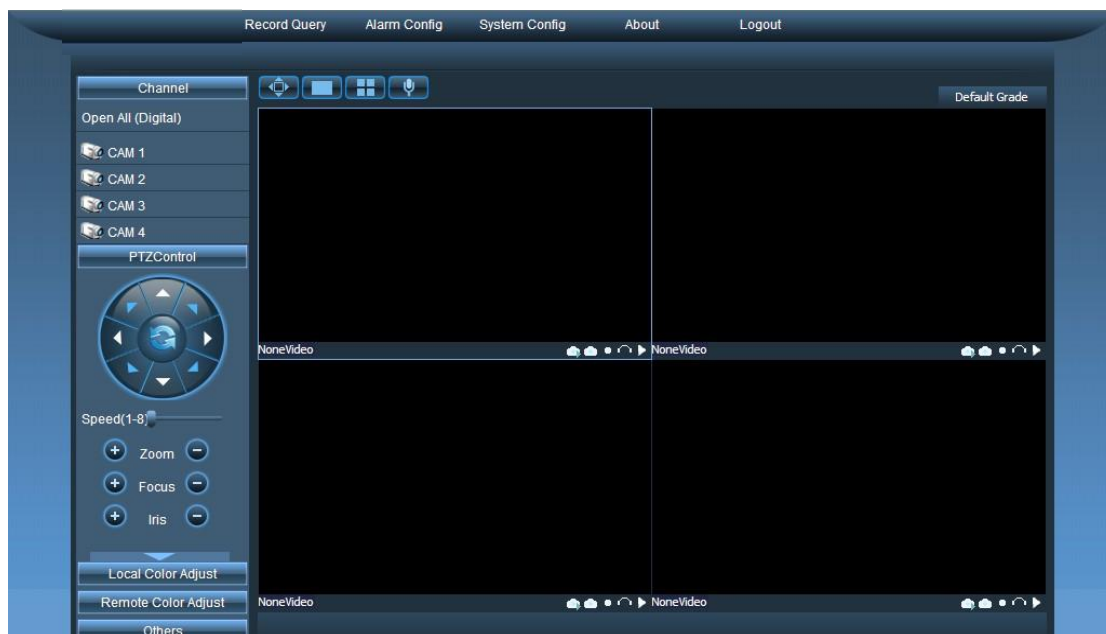

6.4 Menu Bar

The menu bar is on the top of the screen, providing the **Record Query**, **Alarm Config**, **System Config**, **About**, and **Logout** menu options.

Record Query: It is used to go to the record search and playback screen.

Alarm Config: It is used to go to the alarm setting screen.





System Config: It is used to go to the control panel.

About: It is used to display version information about the NVR web server.

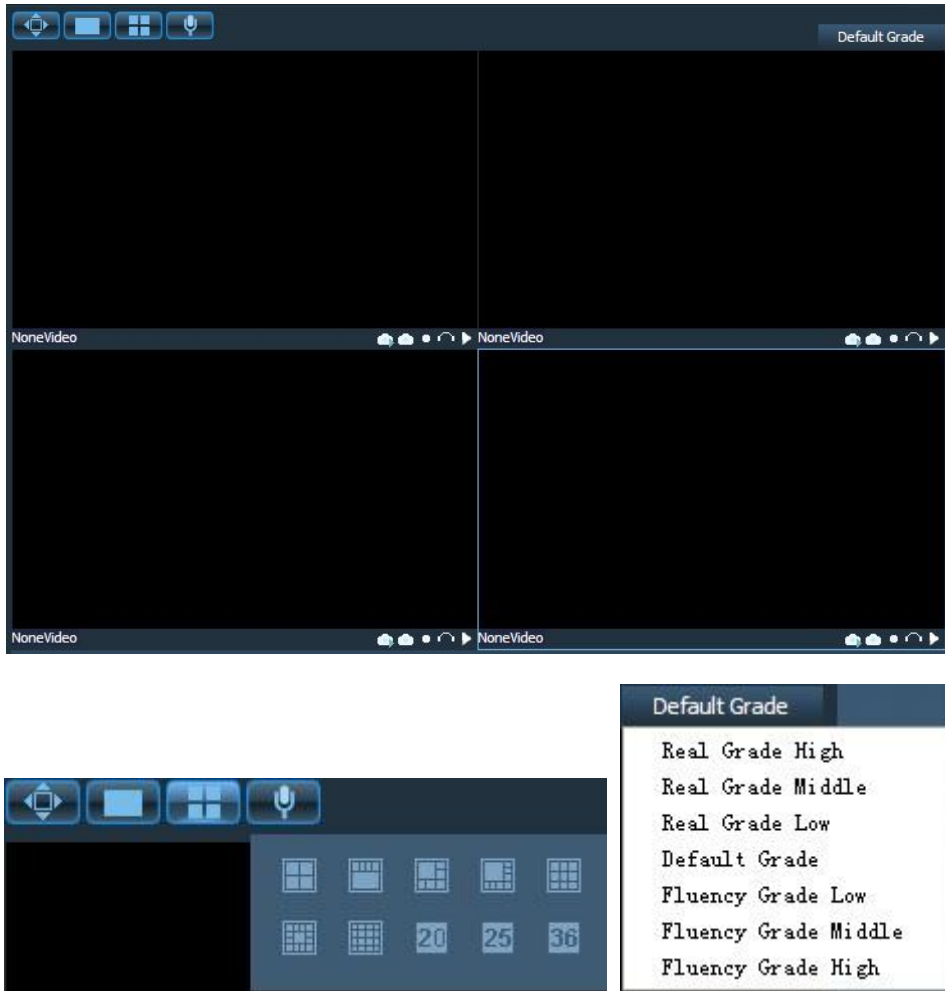
Logout: It is used to exit the NVR web server screen.

6.5 Preview Mode



Icon	Description
	Full-screen display
	Single-screen split display
	Multi-screen split screen: 4-screen/5-screen/6-screen/8-screen/9-screen/13-screen/16-screen/20-screen/25-screen/ 36-screen
	Microphone, intercom
Default Grade	Real-time fluency grade: Real Grade High/Real Grade Middle/Real Grade Low/Default Grade/Fluency Grade Low/Fluency Grade Middle/Fluency Grade High

6.6 Video Connection

In the **Channel** navigation pane, click the channel that you want to connect to. You can preview the

screen when the camera icon becomes orange. Click the drop-down arrow behind the channel No. and choose **Main Stream** or **Second Stream** from the drop-down list.

Start All: It is used to connect to main stream videos in all channels.

Close All: It is used to disconnect from all channels.

Main Stream: It is used to connect to main stream videos in digital channels.

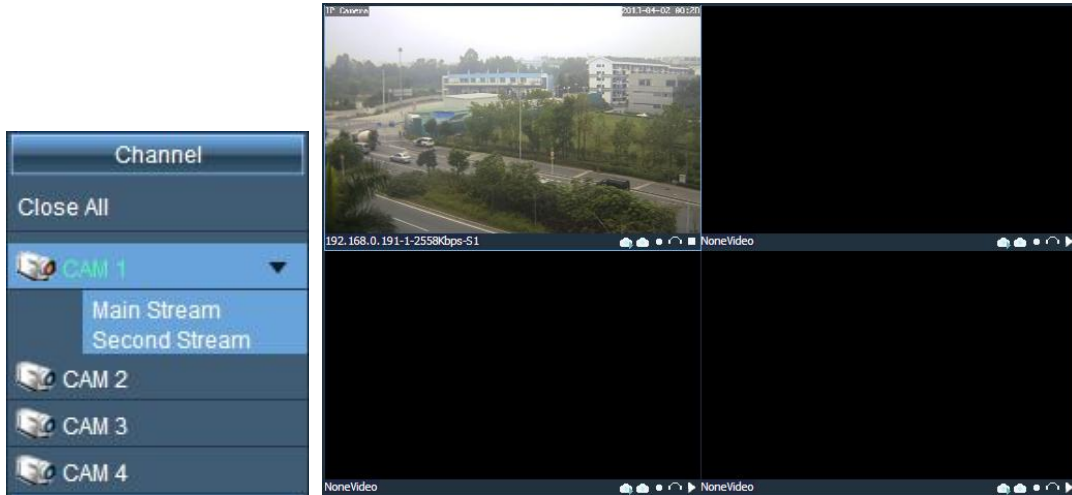

Second Stream: It is used to connect to second stream videos in digital channels.





The preview toolbar is displayed in the lower right corner of the screen.

: It is used to capture the screen of the current channel. The captured screen is stored on a hard disk of the NVR.

: It is used to capture the screen of the current channel in local mode. The captured screen is stored at **C:\RC** by default.

: It is used to enable recording for the current channel. The record is stored at **C:\RC** by default.  indicates that recording is enabled.

: It is used to enable snoop the environment where the current channel is located.  indicates that snooping is enabled.

: It is used to start or stop the preview.

6.7 PTZ Control

You can control the PTZ functions on the web client.



Direction Control: Control the pan/tilt directions (top, bottom, left, and right) of the PTZ. You can control a direction by clicking the corresponding arrow and hold. When you release the mouse, the direction is not under control.

Speed: Control the speed when the PTZ moves up, down, left, and right or in tour mode.

Zoom: Control the zooming of the PTZ camera lens.

Focus: Control the focus of the PTZ camera lens.

Iris: Control the aperture of the PTZ camera lens.

Preset: Type a value for **Preset**. The preset point of the PTZ cameras is invoked.

Auto Tour: Type a value for **Auto Tour**. Tours are enabled for PTZ cameras.

AutoPan: Enable PTZ cameras to rotate horizontally.

AutoScan: It is used to enable linear scanning for PTZ cameras.

Pattern: Control the auto pan/tilt of the PTZ.

PTZ Config: It allows you to set **AutoScan**, **Pattern**, **Preset**, and **Tour**.



Aux. On: It is used to start auxiliary devices.

Aux. Off: It is used to shut down auxiliary devices.

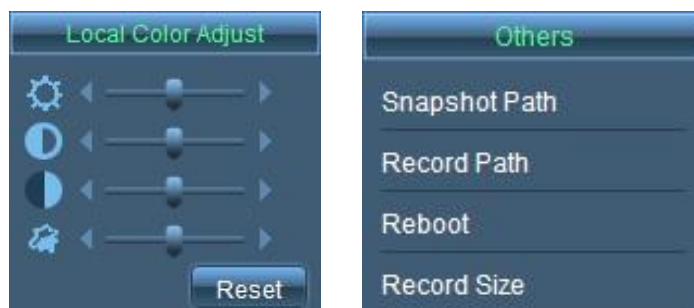
6.8 Screen Settings and Others



Icon	Description
	It is used to adjust the brightness of the screen.
	It is used to adjust the contrast of the screen.

	It is used to adjust the saturation of the screen.
	It is used to adjust the chrominance of the screen.
	It is used to restore the brightness, contrast, saturation, and chrominance to the default values.
Snapshot Path	It is used to set the path for storing captures screens. The default path is C:\RC\ .
Record Path	It is used to set the path for storing records. The default path is C:\RC\ .
Reboot	It is used to restart the device.
Record Size	It is used to set the size of a record file.

6.9 System Information

Click **System Config**. The **Config** window is displayed, as shown in the following figure. You can set and modify all parameters of the NVR.

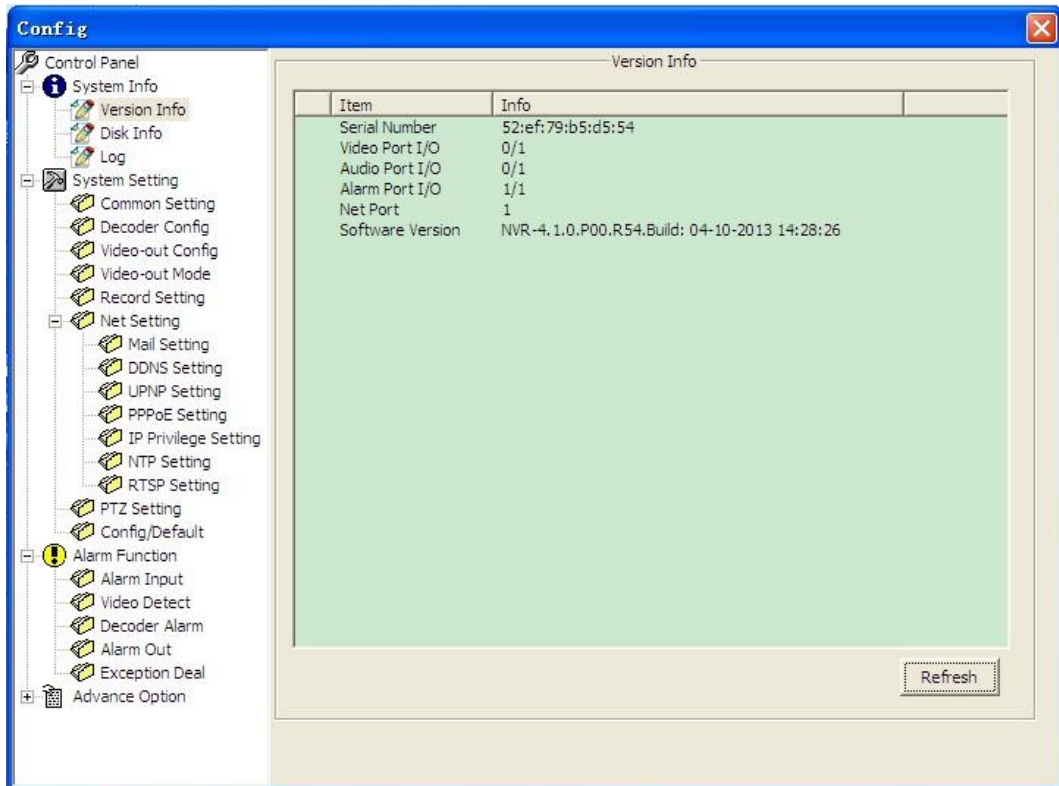

System Info: It allows you to view version information, disk information, and logs of the system.

Version Info: It allows you to view the firmware version information and port information of the NVR.

Disk Info: It allows you to view the disk partitions, disk status, free space, and total space.

Log: It allows you to search for, view, and back up logs of the NVR.

6.10 System Setting

You can set the NVR time, language, format, decoding mode, recording mode, serial port, network, alarm, video, PTZ, and backup parameters.

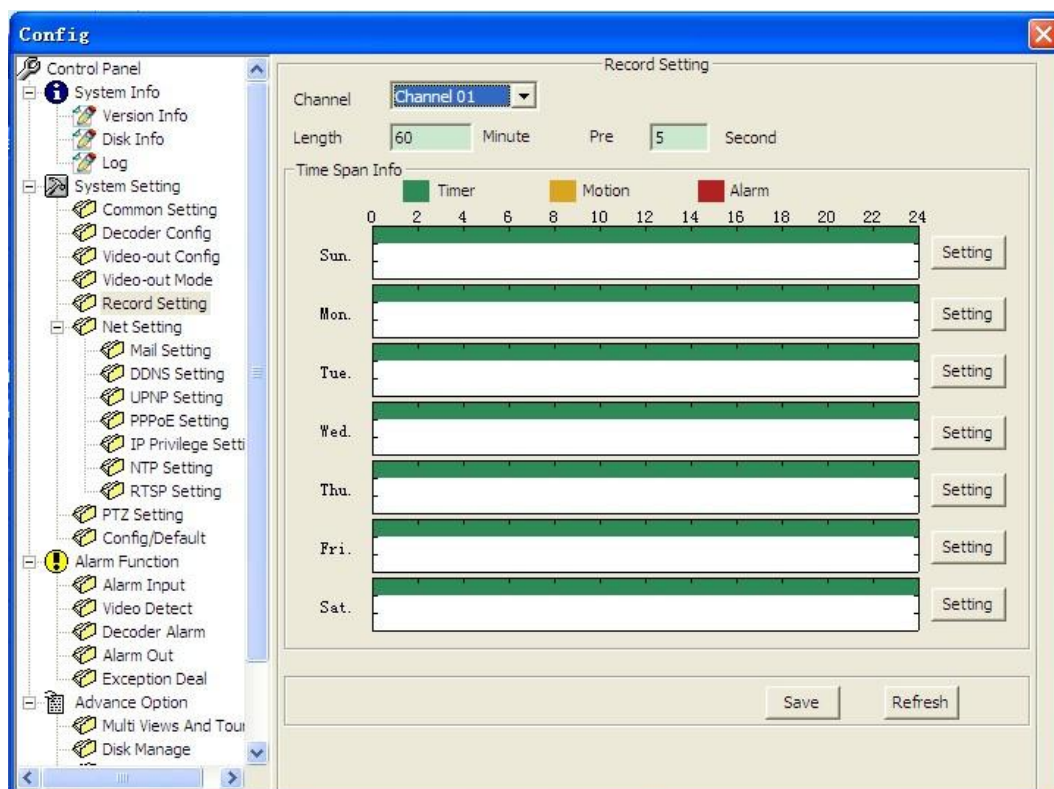

Common Setting: It allows you to set the video format and system time/date, synchronize the system time/date with that of the PC, select voice versions supported by the system, and set the handling methods when hard disks are full.

Decoder Config: It allows you to search for and add devices and set decoding policies for the channels.

Video-out Config: It allows you to adjust the top, bottom, left, and right edge spacing for video display.

Video-out Mode: It allows you to determine whether to display the time, channel, alarm state, and record state on a video.

Record Setting: It allows you to set the length of record files and pre-record time. The record dates and time periods are displayed in a graph based on record types (**Timer**, **Motion**, and **Alarm**).

Net Setting: It allows you to set the device name, IP address, subnet mask, gateway, alarm reception mail box, DDNS, UPNP, PPPoE, IP privilege, NTP, and RTSP.

PTZ Setting: It allows you to set the channel connected to the PTZ, PTZ protocol, PTZ address, baud rate, data bits, stop bits, and parity. The default values are as follows: **PELCO**, **1**, **9600**, **8**, **1**, and **None**.

Config/Default: It allows you to restore all or part of the default values. You can restore the alarm setting, record setting, motion detection setting, serial port setting, output mode setting, exception handling mode, name setting, network setting, alarm setting, PTZ setting, and channel name. You can export or import configuration parameters.

AutoReg: It allows you to set the connection mode of the platform to be registered, IP address and port

ID of the server, user name and password for accessing the platform, and unified device identifier.

6.11 Alarm Function

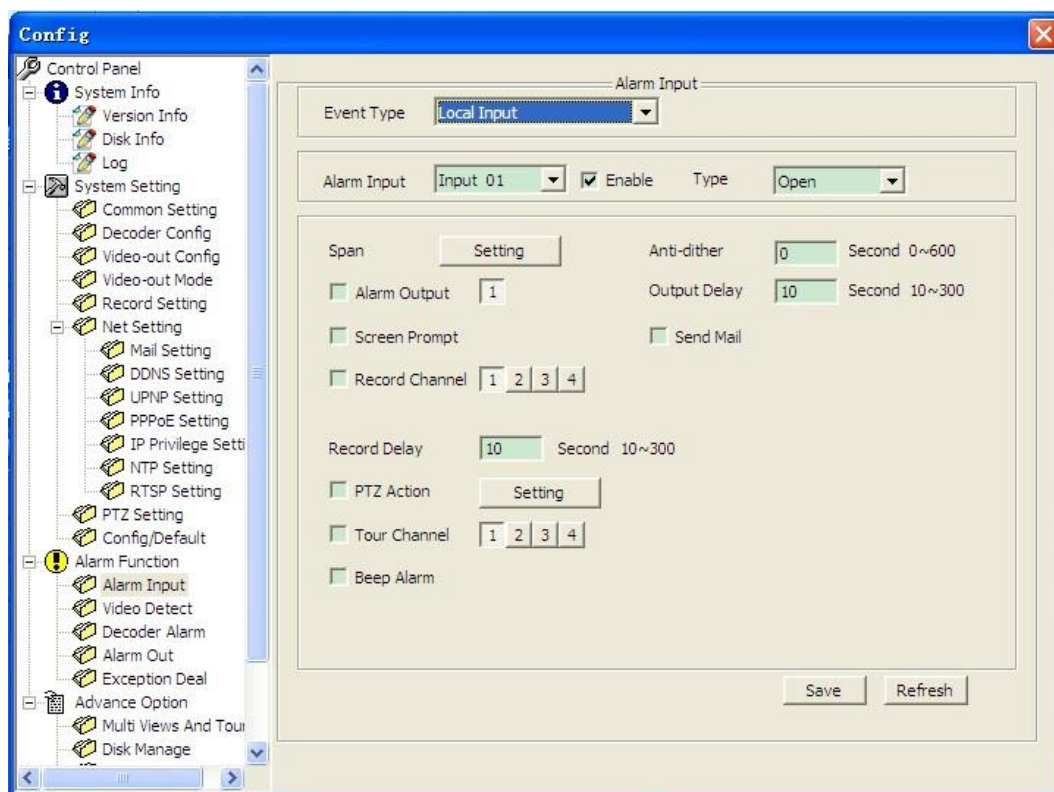

Alarm Input: It allows you to set the event types for alarm input, alarm time, anti-dither time, output channel, PTZ action, and beep alarm.

Video Detect: It allows you to set motion detection areas in a channel and configure actions with alarms.

Decoder Alarm: It allows you to set actions with decoder alarms.

Alarm Out: It allows you to set the display of the alarm output status.

Exception Deal: It allows you to set the exception event types, alarm delay, and exception handling methods, for example, screen prompts, emails, and beep alarms.

6.12 Advance Option

You can set record and maintenance parameters.

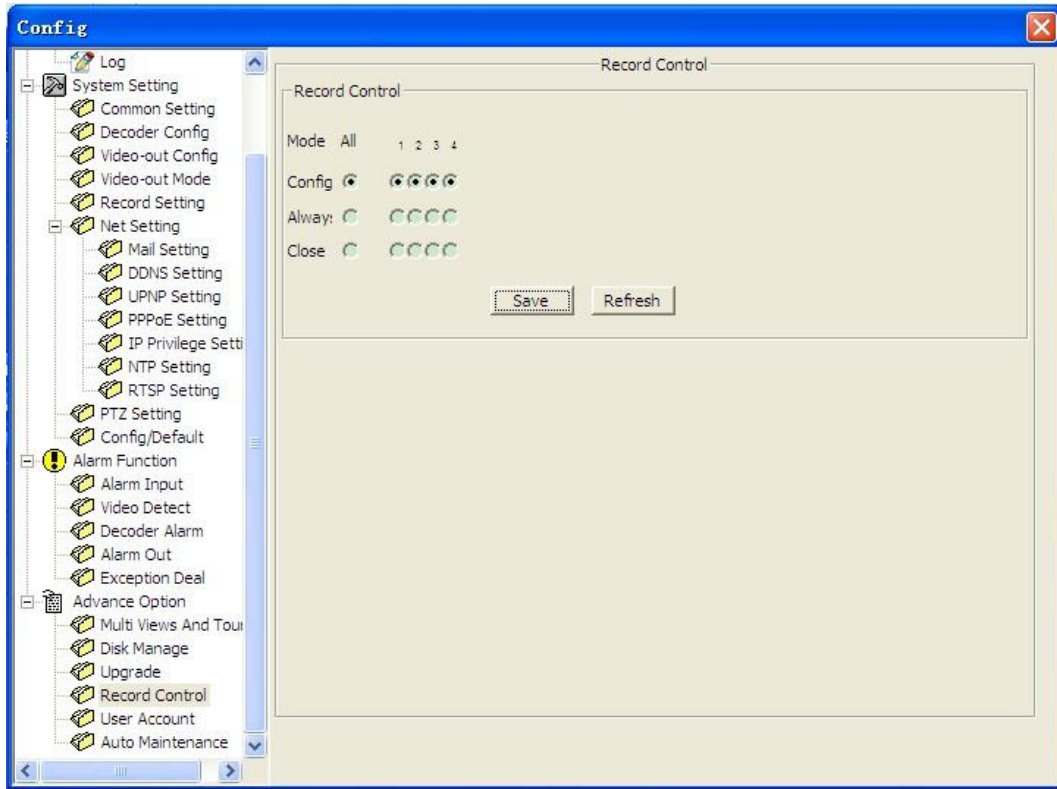

Multi Views and Tour: It allows you to set single-screen or multi-screen display and configure multi-screen tours.

Disk Manage: It allows you set the read/write, read only, and redundancy properties for hard disks, clear data, and recover hard disks from errors.

Upgrade: It allows you to upgrade the system by using a local upgrade file.

Record Control: It allows you to the recording mode to **Always**, **Config**, or **Close** for all channels or part of the channels.

User Account: It allows you to ad users, modify users, delete users, modify passwords, add groups, modify groups, and delete groups.

Auto Maintenance: It allows you to set the restart time for maintenance and determine whether to delete old files.