

Copyright © 2010. Acer Incorporated.
All Rights Reserved.

Acer Projector C20 Series User's Guide
Original Issue: 09/2010

Changes may be made periodically to the information in this publication without obligation to notify any person of such revisions or changes. Such changes will be incorporated in new editions of this manual or supplementary documents and publications. This company makes no representations or warranties, either expressed or implied, with respect to the contents hereof and specifically disclaims the implied warranties of merchantability or fitness for a particular purpose.

Record the model number, serial number, purchase date and place of purchase information in the space provided below. The serial number and model number are recorded on the label affixed to your projector. All correspondence concerning your unit should include the serial number, model number and purchase information.

No part of this publication may be reproduced, stored in a retrieval system, or transmitted, in any form or by any means, electronically, mechanically, by photocopy, recording or otherwise, without the prior written permission of Acer Incorporated.

Acer Projector C20 Series

Model number: _____

Serial number: _____

Date of purchase: _____

Place of purchase: _____

Acer and the Acer logo are registered trademarks of Acer Incorporated. Other companies' product names or trademarks are used herein for identification purposes only and belong to their respective companies.

"HDMI™, the HDMI logo and High-Definition Multimedia Interface are trademarks or registered trademarks of HDMI Licensing LLC."

Information for your safety and comfort

Read these instructions carefully. Keep this document for future reference. Follow all warnings and instructions marked on the product.

Turning the product off before cleaning

Unplug this product from the wall outlet before cleaning. Do not use liquid cleaners or aerosol cleaners. Use a damp cloth for cleaning.

Caution for plug as disconnecting device

Observe the following guidelines when connecting and disconnecting power to the external power supply unit:

- Install the power supply unit before connecting the power cord to the AC power outlet.
- Unplug the power cord before removing the power supply unit from the projector.
- If the system has multiple sources of power, disconnect power from the system by unplugging all power cords from the power supplies.

Caution for Accessibility

Be sure that the power outlet you plug the power cord into is easily accessible and located as close to the equipment operator as possible. When you need to disconnect power to the equipment, be sure to unplug the power cord from the electrical outlet.



Warning:

- Do not use this product near water.
- Do not place this product on an unstable cart, stand or table. If the product falls, it could be seriously damaged.
- Slots and openings are provided for ventilation to ensure reliable operation of the product and to protect it from overheating. These openings must not be blocked or covered. The openings should never be blocked by placing the product on a bed, sofa, rug or other similar surface.

This product should never be placed near or over a radiator or heat register, or in a built-in installation unless proper ventilation is provided.

- Never push objects of any kind into this product through cabinet slots as they may touch dangerous voltage points or short-out parts that could result in a fire or electric shock. Never spill liquid of any kind onto or into the product.
- To avoid damage of internal components and to prevent battery leakage, do not place the product on a vibrating surface.
- Never use it under sporting, exercising, or any vibrating environment which will probably cause unexpected short current or damage rotor devices, lamp.

Using electrical power

- This product should be operated from the type of power indicated on the marking label. If you are not sure of the type of power available, consult your dealer or local power company.
- Do not allow anything to rest on the power cord. Do not locate this product where people will walk on the cord.
- If an extension cord is used with this product, make sure that the total ampere rating of the equipment plugged into the extension cord does not exceed the extension cord ampere rating. Also, make sure that the total rating of all products plugged into the wall outlet does not exceed the fuse rating.
- Do not overload a power outlet, strip or receptacle by plugging in too many devices. The overall system load must not exceed 80% of the branch circuit rating. If power strips are used, the load should not exceed 80% of the power strip's input rating.
- This product's AC adapter is equipped with a three-wire grounded plug. The plug only fits in a grounded power outlet. Make sure the power outlet is properly grounded before inserting the AC adapter plug. Do not insert the plug into a non-grounded power outlet. Contact your electrician for details.



Warning! The grounding pin is a safety feature. Using a power outlet that is not properly grounded may result in electric shock and/or injury.



Note: The grounding pin also provides good protection from unexpected noise produced by other nearby electrical devices that may interfere with the performance of this product.

- Use the product only with the supplied power supply cord set. If you need to replace the power cord set, make sure that the new power cord meets the following requirements: detachable type, UL listed/CSA certified, VDE approved or its equivalent, 4.6 meters (15 feet) maximum length.

Product servicing

Do not attempt to service this product yourself, as opening or removing covers may expose you to dangerous voltage points or other risks. Refer all servicing to qualified service personnel.

Unplug this product from the wall outlet and refer servicing to qualified service personnel when:

- the power cord or plug is damaged, cut or frayed
- liquid was spilled into the product
- the product was exposed to rain or water
- the product has been dropped or the case has been damaged
- the product exhibits a distinct change in performance, indicating a need for service
- the product does not operate normally after following the operating instructions



Note: Adjust only those controls that are covered by the operating instructions, since improper adjustment of other controls may result in damage and will often require extensive work by a qualified technician to restore the product to normal condition.



Warning! For safety reasons, do not use non-compliant parts when adding or changing components. Consult your reseller for purchase options.

Your device and its enhancements may contain small parts. Keep them out of the reach of small children.

Additional safety information

- Do not look into the projector's lens when the lamp is on. The bright may hurt your eyes.
- Turn on the projector first and then signal sources
- Do not place the product in following environments:
 - Space that is poorly ventilated or confined. At least 50cm clearance from walls and free flow of air around the projector is necessary.
 - Locations where temperatures may become excessively high, such as inside of a car with all windows rolled up.
 - Locations where excessive humidity, dust, or cigarette smoke may contaminate optical components, shortening the life span and darkening the image.
 - Locations near fire alarms.
 - Locations with an ambient temperature above 40 °C/104 °F.
 - Locations where the altitudes are higher than 10000 feet.
- Unplug immediately if there is something wrong with your projector. Do not operate if smoke, strange noise or odor comes out of your projector. It might cause fire or electric shock. In this case, unplug immediately and contact your dealer.
- Do not keep using this product to break or drop it. In this case contact your dealer for inspection.
- Do not face the projector lens to the sun. It can lead to fire.
- When switching the projector off, suggest to ensure the projector completes its cooling cycle before disconnecting power.
- Do not frequently turn off the main power abruptly or unplug the projector during operation. The best way is to wait for the fan to turn off before turning main power off.
- Do not touch air outlet grille and bottom plate which becomes hot.
- Clean the air filter frequently if have. The temperature inside may rise and cause damage when the filter/ventilation slots clogged with dirt or dust.

- Do not look into the air outlet grille when projector is operating. It may hurt your eyes.
- Always open the lens shutter or remove the lens cap when the projector is on.
- Do not block the projector lens with any object when the projector is under operation as this could cause the object to become heated and deformed or even cause a fire. To temporarily turn off the lamp, press HIDE on the remote control.
- The lamp becomes extremely hot during operation. Allow the projector to cool for approximately 45 minutes prior to removing the lamp assembly for replacement.
- Do not operate lamps beyond the rated lamp life. It could cause it to break on rare occasions.
- Never replace the lamp assembly or any electronic components unless the projector is unplugged.
- The product will detect the life of the lamp itself. Please be sure to change the lamp when is showing warning message.
- When changing the lamp, please allow unit to cool down, and follow all changing instructions.
- Reset the "Lamp Hour Reset" function from the Onscreen display "Management" menu after replacing the lamp module.
- Do not attempt to disassemble this projector. There are dangerous high voltages inside which may hurt you. The only user serviceable part is the lamp which has its own removable cover. Refer servicing only to suitable qualified professional service personnel.
- Do not stand the projector on end vertically. It may cause the projector to fall over, causing injury or damage.
- This product is capable of displaying inverted images for ceiling mount installation. Only use acer ceiling mount kit for mounting the projector and ensure it is securely installed.

Caution for Listening

To protect your hearing, follow these instructions.

- Increase the volume gradually until you can hear clearly and comfortably.
- Do not increase the volume level after your ears have adjusted.
- Do not listen to music at high volumes for extended periods.
- Do not increase the volume to block out noisy surroundings.
- Decrease the volume if you can't hear people speaking near you.

Disposal instructions

Do not throw this electronic device into the trash when discarding. To minimize pollution and ensure utmost protection of the global environment, please recycle. For more information on the Waste from Electrical and Electronics Equipment (WEEE) regulations, visit <http://www.acer-group.com/public/Sustainability/sustainability01.htm>



First things first

Usage Notes

Do:

- Turn off the product before cleaning.
- Use a soft cloth moistened with mild detergent to clean the display housing.
- Disconnect the power plug from AC outlet if the product is not being used for a long period of time.

Don't:

- Block the slots and openings on the unit provided for ventilation.
- Use abrasive cleaners, waxes or solvents to clean the unit.
- Use under the following conditions:
 - In extremely hot, cold or humid environments.
 - In areas susceptible to excessive dust and dirt.
 - Near any appliance that generates a strong magnetic field.
 - Place In direct sunlight.

Precautions

Follow all warnings, precautions and maintenance as recommended in this user's guide to maximize the life of your unit.



Warning!

- To reduce the risk of fire or electric shock, do not expose this product to rain or moisture.
- Please do not open or disassemble the product as this may cause electric shock.
- When switching the projector off, please ensure the projector completes its cooling cycle before disconnecting power.
- Turn on the projector first and then the signal sources.
- Do not use lens cap when projector is in operation.

Introduction



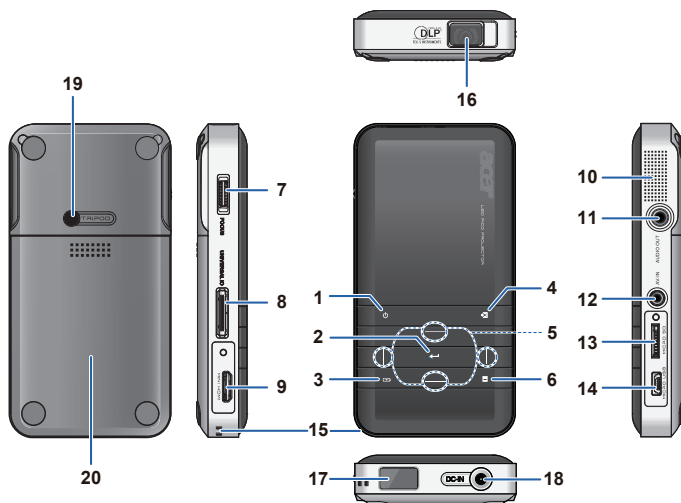



Product Overview

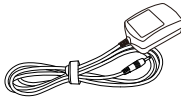
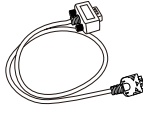
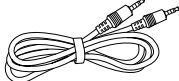

#	Description
1	Power Button
2	Enter Button
3	Battery Indicator
4	Auto Search Source Button
5	Navigation/Volume Button (up/down/left/right)
6	Menu/Esc Button
7	Focus Dial
8	VGA/Component Input Connector
9	Mini HDMI Connector
10	Speaker
11	Audio Out Connector
12	AV Input Connector
13	MicroSD Card Slot
14	Micro USB port
15	Through-hole for straps
16	Lens
17	IR Receiver
18	DC Input
19	Screw Hole for Tripod Converter
20	Battery Cover

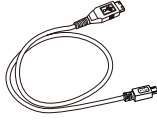
Package Overview

This projector comes with all the items shown below. Check to make sure your unit is complete. Contact your dealer immediately if any thing is missing.

				
Projector & Battery	Power adaptor with AC Plug	Universal-to-D-Sub Cable	2.5mm-to-3.5mm A/V Cable	Micro USB to USB A Cable.
				
Pouch	USB Cable	Quick start guide	Mini HDMI Adapter (Optional)	Adapter for iPod/iPhone (Optional)

Getting Started

Installing the Battery

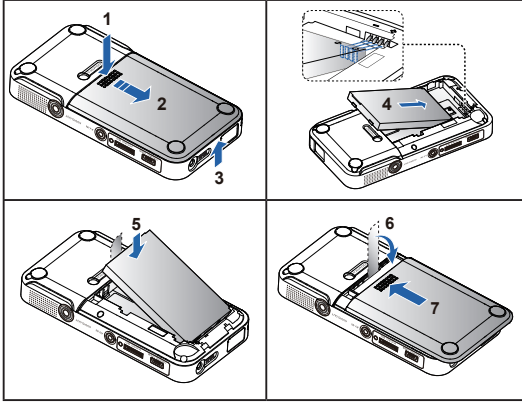

1. Remove the battery cover. (illustration #1~3)
2. Insert the battery with the electrical contact facing downward and away from the lens. (illustration #4)
3. Ensure that the battery pull tab extends from under the battery. (illustration #5)
4. Slide the battery cover back into place over the battery pull tab. (illustration #6~7)

Charging the Battery

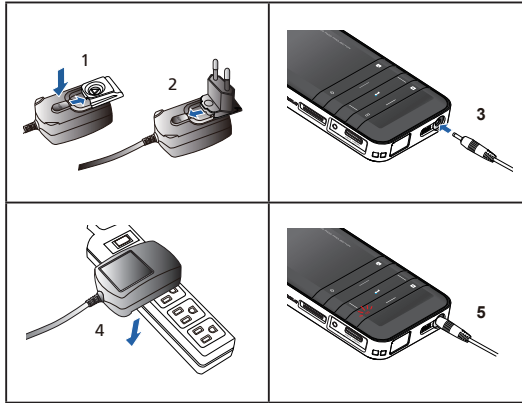

1. Remove protection cap and insert the plug. (illustration #1~2)
2. Connect the charger. (illustration #3~4)
3. During charging the LED indicator lights red. (illustration #5)
4. The LED Charge Indicator will go off when battery is fully charged. This process may take up to 2.5 hours.



Warning: Projector will not charge while operating.



Note: Led indicator

	Operation
	Battery charging
	Charge complete



Note: After the projector is turned off, the battery may not start charging right away due to over temperature protection.



Warning:

Battery charging	The accessory batteries have a small amount power at the time of purchase. The first charge should last for 6 hours and the machine should not be used during charging.
Battery indicator	Indication for 3 stages or sections. (50%/20%/5%)
Notes on battery use	<ol style="list-style-type: none"> 1. When the batteries are used, charging will automatically stop if their temperature is greater than 45 °C. 2. After they cool down, charging will resume and you do not have to plug or unplug the batteries/adaptor. 3. It is not recommended to charge the batteries immediately after use.

Connecting the Projector

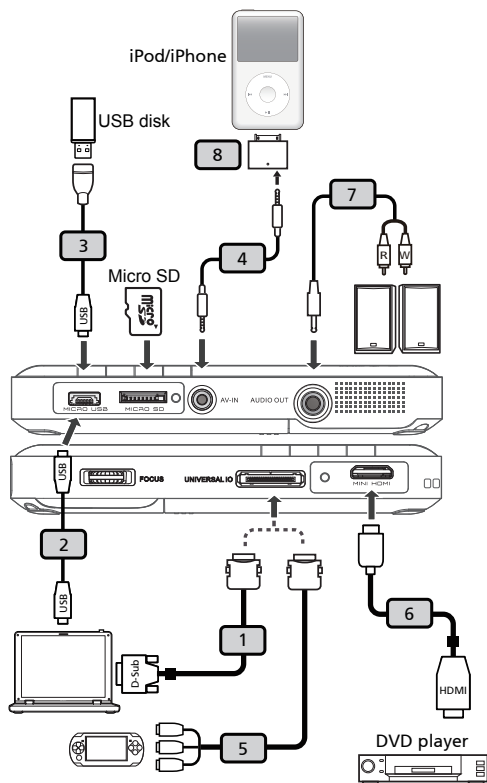

#	Description
1	Universal-to-D-Sub Cable
2	USB Cable
3	Micro USB to USB A Cable
4	2.5mm-to-3.5mm A/V Cable
5	Universal to RCA Cable
6	HDMI Cable (mini-to-STD)
7	Audio Cable Jack/RCA
8	Adapter for iPod/iPhone



Note: To ensure the projector works well with your computer, please make sure the timing of the display mode is compatible with the projector.

Adjusting the Projected Image

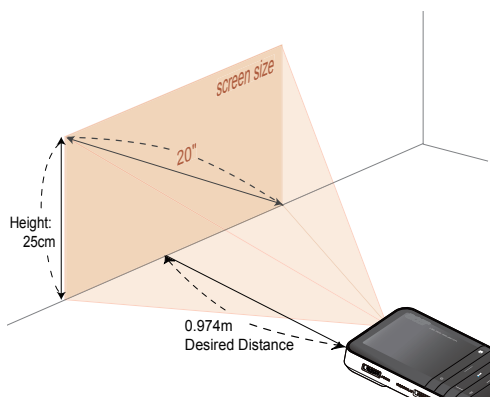

Desired Distance (m)	Screen Size	
	Diagonal (inch)	W(cm) x H(cm)
0.245	5.0	11 x 6
0.500	10.3	23 x 13
0.700	14.4	32 x 18
0.974	20.0	44 x 25
1.500	30.8	68 x 38
2.000	41.1	91 x 51
2.500	51.3	114 x 64
3.215	66.0	146 x 82

User Controls

How to Use the Menu

English



1. Display the Main Menu. (↵)
2. Highlight the desired option (| |)
3. Enter the desired option. (↵)
4. Highlight the desired item. (| _ |)
5. Select the item. (↵)
6. Press (≡) to go up one directory.

Under external signal mode, press (≡) to bring out the OSD.
 The OSD disappears in 5 seconds if there is no OSD operation.
 The projector will automatically shut down if the projector is idle at its main menu or sub menu for 3 minutes. (Only in the battery state.)

Note: External signal mode is applicable for connecting VGA, Composite, HDMI and Component signals.
Note: The first time you use the projector, you can select your preferred language from the quick menu after the startup screen displays.











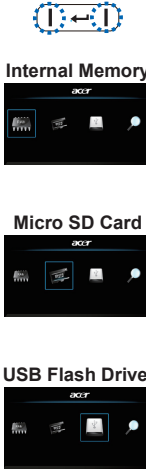
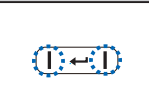
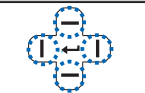

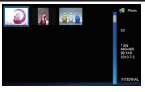

Source: Composite AV, VGA, Component and HDMI

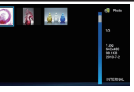
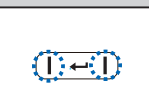
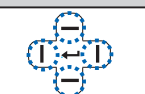
<p>Composite, HDMI or Component source</p>	<p>Bright mode: Full LED power.</p> <p>STD mode: Standard LED power.</p> <p>Front Desktop.</p> <p>Rear Desktop.</p> <p>Front Inverted.</p> <p>Rear Inverted.</p>	<p>H. Position: adjust the horizontal position.</p> <p>V. Position: adjust the vertical position.</p> <p>Frequency: change the display data frequency to match the frequency of your computer's graphic card. Use this function only if the image appears to flicker vertically.</p> <p>Phase: synchronize the signal timing of the display with the graphic card. If the image appears to be unstable or flickers, use this function to correct it.</p>
	<p>VGA source</p> <p>4x3 aspect ratio.</p> <p>16x9 aspect ratio.</p> <p>Auto aspect ratio.</p> <p>Contrast: adjust contrast</p>	

Source: Internal Memory, Micro SD Card, and USB Flash Drive

Videos			
Main menu	Internal Memory	Micro SD Card	USB Flash Drive
Item			<p>Adjust Volume 00:05 00:28</p> <p> Fast forward</p> <p> Rewind</p> <p> Play/Pause</p> <p> Exit Video mode</p>

Source: Internal Memory, Micro SD Card, and USB Flash Drive

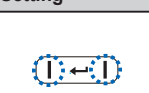
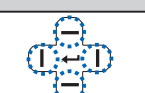
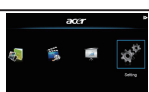
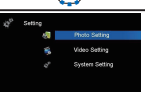
Main menu	Item				
	Photos				
					
					
	Presentation				
					
					
	Setting				
			Photo Setting		
			Slideshow Duration Timer: Select duration of slideshow (Off, 2 sec., 5 sec., 10 sec.). Slideshow Repeat: Enable slideshow repeat (Off, On).		
			Video Setting		
		Play Mode: Select play mode (Once, Repeat, Repeat Once).			
		System Setting			
		Language: Select preferred language for on-screen menus.			
		Brightness: Select LED mode (STD, ECO).			
		Projection: Select the projection mode (Front Desktop, Rear Desktop, Front Inverted, Rear Inverted).			
		Version: Displays firmware version.			

Using MPtG Converter Tool

Download MPtG converter tool from internal memory of projector.
You can use this tool to transfer PPT/PDF files to projector.

To install converter tool:

1. Connect the projector for data transfer.
2. Browse internal memory of Projector (like a USB memory stick) to download converter "mptg.exe" from a folder "Converter".
3. Execute the file "mptg.exe" on your PC/NB, and follow the onscreen instructions to finish installation.



Click converter to select a PowerPoint or PDF files and start conversion. The tool will transfer PowerPoint/PDF files to MPtG format. You can copy all of converted results in media (ex. USB drive) you have and play MPtG files on Presentation mode of Projector.



Note: Please make sure the Microsoft office is installed before playing PtG.

How to Play iPhone/iPod Media via C20

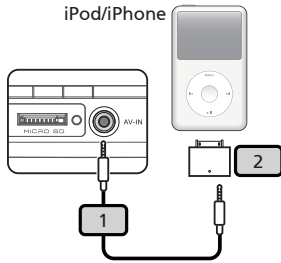

Adjust C20 source upto "Composite" and make sure to plug adapter with iPod/iPhone well.

#	Description
1	2.5mm-to-3.5mm A/V Cable
2	Adapter for iPod/iPhone

How to play photos

If using iPhone,

→ Photos →

Follow below steps:

1. Press application "Photo" on main screen and choose album.
2. Press ► in thumbnail page .

If using iPod,

→

Please make sure Photo setting in advance.
Follow below:

- If by iPod Nano:
Photos → Settings
- If by iPod Classic : Slideshow Settings
 - a. TV Out: choose On
 - b. TV Signal: choose NTSC

Follow below steps:

1. Choose photos and then choose which album you want. (ex. TOKYO)
2. If by iPod Nano : press ►|| when thumbnail mode.
3. If by iPod Classic : press ►► to enter "slideshow" mode and photo will be output automatically via C20.

How to play videos

If using iPhone,

→ iPod →

Follow below steps:

1. Press application "Video" in main screen.
2. Press video clip you want in Video clip listing, then video will be output automatically via C20.

Same behavior by iPhone and iPod.

Appendices

Troubleshooting

If you experience a problem with your Acer projector, refer to the following troubleshooting guide. If the problem persists, please contact your local reseller or service center.

Image Problems and Solutions

#	Problem	Solution
1	No image appears on-screen	<ul style="list-style-type: none"> Ensure the cables/charger/battery are correctly and securely connected. Ensure the pins of connectors are not crooked or broken. Make sure the projector is switched on.
2	Image is out of focus	<ul style="list-style-type: none"> Adjust the Focus Dial. Make sure the projection screen is between the required distance 9.6 to 126.6 inches (0.245 to 3.215 meters) from the projector.
3	Image is too small or too large	<ul style="list-style-type: none"> Move the projector closer to or further from the screen.
4	Image is reversed	<ul style="list-style-type: none"> Select "Source --> Settings --> System Setup --> Projection" from the OSD and adjust the projection direction.



Audio Problems

1	No sound	<ul style="list-style-type: none"> Press the  + button.
---	----------	---

Battery Problems

#	Problem	Solution
1	Battery capacity is low 	<ul style="list-style-type: none"> Remove the battery and clean the connectors. The battery is worn out and needs to be replaced. The battery may not charge right after the projector is turned off due to the high temperature emitted by the projector.

Message Reminder

1	Out of the range 	Please see "Compatibility Modes"
2	High battery consumption 	Please change the battery.

Compatibility Modes

Mode	Resolution	V-Sync (Hz)
VGA	640x480	60
	800x600	60
	1024x768	60
	1280x720	60
	1280x800	60
Composite Component HDMI	480i / 480P	60
	576i / 576P	50
	720P	50 / 60
	1080i	50 / 60

Multimedia Format: Video

File Format	Video Format	Max Res.	Profile
AVI, MOV, MP4, 3GP	H.264	720X480 30fps or 720x576 25fps	Baseline
AVI	MPEG4		Simple Profile
AVI	Xvid		Baseline
AVI	MJPEG	640X480 30fps	Baseline

Photo

File Format	File Extension	File Format
BMP	*.bmp	AAC, MP3, PCM, ADPCM, WMA, OGG
JPG, JPEG	*.jpg, *.jpeg	

Audio

Media Card (micro SD/SDHC)

C20 support Micro SD/SDHC up to 16GB, Class 2~6. Below are recommended models:

Manufacturer	Model Name	Capacity
A-Data	microSD2G+Adapter	2GB
A-Data	MM4GR01GUACU-PA	1GB
APACER	MM4GR01GUACE-PA	1GB
Kingmax	T02GSEMASI	2GB
Kingston	SDC/1GBFE	1GB
Kingston	SDC/2GBFE	2GB
PQI	AE81-2030R C20HF0730001	2GB
RiDATA	E247TNO1GIOBE	1GB
SanDisk	SDSDQ-1024-J3K	1GB
SanDisk	SDSDQ-2048-E10M	2GB
SanDisk	SDSDQ-2048-J3K	2GB
SanDiskn	07186023400PC (SDHC)	4GB
Toshiba	SD-C02GR4W	2GB
Transcend	TS1GUSD	1GB
Transcend	TS2GUSD	2GB



Note: Video format does not support content with B-Frame function.