



**Canon**

# *PowerShot G1 X*

## **Getting Started**

Please refer to the complete user guide included on the CD-ROM for more detailed information.

- Make sure you read this guide, including the “Safety Precautions” section, before using the camera.
- Reading this guide will help you learn to use the camera properly.
- Store this guide safely so that you can use it in the future.

**ENGLISH**

## Package Contents

Before use, make sure the following items are included in the package. If anything is missing, contact your camera dealer.



Camera



Battery Pack NB-10L  
(with terminal cover)



Battery Charger  
CB-2LC/CB-2LCE

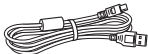

Interface Cable  
IFC-400PCU

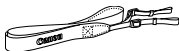

Neck Strap  
NS-DC9



Lens Cap  
(with cord)



Getting Started  
(This Guide)



DIGITAL CAMERA  
Solution Disk



Warranty Card

- A memory card is not included (see below).

## About Getting Started (This Guide) and the PDF Manuals

This guide introduces basic camera operations.

To master more advanced operations and use the included software, refer to the PDF manuals on the CD-ROM (p. 27).



- Adobe Reader is required to view the PDF manuals.

## Compatible Memory Cards

The following memory cards (sold separately) can be used, regardless of capacity.

- SD memory cards\*
- SDHC memory cards\*
- SDXC memory cards\* 
- Eye-Fi cards

\* Conforms to SD specifications. However, not all memory cards have been verified to work with the camera.

## About Eye-Fi Cards

This product is not guaranteed to support Eye-Fi card functions (including wireless transfer). In case of an issue with an Eye-Fi card, please check with the card manufacturer.

Also note that an approval is required to use Eye-Fi cards in many countries or regions. Without approval, use of the card is not permitted. If it is unclear whether the card has been approved for use in the area, please check with the card manufacturer.



- Always confirm beforehand that memory cards are supported on other devices such as card readers and computers (including the current version of your operating system).

## Preliminary Notes and Legal Information

- Take and review some test shots initially to make sure the images were recorded correctly. Please note that Canon Inc., its subsidiaries and affiliates, and its distributors are not liable for any consequential damages arising from any malfunction of a camera or accessory, including memory cards, that results in the failure of an image to be recorded or to be recorded in a way that is machine readable.
- Images recorded by the camera are intended for personal use. Refrain from unauthorized recording that infringes on copyright law, and note that even for personal use, photography may contravene copyright or other legal rights at some performances or exhibitions, or in some commercial settings.
- The camera warranty is valid only in the area of purchase. In case of camera problems while abroad, return to the area of purchase before contacting a Canon Customer Support Help Desk.
- Although the LCD monitor is produced under extremely high-precision manufacturing conditions and more than 99.99% of the pixels meet design specifications, in rare cases some pixels may be defective or may appear as red or black dots. This does not indicate camera damage or affect recorded images.
- The LCD monitor may be covered with a thin plastic film for protection against scratches during shipment. If covered, remove the film before using the camera.
- When the camera is used over an extended period, it may become warm. This does not indicate damage.

# Part Names and Conventions in This Guide

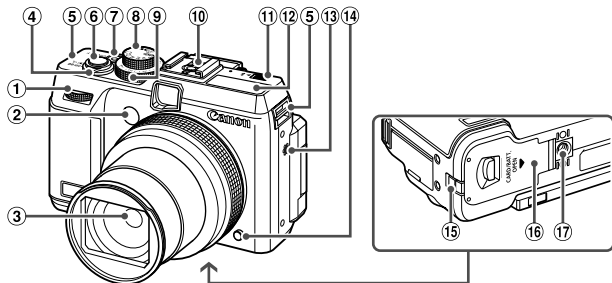

- |                                 |                              |
|---------------------------------|------------------------------|
| ① Front dial                    | ⑧ Mode dial                  |
| ② Lamp                          | ⑨ Exposure compensation dial |
| ③ Lens                          | ⑩ Hot shoe                   |
| ④ Zoom lever                    | ⑪  (Pop up flash) switch     |
| Shooting:  (telephoto) /        | ⑫ Flash                      |
| (wide angle)                    | ⑬ Speaker                    |
| Playback:  (magnify) /  (index) | ⑭ Ring release button        |
| ⑤ Strap mount                   | ⑮ DC coupler cable port      |
| ⑥ Shutter button                | ⑯ Memory card/battery cover  |
| ⑦ Power button/lamp             | ⑰ Tripod socket              |

- In this guide, icons are used to represent the corresponding camera buttons and dials on which they appear or which they resemble.
- The following camera buttons and controls are represented by icons.
  - Front dial ① on front
  - Up button ⑯ on back
  - Left button ⑰ on back
  - Control dial ⑱ on back
  - FUNC./SET button ⑲ on back
  - Right button ⑳ on back
  - Down button ㉑ on back
- On-screen text is indicated in brackets.
- : Important information you should know
- : Notes and tips for expert camera use
- (p. xx): Pages with related information (in this example, “xx” represents a page number)
- Instructions in this guide apply to the camera under default settings.

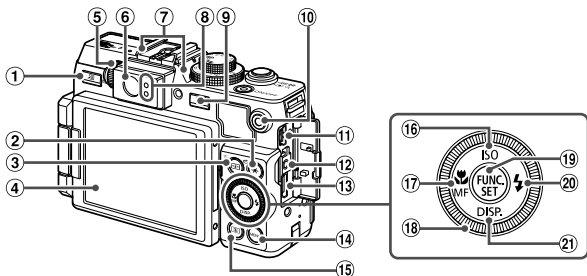

- |   |  |
|---|--|
| ①  (Shortcut) /  (Direct print) button                | ⑫ Remote terminal                            |
| ②  (AE lock/FE lock) /  (Jump) button                 | ⑬ HDMI™ terminal                             |
| ③  (AF Frame Selector) /  (Single image erase) button | ⑭ MENU button                                |
| ④ Screen (LCD monitor)                                | ⑮  (Metering) button                         |
| ⑤ Diopter adjustment dial                             | ⑯ ISO speed / Up button                      |
| ⑥ Viewfinder  | ⑰  (Macro) / MF (Manual focus) / Left button |
| ⑦ Microphone  | ⑱ Control dial                               |
| ⑧ Indicator   | ⑲ FUNC./SET button                           |
| ⑨  (Playback) button                                  | ⑳  (Flash) / Right button                    |
| ⑩ Movie button  | ㉑ DISP. (Display) / Down button              |
| ⑪ AV OUT (Audio/video output) / DIGITAL terminal      |  |



- Turning the control dial is one way to choose setting items, switch images, and perform other operations. Most of these operations are also possible with the buttons.

- For convenience, all supported memory cards are simply referred to as “the memory card” .
- The tabs shown above titles indicate whether the function is used for still images, movies, or both.

**Still Images** : Indicates that the function is used when shooting or viewing still images.

**Movies** : Indicates that the function is used when shooting or viewing movies.

# Contents

Package Contents .....	2	Safety Precautions .....	6
Compatible Memory Cards .....	2	Initial Preparations .....	9
Preliminary Notes and Legal Information.....	3	Trying the Camera Out.....	17
Part Names and Conventions in This Guide .....	4	Included Software, PDF Manuals....	22
Contents .....	6	Accessories .....	28
		Specifications .....	30

## Safety Precautions

- Before using the product, please ensure that you read the safety precautions described below. Always ensure that the product is used correctly.
- The safety precautions noted on the following pages are intended to prevent injuries to yourself and other persons, or damage to the equipment.
- Be sure to also check the guides included with any separately sold accessories you use.



### Warning

Denotes the possibility of serious injury or death.

- **Do not trigger the flash in close proximity to people's eyes.**

Exposure to the intense light produced by the flash could damage eyesight. In particular, remain at least one meter (39 inches) away from infants when using the flash.

- **Store this equipment out of the reach of children and infants.**

Strap: Putting the strap around a child's neck could result in asphyxiation.

- **Use only recommended power sources.**
- **Do not attempt to disassemble, alter or apply heat to the product.**
- **Avoid dropping or subjecting the product to severe impacts.**
- **To avoid the risk of injury, do not touch the interior of the product if it has been dropped or otherwise damaged.**
- **Stop using the product immediately if it emits smoke, a strange smell, or otherwise behaves abnormally.**
- **Do not use organic solvents such as alcohol, benzene, or thinner to clean the product.**
- **Do not let the product come into contact with water (e.g. sea water) or other liquids.**
- **Do not allow liquids or foreign objects to enter the camera.**

This could result in electrical shock or fire.

If liquids or foreign objects come into contact with the camera interior, immediately turn the camera off and remove the battery.

If the battery charger becomes wet, unplug it from the outlet and consult your camera distributor or a Canon Customer Support Help Desk.

- **Do not look through the viewfinder at bright light sources (such as the sun on a clear day).**

This could damage your eyesight.

- Use only the recommended battery.
- Do not place the battery near or in direct flame.
- Unplug the power cord periodically, and using a dry cloth, wipe away any dust and dirt that has collected on the plug, the exterior of the power outlet, and the surrounding area.
- Do not handle the power cord with wet hands.
- Do not use the equipment in a manner that exceeds the rated capacity of the electrical outlet or wiring accessories. Do not use if the power cord or plug are damaged, or not fully plugged into the outlet.
- Do not allow dirt or metal objects (such as pins or keys) to contact the terminals or plug.

The battery may explode or leak, resulting in electrical shock or fire. This could cause injury and damage the surroundings. In the event that a battery leaks and the battery electrolyte contacts eyes, mouth, skin or clothing, immediately flush with water.

- Turn the camera off in places where camera use is prohibited.

The electromagnetic waves emitted by the camera may interfere with the operation of electronic instruments and other devices. Exercise adequate caution when using the camera in places where use of electronic devices is restricted, such as inside airplanes and medical facilities.

- Do not play the supplied CD-ROM(s) in any CD player that does not support data CD-ROMs.

It is possible to suffer hearing loss from listening with headphones to the loud sounds of a CD-ROM played on an audio CD player (music player). Additionally, this could damage the speakers.



## Caution

Denotes the possibility of injury.

- When holding the camera by the strap, be careful not to bang it, subject it to strong impacts or shocks, or let it get caught on other objects.
- Be careful not to bump or push strongly on the lens.

This could lead to injury or damage the camera.

- When using the flash, be careful not to cover it with your fingers or clothing.

This could result in burns or damage to the flash.

- Avoid using, placing or storing the product in the following places:

- Places subject to strong sunlight
- Places subject to temperatures above 40 °C (104 °F)
- Humid or dusty areas

These could cause leakage, overheating or an explosion of the battery, resulting in electrical shock, fire, burns or other injuries.

High temperatures may cause deformation of the camera or battery charger casing.

- Viewing images on the camera screen for prolonged periods may cause discomfort.

### Caution

Denotes the possibility of damage to the equipment.

- **Do not aim the camera at bright light sources (such as the sun on a clear day).**  
Doing so may damage the image sensor.

- **When using the camera on a beach or at a windy location, be careful not to allow dust or sand to enter the camera.**

This may cause the product to malfunction.

- **In regular use, small amounts of smoke may be emitted from the flash.**

This is due to the high intensity of the flash burning dust and foreign materials stuck to the front of the unit. Please use a cotton swab to remove dirt, dust or other foreign matter from the flash to prevent heat build-up and damage to the unit.

- **Remove and store the battery when you are not using the camera.**

If the battery is left inside the camera, damage caused by leakage may occur.

- **Before you discard the battery, cover the terminals with tape or other insulators.**

Contacting other metal materials may lead to fire or explosions.

- **Unplug the battery charger from the power outlet after charging is complete, or when you are not using it.**

- **Do not place anything, such as cloth, on top of the battery charger while it is charging.**

Leaving the unit plugged in for a long period of time may cause it to overheat and distort, resulting in fire.

- **Do not place the battery near pets.**

Pets biting the battery could cause leakage, overheating or explosion, resulting in fire or damage.

- **When putting the camera in your bag, close the screen to face inward to ensure that hard objects do not come into contact with the screen.**

- **Do not attach any hard objects to the camera.**

Doing so may cause malfunctions or damage the screen.

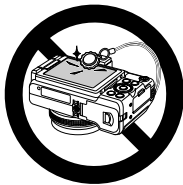



# Initial Preparations

Prepare for shooting as follows.

## Attaching Accessories

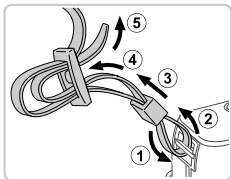

### 1 Attach the strap.

- Attach the included strap to the camera as shown.
- On the other side of the camera, attach the strap the same way.

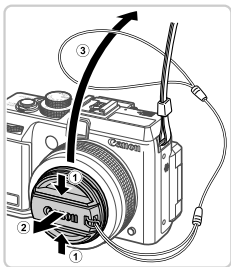

### 2 Attach the lens cap to the strap.

- Remove the lens cap from the lens and attach the lens cap cord to the strap.
- Always remove the lens cap before turning the camera on. Try attaching the lens cap to the neck strap when the cap is not in use.
- Keep the lens cap on the lens when the camera is not in use.

## Holding the Camera



- Place the strap around your neck.
- When shooting, keep your arms close to your body and hold the camera securely to prevent it from moving. If you have raised the flash, do not rest your fingers on it.

## Charging the Battery

Before use, charge the battery with the included charger. Be sure to charge the battery initially, because the camera is not sold with the battery charged.

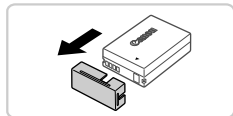

### 1 Remove the cover.

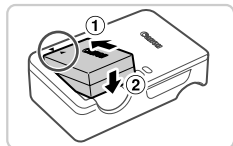

### 2 Insert the battery.

- After aligning the ▲ marks on the battery and charger, insert the battery by pushing it in (①) and down (②).

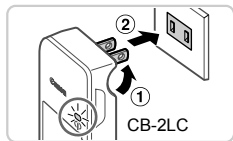

### 3 Charge the battery.

- **For CB-2LC:** Flip out the plug (①) and plug the charger into a power outlet (②).
- **For CB-2LCE:** Plug the power cord into the charger, then plug the other end into a power outlet.

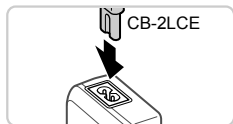

- ▶ The charging lamp turns orange and charging begins.
- ▶ When the charging is finished, the lamp turns green.

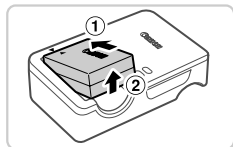

### 4 Remove the battery.

- After unplugging the battery charger, remove the battery by pushing it in (①) and up (②).

- ❗ To protect the battery and keep it in optimal condition, do not charge it continuously for more than 24 hours.
- For battery chargers that use a power cord, do not attach the charger or cord to other objects. Doing so could result in malfunction or damage to the product.



- For details on charging time and the number of shots and recording time possible with a fully charged battery, see “Specifications” (p. 30).

## Inserting the Battery and Memory Card

Insert the included battery and a memory card (sold separately). Note that before using a new memory card (or a memory card formatted in another device), you should format the memory card with this camera (see *Camera User Guide*).

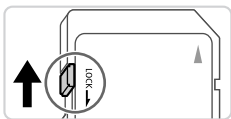

### 1 Check the card's write-protect tab.

- Recording is not possible on memory cards with a write-protect tab when the tab is in the locked (downward) position. Slide the tab up until it clicks into the unlocked position.

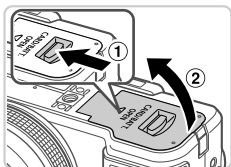

### 2 Open the cover.

- Slide the switch (①) and open the cover (②).

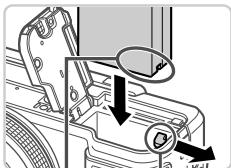

### 3 Insert the battery.

- While pressing the battery lock in the direction of the arrow, insert the battery facing as shown and push it in until it clicks into the locked position.

Terminals    Battery Lock

- If you insert the battery facing the wrong way, cannot be locked into the correct position. Always confirm that the battery is facing the right way and locks when inserted.

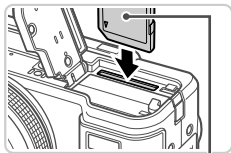

Label

### 4 Insert the memory card.

- Insert the memory card facing as shown until it clicks into the locked position.
- Make sure the memory card is facing the right way when you insert it. Inserting memory cards facing the wrong way may damage the camera.

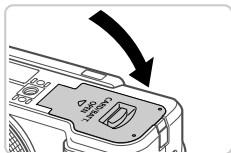

### 5 Close the cover.

- Lower the cover in the direction of the arrow and press it until it clicks into the closed position.

## Removing the Battery and Memory Card

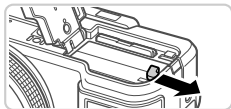

### Remove the battery.

- Open the cover and press the battery lock in the direction of the arrow.
- ▶ The battery will pop up.

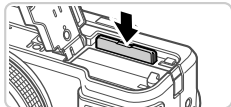

### Remove the memory card.

- Push the memory card in until it clicks, and then slowly release it.
- ▶ The memory card will pop up.

## Using the Screen

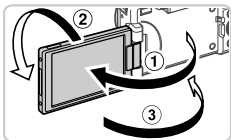

### Prepare the screen for use.

- Open the screen (①) and rotate it toward the lens 180° (②).
- Close the screen in this orientation (③).

- ! • The screen can only open to approximately 175° in direction ①. Be careful not to open the screen any further than this, as it will damage the camera.

### Adjusting the Screen Angle and Orientation

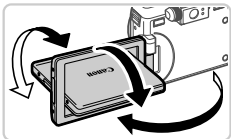

- You can adjust the angle and orientation of the screen as needed, to suit shooting conditions.
- To protect the screen when the camera is not in use, always keep it closed and facing the camera body.

- ! • If the screen is closed and facing the camera body, you will not be able to shoot a movie.



- When including yourself in shots, you can view a mirror image of yourself by rotating the screen around toward the front of the camera. To cancel reverse display, press the **MENU** button, choose [Reverse Disp.] on the **DISP** tab, and press the **◀▶** buttons to choose [Off].

## Setting the Date and Time

A screen for setting the date and time is displayed the first time you turn the camera on. Be sure to specify the date and time, which is the basis for dates and times added to your images.

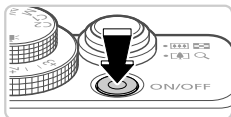

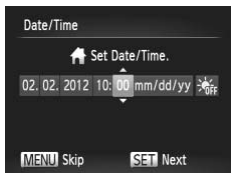

### 1 Turn the camera on.

- Press the power button.
- ▶ The [Date/Time] screen is displayed.



### 2 Set the date and time.

- Press the ◀▶ buttons to choose an option.
- Press the ▲▼ buttons or turn the  dial to specify the date and time.
- When finished, press the  button.



### 3 Set the local time zone.





- Press the ◀▶ buttons or turn the  dial to choose your local time zone.



### 4 Finish the setup process.

- Press the  button when finished. After a confirmation message, the setting screen is no longer displayed.
- To turn off the camera, press the power button.

- ⓘ Unless you set the date, time, and local time zone, the [Date/Time] screen will be displayed each time you turn the camera on. Specify the correct information.

-  To set daylight saving time (1 hour ahead), choose  in step 2 and then choose  by pressing the  buttons or turning the  dial.

## Changing the Date and Time

Adjust the date and time as follows.





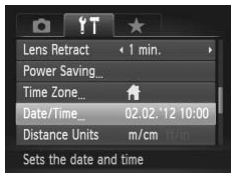

### 1 Access the camera menu.

- Press the **MENU** button.





### 2 Choose [Date/Time].

- Move the zoom lever to choose the  tab.
- Press the  buttons or turn the  dial to choose [Date/Time], and then press the  button.

### 3 Change the date and time.

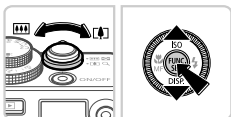
- Follow step 2 on p. 14 to adjust the settings.
- Press the **MENU** button to close the menu.



-  Date/time settings can be retained for about 3 weeks by the camera's built-in date/time battery (backup battery) after the battery pack is removed.
- The date/time battery will be charged in about 4 hours once you insert a charged battery or connect the camera to an AC adapter kit (sold separately, see *Camera User Guide*), even if the camera is left off.
- Once the date/time battery is depleted, the [Date/Time] screen will be displayed when you turn the camera on. Follow the steps on p. 14 to set the date and time.

## Display Language

The display language can be changed as needed.

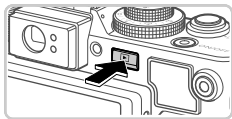

### 1 Enter Playback mode.

- Press the  button.









### 2 Access the setting screen.



- Press and hold the  button, and then immediately press the **MENU** button.



### 3 Set the display language.

- Press the     buttons or turn the  dial to choose a language, and then press the  button.
- ▶ Once the display language has been set, the setting screen is no longer displayed.



- A clock icon is displayed if you wait too long in step 2 after pressing the  button before you press the **MENU** button. In this case, press the  button to dismiss the clock icon and repeat step 2.
- You can also change the display language by pressing the **MENU** button and choosing [Language  tab.



# Trying the Camera Out

Follow these instructions to turn the camera on, shoot still images or movies, and then view them.

## Shooting (Smart Auto)

For fully automatic selection of the optimal settings for specific scenes, simply let the camera determine the subject and shooting conditions.

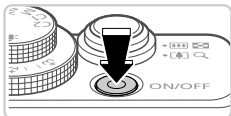

### 1 Turn the camera on.

- Press the power button.
- ▶ The startup screen is displayed.

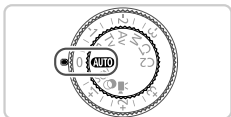

### 2 Enter **AUTO** mode.

- Set the mode dial to **AUTO**.
- Aim the camera at the subject. As the camera determines the scene, it will make a slight clicking noise.
- ▶ Icons representing the scene and image stabilization mode are displayed in the upper right of the screen.
- ▶ Frames displayed around any subjects that are detected indicate that they are in focus.



### 3 Compose the shot.

- To zoom in and enlarge the subject, move the zoom lever toward [🌳] (telephoto), and to zoom away from the subject, move it toward [|||] (wide angle).

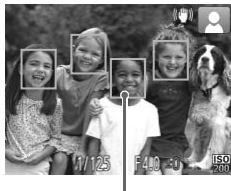
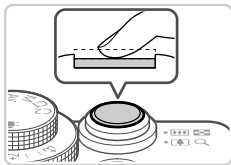

AF Frames

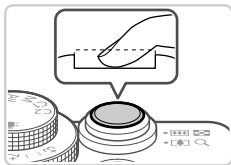
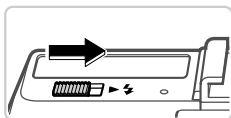

#### 4 Shoot.

### Shooting Still Images

#### ① Focus.

- Press the shutter button lightly, halfway down. The camera beeps twice after focusing, and AF frames are displayed to indicate image areas in focus.

- If [Raise the flash] appears on the screen, move the switch to raise the flash. It will fire when shooting. If you prefer not to use the flash, push it down with your finger, into the camera.

#### ② Shoot.

- Press the shutter button all the way down.
- ▶ As the camera shoots, a shutter sound is played, and in low-light conditions when you have raised the flash, it fires automatically.
- ▶ Your shot remains displayed on the screen for about two seconds.
- Even while the shot is displayed, you can take another shot by pressing the shutter button again.



Elapsed Time

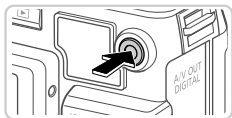

## Shooting Movies

### ① Start shooting.

- If the flash is already up, push it down with your finger, into the camera.
- Press the movie button. The camera beeps once as recording begins, and [●Rec] is displayed with the elapsed time.
- ▶ Black bars displayed on the top and bottom edges of the screen indicate image areas not recorded.
- Once recording begins, you can take your finger off the movie button.

### ② Finish shooting.

- Press the movie button again to stop shooting. The camera beeps twice as recording stops.
- ▶ Recording will stop automatically when the memory card becomes full.

## Viewing

After shooting images or movies, you can view them on the screen as follows.

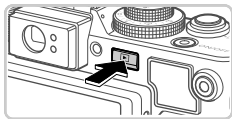





### 1 Enter Playback mode.







- Press the  button.
- ▶ Your last shot is displayed.



### 2 Browse through your images.

- To view the previous image, press the  button or turn the  dial counterclockwise. To view the next image, press the  button or turn the  dial clockwise.
- Press and hold the  buttons to browse through images quickly. Images appear grainy at this time.



- To access Scroll Display mode, turn the  dial rapidly. In this mode, turn the  dial to browse through images.
- To return to single-image display, press the  button.
- To browse images grouped by shooting date, press the  buttons in Scroll Display mode.
- Movies are identified by a   icon. To play movies, go to step 3.





### 3 Play movies.

- Press the **FUNC/SET** button to access the movie control panel, choose **▶** (either press the **◀▶** buttons or turn the **DISP** dial), and then press the **FUNC/SET** button again.
- ▶ Playback now begins, and after the movie is finished, **SET** is displayed.
- To adjust the volume, press the **▲▼** buttons.



• To switch to Shooting mode from Playback mode, press the shutter button halfway.

## Erasing the Images

You can choose and erase unneeded images one by one. Be careful when erasing images, because they cannot be recovered.

### 1 Choose an image to erase.

- Press the **◀▶** buttons or turn the **DISP** dial to choose an image.



### 2 Erase the images.

- Press the **🗑️** button.
- After [Erase?] is displayed, press the **◀▶** buttons or turn the **DISP** dial to choose [Erase], and then press the **FUNC/SET** button.
- ▶ The current image is now erased.
- To cancel erasure, press the **◀▶** buttons or turn the **DISP** dial to choose [Cancel], and then press the **FUNC/SET** button.

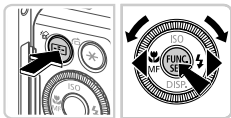

• You can also erase all images at once (see *Camera User Guide*).

## Included Software, PDF Manuals

The software and PDF manuals on the included CD-ROM are introduced below, with instructions for installation, saving images to a computer, and using the PDF manuals.

### Features of the Included Software

After installing the software on the CD-ROM, you can do the following things on your computer.



#### ZoomBrowser EX ImageBrowser

- Import images and change camera settings
- Manage images: browse, search, and organize
- Print and edit images

#### Digital Photo Professional

- Browse, process and edit RAW images

### PDF Manuals

The following PDF manuals are provided on the included CD-ROM.



#### Software Guide

Refer to the *Software Guide* when using the included software. Windows and Macintosh versions are provided.



#### Camera User Guide

Once you are familiar with the information in this manual, refer to the guide for a more in-depth understanding of camera operation.

## System Requirements

The included software can be used on the following computers. Adobe Reader is required to view the PDF manuals.

### Windows

Operating System	Windows 7 (including SP1) Windows Vista SP2 Windows XP SP3
Computer	Computers running one of the above operating systems (preinstalled), with an included USB port
Processor	Pentium 1.3 GHz or higher (still images), Core 2 Duo 2.6 GHz or higher (movies)
RAM	Windows 7 (64 bit): 2 GB or more Windows 7 (32 bit), Windows Vista (64 bit, 32 bit), Windows XP: 1 GB or more (still images), 2 GB or more (movies)
Interfaces	USB
Free Hard Disk Space	620 MB or more*
Display	1024 x 768 resolution or higher

\* In Windows XP, Microsoft .NET Framework 3.0 or later (max. 500 MB) must be installed. Installation may take some time, depending on computer performance.

### Macintosh

Operating System	Mac OS X 10.5 – 10.6
Computer	Computers running one of the above operating systems (preinstalled), with an included USB port
Processor	Intel Processor (still images), Core 2 Duo 2.6 GHz or higher (movies)
RAM	1 GB or more (still images), 2 GB or more (movies)
Interfaces	USB
Free Hard Disk Space	680 MB or more
Display	1024 x 768 resolution or higher

• Check the Canon website for the latest system requirements, including supported OS versions.

## Installing the Software and PDF Manuals

Windows 7 and Mac OS X 10.6 are used here for the sake of illustration.

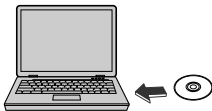

### 1 Insert the CD-ROM in the computer's CD-ROM drive.

- Insert the included CD-ROM (DIGITAL CAMERA Solution Disk) (p. 2) in the computer's CD-ROM drive.
- On a Macintosh computer, after inserting the disc, double-click the desktop disc icon to open it, and then double-click the  icon displayed.



### 2 Install the files.

- In Windows, click [Easy Installation], or on a Macintosh computer, click [Install]. Follow the on-screen instructions to complete the installation process.
- If the [User Account Control] window is displayed in Windows, follow the on-screen instructions.



### 3 Complete the installation.

- In Windows, click [Restart] or [Finish] and remove the CD-ROM after the desktop is displayed.
- On a Macintosh computer, click [Finish] on the screen after installation and remove the CD-ROM when the desktop is displayed.



## Saving Images to a Computer

Windows 7 and Mac OS X 10.6 are used here for the sake of illustration.

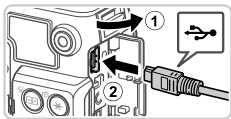

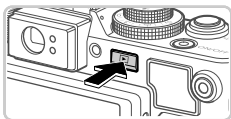
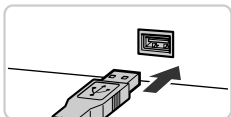

### 1 Connect the camera to the computer.

- Make sure the camera is off.
- Open the cover (①). With the smaller plug of the included interface cable (p. 2) in the orientation shown, insert the plug fully into the camera terminal (②).
- Insert the larger plug of the interface cable in the computer's USB port. For details about USB connections on the computer, refer to the computer user manual.



### 2 Turn the camera on to access CameraWindow.

- Press the  button to turn the camera on.
- On a Macintosh computer, CameraWindow is displayed when a connection is established between the camera and computer.
- For Windows, follow the steps introduced below.
- In the screen that displays, click the  link to modify the program.

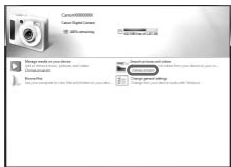

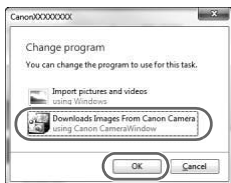

- Choose [Downloads Images From Canon Camera using Canon CameraWindow] and then click [OK].



- Double click  .

### CameraWindow

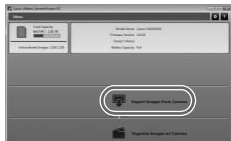

### 3 Save the images to the computer.

- Click [Import Images from Camera], and then click [Import Untransferred Images].
- ▶ Images are now saved to the Pictures folder on the computer, in separate folders named by date.
- After images are saved, close CameraWindow, press the  button to turn the camera off, and unplug the cable.
- For instructions on viewing images on a computer, refer to the *Software Guide*.



- In Windows 7, if the screen in step 2 is not displayed, click the  icon in the taskbar.
- To start CameraWindow in Windows Vista or XP, click [Downloads Images From Canon Camera using Canon CameraWindow] on the screen displayed when you turn the camera on in step 2. If CameraWindow is not displayed, click the [Start] menu and choose [All Programs] ► [Canon Utilities] ► [CameraWindow] ► [CameraWindow].
- On a Macintosh computer, if CameraWindow is not displayed after step 2, click the [CameraWindow] icon in the Dock (the bar at the bottom of the desktop).
- Although you can save images to a computer simply by connecting your camera to the computer without using the included software, the following limitations apply.
  - It may take a few minutes after you connect the camera to the computer until camera images are accessible.
  - Images shot in vertical orientation may be saved in horizontal orientation.
  - RAW images (or JPEG images recorded with RAW images) may not be saved.
  - Image protection settings may be cleared from images saved to a computer.
  - Some problems may occur when saving images or image information, depending on the operating system version, the software in use, or image file sizes.
  - Some functions provided by the included software may not be available, such as editing movies or returning images to the camera.

## Using the PDF Manuals

You can access the PDF manuals by double-clicking the desktop shortcut icons created when the included CD-ROM is used for installation. Adobe Reader is required to view the PDF manuals.



Canon\_CUG



Software\_Gui...



- It may not be possible to install the software and PDF manuals on computers that do not meet the system requirements (see *Camera User Guide*). To view the manuals on these computers, copy the PDF files in the Readme folder on the CD-ROM directly to a computer capable of using Adobe Reader.

# Accessories

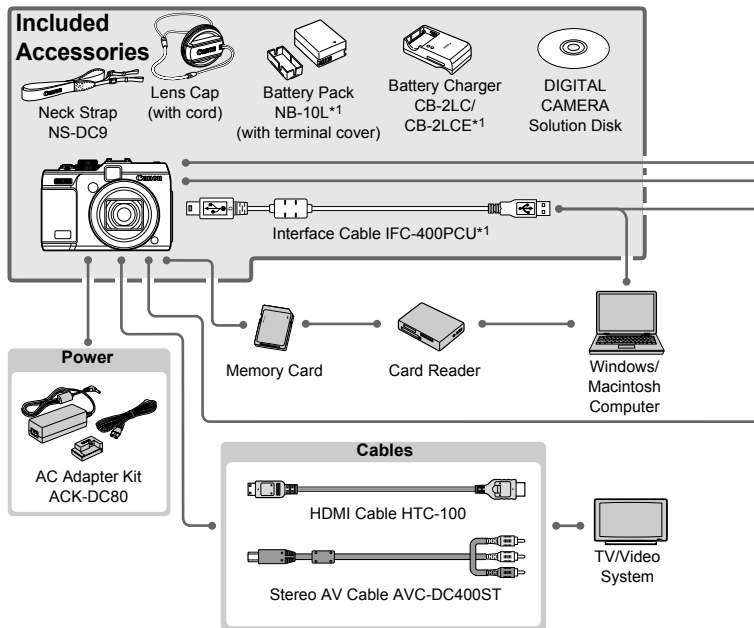

\*1 Also available for purchase separately.

\*2 Speedlite Transmitter ST-E2, Speedlite Bracket SB-E2 and Off-Camera Shoe Cord OC-E3 are also supported.

\*3 Bracket BKT-DC1, Off-Camera Shoe Cord OC-E3, Macrolite Adapter MLA-DC1 are required to attach these accessories.

\*4 Macrolite Adapter MLA-DC1 is required to attach this accessory.

\*5 Requires Waterproof Case Weight WW-DC1.

\*6 Filter Adapter FA-DC58C is required to attach this accessory.

## CAUTION

RISK OF EXPLOSION IF BATTERY IS REPLACED BY AN INCORRECT TYPE.  
DISPOSE OF USED BATTERIES ACCORDING TO LOCAL REGULATION.

## Flash Units



Speedlite\*2  
580EX II, 430EX II,  
320EX, 270EX II



Macro Twin Lite  
MT-24EX\*3



Macro Ring Lite  
MR-14EX\*4

## Cases



Waterproof Case  
WP-DC44 \*5



Soft Case  
SC-DC75

## Lens Accessories



Canon-brand Lens Filter  
(58 mm dia.)\*6



Lens Hood  
LH-DC70

## Canon PictBridge-Compatible Printers



## Other Accessories



Remote Switch RS60-E3

### Use of genuine Canon accessories is recommended.

This product is designed to achieve excellent performance when used with genuine Canon accessories.

Canon shall not be liable for any damage to this product and/or accidents such as fire, etc., caused by the malfunction of non-genuine Canon accessories (e.g., a leakage and/or explosion of a battery pack). Please note that this warranty does not apply to repairs arising out of the malfunction of non-genuine Canon accessories, although you may request such repairs on a chargeable basis.

# Specifications

Camera Effective Pixels	Approx. 14.3 million pixels
Lens Focal Length	4x zoom: 15.1 (W) – 60.4 (T) mm (35mm film equivalent: 28 (W) – 112 (T) mm)
Viewfinder	Real-image zoom viewfinder Dioptric Adjustment Range: -3.0 to +1.0 m <sup>-1</sup> (dpt) Coverage: 77%
LCD Monitor	3.0 type color TFT LCD Effective Pixels: Approx. 922,000 dots
File Formats	Conforms to DCF and DPOF 1.1 standards
Data Types	Still Images: Exif 2.3 (JPEG) and RAW (Canon CR2 format) Movies: MOV (H.264 video data, Linear PCM (stereo) audio data)
Interfaces	Hi-speed USB HDMI output Analog audio output (stereo) Analog video output (NTSC/PAL)
Power	Battery Pack NB-10L AC Adapter Kit ACK-DC80
Dimensions (Based on CIPA Standards)	116.7 x 80.5 x 64.7 mm (4.60 x 3.17 x 2.55 in.)
Weight (Based on CIPA Guidelines)	Approx. 534 g (approx. 19.0 oz.; including battery and memory card) Approx. 492 g (approx. 17.3 oz.; camera body only)

## Number of Shots/Recording Time, Playback Time









<b>Number of Shots</b>	<b>Screen On</b>	Approx. 250
	<b>Screen Off</b>	Approx. 700
<b>Movie Recording Time*1</b>	<b>Screen On</b>	Approx. 1 hours, 10 minutes
	<b>Continuous Shooting*2</b>	Approx. 2 hours, 00 minutes
<b>Playback Time</b>		Approx. 7 hours, 00 minutes

\*1 Time under default camera settings, when normal operations are performed, such as shooting, pausing, turning the camera on and off, and zooming.

\*2 Time available when shooting the maximum movie length (until recording stops automatically) repeatedly.



- The number of shots that can be taken is based on measurement standards of the Camera & Imaging Products Association (CIPA).
- Under some shooting conditions, the number of shots and recording time may be less than mentioned above.
- Number of shots/recording time with fully charged battery.

## Number of 4:3 Shots per Memory Card

Resolution (Pixels)	Compression Ratio	No. Shots per Memory Card (Approx.)	
		4 GB	16 GB
<b>L</b> (Large) 14M/4352x3264		1040	4259
		2154	8824
<b>M1</b> (Medium 1) 7M/3072x2304		1978	8101
		4022	16473
<b>M2</b> (Medium 2) 2M/1600x1200		6352	26010
		12069	49420
<b>S</b> (Small) 0.3M/640x480		20116	82367
		30174	123550
RAW Images 4352x3264	—	190	783



- These values are measured according to Canon standards and may change depending on the subject, memory card and camera settings.
- Table values are based on images with a 4:3 aspect ratio. Changing the aspect ratio see *Camera User Guide* will enable more shots, because less data is used per image than for 4:3 images. However, with **M2**, 16:9 images have a resolution of 1920 x 1080 pixels, which requires more data than for 4:3 images.

## Recording Time per Memory Card

Image Quality	Recording Time per Memory Card	
	4 GB	16 GB
	14 min. 34 sec.	59 min. 40 sec.
	20 min. 43 sec.*1	1 hr. 24 min. 54 sec.*2
	43 min. 43 sec.	2 hr. 59 min. 03 sec.

\*1 Approx. 13 min. 35 sec. for iFrame movies see *Camera User Guide*.

\*2 Approx. 55 min. 38 sec. for iFrame movies see *Camera User Guide*.

- Based on Canon testing standards.
- Recording will automatically stop when the file size of an individual clip being recorded reaches 4 GB, or when the recording time reaches approximately 29 minutes and 59 seconds (for  or  movies) or approximately 1 hour (for  movies).
- On some memory cards, recording may stop before the maximum clip length has been reached. Speed Class 6 or higher memory cards are recommended.

### Flash Range

Maximum wide angle (☹☹☹)	50 cm – 7.0 m (approx. 1.6 – 23 ft.)
Maximum telephoto (☹☹☹)	100 cm – 3.1 m (approx. 3.3 – 10.2 ft.)

### Shooting Range

Shooting Mode	Focusing Range	Maximum Wide Angle (☹☹☹)	Maximum Telephoto (☹☹☹)
<b>AUTO</b>	—	20 cm (7.9 in.) – infinity	85 cm (2.8 ft.) – infinity
	—	1 m (3.3 ft.) – infinity	1.3 m (4.3 ft.) – infinity
	—	1 m (3.3 ft.) – infinity	1.3 m (4.3 ft.) – infinity
Other modes		40 cm (1.3 ft.) – infinity	1.3 m (4.3 ft.) – infinity
	*	20 cm (7.9 in.) – 70 cm (2.3 ft.)	85 cm – 1.6 m (2.8 - 5.2 ft.)
	<b>MF</b> *	20 cm (7.9 in.) – infinity	85 cm (2.8 ft.) – infinity

\* Not available in some shooting modes.

### Continuous Shooting Speed

Shooting Mode	Continuous Shooting Mode	Speed
*	—	Approx. 4.5 shots/sec.
<b>P</b>		Approx. 1.9 shots/sec.
		Approx. 0.7 shots/sec.
		Approx. 0.7 shots/sec.

\* Up to 6 continuous shots at one time.

### Shutter Speed

<b>AUTO</b> mode, automatically set range	1 – 1/4000 sec.
Range in all shooting modes	60 – 1/4000 sec.
<b>TV</b> mode available values (sec.)	60, 50, 40, 30, 25, 20, 15, 13, 10, 8, 6, 5, 4, 3.2, 2.5, 2, 1.6, 1.3, 1, 0.8, 0.6, 0.5, 0.4, 0.3, 1/4, 1/5, 1/6, 1/8, 1/10, 1/13, 1/15, 1/20, 1/25, 1/30, 1/40, 1/50, 1/60, 1/80, 1/100, 1/125, 1/160, 1/200, 1/250, 1/320, 1/400, 1/500, 1/640, 1/800, 1/1000, 1/1250, 1/1600, 1/2000, 1/2500, 1/3200, 1/4000



## ▼ Aperture

f/number	f/2.8 – f/16 (W), f/5.8 – f/16 (T)
<b>Av</b> mode available values*	f/2.8, f/3.2, f/3.5, f/4.0, f/4.5, f/5.0, f/5.6, f/5.8, f/6.3, f/7.1, f/8.0, f/9.0, f/10, f/11, f/13, f/14, f/16

\* Not all aperture values are available at all zoom positions.

## ▼ Battery Pack NB-10L

Type	Rechargeable lithium-ion battery
Nominal Voltage	7.4 V DC
Nominal Capacity	920 mAh
Charging Cycles	Approx. 300
Operating Temperature	0 – 40 °C (32 – 104 °F)
Dimensions	32.5 x 45.4 x 15.1 mm (1.28 x 1.79 x 0.59 in.)
Weight	Approx. 41 g (Approx. 1.45 oz.)

## ▼ Battery Charger CB-2LC/CB-2LCE

Rated Input	100 – 240 V AC (50/60 Hz) 16 VA (100 V) – 22 VA (240 V), 0.18 A (100 V) – 0.12 A (240 V)
Rated Output	8.4 V DC, 0.7 A
Charging Time	Approx. 1 hour 50 min. (when using NB-10L)
Charge Indicator	Charging: orange / Fully charged: green
Operating Temperature	5 – 40 °C (41 – 104 °F)
Dimensions	92.8 x 63.0 x 27.0 mm (3.65 x 2.48 x 1.06 in.)
Weight	Approx. 80 g (Approx. 2.82 oz.) (CB-2LC) Approx. 74 g (Approx. 2.61 oz.) (CB-2LCE, excluding power cord)

## ▼ Filter Adapter FA-DC58C (Sold Separately)

Max. Diameter x Length	φ60.0 x 6.3 mm (φ2.36 x 0.25 in.)
Weight	Approx. 4.0 g (Approx. 0.14 oz.)

## ▼ Bracket BKT-DC1 (Sold Separately)

Dimensions (Max.)	220.0 x 32.0 x 19.0 mm (8.66 x 1.26 x 0.75 in.)
Weight	Approx. 90 g (Approx. 3.2 oz.)

### ▼ Lens Hood LH-DC70 (Sold Separately)

Max. Diameter x Length	60.0 x 27.9 mm ( $\phi$ 2.36 x 1.10 in.)
Weight	Approx. 8.0 g (Approx. 0.28 oz.)

### ▼ Macrolite Adapter MLA-DC1 (Sold Separately)

Max. Diameter x Length	$\phi$ 65.3 x 49.5 mm ( $\phi$ 2.57 x 1.95 in.)
Weight	Approx. 30 g (Approx. 1.06 oz.)

- All data is based on tests by Canon.
- Camera specifications or appearance are subject to change without notice.

## Trademark Acknowledgments

- The SDXC logo is a trademark of SD-3C, LLC.
- This device incorporates exFAT technology licensed from Microsoft.
- HDMI, the HDMI logo and High-Definition Multimedia Interface are trademarks or registered trademarks of HDMI Licensing LLC.
- The iFrame logo and the iFrame symbol are trademarks of Apple INC.

## About MPEG-4 Licensing

This product is licensed under AT&T patents for the MPEG-4 standard and may be used for encoding MPEG-4 compliant video and/or decoding MPEG-4 compliant video that was encoded only (1) for a personal and non-commercial purpose or (2) by a video provider licensed under the AT&T patents to provide MPEG-4 compliant video.

No license is granted or implied for any other use for MPEG-4 standard.

\* Notice displayed in English as required.

## Camera User Guide Errata (contained on the Solution Disk)

- p. 98

(Wrong) With  $\frac{1}{200}$  and  $\frac{1}{400}$ , the ISO speed will be restored to  $\frac{ISO}{1600}$  if you attempt to set a speed higher than .

(Correction) With  $\frac{1}{200}$  and  $\frac{1}{400}$ , the ISO speed will be restored to  $\frac{ISO}{1600}$  if you attempt to set a speed higher than  $\frac{ISO}{1600}$ .

### **FCC Notice**

(Digital Camera, Model PC1674 systems)

This device complies with Part 15 of the FCC Rules. Operation is subject to the following two conditions;

- (1) this device may not cause harmful interference, and
- (2) this device must accept any interference received, including interference that may cause undesired operation.

Note: This equipment has been tested and found to comply with the limits for Class B digital devices, pursuant to Part 15 of the FCC rules. These limits are designed to provide reasonable protection against harmful interference in a residential installation. This equipment generates, uses and can radiate radio frequency energy and, if not installed and used in accordance with the instructions, may cause harmful interference to radio communications. However, there is no guarantee that interference will not occur in a particular installation. If this equipment does cause harmful interference to radio or television reception, which can be determined by turning the equipment off and on, the user is encouraged to try to correct the interference by one or more of the following measures:

- Reorient or relocate the receiving antenna.
- Increase the separation between the equipment and receiver.
- Connect the equipment into an outlet on a circuit different from that to which the receiver is connected.
- Consult the dealer or an experienced radio/TV technician for help.

The cable with the ferrite core provided with the digital camera must be used with this equipment in order to comply with Class B limits in Subpart B of Part 15 of the FCC rules.

Do not make any changes or modifications to the equipment unless otherwise specified in the manual. If such changes or modifications should be made, you could be required to stop operation of the equipment.

Canon U.S.A., Inc.

One Canon Plaza, Lake Success, NY 11042, U.S.A.

Tel No. (516) 328-5600

## **Canadian Radio Interference Regulations**

This Class B digital apparatus complies with Canadian ICES-003.

To ensure proper operation of this product, use of genuine Canon accessories is recommended.



### **USA and Canada only:**

The Lithium ion/polymer battery that powers the product is recyclable.

Please call 1-800-8-BATTERY for information on how to recycle this battery.

## **Battery Charger CB-2LC**

**IMPORTANT SAFETY INSTRUCTIONS-SAVE THESE INSTRUCTIONS.**

**DANGER-TO REDUCE THE RISK OF FIRE OR ELECTRIC SHOCK, CAREFULLY FOLLOW THESE INSTRUCTIONS.**

For connection to a supply not in the U.S.A., use an attachment plug adapter of the proper configuration for the power outlet, if needed.

### **Disclaimer**

- Reprinting, transmitting, or storing in a retrieval system any part of this guide without the permission of Canon is prohibited.
- Canon reserves the right to change the contents of this guide at any time without prior notice.
- Illustrations and screenshots in this guide may differ slightly from the actual equipment.
- The above items notwithstanding, Canon accepts no liability for damages due to mistaken operation of the products.

## **Battery Charger CB-2LCE**

The adapter can be used with a power supply between 100 and 240 V AC. Contact your Canon dealer for information about plug adapter for overseas use.

For U.S.A. customers only: For areas where 120 V AC power is not used, you will need a special plug adapter.

For only United States

Use a UL listed, 1.8-3m(6-10ft), Type SPT-2 or NTSPT-2, AWG no.18 power supply cord, rated for 125V 7A, with a non-polarized NEMA 1-15P plug rated for 125V 15A.

### **For CA, USA only**

Included lithium battery contains Perchlorate Material - special handling may apply.

See [www.dtsc.ca.gov/hazardouswaste/perchlorate/](http://www.dtsc.ca.gov/hazardouswaste/perchlorate/) for details.