

# TRP-C37

## User's Manual

### Ethernet to RS232/422/485 Converter



Printed Oct. 2010 Rev 1.0

**Trycom Technology Co., Ltd**  
1F, No.2-11, Sihu street, Yingge Township, Taipei, Taiwan ROC  
Tel: 886-2-86781191, Fax: 886-2-86781172  
Web: [www.trycom.com.tw](http://www.trycom.com.tw)

#### Copyright

Copyright Notice: The information in this manual is subject to change without prior notice in order to improve reliability, design and function and does not represent a commitment on the part of the manufacturer. No part of this manual may be reproduced, copied, or transmitted in any form without the prior written permission of manufacturer. Acknowledgment Products mentioned in this manual are mentioned for identification purpose only. Products names appearing in this manual may or may not be registered trademarks or copyright of their respective companies.

# 1. Introduction

TRP-C37 is suitable industrial environment Ethernet serial server, wide range power input and serial communicate protection, Built-in surge, over current ,over voltage ensure long distance serial quality , the RS485 interface built-in hardware decoder ensure RS485 data without lost, Specify hardware can keep on line RS485 device working fine; Increase external watchdog function will auto reset when Ethernet serial server or power fail, if careless lost password or IP that can easy to back to factory by external switch.

The TRP-C37 operates in “Direct IP Mode”, “Virtual COM Mode”, and “Paired Mode”. It has one synchronous DB-9 serial port for RS232 connection and screw terminal block for RS422/485 and power connection. The Ethernet port support Auto-MDIX and Auto-select 10/100MB. TRP-C37 also offers a Heart Beat feature to ensure a reliable communicating connection.

TRP-C37 also offers the maximum connection 16 host clients to link the one serial server that is easy to operate in Modscan32 and Modbus Poll application uses TCP mode, Virtual-COM mode and Pair Mode.

The TRP-C37 provides a watchdog timer function, The Watchdog timer allows the system to automatically recover from a system crash. When the TRP-C37M MCU stop working correctly, the watchdog timer waits for a preset period of time, and the performs a hardware reset. When TRP-C37M working at industrial environment, if the voltage is unstable, The TRP-C37M built-in power detection circuit can prevent the power fail cause of the system boot fail.

## 1-1 Features

- Wide input range DC power supply.
- External watchdog function prevents system or power fail.
- Support Auto-MDIX twisted pair crossover detection and Auto-Correction.
- Maximum Connection 16 Client PC at Server Mode.
- Auto fast Bi-direction RS485 hardware .
- Surge protection and over current and over voltage on RS-422/485 data lines.
- Support baud rate from1200~921600Kbps.
- Auto switching RS-232/422/485 signal interface
- Virtual COM drivers for Windows 98/WIN2000/WIN XP/Vista/WIN2003/WIN 7.
- Virtual Com Support Server, Client, UDP mode.
- Fully compatible with Ethernet and TCP/IP protocol.
- Supports 10/100 Mbps Ethernet.
- Power/Link/RX/TX mode LED indicator.
- Heart Beat function ensures a reliable communicating connection.
- Auto Pair-mode when power or Ethernet fails.

- Back to factory by external switch.
- Update the firmware from Ethernet.
- Dual power input select from screw terminal or DC-jack.

## 1-2 Specification.

- Power Input Voltage: DC +10V to +30V.
- LAN: Auto-MDIX, 10/100 Mbps Auto-detecting.
- RS-232: TX, RX, RTS, CTS, DTR, DSR, DCD, GND.
- RS485 signal: differential 2 half-duplex wires (DATA+, DATA-).
- RS422 signal: differential 4 full-duplex wires.(TX+,RX+,TX-,RX-)
- Data Rate: 1200,2400,4800,9600,19200,38400,57600,115200,921600 K bps .
- Parity: none, even, odd.
- Data Bits: 5, 6, 7 or 8.
- Stop Bits: 1, 1.5 or 2.
- Protocol: TCP, IP, ARP, DHCP, Telnet, HTTP, UDP, ICMP
- External switch:       OFF   OFF :TCP and VSP mode.  
                                  ON    OFF : Option .  
                                  OFF  ON  :Option.  
                                  ON    ON  :Back to Factory.
- Virtual-Com mode support RS232 TXD,RXD,GND.  
                                  RS422 TX+,TX-,RX+,RX-.  
                                  RS485 DATA+,DATA-.
- Power supply: Screw terminal or DC jack .
- Serial interface: +/-15 KV ESD.
- RS422/485 interface: Surge, over current, over voltage protection.
- Power consumption: 12V/140mA.
- Operating Temperature:-10 to 65 °C.
- Humidity: 0~90% Non-Condensing.
- Dimensions: 151(L)\*75(W)\*26(H) mm.
- Weight: 395g with packing.

## 2. Hardware Description

### 2-1. Panel layout

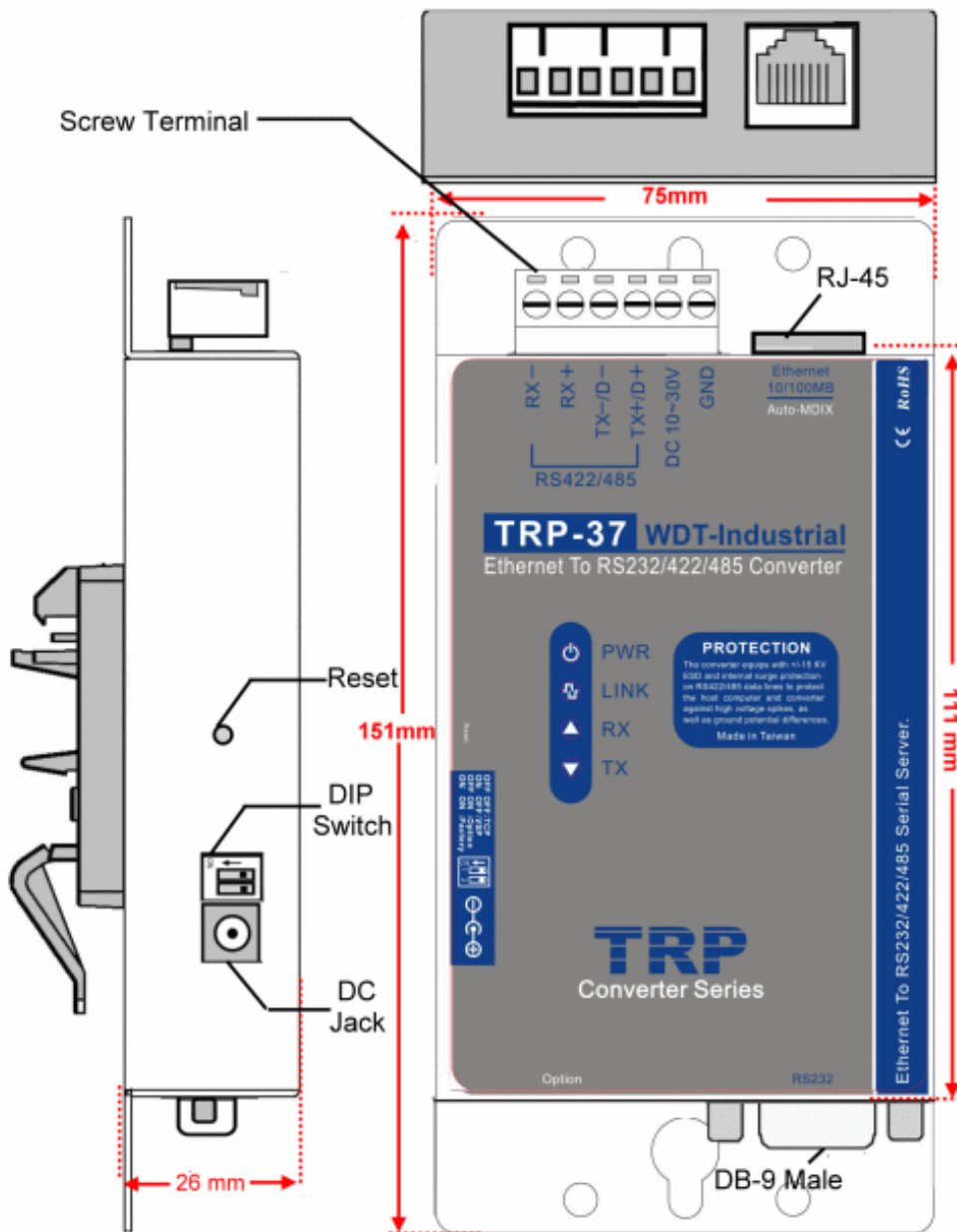

**Notice:** User can only choose either external DC-Jack or Screw terminal DC input. Do not use external DC-Jack and screw terminal DC input simultaneously.

## 2-2. LED indicator

**PWR LED:** System is ready.(Blinking)

**LINK LED:** Ethernet cable connection and data active.

**TX/RX LED:** UART Transmitting/Receiving Indicator.

**DC Jack:** Power Input DC +10V to +30V. (Please use the 5.5\*2.1mm DC JACK).

## 2-3. Reset Button

Push the reset button will Re-Boot.

## 2-4. DIP Switches

A double DIP switch allows the TRP-C37 to be placed into TCP/Option/Factory Mode.

- OFF OFF: Normal mode.
- ON OFF: Option.
- OFF ON: Option.
- ON ON: Back to factory.

## 2-5.Factory Setting

Factory Setting: **\*Adjust the external switch to ON ON will back to factory.**

The screenshot shows a 'Device Setup' window with two tabs: 'Network Setting' and 'Serial Port Setting'. The 'Network Setting' tab is selected and contains the following fields:

- Device Name: TRP-C37
- MAC Address: 00-0E-C6-00-01-AC
- DHCP: Enable (dropdown)
- Server (selected radio button):
  - Listening IP: 192.168.1.1
  - Data listening port: 502
- Client (unselected radio button):
  - Destination IP: 192.168.1.2
  - Destination Port: 4000
- Data Packet Type:
  - UDP
  - Auto connect after reboot
  - TCP
- Management Packet Type:
  - Broadcast
  - Multicast
- Netmask: 255.255.255.0
- Gateway: 192.168.1.3
- DNS: 168.95.1.1
- Transmit Timer: 10
- UART Transmit: 0
- Heart Beat: Disable (dropdown)
- Maximum Connection: 1 (dropdown)
- New Password: \*\*\*\*
- Firmware: 1026

At the bottom of the window are three buttons: 'Submit', 'Save', and 'Load'.

The screenshot shows the 'Serial Port Setting' tab in the 'Device Setup' window. It contains the following fields:

- Baud rate: 9600 (dropdown)
- Data bits: 8 (dropdown)
- Parity: None (dropdown)
- Stop bits: 1 (dropdown)
- Flow Control: None (dropdown)

## 2-6. D sub 9 Pin male Configuration

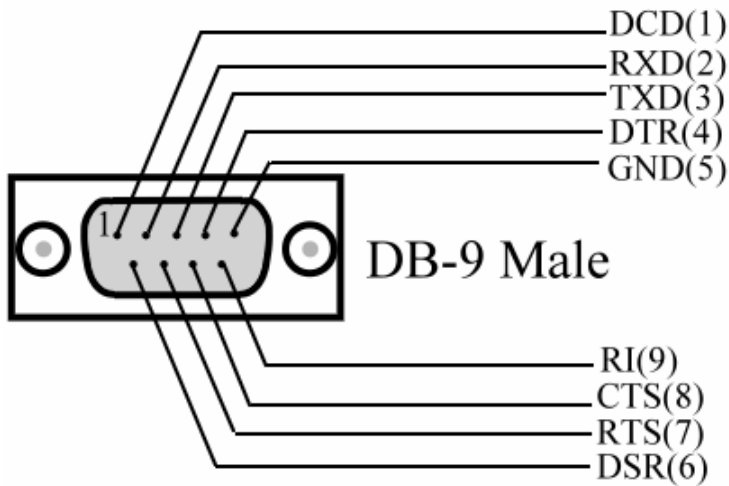

### 3. Install TRP-C37 Hardware

**STEP1:** Connect power source with TRP-C37, the PWR LED will blinking.

**STEP2:** Connect TRP-C37 with LAN port by RJ45 cable.

If the cable is properly connected the "LINK" LED will light up.

\*The TRP-C37 Support Auto-MDIX, A straight-through or crossover RJ45 cable can be used to make a connection directly to the HUB/Router/PC LAN port.

**STEP3:** Connect TRP-C37 to RS232 device by Null-Modem cable (Maximum 15M).

Connect TRP-C37 to RS422/485 by AWG #12~30 wires ( Maximum 1.2KM).

#### 3-1. RS485 Wiring

The RS-485 mode supports the Transmit and Receive channels using 2-wire half-duplex operation.

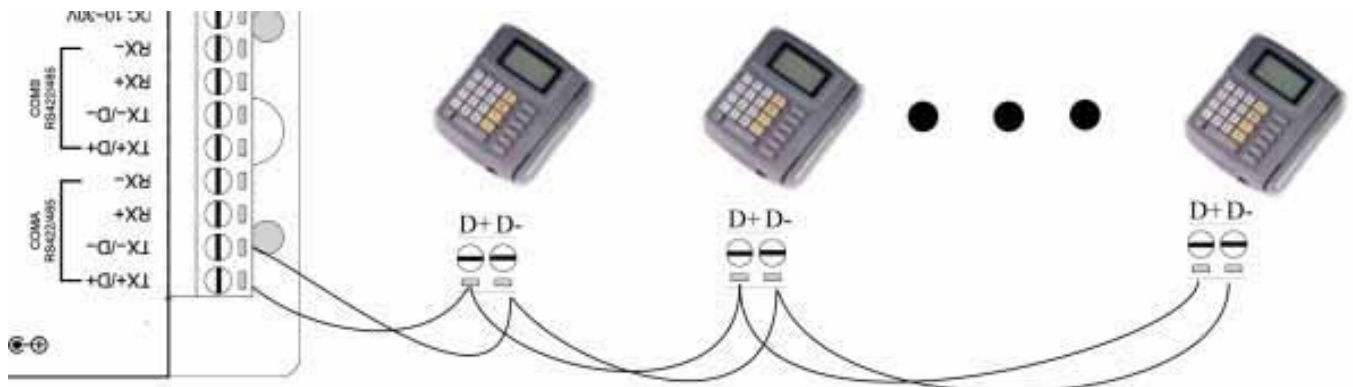

#### 3-2. RS422 Wiring

The RS-422 mode supports 4 channels with full duplex operation.

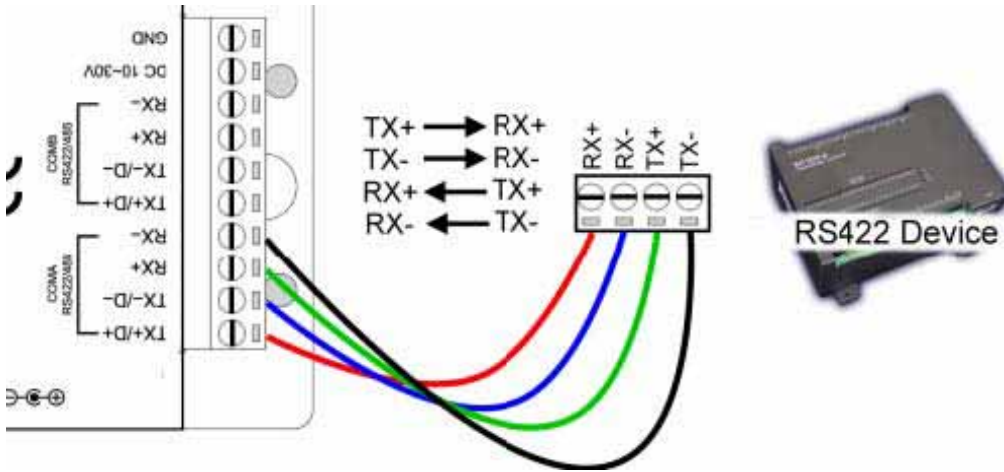

### 3-3. RS232 Wiring

Refer to the Pin out table for connections.

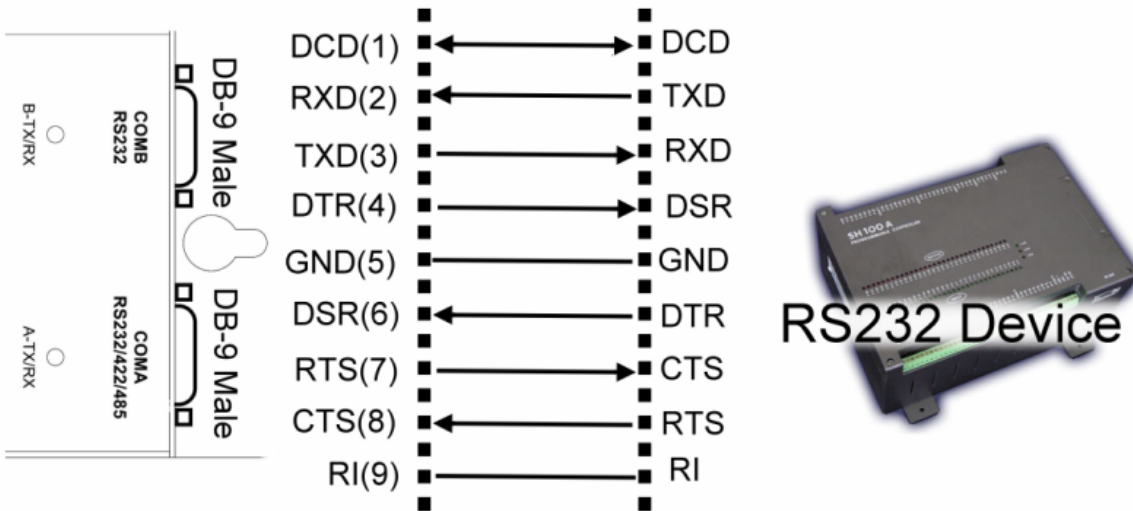

## 4. How to configure TRP-C37

There are 2 ways to access the TRP-C37.

### 4-1. TRP-C3X DSM Software.

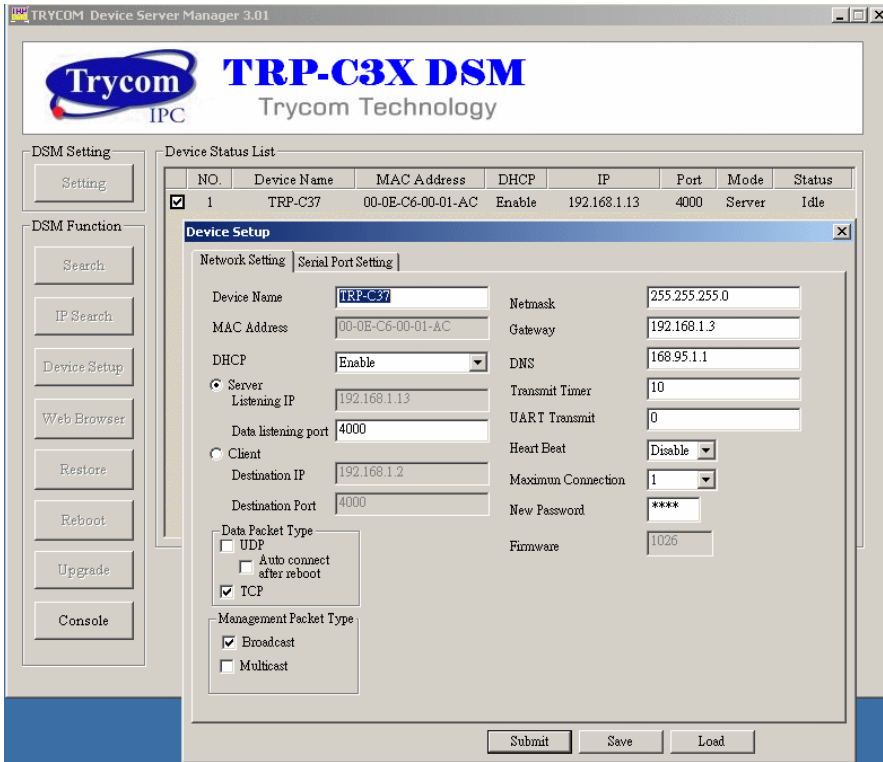

## 4-2.WEB Server

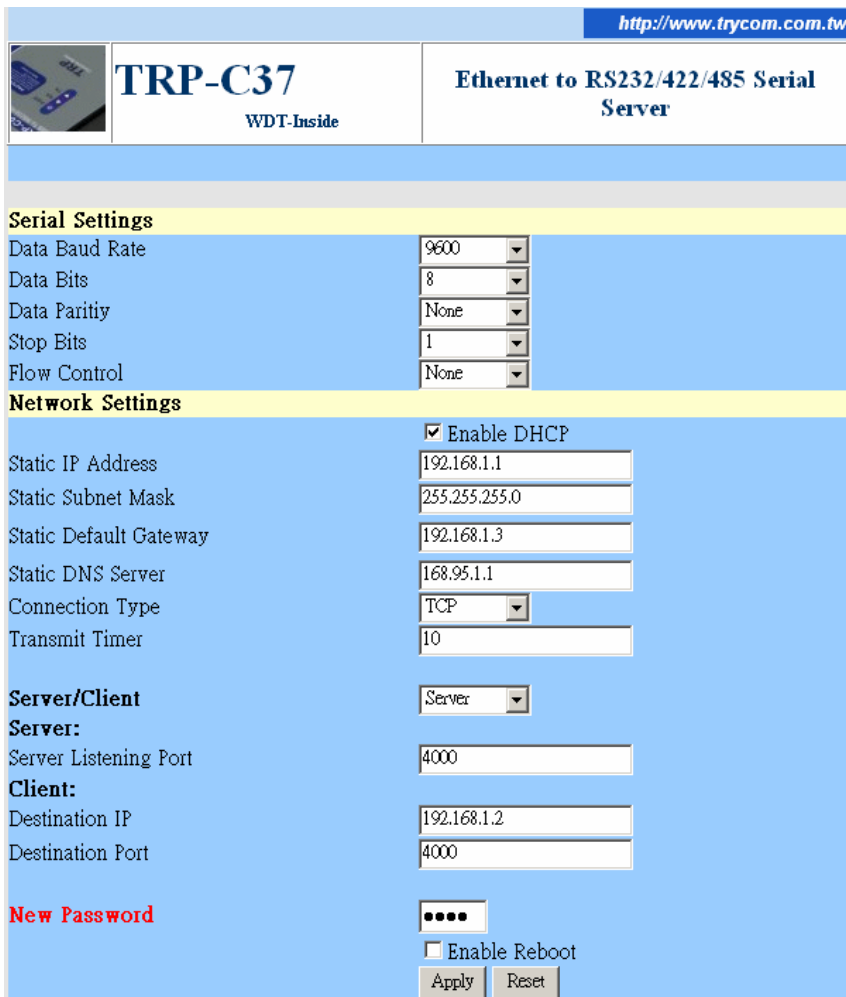

## 4-3. Using TRP-C3X DSM Utility.



The “**TRP-C3X DSM utility**” software performs several functions:

- A: Searching for TRP-C37 connected to the network.
- B: Displaying and changing the configuration of TRP-C37.
- C: Upgrading the TRP-C37 firmware.
- \*Refer the Firmware upgrade help file.
- D: Saving and Loading Configuration from external log File or EEPROM.

#### 4-4. Searching LAN for TRP-C37

Once TRP-C37 is connected to the LAN the **TRP-C3X DSM** software will search it and display it in a window by name, IP address, Mac....Information.

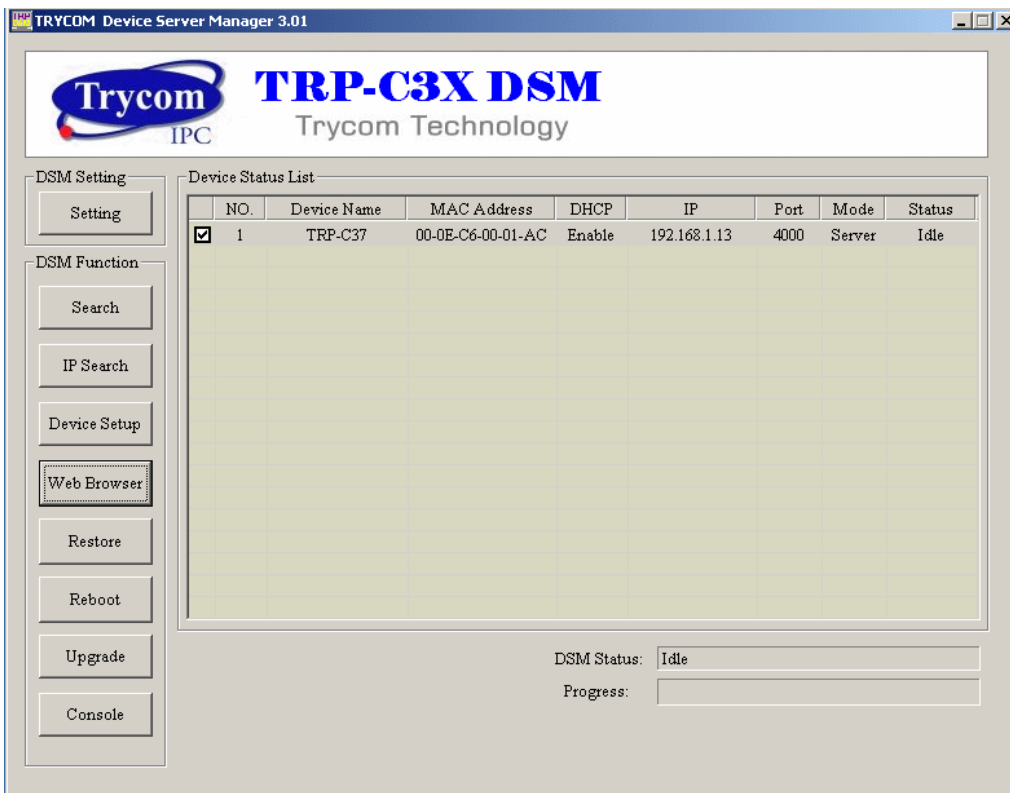

#### 4-5. Configuring Server Properties

Select the “NO.” item and Double click to open the Server configuration, after setting then click “Submit” will save the configuration to EEPROM.

The screenshot shows a 'Device Setup' window with two tabs: 'Network Setting' and 'Serial Port Setting'. The 'Network Setting' tab is selected. It contains the following fields and options:

- Device Name: TRP-C37
- MAC Address: 00-0E-C6-00-01-AC
- DHCP: Enable (dropdown)
- Server (selected radio button):
  - Listening IP: 192.168.1.13
  - Data listening port: 4000
- Client (unselected radio button):
  - Destination IP: 192.168.1.2
  - Destination Port: 4000
- Data Packet Type:
  - UDP
  - Auto connect after reboot
  - TCP
- Management Packet Type:
  - Broadcast
  - Multicast
- Netmask: 255.255.255.0
- Gateway: 192.168.1.3
- DNS: 168.95.1.1
- Transmit Timer: 10
- UART Transmit: 0
- Heart Beat: Disable (dropdown)
- Maximum Connection: 16 (dropdown)
- New Password: \*\*\*\*
- Firmware: 1026

At the bottom of the window are three buttons: 'Submit', 'Save', and 'Load'.

### Device Name

Device server name, Maximum 10 chars.

### MAC Address

The Device server MAC address.

### DHCP

If DHCP is disabled, it allows user setting the IP address, Subnet mask, Gateway.

If DHCP is enabled ,the IP address, Subnet mask, Gateway address will be dynamically configuration by DHCP server such router.

When “DHCP” is enabled ,but the DHCP server is not available on the network, the TRP-C37 will timeout then back to factory setting IP=192.168.1.1.

### Server Listening IP

The TRP-C37 IP address.

### Server Data listening port

RS232/422/485 port address.

### Client Destination IP

When user using the paired mode, the client setting need to input Server IP and PORT which one need to connect.

### Client Destination port

RS232/422/485 port address.

Port: 16 bit number. (1 ~ 65535)

### Netmask

The default LAN Netmask is configured for a Class C address. This maybe reconfigured by the user.

## **Gateway**

Input the gateway IP address that can be allows users to access the serial server from internet.

## **DNS**

Short for Domain Name System, an Internet service that translates domain names into IP addresses. Because domain names are alphabetic, they're easier to remember. The Internet however, is really based on IP addresses. Every time you use a domain name, therefore, a DNS service must translate the name into the corresponding IP address.

## **Transmit timer:0~64 mS/Unit**

Time interval to send out serial data char starting packet.

## **UART Transmit:0~15 uS/Unit**

Time interval to send out serial data char packet.

## **Hear Beat: Disable /Enable**

When Hear Beat enable, User can open a 5300 port, 5 sec interval to send out data char packet that provides a easy way to ensure the communications between Host PC Client and server devices.

## **Maximum Connection: 1~16**

The function allows the user to configure the TRP-C37 Serial Server to have up to 16 TCP client connections.

## **New Password: 1234**

It only accept value from 1000~9999 integer, if input the wrong password over 5 times, the WEB-Page will lock until the TRP-C37M re-boot.

## **Firmware Version**

Firmware Version.

## **Serial Port setting**

Baud Rate: UART Speed from 1200,2400,4800,9600,19200,38400,57600,115200,921600 k bps

Data Bit: 5,6,7,8

Parity: Odd, Even, None

Stop Bits: 1, 1.5

Flow Control: Xon/Xoff, Hardware, None

## **Submit**

Save the setting value to EEPROM.

## **Save**

Save the setting value to external log file.

## **Load**

Load the setting value to external log file.

## **Upgrade**

Upgrade the TRP-C37 firmware

*\*Wrong way the upgrade firmware will cause the TRP-C37 system fail.*

## **4-6 using the WEB Server mode**

The Web Server can be used to configure the TRP-C37 Serial Server from any web browser software (such as I.E).

In Internet Explorer type the IP Address of the Serial Server into the address field and press the **Enter** key. The following window will appear:

Example:

If TRP-C37 IP is 192.168.3.24 Please Input the 192.168.3.24 then enter at web address, the web-page will appear..... See diagram below.

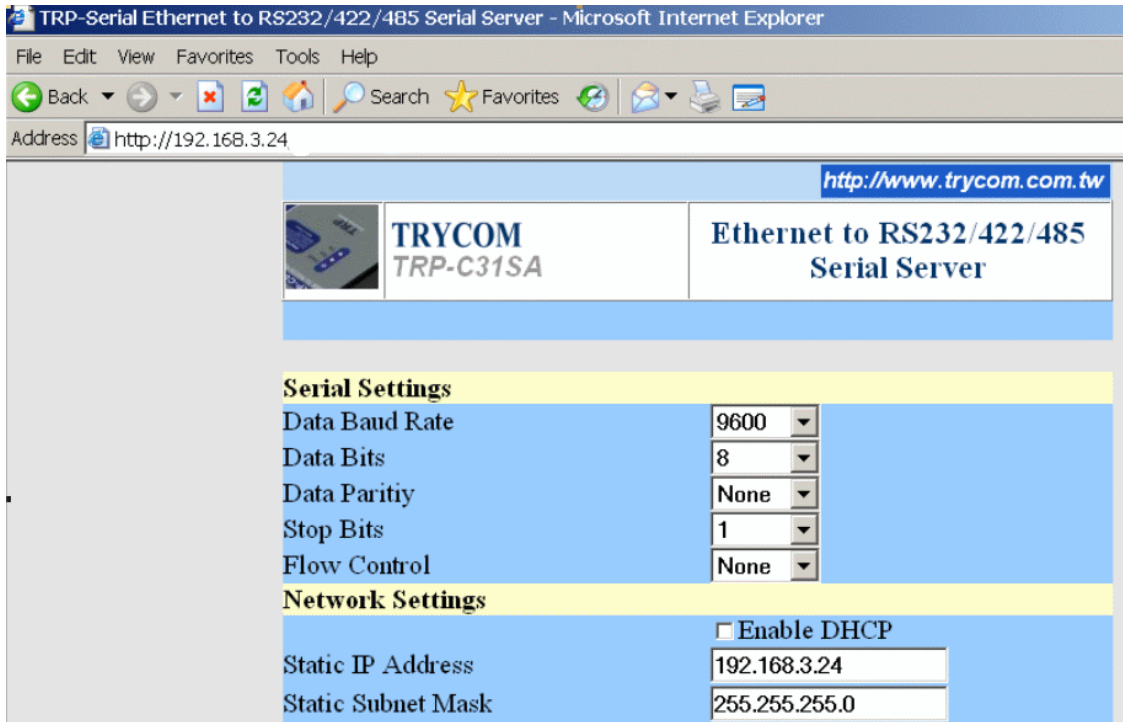

## 5. Install the Virtual-COM

The Virtual-COM utility support TCP/IP、 UDP data mapping to the HOST PC virtual-com, it can creative Maximum 512~1024 virtual-com port, Support Server、 Client、 UDP mode, Support all Windows O.S include Win98/Win2000/WinXP/Vista/Win2003/WIN7,Support Multi-virtual com at different PC to one serial server; Support Ethernet and Internet , If TRP-C37 off line or power fail, The Virtual-Com utility will try to Reconnection.

**Step 1.** Adjust the switch to “OFF, OFF”... The switch position at Normal-mode.

**Step 2.** Insert the TRP-Serial CD and find the TRP-C37 folder.

**Step 3.**Click “Vcomm.exe” icon then install Virtual-COM utility.

\*The Virtual COM utility support multi-language, please select which language do you need.

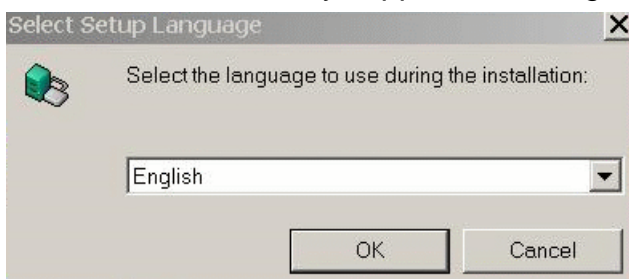

Step4. Click “OK” button and select “VSP run as Client support Server Device”.

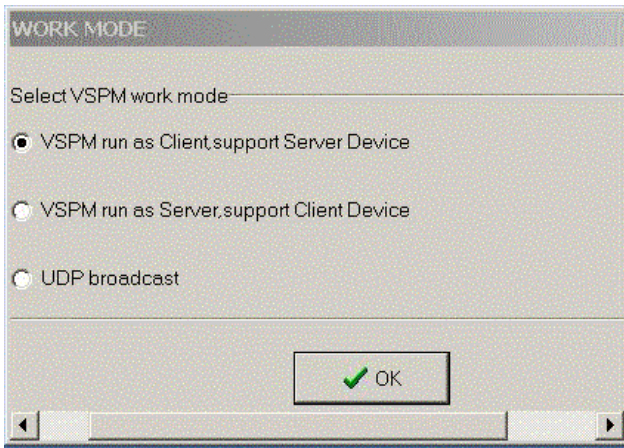

Step5. Select “Create virtual serial by device scanner”, then press “OK”

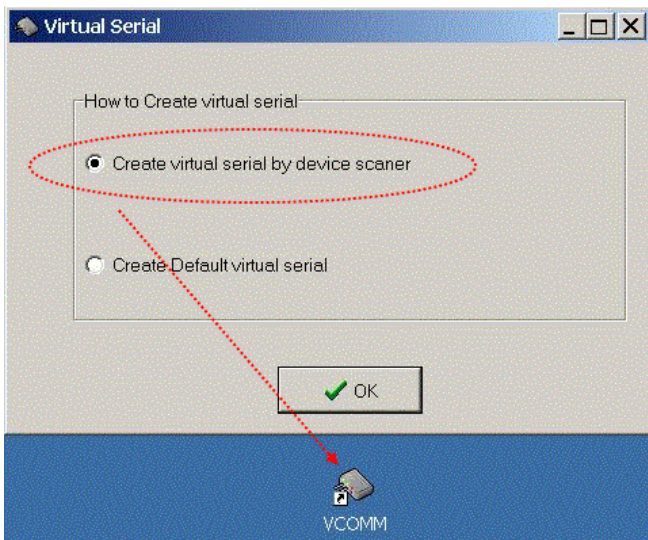

Step6. Run VCOMM.exe then click right button select “New Virtual COM”

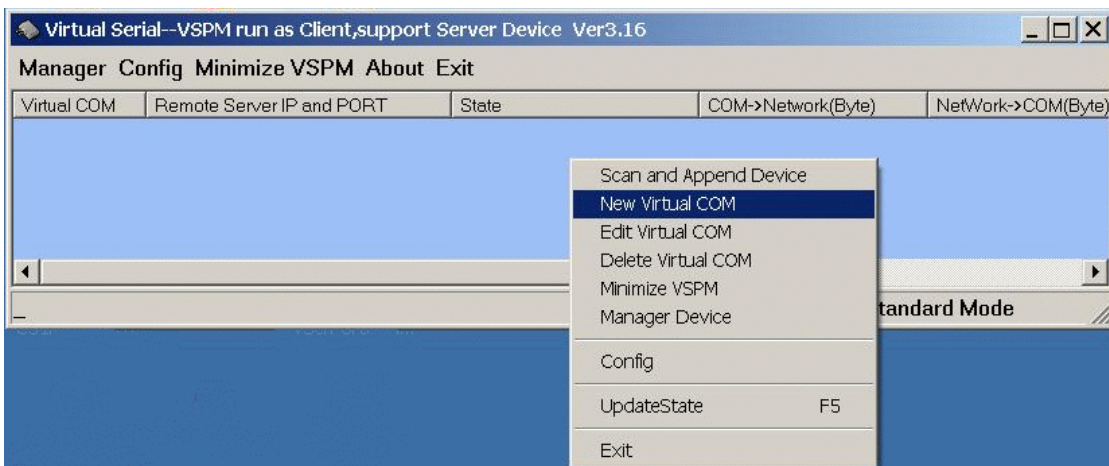

Step7. Select “Select Serial Port” and input TRP-C37 IP and port then press “OK”.

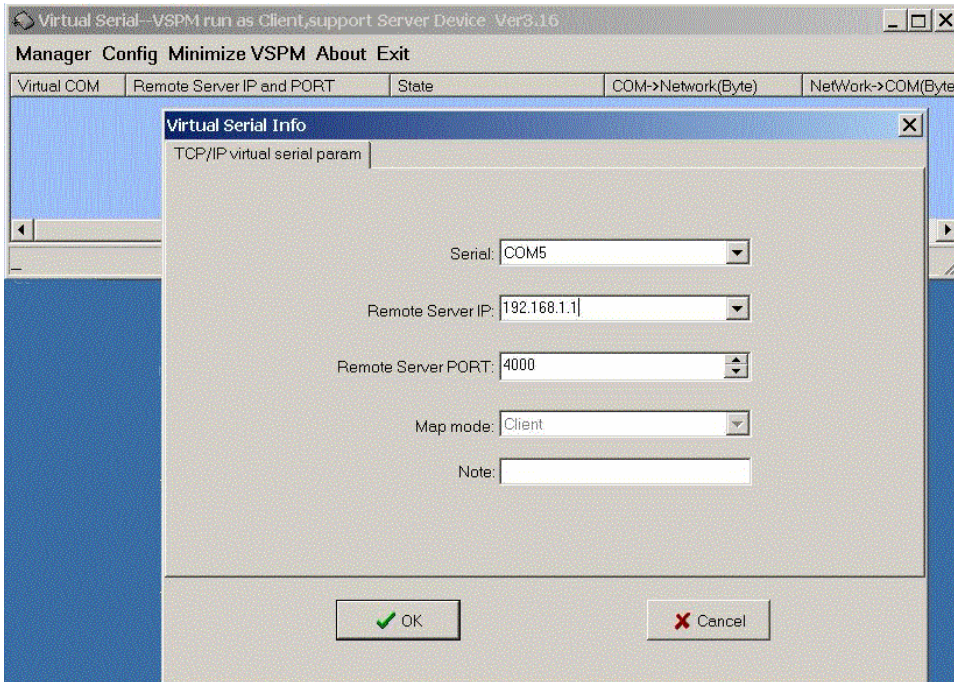

**Step8.** If Virtual-Com setting success, the display will appear bellow.

**Step9.** Run TRPCOM utility then select virtual-com port make a TRP-C37 loop test.

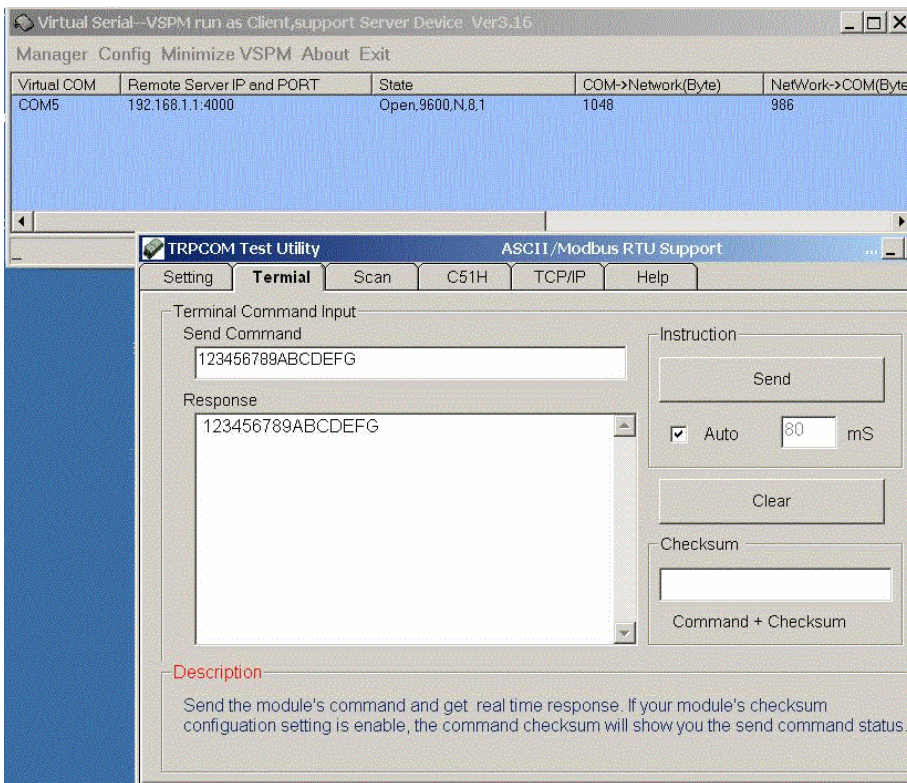

\*If in VCOMM's configuration select "Boot with windows", the virtual-com will Auto-connection when windows start.

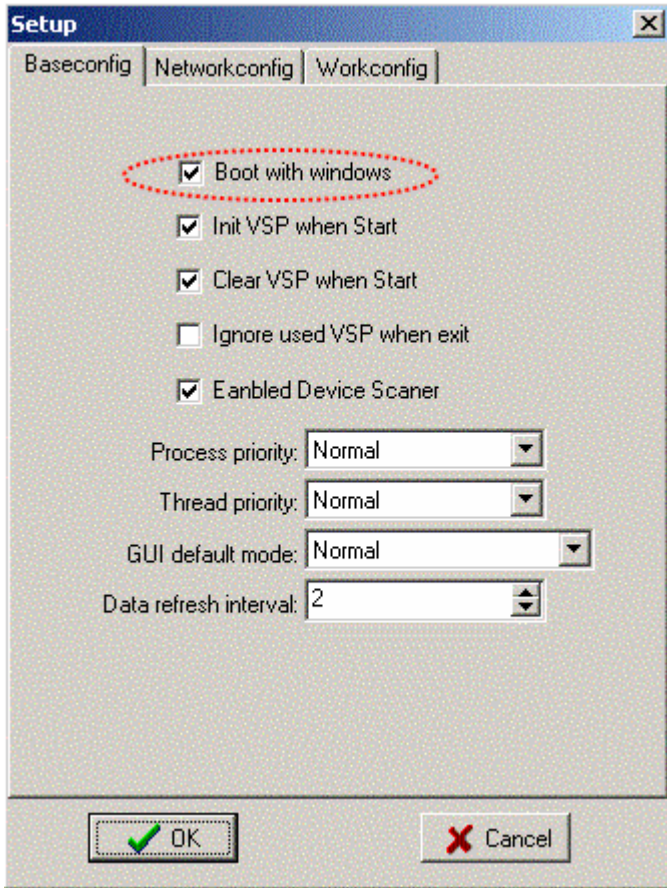

## 6. Application

### 6-1 Direct IP Mode

*\*Keep DIP switch to the OFF, OFF Position.*

#### key-in IP & Port



#### Direct IP Mode



#### Example:

Step1: Connect PC-----Ethernet-----TRP-C37M-----RS485---TRP-C28 (RS485 ID=01)

Step2.Run TRPCOM utility and input IP/Port, click “Link” button, then Send Command , The Response will appear TRP-C28 I/O Status.

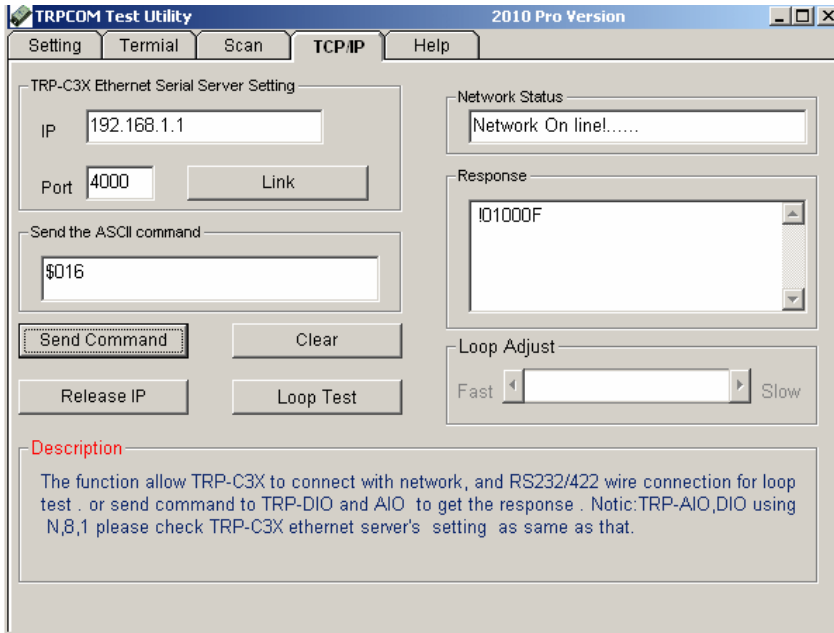

Step3. Send Command “#010003”, The Response will enable TRP-C28 Relay1 and Relay2 enable.

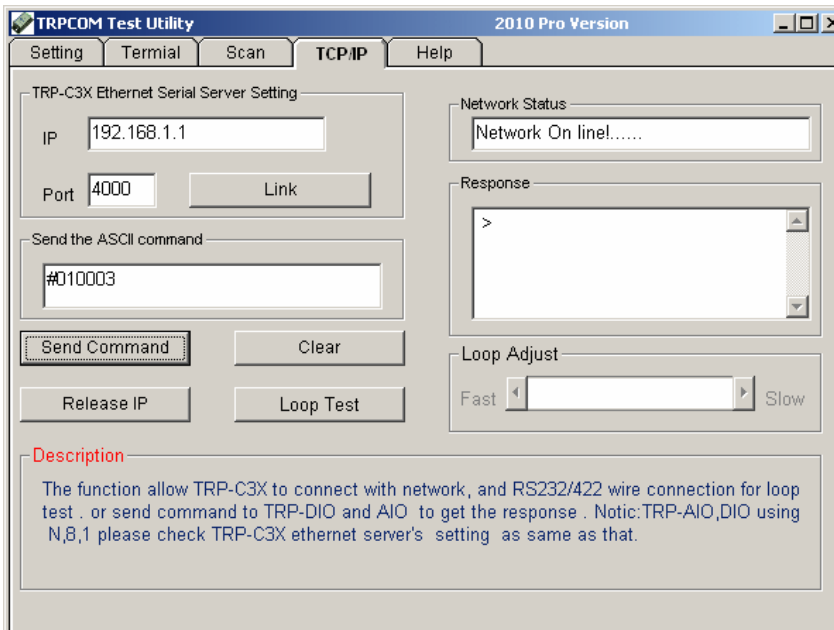

## 6-2 Virtual COM Mode

**\*Keep DIP switch to the OFF, OFF Position.**

### Select Virtual-Com Port Number

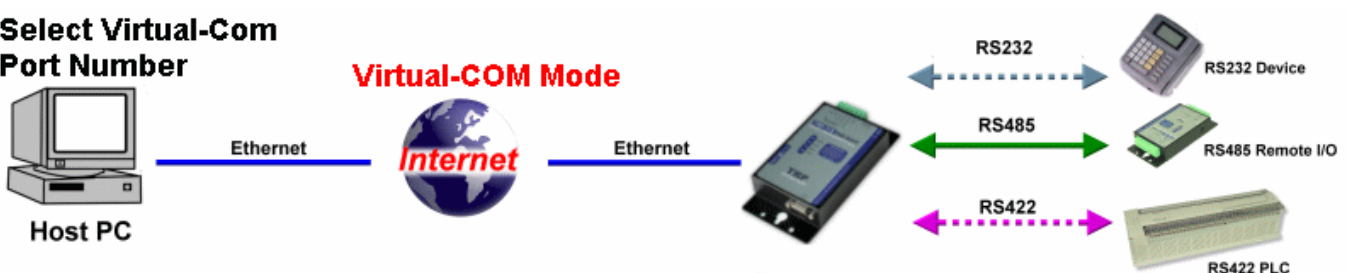

### Example:

Step1. Connect PC-----Ethernet-----TRP-C37-----RS485---TRP-C28 (RS485 ID=01).



Step2. Run Virtual-COM utility and make a virtual-COM port, Run TRPCOM utility and input com port number, press “OK”.

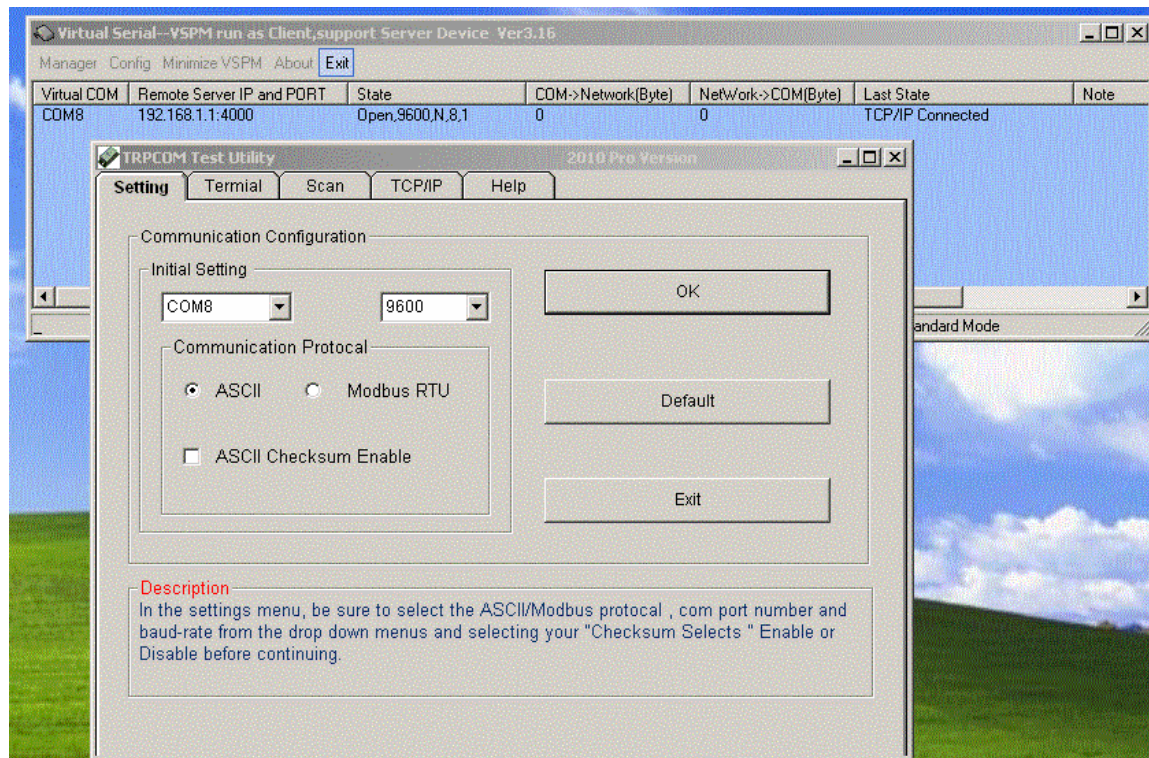

Step3.Select “Terminal” and send command, the response will appear TRP-C28 channel 2 counter value.

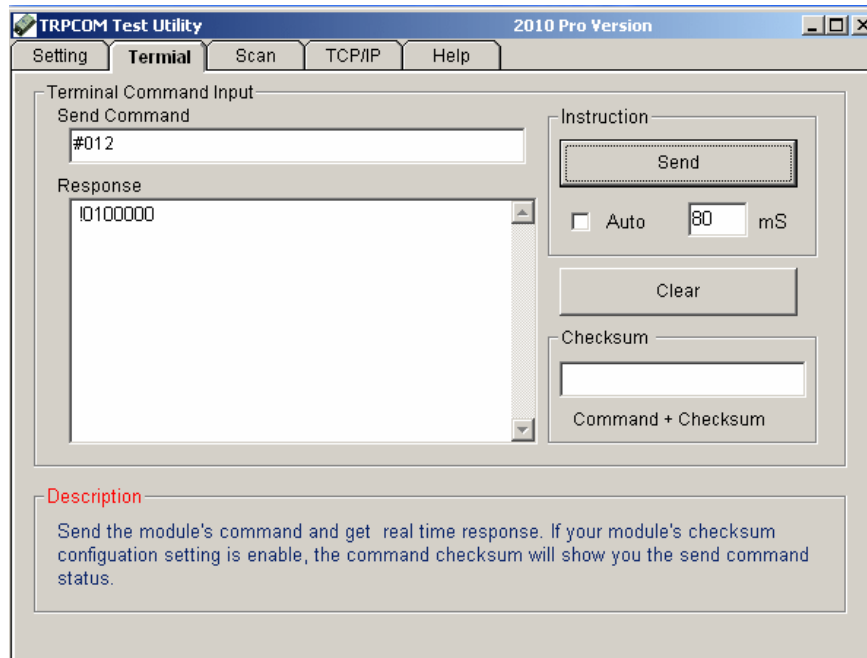

### 6-3 Paired Mode

***\*Keep DIP switch to the OFF, OFF Position.***

## Paired Mode

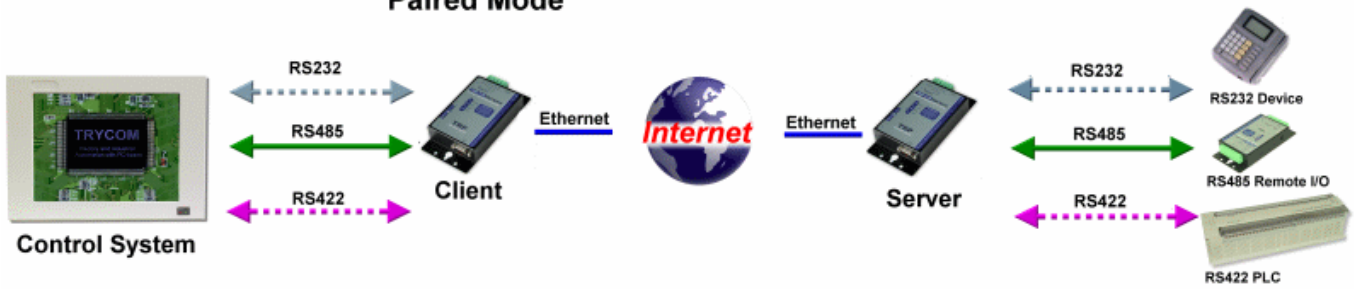

### Example:

Step1. Connect PC---RS232---TRP-C37-----Ethernet-----TRP-C37----RS422 (loop back TX+→RX+,TX-→RX-).

Step2.Run DSM set up **TRP-C37 Client**, Input destination IP and Port.

The screenshot shows the 'Device Setup' window with the 'Serial Port Setting' tab selected. The 'Client' radio button is chosen. The 'Destination IP' is set to 192.168.1.2 and the 'Destination Port' is set to 4000. The 'Data Packet Type' section has 'TCP' checked. Other settings include Device Name: TRP-C31SA, Netmask: 255.255.255.0, Gateway: 192.168.1.3, DNS: 168.95.1.1, Transmit Timer: 10, UART Transmit: 5, Heart Beat: Disable, Maximum Connection: 8, New Password: \*\*\*\*, and Firmware: 9019. The 'Management Packet Type' section has 'Broadcast' checked.

Step3.Run DSM set up **TRP-C37 Server** and be sure the IP and port as same as client setting.

The screenshot shows the 'Device Setup' window with the 'Serial Port Setting' tab selected. The 'Server' radio button is chosen. The 'Listening IP' is set to 192.168.1.2 and the 'Data listening port' is set to 4000. The 'Data Packet Type' section has 'TCP' checked. Other settings are identical to the client setup: Device Name: TRP-C31SA, Netmask: 255.255.255.0, Gateway: 192.168.1.3, DNS: 168.95.1.1, Transmit Timer: 10, UART Transmit: 5, Heart Beat: Disable, Maximum Connection: 8, New Password: \*\*\*\*, and Firmware: 9019. The 'Management Packet Type' section has 'Broadcast' checked.

Step4. Run the windows utility "hyper Terminal" and select com port number, and press "OK".

Step5. Key-in some chars the hyper terminal will show loop back.

**\*Try to disconnect power or RJ45 cable, the TRP-C37 will Auto Re-connection.**

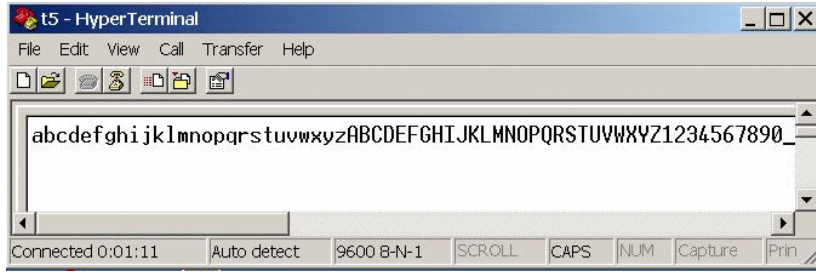

### 6-4 Multi-Client to 1 TRP-C37 Server

**\*Keep DIP switch to the OFF, OFF Position.**

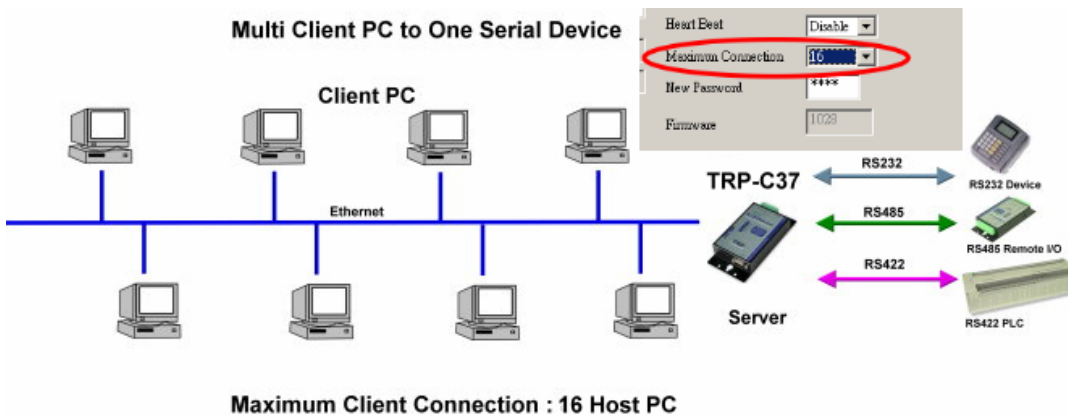

**Example:**

**\*Running at Multi-Direct IP Mode**

Step1. Connect Multi-PC ---Ethernet----TRP-C37 Server----TRP-C28 (RS485 ID=1)

Step2. Run DSM Set up **TRP-C37** Maximum connection=8.

Step3. All host PC run TRPCOM and input IP, Port, click “Link” button, then Send Command, The Response will appear TRP-C28 I/O Status.

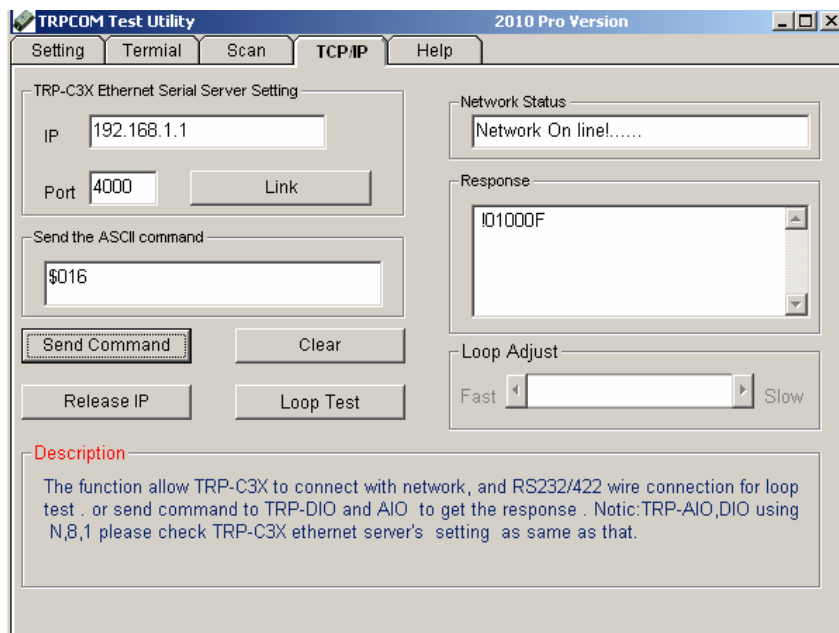

### **\*Running at Multi-Virtual COM Mode**

Step1. All PC run Virtual com utility and make a self virtual-COM port, Run TRPCOM utility and select com port number, and press "OK".

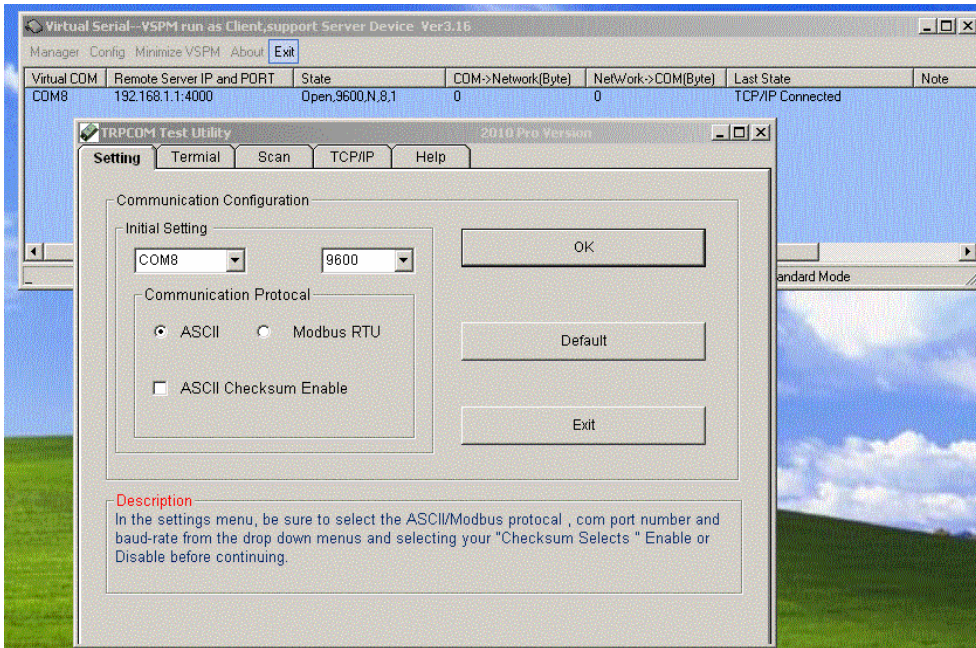

Step3.Select "Terminal" and send command, the response will appear TRP-C28 channel 2 counter value.

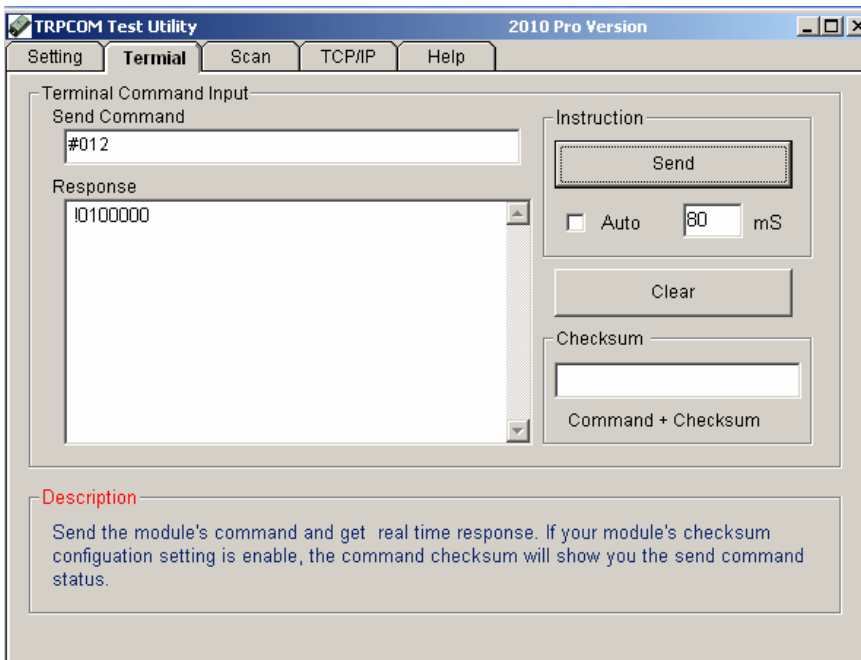

### **6-5 Heart Beat**

The heart Beat function help customer detection the TRP-C37 LAN on-line or off-line, User can open one 5300 port, if TRP-C37 on line, the 5300 port will send a char package period of 5 sec.

Step1: Run TRP-C3X DSM.exe to set up the heart beat enable.

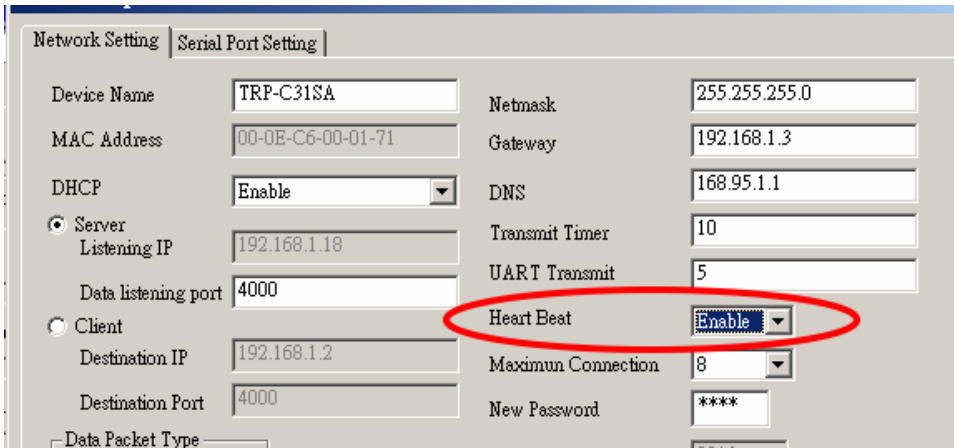

Step2: RUN TRPCOM then click “Link” button  
 Wait until the Response screen appear the message

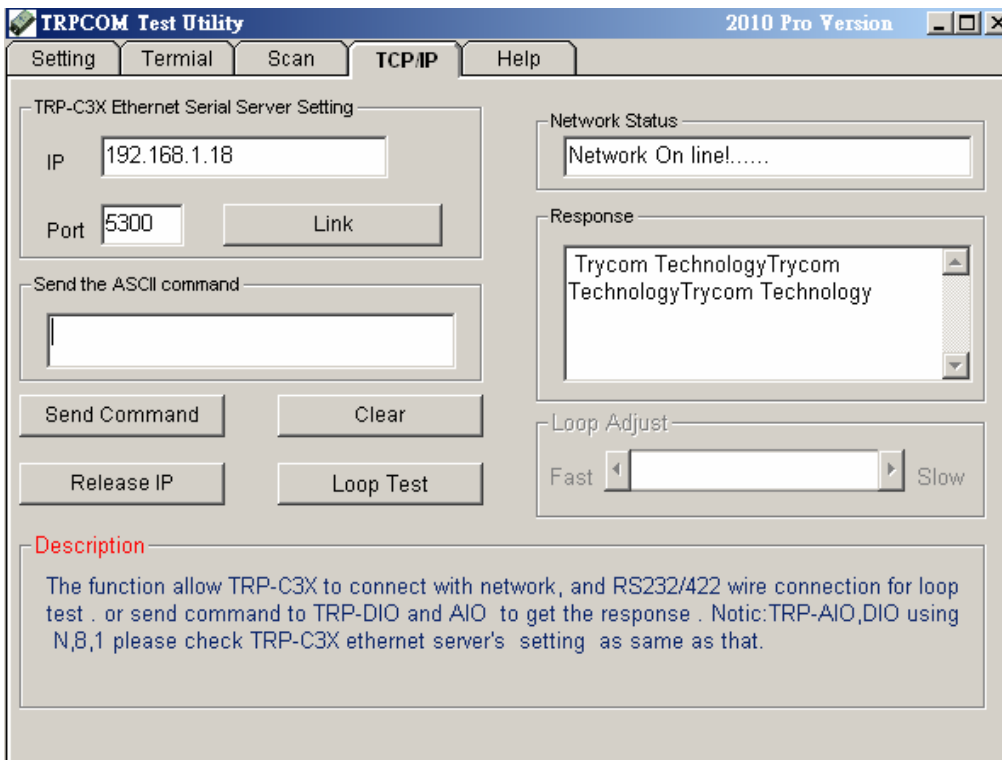

## 7. Using TRPCOM Utility test TRP-C37.

**TRP-Serial Test Utility** is demo utility which may help to test direct IP Mode .User may find the utility in the TRP-C37 support CD. Double click “TRPCOM Utility”, the installShield Wizard will guide you complete installation.

User can directly link TRP-C37 to TRP-Serial Remote IO Modules by RS485, The basic wiring connect.

### RS485 Test

DATA+ to DATA+,DATA- to DATA-

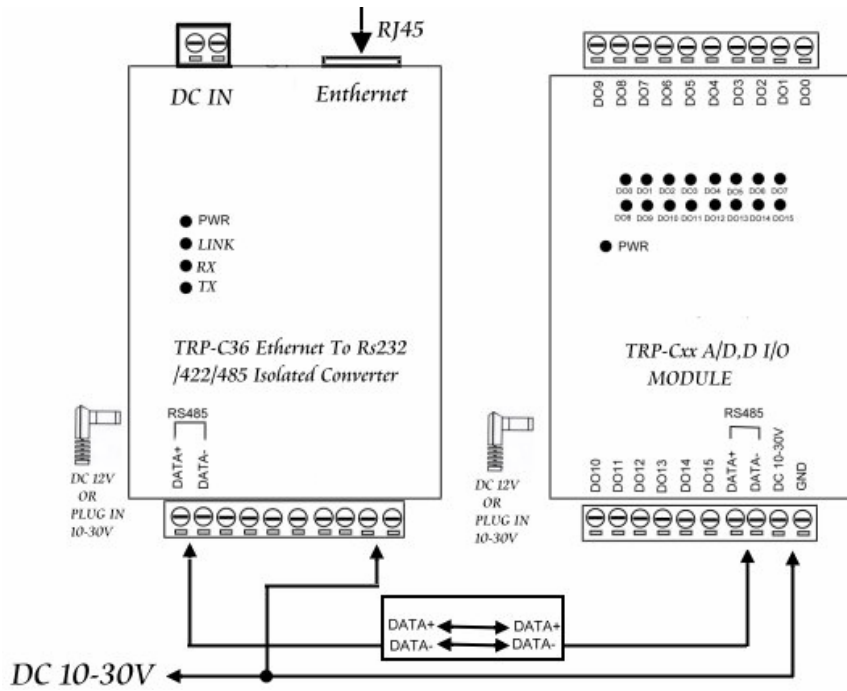

Run TRPCOM and send command "\$01M" and get response.

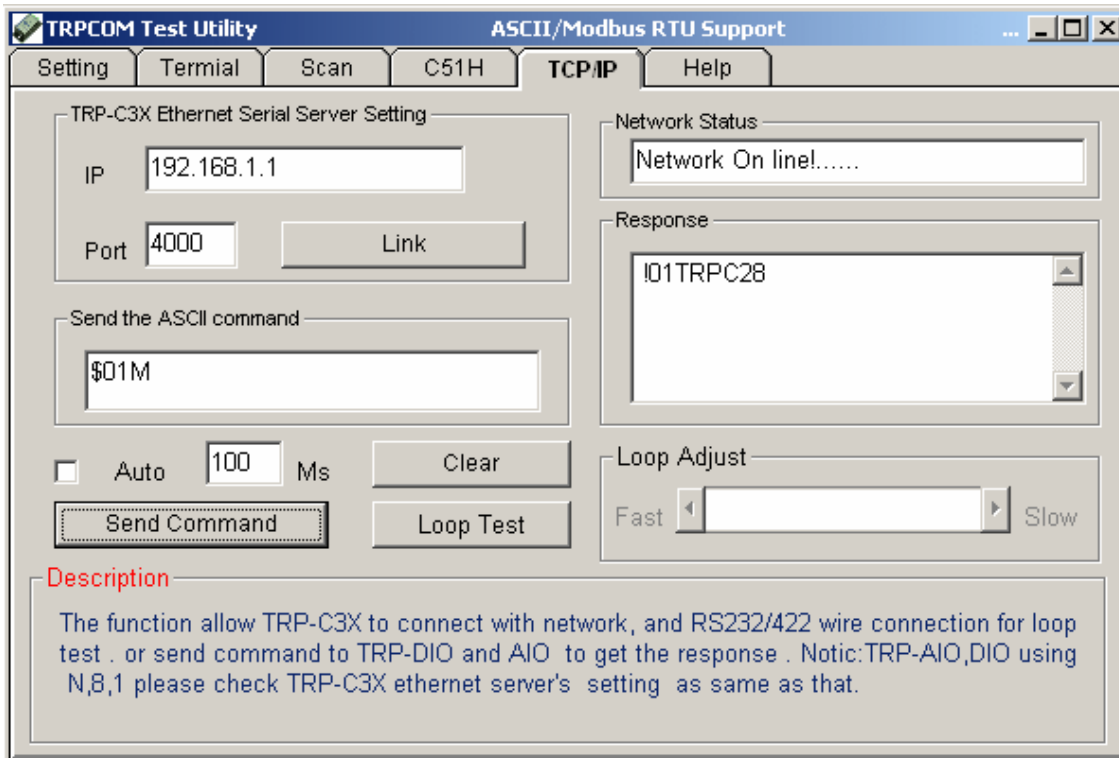

### RS422 Loop Test

Hardware wiring connection for RS422 loop test.

TX+ to RX+, TX- to RX-

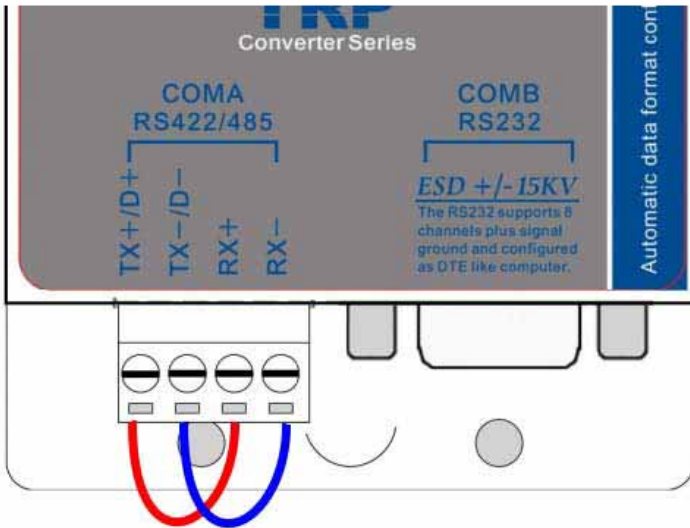

### RS232 Loop Back Test

Hardware wiring connection for RS232 Loop Test.

TXD to RXD, RTS to CTS.

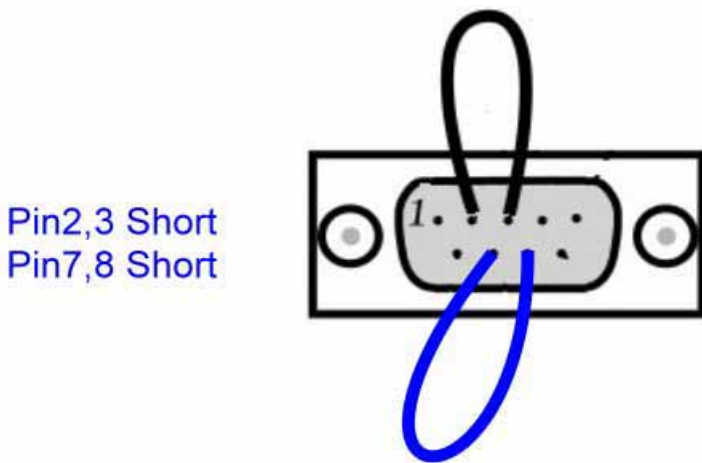

RUN TRPCOM test utility then connect correct IP and Port then click the "Loop Test" button"

