

SPECIAL FUNCTIONS DESCRIPTION

USER MANUAL COMPLEMENT
B series

Contents:

1. Basic information	3
2. Keys and indicators.....	4
3. Date and time setting (dAtE).....	5
4. Formulation function (SU \Rightarrow).....	6
5. Average calculation (SrE)	7
6. Percentage weighing (F..-Pro).....	8
7. Animal weighing (LOC).....	9
8. Maximum value (UP)	10
9. Anti-disturbance filter (FIL).....	11
10. Checkweighing (thr).....	12
11. Total weight function (totAL)	16
12. Density determination (hYdro)	18
13. Function Menu customisation (F..-ACt).....	20

1. Basic information

Beside basic measuring functions all balances are equipped with the set of special user functions.

Standard balance features the following functions:

- basic set of special functions, including:
 - pieces counting
 - autozero
 - serial port working mode setting
 - serial port parameters setting
 - constant tare
 - calibration options

On customers' request balances may be equipped with:

- additional set of special functions, including:
 - percentage weighing
 - formulation
 - animal weighing
 - maximum value
 - anti-stroke filter
- checkweighing
- paper substance determination*
- total weight function
- liquid and solids density determination

This brochure describes the functions not explained in user manual (i.e. additional functions set).

* Functions available with special balance program (with limited use of other functions).

2. Keys and indicators

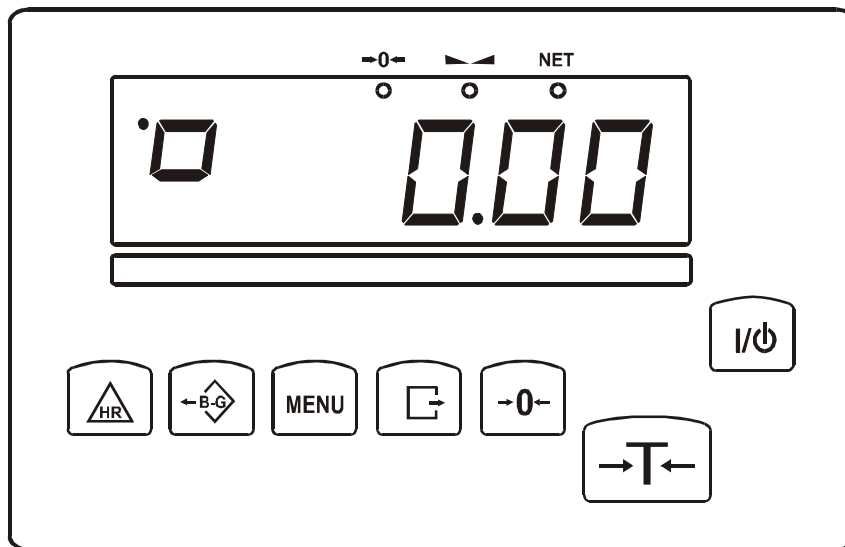

key	⏻	- switch-on / switch-off (standby),
key	HR	- increased indication resolution,
key	B/G	- gross weight indication switch,
key	MENU	- special functions menu,
key	→0←	- zero,
key	→	- print-out,
key	⏻	switch-on / switch-off (standby),
indicator	→0←	- zero indicator
indicator	—	- result stabilisation indicator
indicator	NET	- net weight indicator (indication with subtracted tare)
indicator	MODE	- special function mode indicator,
bar indicator		- total load indicator (graduated 0-100%)
indicator	OFF	- standby (switched-off with ⏻ key),
indicator	B/G	- gross weigh indicator (after pressing B/G key)
indicator	pcs	- number of pieces

To enter numeric values use the following keys:

→0← - digit increase,

→ - decimal point,

→T← - next digit,

MENU - end.

3. Date and time setting (dAtE)

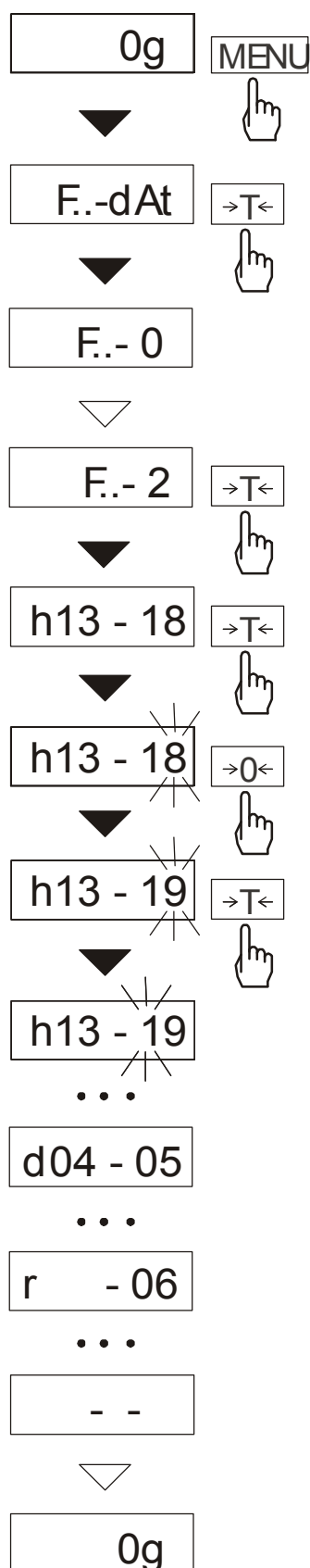

This function enables to set current date and time of internal balance clock and enable/disable date and time on weighing result printouts.

Options:

- *F..-0* – deactivate date printout,
- *F..-1* – activate date printout (☐ key),
- *F..-2* - change date and time.

The example at the left presents how to set current date and time with *F..-2* option.

Change successive numbers using $\rightarrow 0 \leftarrow$ key.

To move to the next position use $\rightarrow T \leftarrow$ key.

Once current date and time is set activate it with *F..-1* option.

Time format: *h gg - mm*
(*gg* - hour, *m* - minute).

Date format: *d mm - dd*
(*m* - month, *d* - day).

Year format: *r - rr*
(*r* - two last digits of a year).

4. Formulation function (SU≡)

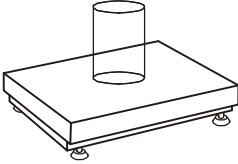
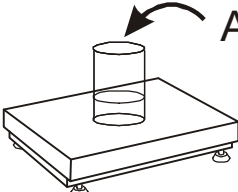
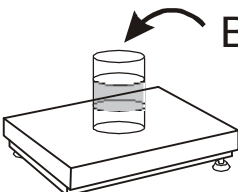
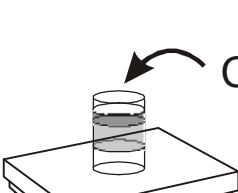
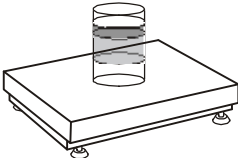
	0 g	MENU
	▼	↓
	F..-SU≡	→T←
	▼	↓
	F..- 0	
	▽	
	F..- 1	→T←
	▼	↓
	o 11g	→T←
	▼	↓
	o 0g	
	▼	
	o 12g	→T←
	▼	↓
	o 0g	
	▼	
	o 13g	MENU
	▼	↓
	F..-SU≡	→T←
	▼	↓
A+ B+ C	F..- 0	→T←
	▼	↓
	36g ^{SUM}	

This function allows separate weighing of several ingredients in one container with a possibility to control aggregated sum of all weighed components.

Function options:

- F..-0 – leave the function to read aggregated weight,
- F..-1 – start recipe formulation
- F..-2 – return to formulation.

Before weighing each of successive recipe ingredients (A, B, C, etc.) make sure the balance displays zero indication or simply tare the balance with →T← key.

To display aggregated sum of series of measurements, press *MENU* key, choose *SU≡* function and use F..-0 option.

Aggregated weight of the recipe is displayed when *SUM* indicator is lit.

Whilst *SUM* indicator is displayed, it is possible to return to the previous formula with F..-2 option.

To finish formulation and to remove *SUM* indicator press →T← key.

Notes:

If „o” indication is displayed at the left of the display, *SU≡* function is active.

5. Average calculation (SrE)

This function enables to calculate average value of series of measurements. During measurements successive values are registered automatically after result stabilisation.

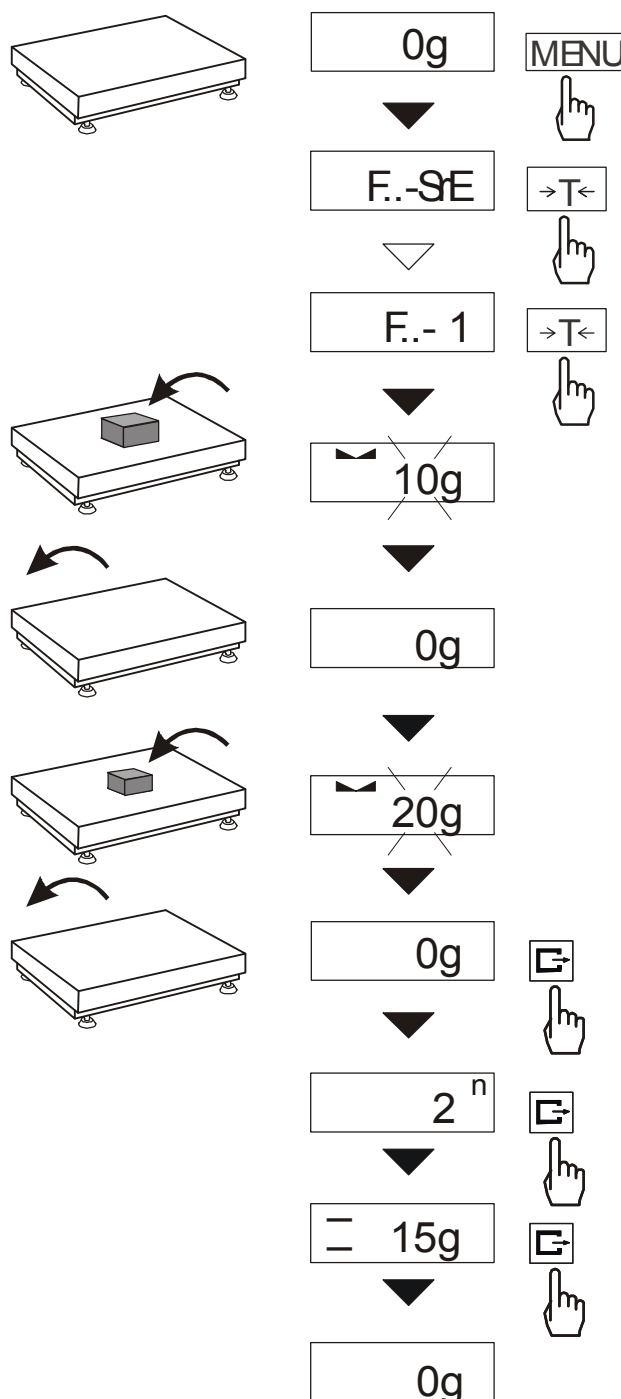

Press *MENU* key and choose *F..-SrE* function with $\rightarrow T \leftarrow$ key.

The following options appear:

- *F..-0* - exit,
- *F..-1* - average calculation.

Select *F..-1* option. The balance is now registering each stable result for average value calculation.

Pay attention that the value is registered only when the result is stable. Remove the load only after „- -” communicate is displayed.

The balance registers the results above Min balance value only.

The number of successive measurements is limited to 9999.

Press **G** key several times to display average calculation information in the sequence given below:

- number of measurements (n).
- average value (=).

Press **G** key for the third time to continue measurements.

If the printer is connected, the following report is printed:

Date: ...	Time. ...
MEASUREMENTS No = ...	
AVERAGE VALUE = ...	

To leave the function press *MENU* key, choose *F..-SrE* function and select *F..-0* option.

6. Percentage weighing (F.-Pro)

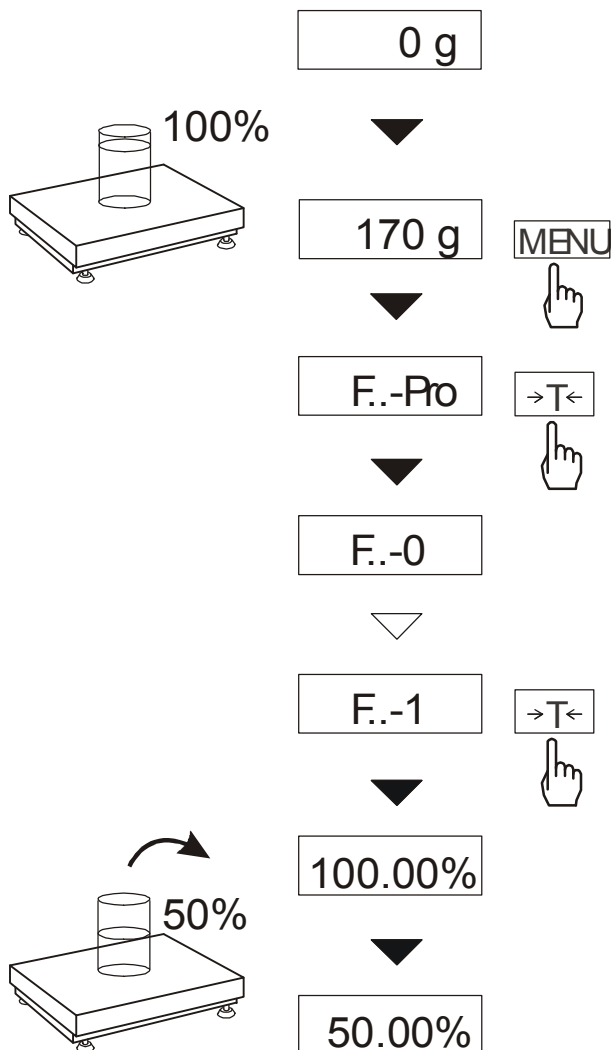

This function enables to display weighing result as a percentage of a reference sample.

A measurement is performed in two phases:

- first phase – weighing a reference sample,
- second phase – measuring specific sample as a percentage of the reference sample.

Weighing result is displayed in different format, depending on the reference sample weight value. For values of 0÷3,5% of weighing range the format is “100.0”, for values 3,5÷35% it is “100.00” and 35÷100% - “100.00”

The function has the following options:

- F.-0 – disables the function,
- F.-1 – stores current indication as 100% and activates percentage weighing,
- F.-2 – activates percentage weighing with the previous reference sample value.

„%” sign is replaced with „ $\overline{\text{—}}$ ” indicator.

Note:

1. Err-3 communicate signalises that 100% value is smaller then $0.5 \cdot \text{Min}$ or not entered (see F-1).

2. When the function is activated →T← key function does not change.

7. Animal weighing (LOC)

This function allows precise animals weighing.

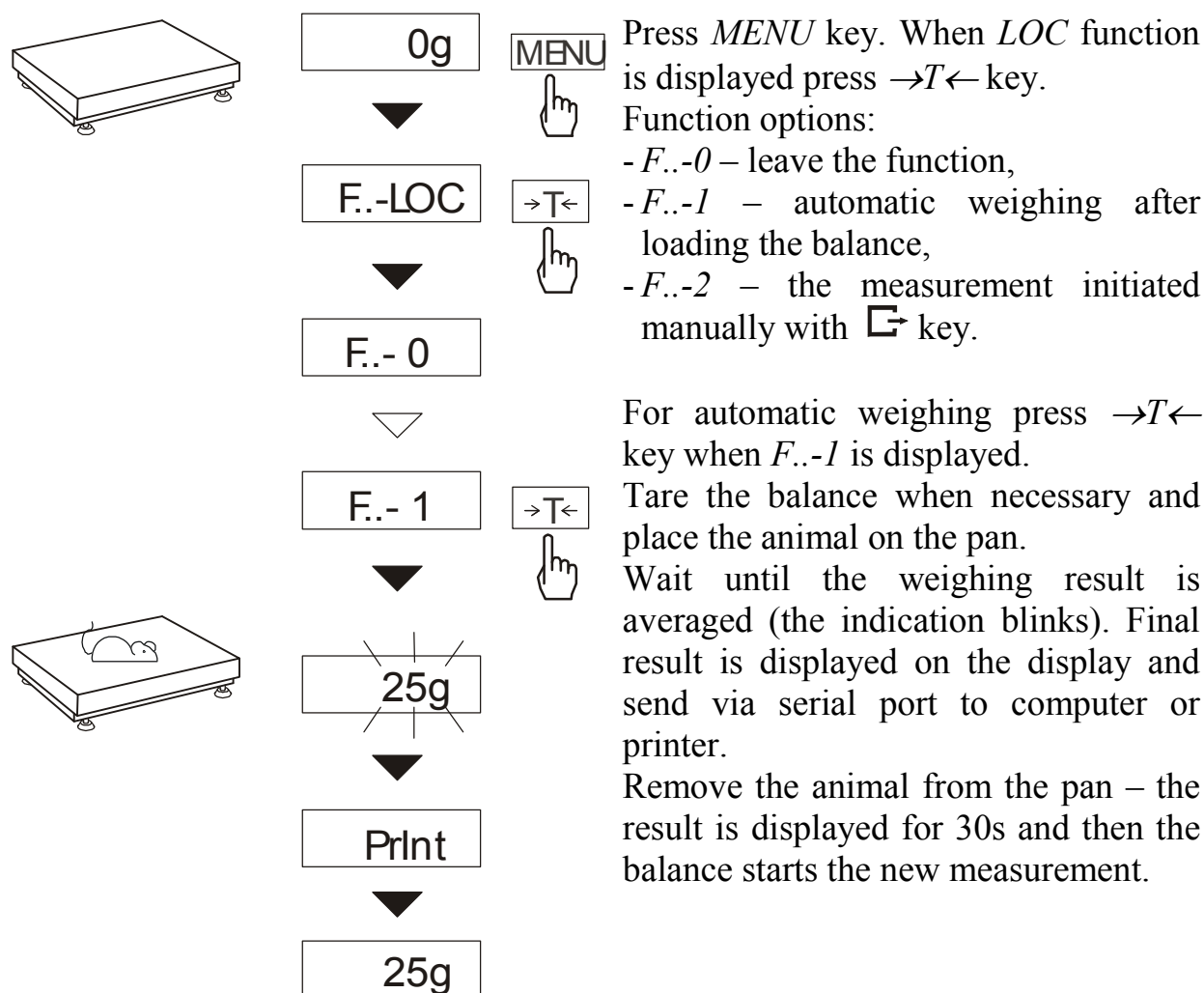

Important notes:

1. The load less than *Min* is not averaged.
2. In case placing the animal takes more than 5s, it is advised to use *F..-2* option (manual weighing with $\square \rightarrow$ key).

8. Maximum value (UP)

This function enables to display the maximum value from the series of weighing.

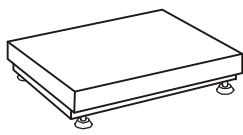

0 g MENU



F..-UP →T←



F..- 0



F..- 1 →T←



1g



10g



10g

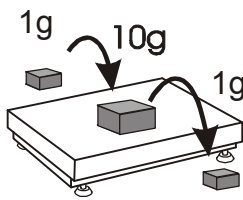

Make sure the balance displays zero indication before starting measurements.

Enter the function menu with MENU key and choose *F..-UP* function. The displayed indication is the highest value from the series of measurements.

Press →T← key to zero the indication.

Note:

Autozero function and the stabilisation indicator are deactivated when UP function is active. The indication is the result of continuous averaging of 5 measurements.

9. Anti-disturbance filter (FIL)

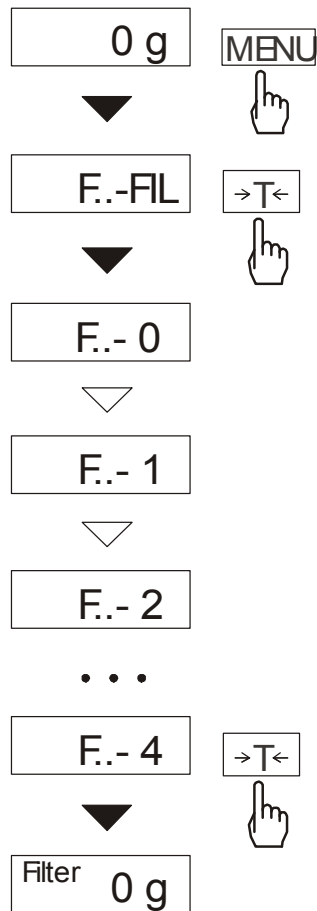

This function activates digital filter of chosen intensity, which reduces the influence of mechanical vibrations (air blasts, base vibrations) on measurement result. Using the filter is necessary for accurate people or animal weighing.

Press *MENU* key and choose *F..-FIL* with *→T←* key.

The following options appears:

- *F..-0* – filter deactivated
- *F..-1* - filter I (weak)
- *F..-2* - filter II (average)
- *F..-3* - filter III (intense)
- *F..-4* - filter IV (very intense)

Choose the filter of desired intensity – the balance is now operating with selected filter.

To return to normal work (deactivate the filter) enter *F..-FIL* menu and choose *F..-0* option.

10. Checkweighing (*thr*)

This function compares weighing result with two reference values: lower and upper threshold. The balance signals comparison result with MIN, OK and MAX indicators and sound signal generated when threshold values are exceeded.

If comparison result is:

- smaller than lower threshold – the balance displays MIN,
- between threshold values - the balance displays OK with the shot sound signal when exceeding the threshold,
- greater than upper threshold - the balance displays MAX with the long sound signal when exceeding the threshold.

The checkweighing results can be used to control external optical indicator (*Indication mode*) or batching devices (*Batching mode*). Standard balance is set for cooperation with the external indicator.

Threshold comparison results appear on P1-P3 (*Relays socket*) output pins as a short-circuit state.

Output state charts (increasing load):

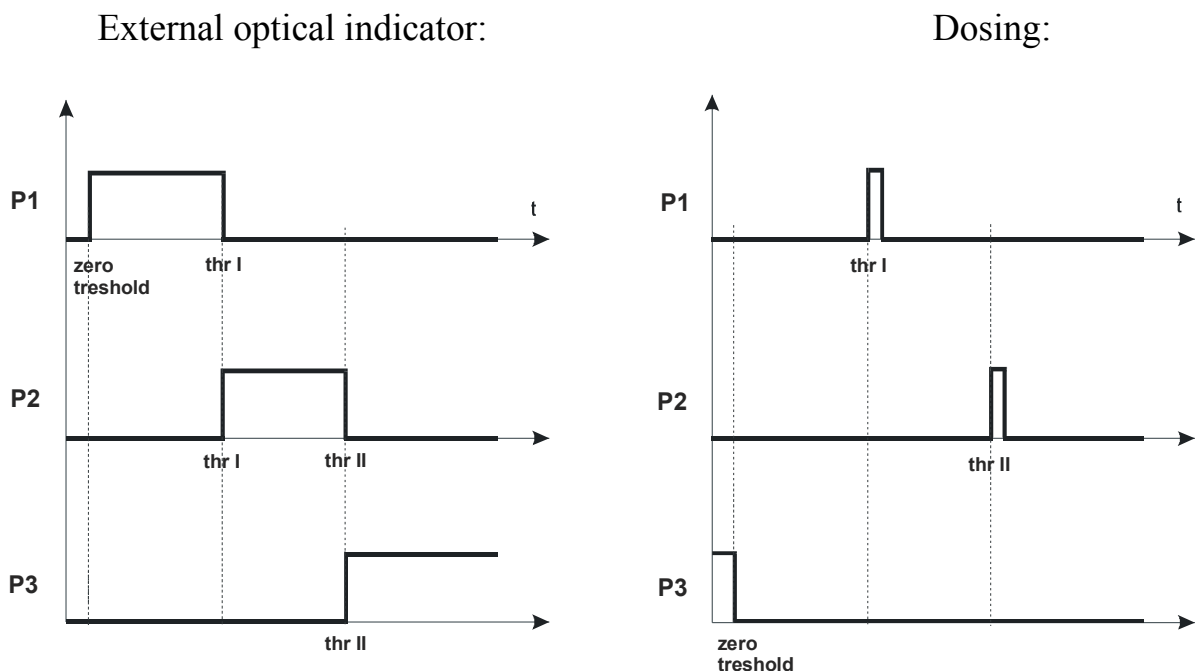

During dosing (optional), short-circuit pulses lasting for 0.5s appear on P1 (I threshold) and P2 (II threshold) outputs and for P3 output (zero threshold) – short-circuit state for the indication below zero threshold.

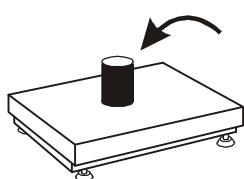
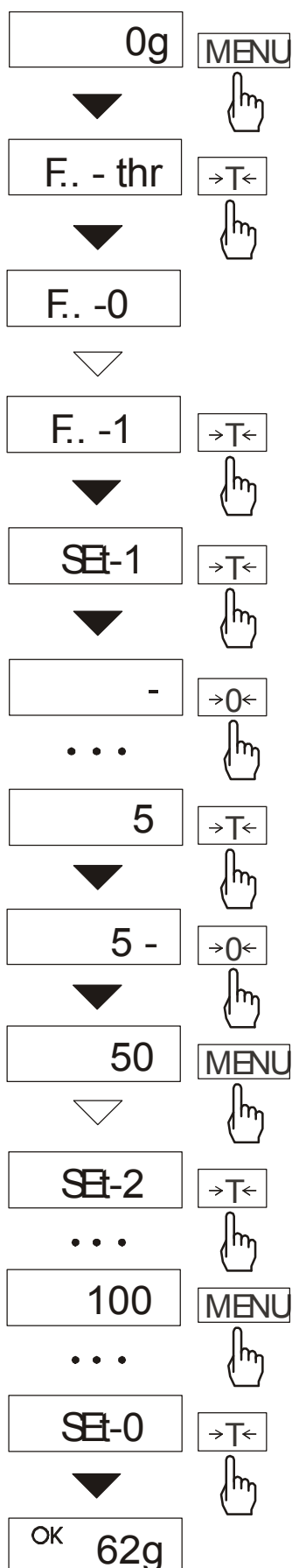
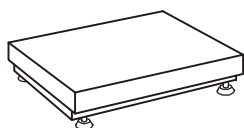

Press *MENU* key and choose *F..- thr* with $\rightarrow T \leftarrow$ key.

The following options are displayed:

- *F..-0* – deactivate the function,
- *F..-1* – activate the function,
- *F..-P* – check current threshold values (use $\square \rightarrow$ to display successive values),
- *F..-t* – *Relays* socket mode:
 - 0 – exit
 - 1 – *Batching* mode
 - 2 – *Indication* mode

Choose *F..-0* option with $\rightarrow T \leftarrow$ key.

Following options are displayed:

- *SEt-0* - start the function with the excess signalisation,
- *SEt-1* - set lower threshold value,
- *SEt-2* - set lower threshold value,
- *SEt-3* - set zero excess signalisation,

Set the lower and the upper threshold values with the following keys:

- $\rightarrow 0 \leftarrow$ - digit increase,
- $\square \rightarrow$ - decimal point,
- $\rightarrow T \leftarrow$ - next digit,

MENU - end.

To start checkweighing function use *Set-0* option.

To change *Relays* socket mode use *F..-t* option. Default option is *Indication*.

To leave the function, press *MENU* key and choose *thr* and *F..-0* options.

Notes:

When necessary, use *SEt-3* option to set the zero threshold value (indications below this value are regarded as unloaded balance).

Relays connection diagram:

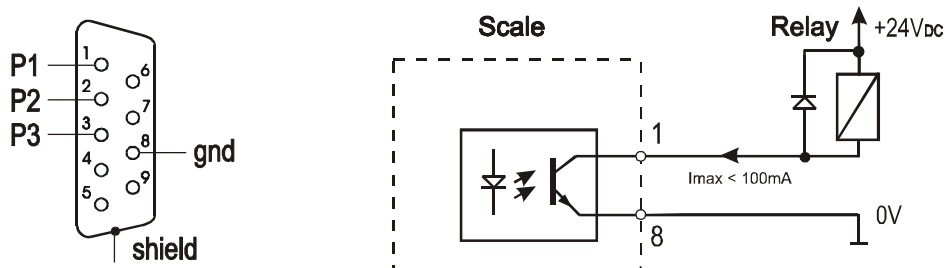

Relays output is the open collector transistor output with load capacity 100mA / 24V. Transmitter inputs must be protected with diodes, e.g. 1N4148. It is advised to use MS3K/P electronic board (sold separately), consisting of RM96P transmitters, with DC24V input voltage and AC250V, 3A output.

Important notes:

After switching the balance on, both thresholds are set as maximum values. When selecting upper threshold value, pay attention that its value is not greater than the lower threshold value.

11. Total weight function (totAL)

The function enables to calculate total weight of series of measurements greater than the balance capacity.

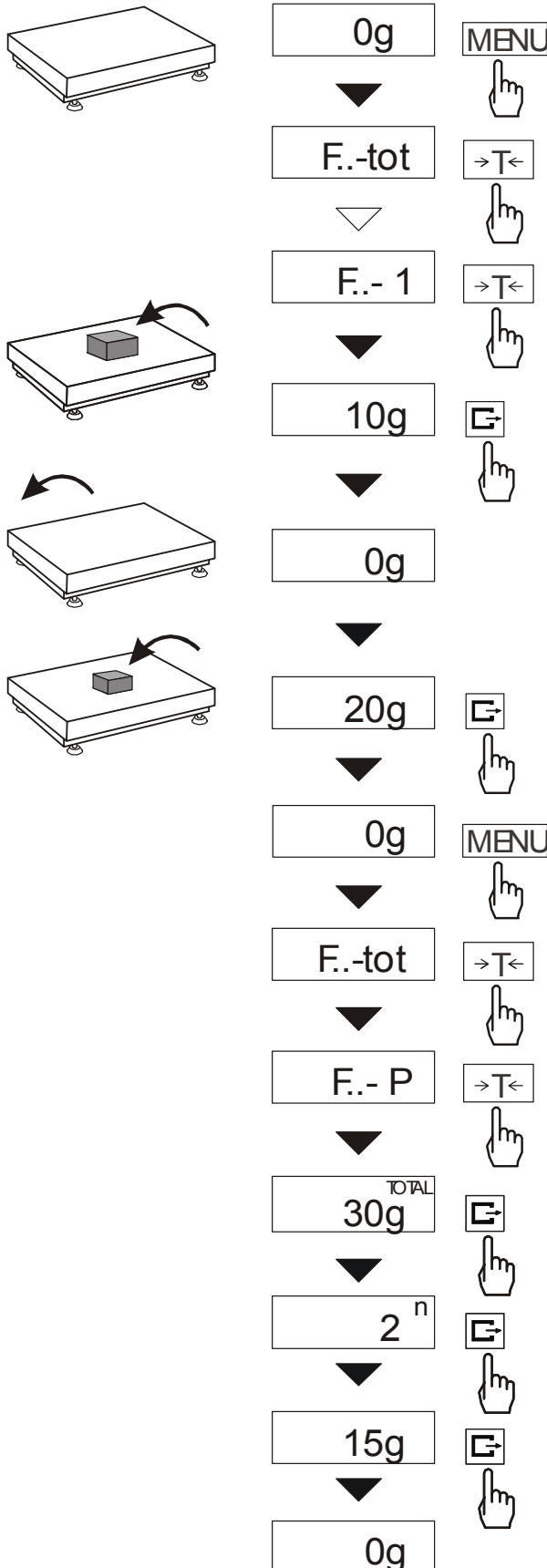

To enter the function, press *MENU* key and choose *F..-tot* option with **→T←** key.

The following options are displayed:

- *F..-P* - report printout without clearing the adding register,
- *F..-0* - report printout with clearing the adding register,
- *F..-1* - report printout after each measurement,
- *F..-2* - report printout disabled.

Press **→T←** key when *F..-1* is displayed.

Place successive samples on the pan and press **⇧** after each measurement to store the value in the adding register

To display current results enter *F..-tot* function menu and choose *F..-P* option.

The results are display in the following order:

- total weight (\equiv)
- number of registered measurements (n),
- average value (\equiv).

(Press **⇧** key twice).

To continue series of measurements press **⇧** key for the third time.

To leave the function with clearing the adding register, enter *F..-tot* function menu and choose *F..-0* option. When connected to a printer, the balance prints the communicate informing about clearing the register.

The sample check for each measurement:

Date:	...	Time	...
measurement no		weight	
measurement no		weight	
...		...	

Report printout sample:

Date:	...	Time	...
TOTAL WEIGHT		=	
NUMBER OF SAMPLES		=	
AVERAGE VALUE		=	

Note:

When the balance has not an internal clock, Date and Time do not appear on printout. Maximum number of measurements 99 999.

Maximum total load 99 999 000d.

The weighing unit of the aggregated value from the register (total) is the same as the weighing unit stated on the keypad or is 1000 times greater (signalised with “o” indicator at the left of the display).

If the registered value is too big to be displayed, “E” communicate appears on the display.

If the number of series is too high to be displayed, “Err1” communicate appears on the display.

12. Density determination (hYdro)

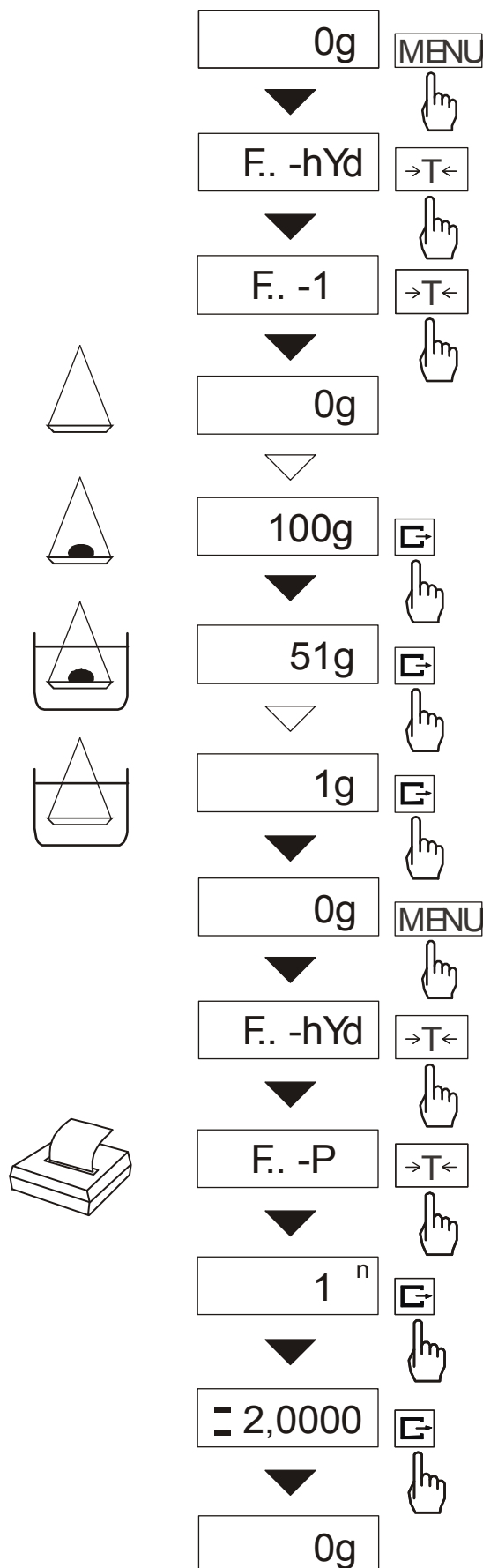

This function calculates material density basing on its weight in air and in liquid of known density using the formula below:

$$\rho = \frac{m_1}{m_1 - m_2} * \rho_L$$

where, m_1 – weigh in air
 m_2 – weight in water
 ρ_L – density of liquid

Default liquid density is:

$$\rho_L = 1\text{g/cm}^3$$

(distilled water).

When using liquid other than distilled water, choose *F..-hYd* and use *F..-2* option to enter its density according to its temperature.

To enter the value use the following keys:

→0← - digit increase,
 ⇐ - decimal point,
 →T← - next digit,
 MENU - end.

The measurement is performed in three phases:

- measurement in air,
- measurement in liquid,
- hanger weighing.

To read density determination result, enter *F..-hYd* function menu and use *F..-P* option. Press ⇐ key to display successive measurement number. Press ⇐ key again to display density measurement result and to send the density value to the printer. The balance is now ready for the next density determination.

To print a density determination report after all necessary measurements, connect a printer to the balance.

Date: ...	Time. ...
MEASUREMENT No. =	
WEIGHT in air = g
WEIGHT in liquid =	g
HANGER WEIGHT =	g
LOAD DENSITY =	g/cm^3
LIQUID DENSITY =	g/cm^3

Operation sequence (weighing in air and in liquid) for below-balance weighing:

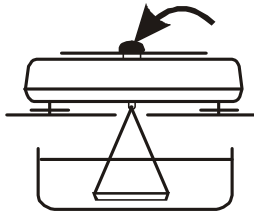

Phase I: measurement in air.

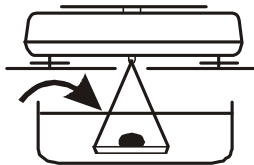

Phase II: measurement in liquid.

13. Function Menu customisation (F..-ACt)

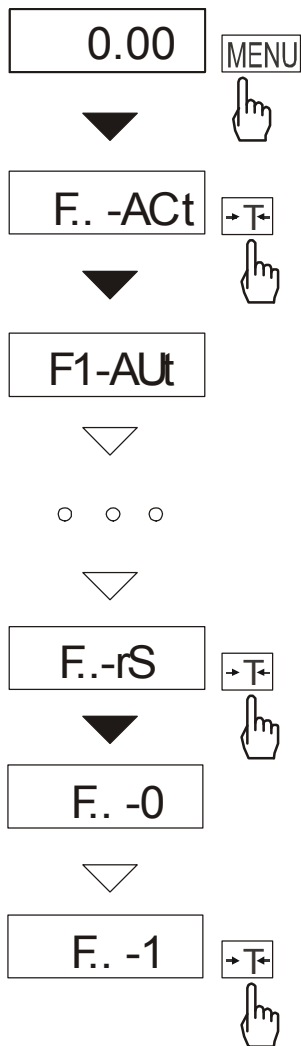

This function enables to select special functions that will be displayed after pressing *MENU* key. Easy access to the most useful functions will shorten operation time and make work more comfortable.

Operation sequence shown on the picture, presents how to add RS232C parameters setting function (F..-rS) to the Function Menu.

To remove a function from the Function Menu choose “F..-0” in the last operation.