

Panasonic

Operating Instructions
Digital Cellular Phone

EB-GD67



Before operating this equipment please read these instructions completely.

Important Information

We, Matsushita Mobile Communications Development of Europe Ltd, declare, that the EB-GD67 conforms with the essential and other relevant requirements of the directive 1999/5/EC. A declaration of conformity to this effect can be found at <http://www.panasonicmobile.com/support>

Safety Considerations

The following information should be read and understood as it provides details which will enable you to operate your phone in a manner which is both safe to you and your environment, and conforms to any legal requirements regarding the use of cellular phones.



This equipment should only be charged with approved charging equipment. Other usage will invalidate any approval given to this apparatus and may be dangerous. The use of approved charging equipment is recommended to ensure optimum performance and avoid damage to your phone. Ensure the voltage rating of the Fast Travel Charger is compatible with the area of use when travelling abroad.

A Fast Travel Charger (EB-CAD95xx*) is supplied with the Main Kit. Other recommended equipment for charging -Car Charger (EB-CDD95)

Note* xx identifies the Charger region, e.g. CN, EU, HK, UK.



Switch off your cellular phone when in an aircraft. The use of cellular phones in an aircraft may be dangerous to the operation of the aircraft, disrupt the cellular network and may be illegal. Failure to observe this instruction may lead to the suspension or denial of cellular phone services to the offender, or legal action or both.



Do not incinerate or dispose of the battery as ordinary rubbish. The battery must be disposed of in accordance with local legislation and may be recycled.

Important Information



It is advised not to use the equipment at a refuelling point. Users are reminded to observe restrictions on the use of radio equipment in fuel depots, chemical plants or where blasting operations are in progress. Never expose the battery to extreme temperatures (in excess of 60°C).



It is imperative that the driver exercises proper control of the vehicle at all times. Do not hold a phone while you are driving; find a safe place to stop first. Do not speak into a Handsfree microphone if it will take your mind off the road. Always acquaint yourself thoroughly with restrictions concerning the use of cellular phones within the area you are driving and observe them at all times.



Care must be taken when using the phone in close proximity to personal medical devices, such as pacemakers and hearing aids.



For most efficient use hold the phone as you would any normal phone. Your GD67 cellular phone is fitted with an internal antenna, located in the upper portion of the phone, above the display screen. To avoid deterioration of signal quality or antenna performance, do not touch or "cup" the antenna area while the phone is switched on. (See "SAR Statement" page iii)
Unauthorized modifications or attachments may damage the phone and violate applicable regulations. The use of an unapproved modification or attachment may result in the invalidation of your guarantee – this does not affect your statutory rights.

This Panasonic mobile phone is designed, manufactured and tested to ensure that it complies with the specifications covering RF exposure guidelines applicable at the time of manufacture, in accordance with EU, USA FCC, and Australian ACA regulations; or as specifically stated in the separate declaration leaflet enclosed with this product.

Please refer to our website for latest information/standards compliance in your country/region of use.

<http://www.panasonicmobile.com/health.html>

SAR Statement

European union - RTTE

THIS PANASONIC PHONE (MODEL EB-GD67) MEETS THE EU REQUIREMENTS FOR EXPOSURE TO RADIO WAVES.

Your mobile phone is a radio transmitter and receiver. It is designed and manufactured not to exceed the limits for exposure to radio frequency (RF) energy recommended by The Council of the European Union. These limits are part of comprehensive guidelines and establish permitted levels of RF energy for the general population. The guidelines were developed by independent scientific organisations through periodic and thorough evaluation of scientific studies. The limits include a substantial safety margin designed to assure the safety of all persons, regardless of age and health.

The exposure standard for mobile phones employs a unit of measurement known as the Specific Absorption Rate, or SAR. The SAR limit recommended by The Council of the European Union is 2.0 W/kg.* Tests for SAR have been conducted using standard operating positions with the phone transmitting at its highest certified power level in all tested frequency bands. Although the SAR is determined at the highest certified power level, the actual SAR level of the phone while operating can be well below the maximum value. This is because the phone is designed to operate at multiple power levels so as to use only the power required to reach the network. In general, the closer you are to a base station antenna, the lower the power output.

Before a phone model is available for sale to the public, compliance with the European R&TTE directive must be shown. This directive includes as one essential requirement the protection of the health and the safety for the user and any other person. The SAR value for this model phone, when tested for use at the ear, for compliance against the standard was **0.505 W/kg**. While there may be differences between the SAR levels of various phones and at various positions, they all meet the EU requirements for RF exposure.

* The SAR limit for mobile phones used by the public is 2.0 watts/kilogram (W/kg) averaged over ten grams of tissue. The limit incorporates a substantial margin of safety to give additional protection for the public and to account for any variations in measurements. SAR values may vary depending on national reporting requirements and the network band. For SAR information in other regions please look under product information at <http://www.panasonicmobile.com/health.html>

Accessories

Car

Car Charger

EB-CDD95

Top up your battery in your vehicle by attaching this accessory to your phone and to the cigarette lighter socket



Car Holder

EB-KAD67

This compact Car Holder can be mounted in your vehicle, providing a convenient and attractive means of storing your phone



Personal

Carry Case

EB-YKD67

This attractive hip case protects your phone and by using the belt clip keeps it close at hand.



Li-Ion Battery

EB-BSD67

Double your talk time by having a spare battery.



Personal Handsfree

EB-EMD35

Talk and move while keeping your hands free by using this accessory. Just place the earpiece in your ear and the adaptor in the side of the handset - and talk



Office

Fast Travel Charger

EB-CAD95UK

Carry a lightweight portable charger wherever you go to ensure you always have power to talk



Fast Travel Charger

EB-CAD95EU



Charge Data Cable

EB-RSD67

This Charge Data Cable is used to connect your phone to a PC, allowing data communication between them. This should be used in conjunction with the Free Panasonic Data Connection Assistant Software.



The software can be downloaded from

<http://www.panasonicmobile.com/support/software>

Identify a Genuine Panasonic Accessory

Panasonic produces some of the most advanced mobile phones available. So, as you'd expect from this class leader, the range of accessories are second to none.

Most genuine Panasonic accessories will have a label showing an "EB-XXX00" model number

Care and Maintenance



Pressing any of the keys may produce a loud tone. Avoid holding the phone close to the ear while pressing the keys.



Extreme temperatures may have a temporary effect on the operation of your phone. This is normal and does not indicate a fault.



Do not modify or disassemble the equipment. There are no user serviceable parts.



Do not subject the equipment to excessive vibration or shock.



Avoid contact with liquids. If the equipment becomes wet immediately remove the power and contact your dealer.



Do not leave the equipment in direct sunlight or a humid, dusty or hot area.



Keep metallic items that may accidentally touch the terminals away from the equipment.



Always charge the battery in a well ventilated area, not in direct sunlight, between +5°C and +43°C. It is not possible to recharge the battery if it is outside this temperature range.

















When connecting the phone to an external source, read the operating instructions of the equipment for the correct connection and safety precautions. Ensure the phone is compatible with the product it is being connected to.



When disposing of any packing materials or old equipment check with your local authorities for information on recycling.



Quick Reference

	"Press () to select".
	Direction which the user can move around the display screen using the Navigation key.
	Press a key once for a particular phone operation.
 + Hold	"Press and hold" a key for a particular phone function.
Menu	Representation of screen menu option.
	Secondary Softkey
	Negative soft key/Back-key
	Numeric key pads.
	Answer a call or call a dialled number.
	To end a call or return to Idle screen or  + Hold to switch the phone on or off.
	Indicates that a function is SIM Dependent.
	Indicates that a function is Network Dependent.
	Switches Quiet Mode on and off.

Contents

Important Information	i
Safety Considerations	i
SAR Statement	iii
European union - RTTE	iii
Accessories	iv
Car	iv
Personal	iv
Office	v
Identify a Genuine Panasonic Accessory	v
Care and Maintenance	vi
Quick Reference	vii
Getting to Know Your Phone	xi
Location of Controls	xi
Getting Started	1
Fitting the SIM & Removing the SIM	1
Fitting the Battery and Rear Cover	2
Removing the Rear Cover and Battery	2
Charging the Battery	3
Fitting the IO cover	4
Fitting Image-In	4
Operation of Battery Level Indicator	5
Low Battery Warning	5
The Menu System	5
Display Icons	6
Using the Menu System	7
Selecting a Function	7
Basic Operation	9
Switching the Phone On/Off	9
Making a Call	9
International Dialling	9
Emergency Calls	10
Automatic Redial	10
Ending a Call	10
Answering a Call	10
Caller Identification	11
Earpiece Volume Control	11
Locking the Phone	11
Using the PIN	12
Setting Quiet Mode	12
Setting Ring and Key Volume	13
Setting the Key Tone Type	13
Phonebook	14
Store a Number	14
Overwrite Protection	15
Browsing Phonebook	15
Retrieve a Number	15
Editing Phonebook Entries	16
Grouping Phonebook Entries	17
Using Voice Commands	19
Voice Dial Entry Setup	19
Recalling Voice Dial Entries	19
Dialling Voice Dial Entries	20

Editing the Voice Dial Entries	20
My Numbers	21
Personalising Your Phone	22
Add a Start-up Greeting	22
Displaying Animations	22
Idle Screen Image	22
Media Folders	23
Colour Themes	23
Changing the Ring Tone	23
Download data ()	25
Composing a Melody	27
Setting the Backlight Time	28
Changing the Language	28
Restoring the Default Phone Settings	28
Phone Security	29
Enabling Key Guard	29
Disabling Key Guard	29
Changing the Security Codes	29
Restricting Calls	30
Applications	32
Clock	32
Initially Setting the Home Time	32
Setting the Clock Format	32
Altering the Time/Date	33
Setting the Clock for Summer Time	33
Setting the Alarm	33
Muting the Alarm	33
Setting a Power On/Off Time	34
Calculator	35
Currency Convertor	35
Text Messages	37
Setting the Phone for Short Text Messages	37
Setting the Message Centre Number	37
Creating a Text Message	37
Receiving Text Messages	38
Message Options	39
Cut / Copy & Paste Message Text	39
Manage Messages Lists	40
Chat SMS	40
Cell Broadcasts	41
Parameters	42
Call Information	44
Recent Numbers	44
Call Duration	45
Call Charges	46
Setting the Unit Price	46
Setting the Maximum Unit Level	46
Setting a Warning Level	47
Call Identification	47
Advanced Operation	48
Diverting Calls	48
Holding Calls and Call Waiting	48
Making a Second Call	48
Receiving a Second Call	49
Accept a Second Call	49
Reject a Second Call	49
End Current Call and Receive Second Call	49

Operation During Two Calls	49
Call Transfer	50
Multi-party Calls	50
Changing to a New Network	52
Schedule	53
Creating a Reminder	53
Viewing Reminders	53
Deleting Reminders	54
Setting a Holiday Reminder	54
Deleting Holiday Reminders	54
Jump to Date	55
Games	56
Downloadable Games ()	56
Embedded Games ()	56
WAP Browser	57
Browser Settings	57
Activating the Browser	58
Navigating Content	58
The Browser Menu	58
Using Bookmarks	59
Deactivating the Browser	61
Setting the Linger Time	61
Additional Features	62
Desktop Handsfree	62
Voice Memo	62
DTMF Tones	63
Note Pad	64
Second Clock	64
Setting Clock Display	64
Accessory Related Features	65
Text Entry	66
T9® Text Input	67
Other Text Modes	67
Editing Text	67
Trouble Shooting	68
Important Error Messages	70
Glossary of Terms	72
Specifications	74
Phone (Including Battery)*	74
EU Warranty	75
Personal Settings	80
Notes	81
Menu Structure	82
Licencing	83

Getting to Know Your Phone

Location of Controls



Getting Started

Thank you for purchasing this Panasonic digital cellular phone. This phone is designed to operate on GSM networks - GSM900 or GSM1800. It also supports GPRS for packet data connections. Ensure the battery is fully charged before use.

Before operating this phone please read the "Important Information" section - see page i.

These operating instructions detail use of the equipment contained in the Main Kit.

Some services detailed, are network dependent () or may only be available on a subscription basis. Some functions are SIM dependent (). For more information contact the Service Provider. If an item in the Phone Option is network or SIM dependant and is not available, the items will be "Greyed-Out". If the highlight bar is moved over a "Greyed-Out" item, the primary softkey label will be removed.

Fitting the SIM & Removing the SIM

The SIM is inserted into the back of the phone underneath the battery.



Getting Started

Fitting the Battery and Rear Cover

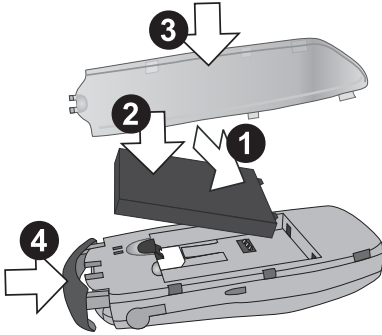

Removing the Rear Cover and Battery

Ensure the phone is switched off and the charger is disconnected from the phone before removing the battery.

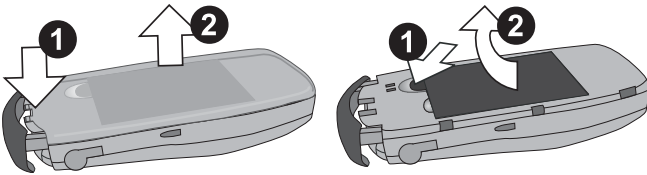

Charging the Battery

Connecting the Fast Travel Charger

The battery must be fitted in the phone before the charger is connected. Insert the connector into the base of the phone, ensuring the arrows on the connector are to the front of the phone.

Note: DO NOT force the connector as this may damage the phone and or the charger.

Connect the charger to the mains power supply. The charging indicator will light and the battery level indicator will scroll right to left when charging.



Disconnecting the Fast Travel Charger

When charging is complete turn off the mains power supply and disconnect the charger.

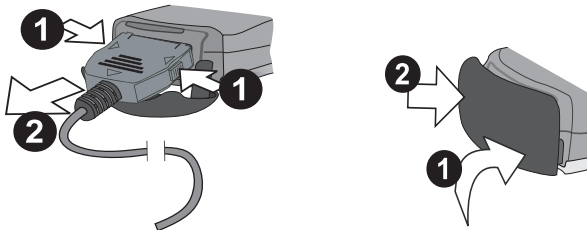

Getting Started

Fitting the IO cover

If excess force is applied to the IO cover, it is possible that the cover can become detached from the phone.

If the IO cover does become detached, it can easily be replaced

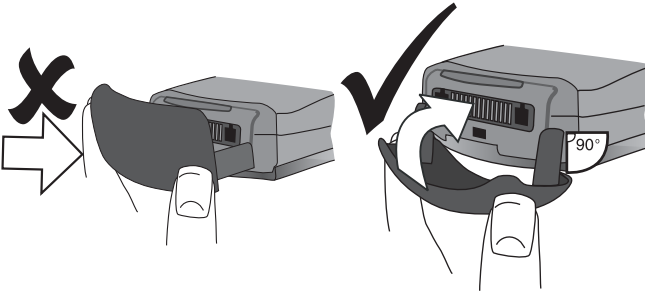

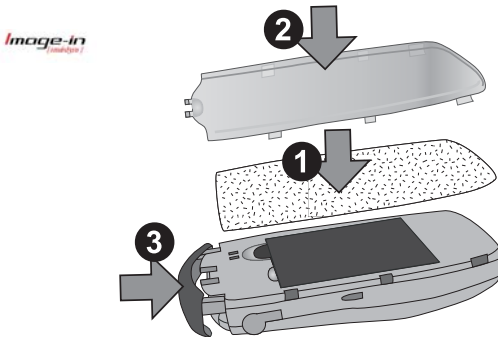

Fitting Image-In

Customised image cards may be fitted to the rear of the phone, behind the transparent rear cover.



Operation of Battery Level Indicator

	While charging	Charging complete
Phone on		
Phone off		LCD Battery Charge Indicator off

Low Battery Warning

When the battery power is low, a warning tone will sound, and a flashing **LOW BATTERY** message will be displayed. If this occurs during conversation, finish your call immediately. The power will automatically shut off after the warning tone. Fully recharge the battery. See “Charging the Battery” page 3. (Calls can be made and received while the phone is charging)

It is recommended that the battery is fully discharged between charges to maintain optimum battery life and performance.

The Menu System

The menu system allows the user to access all the functions of the phone that are not accessible purely by key strokes. Each menu contains a list of options. Some menus have further sub menus.

Getting Started









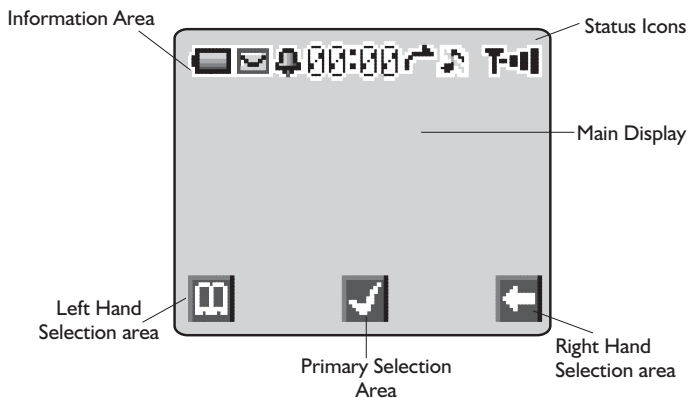







Display Icons



Following some operations the display will automatically clear after three seconds or after pressing any key.

Status Icons

The status icons are displayed according to the currently activated functions. The Antenna, Signal and Battery icons are displayed when the handset is switched on and connected to a network.



-  is displayed when you are registered to a non-home network - Roaming
-  Indicates Call divert is enabled
-  Indicates **Quiet Mode** is enabled
-  Indicates All tones or ring volume is off
-  Icon flashes when there is an unread message in the Inbox, or remains permanently lit when store is full
-  Indicates Phone lock is enabled
-  Indicates it is possible to make emergency calls only
-  GSM signal strength:  - weak signal,  - strong signal
-  GPRS signal strength:  - weak signal,  - strong signal
-  Indicates Battery level:  - full,  (flashing) - low battery
-  Indicates Alarm is set





-  Indicates current Phonebook entry is sourced from the Mobile Phonebook
-  Indicates current Phonebook entry is sourced from the SIM Phonebook
-  Available directions in which the **Navigation key** can be pressed

Using the Menu System

The menu system provides the means for accessing all the functions which do not have their own dedicated buttons on the keypad.

The menu functions are selected using the five-way **Navigation key**. ()

Selecting a Function

 and  move around the icons on the screen. When a particular menu is highlighted,  a submenu is displayed. From any submenu, use  until the required item is highlighted, .













Example:

From **Idle**  , select **Phone Option** > **Security** > **Phone Lock** > **Status**  .

Use  to choose Enable or Disable,  .

Enter the lock code, See "Locking the Phone" page 11,  .











In detail:

- 1 Use  to enter the menu system
- 2 Use  to highlight the Phone Option menu
- 3   to enter the menu
- 4 Use  twice to highlight the Security menu
- 5   three times to enter the Phone Lock menu
- 6 Use  to select Enable or Disable  .
- 7 Enter the Lock Code  .

Following some operations the display will automatically clear after three seconds, if this is not the case   to return to **Idle**.

Getting Started

Shortcuts

When familiar with the layout of the menu, use the keypad to enter the Menu Number. This will allow the user to obtain the required function without having to navigate through the display menus. For example,   or  to enter the menu, then    to take you directly to the Enable/Disable menu. Make the choice of disable or Enable  , enter the Lock Code  .

Basic Operation

New to GD67 is the introduction of the "Pick List", which is used extensively throughout the phone. Using  to scroll through the Pick List, the user can highlight a feature before "checking" a check box, or selecting a button to the left of the option.

  to confirm selection of a feature and   to return to the previous screen.



Switching the Phone On/Off

 + Hold 

When the phone is switched on a greeting will be displayed and then the phone will go into Idle

Making a Call

Ensure that the phone is switched on, the network operator logo is displayed and the signal strength meter shows network coverage is available in the current area.







- 1 Enter area code and phone number
- 2  

International Dialling

Using the automatic international access code (+) you will be able to dial international numbers without having to know the code for the international exchange.

If the international number is known then it can be entered in the normal fashion followed by the area code and phone number.







- 1 From **Idle**  + Hold  until "+" is displayed
- 2 Use  to cycle through the abbreviated international names 
-  to choose the required code
- 3 Enter area code and phone number
- 4  

Basic Operation



Note: Many countries / regions include an initial "0" in the area code. This should, in most cases, be omitted when dialling international numbers. If you have difficulties making international calls, contact your Service Provider.

Emergency Calls

To make an emergency call the antenna symbol (T) must be present.

Enter 112   or if no SIM is fitted to the phone   

Automatic Redial

When your connection is unsuccessful,   when **Ok** is displayed and a timer will countdown in seconds to the next redial.

To stop redialling,   when **Cancel** is displayed in the Primary Selection area.

When a call is connected a beep will be emitted.

If a call is repeatedly unsuccessful, the phone will not automatically redial the phone number. In this case you must redial the phone number manually.



Ending a Call







Answering a Call

To receive a call the phone must be switched on and the signal strength meter must be displayed.

 any key except  or  to answer a call

  to reject a call

  during an incoming call, and you will be given the option to **Accept** or **Reject** the call. Use  to select an option and  

If a call is not answered, or is rejected, the number of incoming calls missed will be displayed.

 any key to clear the display



Caller Identification

This feature allows you to identify incoming calls. The caller's phone number, and name if stored in Phonebook, will be displayed.

Note: Caller Identification may not always be available.

Earpiece Volume Control











The volume level may be adjusted during a call:

Use \ominus to decrease the volume, use \oplus to increase the volume

Note: Volume control for Personal Handsfree accessory is adjusted in the same manner.

Locking the Phone



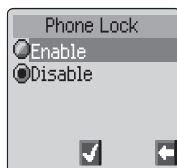

With the Phone Lock enabled you will be restricted to answer incoming calls and make emergency calls only. The Phone Lock Code is factory set to "0000".

- 1 From **Idle**  , select **Phone Option** > **Security** > **Phone Lock**  
- 2 From the pop up menu select **status**  
- 3 Select **Enable**  
- 4 Enter the 4-digit code,  



The lock icon () will now be displayed.











Unlocking the Phone

Enter your Lock Code  . However, when you turn the phone off and on again the Lock Code will need to be re-entered. When the correct code has been entered a tick will appear in the primary selection area,  

Basic Operation

Disabling Phone Lock

The phone must be unlocked before the phone lock can be disabled.

- 1 From **Idle**  , select **Phone Option** > **Security** > **Phone Lock**  
- 2 From the pop up menu select **status**  
- 3 Select **Disable**  
- 4 Enter the 4-digit code  

Using the PIN

The PIN protects your SIM against unauthorized use. If you enable the PIN, every time the phone is turned on you will be prompted to enter the PIN.











The PIN2 controls security for the Fixed Dial Store, Call Charge metering and Barred Dial.

If either PIN/PIN2 is entered incorrectly 3 times the phone will be locked and the user will need to enter the PUK/PUK2 code.

Contact your service provider for the PUK/PUK2 code.













Note: If the PUK/PUK2 code is entered incorrectly 10 times, the phone will cease to operate.

Enabling/Disabling the PIN

- 1 From **Idle**  , select **Phone Option** > **Security** > **PIN**  
- 2 Use  select **Status**  
- 3 Select **Enable / Disable** ,  
- 4 Enter PIN (Between 4 and 8 digits)  

Setting Quiet Mode









When required, the phone can be set up to vibrate when a call is received. Quiet Mode enables the user to choose between **Continuous**, **Intermittent** vibration alerts and a user defined ring volume when a call is received.

- 1 From **Idle**  , select **Personalise** > **Quiet Mode**  
- 2 Select **Ring Volume**  , adjust the ring volume as required  
- 3 select **Vibration**  
- 4 Choose the vibration setting required; **Continuous**, **Intermittent** or **Disable**,  







Note: When activated, the phone will vibrate briefly.

Setting Ring and Key Volume

Changing either the ring volume/key volume is done in the same manner. If you increase the ring volume above maximum it will set an escalating ring tone. If you turn the ring volume off, the silent indicator icon (🔇) will be displayed.

- 1 From **Idle**  , select **Personalise** > **Tones**  
- 2 Select **Ring Volume** or **Key Volume**  
- 3 Use  to set the volume level  

Setting the Key Tone Type

- 1 From **Idle**  , select **Personalise** > **Tones** > **Key Tone Type**  
- 2 Use  to select tone type  

Phonebook

It is possible to store phone numbers in two locations:











In the SIM Phonebook (☐)

In the Mobile Phonebook. This means that if you change the SIM, the numbers in the phone are not lost



The Mobile Phonebook has the advantage that you can group your phonebook entries together.

Store a Number



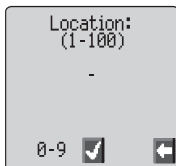











To Store a Number in the SIM Phonebook

- 1 From **Idle** enter the phone number and  
- 2 To select SIM Phonebook  
- 3 Enter the name – see “Text Entry” page 66,   twice
- 4 Confirm Phone number  
- 5 Enter location number  





You can choose not to enter a location number and the entry will be placed in the next available location. Simply   when **Any is displayed.**

To Store a Number in the Mobile Phonebook

- 1 From **Idle** enter the phone number and  
- 2 Use  to select **Mobile Phonebook** and  
- 3 Enter the name - see “Text Entry” page 66,  
- 4 Confirm phone number   twice
- 5 Use  to select a group - see “Grouping Phonebook Entries” page 17 - into which to place the entry  
- 6 Enter location number  



A location number does not have to be specified. In this case the entry will be placed in the next available location. Simply   when **Any is displayed.**

Overwrite Protection

If a location is occupied, a prompt will be displayed to confirm that the current information is to be overwritten.











  to overwrite the selected location

  to choose another location number

Note: If you amend an entry stored in your phonebook that has a Voice Dial Command assigned to it, you will need to delete and reassign that Voice Dial Command - see “Editing the Voice Dial Entries” page 20.



Browsing Phonebook

You can search the Phonebook by either Name or Location. The default setting for browsing is by name. When browsing by name pressing a lettered key will take you to the first entry starting with that letter.





- 1 From **Idle**  , select **Phonebook** > **Browse**  
- 2 Use  to toggle between **Names** or **Loc. Nos.**  
- 3 Use  to select the Phonebook you wish to browse  

Retrieve a Number

- 1 From **Idle**  
- 2 Use  to browse through the Phonebook and highlight the required entry  
- 3 Use  to select recall  

Note: The Phonebook you last viewed will be the default when you next  . To change the default, use the Phonebook menu to select a particular phonebook.

Speed Dial a Number Stored in SIM Phonebook





- 1 From **Idle** Enter location number – leading zeros may be left out
- 2  
- 3  

Phonebook







Editing Phonebook Entries

It is possible to **Detail, View, Recall, Edit, Delete** or **Create** information in the Phonebook. To access any of these functions follow the same procedure for each one.

With a phone number or name displayed:

- 1   Use  to cycle through **Detail, View, Recall, Edit, Delete** or **Create**
- 2   to select an option

Detail

Displays each element of the selected Phonebook entry. Use  to display the next/previous element of the entry. Each element may be edited -   , edit as required   twice to save any changes.



View

Displays an individual name and phone number in the names list.

Recall

Displays the phone number, enabling you to either change it or call the number.

Edit

Displays the entry allowing you to make changes as required.   twice to save any changes.

Delete

Deletes the entry from the Phonebook.

Create

Creates a new entry in the Phonebook

Grouping Phonebook Entries

The ability to group phonebook entries together is an extra function of the Mobile Phonebook.

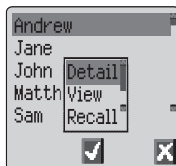

Retrieving a Number from a Group

Groups are used to collect together types of Phonebook entries, for example business and personal. Each group can be suitably titled for quick access to the entries contained within.

An alert profile can be attributed to groups, or a phone number, thus allowing incoming calls to be tailored to indicate the type of caller. See “Alert Profiles” page 17.

- 1 From **Idle** , select **Phonebook** > **Group Setting** and or from **Idle** twice
- 2 Use to select the group twice
- 3 Use to select the entry required twice to recall the number

Retitling Group Names

- 1 From **Idle** , select **Phonebook** > **Group Setting**
- 2 Use to select the group required
- 3 Use to select **Edit**

Clear the current title and re-enter - see “Text Entry” page 66

- 4 twice to save any changes





Alert Profiles

Alert Profile enables you to identify callers with a particular ring tone, display picture/Animation, making it easier to distinguish between callers or groups of callers.

Creating an Alert Profile

- 1 From **Idle** , select **Phonebook** > **Alert Profile**
- 2 , select **Add or Insert** from the pop up menu
- 3 Use to select **Personal** or **Group**
- 4 Recall the phone number / select group from the Phonebook – see “Retrieve a Number” page 15

Phonebook

- 1 Use  to select the ring tone that you wish to use for this profile 
- 2 Use  to select the picture 





Hot Key Phone Numbers

It is possible to dial phone numbers from the Phonebook or Service Dial part of Phonebook very quickly. Some Hot Key Phone numbers may be reserved by the Service Provider, for example the first three Hot Key Phone numbers may be linked to Service Dial ().

- 1  + Hold a Digit key ( - )
- 2  



Note: In some instances, a long press on the  key will initiate the games menu

Setting the Hot Key Dial Source

- 1 From **Idle**  , select **Phonebook** > **Hot Key Dial** 
- 2 Use  to select **SIM Phonebook** or **Mobile Phonebook** and 

Info Numbers or Service Dial





Your Service Provider may program some special phone numbers into your SIM (). It is not possible to modify these

- 1  + Hold 
- 2   to browse through the Service Dial list of phone numbers

The phone number pointed to can only be recalled or dialled.

Review the Phonebook

The Review function in the Phonebook menu shows how many locations are available in the Phonebook.

- 1 From **Idle**  , select **Phonebook** > **Review** 
- 2 Use  to select **SIM Phonebook** or **Mobile Phonebook** 









A summary of the selected Phonebook will be displayed.

Using Voice Commands



Before any of the phone's voice activated functions can be used, it is necessary to configure the phone so that it will recognize a particular voice and intonation.

Voice Dial Entry Setup

This function allows the user to recall and dial numbers from the Phonebook using voice commands.

- 1 From **Idle**  , select **Phonebook** > **Voice Command** > **Voice Dial**  
- 2   to add a new Voice Dial entry to the list
- 3 Browse through the Phonebook to select an entry which is to be attributed with a voice command,   twice

Note: Each recording is short in length, so be prepared to speak soon after initiating the recording.





- 4 When ready, the user should hold the phone approximately 20cm from his/her mouth,   and speak clearly into the microphone to record the name of the selected Phonebook entry



When the recording has stopped, it will be necessary to repeat the name.

- 5 When prompted,   and repeat the name

When recording is completed for a second time, the display will indicate if the recording was successful or not. If unsuccessful, repeat from step 4.

Recalling Voice Dial Entries

From **Idle** move and hold the navigation key () in any one of the four directions , ,  or . Speak clearly the name you wish to recall (exactly as recorded) and wait.

The above procedure will recall the phone number and the recorded Voice Dial entry is repeated; to initiate the call  .

Phonebook

Dialling Voice Dial Entries

Using Permission

From **Idle**  , select **Phonebook > Voice Command > Permission**  

With this function enabled a recalled phone number is automatically dialled without further intervention.

Repeat this process to disable the Permission function returning to Voice Dial recall only.

Editing the Voice Dial Entries

It is possible to add to, **play** or **delete** any of the Voice Dial entries. With a Voice Dial entry displayed:

  and use  to select **Add, Play** or **Delete**   to select the desired option

Add

To add a new Voice Dial entry.

Play

To listen to the recording of a Voice Dial entry.









Delete



To delete an entry





My Numbers

My Numbers is a convenient part of Phonebook where voice, fax and data phone number(s) can be stored and viewed. (☐)









Adding Numbers

- 1 From **Idle**  , select **Phonebook** > **My Numbers** 
 twice
- 2 Use  until **Create** is displayed in the pop up menu  
- 3 Enter the name - see "Text Entry" page 66, and use 

Note: If using T9® text input then move  before moving  otherwise an alternative word will be selected.

- 4 Enter the phone number   twice
- 5 Enter location number or select **Any**  







Viewing Stored Numbers

- 1 From **Idle**  , select **Phonebook** > **My Numbers** 

- 2 Use  to select **View** or **Detail** from the pop up menu  
- 3 If more than one number is available then use  to cycle through the listed numbers

Personalising Your Phone

Add a Start-up Greeting









A personalised greeting can be programmed for when the phone is switched on.

- 1 From **Idle**  , select **Personalise** > **Display Setting** > **Greeting**  
- 2 Use the text entry facility to add a greeting   twice - see “Text Entry” page 66



Displaying Animations

Animations can be displayed during the phone power on and off sequences







- 1 From **Idle**  , select **Personalise** > **Display Setting** > **Animation**  
- 2 Use  to cycle through the animated themes available
- 3 Use  to view
- 4   to select either the desired theme, or switch off the animation



Idle Screen Image

The idle screen can be changed to display colour downloaded images or Colour Themes.

To choose an image for the Idle screen:

- 1 From **Idle**  , select **Personalise** > **Display Settings** > **Idle Screen**
- 2 Use  to navigate select the required image
- 3 Use  to view image
- 4  









It is possible to view the selected image before fixing it to the Idle screen. When **View** is displayed in the secondary selection area  .

Media Folders

This option enables the user to manipulate the media files which have been downloaded from a third party source and are saved in the handset. Some of these can be used as ring tones, or Idle screen images or attachments to text messages.

Note: It is only possible to attach EMS format Animations/Pictures

To select an item from the Media Folder:

- 1 From **Idle**   select **Personalise > Media Folders**
 
- 2 Use  to select the media type  
- 3 Use  to select an object

Use  to view the selected file before making any changes to the file.









- 4   and use  to select **Rename**, **Delete** or **Delete All**
 

  at any time to return to the Media Folders sub menu

Colour Themes

The purpose of the Themes, is to provide alternative combinations of colours for the background and text.

To use a Colour Theme:

- 1 From **Idle**   select **Personalise > Display Settings > Colour Themes**  
- 2 Use  to preview the Colour Theme
- 3 Use  to select the required Colour Theme  



To return to the Idle screen  

Changing the Ring Tone

The ring tones of the phone can be changed to one of many pre-defined sounds, a downloaded ring tone or a voice ringer (voice recording used as a ring tone).







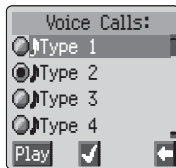

All voice, fax, data and messages can have a different ring tone.

To change the Ring Tone:

- 1 From **Idle**   select **Personalise > Tones > Ring Type**
 













Personalising Your Phone

- 2 Use  to select the call type to be adjusted  
- 3 Use  to select the required ring tone
- 4   to preview the ring tone
- 5   to confirm ring tone selection









Alternatively you can use the Melody Composer to generate a custom ring tone. See "Composing a Melody" page 27.

Recording a Voice Ringer

- 1 From **Idle**  , select **Personalise** > **Tones** > **Voice Ringer**  
- 2 Use  to select the appropriate voice ringer to be changed  
- 3  , start speaking into the microphone. The recording will stop automatically, or before if  is selected

To playback the recording use  to select the appropriate voice ringer  , select **Playback**  

Disabling/Enabling all Tones

- 1 From **Idle**  , select **Personalise** > **Tones**  
- 2  
- 3 Use  to select **Disable** or **Enable**  

When **Idle** is resumed the silent indicator icon () will be displayed

Download data ()

The Panasonic GD67 is able to use various downloaded data. The downloaded data is stored in the Media Folder and can be acquired via EMS, SMS or WAP. Details of this service are available on our website.

For further information see:

<http://www.panasonicbox.com>

Download Animations, Pictures & Melodies

Animation, Picture & Melody data can be downloaded using EMS, SMS (services supplied by a third party)

Download Animations





Animations may be downloaded to the phone using EMS.

This service is network dependent.

The service may not be available in all countries.

Downloaded animations are stored in, and retrieved from: **Personalise > Media Folders > Animations**

If an SMS or EMS has been received containing an animation:

- 1   to acknowledge receipt of the animation
- 2 Use  to select the SMS or EMS   twice

The Animation is now stored and can be selected as required.

Download Pictures

Pictures may be downloaded to the phone using WAP. Details of this service are available on our website.





This service is network dependent.

For further information see:

<http://www.panasonicbox.com>

The service may not be available in all countries due to regulatory restrictions so please check the above site for availability.

Downloaded Pictures are stored in, and retrieved from: **Personalise > Media Folders > Pictures** If an SMS or EMS has been received containing a Picture:

- 1   to acknowledge receipt of the picture
- 2 Use  to select the SMS or EMS   twice

The Pictures is now stored and can be selected as required.

Personalising Your Phone

Download Melody

Melodies may be downloaded to the phone using SMS or EMS. Details of this service are available on our website.





This service is network dependent.

For further information see:

<http://www.panasonicbox.com>

The service may not be available in all countries due to regulatory restrictions so please check the above site for availability.

When a message has been received containing a melody:

- 1   to acknowledge receipt of the melody
- 2 Use  to select the ring tone number to overwrite  
twice

The melody is now stored and can be selected as a ring tone.













Composing a Melody

From **Idle**  , select **Personalise** > **Tones** > **Melody Composer**  .

Using the following table as reference, enter the notes (from the choice of low, middle and high), rests, and the durations of each, to generate your composition.

Note: At any time during composing   to play back the current melody.

When the composition is complete   twice to save it.

Key	1st press	2nd press	3rd press	4th press	5th press
	C	C#	low C	low C#	high C
	D	D#	low D	low D#	high D
	E	low E	high E		
	F	F#	low F	low F#	high F
	G	G#	low G	low G#	high G
	A	A#	low A	low A#	high A
	B	low B			
					
					
	Rest				
	1/8	1/4	1/2	1/1	1/16
	Sharp				



¹ Indicates a note from the second octave

² Indicates "Sharp" is not available to these notes





Personalising Your Phone

Editing your Melody

Once the melody has been saved the following operations can be used for re-editing purposes:







-  to delete the character to the left of the cursor
- Use  to navigate the cursor around the screen
- Use the relevant keys to insert new notes/rests

Setting the Backlight Time

- 1 From **Idle** , select **Personalise** > **Display Setting** > **Backlight Time** 
- 2 Use  to cycle through the times available
- 3  to select the desired time

Changing the Language

It is possible to change the language that the phone uses for either display messages and/or text entry. ()

- 1 From **Idle** , select **Personalise** > **Language** 
- 2 Use  to select **Display Language** or **Tegic Language** (text entry) that you wish to change 
- 3 Use  to select the desired language 



Restoring the Default Phone Settings

Any personal settings can be returned to their factory default, with the exception of some features, such as the Phone Lock code and the Language.

- 1 From **Idle** , select **Personalise** > **Defaults** 
- 2  to restore the default settings

Phone Security

The phone features a number of security functions that protect against unauthorized use, and enable the user to restrict access to certain features - see "Using the PIN" page 12. It is recommended that all security codes are memorized. If it is necessary to make a note of any security codes, never write them in a way that they can be recognized by another person. If forgotten, contact the dealer for the Phone Lock Code or the Service Provider for PIN and PIN2.

Enabling Key Guard

The Key Guard function is used to prevent any keys from being accidentally pressed e.g. when the phone is being carried.

From **Idle**  , 3 times or  + Hold , select **Key Guard**,   twice.

When a call is received Key Guard will be disabled temporarily, allowing the user to press any key except  to answer the call. Emergency calls can still be made - see "Emergency Calls" page 10.

Note: When making emergency calls with the "Key Guard" enabled, there will be no audible or visual indication that the number is being dialled







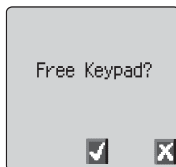





Disabling Key Guard

 any key,
When **Free** is displayed   









Changing the Security Codes

- 1 From **Idle**  , select **Phone Option** > **Security**  
- 2 Use  to select **Phone Lock**, **PIN** or **PIN2**  
- 3 Use  to select **Change**  















Phone Security

- 4 Enter the current code  
- 5 Enter the new code  
- 6 Verify the new code  

Restricting Calls

Call Barring



The Call Bar function is used to restrict certain outgoing and/or incoming calls. Call Bar is controlled by a security password that is supplied by the Service Provider. When updating or checking the status of Call Bar the phone must be registered with a network. Different Call Bar restrictions can be used for voice, fax and data calls. Any combination of call restrictions can be set.

- 1 From **Idle**  , select **Phone Option** > **Security** > **Call Bar**   twice
- 2 Use , select **Bar Voice**, **Bar Fax** or **Bar Data**   twice
- 3 Use  to select the level of call barring that needs to be applied and  
- 4 Enter Call Bar password and  



Barred Dialling

The Barred Dial function enables the user to bar all phone numbers pre-programmed in the SIM from being dialled on the phone. To use this function PIN2 is required.

- 1 From **Idle**  , select **Phone Option** > **Security** > **Barred Dial**  
- 2 Enter **PIN2**  

Fixed Dial



The **Fixed Dial** Store is part of Phonebook, but with additional security. When the security feature **Fixed Dial** is enabled it is only possible to make calls with phone numbers that are in the Fixed Dial Store.

When **Fixed Dial** is enabled any manually dialled phone numbers must match a phone number in the **Fixed Dial** Store.

To store, edit or delete a phone number in the Fixed Dial Store the Fixed Dial function must be enabled. With Fixed Dial enabled, all phone numbers can be added, edited or deleted as normal, but you will be prompted for **PIN2**.

“Wild” Numbers

Wild numbers are spaces that can be stored in a phone number. The “wild” numbers must be filled before the phone number is dialled. Used in conjunction with Fixed Dial calls can be restricted, for example, to a specific area by storing the area code of a phone and when recalled the remainder can be added. The “wild” numbers can be anywhere within a stored phone number.

- 1  + Hold  until is displayed to enter a wild number
- 2 When the phone number is recalled pressing a numeric key will fill in a “wild” number









Applications

Clock

This phone incorporates a clock with date/time, an alarm and a power on/off feature.







A second clock for dual time is also included - see “Second Clock” page .64

Initially Setting the Home Time

- 1 From **Idle**  , select **Applications** > **Clock Function** > **Clock Set** > **Home** > **Time Set**, use  to select Summer Time on or off,  
- 2 Enter the digits for the date in the format day/month/year   twice to accept the date
- 3 Enter the digits for the time   twice to accept the time







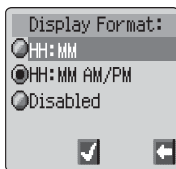



Setting the Clock Format









- 1 From **Idle**  , select **Applications** > **Clock Function** > **Clock Format** > **Display Format**  
- 2 Use  to cycle through the different clock and/or date formats or disable
- 3   to select the desired clock display type



Altering the Time/Date

- 1 From **Idle**  , select **Applications** > **Clock Function** > **Clock Set** > **Home** > **Time Set**  
- 2 Enter the digits in the format day/month/year
- 3   twice to accept the date
- 4 Enter the digits   twice to accept time















Setting the Clock for Summer Time

- 1 From **Idle**  , select **Applications** > **Clock Function** > **Clock Set** > **Home** > **Summer Time**  
- 2   to set Summer Time On or Off  

Setting the Alarm

If the clock hasn't been set, the user will be prompted to do so prior to setting the alarm.

There are four separate alarms, each of which may be set independently.

- 1 From **Idle**  , select **Applications** > **Clock Function** > **Alarm Set**  
- 2 Use  to select the alarm to be set  
- 3 Enter the digits for the time  
- 4 Use  to select the frequency of the alarm  
- 5 Use  to select the ring type  

When the alarm has been set, and the clock is displayed,  will be displayed when the phone is in Idle.

The alarm is activated in accordance with the current clock (Home or Second).

Muting the Alarm











When the set time is reached the alarm will sound and the display will flash with an alarm message. The alarm will sound for 30 seconds. If the alarm is due during a call, it will activate vibration alert.

To end the alarm:

 any key

















Applications

Disabling the Alarm

- 1 From **Idle**  , select **Applications** > **Clock Function** > **Alarm Set**  
- 2 Use  to select the alarm to be disabled   three times
- 3 Use  to select **Disabled**  

When disabled, following the same procedure will re-enable the alarm.

Adjusting the Alarm Time

- 1 From **Idle**  , select **Applications** > **Clock Function** > **Alarm Set**  
- 2 Use  to select the alarm to be adjusted  
- 3  + Hold  to remove the current alarm time
- 4 Enter the digits for the time   twice
- 5 Use  to select the frequency of the alarm  
- 6 Use  to select the ring type  

Setting a Power On/Off Time













The phone can be set to turn itself on or off automatically at a specified time using the Power On/Off feature. The procedure for setting/adjusting the Power On/Off automatically is similar to that for setting the time on the clock. For either setting or adjusting the time needed to select **Power On Time** or **Power Off Time** in the Clock Function menu.





Caution: Ensure that the setting of the Alarm or Power On function will not contravene any regulations whereby it may automatically power on when in an aircraft or medical facility etc. - see "Important Information" page i.

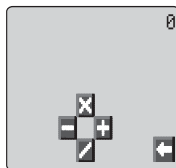

Calculator

The four function calculator will enable the user to perform simple arithmetic calculations (addition/subtraction/multiplication and division).

- 1 From **Idle**  , select **Applications** > **Calculator**  
- 2 Enter a number (maximum 10 digits) and it will be displayed on the upper right of the display. If a decimal point is required,  
- 3 Use   to select the arithmetic operation you wish to perform ( to multiply,  to add,  to divide,  to subtract)
- 4 Enter a number (maximum 10 digits) and it will be displayed next to the operation symbol



If   is used to select another arithmetical operation to perform, an intermediate calculation will be performed and the result displayed on the top line.









- 5   to complete the calculation when  is displayed in the left operation area

Currency Converter

The currency converter enables the user to convert from/to a home currency using a conversion rate that you enter.





From **Idle**  , select **Applications** > **Currency**  





Entering an Initial Conversion Rate

- 1  
- 2 Enter an abbreviation for the home currency (up to 3 characters)   twice
- 3 Enter an abbreviation for the foreign currency (up to 3 characters)   twice
- 4 Enter the currency conversion rate   twice

Applications







Converting a Value

- 1 Check the conversion rate is the one you require   twice
- 2 Enter the value to be converted   twice

The conversion rate will be retained in the phone once entered. The next time the convertor is used, the conversion rate / currency abbreviation can be edited while in the Currency /rate display.  , then use  to select **Edit**  

Swapping the Currency Conversion

When you have accepted the conversion rate and are ready to enter the value to be converted, you can swap the currencies to convert from the foreign currency into the home currency.

- 1  , use  to select **Swap**  
- 2 Enter the value for conversion   twice

Text Messages

It is possible to receive, display, edit and/or send single or concatenated text messages to mobile phones on the same network or any network that has a roaming agreement. Before the message is sent, the user will be informed of the number of text messages that will be sent if it is greater than one.

Setting the Phone for Short Text Messages

Before a message can be sent, it is necessary to enter the Message Centre number into Parameters (the Service Provider will supply the Message Centre number).











The Message Centre number may have been preprogrammed on the SIM.

Setting the Message Centre Number



From **Idle**  , select **Messages** > **Parameters** > **Message Centre**  .

Enter message centre number in international dial format – see “International Dialling” page 9.









Creating a Text Message



- 1 From **Idle**  , select **Messages** > **Create**  .
- 2  , use  to chose Text Entry mode from a pop up menu  
  to cancel the pop-up menu without changing text selection







Note:   will take the user directly to the Text Message main menu

Create a text message - see “Text Entry” page 66.



The Character menu is not available in “Numeric mode”. In text modes it may be accessed by  + Hold  -  or  , use  to select **Char. List** from the pop up menu,  .











Or in T9 mode  + Hold .

  to exit the character menu.

- 3 Use  to navigate through the message and add or delete text
- 4   twice

Text Messages

The user may be prompted to send the message. If the message is not to be sent  , the message will be stored.









- 5   and enter the destination phone number (or recall a number from the Phonebook) - see "Retrieve a Number" page 15
  twice
- 6 The user may be asked if delivery confirmation is required. If not required use  to select **No**  . If yes, use  to select **Yes**
 

The default setting for delivery confirmation can be enabled/disabled using the Report parameter in the Parameters menu.

Text Attachments





When creating a text message, it is possible to include attachments.
(Copyright permitting)

To include an attachment:

- 1 From **Create/Edit**  , from the pop menu, select **Insert**
- 2 Use  to make a selection from the pop-up menu and   to select.
- 3 Use  to select the required file to be inserted into the text body,
 

Receiving Text Messages

When a Short Text Message is sent to the phone, the message "Received 1 New Message" and the message indicator () will flash in the display, with an audible tone or vibration. This indicates that a new message has been received.

When **Read** is displayed   to read the message. Use  to navigate through the message and to identify the sender and the time the message was sent. With the phone number shown  
To dial the phone number.

Note: If the message indicator is displayed constantly (**does not flash**) this indicates that the message area is full and you will need to delete old messages in order to be able to receive new messages in the future.

Message Options

Reply to a Message

When a message is received and read the option to reply to the sender may be selected.

  twice. This will allow the user to create a reply message





Delete a Message

- 1  
- 2 Use  to select **Delete**   to delete the message

To enable the auto-deletion of messages - see "Parameters" page 42.











Edit a Message

- 1  
- 2 Use  to select **Edit**   to edit the message





 , this will give the option to send the edited message - see "Creating a Text Message" page 37.   if it is not necessary to send the message and it will be stored in the Send List.

Cut / Copy & Paste Message Text

This function allows the user to cut or copy message text from a user defined message or a user created message, into a new or existing message. It can also be used to paste text to a previously sent message - See "Edit a Message" page 39.

- 1 When message text is displayed,  , select **Cut** or **Copy**
 
- 2 Use  to position the cursor at the beginning of the text to be cut or copied  
- 3 Use  to highlight the required text  

The cut or copied text will remain in the phone memory until other text is cut or copied.

- 4 Select the required text screen for cut or copied text to be pasted into  
- 5 Select **Paste**  

To cut or copy text from a received message, select **Forw'd** and repeat steps 1 - 3.





Text Messages

Manage Messages Lists

All messages, whether sent or received, will mostly be stored in the phone until they are deleted. Selecting a stored message allows it to be replied to, edited or deleted.

Inbox

Messages received will be stored in the Inbox. A  in the receive list, indicates an unread message.

When reading a message the sender's information is displayed below the text.   to show the sender's ID (if available), the time the message was sent.   twice allows the user to reply to the message.

From the Inbox, it is possible for the user to Forward a received message, Extract text from a message and forward it or Chat with the sender of the message. See Chat SMS page 40.

Outbox







When a message has been sent or edited it will be stored in the Outbox.

Create

This allows the user to create a new message or reply to a received message.

Chat SMS

Chat, will enable the user to read sent and received messages on one screen when in Chat SMS mode with another party.



- 1 When reading a previously sent or received message,    to select chat
- 2 Enter the destination phone number,   
- 3 Enter your Nick name (up to 18 characters) - see "Text Entry" page 66.

It is now possible to Chat with the other party, providing they have the chat SMS facility on their phone. Enter your message - see "Text Entry" page 66.

When receiving a message in chat mode, the text will appear automatically above your previous message.

- 4  , select **OK** to continue the chat

If the phone is not in chat mode when receiving a reply to a chat message, it will be received as a normal sms. If a voice call is received when in chat mode, the phone will allow the user to accept the incoming call and return to chat mode at the end of the call.

- 5 To exit chat mode   

The last sent message will be stored in the Out box.











The last part of the received message will be stored in the In box.

All other messages from the latest chat, will automatically be deleted from the phone.

It is also possible to initiate chat mode from the Messages menu.

Cell Broadcasts

The user will need to specify the topic(s) of information that is to be received as broadcasts before they can be received. It is important that the user ensures the list is empty in order to receive optimum broadcasts.

- 1 From **Idle**  , select **Messages > Broadcasts > Topics**
 
- 2   to insert a new topic
- 3 Use  to cycle through the available topics
- 4   select **RX On** from the pop up menu
- 5   to insert the currently displayed topic into your broadcast list

Note: There are 3 Cell Broadcast options: **Not Receiving, Receiving and Receive and Notify Upon Arrival**

Message List

This is a store for the last received broadcast messages. Messages can be deleted from here.

Language

The language in which broadcast messages are displayed can be changed ().

Enabling/Disabling Cell Broadcasts

- 1 From **Idle**  , select **Messages > Broadcasts**  
- 2 Select **receive**  
- 3 Use  and select **Enable/Disable**  

Note: The pop menus may vary in appearance.







Text Messages

When enabled, following the same procedure will disable broadcasts.

When a low priority broadcast has been received,  will be displayed on the Idle screen and a notification tone may sound (if enabled) . If a high priority broadcast is received, it's text content will be displayed on the idle screen

Notify Tone

To enable the notification tone for Cell Broadcast:

- 1 From **Idle**   select **Messages > Broadcasts > Notify Tone**  
- 2 Use  to highlight **Enable**
- 3   to select

To disable the notification tone, follow the same procedure and select **Disable** in the **Notify Tone** menu

Parameters

From **Idle**  , select **Messages > Parameters**  

The following parameters can be set:

Recipient Group



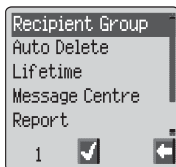

There are 5 different recipient groups, allowing you to store up to ten destinations in each.

Recipient Group enables the user to pre-define the destination of text messages.



Setting Recipient Group

1 From **Idle**  , select **Messages > Parameters > Recipient Group**  

To enter a new name,   select **Select** and enter the name of the recipient from a name stored in one of the phone books, See Retrieve a Number page 15.   twice, select **OK** from the pop up menu  

Auto Delete

When set, will erase messages automatically:

Received Read - will overwrite the oldest read message.

Received Any - will overwrite the oldest message, even though it may not have been read.

Lifetime

This is the duration that your message is stored at the Message Centre. Delivery attempts will be repeated until the message has been delivered or the Lifetime expires.

Message Centre

Allows the Message Centre phone number to be edited - see "Setting the Phone for Short Text Messages" page 37.

Report

When your message has been delivered a confirmation will be received if Report is set to Yes.

Protocol

The Message Centre may be able to convert the message to the format specified by the selected protocol.

Call Information







Recent Numbers

Recently dialed phone numbers will be stored in Last Dialed.



If Caller Identification is available the caller's phone number, for an answered call will be stored in the **Answered** menu and an unanswered call will be stored in the **Unanswered** menu.

If Caller Identification is not available then calls will still be stored but will have the date and time attributed to them.

When the store is full the next phone number will overwrite the oldest.

- 1 From **Idle**  
- 2 Use  to select **Last Dialed, Answered** or **Unanswered** 
- 3 Use  to select the phone number (or name) you wish to redial  

You can edit or delete the phone number before dialling – see “Editing Phonebook Entries” page 16.

If you wish to store the selected number in Phonebook,   while the number is displayed – see “Store a Number” page 14.

Calling the Last Dialed Number



To redial your last called phone number   twice.

Returning an Unanswered Call

When the display shows that you have received calls but not answered them.

- 1  



The last caller's phone number will be displayed if it is available.

- 2 Use  to select the phone number you wish to dial
- 3  

Call Duration

- 1 From **Idle**  , select **Phone Option > Call Service > Calls**  

Note: The Calls function is SIM dependent (). If the SIM does not support this function then items under Calls menu will be found directly under Call Service menu.

- 2 Use  to select one of the functions described below, and  

The **Last Call** function will display the duration and call charge if available, of the last call, when in Idle mode. Times are indicated as: hours (0-99), minutes (0-59), seconds (0-59) - HH:MM:SS.

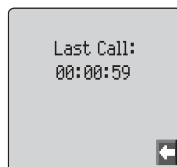



The All Calls function displays the accumulated duration and call charge, if available, of Incoming and Outgoing calls. The lock code or PIN2 is required to reset the timer and call charge.

GPRS Call Duration

- 1 From **Idle**  , select **Phone Option > Call Service > Connections**  

Note: The Connections function is SIM dependent ().

- 2 Use  to select one of the functions described below, and  

The Last Connection function will display the duration and amount of data transfer of the last call. Times are indicated as: hours (0-99), minutes (0-59), seconds (0-59) - HH:MM:SS.

The All Connections function displays the accumulated duration and amount of data transfer. The lock code or PIN2 is required to reset the timer.

The Call Priority function is used to determine whether or not an incoming voice call should interrupt a data call.



Call Information

Call Charges





To maintain control over the cost of calls that are made, the phone can be set to restrict use to a finite number of units overall. (☐)

Setting the Unit Price

Firstly, a price per unit must be entered. This is the cost that the Service Provider charges for one unit of call time. (☐)







- 1 From **Idle**  , select **Phone Option** > **Call Service** > **Service Charges** > **Price/Unit**  
- 2   to edit the values

At this point you will be asked to enter your PIN2 or Lock code  .



- 3 Enter a currency unit (up to three characters) e.g. GBP  
twice
- 4 Enter a price   twice

Setting the Maximum Unit Level

This function allows the user to pre - determine the maximum cost of calls made. (☐)

- 1 From **Idle**  , select **Phone Option** > **Call Service** > **Service Charges** > **Max Cost**  
- 2   twice to edit the values









At this point you will be asked to enter your PIN2 or lock code  .

- 3 Enter a value (number of units) which is to be the maximum permitted, and the corresponding cost will be displayed
- 4   twice to accept

Note: The duration of one unit may vary during the day, peak and off-peak times. Therefore, the call charge can be calculated accordingly. However, call charge information may not give an accurate reflection of the tariffs charged by your Service Provider.

Setting a Warning Level

A warning can be set as an indication that the maximum cost is about to be reached. (☐)

- 1 From **Idle**  , select **Phone Option** > **Call Service** > **Service Charges** > **Warning at**  
- 2   twice to edit the value
- 3 Enter a value (in units) at which time you would like the warning to sound   twice

Call Identification











In the Call Service menu, the Caller's ID and Withhold ID functions allow you to check the status of whether a Caller's Identification is sent or can be received. (Withhold ID )

Note: When checking the status the phone must be registered with a network.

Advanced Operation

Diverting Calls

Voice, fax and data calls can be diverted using different circumstances and to different numbers. For example you may wish voice calls to be diverted to Voicemail in the event that the phone is switched off.

- 1 From **Idle**   select **Phone Option** > **Call Divert** 
- 2 Use  to select the type of calls to divert,   twice
- 3 Use  to select the circumstances to initiate the divert  
- 4 Enter phone number to divert to   twice

When a divert situation is enabled the divert icon (↗) is displayed.

When updating or checking the status of **Call Divert** the phone must be registered with a network. ()

Holding Calls and Call Waiting

Holding a Call



During a call:

- 1  
- 2 Use  to select **Hold**  

Resuming a Call

- 1  
- 2 Use  to select **Resume**  

Making a Second Call

- 1 Enter phone number (or recall from Phonebook – see “Retrieve a Number” page 15)
- 2  

The first call will be placed on hold.

Receiving a Second Call

A second call can be received, if Call Waiting is switched on. This is enabled from the **Phone Option > Call Service** menu. It is not possible to have more than one fax or data call. All voice calls must be ended before you can make or receive a fax or data call. (☐)

Accept a Second Call





- 1  
- 2 Use  to select **Accept**  

The current call will be placed on hold.

Reject a Second Call



- 1  
- 2 Use  to select **Reject**  

End Current Call and Receive Second Call

- 1   with a waiting call
- 2  any key except  or 

Operation During Two Calls

Swapping Between Calls

The   prompt in the display screen, indicates the current call

- 1  
- 2 Use  select **Swap**  

End Current Call

- 1  
- 2 Use  to select **End**  

The held call will remain held.

End Both Calls



Advanced Operation

Call Transfer

With two calls connected, Call Transfer enables the user to connect them together ending your connection, leaving the other parties to talk together.

( )



When two calls are in use:

- 1  
- 2 Use  to select **Trans.**  

The two calls will be connected to each other and your call will be ended.

Note: Two call transfer cannot be utilized while in Multi-party mode.

Multi-party Calls

A Multi-party call enables three to five people to be in conversation at the same time. It is possible to swap between a Multi-party call and another call in the same way as with two separate calls. ( )

Enabling Multi-party

With two calls connected (one active, one on hold):

- 1  
- 2 Use  to select **Merge**  

A Multi-party call has been enabled, all three people will be able to talk to each other.

Adding to Multi-party







It is possible to add to the Multi-party call (up to a maximum of five). Either by making a call or accepting an incoming call. The call can then be merged into the Multi-party.

Note: When making a call or accepting an incoming call the Multi-party call will be placed on hold. The callers in the Multi-party call can continue to communicate with each other while on hold.

Splitting a Multi-party

The user can select an individual from the Multi-party and remove their connection. This enables you to talk privately without the participation of the rest of the Multi-party.

During a Multi-party call:

- 1 
- 2 Use  to select **Option** 
- 3 Use  to select a caller in the Multi-party
- 4 
- 5 Use  to select **Split** 







The selected caller will be split from the Multi-party call and the Multi-party call will be placed on hold (the remaining Multi-party callers can still communicate).

Ending Multi-party Calls

The user can either select an individual in the Multi-party and end the call or end the entire Multi-party call. If a call is held, or another call is incoming then an individual call cannot be ended.



Ending a Single Connection

During a Multi-party call

- 1 
- 2 Use  to select **Option** 
- 3 Use  to select a caller in the Multi-party
- 4 
- 5 Use  to select **End** 

Ending all Connections

During a Multi-party call:







  to end all the calls at once

Advanced Operation

Changing to a New Network

When not in your home Country / Region, the user may use a network that is not directly subscribed to, this is called ROAMING. National Law may not permit roaming in your home region.

The New Network function is used to manually select a network that is available in your current location.

- 1 From **Idle**  , select **Phone Option > Network > New Network**  
- 2 Use  to select one from the list of available networks  

If you cannot register with the selected network, that network will be greyed out.

When the Search Mode is set to Automatic the phone will automatically reselect a new network in order to maintain optimum network availability. With the Search Mode set to Manual the phone will only use a selected network. If coverage is lost another network should be selected.

The Network List is used when the Search Mode has been set to Automatic. The location numbers in the Preferred Network List show the search priority.

Selecting Insert stores a new network in the currently displayed location and then moves other networks down, Edit overwrites the old network with a new one, and Add stores a new network at the end of the list.











Schedule

The Scheduler can be used to register reminders for personal events as well as planning holiday periods.





Caution: Ensure that any settings made in the Scheduler will not contravene any regulations whereby the phone may automatically power on when in an aircraft or medical facility etc. - see “Important Information” page i.

Creating a Reminder

From **Idle**  , select **Schedule**  

- 1 Use the Navigation key () to select the date for your reminder
- 2   twice to create a new entry when the required date is highlighted,   twice
- 3 Enter the digits for the time using 12 or 24 hour clock   twice
- 4 Use  to select the frequency of the reminder  



When selecting **Daily**, **Weekly** or **Yearly** you will be given the option of using the “Repeat Count”, which allows you to set the frequency of the alarm.

- 5 Enter the memo for the reminder – see “Text Entry” page 66,   twice
- 6 Use  to select a ring type for the reminder  



Note: To indicate that a reminder has been set, the date will appear inverted.





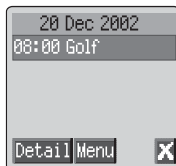







Viewing Reminders

When in the **Schedule** menu, select the required date using the Navigation key ()   to view reminders for that date



















Schedule

Deleting Reminders

- 1 From **Idle**  , select **Schedule**  
- 2 Use  to select the required date of the reminder  
- 3 Use  to select the reminder to be deleted  
- 4 Use  to select **Delete**   twice

Setting a Holiday Reminder





















- 1 From **Idle**  , select **Schedule**  
- 2 Use the Navigation key () to select the day of your holiday 

- 3 Use  to select **Function**  
- 4 Use  to select **Holiday Set**  
- 5 Use  to select **Day, Day of the week** use  to select a day 
 to update the **Holiday List**

Repeat process for each day of holiday as required.















Note: To indicate that a holiday reminder has been set, the date/s will be emboldened

Deleting Holiday Reminders

To delete holiday reminders:

- 1 From **Idle**  , select **Schedule**  
- 2 Use the Navigation key () to select the day of your holiday to be deleted  
- 3 Use  to select **Function**  
- 4 Use  to select **Holiday Set**  
- 5 Use  to select **Holiday List**,   to select date for deletion
  twice or to delete all holiday Reminders use , select **All Clear**   twice

Jump to Date

- 1 From **Idle**  , select **Schedule**  
- 2  
- 3 Use  to select **Jump**  
- 4  + Hold  to remove the current date
- 5 Using  -  enter the date (using chosen date format) to which you want to 'jump' to   twice



Games

Downloadable Games ()

The Downloadable Games menu enables the user to use one factory embedded game (Wallbreaker) and download another game from the games catalogue.

Note: A downloaded game will overwrite the previously downloaded game.

From **Idle**  , select **Games** or select **Games** from **Applications**

The games banner will appear on the screen. To skip the banner introduction  

  and use  to scroll through the games menu

  to make a selection



Follow the screen prompts to navigate through the games menu.

Full instructions on downloading and playing the range of games can be found in the games menu.

Embedded Games ()

To enter the Embedded games menu:

 , select **Games** or select **Games** from **Applications**

Use  to select a game  

Follow the prompts in the pop up menu for playing instructions and game options

WAP Browser

The phone's WAP (Wireless Application Protocol) Browser enables the user to access Internet services supported by the network, such as news, weather reports, sport etc.

Browser Settings

Before Internet services can be accessed, the SIM must be data enabled and the relevant configuration information, entered into the phone.

These settings may have been pre-programmed by the network operator.

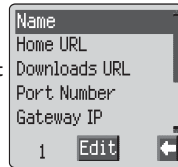

Note: Modifying previously entered settings can cause failure of the Browser.

- 1 From **Idle** select **Browser** > **Browser Setting** > **Server Setting**
- 2 Two servers may be setup on the phone. Use to select one or other of the server settings
- 3 Use to select **Edit**

A list of configuration parameters will be displayed. The parameter **Name** will be highlighted and **Edit** will be displayed.

- 4
- 5 Enter the name of the WAP server twice
- 6 Use to select each of the other parameters in turn, edit the information twice
- 7 After all parameters have been entered, to return to the previous menu level
- 8 Select the server setting that you have just edited . Use to select **Set**

Record your WAP settings in the table at the rear of this booklet for easy reference.

Activating the Browser

To activate the Browser, either:

From **Idle**  , select **Browser > Start Browser**  

The first time that the browser is activated there will be no content. Each time the browser is activated, the last page viewed from the previous WAP session will be recalled. (Cache is the phone's memory that stores content downloaded in the past). At the start of a WAP session, the browser content may be retrieved from the cache. (At this stage the browser will remain off line) When data is required from the WAP server, the user will be prompted to **Start a data call**. If **Yes** is selected, the phone will go on line and the phone will go to the home page. (as defined by the network operator).



Navigating Content

Use the Navigation key () to scroll through the content on the screen as follows:

Use  to scroll up/down on the current page





Use  to return to the previous object

Use  to return to the next selectable object

When linked text (underlined text) is highlighted   to load the page represented by the link.

The Browser Menu

The Browser also contains its own menu which is applicable when content is currently being displayed (either on-line or off-line).

To access the Browser menu   to select the browser icon in the top left of the screen,  , or, while in the browser, it can be accessed by  + Hold 

This menu is used as follows:

Back

Returns the user to the Browser Start Up menu

Home

Displays the Home URL content as defined by the network operator.

Exit

Deactivates the Browser.

Mark Site

Used to mark a location to return to later

Bookmarks

Use, add, delete and rename bookmarks.

Inbox

Used to retrieve a text message

Save Image

To save an image from the browser

Reload

Will reload and update the current page.

Settings

Allows the user to select the home URL, and allows the user pre-determine the functionality and speed of the keys. For example: the scroll speed. Access to the **Security & Advanced** menus is also available.











About

Provides information about the type of browser and security options

Using Bookmarks

Adding to the Bookmarks menu is gained via the "In Browser" menu. Frequently accessed pages may be bookmarked to save time. This prevents the need to re-enter the URL each time.

Adding a Bookmark

























- 1 To access the Browser menu   to select the browser icon in the top left of the screen,   or, while in the browser, it can be accessed by  + Hold 
- 2 Use  to select **Mark Site**
- 3 Use e to select either Title or URL
- 4 Use  to confirm **Title & URL** to be stored. Scroll down until Save is displayed in the primary selection area and  

WAP Browser















Recalling Pages Using Bookmarks

- 1 To access the Browser menu   to select the browser icon in the top left of the screen,   or, while in the browser, it can be accessed by  + Hold 
- 2 Use  to select **Bookmarks**  
- 3 Use  to select the relevant bookmarks from the list,  

Renaming a Bookmarks

- 1 To access the Browser menu   to select the browser icon in the top left of the screen,   or, while in the browser, it can be accessed by  + Hold 
- 2 Use  to select **Bookmarks**  
- 3 Use  to select the relevant bookmark from the list,  
- 4  
- 5 Use  to select the area to be edited/ renamed  
- 6   to cancel required text and re-entre text using key pad.
See "Text Entry" page 66
- 7   to confirm edit
- 8 Use  to scroll down until Save is shown in the Primary selection area  

Deleting Bookmarks

- 1 To access the Browser menu   to select the browser icon in the top left of the screen,   or, while in the browser, it can be accessed by  + Hold 
- 2 Use  to select **Bookmarks**  
- 3 Use  to select the relevant bookmark from the list,  
- 4 Use  to select **Delete**  

Deactivating the Browser















The Browser can be deactivated as follows:

When browsing on-line   to review cache off line.

When browsing off-line   to return to Idle mode.

Setting the Linger Time

The phone will be automatically disconnected from the WAP server after a set period of non-interaction. This period is defined in seconds by the Linger Time setting.

- 1 From **Idle**  , select **Browser > Browser Setting > Linger Time**  
- 2 Use  to select Bearer Type  
- 3 Use  to select value  
- 4  + Hold  to remove the current linger time, then re-enter the value required (in seconds)   twice

Additional Features

Desktop Handsfree

Desktop Handsfree enables you to hold a conversation without having to hold the phone to your ear.

Note: Do NOT hold the phone to your ear in Handsfree mode.

Swapping Between Handsfree and Handheld Calls

During a Handheld call:

- 1  
- 2 Use  to select **H'free**  

During a Handsfree call:

  twice to revert for Handheld operation

Answering a Call Handsfree:

To answer a call using Handsfree  + Hold 

Voice Memo

You can record a two-way conversation during a call. If a different SIM is installed any voice memos will be lost.



Caution: Security of a recorded message is your responsibility. You **MUST** ask for the other party's consent before recording.

Record a Voice Memo

During a call:



 
Use  to select **Memo**  

A tone will sound when recording starts. When the recording stops a tone will sound.

If you   while recording a voice memo, recording will stop but no tone will sound to either party.

Play Back a Voice Memo

From **Idle**  , select **Applications > Voice Memo Play > Playback**  

To stop playing,   twice

The Note Pad function is available during playback - see "Note Pad" page 64.

Volume Control During Playback

While playing back:

Use  to adjust the volume of the voice memo

Delete Memo

From **Idle**  , select **Applications > Voice Memo Play > Delete**   twice

DTMF Tones





DTMF tones can be sent during conversation. These are often used to access voice mail, paging and computerised home banking. For example, you may need to input a number to remotely access voice mail messages. A phone number may be stored in the Phonebook with DTMF tones, allowing the number to be dialled upon recall and the DTMF number to be sent automatically.



Send DTMF Tones During a Call

Enter digits (, ,  and )

Pause Dial

Using pauses allows you to send DTMF tones automatically.

- 1 Enter phone number
- 2  and hold  until a **P** is displayed at the end of the phone number entered
- 3 Enter DTMF digits after the pause, e.g. enter the number to access voice mail messages.
- 4  

When the call is successful DTMF tones will be sent after 3 seconds or   to send the DTMF tones manually.

If the DTMF tones are unsuccessful then the destination of your call may require that the length of the tones be increased.

Additional Features

- From **Idle**  , select **Personalise** > **DTMF Length** 
- Use  to select **Long**  

Note Pad

During a call numbers can be entered which you may wish to dial when the call has ended.

During a call:







- Enter phone number
- When the call has ended   to call that number

To store in Phonebook,   while the number is displayed – see “Store a Number” page 14.

Second Clock

The Second Clock can either be set to auto-adjusting, whereby the second time will be automatically set from the code of the current network, or a specified time difference can be set manually.







Setting Clock Display

- From **Idle**  , select **Applications** > **Clock Function** > **Clock Format** > **Display Pattern**  
- Use  to select **Second Time** or **Home Time**  





Setting Auto Adjustment

If traveling to a country / region which has a roaming agreement with the users' home network, the Second Clock will be automatically adjusted. However, for countries / regions which have several time zones in the same area manual adjustment is required.







- From **Idle**  , select **Applications** > **Clock Function** > **Clock Set** > **Second** > **Auto Adjustment** > **Home area** 
- Use  to select your home area  

Enabling Auto Adjustment

From **Idle**  , select **Applications > Clock Function > Clock Set > Second > Auto Adjustment > Auto Adjustment**
 

Repeat to disable Auto Adjustment.

Setting Manual Adjustment

- 1 From **Idle**  , select **Applications > Clock Function > Clock Set > Second > Time Difference**  
- 2 Use  to select the time difference required   to set the value

Setting Summer Time

From **Idle**  , select **Applications > Clock Function > Clock Set > Second > Summer Time**  

Once enabled, following the same procedure will disable Summer Time.

Accessory Related Features

When Auto Answer is switched on, and Personal Handsfree is connected, a call will be answered without pressing any keys. Any call waiting should be answered in the normal way.

See the documentation provided with the relevant Accessory for operation details.

Text Entry

The phone provides a means for entering alphanumeric characters to enter details into the Phonebook, to create text and e-mail messages etc. This section details the characters that can be entered and the relevant keys to press.

Text Mode					
Key	T9®	Normal (ABC)	Greek (ΑΒΓ)	Extended (ΑΑΑ)	Numeric (0 - 9)
	Alternatives	+ _	+ _	+ _	0+P_
	Punctuation	.@/:;*#+-“, ! ?¿_()[]{}’&%%^~ ◇=ε.£\$¥&85			1
	abc	ABCabc	ΑΒΓ	ΑΑΑΒΒΒCÇçäää#äabc	2
	def	DEFdef	ΔΕΖ	DEÉFdeééf	3
	ghi	GHIghi	ΗΘΙ	GHIghi i	4
	jkl	JKL_jkl	ΚΑΜ	JKL_jkl	5
	mno	MNOmno	ΝΞΟ	MNNOöømññïoöøö	6
	pqrs	PQRSpqrs	ΠΡΣ	PQRSpqrsß	7
	tuv	TUVtuv	ΤΥΞ	TUÜVtuüüv	8
	wxyz	WXYZwxyz	ΧΨΩ	WXYZwxyz	9
	Shift/Lock*	Shift/Lock*		Shift/Lock*	✕
	Space	Space	Space	Space	#

* once to enter a single capital letter (subsequent characters will be lower case). twice acts as a keyboard CAPS LOCK function and subsequent characters will be uppercase. a third time, to return to lowercase character entry.

Alternatively, + Hold any of the numeric keys to enter the character menu, which allows the user to navigate around the menu () until the required character is highlighted. to select.

to return to the message screen.

T9[®] Text Input

Using this mode of text entry dramatically reduces the number of key presses required:

Press a key once for any letter you require on that key. The desired letter may not be displayed. Continue pressing other keys until the end of a word is reached; then check that the word has been typed correctly before continuing on to the next word.

If the combination of letters typed has produced a word which is not the one you require, press  repeatedly until the correct word is displayed. Continue to the next word.



If the word you require is not in the internal dictionary (i.e. It is a proper noun or a rarely used word) then it should be entered using the Normal (ABC) mode.

Other Text Modes

To access any of the other text entry modes use  to cycle through until the desired mode is displayed in the Information Area.

When using Normal (ABC), Greek (ΑΒΓ) or Extended (ΑΆĂ) text entry modes, each time a key is pressed in quick succession it will display the next character available on that key. Releasing the key, or pressing another key will enter the currently displayed character and the cursor will move to the next position.

Editing Text

Pressing  will move you up or down one text line (or field in Phonebook). Pressing  will move you left or right one character. When the cursor is moved over a character and another key pressed this will insert the new character immediately before the selected character. Pressing  will delete the character to the left of the cursor or delete the current line when pressed and held.

Trouble Shooting

Trouble Shooting

Should any problem persist contact your dealer.

Problem	Cause	Remedy
Phone will not switch on		Check that the battery is fully charged and correctly connected to the phone
Extremely short battery life for a new battery	The network you are using and the condition of the battery can affect battery life	
Short battery life for an old battery	The battery has worn out	Replace with a new fully charged battery
The charging indicator does not light, the battery level indicator does not appear and the phone cannot be switched on when charging	The battery is not attached to the phone or when the battery has been deeply discharged the phone will take a short time until the indicator lights	Leave the phone charging the battery for a few minutes before the indicator is lit and attempting to switch it on
Battery fails to charge	The battery is not attached to the phone	Ensure the battery is fitted to the phone prior to commencing charging.
	Battery has been connected to the phone after the Fast Travel Charger has been switched on	

Trouble Shooting

Calls cannot be made	The phone is locked	Unlock the phone
	Outgoing calls are barred	Disable the outgoing call barring, or barred dial
	The phone is not registered to a network	Move to a coverage area and operate your phone after it has registered with a network.
Calls cannot be made from Fixed Dial Store		<p>Check your SIM supports Fixed Dial</p> <p>Check if the Fixed Dial is switched on</p> <p>Check the phone number is stored in the Fixed Dial</p>
Calls cannot be received	The phone is not switched on	Switch the phone on
	Incoming calls are barred	Disable the incoming call barring
	The phone is not registered to a network	Move to a coverage area and operate your phone after it has registered with a network.
Emergency calls cannot be made	You are not in a GSM coverage area	Check that the antenna symbol  is displayed - move to a coverage area and operate your phone when the antenna symbol is displayed
Phone numbers cannot be recalled from Phonebook	The phone is locked	Unlock the phone
	Phone number has been restricted	Switch off restriction

Trouble Shooting

Important Error Messages

These are some of the most important error messages which may be displayed:

Area Not Allowed	Roaming in the selected area is not allowed
Network Not Allowed	Roaming with the selected network is not allowed
Security Failure	The network has detected an authentication failure because your SIM is not registered with that network - contact your Service Provider
SIM Blocked / Contact Service provider	The SIM is blocked because one of the PIN/PIN2 unblocking keys (PUK/PUK2) has been entered incorrectly ten times - contact your Service Provider
SIM Error	The phone has detected a problem with the SIM - switch the phone off and then back on; if the message is still displayed contact your Service Provider
SIM Invalid	The SIM has failed one or more of the SIM personalisation checks - contact your Service Provider
Function Unavailable	The selected feature is either not supported by the SIM or is not available with the current subscription - contact your Service Provider
PIN2 Invalidated	The PIN2 is blocked permanently because the wrong PUK2 has been entered ten times, services controlled by PIN2 cannot be used - contact your Service Provider
Message Rejected Store Full	A message has been received but the message store is full - to receive messages, delete some of the currently stored messages or set messages to Auto Delete
Phone Number Too Long (Max:20)	The edited or newly created Phonebook number is too long for the SIM
Warning Store Full Continue?	The message area is full. Your messages cannot be stored until some of the currently stored messages are deleted

Trouble Shooting

Verification Failure	On changing the phone lock code, verification of the new code is incorrect - retry changing the lock code with correct verification
Incorrect Lock Code	Disabling or enabling the lock code has failed due to incorrect entry of the lock code - re-enter lock code
Incorrect PIN / PIN2 / PUK / PUK2	The entered code is incorrect - re-enter code correctly
Auto Redial List Full	Redial list of unsuccessfully dialed numbers is full - switch the phone off and then on again

Glossary of Terms

APN	Access Point Name. Directs the user to the gateway or the required service.
Cut	Permanently removes selected text from short text message
Copy	Copies selected text from short text message without removing it from the original message
CHAP	Challenge Handshake Authentication Protocol. A security feature for the GPRS network.
DTMF Tones	Dual Tone Multi-Frequency tones allow you to communicate with computerised phone systems, voice mailboxes etc.
EMS	Enhanced Message Service. Upgraded feature of Text Messages
GPRS	General Packet Radio Service. The Technology the phone uses.
GSM	Global System for Mobile Communications. The name given to the advanced digital technology that your phone uses.
Network Operator	The organization responsible for operating a GSM network.
PAP	Password Authentication Protocol. A security feature for the GPRS network.
Password	Used for the control of the Call Bar. Supplied by your Service Provider.
PIN	Personal Identification Number used for SIM security. Supplied by your Service Provider. If the PIN is entered incorrectly 3 times, the PIN will be blocked.
PIN2	Personal Identification Number used for the control of Fixed Dial Store and Call Charge metering. Supplied by your Service Provider. If the PIN2 is entered incorrectly 3 times, the PIN2 will be blocked.

Glossary of Terms

PUK/PUK2	PIN/PIN2 Unblocking Key. Used to unblock the PIN/PIN2. Supplied by your Service Provider. If the PUK/PUK2 is entered incorrectly 10 times, the PUK/PUK2 will be blocked.
Registration	The act of locking on to a GSM network. This is usually performed automatically by your phone.
Roaming	The ability to use your phone on networks other than your Home network.
Service Provider	The organization responsible for providing access to the GSM network.
SIM	Subscriber Identity Module. A small smart-card which stores unique subscriber and user-entered information such as Phonebook and Short Messages. Supplied by your Service Provider.
WAP	Wireless Application Protocol. The communication standard which enables you to download resources from the Internet to your phone

Specifications

Specifications

Phone (Including Battery)*

Type	GSM900 Class 4 GSM1800 Class I
Temperature Range	
Charging	+5°C - +43°C
Storage	-20°C - +60°C
Weight	81g*
Dimensions (mm)	
Height x Width x Depth	109 x 45 x 20
Supply Voltage	3.7V DC, 690mAh Li-ion
Standby Time (hrs)	From 60 - 190
Talk Time (hrs)	From 1.5 - 6.5
Charge Time (Phone off)	Up to 85m (Fast Travel Charger) Up to 84m (Car Charger)
Antenna	Internal
SIM Type	3V only

Phonebook Memory	200 + SIM
Animation Themes	2
Voice Memo	1 x 16 seconds
User Composed Melody	One
Download Melody	Up to 5
Download Logo	Up to 5
Recordable Ringer	2 x 10 seconds
Games (-)	Up to 2
Backlight	1
Ring tones	23 Fixed & Variable
Scheduler	Up to 100 Entries
Alarms	4

Note: Charge time will be longer when the phone is turned on. Battery life is affected by the network being used and the condition of the battery. Talk and standby time will be dependant upon network conditions, SIM, back light usage and battery condition.

EU Warranty

EU/EEA - Wide guarantee is applicable in the EU/EEA and Switzerland.

Panasonic GSM European Service Guarantee Conditions

Dear Customer,

Thank you for buying this Panasonic digital cellular telephone. The Panasonic GSM European Service Guarantee only applies while traveling in countries other than where the product was purchased. Your local guarantee is applicable in all other cases. If your Panasonic GSM telephone requires service while abroad, please contact the local service company shown on this document.

The Guarantee

The applicable period of the European wide guarantee for GSM is generally 12 months for the main body and 3 months for the rechargeable battery. With respect to a product used in a country other than a country of purchase, notwithstanding what is stated in the conditions below, the customer will benefit, in that country of use, from these guarantee periods of, respectively, 12 and 3 months, if these conditions are more favorable to him than the local guarantee conditions applicable in such country of use.

Conditions of Guarantee

When requesting guarantee service the purchaser should present the warranty card together with proof of purchase, to an authorized service centre.

The guarantee covers breakdowns due to manufacturing or design faults; it does not apply to other events such as accidental damage, however caused, wear and tear, negligence, adjustment, modification or repair not authorized by us.

Your sole and exclusive remedy under this guarantee against us is the repair, or at our option the replacement, of the product, or any defective part or parts. No other remedy, including, but not limited to, incidental or consequential damage or loss of whatsoever nature shall be available to the purchaser.

This is in addition to and does not in any way affect any statutory or other rights of consumer purchasers. This guarantee applies in countries shown on this document at the authorized service centres detailed for that country.

UK

Service Centres in England
Tel. +44 (0) 8705 159159

IRL

Service Centres in Ireland
Tel: +353 (0) 1 2898333

D

Panasonic Service Center Dresden
SERKO GmbH
Großenhainer Straße 163
01 129 Dresden
Tel. +49 (0)351/ 85 88 477

Panasonic Service Center Cottbus
Petsch Kundendienst GmbH
Am Seegraben 21
03058 Gross-Gaglow
Tel. +49 (0)355/ 58 36 36

Panasonic Service Center Leipzig
KES Keilitz-Electronic-Service GmbH
Föpplstraße 19
04347 Leipzig
Tel. +49 (0)341/ 244 33 33

Panasonic Service Center Chemnitz
WPS Rundfunk- u. Fernsehservice GmbH
Fietzenstraße 16
09130 Chemnitz
Tel. +49 (0)371/ 40 10 359

Panasonic Service Center Berlin
SERKO GmbH
Schwedter Straße 34a
10435 Berlin
Tel. +49 (0)30/ 44 30 3221

Panasonic Service Center Berlin
RUESS SYSTEMS
Thrasoltstraße 11
10585 Berlin
Tel. +49 (0)30/ 342 2013

Panasonic Service Center Rostock
warnow electronic service gmbh
An der Jägerbäk 2
18069 Rostock
Tel. +49 (0)381/ 82 016

Panasonic Service Center Hamburg
ELVICE Service GmbH
Spaldingstraße 74
20097 Hamburg
Tel. +49 (0)40/ 23 08 07

Panasonic Service Center Rendsburg
FERNSEH-DIENST B&W Service GmbH
Kieler Straße 41
24678 Rendsburg
Tel. +49 (0)4331/ 14 11-0

Panasonic Service Center Bremen
COM Elektronik Service GmbH
Rübekamp 50
28219 Bremen
Tel. +49 (0)421/ 691 80 69

EU Warranty

Panasonic Service Center Hannover
COM Elektronik Service GmbH
Vahrenwalder Straße 31 I
30179 Hannover
Tel. +49 (0)511/ 37 27 91

Panasonic Service Center Magdeburg
SERKO GmbH
Ebendorfer Chaussee 47
39128 Magdeburg
Tel. +49 (0)391/ 289 90 69

Panasonic Service Center Düsseldorf
VTH GmbH
Kölner Straße 147
40227 Düsseldorf
Tel. +49 (0)211/ 77 90 25

Panasonic Service Center Essen
Bernd van Bevern GmbH
Heinrich-Held-Straße 16
45133 Essen
Tel. +49 (0)201/ 84 20 220

Panasonic Service Center Osnabrück
Petsch Kundendienst GmbH
Pagenstecherstraße 75
49090 Osnabrück
Tel. +49 (0) 541/ 68 038

Panasonic Service Center Wiesbaden
J. Hemmerling - VAD GmbH
Ostring 7
65205 Wiesbaden
Tel. +49 (0)6122/ 90 91 10

Panasonic Service Center Mannheim
N. Schaaf
Reichenbachstraße 21-23
68309 Mannheim
Tel. +49 (0)621/ 72 787-0

Panasonic Service Center Stuttgart
Hans Beck
Friedrich-List-Straße 38
70771 Leinfelden-Echterdingen
Tel. +49 (0) 711/ 94 701-0

Panasonic Service Center Reutlingen
Herbert Geissler
Lichtensteinstraße 75
72770 Reutlingen
Tel. +49 (0)7072/ 92 96-0

Panasonic Service Center München
G. Berghofer & W. Kaller GmbH
Helene-Wessel-Bogen 7
80939 München
Tel. +49 (0)89/ 318 907-0

Panasonic Service Center Augsburg
Klaus Bieneke
Affinger Straße 4
86167 Augsburg
Tel. +49 (0)821/ 70 70 75

Panasonic Service Center Nürnberg
Herbert Geissler GmbH
Friedrich-Ebert-Straße 21
90537 Feucht
Tel. +49 (0)9128/ 70 67-0

Panasonic Service Center Eisenach
Blitz Electro-Electronic-GmbH
Bahnhofstraße 17
99817 Eisenach
Tel. +49 (0)3691/ 29 29 42 8

A

Service-Fentren in Österreich
Funk Fuchs GmbH & CoKg Unterhart 90
4642 Sattledt
Tel. +43 7244 733

Funktechnik Seissl
Dorf 79
6330 Schwoich
Tel. +43 5372 8217

Electro Oberndorfer
Linzer Straße 2-4
4840 Vöcklabruck
Tel. +43 6772 72889

Panasonic Austria Handelsges.mBh Laxenburger
Straße 252
1232 Wien
Tel. +43 222/61080

FR

CETELEC
FI de la Delorme
5 Avenue Paul héroult
13015 MARSEILLE
Tél. : 04 96 15 77 77
Tél. : 04 91 58 07 55

CORDON Electronique
BP 460
FI Taden
22107 DINAN CEDEX
Tél. : 02.96.85.82.20
Fax : 02.96.85.82.21

EASY REPAIR
26 rue des Cosmonautes
31400 Toulouse
Tél. : 05.62.71.48.14
Fax : 05.62.71.48.15

EASY REPAIR
22 boulevard des Brotteaux
69006 Lyon
Tél. : 04.72.83.02.02
Fax : 04.78.52.40.38

ELECTRONIQUE SERVICE
Avenue Figuières
FAC Font de la Banquière
34970 LATTES
Tél. : 04.67.15.96.30
Fax : 04.67.20.04.72

GENERAL ELECTRONIQUE
16 rue Joseph Cugnot
F.I. Bracheux
60000 BEAUVAIS
Tél. : 03.44.89.79.00
Fax : 03.44.05.16.96

Négoce Technique etMaintenance
40 boulevard Bessières
75017 PARIS
Tél. : 01.44.85.21.66
Fax : 01.42.29.60.05

S.B.E.
F.I. de la Liane
BP 9
62360 SAINT LEONARD
Tél. : 03.21.10.10.21
Fax : 03.21.80.20.10

EU Warranty

NL

Service-centra in
Nederland

Panasonic-Centre Nederland
(Servicom bv)
P.O Box 16280
2500 BG
Den-Haag
Nederland
Tel. +31 703314314

Fonweg 60
2516 BM
Den-Haag
Nederland
Tel. +31 703314314

I

Per I Centri Assistenza in Italia
Servizio Clienti

Tel. +39 02/ 67072556

E

Panasonic España, S.A.
Servicio de Atención a Usuarios:
Tel: 902 15 30 60

DK

For nærmeste servicecenter ring Panasonic
Danmark

Tel. +45 43 20 08 50

S

Firmor I Sverige

Komrep
Rosenlundsgatan 4
411 20 Göteborg
Tel. +46 031-173354

Signalstyrkan
Kungsholmstorg 4
104 22 Stockholm
Tel. +46 08-6542500

CR service
Industribyn 3
232 37 Malmö
Tel. +46 040-430030

SF

Huoltokeskukset Suomessa:

KAUKOMARKKINAT OY
PANASONIC-HUOLLOT Kutojantie 4
02630 Espoo
Puh. +358 09 521 5151 Huolto
Puh. +358 09 521 5155 Varaosat Ja Tarvikkeet

SETELE OY
Vanha Viertotie 7
00300 Helsinki
Puh. +358 09 549100

PLAY-SHOP SERVICE Keskuskatu 3
00100 Helsinki
Puh. +358 09 27053626

MEGAFIX KY
Louhenkatu 9
74100 Iisalmi
Puh. +358 017 14631

T: MI.M.HAAPOJA
Miiilukatu 7
40320 Jyväskylä
Puh. +358 014 677121

OUTOKUMMUN PUHELIN Pohjoisahonkatu 9
83500 Outokumpu
Puh. +358 013 562211

SETELE OY
Rengastie 31
60100 Seinäjoki
Puh. +358 06 4148344

TURUN J-MARKKINAT OY Tuureporinkatu 6
20100 Turku
Puh. + 358 02 2332685

N

Servicesenter I Norge

Norsk Elektronikkcenter
Fetveien 1
2007 Kjeller
Tlf: +47 63 80 45 00

Panasonic Norge AS
Østre Aker vei 22
0508 Oslo
Tlf: +47 22 91 68 00

GR

Κέντρα τεχνικής υποστήριξης

INTERTECH S.A.
International Technologies
Αφροδίτης 26, 167 77 Ελληνικό
Ταχ. Θυρ.: 738 21, 167 10 ΕΛΛΗΝΙΚΟ
Τηλ. Κέντρο: (01) 9692.300
Υποκατάστημα Βόρειας Ελλάδας:
Κ. Καραμανλή 11, 54638 ΘΕΣΣΑΛΟΝΙΚΗ
Τηλ. Κέντρο: (031) 245.840-3

P

Centros de Assistência em Portugal

PAPELACO, S.A.
Vale Paraíso - Ferreiras
8200 ALBUFEIRA
ALGARVE
Tel. +351 89 589960

PAPELACO, S.A.
Largo de Santos, 9
1200 LISBOA
Tel. +351 1 3970539

PAPELACO, S.A.
Largo do Tribunal, Lote 11
2400 LEIRIA
Tel. +351 44 28071

EU Warranty

PAPELACO, S.A.
Rua Cidade de Santos, 31R/C
9000 FUNCHAL
MADEIRA
Tel. +351 91 231523

PAPELACO, S.A.
Rua do Outeiro,
Lote 25 - Gemunde
4470 MAIA
PORTO
Tel. +351 2 944 0354/9

PAPELACO, S.A.
Rua Major Leopoldo da Silva,
Lote 3
3500 VISEU
Tel. +351 32 424771

B

Centres de service après-vente en Belgique

BROOThAERS
Hoevelei 167
2630 AARTSELAAR
Tel. +32 03/887 06 24

HENROTTE
Rue du Campinaire 154
6240 FARCIEUNNES
Tel. +32 071/39 62 90

PIXEL VIDEOTECH
Rue St Remy 7
4000 LIEGE
Tel. +32 041/23 46 26

DELTA ELECTRONICS
Rue P.d'Alouette 39
5100 NANINNE
Tel. +32 081/40 21 67

ELEKSERVICE FEYS Houthulstseweg 56
8920 POELKAPELLE
Tel. +32 057/48 96 37

AVS WAASLAND Lavendelstraat 113
9100 ST NIKLAAS
Tel. +32 03/777 99 64

A.V.T.C SA
Kleine Winkellaan 54
1853 STROMBEEK-BEVER Tel. +32 02/267 40
19

RADIO RESEARCH
Rue des Carmélites 123
1180 BRUXELLES
Tel. +32 02/345 68 56

VIDEO TECHNICAL SERVICE
Av. du Roi Albert 207
1080 BRUXELLES
Tel. +32 02/465 33 10

SERVICE CENTER Kapellestraat 95
9800 DEINFE
Tel. +32 09/386 67 67

TOP SERVICE
Westerloseweg 10
2440 GEEL
Tel. +32 014/54 67 24

TELECTRO SC
Quai des Ardennes 50
4020 Liège
Tel. +32 041/43 29 04

L

Centres de service après-vente au Luxembourg
NOUVELLE CENTRAL RADIO
Rue des Jones 15
L - 1818 Howald
Luxembourg - Grand Duché
Tel. +32 40 40 78

CH

Jonh Lay Electronics AG
Littauerboden
6014 Littau
Phone: +41 41 259 9090 Fax: +41 41 252
0202

TR

TEKOFAKS ISTANBUL CENTRE OFFICE
KAGITHANE CADDESİ SEVİLEN SOKAK NO. 58
80340 ÇAGLAYAN-ISTANBUL
Tel: 90-212-220 60 70 / 14 Lines
Fax: 90-212-220-60 94

ANKARA BRANCH OFFICE
GÜVEN MAH.FARABI SOKAK NO: 38/6 06690
KAVAKLIDERE - ANKARA
Tel: 90-312-467 30 94/2 Lines pbx
Fax: 90-312 467 85 38

İSMİR BRANCH OFFICE
CUMHURİYET BULVARI NO:330 K.6 D.:608 SEVİL
İŞ MERKEFİ 35520 ALSANCAK-İFMİR
Tel: 90-232-464 29 01 pbx
Fax: 90-232-422 67 44

BURSA BRANCH OFFICE
ŞEHREKÜSTÜ MAHİLLESİ DURAK CADDESİ NO.:7
BURSA
Tel: 90-224-225 10 46 pbx
Fax: 90-224-223 81 03

ADANA BRANCH OFFICE
REŞATBEY MAH.FUFULİ CAD.GÜLEK SITESİ A
BLOK NO: 75b 01120 ADANA
Tel: 90-322-458 39 52 pbx
Fax: 90-322-453 21 32

TRABFON BRANCH OFFICE
MARAŞ CAD.MARAŞ APT.NO:51 D.:2 61200
TRABFON
Tel: 90-462-321 33 08
Fax: 90-462-326 37 78

ANTALYA BRANCH OFFICE
ALTINDAĞ MAH. 146 SOKAK ÖFKOÇ
APT.NO:9/1-2A ANTALYA
Tel: 90-242-243 23 70 / 3 Lines
Fax: 90-242-243 23 72

DİYARBAKIR BRANCH OFFICE
LİŞE CADDESİ GÖKALP APT.NO: 18/A
DİYARBAKIR
Tel: 90-412-228 73 00
Fax: 90-412-223 59 00

EU/EEA - Wide Guarantee: Conditions applicable in any country other than the country of original purchase.

- A When the purchaser finds the appliance to be defective, he should promptly contact the proper sales company or national distributor in the EU/EEA country where this guarantee is claimed, as indicated in the "Product Service Guide" or the nearest authorized dealer together with this guarantee and proof of date of purchase.
The purchaser will then be informed whether:
- (i) the sales company or national distributor will handle the repair service; or
 - (ii) the sales company or national distributor will arrange for trans-shipment of the appliance to the EU/EEA country where the appliance was originally marketed; or
 - (iii) the purchaser may himself send the appliance to the sales company or national distributor in the EU/EEA country where the appliance was originally marketed.
- B If the appliance is a product model which is normally supplied by the sales company or national distributor in the country where it is used by the purchaser, then the appliance, together with this guarantee card and proof of date of purchase, should be returned at the purchaser's risk and expense to such sales company or distributor, which will handle the repair service. In some countries, the affiliated sales company or national distributor will designate dealers or certain service centres to execute the repairs involved.
- C If the appliance is a product model which is not normally supplied in the country where used, or if the appliance's internal or external product characteristics are different from those of the equivalent model in the country where used, the sales company or national distributor may be able to have the guarantee repair service executed by obtaining spare parts from the country where the appliance was originally marketed, or it may be necessary to have the guarantee repair service executed the sales company or national distributor in the country where the appliance was originally marketed.
In either case, the purchaser must furnish this guarantee card and proof of date of purchase. Any necessary transportation, both of the appliance and of any spare parts, will be at the purchaser's risk and expense, and there may be a consequent delay in the repair service.
- D Where the consumer sends the appliance for repair to the sales company or national distributor in the country of use of the appliance, the service will be provided on the same local terms and conditions (including the period of guarantee coverage) as prevail for the same model appliance in the country of use, and not the country of initial sale in the EU/EEA. Where the consumer sends the appliance for repair to the sales company or national distributor in the EU/EEA country where the appliance was originally marketed, the repair service will be provided on the local terms and conditions prevailing in the country of initial sale in the EU/EEA.
- E Some product models require adjustment or adaptation for proper performance and safe use in different EU/EEA countries, in accordance with local voltage requirements and safety or other technical standards imposed or recommended by applicable regulations. For certain product models, the cost of such adjustment or adaptation may be substantial and it may be difficult to satisfy local voltage requirements and safety or other technical standards. It is strongly recommended that the purchaser investigates these local technical and safety factors before using the appliance in another EU/EEA country.
- F This guarantee shall not cover the cost of any adjustments or adaptations to meet local voltage requirements and safety or other technical standards. The sales company or national distributor may be in a position to make the necessary adjustments or adaptations to certain product models at the cost of the purchaser. However, for technical reasons it is not possible to adjust or adapt all product models to comply with local voltage requirements and safety or other technical standards. Moreover, where adaptations or adjustments are carried out the performance of the appliance may be affected.
- G In the opinion of the sales company or national distributor in the country where the appliance is used the purchaser has the necessary adjustments or adaptations to local voltage requirements and technical or safety standards properly made, any subsequent guarantee repair service will be provided as above indicated, provided the purchaser discloses the nature of the adjustment or adaptation if relevant to the repair. (It is recommended that the purchaser should not send adapted or adjusted equipment for repair to the sales company or national distributor in the country where the appliance was originally marketed if the repair relates in any way to the adaptation or adjustment).
- H This guarantee shall only be valid in territories subject to the laws of the European Union and the EEA.

Please keep this guarantee with your receipt.

Personal Settings

Personal Settings

Use the table below to record your GSM/GPRS WAP settings.

Item	Provisioning Information Setting No 1	Provisioning Information Setting No 2
Name		
Home URL		
Gateway IP		
Port Number	Non secure - 9201 Secure - 9203 (Delete One)	
Service Choice		
Circuit Switched (GSM)		
Digital Dial #		
Analogue Dial #		
Circuit Type		
PPP ID		
PPP Password		
Linger time		
Packet Switched (GPRS)		
Access Point Name		
User ID		
User Password		
Authentication	Normal/Encrypted/ None (PAP) (Chap)	

Notes

Menu Structure

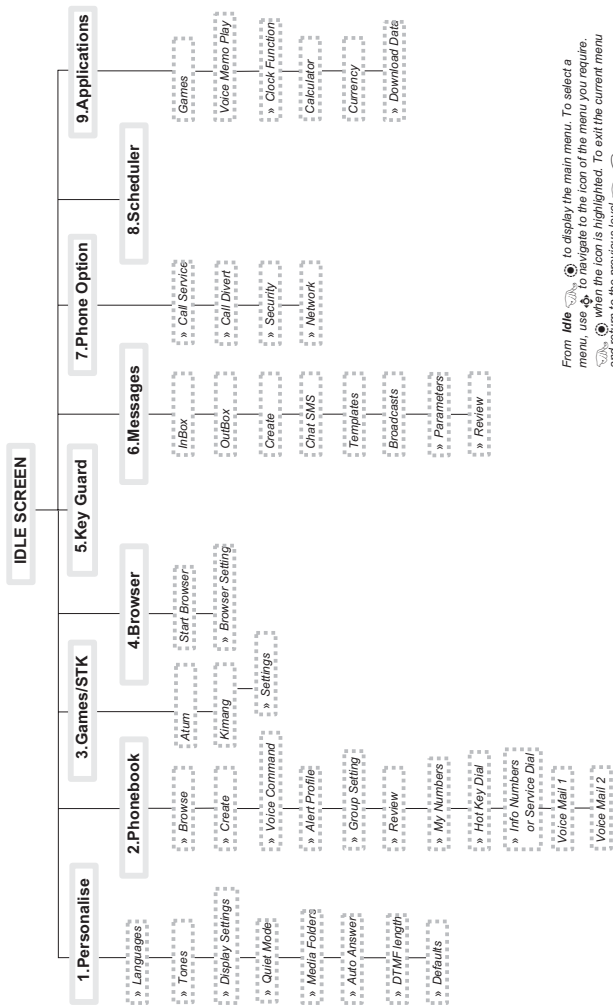

From **Idle** to display the main menu. To select a menu, use to navigate to the icon of the menu you require, when the icon is highlighted. To exit the current menu and return to the previous level . To exit the menu structure + . During a call a restricted menu will be available.

» Indicates there are further Sub menus

Licencing

In-Fusio

In-Fusio have developed specific software called ExEn for the purpose of downloading and playing games from mobile handset



OpenWave

OpenWave is a pioneer in the mobile data transfer industry, supplying voice and data revenue to the mobile communications sector.



Tegic

T9® is a trademark of Tegic Communications Inc. T9® Text Input is licensed under one or more of the following: U.S. Pat. Nos. 5,818,437, 5,953,541, 5,187,480, 5,945,928, and 6,011,554; Canadian Pat. No. 1,331,057; United Kingdom Pat. No. 2238414B; Hong Kong Standard Pat. No. HK0940329; Republic of Singapore Pat. No. 51383; Euro. Pat. No. 0 842 463 (96927260.8) DE/DK, FI, FR, IT, NL, PT.ES, SE, GB; and additional patents are pending worldwide.

CE0168

CP8 Patent

© Matsushita Mobile Communications Development of Europe Ltd 2002
Information in this document is subject to change without notice. No part of these instructions may be reproduced or transmitted in any form or by any means without obtaining express permission from Matsushita Mobile Communications Development of Europe Ltd

The Serial Number can be found on the outside of the phone under the battery. For your convenience we recommend that you note the following details as a record of your purchase.

Part Number	
Serial Number	
Dealer Name	
Purchase Date	



GD67DPK11A

Printed in Czech Republic
www.panasonicmobile.com

Matsushita Communication Industrial Czech s.r.o
Pardubice, Czech Republic