

---

*Operator's Manual*

***SYSTEM 5000***<sup>TM</sup>  
E L E C T R O S U R G I C A L     U N I T



## LIMITED WARRANTY

For a period of two years following the date of delivery, CONMED Corporation warrants the CONMED System 5000™ Electrosurgical Generator against any defects in material or workmanship and will repair or replace (at CONMED's option) the same without charge, provided that routine maintenance as specified in this manual has been performed using replacement parts approved by CONMED. This warranty is void if the product is used in a manner or for purposes other than intended.

© **2007 CONMED Corporation**  
525 French Road  
Utica, New York 13502 U.S.A.

U.S. Patent Nos. 4,961,739 - 5,152,762 - 5,626,575 -  
6,830,569 - 6,835,082 - 6,875,210 - 6,939,347 -  
D477,082 - D477,408.

For Technical Service or Return Authorization Phone:  
303-699-7600 / 1-800-552-0138 Extension 5274  
Fax 303-699-1628

For Customer Service or to order parts phone:  
1-800-448-6506 / 315-797-8375 / Fax 315-735-6235  
or contact your CONMED Representative.

European Authorized Representative  
MDSS GmbH  
Schiffgraben 41  
D - 30175 Hannover  
Germany

The revision level of this manual is specified by the highest revision letter found on either the inside front cover or enclosed errata pages (if any).

**Manual Number 60-8016-ENG Rev. N 11/07**

Unit Serial Number \_\_\_\_\_

**Table of Contents**  
*& List of Illustrations*

Section	Title	Page
<b>1.0</b>	<b>General Information .....</b>	<b>1-1</b>
<b>1.1</b>	<b>Cautions.....</b>	<b>1-1</b>
1.1.1	Cautions For Equipment Preparation .....	1-2
1.1.2	Cautions For Patient Preparation.....	1-2
1.1.3	Cautions For Use .....	1-4
1.1.4	Cautions For Testing or Servicing .....	1-5
1.1.5	Electromagnetic Compatibility .....	1-6
1.1.5.1	EN/IEC 60601-1-2 Table 201.....	1-6
1.1.5.2	EN/IEC 60601-1-2 Table 202.....	1-7
1.1.5.3	EN/IEC 60601-1-2 Table 204.....	1-8
1.1.5.4	EN/IEC 60601-1-2 Table 206.....	1-9
<b>1.2</b>	<b>Specifications .....</b>	<b>1-9</b>
1.2.1	Mains Overcurrent Protection .....	1-9
1.2.2	Mains Frequency Leakage .....	1-9
1.2.3	Regulatory Compliance.....	1-10
1.2.4	Operation.....	1-10
1.2.5	Power Display Accuracy .....	1-10
1.2.6	Line Regulation .....	1-10
1.2.7	Environmental.....	1-10
1.2.8	Contact Quality Monitor.....	1-10
1.2.9	Audio Specifications.....	1-10
1.2.10	Other Specifications .....	1-11
1.2.11	Operating Modes and Nominal Output Parameters.....	1-11
<b>1.3</b>	<b>Explanation of Symbols.....</b>	<b>1-12</b>
1.3.1	Control Panel .....	1-12
1.3.2	Interior.....	1-12
1.3.3	Output/Control Panel.....	1-12
1.3.4	Rear Panel .....	1-13
<b>1.4</b>	<b>Output Characteristic Curves.....</b>	<b>1-14</b>
<b>2.0</b>	<b>Installation and Operation .....</b>	<b>2-1</b>
<b>2.1</b>	<b>Initial Inspection.....</b>	<b>2-1</b>
<b>2.2</b>	<b>Installation.....</b>	<b>2-1</b>
2.2.1	Installation Of Fuses .....	2-1
<b>2.3</b>	<b>Preliminary Checks .....</b>	<b>2-1</b>
2.3.1	Preliminary Functional Testing .....	2-1
2.3.2	Preliminary Performance Testing .....	2-3
<b>2.4</b>	<b>Controls, Displays and Connectors .....</b>	<b>2-3</b>
2.4.1	Control Panel .....	2-3
2.4.2	Output Panel.....	2-5
2.4.3	Rear Panel.....	2-6
<b>2.5</b>	<b>Set Up For Use .....</b>	<b>2-7</b>
<b>2.6</b>	<b>Operation.....</b>	<b>2-10</b>
2.6.1	General .....	2-10
2.6.2	Monopolar Pulse Cut .....	2-10



Section	Title	Page
2.6.3	Monopolar Pulse Coag.....	2-11
2.6.4	Fluids Specialty Mode .....	2-11
2.6.5	Lap Specialty Mode.....	2-11
2.6.6	Programming .....	2-11
2.6.6.1	Storing Programs .....	2-11
2.6.6.2	Using Programs .....	2-11
2.6.7	Remote Power Control .....	2-11
2.6.7.1	Changing Monopolar Power Remotely .....	2-12
<b>2.7</b>	<b>User Maintenance .....</b>	<b>2-12</b>
2.7.1	General Maintenance Information .....	2-12
2.7.2	Cleaning.....	2-12
2.7.3	Periodic Inspection.....	2-12
2.7.4	Periodic Performance Testing .....	2-12
<b>2.8</b>	<b>In Case of Difficulty.....</b>	<b>2-12</b>
2.8.1	Dispersive Electrode Alarm .....	2-12
2.8.1.1	Single Dispersive Electrode Alarm.....	2-12
2.8.1.2	Dual Dispersive Electrode Alarm .....	2-13
2.8.2	Acc Codes .....	2-13
2.8.3	Err Codes.....	2-13
2.8.4	If All Else Fails.....	2-13
<b>2.9</b>	<b>Environmental Protection .....</b>	<b>2-13</b>

Figure/Title	Page
Figure 1.1 Output Power vs. Power Setting.....	1-14
Figure 1.2 Display vs. Open Circuit Peak Voltage.....	1-14
Figure 1.3 Load Regulation, Monopolar Pure Cut .....	1-15
Figure 1.4 Load Regulation, Monopolar Blend 1 .....	1-15
Figure 1.5 Load Regulation, Monopolar Blend 2 .....	1-16
Figure 1.6 Load Regulation, Monopolar Blend 3 .....	1-16
Figure 1.7 Load Regulation, Monopolar Pinpoint Coag.....	1-17
Figure 1.8 Load Regulation, Monopolar Standard Coag .....	1-17
Figure 1.9 Load Regulation, Monopolar Spray Coag .....	1-18
Figure 1.10 Load Regulation, Bipolar Micro .....	1-18
Figure 1.11 Load Regulation, Bipolar Macro .....	1-19
Figure 1.12 Load Regulation, Lap Spray.....	1-19
Figure 1.13 Load Regulation, Lap Standard.....	1-20
Figure 2.1 Control Panel.....	2-4
Figure 2.2 Output Panel .....	2-6
Figure 2.3 Rear Panel .....	2-7
Figure 2.4 Accessory Schematics.....	2-14
Figure 2.5 Accessory Connections .....	2-14



## General Information

### Section 1.0

This manual provides the set up and operating instructions for the System 5000™ Electrosurgical Unit (ESU). Electrosurgery can be dangerous to patients, staff and other equipment if mis-used. Please understand and follow the warnings and cautions that are included in this manual. Technical specifications, performance characteristic curves and user maintenance instructions are also included.

The System 5000™ provides a broad range of capabilities in a single, general-purpose electrosurgical generator. This rugged ESU fulfills the operational and safety needs of the modern operating room by providing:

- Four monopolar cutting modes: Pure, Blend 1, Blend 2 and Blend 3.
- Three monopolar coagulation modes: Spray, Standard and Pinpoint.
- Two bipolar modes: Micro and Macro
- Two specialty modes and a general surgery mode:
  - General Mode provides full power performance for open surgical procedures.
  - Fluids Specialty Mode provides immediate energy delivery for procedures performed in a fluid medium.
  - Laparoscopic Specialty Mode provides optimal safety by limiting output voltage and minimizing the potential harmful effects of capacitive coupling.
- Pulse Cut Mode provides precise modulated energy delivery for critical dissection.
- Pulse Coagulation Mode provides a modulated waveform for unsurpassed precision and control.
- Radio Frequency (RF) isolated and independent outputs.
- The proven Automatic Return Monitor (A.R.M.™) contact quality monitoring system.
- Continuous microprocessor safety monitoring.

Features include:

- Dynamic Response Technology delivers optimal clinical effects in all operational modes through the continuous synchronization of current and voltage.
- Bipolar Output Meter provides visual and audible feedback to surgeon during tubal ligations, vasectomies, and other procedures.
- ReadiPlug™ universal accessory receptacle eliminates the need for foot-controlled adapters.
- Nine programmable memory settings provide set-up convenience.
- Automatic programming restores the ESU to the last settings used.
- Remote Power Control (PC) allows power setting changes using standard hand-controlled pencils.
- Independent power setting available for all modes.
- Ability to change power settings from the control panel while the ESU is activated.
- Two handswitched receptacles and a separate footswitched receptacle enable multiple accessory connections.
- Simultaneous activation in non-contact monopolar coagulation modes.
- Channeled accessory receptacles direct plugs into position, making attachments less cumbersome.
- Illuminated receptacles for greater visibility.
- Integrated operating room control system capability.
- Integrated interface for activation of smoke evacuators and similar devices.

### 1.1 Cautions

This equipment, in conjunction with connected accessories, is intended to produce high-frequency electrical energy for the controlled destruction of tissue.



Safe and effective electrosurgery is dependent not only on equipment design, but also on factors under the control of the operator. It is important that the instructions supplied with this equipment be read, understood and followed in order to ensure safe and effective use of the equipment.

### 1.1.1 Cautions For Equipment Preparation

- Use only accessories that comply with the relevant regulatory standards for your location and meet the requirements of Section 1.2, Section 1.4, and Figure 2.4. Use of other accessories may result in increased emissions or decreased immunity of the ESU.
- Reusable accessory cables should be periodically function and safety tested in accordance with the original manufacturer's instructions.
- Visually inspect all accessories before each use to verify the integrity of insulation and the absence of obvious defects. In particular, electrode cables and endoscopic accessories should be checked for damage to the insulation.
- The System 5000™ is equipped to connect three monopolar accessories at one time for the convenience of the surgical staff. Unused accessories should be stowed in a safe, electrically insulated place such as a non-conductive holster, isolated from the patient. CONMED recommends accessories not be connected unless needed.
- Never connect more than one accessory at a time to any one receptacle, not including the dispersive electrode receptacle when the appropriate CONMED adapter is used.
- Use only a hospital grade, 3-prong, power cord rated to meet the specifications in Section 1.2 and all of the requirements for safe grounding of the ESU. The user should verify that the power receptacle with which this ESU is used is properly grounded, correctly polarized and of the proper frequency per Section 1.2. Do not use ground cheater plugs or extension cords.
- Do not place liquid containers on top of the ESU. Wipe spilled liquids off the ESU immediately. To preclude inadvertent entry of liquids, do not operate this ESU except in its normal position.
- Do not stack other devices or equipment on top of or adjacent to the System 5000™. The CONMED Stacking Adapter (Cat. No.

60-8030-001) allows two System 2500™ or System 5000™ units to be stacked in a safe manner.

- Confirm all accessories are properly connected to the appropriate receptacles before powering the ESU.
- Potentially hazardous conditions may exist when accessories of similar connector types are combined. Be certain accessories are appropriate for the type of generator output used. Use only CONMED Electrosurgery footswitches. Confirm bipolar leads are connected only to the bipolar receptacles. Connecting bipolar accessories to monopolar outputs may result in patient injury.
- Do not reuse disposable (single use) accessories.
- Do not use cords as handles as damage to the insulation and increased risk of burns or other injury may result.
- A failure in the ESU could cause an unintended increase in output power. Verify that the ESU is functioning correctly prior to use.
- Prior to use, verify that devices connected to the Activation Relay Connector function properly in a manner that is synchronized with ESU power delivery.
- Equipment connected to the Serial Interface Connector must be approved by CONMED and must be connected in accordance with instructions accompanying the equipment. Verify proper operation prior to ESU use.

### 1.1.2 Cautions For Patient Preparation

- Electrosurgery should NEVER be performed in the presence of flammable anesthetics, flammable prep solutions or drapes, oxidizing gases such as Nitrous Oxide (N<sub>2</sub>O) or in oxygen-enriched environments. The risk of igniting flammable gases or other materials is inherent in electrosurgery and cannot be eliminated by device design. Precautions must be taken to restrict flammable materials and substances from the electrosurgical site. They may be present in the form of an anesthetic, life support, skin preparation agent, produced by natural processes within body cavities or originate in surgical drapes, tracheal tubes or other materials. There is a risk of pooling of flammable solutions in body depressions such as the umbilicus and in body cavities,



such as the vagina. Any fluid pooled in these areas should be removed before the high frequency surgical equipment is used. Due to the danger of ignition of endogenous gases, the bowel should be purged and filled with nonflammable gas prior to abdominal surgery. To avoid the risk of tracheal fires, never use electrosurgery to enter the trachea during tracheotomy procedures.

- The System 5000™ mobile pedestal is made of nonconductive plastic, that can hold a static charge. It should not be used in a flammable environment, as described above.
- Only non-flammable agents should be used for cleaning and disinfection wherever possible.
- Exercise care when relocating the ESU to avoid electrostatic charge buildup in the presence of flammable materials, as there is a risk of igniting these materials if a spark should occur.
- This ESU is equipped with the Automatic Return Monitor (A.R.M.™), which monitors the quality of the dispersive electrode connection. When a correctly functioning single dispersive electrode is connected to the ESU, A.R.M.™ verifies the connections between the ESU, the dispersive electrode cable and the dispersive electrode. It DOES NOT verify that a single dispersive electrode is in contact with the patient. When using a dual dispersive electrode, A.R.M.™ confirms the total resistance is within the preset safety range. Proper application and visual inspection of the dispersive electrode is required for safe operation.
- The use and proper placement of a dispersive electrode is a key element in safe and effective electrosurgery. Follow manufacturer's directions and recommended practices for the preparation, placement, use, surveillance and removal of any dispersive electrode supplied for use with this electrosurgical unit.
- Apply the dispersive electrode over a well-vascularized muscle mass that is thoroughly clean and dry. Clean and clip site, as necessary, to provide adequate electrical connection and per hospital policy. Avoid placement over scar tissue, bony prominences or other areas where pressure points on small areas might develop.
- Because of the risk of burns, needles should never be used as a dispersive electrode for electrosurgery. The entire area of the dispersive electrode should be placed so that the entire conductive area is in firm contact with an area of the patient's body that has a good blood supply and is as close to the operative site as possible. In general, electrosurgical current paths should be as short as possible and should run either longitudinally or in a diagonal direction to the body, not laterally and under no circumstances lateral to the thorax.
- Dispersive electrodes and probes of monitoring, stimulating and imaging devices can provide paths for high frequency currents even if they are battery powered, insulated or isolated at 50/60 Hz. The risk of burns can be reduced but not eliminated by placing the probes as far away as possible from the electrosurgical site and the dispersive electrode. Protective impedances incorporated in the monitoring leads may further reduce the risk of these burns. Needles should not be used as monitoring electrodes during electrosurgical procedures.
- When high frequency surgical equipment and physiological monitoring equipment are used simultaneously on the same patient, all monitoring electrodes should be placed as far as possible from the surgical site and dispersive electrode. Needle monitoring electrodes are not recommended. Monitoring systems incorporating high frequency current limiting devices are recommended whenever possible.
- The active electrode should not be used in the vicinity of electrocardiograph electrodes.
- Heat applied by thermal blankets or other sources is cumulative with the heat produced at the dispersive electrode (caused by electrosurgical currents). Choosing a dispersive electrode site that is remote from other heat sources may minimize risk of a patient injury.
- Electrosurgery, by its nature produces significant levels of electromagnetic interference (EMI) when the ESU is activated. This EMI may damage or impair the function of other electronic equipment in the operating room, especially equipment that makes contact with the patient. Adverse effects can only be mitigated by use of equipment specifically designed to tolerate electrosurgical interfer-





ence. Cables subject to flexing should be inspected frequently for shielding integrity.

- Other equipment in the operating room, including portable or mobile communications equipment, may produce EMI, which can affect the function of the ESU. Adverse effects can only be mitigated by use of equipment with EMI characteristics proven below recognized limits. In the event of suspected interference from other equipment, discontinue use of the ESU until the problem can be remedied.
- The patient should not be allowed to come into contact with metal items that are grounded or have an appreciable capacitance to earth. Examples of this would be operating tables, supports, etc.
- Jewelry and other metallic items can cause localized burns if they make contact with grounded items and should be removed from the patient prior to use of electrosurgery.
- Skin to skin contacts, such as between the arm and body of a patient or between the legs and thighs, should be avoided by the insertion of dry gauze.
- The use of electrosurgery on patients with cardiac pacemakers, AICDs, neurostimulators or other active implants is potentially hazardous. The implant may be irreparably damaged and/or the high frequency energy of the electrosurgical output may interfere with the function of the implant. Ventricular fibrillation may occur. Precautions should be taken to ensure the patient's well-being is maintained in the event of such interaction. The manufacturers of the implants should be consulted for advice before operating on a patient with an implant. These precautions also apply to operating room personnel with similar implants.
- To minimize the possibility of cardiac pacemaker interference, place the dispersive electrode such that the electrosurgical current path does not intersect the path of the pacemaker or leads.

### 1.1.3 Cautions For Use

- Safe and effective electrosurgery is dependent not only on equipment design, but also on factors under the control of the operator. It is important that the instructions supplied

with this equipment be read, understood and followed in order to ensure safe and effective use of the equipment. Only properly qualified and trained operators should perform electrosurgery. The operator and their support personnel must be diligent in assuring that the ESU is properly configured and that proper settings are used. The ESU must be located to assure the operator or their support personnel can readily verify the settings.

- PLEASE NOTE: Federal law (U.S.A.) requires that all health care facilities must report to the manufacturer of a medical device, any death or serious injury or illness to a patient related to the use of a medical device. Serious injuries or illness involving the use of a medical device must be reported to the manufacturer of the device (or to the FDA if the manufacturer of the device is not known) within 10 working days of the incident. Summary reports of such injuries must also be submitted directly to the FDA twice a year. Patient deaths related to the use of a medical device must be reported to the manufacturer and the FDA. For further information, please contact the Regulatory Affairs Department of CONMED Electrosurgery at 800-552-0138, 303-699-7600 or FAX 303-699-9854.
- Do not use monopolar electrosurgery on small appendages, as in circumcision or finger surgery, as it can cause thrombosis and other unintended injury to tissue proximal to the surgical site. Should the surgeon decide that the bipolar electrosurgical technique is acceptable for circumcision, do not apply the bipolar electrosurgical current directly to circumcision clamps.
- Apparent low power output or failure of the electrosurgical equipment to provide the expected effect at otherwise normal settings may indicate faulty application of the dispersive electrode, failure of an electrical lead or excessive accumulation of tissue on the active electrode. Do not increase power output before checking for obvious defects or misapplication of the dispersive electrode. Check for effective contact of the dispersive electrode to the patient anytime the patient is moved after initial application of the dispersive electrode.





- Studies have shown that smoke generated during electrosurgical procedures may be harmful to surgical personnel. These studies recommend using a surgical mask and adequate ventilation of the smoke using a surgical smoke evacuator or other means.
- In the event that the system resets due to a power interruption or low voltage, check the contact of the dispersive electrode prior to resuming electrosurgery.
- If a dispersive electrode or A.R.M.™ alarm is sounded intraoperatively, physically confirm proper dispersive electrode attachment to the patient and confirm that the display falls within the set range. Smooth the dispersive electrode surface with hand to ensure electrode contact to patient skin. Replace the dispersive electrode if necessary.
- Simultaneous activation can be used in both Standard and Spray monopolar coagulation modes. Caution should be used as the output from either active electrode may change as a result of activation of a second output or ending activation of an output. Power sharing is unlikely to be equal because of differences in electrode to tissue distance and other factors. This unequal power sharing can be enough to stop power delivery to one electrode if the second electrode is close to tissue and the first electrode is somewhat above the tissue. The motion or deactivation of one electrode can cause the other electrode to start delivering power when it had been too far away from tissue to arc before the first electrode change. Simultaneous activation can also increase leakage currents, which can be hazardous to the patient. It is recommended that a second electrosurgical generator be used when it is necessary to perform simultaneous operation.
- The cables to the surgical electrodes (active, bipolar or dispersive electrodes) should be positioned in such a way that contact with the patient or other leads is avoided.
- Confirm the desired specialty mode is selected prior to use to ensure output characteristics are suitable for the intended procedure.
- Confirm the desired bipolar mode is selected prior to use to ensure output characteristics are suitable for the intended procedure.
- The output power selected should be as low as possible and activation times should be as short as possible for the intended purpose.
- The clinical use of electrosurgery is intermittent in nature. This ESU should not be activated continuously for extended periods of time.
- When uncertain of the proper setting for the power level in a given procedure, start with a low setting and increase as required.
- Confirm that Pulse Cut Mode is properly selected prior to activation to ensure that improper application does not result in patient injury. Set the monopolar coag power to 0 when using Pulse Cut to ensure that an accidental activation of coag does not cause patient injury. Listen for the distinct Pulse Cut Activation Tone during activation to confirm that Pulse Cut is indeed active.
- Observe all caution and warning symbols printed on the ESU.
- The operating room staff should never contact electrosurgical electrodes (either active or dispersive) while the RF output of the ESU is energized.
- The electrodes of recently activated accessories may be hot enough to burn the patient or ignite surgical drapes or other flammable material.
- Do not ignore unexpected tones. Check to determine the cause of the tone, otherwise injury can occur.
- Temporarily unused active electrodes should be stored in an electrically insulated holster. The unused active electrode should never be placed on the patient. This is especially important for laparoscopic procedures.
- Ensure that the footswitches are not inadvertently depressed in order to prevent accessories from being unintentionally activated. Place footswitches in locations that necessitate deliberate action in order to activate the footswitch. Use caution when selecting the correct footswitch to activate.

#### 1.1.4 Cautions For Testing or Servicing

- Service should not be attempted without reference to the System 5000™ service manual (Catalog Number 60-8017-ENG).



- This electrosurgical unit should be tested by a Hospital Qualified Biomedical Technician on a periodic basis to ensure proper and safe operation. It is recommended that examination of the ESU be performed at least yearly.
- Refer all servicing to a Hospital Qualified Biomedical Technician. Your CONMED sales representative will be happy to assist you in getting your equipment serviced.
- High voltages are developed within the ESU that are accessible when the top cover is removed. These voltages are potentially dangerous and should be treated with extreme caution.
- The high voltage DC power supply in the System 5000™ is equipped with a bleeder resistor to dissipate the charge on the filter capacitor. However, it takes several seconds after power is removed to bleed that charge down to a safe level. It is recommended that at least thirty (30) seconds be allowed to elapse before touching or attempting to perform any maintenance involving the power supply or power amplifier.
- Never remove or install any parts with the power cord connected to AC mains.
- Avoid contact with the output leads when the ESU is activated. Periodically inspect the test leads used for the output connections for obvious defects.
- Although this ESU will withstand momentary short circuits on the output, prolonged short circuits may damage the ESU. Short-circuiting the output should be avoided since it is neither necessary nor desirable.
- Since the clinical use of electrosurgical units is intermittent in nature with duty cycles on the order of 10%, this ESU is not designed to operate for extended periods of continuous output. When testing, it is recommended that duty cycles be limited to 10 seconds activation with delays of 30 seconds between activations.
- Activating the System 5000™ in other than its normal operating position impairs the heat dissipation capability of the heat sink.
- Ensure that the two top cover screws are tightened and always perform a power-up check to confirm a normal power-up sequence before returning the ESU to service.
- Improperly connecting test equipment can cause electric shock and destruction of equipment.
- Turn unit off and wait until storage capacitors have discharged before connecting test equipment.
- Loss of power supply isolation can cause electrical shock. When servicing the high voltage power supply, assume internal isolation is compromised until verified otherwise.

### 1.1.5 Electromagnetic Compatibility

Following are guidance and manufacturer’s declarations regarding electromagnetic compatibility for the System 5000™.

#### 1.1.5.1 EN/IEC 60601-1-2 Table 201

Guidance and Manufacturer’s Declaration – Electromagnetic Emissions		
The System 5000™ Electrosurgical Unit is intended for use in the electromagnetic environment specified below. The customer or the end user of the System 5000 Electrosurgical Unit should assure that it is used in such an environment.		
Emissions test	Compliance	Electromagnetic environment - guidance
RF emissions CISPR 11	Group 2	The System 5000 Electrosurgical Unit must emit electromagnetic energy in order to perform its intended function. Nearby electronic equipment may be affected.
RF emissions CISPR 11	Class A	
Harmonic emissions IEC 61000-3-2	Class A	
Voltage fluctuations/ Flicker emissions IEC 61000-3-3	Complies	



## 1.1.5.2 EN/IEC 60601-1-2 Table 202

Guidance and Manufacturer's Declaration – Electromagnetic Immunity			
The System 5000™ Electrosurgical Unit is intended for use in the electromagnetic environment specified below. The customer or the end user of the System 5000 Electrosurgical Unit should assure that it is used in such an environment.			
Immunity Test	IEC60601 test level	Compliance level	Electromagnetic environment - guidance
Electromagnetic discharge (ESD) IEC 61000-4-2	±6 kV contact ±8 kV air	±6 kV contact ±8 kV air	Floors should be wood, concrete or ceramic tile. If floors are covered with synthetic material, the relative humidity should be at least 30%.
Electrical fast transient/burst IEC 61000-4-4	±2 kV for power supply lines ±1 kV for input/output lines	±2 kV for power supply lines ±1 kV for input/output lines	Mains power quality should be that of a typical commercial or hospital environment.
Surge IEC 61000-4-5	±1 kV differential mode ±2 kV common mode	±1 kV differential mode ±2 kV common mode	Mains power quality should be that of a typical commercial or hospital environment.
Voltage dips, short interruptions and voltage variations on power supply input lines IEC 61000-4-11	<5 % UT (>95 % dip in UT) for 0.5 cycle 40 % UT (60 % dip in UT) for 5 cycles 70 % UT (30 % dip in UT) for 25 cycles <5 % UT (>95 % dip in UT) for 5 sec	<5 % UT (>95 % dip in UT) for 0.5 cycle 40 % UT (60 % dip in UT) for 5 cycles 70 % UT (30 % dip in UT) for 25 cycles <5 % UT (>95 % dip in UT) for 5 sec	Mains power quality should be that of a typical commercial or hospital environment. If the user of the System 5000 Electrosurgical Unit requires continued operation during power mains interruptions, it is recommended that the System 5000 Electrosurgical Unit be powered from an uninterruptible power supply or a battery.
Power frequency (50/60 Hz) magnetic field IEC 61000-4-8	3 A/m	3 A/m	Power frequency magnetic fields should be at levels characteristic of a typical location in a typical commercial or hospital environment.
NOTE UT is the a.c. mains voltage prior to application of the test level.			



1.1.5.3 EN/IEC 60601-1-2 Table 204

Guidance and Manufacturer's Declaration – Electromagnetic Immunity			
The System 5000™ Electrosurgical Unit is intended for use in the electromagnetic environment specified below. The customer or the end user of the System 5000 Electrosurgical Unit should assure that it is used in such an environment.			
Immunity Test	IEC60601 test level	Compliance level	Electromagnetic environment - guidance
Conducted RF IEC 61000-4-6	3 Vrms 150 kHz to 80 MHz	3 Vrms	Portable and mobile RF communications equipment should be used no closer to any part of the System 5000™ Electrosurgical Unit, including cables, than the recommended separation distance calculated from the equation applicable to the frequency of the transmitter.  <b>Recommended separation distance</b>  $d = 1.2\sqrt{P}$
Radiated RF IEC 61000-4-3	3 V/m 80 MHz to 2.5 GHz	3 V/m	$d = 1.2\sqrt{P}$ 80 MHz to 800 MHz  $d = 2.3\sqrt{P}$ 800 MHz to 2.5 GHz  where P is the maximum output power rating of the transmitter in watts (W) according to the transmitter manufacturer and <i>d</i> is the recommended separation distance in meters (m).  Field strengths from fixed RF transmitters, as determined by an electromagnetic site survey, <sup>a</sup> should be less than the compliance level in each frequency range. <sup>b</sup>  Interference may occur in the vicinity of equipment marked with the following symbol:  
NOTE 1 At 80 MHz and 800 MHz, the higher frequency range applies.			
NOTE 2 These guidelines may not apply in all situations. Electromagnetic propagation is affected by absorption and reflection from structures, objects and people.			
a	Field strengths from fixed transmitters, such as base stations for radio (cellular/cordless) tele-phones and land mobile radios, amateur radio, AM and FM radio broadcast and TV broadcast cannot be predicted theoretically with accuracy. To assess the electromagnetic environment due to fixed RF transmitters, an electromagnetic site survey should be considered. If the measured field strength in the location in which the System 5000™ Electrosurgical Unit is used exceeds the applicable RF compliance level above, the System 5000™ Electrosurgical Unit should be observed to verify normal operation. If abnormal performance is observed, additional measures may be necessary, such as reorienting or relocating the System 5000™ Electrosurgical Unit.		
b	Over the frequency range 150 kHz to 80 MHz, field strengths should be less than [v1] V/m.		



## 1.1.5.4 EN/IEC 60601-1-2 Table 206

Recommended separation distances between portable and mobile RF communications equipment and the System 5000™ Electrosurgical Unit			
The System 5000™ Electrosurgical Unit is intended for use in an electromagnetic environment in which radiated RF disturbances are controlled. The customer or the user of the System 5000™ Electrosurgical Unit can help prevent electromagnetic interference by maintaining a minimum distance between portable and mobile RF communications equipment (transmitters) and the System 5000™ Electrosurgical Unit as recommended below, according to the maximum output power of the communications equipment.			
Rated maximum output power of transmitter (W)	Separation distance according to frequency of transmitter (m)		
	150 kHz to 80 MHz $d = 1.2\sqrt{P}$	80 MHz to 800 MHz $d = 1.2\sqrt{P}$	800 MHz to 2.5 GHz $d = 2.3\sqrt{P}$
0.01	0.12	0.12	0.23
0.1	0.38	0.38	0.73
1	1.2	1.2	2.3
10	3.8	3.8	7.3
100	12	12	23
For transmitters rated at a maximum output power not listed above, the recommended separation distance $d$ in meters (m) can be estimated using the equation applicable to the frequency of the transmitter, where P is the maximum output rating of the transmitter in watts (W) according to the transmitter manufacturer.			
NOTE 1 At 80 MHz and 800 MHz, the separation distance for the higher frequency range applies.			
NOTE 2 These guidelines may not apply in all situations. Electromagnetic propagation is affected by absorption and reflection from structures, objects and people.			

## 1.2 Specifications

Input Power: 600 watts maximum

Frequency Hz	Mains Voltage VRMS			Mains Current ARMS	Fuses*
	Nominal	Minimum	Maximum	Maximum	
50-60	115	104	127	5.3	T6.3A
50-60	100	90	110	6.2	T8.0A
50-60	230	198	253	2.7	T3.15A

\*Fuses are Type T, High Breaking

## 1.2.1 Mains Overcurrent Protection

Two fuses for each ESU with ratings as noted in the table above.

## 1.2.2 Mains Frequency Leakage

Designed to comply with IEC60601-1: 1995.

Patient connections to Neutral: Less than 10  $\mu$ A.

Chassis to Neutral: Less than 25  $\mu$ A (120V), Less than 45  $\mu$ A (240V).



### 1.2.3 Regulatory Compliance

Designed to comply with Medical Electrical Equipment Standards (UL2601-1: 2000, IEC60601-1: 1995, IEC60601-1-1: 2000, IEC60601-1-2: 2001, IEC60601-1-4: 2000, IEC60601-2-2: 1998, ANSI/AAMI HF18: 2001).

Manufactured in an ISO 13485: 2003 Registered Facility.

Type of protection against electric shock: IEC Class 1.

Degree of protection against electric shock: Type CF, Defibrillator Proof.

Non-Ionizing Radiation.

### 1.2.4 Operation

Mode of operation: Intermittent 10 Sec on/30 Sec off.

### 1.2.5 Power Display Accuracy

The greater of  $\pm 10\%$  of display or  $\pm 3$  watts at rated load.

### 1.2.6 Line Regulation

Power Change  $< 1\%/V$  for the range of line voltages specified.

### 1.2.7 Environmental

Operating Conditions:  $10^{\circ}\text{C}$  to  $30^{\circ}\text{C}$ , 95% RH Non-condensing maximum.

Degree of protection against Ingress of Water: IPX1 (Protection against vertically falling water drops).

Mounting Restriction: 2-inch (5cm) clearance required on each side, back and above the ESU for cooling.

Cooling: Natural convection, conduction, radiation and temperature controlled fan.

Storage Conditions:  $-40^{\circ}\text{C}$  to  $70^{\circ}\text{C}$ , at altitudes from  $-60$  to  $+4500$  meters above mean sea level when sealed in original poly bag, packing material and shipping carton.

Prior to shipment or storage, the ESU should be enclosed and sealed in a polyethylene bag and placed in original carton using original packaging materials.

RF Leakage:  $< 100$  mA per IEC60601-2-2: 1998, Clause 19.3.101b.

### 1.2.8 Contact Quality Monitor

Single dispersive electrode: Two wire continuity detector, typical trip threshold is 10 ohms

Dual dispersive electrode: Two wire resistance monitor, typical acceptance range 10 to 150 ohms, trip threshold typically 30% higher than initial activation, visual indication of patient resistance changes.

### 1.2.9 Audio Specifications

Cut = 520 Hz

Coag = 440 Hz

Bipolar = 440 Hz

Acc Fault = 847 Hz (pulsating)

Dispersive Electrode Alarm = 847 Hz (pulsating)

Err Fault = 847 Hz (pulsating)

Increase Power Level = 379 Hz

Decrease Power Level = 343 Hz

Enter Cut Remote Power Control = 440 Hz followed by 574 Hz

Enter Coag Remote Power Control = 440 Hz followed by 515 Hz

Bipolar Output Tone = 215 Hz

Pulse Cut Activation Tone = 520 Hz with periodic short pulses at 481 Hz during output power pulses

Pulse Coag Activation Tone = 440 Hz with periodic short pulses at 384 Hz

(All tones are 45 dbA minimum except Alarms, which are 65 dbA minimum)





### 1.2.10 Other Specifications

Power Cord: All units supplied with an IEC-320 250V 10A 65°C mains inlet connector. Power cords can be ordered from CONMED Electrosurgery or obtained from other sources if the following specifications are met:

Region	Specification	Description	Standard	
USA, Canada	Any UL, CSA manufacturer	SJT or better	250VAC, minimum 16AWG, 3 Conductor, maximum length 20 feet (6m)	UL817
Europe	Any HAR cord manufacturer	<HAR>H05WF3G1.0	Copper 1.0mm <sup>2</sup> minimum cross sectional area, maximum length 20 feet or 6.0m	IEC60799

Weight: 21.5 lb. (9.75 Kg)

Height: 5.5 inches (14 cm); Width: 13.5 inches (35 cm); Depth: 21.5 inches (48 cm) including handle

SPECIFICATIONS SUBJECT TO CHANGE WITHOUT NOTICE

### 1.2.11 Operating Modes and Nominal Output Parameters

Mode	Max Power (watts)	Rated Load (ohms)	Typical Crest Factor	Max Open Circuit Voltage (Peak)	Max Loaded Voltage (Peak)	Carrier Freq. (KHz)*	Pulse Repetition Freq. (KHz)
<b>Monopolar</b>							
Pure Cut	300	500	1.4 - 1.7	800	820	391	N/A
Blend 1	200	500	1.5 - 1.9	860	930	391	20.0
Blend 2	200	500	1.8 - 2.4	1100	1100	391	20.0
Blend 3	200	500	2.4 - 2.9	1480	1480	391	20.0
Pinpoint Coag	120	500	3.7 - 4.6	2120	2120	391	20.0
Standard Coag	120	500	5.6 - 6.6	3140	3500	562	39.0
Spray Coag	80	500	7.1 - 9.7	6350	6350	562	19.5
<b>Bipolar</b>							
Micro Coag	50	50	1.5 - 1.9	170	180	391	N/A
Macro Coag	90	300	1.6 - 2.0	610	610	391	N/A

\*Measured in the open circuit condition.

















- Activation of Pulse Cut will make the selected cut mode, Pure Cut, Blend 1, Blend 2, or Blend 3 active for 70 milliseconds every 600 milliseconds.
- Activation of Pulse Coag will make the selected coag mode, either Standard or Spray, active for 2.5 milliseconds every 5 milliseconds. Displayed power setting will represent the average power being delivered which is approximately half the power delivered during the pulses.
- LAP Specialty Mode output parameters match general operation parameters except the maximum voltage is limited to less than 2700 Volts peak.
- FLUIDS Specialty Mode output parameters match general operation parameters with an initial energy boost upon activation to initiate an arc.



### 1.3 Explanation of Symbols

#### 1.3.1 Control Panel

Note: International System 5000™ units use symbols on the Control Panel. Some symbols are replaced by words on the domestic (U.S.) units. These words are indicated by bold text in the symbol description.

-  **Pure Cut** waveform with minimum thermal damage and hemostasis.
-  **Blend 1** waveform with moderate hemostasis.
-  **Blend 2** waveform with medium hemostasis.
-  **Blend 3** waveform with maximum hemostasis.
-  **Pinpoint** Monopolar Coagulation.
-  **Standard** Monopolar Coagulation.
-  **Spray** Monopolar Coagulation.
-  **Micro** Bipolar Coagulation
-  **Macro** Bipolar Coagulation
-  **General Setup**
-  **Fluids** Specialty Mode
-  **Lap** Specialty Mode
-  Single Dispersive electrode Status/Alarm Indicator for single monopolar dispersive electrodes.
-  Dual Dispersive electrode Status/Alarm Indicator for dual monopolar dispersive electrodes.
-  **Bipolar Output** Current Indicator
-  **Pulse Mode**



Remote Power Control Key:  
Press to enable or disable Remote Power Control.



**Program**



Program Store Key



Selection Scroll Button

#### 1.3.2 Interior



Protective Earth (Inlet Connector)



High Voltage Circuitry

#### 1.3.3 Output/Control Panel



Dispersive Electrode – Connection for monopolar dispersive electrode.



ReadiPlug™ Universal Accessory Receptacle

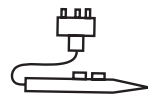

Hand-controlled Monopolar Output: Connection for hand-controlled monopolar accessories.



Bipolar Output: Connection for bipolar accessories.



Caution: High voltage output.



Type CF: Patient connections are isolated from earth and resist the effects of defibrillator discharge.



RF Isolated: Patient connections are isolated from earth at high frequency.



Consult accompanying documents prior to placing equipment in service.



- | Power on: connected to the mains.
- Power off: disconnected from the mains.

**1.3.4 Rear Panel**

**IPX1** Enclosure resists entry of vertically falling water.



Consult accompanying documents prior to placing equipment in service.



This equipment intentionally supplies non-ionizing RF energy for physiological effect.



Explosion risk if used in the presence of flammable anesthetics.



Do not operate in oxygen enriched environments.



Bipolar Footswitch Connector.

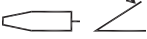

Monopolar Footswitch Connector.



Activation relay connector.



Equipotential Ground Terminal.



Replace fuse only with type and rating as shown.



Caution - High Voltage Inside - Refer servicing to qualified personnel.



Serial Interface Connector.



Volume control: Bipolar Activation tone.



Volume control: Activation tone.



Volume increase/decrease.



Medical Electrical Equipment: With respect to electric shock, fire and mechanical hazards only in accordance with UL2601-1/CAN/CSA C22.2 NO. 601.1 380X



### 1.4 Output Characteristic Curves

Figure 1.1 illustrates output power delivered to rated load for all available modes. Figure 1.2 illustrates the maximum peak voltage available at a given power setting and output mode. Section 1.2 specifies rated loads and maximum power for each mode, while figures 1.3 – 1.11 illustrate output power delivered to a range of load resistances for each mode.

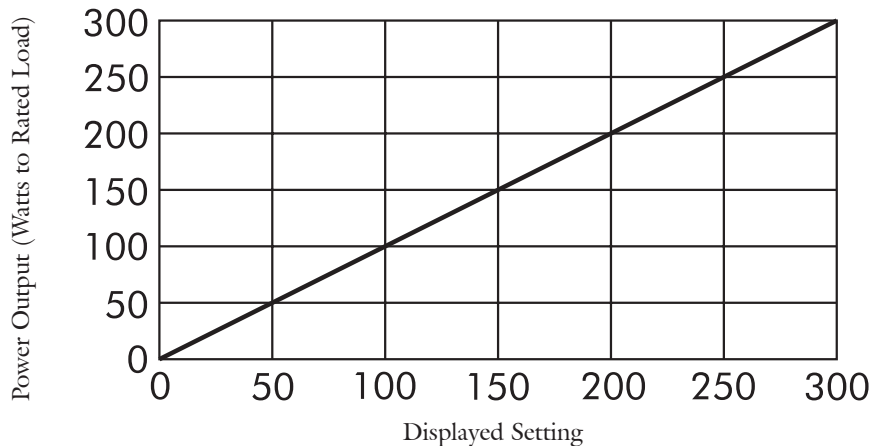

Figure 1.1 Output Power vs. Power Setting

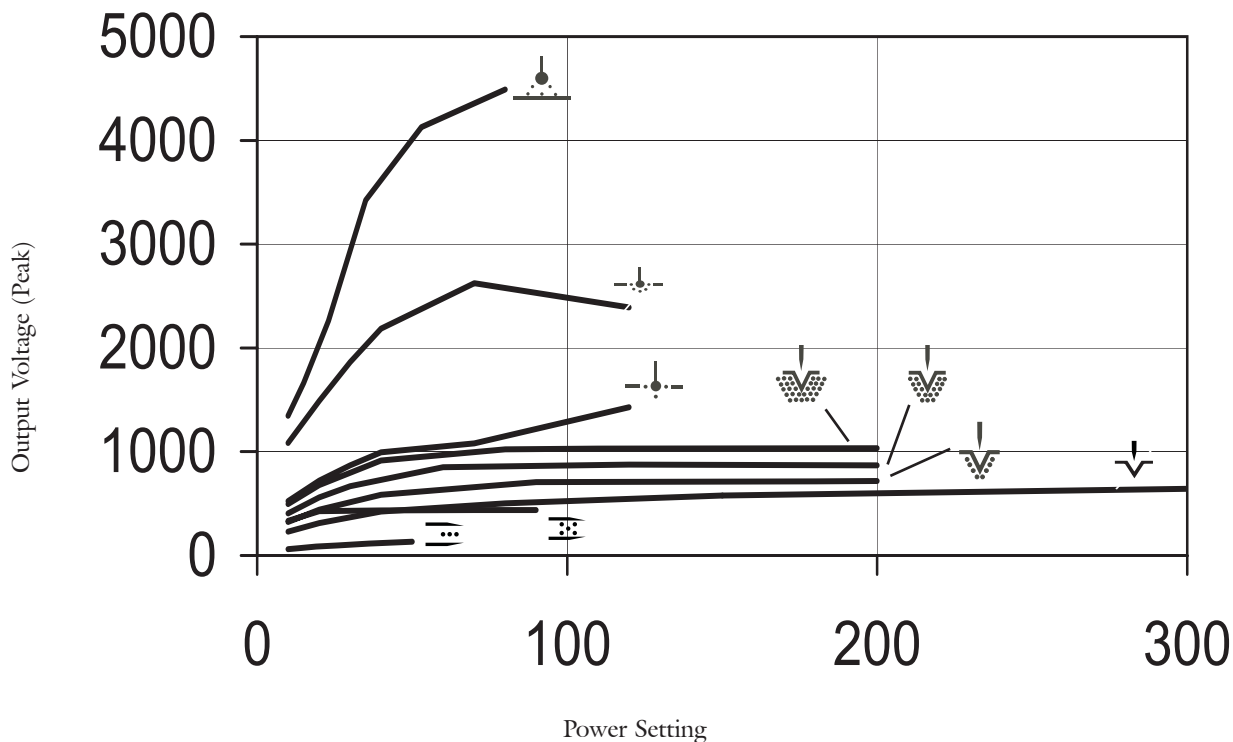

Figure 1.2 Display vs. Open Circuit Peak Voltage



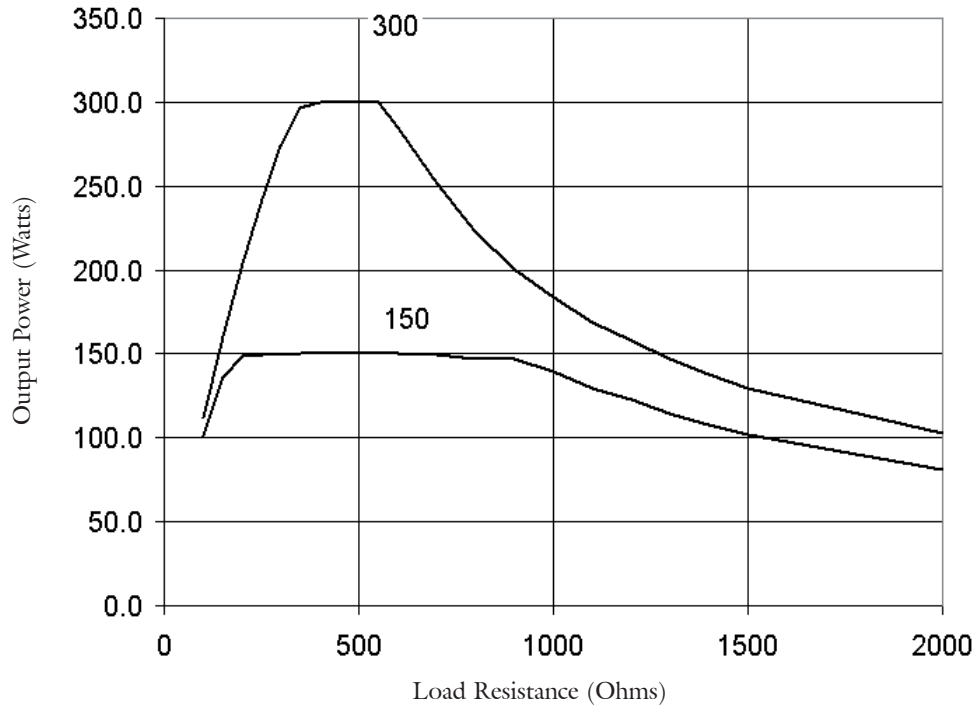

Figure 1.3 Load Regulation, Monopolar Pure Cut

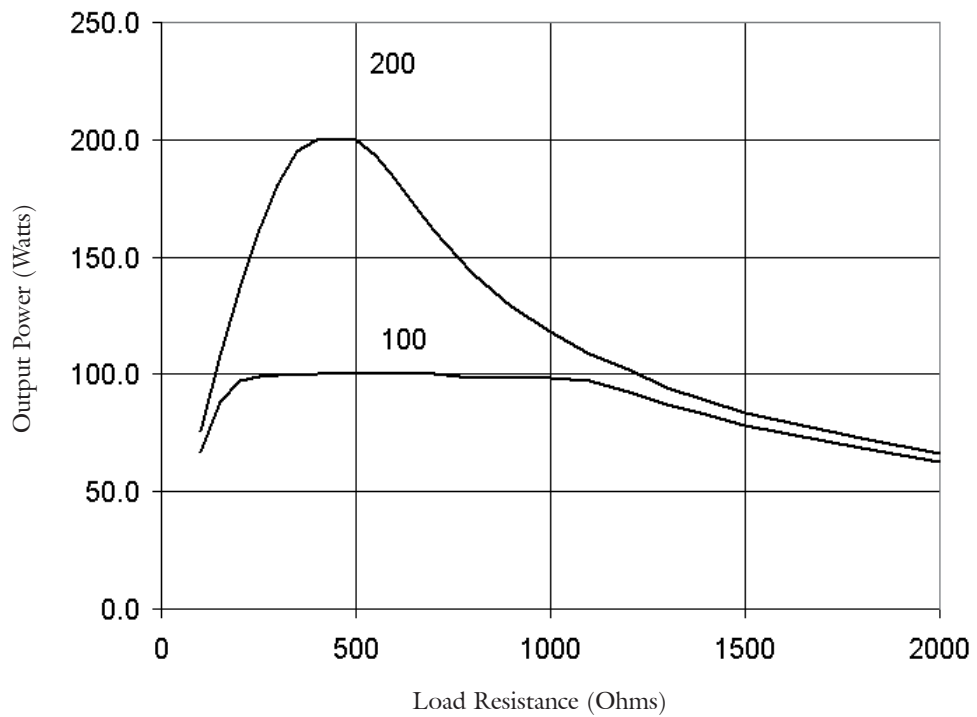

Figure 1.4 Load Regulation, Monopolar Blend 1



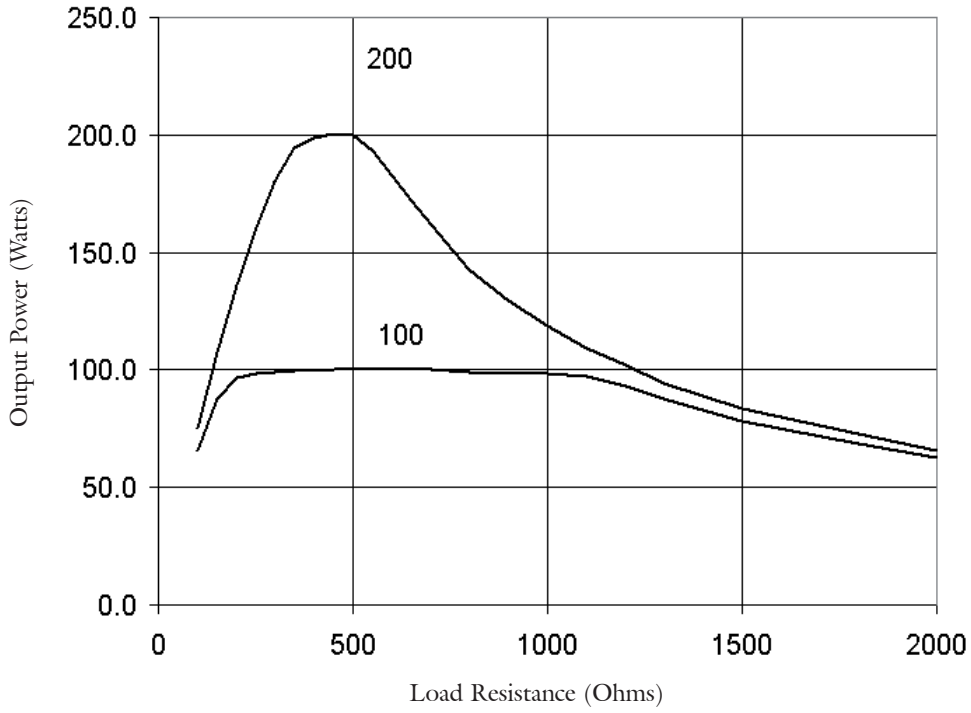

Figure 1.5 Load Regulation, Monopolar Blend 2

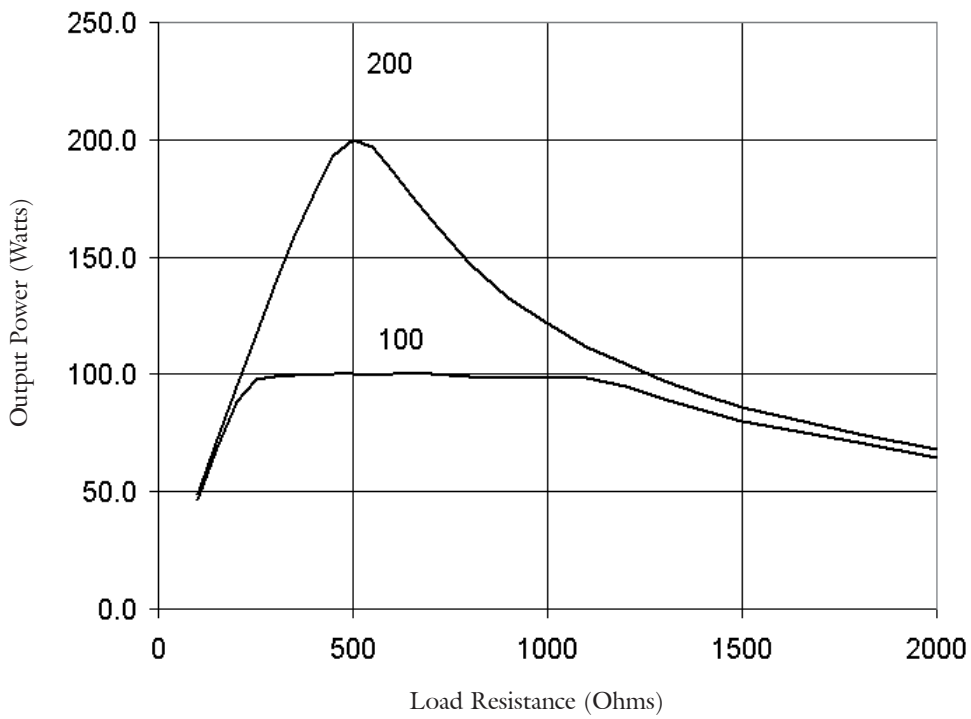

Figure 1.6 Load Regulation, Monopolar Blend 3





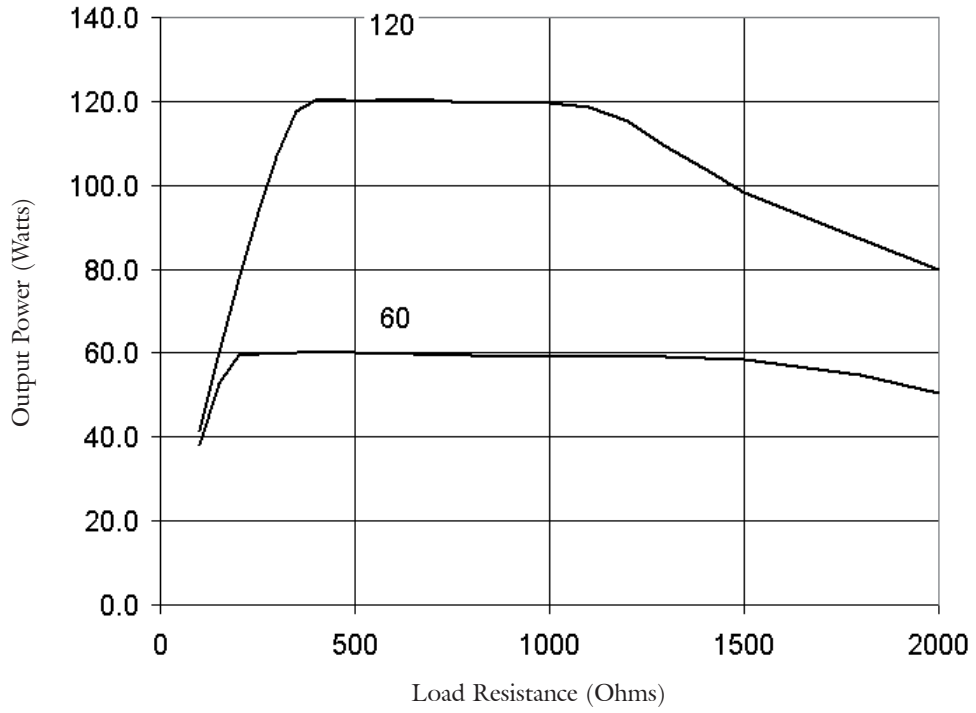

Figure 1.7 Load Regulation, Monopolar Pinpoint Coag

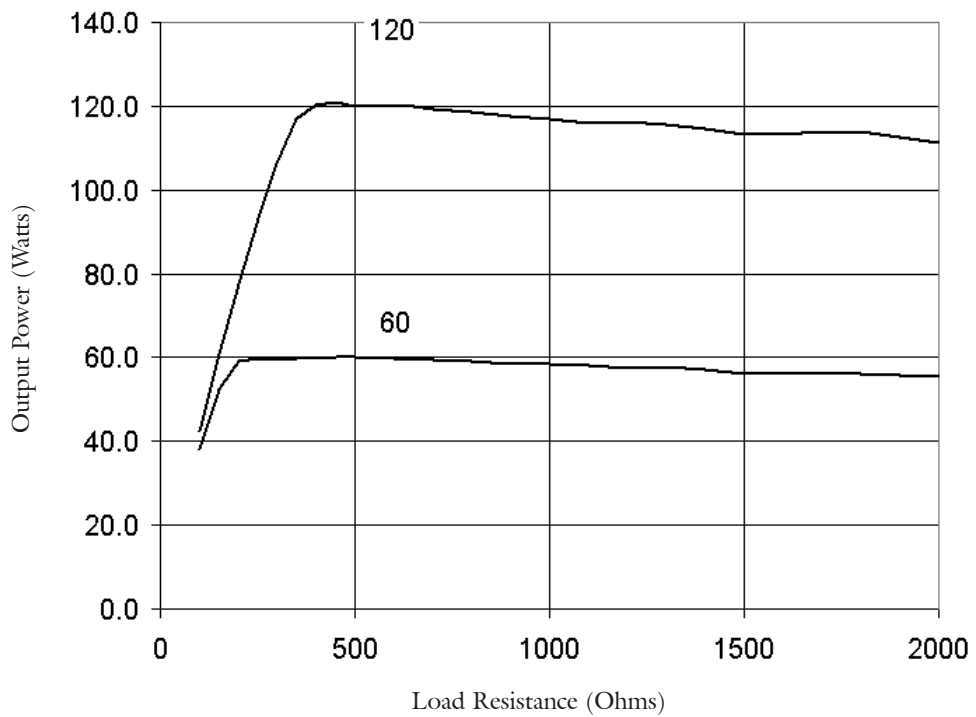

Figure 1.8 Load Regulation, Monopolar Standard Coag



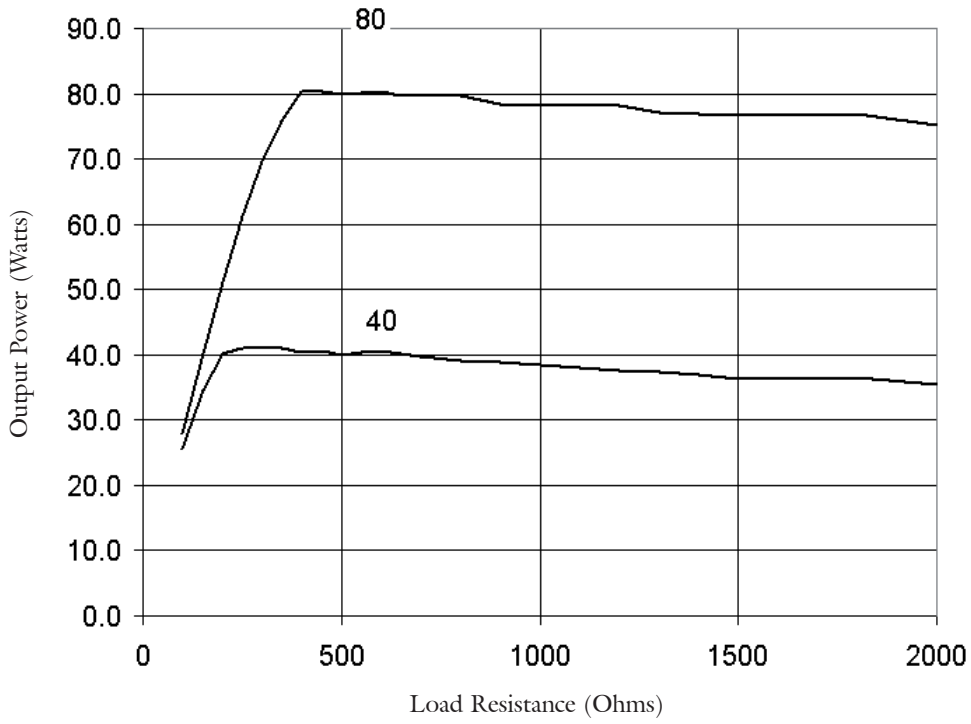

Figure 1.9 Load Regulation, Monopolar Spray Coag

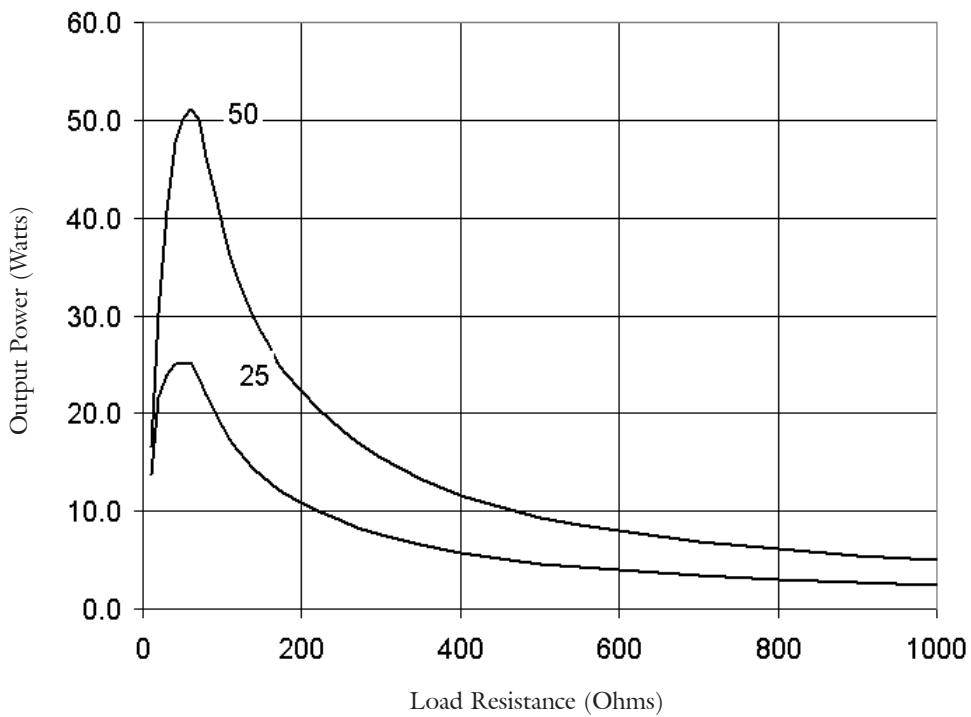

Figure 1.10 Load Regulation, Bipolar Micro



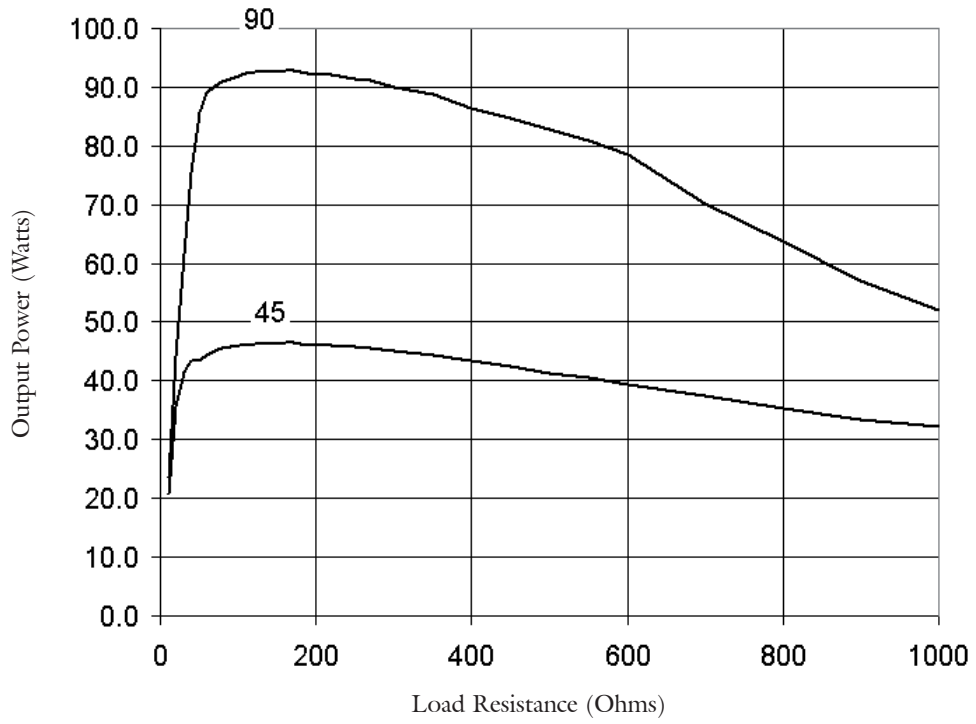

Figure 1.11 Load Regulation, Bipolar Macro

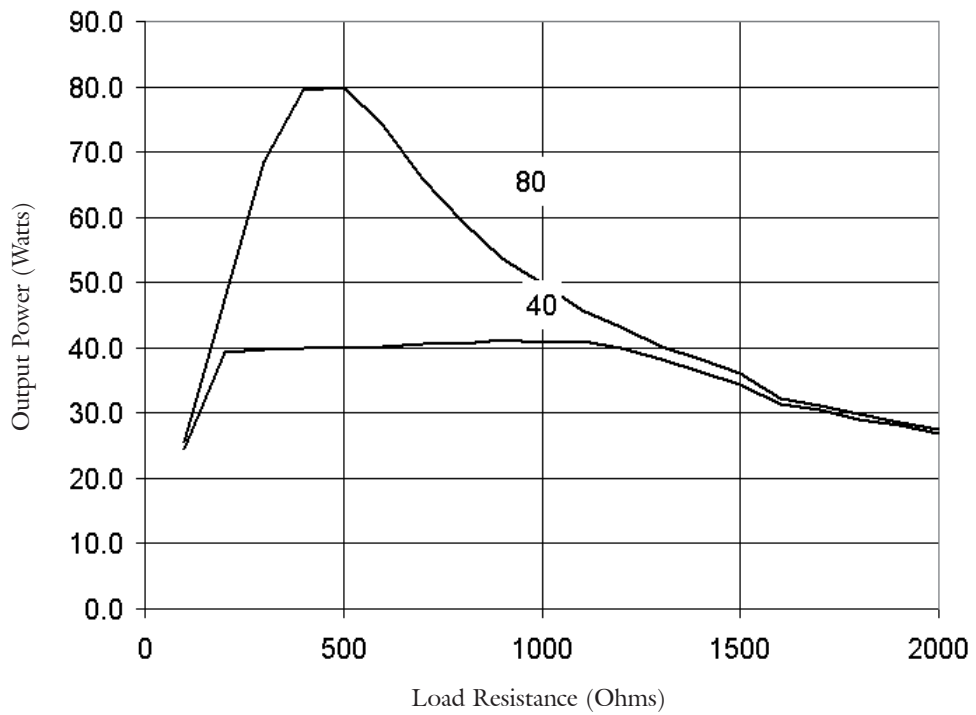

Figure 1.12 Load Regulation, Lap Spray



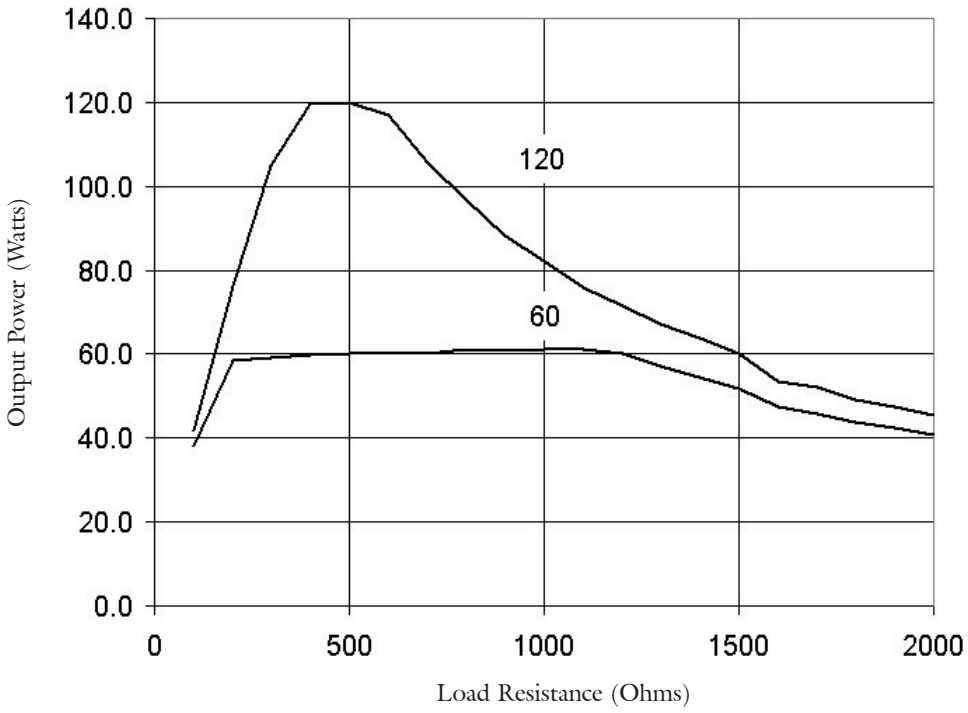

Figure 1.13 Load Regulation, Lap Standard



# *Installation and Operation*

## *Section 2.0*

This section contains initial installation, preliminary checks and operating instructions for the System 5000™.

### **2.1 Initial Inspection**

Unpack the ESU upon receipt and physically inspect it for any obvious damage that may have occurred during shipment. A Hospital Qualified Biomedical Technician should perform this inspection. Notify the carrier and your CONMED representative immediately if damage is found.

### **2.2 Installation**

The ESU may be mounted on a matching mobile pedestal or any stable mobile pedestal or table.

#### **2.2.1 Installation Of Fuses**

Outside of the U.S., proper fuses must be installed prior to connection to any power source. Install fuses in the following manner:

- a) Ensure the power cord is disconnected from the ESU.
- b) Locate the fuses that are packaged with the ESU. There will be three sets of fuses provided:
  - 8.0 A for installations with nominal mains voltages of 100 VRMS (Part number 62-4236-800).
  - 6.3 A for installations with nominal mains voltages of 115 VRMS (Part number 62-4236-630).
  - 3.15 A for installation with nominal mains voltages of 230 VRMS or greater (Part number 62-4236-315).

Choose the correct fuses for the mains voltage in the location where the ESU will be used.

- c) Use a flat blade screwdriver to remove the covers from each of the two FUSE RECEPTACLES by turning the covers approximately ¼ turn to the left.
- d) Insert one of the chosen fuses in each of the two FUSE RECEPTACLE covers.

- e) Re-insert the two FUSE RECEPTACLE covers, with fuses installed, into the FUSE RECEPTACLES.
- f) Use a flat blade screwdriver to gently push each of the two covers into the FUSE RECEPTACLES and rotate each one approximately ¼ turn to the right to lock them in place.
- g) Connect the power cord to the back of the ESU. Installation of the ESU may now be completed.

#### **WARNING**

**THE POWER CORD OF THE ESU SHOULD BE CONNECTED TO A PROPERLY POLARIZED AND GROUNDED POWER SOURCE WHOSE VOLTAGE AND FREQUENCY CHARACTERISTICS ARE COMPATIBLE WITH THOSE LISTED ON THE NAMEPLATE OF THIS ESU.**

**CAUTION:** Since the ESU depends on both natural convection and forced air for cooling, it should not be installed in a cabinet or similar enclosure. If mounted on a shelf or otherwise near a wall, allow a two-inch clearance around and above the ESU to permit free circulation of air along the sides of the ESU.

### **2.3 Preliminary Checks**

Prior to initial installation and use of this ESU, performance of the device should be tested in accordance with this manual. Results of that testing should be compared to the results tabulated on the factory Test Data Sheet supplied with each ESU. This data should be retained for future reference and comparison.

#### **2.3.1 Preliminary Functional Testing**

The following checks are recommended upon initial installation of the equipment and prior to each use of the instrument to avoid unnecessary delays in surgery. See Figure 2.1 for location of controls and connectors.



1. Ensure the power switch is OFF and no accessories are connected.
2. Connect the power cable to a properly grounded and polarized mating power receptacle of the proper voltage and frequency.
3. Connect a CONMED dual-treadle monopolar footswitch and a single treadle CONMED bipolar footswitch to their mating connectors at the rear of the ESU. Note: Use only CONMED Electrosurgery footswitches. Although other types may fit, they may not be functionally compatible.
4. Make no connection to the dispersive electrode receptacle at this time.
5. Set the Power Switch to the ON (“|”) position. As the ESU goes through the internal self-diagnostics, it should respond by:
  - a) Sounding a series of test tones.
  - b) During the test tone, displaying a total of nine “8’s” on the four digital displays.
  - c) Illuminating all three activation indicators, all eight key indicators, two dispersive electrode indicators and the entire dual dispersive electrode contact quality BARGRAPH.
  - d) After the display test, the ESU will show the software revision level in the COAG display window. The ESU is conducting a power-on self-test during this interval.
  - e) If there are no errors, normal operational parameters will then be displayed.
6. Depress the Cut treadle of the monopolar footswitch. The dispersive electrode alarm should sound and dispersive electrode indicators should flash alternating red. While holding the Cut treadle, rotate the volume control over its full range and verify there is no significant change in sound level. Release the Cut footswitch and the tone should stop.
7. Select each of the modes by pressing the Mode Scroll Keys and note the displayed power settings for each mode in the corresponding displays.
8. Verify that the Pure Cut Mode can be selected and adjusted up and down by:
  - Pressing the Cut Mode Scroll Key until the Pure Cut Activation indicator is illuminated.
  - Pressing the Monopolar Cut Power Adjustment Keys to increase and decrease the setting while verifying that the display changes appropriately and verifying that no other displays change.
  - Pressing the Cut Mode Scroll Key and verifying that the settings for each of the other modes were not changed by changing the Pure Cut Mode power setting.
9. Verify that each of the other modes can be selected and adjusted up and down in the same manner as the Pure Cut Mode described above. The other modes include:
  - Blend 1
  - Blend 2
  - Blend 3
  - Pinpoint Coag
  - Standard Coag
  - Spray Coag
  - Bipolar Micro
  - Bipolar Macro
  - Pulse Cut
  - Pulse Coag
  - FLUIDS Specialty Mode
  - LAP Specialty Mode

Return all settings to the desired setting.
10. Select each of the specialty modes by pressing the Specialty Mode Scroll Key and verifying that the selected specialty mode scrolls through General, Fluids, and Lap. Verify that the displayed power settings for each specialty mode can be changed independently of the other modes by adjusting the cut, coag, or bipolar power. Return all settings to the desired setting and return the specialty mode to General before proceeding.
11. Depress the bipolar footswitch. Confirm that the Bipolar Activation indicator illuminates and a bipolar activation tone is sounded. While continuing to depress the bipolar footswitch, rotate the Volume Control over its full range to verify the function of that control and that sound is audible at all positions. This control may be left at any desired position. Release the bipolar footswitch and confirm the System 5000™ returns to its idle state. Set the bipolar power setting to 1 watt and verify the bipolar hand control is func-





tional by use of the appropriate forceps or by connecting a jumper between the center and right hand Bipolar Output receptacle on the Output Panel. The effect will be identical to depressing the bipolar footswitch.

12. Verify that the Single and Dual Dispersive Electrode Status / Alarm Indicators alternately flash red. Connect a single dispersive electrode to the Dispersive Electrode Receptacle. Confirm the Single Dispersive Electrode Status / Alarm Indicator is steady green.
13. Depress the Cut treadle of the Monopolar footswitch. The yellow Cut Activation indicator should light and the cut activation tone should sound.
14. While continuing to press the Cut treadle of the footswitch, press the Coag treadle. The yellow Cut Activation indicator should remain illuminated and the Cut activation tones should continue. Release the Cut treadle while continuing to press the Coag treadle and confirm that the yellow Cut Activation indicator extinguishes, the blue Coag Activation indicator illuminates and the activation tone changes from Cut to Coag. Release the coag treadle and verify that the display returns to normal. Press the Coag treadle and verify that the blue Coag Activation indicator illuminates until the Coag treadle is released.
15. Connect a hand-controlled accessory to one of the Monopolar Accessory Receptacles. Activate the Cut and Coag buttons on the accessory, one at a time, verifying that each control causes the correct indicator and tone to sound. Move the hand-controlled accessory to the other Monopolar Accessory Receptacle and repeat.
16. Disconnect the single dispersive electrode and confirm that the System 5000™ beeps three times and the Single and Dual Dispersive Electrode Status / Alarm Indicators alternately flash red.

### 2.3.2 Preliminary Performance Testing

After the ESU passes the Preliminary Functional Tests of Section 2.3.1, preliminary performance testing may be conducted. Such testing is best carried out by use of an electro-surgical generator tester. Use a non-inductive resistor with the same value as the rated generator output impedance for

the best accuracy of the tester. (See Specifications, Section 1.2).

If no tester is convenient, the availability of therapeutic current may be ascertained subjectively by attempting to cut and coagulate on surrogate tissue such as a piece of meat or fresh fruit, a wet bar of soap or a sponge moistened with saline.

## 2.4 Controls, Displays and Connectors

The numbers preceding the following paragraphs correspond to the numbered items in Figures 2.1, 2.2 and 2.3.

### 2.4.1 Control Panel

All controls, except for the volume controls, are located on the front control panel. Figure 2.1 illustrates the Universal Symbols control panel. Your control panel may be in English.

#### 1. DUAL DISPERSIVE ELECTRODE

**STATUS / ALARM INDICATOR:** Indicates the status of a dual dispersive electrode when the dual dispersive electrode is connected to the ESU. This indicator is made up of a STATUS INDICATOR and a BARGRAPH, which indicates the relative quality of the dual dispersive electrode application.

The STATUS INDICATOR will flash red prior to connection of any dispersive electrode or connection of a dual dispersive electrode that is not applied to the patient. This indicator will flash green after a dual dispersive electrode is applied to the patient and the contact quality of the dual dispersive electrode is at an acceptable level. The status indicator will illuminate steady green upon first activation using a hand control or footswitch with a dual dispersive electrode that is installed and connected with acceptable contact quality.

Prior to activation, the BARGRAPH will show a relative measure of the contact quality between the two elements of the dual dispersive electrode. Good contact quality is indicated by illumination of many segments, while poor contact quality will illuminate fewer segments. Acceptable contact quality to enable safe use of the ESU will be indicated by illumination of one or more segments. All of the BARGRAPH segments will be illuminated upon activation with an acceptably installed and connected dispersive electrode. Fewer segments of the bar graph will



be illuminated as the contact quality of the dispersive electrode deteriorates; as a result, the Dual Dispersive Electrode Status / Alarm Indicator gives a relative measure of contact quality as the procedure progresses.

If the contact quality deteriorates to a level that is unacceptable, all BARGRAPH segments will be extinguished, the STATUS INDICATOR will flash red and an alarm will sound.

2. SINGLE DISPERSIVE ELECTRODE STATUS / ALARM INDICATOR: Indicates the status of a single dispersive electrode when the single dispersive electrode is connected to the ESU. This STATUS INDICATOR will flash red prior to connection of any dispersive electrode. This STATUS INDICATOR will illuminate steady green after a single dispersive electrode is acceptably connected to the ESU.

**WARNING**

**THE SINGLE DISPERSIVE ELECTRODE STATUS / ALARM INDICATOR DOES NOT PROVIDE ANY INDICATION OF THE CONTACT QUALITY BETWEEN THE SINGLE DISPERSIVE ELECTRODE AND THE PATIENT.**

If the quality of connection between the ESU and the single dispersive electrode deteriorates to a level that is unacceptable, this STATUS INDICATOR will flash red and an alarm will sound.

3. GENERAL MODE INDICATOR: This default mode illuminates when no Specialty modes are selected.
4. FLUIDS SPECIALTY MODE INDICATOR: Illuminates when Fluids Specialty Mode is selected.
5. LAP SPECIALTY MODE INDICATOR: Illuminates when Lap Specialty Mode is selected
6. PROGRAM INDICATOR: Indicates the selected program.
7. SPECIALTY MODE SCROLL KEY: Pressing this key will scroll between General mode, Fluids mode and Lap mode.
8. PROGRAM SELECT SCROLL KEY: Pressing this key will scroll between the stored program locations.
9. PROGRAM STORE KEY: Stores the current settings into the selected program location.
10. PURE CUT ACTIVATION INDICATOR: Illuminates when monopolar Pure Cut Mode has been selected.

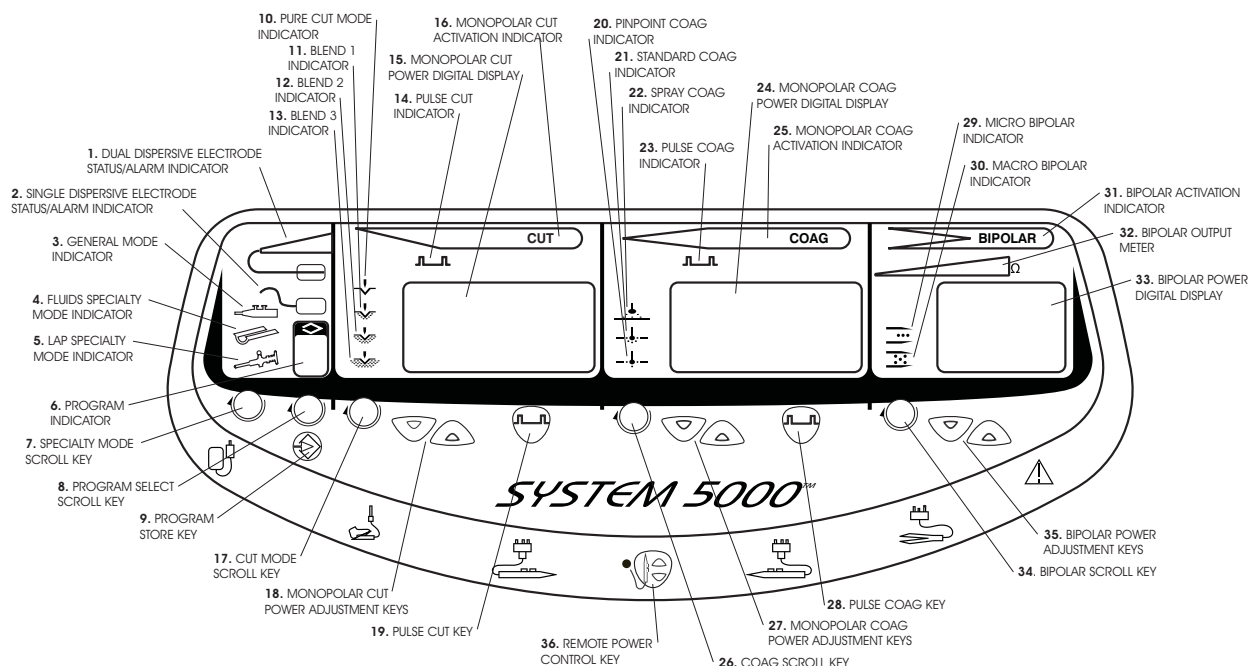

Figure 2.1 Control Panel



11. BLEND 1 INDICATOR: Illuminates when monopolar Blend 1 is selected.
12. BLEND 2 INDICATOR: Illuminates when monopolar Blend 2 is selected.
13. BLEND 3 INDICATOR: Illuminates when monopolar Blend 3 is selected.
14. PULSE CUT INDICATOR: Illuminates when Pulse Cut is selected.
15. MONOPOLAR CUT POWER DIGITAL DISPLAY: Indicates the power setting for the currently selected monopolar cut mode.
16. MONOPOLAR CUT ACTIVATION INDICATOR: This yellow indicator lights when the ESU is activated in a monopolar cut mode.
17. CUT MODE SCROLL KEY: Pressing this key will scroll through the Cut Modes: Pure, Blend 1, Blend 2 and Blend 3.
18. MONOPOLAR CUT POWER ADJUSTMENT KEYS: Adjusts the output power setting of the selected cut mode.
19. PULSE CUT KEY: Pressing this key will select or deselect Pulse Cut.
20. PINPOINT COAG INDICATOR: Illuminates when monopolar Pinpoint coagulation has been selected.
21. STANDARD COAG INDICATOR: Illuminates when monopolar Standard coagulation has been selected.
22. SPRAY COAG INDICATOR: Illuminates when monopolar Spray coagulation has been selected.
23. PULSE COAG INDICATOR: Illuminates when Pulse Coag is selected.
24. MONOPOLAR COAG POWER DIGITAL DISPLAY: Indicates the power setting in the currently selected monopolar coagulation mode.
25. MONOPOLAR COAG ACTIVATION INDICATOR: This blue indicator lights when the ESU is activated in a monopolar coagulation mode.
26. COAG SCROLL KEY: Pressing this key will scroll through the Coag Modes: Pinpoint, Standard and Spray.
27. MONOPOLAR COAG POWER ADJUSTMENT KEYS: Adjusts the output power setting of the selected coagulation mode.
28. PULSE COAG KEY: Pressing this key will select or deselect Pulse Coag.
29. MICRO BIPOLAR INDICATOR: Illuminates when micro bipolar is selected.
30. MACRO BIPOLAR INDICATOR: Illuminates when Macro Bipolar is selected.
31. BIPOLAR ACTIVATION INDICATOR: This indicator lights when the ESU is activated in the bipolar mode.
32. BIPOLAR OUTPUT METER: This bar graph display provides a measure of the tissue resistance.
33. BIPOLAR POWER DIGITAL DISPLAY: Indicates the bipolar mode power level set via the Bipolar Power Adjustment Keys.
34. BIPOLAR SCROLL KEY: Pressing this key will scroll through the Bipolar Modes: Macro and Micro.
35. BIPOLAR POWER ADJUSTMENT KEYS: Adjusts the output power level of the selected bipolar mode.
36. REMOTE POWER CONTROL KEY: Pressing this key will select or deselect Remote Power Control. REMOTE POWER CONTROL INDICATOR: Illuminates when Remote Power Control is selected.

#### 2.4.2 Output Panel

The output panel contains the power switch and the accessory receptacles. The receptacles are illuminated to aid in the insertion of the connectors in low light conditions. Refer to Figure 2.2.

37. DISPERSIVE ELECTRODE RECEPTACLE: This receptacle accepts a standard two-pin single or dual dispersive electrode plug.
38. REDIPLUG™ UNIVERSAL ACCESSORY RECEPTACLE: This receptacle accepts accessory cables equipped with standard active (Bovie #12) plugs, standard 4mm banana plugs or pin-tip style disposable connectors without the necessity of special adapters.
  - Banana plugs can be inserted and removed directly without pushing the button.
  - To insert a Bovie #12 plug, you must push the button adjacent to the receptacle, insert the plug fully and release the button. **IMPORTANT:** When removing a Bovie #12 plug, you **must press the button** while pulling the plug out.



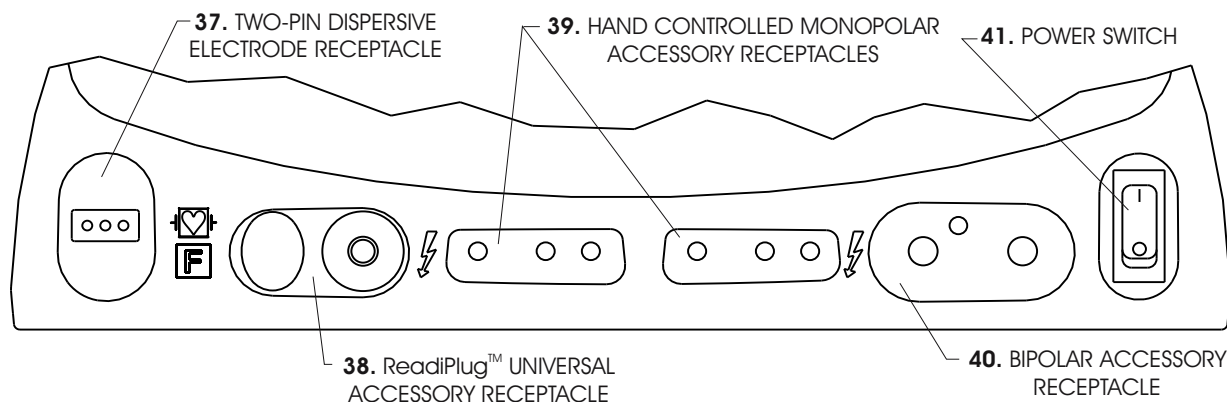

Figure 2.2 Output Panel

- When handling the pin-tip style plug, hold the wire about 3 inches (7.6 cm) from the tip and push the button while inserting the tip. **IMPORTANT:** Verify proper insertion by tugging gently on the plug to ensure that the ReadiPlug™ mechanism has properly retained the tip. To remove the pin-tip, **you must press the button** while pulling the plug out.
- This receptacle can only be activated by the monopolar footswitch.

#### WARNING

**NEVER CONNECT MORE THAN ONE ACCESSORY AT A TIME TO THIS RECEPTACLE.**

- 39. HAND-CONTROLLED MONOPOLAR ACCESSORY RECEPTACLE:** Two independent receptacles are provided for the connection of hand-controlled monopolar accessories. Only by the accessories connected to them may activate these receptacles.
- 40. BIPOLAR ACCESSORY RECEPTACLE:** Bipolar output is activated by the bipolar foot-controlled or by hand-controlled bipolar accessories. CONMED accessories with fixed connection style plugs are recommended for this receptacle. For legacy connections with two banana plug leads, connect these active bipolar forceps leads to the outside connections.
- 41. POWER SWITCH:** Primary power switch for turning the ESU on and off.

#### 2.4.3 Rear Panel

The rear panel contains the footswitch connectors, power cord connector, fuses, volume controls and a carrying handle. Refer to Figure 2.3.

- 42. CARRYING HANDLE**
- 43. SPEAKER:** Sound from the speaker emanates from this location.
- 44. NAMEPLATE:** Specifies model number, serial number, nominal line voltages, frequency, current and fuse rating information.
- 45. FAN:** Forced air from the temperature-controlled fan is expelled in this location.
- 46. BIPOLAR FOOTSWITCH CONNECTOR:** A 3-pin threaded connector designed to accept any CONMED Electrosurgery single-treadle bipolar footswitch.
- 47. MONOPOLAR FOOTSWITCH CONNECTOR:** This 4-pin threaded connector is designed to accept plugs attached to any dual treadle monopolar footswitch available from CONMED Electrosurgery. Use only CONMED Electrosurgery footswitches. Other manufacturer's footswitches may not be compatible.
- 48. ACTIVATION RELAY CONNECTOR:** A receptacle for actuating smoke evacuators and similar devices when delivering electrosurgical output. The maximum contact rating for this receptacle is 1 amp at 24 volts DC. Verify that devices connected to this output function properly in a manner that is synchronized with ESU power delivery prior to use.



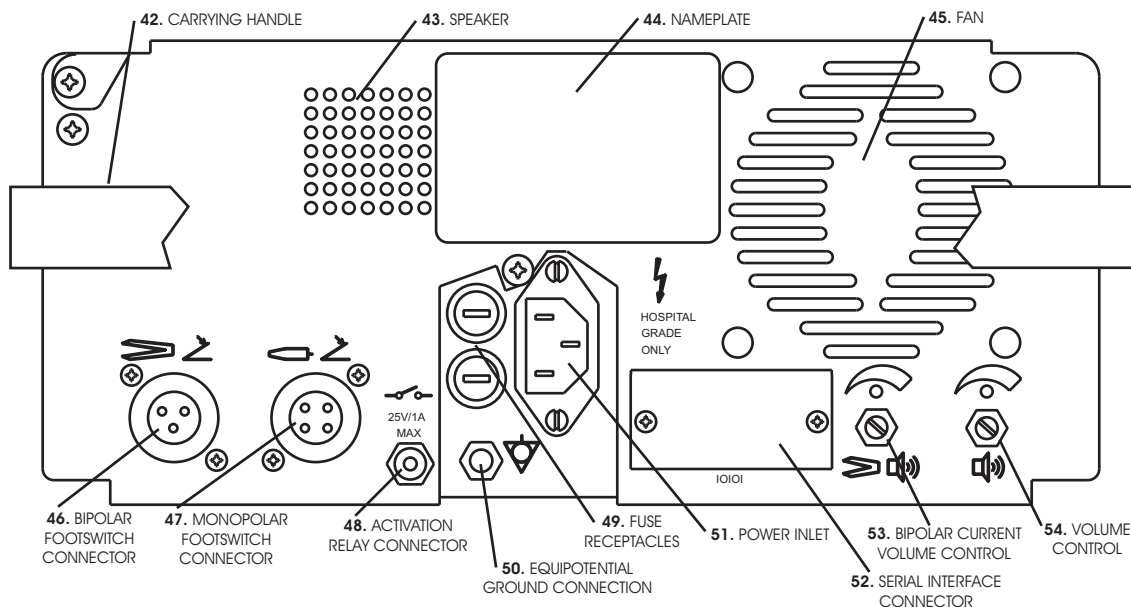

Figure 2.3 Rear Panel

49. FUSE RECEPTACLES: For installation of two mains fuses with ratings as noted in Section 2.2.1.

50. EQUIPOTENTIAL GROUND CONNECTION: Chassis ground connection suitable for attachment of standard auxiliary grounding cable when required for additional protection against low frequency risk current.

51. POWER INLET: Supplies AC mains power to the ESU. It should only be connected to a source of power corresponding to that listed on the nameplate.

52. SERIAL INTERFACE CONNECTOR: This connector provides a means of connection with operating room control centers. Only equipment approved by CONMED should be connected to this interface. Contact your CONMED Sales Representative or CONMED Customer Service at the numbers listed on the inside front cover of this manual.

53. BIPOLAR VOLUME CONTROL: Controls the volume of the special tones produced during bipolar electrosurgery. Rotation to the right increases the volume. Does not affect volume of alarm tones.

54. VOLUME CONTROL: Controls the volume of the tones produced during normal activation of the ESU. Rotation to the right

increases the volume. It does not affect the volume of alarm tones.

## 2.5 Set Up For Use

1. Ensure the Power Switch is OFF, and then connect the power cable to a properly grounded and polarized mating power receptacle. Do not connect a dispersive electrode at this time.
2. Inspect and connect the desired monopolar or bipolar accessories to the connectors on the front of the ESU. Refer to Figure 2.2.

### WARNING

**ALWAYS STOW UNUSED ACCESSORIES IN A SAFE, INSULATED LOCATION SUCH AS A HOLSTER. DO NOT PLACE ACTIVE ACCESSORIES ON THE PATIENT.**

3. Connect the footswitches, as required, to the rear of the ESU (not required if only hand-controlled accessories are to be used). Use only CONMED Electrosurgery footswitches.
4. Set the Power Switch to the ON position. As the ESU goes through its internal self-diagnostics, confirm the machine responds by:
  - a) Sounding a test tone.
  - b) During the test tone, displaying a total of nine "8's" on the four digital displays.





c) Illuminating all three activation indicators, all eight key indicators, two dispersive electrode indicators and the entire dual dispersive electrode contact quality BARGRAPH.

d) After the display test, the ESU will show the software revision level in the COAG display window. The ESU is conducting a power-on self-test during this interval.

After the power-on self-tests, the ESU is ready for use. If the ESU sounds a pulsating high tone, displays an "Err" fault code or otherwise fails to respond as above, the ESU has failed one of its internal tests and is not suitable for use. Before turning the power off, note the "Err" code displayed in the Power Displays to assist in the diagnosis by a Hospital Qualified Biomedical Technician. ACC codes can often be corrected by operating room staff, see Section 2.7.2. Contact your Hospital Qualified Biomedical Technician for repair if an "Err" code appears.

5. When using monopolar modes, select and prepare the patient dispersive electrode site and apply the dispersive electrode in full contact with the patient and in accordance with the manufacturer's instructions. If no instructions are given, observe the guidelines provided in Section 1.0 of this manual. A dispersive electrode need not be connected if only BIPOLAR operation is required.

**Caution: The use and proper placement of a dispersive electrode is a key element in safe and effective electrosurgery. Follow manufacturer's directions and recommended practices for the preparation, placement, use, surveillance and removal of any dispersive electrode supplied for use with this electrosurgical unit.**

6. Apply the dispersive electrode over a well-vascularized muscle mass that is thoroughly clean and dry. Clean and clip site, as necessary, to provide adequate electrical connection and per hospital policy. Avoid placement over scar tissue, bony prominences or other areas where pressure points on small areas might develop.
7. Inspect and connect the plug of the dispersive electrode cable to the Dispersive Electrode Receptacle or to an appropriate adapter.

NOTE: This ESU incorporates A.R.M.™ circuitry. The monitor will inhibit monopolar operation of the ESU if its requirements for

the dispersive electrode have not been satisfied (see instruction 8).

8. The A.R.M.™ dispersive electrode contact quality monitor can automatically detect and accept either single dispersive electrodes or dual dispersive electrodes.

The Single Dispersive Electrode Status / Alarm Indicator indicates the status of a single dispersive electrode when the single dispersive electrode is connected to the ESU. This STATUS INDICATOR will flash red prior to connection of any dispersive electrode. This STATUS INDICATOR will illuminate steady green after a single dispersive electrode is acceptably connected to the ESU. The Single Dispersive Electrode Status / Alarm Indicator DOES NOT provide any indication of the contact quality between the single dispersive electrode and the patient.

If the connection between the ESU and the single dispersive electrode is broken, the Single Dispersive Electrode STATUS INDICATOR will flash red and an alarm will sound.

The DUAL DISPERSIVE ELECTRODE STATUS / ALARM INDICATOR indicates the status of a dual dispersive electrode when the dual dispersive electrode is connected to the ESU. This indicator is made up of a BARGRAPH, which indicates the relative quality of the dual dispersive electrode application and a STATUS INDICATOR.

The STATUS INDICATOR will flash red prior to connection of any dispersive electrode or connection of a dual dispersive electrode that is not applied to the patient. This STATUS INDICATOR will flash green after a dual dispersive electrode is applied and the measured impedance between the dual dispersive electrodes is at an acceptable level. The STATUS INDICATOR will illuminate steady green upon first activation using a hand control or footswitch with a dual dispersive electrode that is installed and connected with acceptable contact quality.

Prior to activation, the BARGRAPH will show a relative measure of the contact quality between the two elements of the dual dispersive electrode. Good contact quality is indicated by illumination of many segments, while poor contact quality will illuminate



fewer segments. Acceptable contact quality to enable safe use of the ESU will be indicated by illumination of one or more segments. All of the BARGRAPH segments will be illuminated upon activation with an acceptably installed and connected dispersive electrode. Fewer segments of the BARGRAPH will be illuminated as the contact quality of the dispersive electrode deteriorates; as a result, the Dual Dispersive Electrode Status / Alarm Indicator gives a relative measure of contact quality as the procedure progresses.

If the contact quality deteriorates to a level that is unacceptable, all BARGRAPH segments will be extinguished, the Dual Dispersive Electrode Status / Alarm Indicator will flash red and an alarm will sound.

When alarm occurs, physically confirm proper dispersive electrode-to-patient contact. Smooth the dispersive electrode surface with hand to improve electrode contact to patient's skin. Green bar graph segments will indicate improved patient contact. Replace the dispersive electrode if dispersive electrode status/ alarm indicator continues to flash red.

#### **WARNING**

**DO NOT DEPEND SOLELY ON THE DUAL DISPERSIVE ELECTRODE STATUS / ALARM INDICATOR FOR CONFIRMATION OF GOOD DISPERSIVE ELECTRODE APPLICATION. QUALIFIED PERSONNEL SHOULD MAKE THE FINAL DECISION ON PROPER DISPERSIVE ELECTRODE PLACEMENT.**

9. The ESU powers up to the last settings at the time the ESU was last activated. Note: Power up to "0" setting is a configuration option that may be selected by a Hospital Qualified Biomedical Technician. Verify that the ESU is properly adjusted with the desired mode selected. Adjust the settings as needed. The ESU is now ready for operation.
10. Scroll to the LAP Specialty Mode to limit output voltage during Laparoscopic procedures.
11. Scroll to the FLUIDS Specialty Mode to initiate cutting and coagulating during procedures conducted in fluid mediums.
12. Set the Monopolar Cut Mode to Pure for cutting or one of three Blend modes for desired cutting with hemostasis.
13. Set the Monopolar Coag Mode to PINPOINT to provide soft / low voltage contact coagulation, to STANDARD to provide a greater degree of contact desiccation (i.e. greater arcing) or to SPRAY for non-contact fulguration.
14. Scroll to BIPOLAR MACRO for normal bipolar tissue desiccation or scroll to BIPOLAR MICRO for delicate bipolar tissue desiccation with low voltage.
15. The Bipolar Output Meter provides a measure of tissue desiccation between the bipolar forceps tines by measuring tissue resistance. Higher tissue resistances indicate a greater degree of desiccation. Several illuminated segments indicates low desiccation, while fewer illuminated segments indicates higher desiccation. Few segments will be illuminated when bipolar power is first applied because the resistance of the tissue is high. As bipolar power continues, inter cellular fluid is released, which decreases the resistance causing more segments to illuminate. As the tissue between the bipolar tines becomes more desiccated, fewer elements of the bar graph will be illuminated. When the desiccation reaches a point where one element of the bar graph is illuminated, the Bipolar Output Tone will sound. Note: Depending on the volume of tissue between the tines, the Bipolar Output Meter movement could occur quite rapidly. Ensure that the tone volume is properly set prior to using the Bipolar Output Tone feature. Bipolar Output Tone volume can be set while activating in Bipolar mode with forceps open.
16. Select Pulse Cut for pulsing bursts of cut energy for precise dissection with minimal thermal necrosis.
17. Select Pulse Coag for pulsing bursts of coagulation energy for precise hemostasis in STANDARD or SPRAY modes. Pulse Coag cannot be selected while PINPOINT is selected.
18. Adjust the CUT, COAG, and BIPOLAR power settings to the desired levels in the following manner:



- To increment or decrement the power setting one step, momentarily press and release the desired CUT, COAG, or BIPOLAR Power Adjustment Key. The power setting will increase one step and a short tone will sound.
- To increase or decrease the power setting a number of steps, press and hold the desired CUT, COAG, or BIPOLAR Power Adjustment Key. For the first nine steps while the key is held, the power setting will increase or decrease in step increments with a short tone for each step. If the key is continuously held after the ninth step, power setting will increase or decrease at an accelerated rate, with a continuous tone, until the Power Adjustment Key is released.

If unsure of the proper settings, use low power settings initially and make adjustments intraoperatively according to the surgeon's requests. Use of a written record of each surgeon's preferred power setting for various procedures will expedite subsequent pre-op setup.

## 2.6 Operation

### 2.6.1 General

#### WARNING

**ENSURE THAT THE FOOTSWITCHES ARE NOT INADVERTENTLY DEPRESSED IN ORDER TO PREVENT ACCESSORIES FROM BEING UNINTENTIONALLY ACTIVATED. PLACE FOOTSWITCHES IN LOCATIONS THAT NECESSITATE DELIBERATE ACTION IN ORDER TO ACTIVATE THE FOOTSWITCH. USE CAUTION WHEN SELECTING THE CORRECT FOOTSWITCH TO ACTIVATE.**

Activate the electrosurgical unit in the desired operating mode by depressing the appropriate treadle of the footswitch or switch of a hand-controlled accessory. Adjust the corresponding power setting until the desired surgical effects are obtained.

Power setting changes are limited when the ESU is activated to the greater of 10 watts or 25% of the dial setting upon initiation of activation. The power setting will be displayed on the digital display for each mode.

The surgical effects obtained are dependent on a number of factors including waveform, electrode size, electrode geometry, power level and surgical technique. The size and geometry of monopolar electrodes are significant in that a large electrode, absent of sharp features (e.g.; a ball electrode) will have no tendency to cut, regardless of the output power level. Conversely, a small, sharp electrode, such as a needle or wire loop, will be likely to cut simply from mechanical pressure at conservative power settings. Note that other generator models will have different clinical effects than the System 5000™, even when power settings are the same.

The Bipolar Coagulation waveform is designed to minimize tissue sticking and popping by limiting the output voltage regardless of the power setting. Bipolar hemostasis is more localized than in monopolar since the tissue grasped between the forceps tines is most affected. This is particularly desirable in vascular surgery where monopolar current may concentrate in the affected vessel and result in undesired tissue effects. This easily controlled localization is also of benefit in plastic surgery and neurosurgery.

### 2.6.2 Monopolar Pulse Cut

Monopolar Pulse Cut provides pulsing bursts of cut energy for precise dissection.

In Monopolar Pulse Cut, Dissection will occur in 70 ms durations every 600 ms. Each pulse will typically dissect less than 1 mm depending on the power setting, the electrode size and type, and the mass of the tissue being dissected. Two distinct tones are audible during activation in Pulse Cut as described in Section 1.2.9. The power displayed on the dial is the power output during the pulses. While the pulsed nature makes the average power low, the power during pulses can be quite high.

#### WARNING

**COAG ACTIVATIONS WILL NOT BE PULSED WITH PULSE CUT SELECTED. SET THE MONOPOLAR COAG POWER TO 0 WHEN USING PULSE CUT TO ENSURE THAT AN ACCIDENTAL ACTIVATION OF COAG DOES NOT CAUSE PATIENT INJURY.**

#### WARNING

**CONFIRM THAT THE PULSE CUT MODE IS PROPERLY SELECTED PRIOR TO ACTIVATION TO ENSURE THAT IMPROPER APPLICATION DOES NOT**





**RESULT IN PATIENT INJURY. LISTEN FOR THE DISTINCT PULSE CUT ACTIVATION TONE DURING ACTIVATION TO CONFIRM PULSE CUT IS INDEED ACTIVE.**

### 2.6.3 Monopolar Pulse Coag

Monopolar Pulse Coag provides pulsing bursts of coagulation energy for precise hemostasis in STANDARD or SPRAY modes. Average power will be displayed as half of peak power for this selection.

Coagulation energy is pulsed on for 2.5 ms every 5 ms providing higher peak power (during the “on” portion) with an effective lower average power resulting in reduced carbonization. Verify the Pulse Coag indicator is illuminated prior to activation to ensure the proper setting. Listen for the distinct Pulse Coag Activation tone during activation to confirm Pulse Coag is indeed active.

### 2.6.4 Fluids Specialty Mode

FLUIDS Specialty Mode provides rapid initiation of clinical effect for surgical procedures conducted in fluid mediums by providing an initial energy burst when activation is initiated.

### 2.6.5 Lap Specialty Mode

Lap Specialty Mode provides optimal safety by limiting output voltage, which minimizes the potentially harmful effects of capacitive coupling and insulation failure. Users will notice that Standard Coag and Spray Coag will have a gentler coagulation effect, that is, shorter arcs and a smaller clinically-affected area when Lap Specialty Mode is selected. When a more aggressive coagulation effect is desired, Pinpoint Coag, Standard Coag or Spray Coag in the General Mode can be selected. When selecting General Mode from Lap Specialty Mode, expect a more aggressive surgical effect and adjust power accordingly. Always use the lowest power setting necessary to get the desired clinical effect. Refer to the instructions provided by the manufacturer of the laparoscopic accessory concerning maximum voltage specifications.

### 2.6.6 Programming

Up to 9 complete mode and power settings can be easily stored and recalled at any time. Additionally, there are two settings that the unit automatically sets, “L” and “0” (zero).

The unit automatically stores the most recent settings when powering down and will restore those settings when the unit is turned ON. An “L” (for Last) will be displayed in the Program Location Indicator. Note that if a power loss occurs during activation, the values stored in the “L” location will be those just prior to the loss of power.

The “0” (zero) location sets all power settings to zero, and the activation modes to Pure Cut, Standard Coag and Bipolar Micro. The settings 1-9 contain user-stored settings.

#### 2.6.6.1 Storing Programs

1. Select the desired storage location BEFORE setting the desired modes and power settings. As each location is shown, the displays will indicate the contents of that location.
2. Set the modes, power and pad settings as desired. Note that non-displayed mode settings are also stored at this time.
3. Press the STORE key. If a correction is needed, simply set the machine as desired and press STORE again. Confirm the program settings are correct before use.

#### 2.6.6.2 Using Programs

Select the stored setting location by scrolling through the program locations using the Program Select Scroll key. Confirm the program settings are correct before use.

#### 2.6.7 Remote Power Control

Remote Power Control provides the surgeon with the ability to change power settings from the surgical field using the activation switches on the monopolar accessory.

**CAUTION: The Remote Power Control feature should be enabled only if the surgeon is familiar with its operation and requires its capabilities. The power displays should be monitored for expected effect while Remote Power Control adjustments are being performed until normal operation is restored.**

The Remote Power Control may only be activated when the Remote Power Control Indicator is on. This mode may be selected or deselected with the Remote Power Control Key. Remote Power Control will always be disabled after power up.



### 2.6.7.1 Changing Monopolar Power Remotely

1. Select Remote Power Control by pressing the Remote Power Control Key.
2. Double click the CUT button on the accessory to adjust the cut power or double click the COAG button to adjust the coagulation power.
3. An acceptance tone will sound, allowing power adjustments only from the accessory where the double click was detected.
4. Only the Power Indicator for the associated power adjustment selected will be illuminated.
5. Only the Remote Power Control Key on the front panel will be functional.
6. Depress CUT on the accessory to increase power or depress COAG to decrease power. An audible tone will sound for each power increment change.
7. A short up or down tone will sound with each one-watt step.
8. As the cut or coag buttons on the accessory are held down for more than nine one-watt steps, the power adjustment will be accelerated and a continuous tone will sound. Releasing the switch and then pressing once again will start the single step function.
9. To end Remote Power Control:
  - a) Double click either CUT or COAG.  
-OR-
  - b) Turn off Remote Power Control Mode.  
-OR-
  - c) Do not press CUT or COAG buttons for 3 seconds and the function will time out.
10. An acceptance tone will sound, returning control for normal operation.

## 2.7 User Maintenance

### 2.7.1 General Maintenance Information

While the System 5000™ has been designed and manufactured to high industry standards, it is recommended that periodic inspection and performance testing be performed by a Hospital Qualified Biomedical Technician using techniques described in the ConMed System 5000™ Service Manual (Catalog Number 60-8017-ENG) to ensure continued safe and effective operation.

### 2.7.2 Cleaning

The exterior of the ESU may be cleaned by wiping it with a cloth that has been dampened (not dripping) with a mild detergent or mild disinfecting solution.

### 2.7.3 Periodic Inspection

The System 5000™ should be visually inspected at least every year. This inspection should include checks for:

- Damage to the power cord.
- Damage to the power plug.
- Tightness of the power plug.
- Tightness of the volume control knob.
- Proper mating, cleanliness and absence of damage to the patient connectors.
- Obvious external or internal damage to the ESU.
- Accumulation of lint or debris within the ESU or heatsink.

### 2.7.4 Periodic Performance Testing

The System 5000™ should be performance tested by a Hospital Qualified Biomedical Technician at least every year. Each ESU is supplied with a serialized Product Test Data Sheet, which tabulates the results of the factory tests performed on the ESU. This data may be used as a reference for subsequent tests and should be made available to the Hospital Qualified Biomedical Technician conducting the tests.

## 2.8 In Case of Difficulty

### 2.8.1 Dispersive Electrode Alarm

Trouble with the dispersive electrode is indicated by red illumination of the Dispersive Electrode Status / Alarm Indicators. Activation attempts will result in an audible fault alarm. Replace the dispersive electrode if any patient contact has been lost.

If a dispersive electrode or A.R.M.™ alarm is sounded intraoperatively, physically confirm proper dispersive electrode attachment to the patient and confirm that the display falls within the set range.

#### 2.8.1.1 Single Dispersive Electrode Alarm

If a Single Dispersive Electrode alarm condition occurs, confirm that a single dispersive electrode



is attached to the ESU. Check all dispersive electrode cable connections and replace the dispersive electrode or cable if necessary.

### 2.8.1.2 Dual Dispersive Electrode Alarm

If a Dual Dispersive Electrode alarm condition occurs, check the Dual Dispersive Electrode Status / Alarm Indicator for clues to the problem:

- a. If only the Dual Dispersive Electrode Status / Alarm Indicator flashes red, the resistance is too high. This can be caused by inappropriate choice of a site for the dispersive electrode, a broken cable or poor connections to the ESU.
- b. If both the Single and Dual Dispersive Electrode Status / Alarm indicators flash red in unison, the impedance is too low. This condition can be caused by a short in the

cable, a short between the two pads on the dispersive electrode, or some fault within the ESU. Replace the dispersive electrode while ensuring the dispersive electrode makes contact only with the patient.

### 2.8.2 Acc Codes

Acc Codes are most often caused by faults in accessories connected to the ESU. The fault can often be corrected in the operating room without a service call. The following list gives the meaning of each code. For each code, check the indicated accessory for proper operation. If the fault persists, unplug the accessory, turn the ESU off and then turn the ESU back on. If the fault is still present, call a Hospital Qualified Biomedical Technician for assistance.

Acc Display Code	Meaning and Solution	Solution
Acc FS	Monopolar Footswitch Shorted	Ensure footswitch treadle is not depressed.
Acc bPF	Bipolar Footswitch Shorted	Ensure footswitch treadle is not depressed.
Acc LH	Left Hand Monopolar Accessory Shorted	Replace hand controlled accessory.
Acc rH	Right Hand Monopolar Accessory Shorted	Replace hand controlled accessory.
Acc bP	Bipolar Accessory Shorted	Replace bipolar accessory.
Acc CP	Control Panel Key Stuck	Ensure no control panel keys are depressed on power-up.

### 2.8.3 Err Codes

Err Codes generally cannot be corrected in the operating room and require the assistance of a Hospital Qualified Biomedical Technician. Occasionally, turning the ESU off and back on will clear an Err fault and resume normal operation of the ESU.

### 2.8.4 If All Else Fails

Contact CONMED Electrosurgery Technical Services at the phone or fax numbers listed on the inside front cover of this manual. Please have the model and serial numbers from the rear panel nameplate along with a description of the problem, including power settings, accessories in use and the fault code.

## 2.9 Environmental Protection

The shipping container and packing material should be retained in the event the ESU must be returned for factory service. At the end of the equipment's life, it should be disposed of in accordance with your local regulations. Component materials are:

- Aluminum enclosure and heatsinks.
- The ESU rear handle is aluminum.
- Thermoset printed wiring boards containing miscellaneous electronic components.
- Transformers made of steel and copper.
- Mains cord made of thermoplastic and copper.
- Shipping container is cardboard; packing materials are a combination of Urethane foam and Polyethylene film.



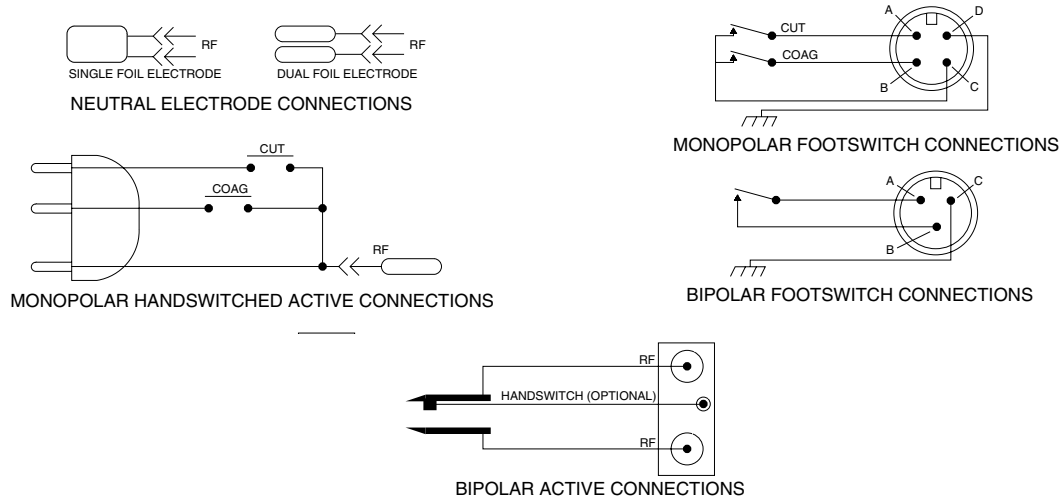

Figure 2.4 Accessory Schematics

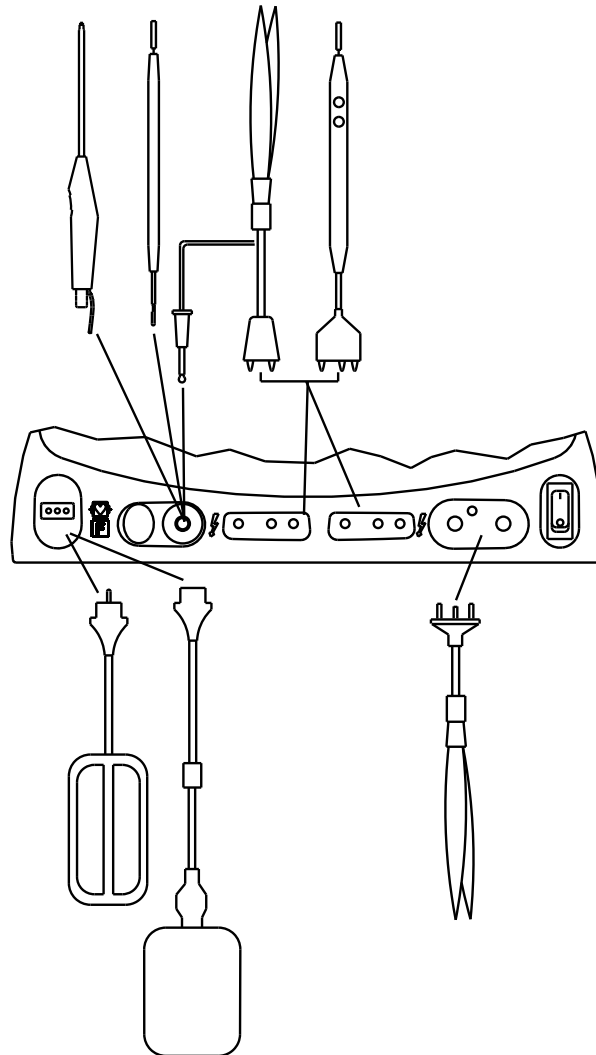

Figure 2.5 Accessory Connections

