

CONTROLLER 48x48mm

RE72 TYPE



USER'S MANUAL



CONTENTS:

1.	APPLICATION	3
2.	CONTROLLER SET	3
3.	BASIC REQUIREMENTS, OPERATIONAL SAFETY	4
4.	INSTALLATION	4
4.1.	Controller Installation	4
4.2.	Electrical Connections	5
4.3.	Installation Recommendations	7
5.	STARTING TO WORK	7
6.	SERVICE	9
6.1.	Programming Controller Parameters	10
6.2.	Programming Matrix	11
6.3.	Setting Change	12
6.4.	Parameter Description	12
7.	CONTROLLER INPUTS AND OUTPUTS	19
7.1.	Main Measuring Inputs	19
7.2.	Additional Measuring Inputs	19
7.3.	Binary Inputs	19
7.4.	Outputs	20
8.	CONTROL	20
8.1.	ON-OFF Control	20
8.2.	Innovative SMART PID Algorithm	20
8.3.	Step-by-step Control	23
8.4.	“Gain Scheduling” Function	24
8.5.	Control of Heating-cooling Type	24
9.	ALARMS	25
10.	TIMER FUNCTION	26
11.	CURRENT TRANSFORMER INPUT	27
12.	ADDITIONAL FUNCTIONS	27
12.1.	Control Signal Monitoring	27
12.2.	Manual Control	27
12.3.	Signal Retransmission	28
12.4.	Set Point Change Rate – Soft Start	28
12.5.	Digital Filter	28
12.6.	Manufacturer's Settings	29
13.	PROGRAMMING CONTROL	29
13.1.	Description of Programming Control Parameters	29
13.2.	Definition of Set Point Value Programs	31
13.3.	Control of the Set Point Value Program	33
14.	RS-485 INTERFACE WITH MODBUS PROTOCOL	35
14.1.	Introduction	35
14.2.	Error Codes	35
14.3.	Register Map	35
15.	ERROR SIGNALING	45
16.	TECHNICAL DATA	45
17.	CONTROLLER VERSION CODES	48
18.	MAINTENANCE AND GUARANTEE	49

1. APPLICATION

The RE72 controller is destined for the temperature control in plastics, food, dehydration industries and everywhere when the temperature change stabilization is necessary.

The measuring input is universal for resistance thermometers (RTD), thermocouple sensors (TC), or for linear standard signals.

The controller has three outputs enabling the two-step control, step-by-step three-step control, three-step control of heating-cooling type and alarm signaling. The two-step control is acc. to the PID or ON-OFF algorithm.

The innovative SMART PID algorithm has been implemented in the controller.

2. CONTROLLER SET

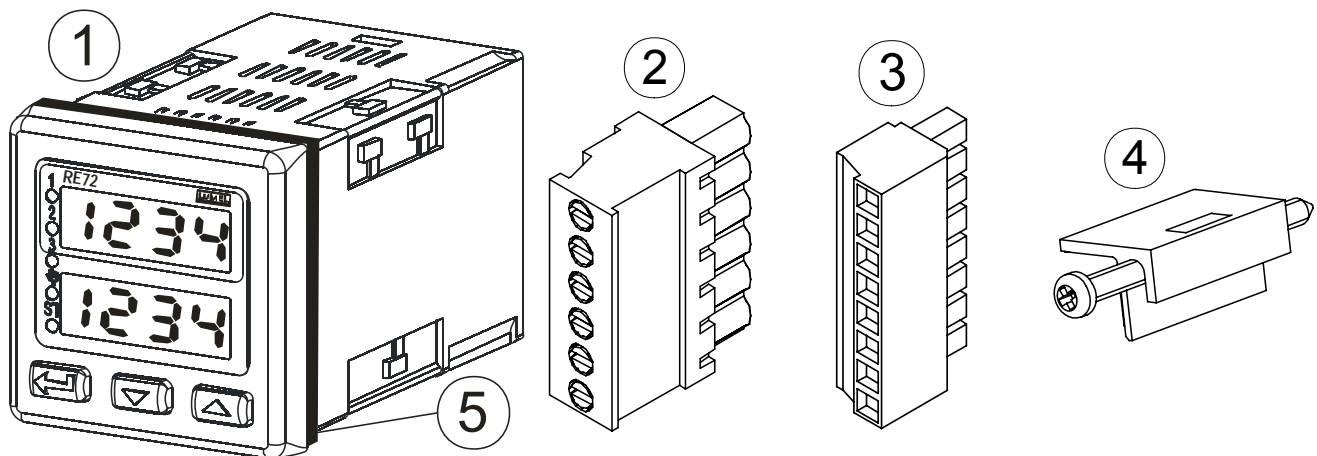

The delivered controller set is composed of:

- | | |
|--|-------|
| ▪ RE72 controller | 1 pc |
| ▪ Plug with 6 screw terminals | 1 pc |
| ▪ Plug with 8 screw terminals | 1 pc |
| ▪ Screw clamp to fix the controller in the panel | 4 pcs |
| ▪ Seal | 1 pc |
| ▪ User's manual | 1 pc |
| ▪ Guarantee card | 1 pc |

When unpacking the controller, please check whether the type and version code on the data plate correspond to the order.

3. BASIC REQUIREMENTS, OPERATIONAL SAFETY

In the safety service scope, the controller meets to requirements of the EN 61010-1 standard.

Observations Concerning the Operational Safety



- All operations concerning transport, installation, and commissioning as well as maintenance, must be carried out by qualified, skilled personnel, and national regulations for the prevention of accidents must be observed.
- Before switching the controller on, one must check the correctness of connections to the network.
- Do not connect the controller to the network through an autotransformer.
- Before removing the controller casing, one must switch the supply off and disconnect measuring circuits.
- The removal of the controller casing during the guarantee contract period may cause its cancellation.
- The controller fulfills requirements related to electromagnetic compatibility in the industrial environment
- When connecting the supply, one must remember that a switch or a circuit-breaker should be installed in the room. This switch should be located near the device, easy accessible by the operator, and suitably marked as an element switching the controller off.
- Non-authorized removal of the casing, inappropriate use, incorrect installation or operation, create the risk of injury to personnel or meter damage.
For more detailed information, please study the User's Manual.

4. INSTALLATION

4.1. Controller Installation

Fix the controller in the panel, which the thickness should not exceed 15 mm, by means of four screw clamps acc. to the fig. 1.

The panel cut-out should have $45+0.6 \times 45+0.6$ mm

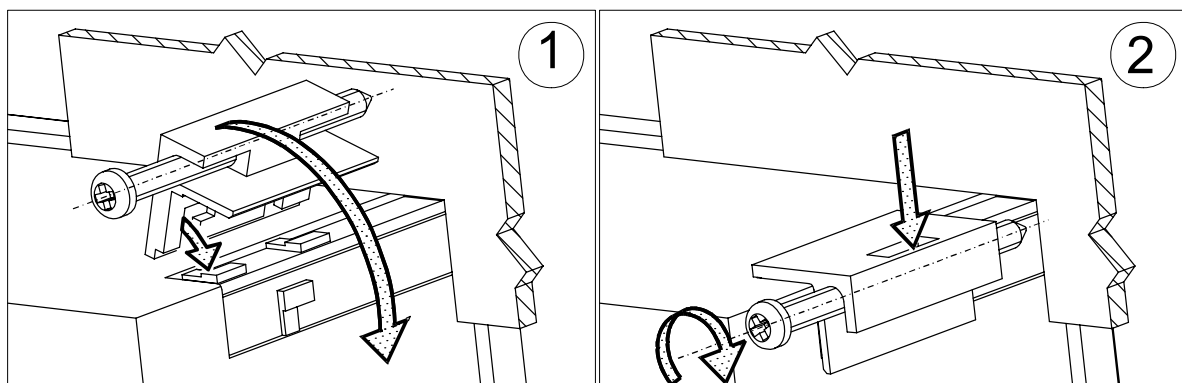

Fig.1 Controller fixing in the panel

Controller overall dimensions are presented on the fig. 2.

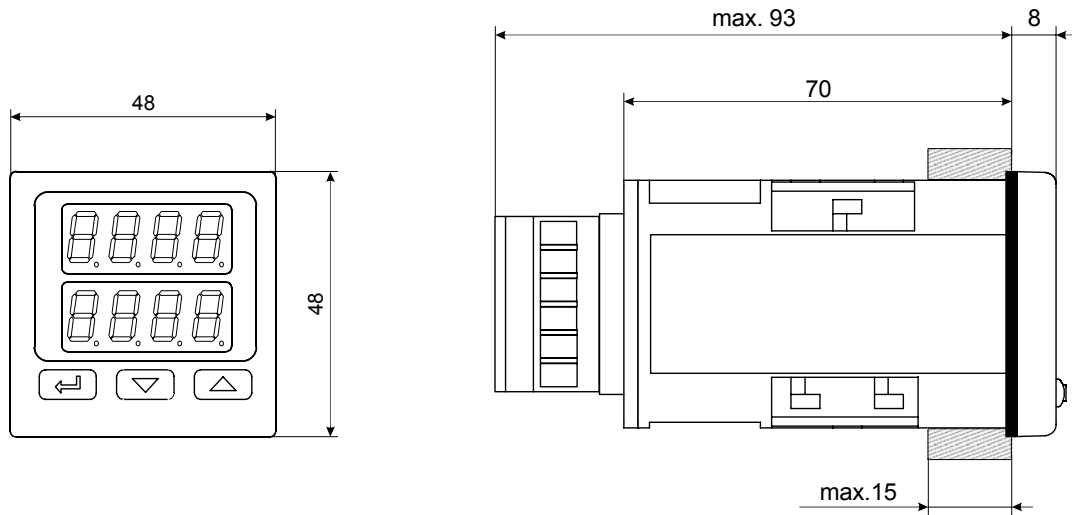

Fig. 2. Controller dimensions.

4.2. Electrical Connections

The controller has two separable terminal strips with screw terminals. One strip enables to connect the supply and outputs by a wire of 2.5 mm² cross-section. The second strip enables to connect input signals by a wire of 1.5 mm² cross-section.

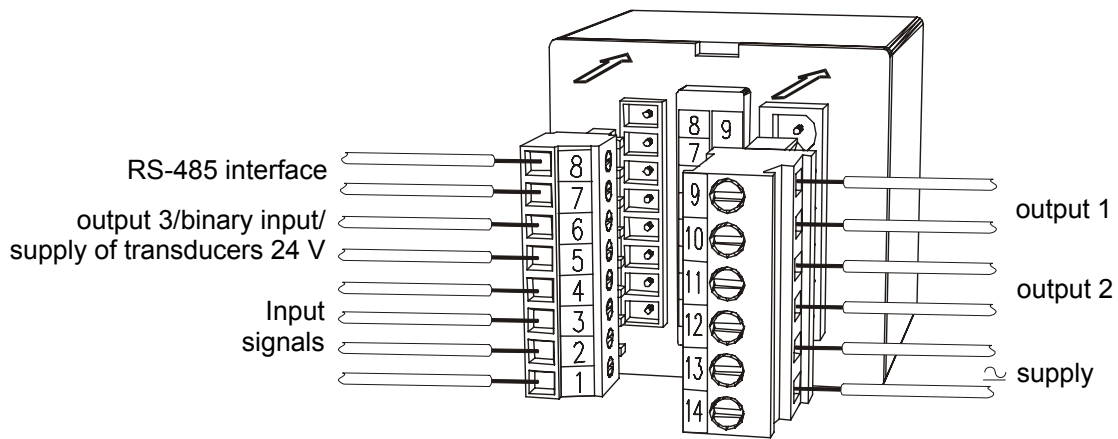

Fig. 3. View of controller connecting strips

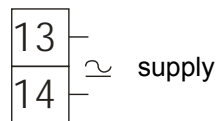

Fig. 4. Supply

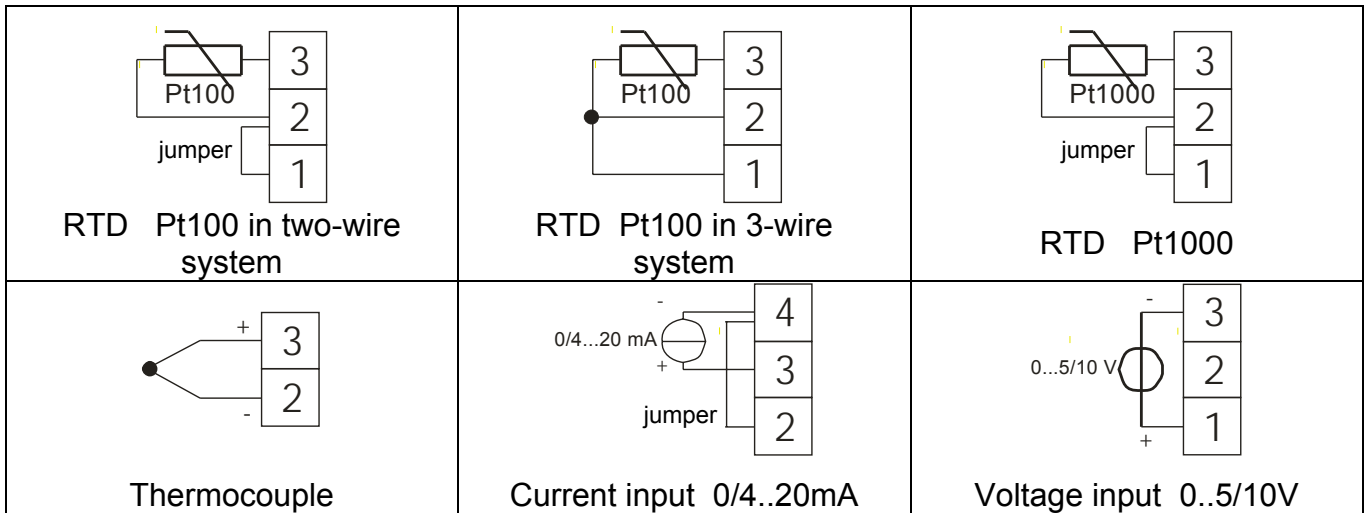

Fig. 5. Input signals

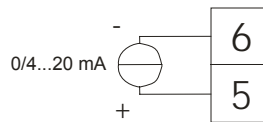

Fig. 6. Additional input signal

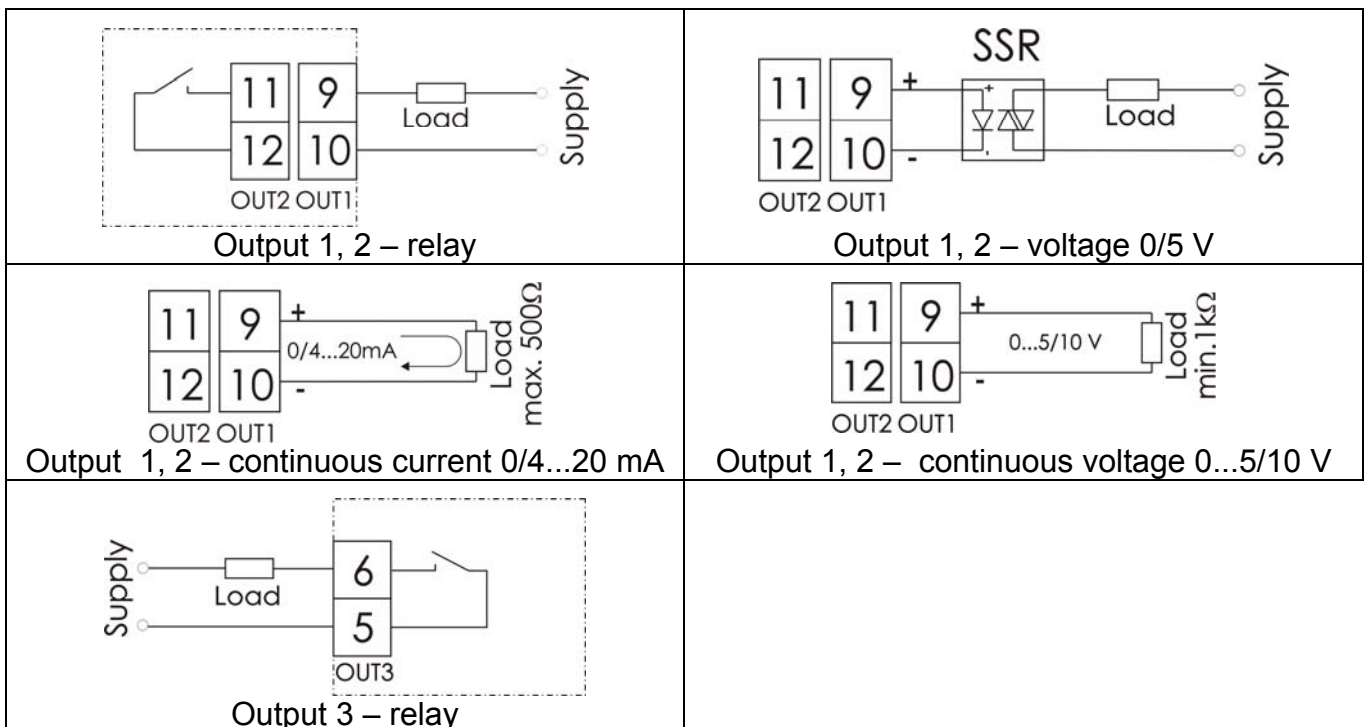

Fig. 7. Control outputs/ alarming

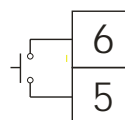

Fig. 8. Binary input

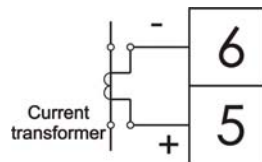

Fig. 9. Current transformer input

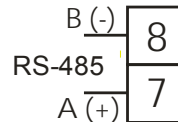

Fig. 10. RS-485 Interface

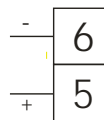

Fig. 11. Supply of 24V transducers

4.3. Installation Recommendations

In order to obtain a full fastness against electromagnetic noise, it is recommended to observe following principles:

- do not supply the controller from the network in the proximity of devices generating high pulse noise and do not apply common earth circuits,
- apply network filters,
- wires leading measuring signals should be twisted in pairs, and for resistance sensors in 3-wire connection, twisted of wires of the same length, cross-section and resistance, and led in a shield as above,
- all shields should be one-side earthed or connected to the protection wire, the nearest possible to the controller,
- apply the general principle, that wires leading different signals should be led at the maximal distance between them (no less than 30 cm), and the crossing of these groups of wires made at right angle (90°).





5. STARTING TO WORK

After turning the supply on, the controller carries out the display test, displays the **RE72** inscription, the program version and next, displays measured and set point values.

A character message informing about abnormalities may appear on the display (table 18).

The PID control algorithm with the proportional range 30°C, integration time constant of 300 seconds, differentiation time constant of 60 seconds and pulse period of 20 seconds is set by the manufacturer.

Changing the Set Point Value

One can change the set point value by pressing the  or the  push-button (fig. 12). The beginning of change is signaled by the flickering dot of the lower display. One must accept the new set point value by pressing the  push-button during 30 seconds since the last pressure of the  or  push-button. In the contrary, the old value will be restored. The change limitation is set by parameters **SPLL** and **SPLH**.

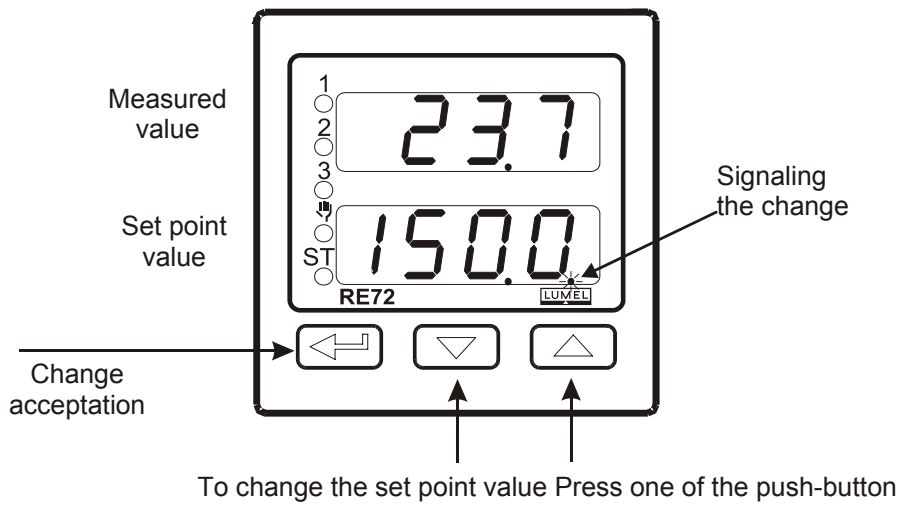

Fig. 12. Fast change of set point value

6. SERVICE

The controller service is presented on the fig. 13

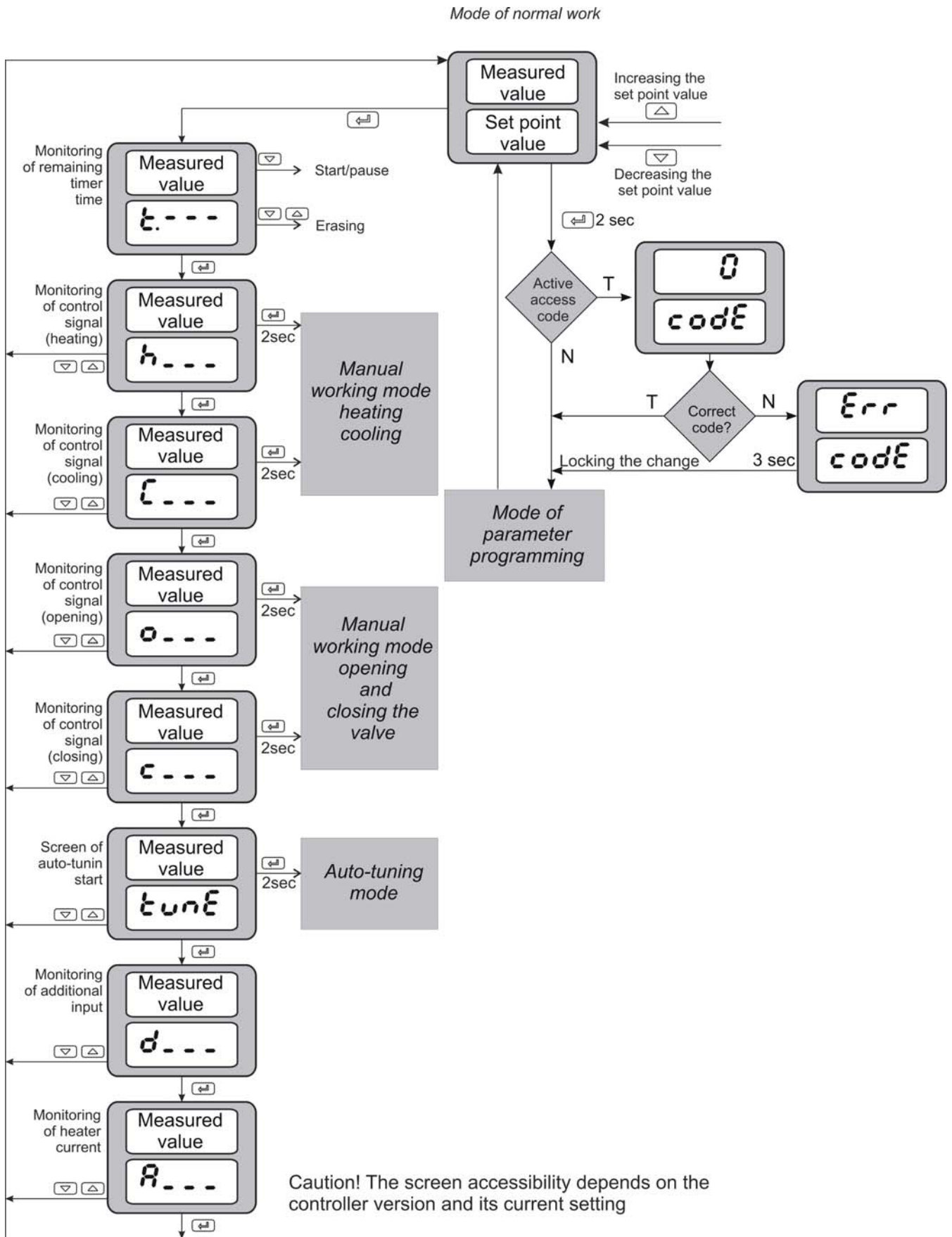









Fig. 13. Menu of controller service

6.1. *Programming Controller Parameters*

The pressure and holding down the  push-button during ca 2 sec. causes the entry in the programming matrix. The programming matrix can be protected by an access code. In case when giving a wrong value of the code, it is only possible to see settings through – without the possibility of changes.

The fig 14. presents the transition matrix in the programming mode. The transition between levels is carrying out by means of  and  push-buttons and the level selection by means of the  push-button.

After selecting the level, the transition between parameters is carried out by means of  and  push-buttons. In order to change the parameter setting, one must proceed acc. to the section 6.3. In order to exit from the selected level, one must transit between parameters until the symbol [. . .] appears and press the  push-button.

In order to exit from the programming matrix to the normal working mode, one must transit between levels until the symbol [. . .] appears and press the  push-button.

Some controller parameters can be invisible – it depends on the current configuration.

The table 1 includes the description of parameters. The return to the normal working mode follows automatically after 30 seconds since the last push-button pressure.

6.2. Programming Matrix

Input parameters	Unit	Kind of main input	Pos. of decimal point	Indic. of lower threshold	Indic. of higher threshold	Shift of measured value	Kind of auxiliary input	Pos. of decimal point	Indic. of lower threshold	Indic. of higher threshold	Time constant of filter	Binary input function	...	
Output parameters	Function of output 1	Type of output 1	Function of output 2	Type of output 2	Function of output 3	Damage signal	Impulse Period Out 1	Impulse Period Out 2	...	Transit to higher level	...	Transit to higher level	...	
Control parameters	Control algorithm	Kind of control	Hysteresis	Dead zone	"Gain schedule" function	Number of PID for GS	Switching level PID1-2	Switching level PID2-3	Switching level PID3-4	Constant set PID	Lower threshold ST	Upper threshold ST	Transit to higher level	
PID parameters	Submenu: P, d, i													
Alarm parameters	Proportional band	Integration Time zone	Different time zone	Correction of control signal	Parameters as for Pid1									Transit to higher level
Set value parameters	R1SP	R1d	R1HY	R1t	R2SP	R2d	R2HY	R2t	R3SP	R3d	R3HY	R3t	...	
Program. control parameters	Description in Programming control chapter	CP	SP	SP2	SP3	SP4	SP1	SPH	SPR	Deviation for alarm 3	Hysteresis alarm 3	Memory alarm 3	Set value alarm 3	
Retransmis. parameters	Rofn	Rolo	Rohi	...										
Interface parameters	Rddr	brud	Proe	...										
Service parameters	Sefu	Sfn	tnr	tnE	d2	de	toe	...						
Exit from menu	...													

Fig. 14. Programming matrix

6.3. Setting Change

The change of the parameter setting begins after pressing the push-button during the display of the parameter name. The setting selection is carried out through and push-buttons, and accepted by the push-button. The change cancellation follows after the simultaneous pressing of and push-buttons or automatically after 30 sec since the last push-button pressure. The way to change the setting is shown on the fig. 15.

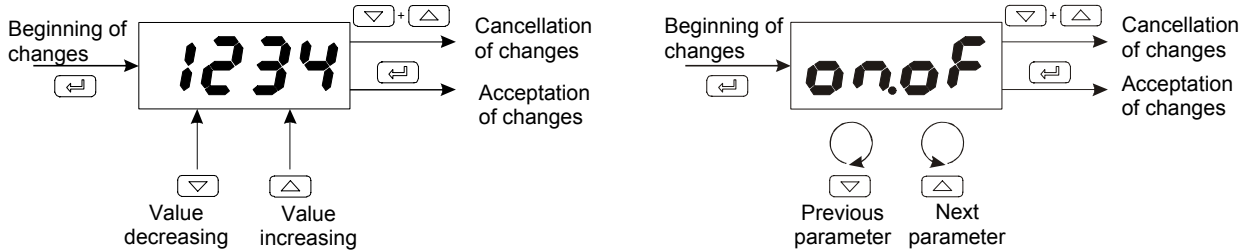

Fig. 15. Change of number and text parameter settings

6.4. Parameter Description

The list of parameters in the menu is presented in the table 1.

List of configuration parameters

Table 1

Parameter symbol	Parameter description	Manufacturer setting	Range of parameter changes	
			sensors	Linear input
Input parameters				
unit	Unit	°C	°C : Celsius degrees °F : Fahrenheit degrees PU : physical units	
input	Kind of main input	Pt 1	Pt 1 : Pt100 Pt 10 : Pt1000 J - J : thermocouple of J type T - T : thermocouple of T type K - K : thermocouple of K type S - S : thermocouple of S type R - R : thermocouple of R type B - B : thermocouple of B type E - E : thermocouple of E type N - N : thermocouple of N type L - L : thermocouple of N type 0 - 20 : linear current 0-20mA 4 - 20 : linear current 4-20mA 0 - 5 : linear voltage 0-5 V 0 - 10 : linear voltage 0-10 V	
dp	Position of the main input decimal point	1 - dp	0 - dp : without decimal point 1 - dp : 1 decimal place 2 - dp : 2 decimal place	0 - dp : without decimal point 1 - dp : 1 decimal place 2 - dp : 2 decimal place

Parameter symbol	Parameter description	Manufacturer setting	Range of parameter changes	
			sensors	Linear input
<i>1 nLo</i>	Indication for the lower threshold of the linear main input	0.0	-	-1999...9999 ¹⁾
<i>1 nHi</i>	Indication for the upper threshold of the linear main input	100.0	-	-1999...9999 ¹⁾
<i>5H.F</i>	measured value shift of the main input	0.0 °C	-100.0...100.0 °C (-180.0...180.0 °F)	-999...999 ¹⁾
<i>1 2.t y</i>	Kind of the auxiliary input	<i>4-20</i>	<i>0-20</i> : linear current 0-20mA <i>4-20</i> : linear current 4-20mA	
<i>dP2</i>	Position of the decimal point	<i>1-dP</i>	-	<i>0-dP</i> : without decimal place <i>1-dP</i> : 1 decimal place <i>2-dP</i> : 2 decimal place
<i>1 2Lo</i>	Indication for the lower threshold of the auxiliary linear input	0.0	-	-1999...9999 ¹⁾
<i>1 2Hi</i>	Indication for the upper threshold of the auxiliary linear input	100.0	-	-1999...9999 ¹⁾
<i>F.Lt</i>	Time constant of the filter	<i>0.2</i>	<i>oFF</i> : filter disabled <i>0.2</i> : time constant 0.2 s <i>0.5</i> : time constant 0.5 s <i>1</i> : time constant 1 s <i>2</i> : time constant 2 s <i>5</i> : time constant 5 s <i>10</i> : time constant 10 s <i>20</i> : time constant 20 s <i>50</i> : time constant 50 s <i>100</i> : time constant 100 s	
<i>bn.n</i>	Binary input function	<i>none</i>	<i>none</i> : none <i>stop</i> : control stop <i>Hand</i> : switching into manual working <i>SP2</i> : switching SP1 into SP2 <i>rS.Rt</i> : erasing of timer alarm <i>PStR</i> : program start <i>PnSt</i> : jump to the next segment <i>P.HLd</i> : stopping to count the set point in the program	
oUtP – Output parameters				
<i>out 1</i>	Function of output 1	<i>y</i>	<i>oFF</i> : without function <i>y</i> : control signal <i>RHi</i> : upper absolute alarm <i>RLo</i> : lower absolute alarm <i>d.u.Hi</i> : upper relative alarm <i>d.u.Lo</i> : lower relative alarm <i>d.u.n</i> : internal relative alarm	

Parameter symbol	Parameter description	Manufacturer setting	Range of parameter changes	
			sensors	Linear input
			<i>d.u.o.v.</i> : external relative alarm <i>y.o.p.</i> : control signal of step-by-step control - opening <i>r.e.t.r.</i> : retransmission	
<i>o1ty</i>	Output type 1	<i>4-20</i> ²⁾	<i>r.e.l.y.</i> : relay output <i>55r</i> : voltage output 0/5 V <i>4-20</i> : continuous current output 4 – 20 mA <i>0-20</i> : continuous current output 0 – 20 mA <i>0-5</i> : continuous voltage output 0 – 5 V <i>0-10</i> : continuous voltage output 0 – 10 V	
<i>out2</i>	Function of output 2	<i>off</i>	<i>off</i> : without function <i>y</i> : control signal <i>R.H.</i> : absolute upper alarm <i>R.L.o</i> : absolute lower alarm <i>d.u.H.</i> : relative upper alarm <i>d.u.L.o</i> relative : lower alarm <i>d.u.i.n</i> : internal relative alarm <i>d.u.o.v.</i> : external relative alarm <i>R.L.t.r.</i> : timer alarm <i>R.L.h.b</i> alarm: heater burnout <i>R.L.o.s</i> : alarm of output 1 shorting <i>y.c.l</i> : control signal of step-by-step control – closing <i>c.o.o.l</i> : control signal - cooling <i>r.e.t.r.</i> : retransmission <i>E.v.1</i> : auxiliary output in the programming control	
<i>o2ty</i>	output type 2	<i>4-20</i> ²⁾	<i>r.e.l.y.</i> : relay output <i>55r</i> : voltage output 0/5 V <i>4-20</i> : current continuous output 4 – 20 mA <i>0-20</i> : current continuous output 0 – 20 mA <i>0-5</i> : voltage continuous output 0 – 5 V <i>0-10</i> : voltage continuous output 0 – 10 V	
<i>out3</i>	Function of output 3	<i>off</i>	<i>off</i> : without function <i>R.H.</i> : absolute upper alarm <i>R.L.o</i> : absolute lower alarm <i>d.u.H.</i> : relative upper alarm <i>d.u.L.o</i> : relative lower alarm <i>d.u.i.n</i> : internal relative alarm <i>d.u.o.v.</i> : external relative alarm <i>R.L.t.r.</i> : timer alarm <i>E.v.2</i> auxiliary output in programming control	
<i>y.F.L</i>	Control signal of control output for proportional control in case of the sensor damage.	0.0	0.0...100.0	

Parameter symbol	Parameter description	Manufacturer setting	Range of parameter changes	
			sensors	Linear input
t_{o1}	Pulse repetition period of output 1	20.0 s	0.5...99.9 s	
t_{o2}	Pulse repetition period of output 2	20.0 s	0.5...99.9 s	
ctrl – Control parameters				
ALG	Control algorithm	P, d	o n o f : control algorithm on-off P, d : control algorithm PID	
TYPE	Kind of control	i n u	d i r : direct control (cooling) i n u : reverse control (heating)	
HY	Hysteresis	1.1 °C	0.2...100.0 °C (0.2...180.0 °F)	
Hn	Displacement zone for heating-cooling control or dead zone for step-by-step control.	10.0 °C	0.0...100.0 °C (0.0...180.0 °F)	0...999 1)
CLY	“Gain Scheduling “ function	o f f	o f f : disabled S P : from set point value S E t : constant PID set	
CLnb	Number of PID sets for “Gain Scheduling” from the set point value	2	2 : 2 PID sets 3 : 3 PID sets 4 : 4 PID sets	
CL12	Switching level for PID1 and PID2 sets	0.0	MIN...MAX 3)	
CL23	Switching level for PID2 and PID3 sets	0.0	MIN...MAX 3)	
CL34	Switching level for PID3 and PID4 sets	0.0	MIN...MAX 3)	
CLSEt	Selection of the constant PID set	P, d 1	P, d 1 : PID1 set P, d 2 : PID2 set P, d 3 : PID3 set P, d 4 : PID4 set	
StLo	Lower threshold for auto-tuning	0.0 °C	MIN...MAX 3)	
StHi	Upper threshold for auto-tuning	800.0 °C	MIN...MAX 3)	
P, d – PID parameters				
P, d 1	Pb	Proportional band	30.0 °C	0.1...550.0 °C (0.1...990.0 °F)
	t_i	Integration time constant	300 s	0...9999 s
	t_d	Differentiation time constant	60.0 s	0.0...2500 s
	yo	Correction of the control signal, for P or PD control type	0.0 %	0...100.0 %

Parameter symbol	Parameter description	Manufacturer setting	Range of parameter changes	
			sensors	Linear input
P. d2	Pb2 ti2 td2 y02	Second set of PID parameters	as PB, TI, TD, Y0	
P. d3	Pb3 ti3 td3 y03	Third set of PID parameters	as PB, TI, TD, Y0	
P. d4	Pb4 ti4 td4 y04	Fourth set of PID parameters	as PB, TI, TD, Y0	
P. dC	PbC	Proportional band for the cooling channel (in relation to PB)	100 %	0.1...200 %
	tiC	Integration time constant	300 s	0...9999 s
	tdC	Differentiation time constant	60.0 s	0.0...2500 s
ALAr – Alarm parameters				
A1SP	Set point value for absolute alarm1	100.0	MIN...MAX ³⁾	
A1d0	Deviation from the set point value for relative alarm 1	0.0 °C	-200.0... 200.0 °C (-360.0... 360.0 °F)	
A1HY	Hysteresis for alarm 1	2.0 °C	0.2...100.0 °C (0.2...180.0 °F)	
A1Lt	Memory of alarm 1	oFF	oFF : disabled oN : enabled	
A2SP	Set point value for absolute alarm 2	100.0	MIN...MAX ³⁾	
A2d0	Deviation from the set point value for relative alarm 2	0.0 °C	-200.0... 200.0 °C (-360.0... 360.0 °F)	
A2HY	Hysteresis for alarm 2	2.0 °C	0.2...100.0 °C (0.2...180.0 °F)	
A2Lt	Memory of alarm 2	oFF	oFF : disabled oN : enabled	
A3SP	Set point value for absolute alarm 3	100.0 °C	MIN...MAX ³⁾	
A3d0	Deviation from the set point value for relative alarm 3	0.0 °C	-200,0... 200,0 °C (-360.0... 360.0 °F)	
A3HY	Hysteresis for alarm 3	2.0 °C	0.2...100.0 °C (0.2...180.0 °F)	
A3Lt	Memory of alarm 3	oFF	oFF : disabled oN : enabled	

Parameter symbol	Parameter description	Manufacturer setting	Range of parameter changes	
			sensors	Linear input
AhSP	Alarm set point value for the heater current	0.0 A	0.0...50.0 A	
AhHY	Alarm hysteresis for the heater current	0.1 A	0.1...50.0 A	
SPP – Set point value parameters				
SPnd	Kind of set point value	SP12	SP12 : set point value SP1 or SP2 SP12s : set point value with soft start in units per minute SP12h : set point value with soft start in units per hour SP12i : set point value from the additional input SP12p : set point value from programming control	
CPG	Program No to carry out	1	1...15	
SP1	Set point value SP1	0.0 °C	MIN...MAX ³⁾	
SP2	Set point value SP2	0.0 °C	MIN...MAX ³⁾	
SP3	Set point value SP3	0.0 °C	MIN...MAX ³⁾	
SP4	Set point value SP4	0.0 °C	MIN...MAX ³⁾	
SPL	Lower limitation of the fast set point value change	-200 °C	MIN...MAX ³⁾	
SPH	Upper limitation of the fast set point value change	1767.0 °C	MIN...MAX ³⁾	
SPrr	Accretion rate of the set point value SP1 or SP2 during the soft start .	0.0 °C	0...999.9 / time unit ⁴⁾	0...9999 ¹⁾ / time unit ⁴⁾
PrC – Programming control parameters				
The description of parameters is in the section: Programming control – table 5				
intE – Serial interface parameters				
Addr	Device address	1	1...247	
brud	Transmission rate	96	48 : 4800 bit/s 96 : 9600 bit/s 192 : 19200 bit/s 384 : 38400 bit/s 576 : 57600 bit/s	
Prot	Protocol	r8n2	nonE : lack r8n2 : RTU 8N2 r8E1 : RTU 8E1 r8o1 : RTU 8O1 r8n1 : RTU 8N1	
rEt r – Retransmission parameters				
RoFn	Quantity retransmitted on the continuous output	Pu	Pu : measured value on the main	

Parameter symbol	Parameter description	Manufacturer setting	Range of parameter changes	
			sensors	Linear input
			input PV <i>PV2</i> : measured value on the additional input PV2 <i>P1-2</i> : measured value PV – PV2 <i>P2-1</i> : measured value PV2 – PV <i>SP</i> : set point value <i>du</i> : control deviation (set point value – measured value)	
<i>R.o.L.o</i>	Lower threshold of the signal to retransmit	0.0	MIN...MAX ³⁾	
<i>R.o.H.i</i>	Upper threshold of the signal to retransmit	100.0	MIN...MAX ³⁾	
SER-P – Service parameters				
<i>SECU</i>	Access code to the menu	0	0...9999	
<i>StFn</i>	Auto-tuning function	on	off: locked on: available	
<i>ti nr</i>	timer function	off	off: disabled on: enabled	
<i>ti nE</i>	Counting off the time by the timer	30.0 min	0.1...999.9 min	
<i>di 2</i>	Monitoring of the auxiliary input	off	off: disabled on: enabled	
<i>dct</i>	Monitoring of the heater current	off	off: disabled on: enabled	
<i>tout</i>	Time of the automatic output from the monitoring mode	30 s	0...9999 s	

¹⁾ The definition at which the given parameter is shown depends on the parameter *dp* – position of the decimal point.

²⁾ For the output 0/4...20 mA, parameter to write, for other cases, to readout – acc. to the version code.

³⁾ See table 2.

⁴⁾ Time unit defined by the parameter *SPnd* (*r.n. n*, *r.Hr*).

Caution!

The accessibility of parameters depends on the controller version and its current settings.

Parameters depended on the measuring range

Table 2

Symbol	Input/ sensor	MIN	MAX
<i>Pt 1</i>	Resistance thermometer Pt100	-200 °C (-328 °F)	850 °C (1562 °F)
<i>Pt 10</i>	Resistance thermometer Pt1000	-200 °C (-328 °F)	850 °C (1562 °F)
<i>t - J</i>	Thermocouple of J type	-100 °C (-148 °F)	1200 °C (2192 °F)
<i>t - T</i>	Thermocouple of T type	-100 °C (-148 °F)	400 °C (752 °F)
<i>t - K</i>	Thermocouple of K type	-100 °C (-148 °F)	1372 °C (2501,6 °F)
<i>t - S</i>	Thermocouple of S type	0 °C (32 °F)	1767 °C (3212,6 °F)
<i>t - R</i>	Thermocouple of R type	0 °C (32 °F)	1767 °C (3212,6 °F)
<i>t - B</i>	Thermocouple of B type	0 °C (32 °F)	1767 °C (3212,6 °F)

$\epsilon - \epsilon$	Thermocouple of E type	-100 °C (-148 °F)	1000 °C (1832 °F)
$\epsilon - n$	Thermocouple of N type	-100 °C (-148 °F)	1300 °C (2372 °F)
$\epsilon - L$	Thermocouple of L type	-100 °C (-148 °F)	800 °C (1472 °F)
$0 - 20$	Linear current 0-20mA	-1999 ¹⁾	9999 ¹⁾
$4 - 20$	Linear current 4-20 mA	-1999 ¹⁾	9999 ¹⁾
$0 - 5$	Linear voltage 0-5 V	-1999 ¹⁾	9999 ¹⁾
$0 - 10$	Linear voltage 0-10 V	-1999 ¹⁾	9999 ¹⁾

¹⁾. The definition at which the given parameter is shown depends on the parameter dP – position of the decimal point.

7. CONTROLLER INPUTS AND OUTPUTS

7.1. Main Measuring Inputs

The main input is the source of measured value taking part in control and alarms.

The main input is an universal input, to which one can connect different types of sensors or standard signals. The selection of the input signal type is made by the parameter $i n t y$.

The position of the decimal point which defines the display format of the measured and the set point value is set by the parameter dP . For linear inputs, one must set the indication for the lower and upper analog input threshold $i l o$ and $i h i$.

The correction of the measured value indication is carried out by the parameter $S h, F$.

7.2. Additional Measuring Inputs

The additional input can be the source of remote set point value ($S P, n d$ set on $i n 2$) or the signal for retransmission ($R a F n$ set on $P y 2$).

The additional input is a linear input. The selection of the input signal type is possible between 0...20 mA and 4...20 mA by the parameter $i 2 t y$.

The position of decimal point which defines the display format of the measured and set point value is set by the parameter $d P 2$. One must also set the indication for the lower and upper analog input threshold $i 2 l o$ and $i 2 h i$.

The signal from the additional input is displayed with the character „d” on the first position. To display the value, one must press the  push-button till the moment of its appearance on the lower display (acc. to the fig. 13.) The return to display the set point value is set by the manufacturer for 30 sec, but it can be changed, or disabled through the parameter $t o u t$.

7.3. Binary Inputs

The function of the binary input is set by the parameter $b n, n$.

Following binary input functions are available:

- **without function** – the binary input state does not influence the controller operation,
- **control stop** – the control is interrupted, and control outputs are behaved as after a sensor damage, alarm and retransmission operate independently,
- **switching on manual operation** – transition to the manual control mode'
- **switching SP1 on SP2** – change of the set point value during the control,
- **erasing of the timer alarm** – disabling of the relay responsible for the timer alarm,
- **program start** – the programming control process begins (after a prior set of the programming control),
- **jump to the next segment** – the transition to the next segment, follows during the duration of programming control.
- **stoppage to count the set point value in the program** – the stoppage of set point value

counting follows during the duration of the programming control.

7.4. Outputs

The controller has maximally three outputs. The on-off or proportional control is available on the output 1. The step-by-step control is available on the output 1 (valve opening) and 2 (valve closing). The heating-cooling control is available on the output 1 (heating) and 2 (cooling). Alarms are available on each of three outputs.

For the proportional control (with the exception of analog outputs), the impulse period is additionally set.

The impulse period is the time which goes by between successive switches of the output during the proportional control. The length of the impulse period must be chosen depending on dynamic object properties and suitably for the output device. For fast processes, it is recommended to use SSR relays. The relay output is used to steer contactors in slow-changing processes. The application of a high impulse period to steer slow-changing processes can give unwanted effects in the shape of oscillations. In theory, lower the impulse period, better the control, but for a relay output it can be as large as possible in order to prolong the relay life.

Recommendations concerning the impulse period:

Table 3

output	Impulse period to	Load
Electromagnetic relay	Recommended >20 s, min.10 s	2 A/230 V a.c.
	Min. 5 s	1 A/230 V a.c.
Transistor output	1...3 sec	SSR relay

8. CONTROL

8.1. ON-OFF Control

When a high accuracy of temperature control is not required, especially for objects with a great time constant and small delay, one can apply the on-off control with hysteresis.

Advantages of this way of control are simplicity and liability, but disadvantage are the occurring oscillations, even at small hysteresis values.

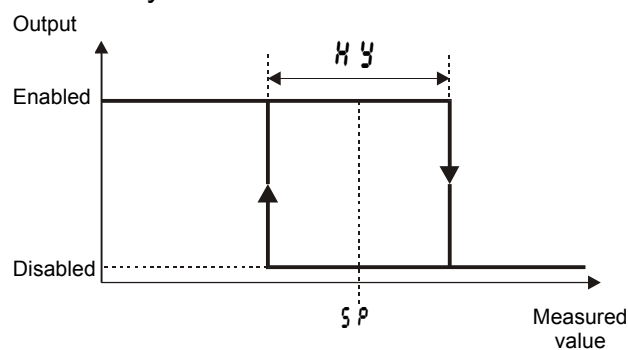

Fig. 16. Operation way of the heating output type

8.2. Innovative SMART PID Algorithm

When a high accuracy of the temperature control is required, one must use the PID algorithm. The applied innovative SMART PID algorithm is characterized by an increased accuracy for a wider class range of controlled objects.

The controller tuning of the object consists on the manual setting of the proportional element value, integration element, differentiation element, or automatically – by means of the auto-tuning function.

8.2.1. Auto-tuning

The controller has the function to select PID settings. These settings ensure in most of case an optimal control.

To begin the auto-tuning, one must transit to the **tUNE** message (acc. to the fig. 13) and hold down the  push-button during at least 2 seconds. If the control algorithm is set on on-off or the auto-tuning function is locked then, the **tUNE** message will be hidden.

For a correct realization of the auto-tuning function, it is required to set **StLo** and **StHi** parameters. The **StLo** parameter must be set on the value corresponding to the measured value at disabled control. For temperature control objects, one can set 0°C. One must set the **StHi** parameter on the value corresponding to the maximum measured value at switched on control on full power.

The flickering ST symbol informs about the activity of the auto-tuning function. The duration of auto-tuning depends on dynamic object properties and can last maximally 10 hours. In the middle of the auto-tuning or directly after it, over-regulations can occur, and for this reason one must set a smaller set point, if it possible.

The auto-tuning is composed of following stages:

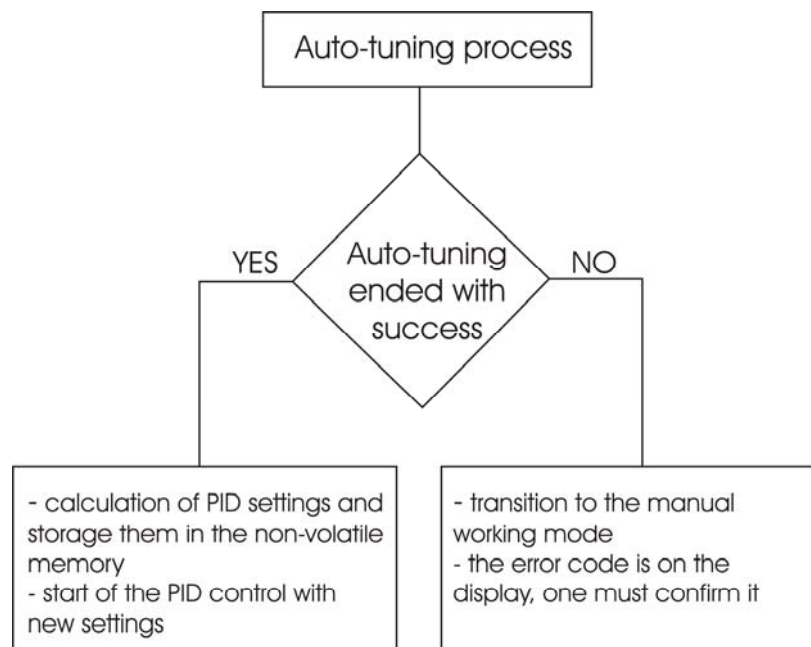

The auto-tuning process will be stopped without counting PID settings, if a supply decay occurs or the  push-button is pressed. In this case, the control with current PID settings begins.

If the auto-tuning is not achieved with success, the error code will be displayed acc. to the table 4.

Error codes for auto-tuning

Table 4

Error code	Reason	How to proceed
E501	P or PD control was selected.	One must select PI, PID control, i.e. the TI element must be higher than zero.
E502	The set point value is incorrect.	One must change one or more set point value or StLo , StHi .
E503	The  push-button was pressed.	
E504	The maximal duration time of auto-tuning was exceeded.	Check if the temperature sensor is correctly placed and if the set point value is not set too higher for the given object.
E505	The waiting time for switching was	

	exceeded	
E506	The measuring input range was exceeded.	Pay attention for the sensor connection way. Do not allow that an over-regulation could cause the exceeding of the input measuring range
E520	Very non-linear object, making impossible to obtain correct PID parameter values, or noises have occurred.	Carry out the auto-tuning again. If that does not help, select manually PID parameters.

8.2.2. Auto-tuning and "Gain Scheduling"

In case, when "Gain Scheduling" is used, one can carry out the auto-tuning in two ways.

The first way consist on choosing a suitable set of PID parameters, in which calculated PID parameters will be stored and realizing the auto-tuning on the level of the currently chosen set point value for the fixed set point control. One must set the U_{tY} parameter on SEt , and choose U_{SEt} between P, d, i and P, d, Y

The second way enables the automatic realization of the auto-tuning for all PID sets. One must set the U_{tY} parameter on SP , and choose the number of PID sets for setting – parameter U_{SNb} . Set point values for individual PID sets must be give in $SP, SP2, SP3, SP4$ parameters, from the lowest to the highest.

8.2.3. Proceeding Way in Case of a Dissatisfying PID Control

The best way to select PID parameters is to change the value into a twice higher or into a twice lower. During changes, one must respect following principles:

- a) Oscillations:
 - increase the proportional band,
 - increase the integration time,
 - decrease the differentiation time.
- b) Over-regulations:
 - increase the proportional band,
 - increase the integration time,
 - increase the differentiation time.
- c) Instability:
 - decrease the proportional band,
 - decrease the differentiation tim,
- a) Slow jump response:
 - decrease the proportional band,
 - decrease the integration time,

Run of the controlled quantity	Algorithms of controller operations			
	P	PD	PI	PID
	Pb↑	Pb↑ td↓	Pb↑	Pb↑ ti↑ td↓
	Pb↑	Pb↑ td↑	Pb↑ ti↑	Pb↑ ti↑ td↑
		Pb↓ td↓		Pb↓ td↓
	Pb↓	Pb↓	ti↓	Pb↓ ti↓

Fig. 17 Way to correct PID parameters

8.3. Step-by-step Control

The three-stage step-by-step control is applied for valve control. One must set the output out_1 on YOP and out_2 on YCL and set the dead zone H_n around the the set point value. The first channel - valve opening – operates for the set point value equal to $SP - H_n/2$ as a reverse controller, the second channel – valve closing – operates for the set point value equal to $SP + H_n/2$ as a direct controller. PID parameters for the second channel are identical as for the first channel. The algorithm PD is recommended for the step-by-step control. The operation of a three-stage step-by-step controller with algorithm P is shown on the fig. 17. The auto-tuning algorithm is not available for the step-by-step control. The impulse period is the same for valve opening and valve closing (parameter t_{oi}).

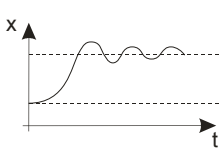
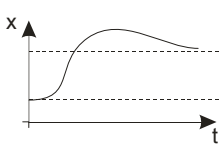
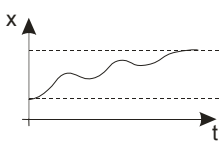
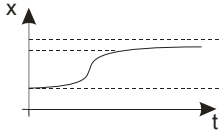
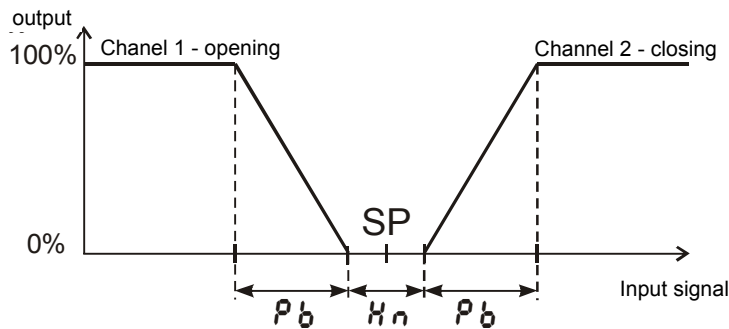

Fig. 18. three-stage step-by-step control

8.4. "Gain Scheduling" Function

For control systems, Where the object behaves decidedly differently in various temperatures, it is recommended to use the "Gain Scheduling" function. The controller allows to remember up to four sets of PID parameters and switch them over automatically.. The switching between PID sets runs percussiveless and with hysteresis, in order to eliminate oscillations on switching limits.

The G.S.Y parameter settles the way of the function operation.

OFF	The function is disabled
SP	a) switching depending on the set point value. For the fixed set point control one must also choose the number of PID sets – the G.S.nb parameter, and set switching levels in dependence from the number of PID sets. b) For the programmed control, one can set the PID set individually for each segment. Then, one must set the P.i.d parameter on on for the given Pr.n program, in the P.C.F.C group.
SET	Permanently setting of one PID set, the PID set is put through the G.S.Et parameter.

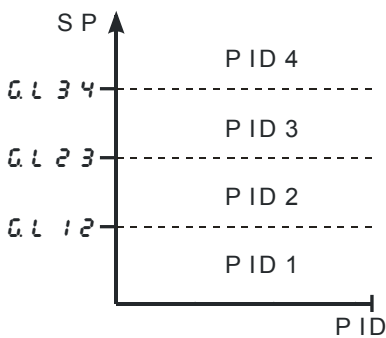

Fig 19. "Gain Scheduling" switched over from SP

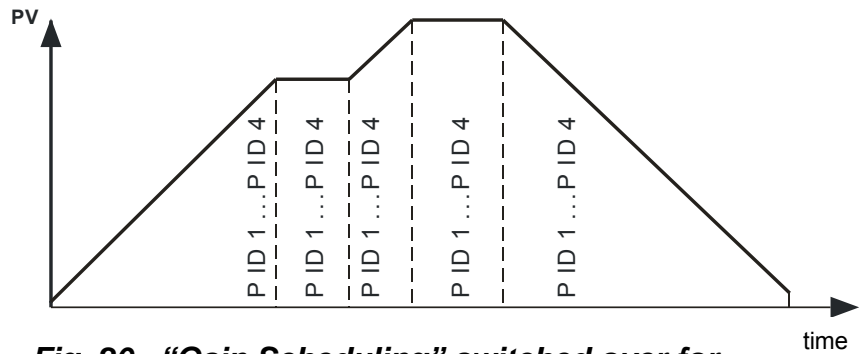

Fig 20. "Gain Scheduling" switched over for each segment in the programmed control

8.5. Control of Heating-cooling Type

In the heating-cooling control type, one must set the output out 1 on H and out 2 on COOL and set the extension zone Hn for cooling.

For the heating channel, one must set PID parameters: Pb , ti , td , for the cooling channel set PID parameters: PbC , tiC , tdC . The parameter PbC is defined as the ratio of the Pb parameter from the range 0.1 ... 100%.

The impulse period for binary outputs (relay, SSR) is set independently for the heating and cooling channel (to 1 and to 2 parameters).

If there is the need to use the PID control in one channel and the ON-OFF control in the second channel, one must configure the output 1 on the PID control and the output 2 as the upper relative alarm.

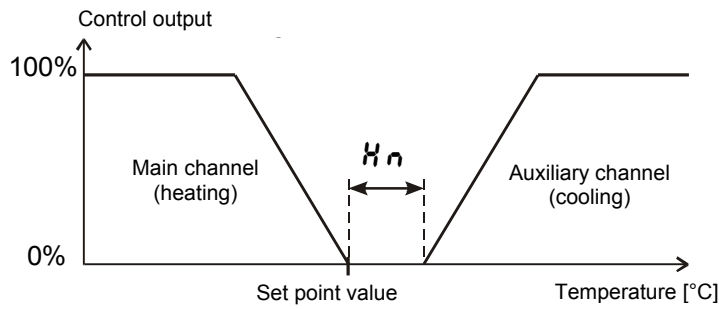
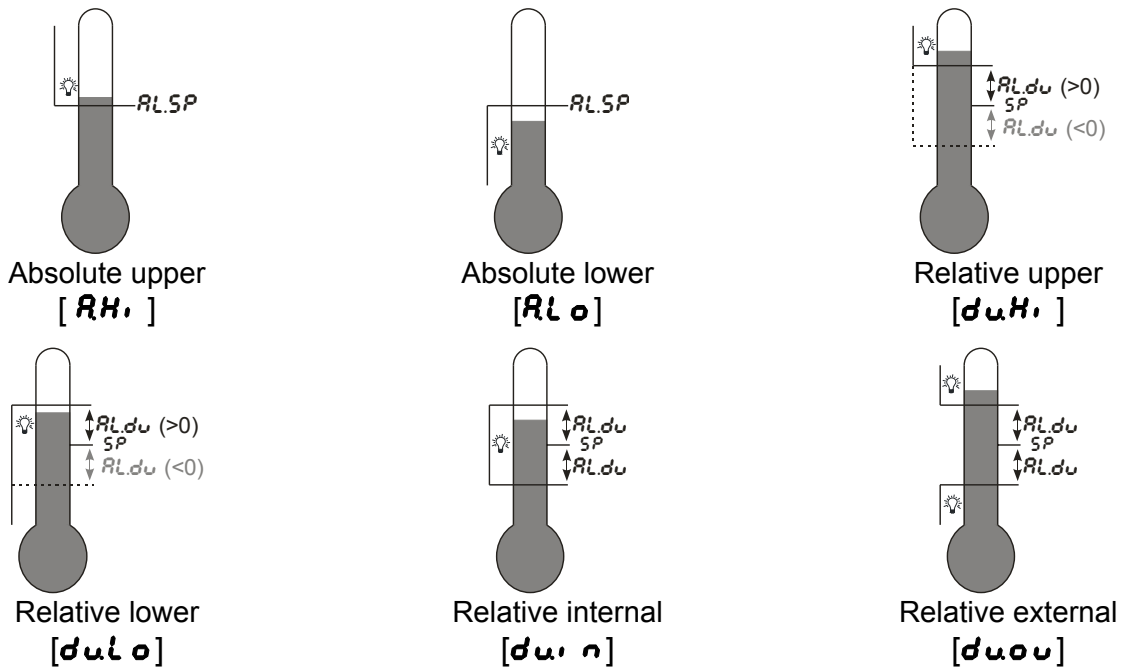

Fig.21. Control with two channels – heating-cooling type

9. ALARMS

Four alarms are available in the controller, which can be assigned: to each output. The alarm configuration requires the selection of the alarm kind through setting *out 1*, *out 2*, *out 3* and *out 4* parameters on the suitable type of alarm. Available types of alarms are given on the fig. 22.



Rys. 22. Kinds of alarms

The set point value for absolute alarms is the value defined by the $Rx.SP$ parameter, and for relative alarms, it is the deviation from the set point value in the main channel - $Rx.du$ parameter. The alarm hysteresis, i.e. the zone around the set point value, in which the output state is not changed, is defined by the $Rx.HY$ parameter. One can set the alarm latch, i.e. the memorizing of the alarm state after stopping alarm conditions (parameter $Rx.Lt = on$). The erasing of alarm memory can be made by the simultaneous pressure of and push-buttons in the normal working mode or interface.

10. TIMER FUNCTION

When reaching the set point temperature (SP) the timer begins the countdown of the time defined by the t_{nr} parameter. After counting down to zero, the timer alarm is set, which remains active till the moment of the timer erasing.

To active the timer function, one must set the parameter $t_{nr} = on$.

To signal the alarm state on the output 2, one must set the parameter $out2 = ALt_r$, and on the output 3 one must set the parameter $out3 = ALt_r$.

The timer status/ residual time is displayed with the mark „t” on the first position. To display it, one must press the \leftarrow push-button till the moment of it appearance on the lower display (acc. to the fig. 13)

The return to the set point value display is set by the manufacturer on 30 sec, but can be changed, or disabled through the t_{out} parameter.

Status	Description	Sygnaling
timer stopped		t - - -
Starting of the timer	- temperature over SP - Press the $\square \downarrow$ push-button	Residual time in minutes: e.g. (t 29.9)
Pause of the timer	Press the $\square \downarrow$ push-button	Flickering residual time in minutes
End of the countdown	Reaching zero by the timer	t End
Timer erasing	During the countdown: Press $\square \downarrow$ and $\square \uparrow$ push-buttons	
	After the countdown end: - press the $\square \uparrow$ push-button - through the binary input	

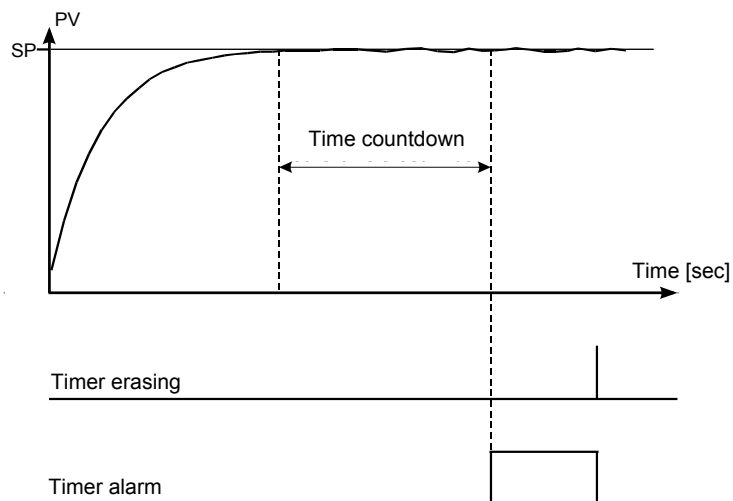



Fig.23. Principle of timer operation

11. CURRENT TRANSFORMER INPUT

After connecting the current transformer (designation CT-94-1), the measurement and display of the current flowing through the load steered by the output 1, is possible.

The first output must be of relay or voltage 0/5 V type. For the current counting, the minimal time of the output switching on must be at least 200 ms.

The transformer work range is equal from 0 to 50 A. The heater current is displayed with the mark "H" in the first position. In order to display the heater current, one must press the  push-button till the moment of its appearance on the lower display (acc. to the fig. 13).

The return to the set point value display is set by the manufacturer on 30 sec, but can be changed or disabled through the **tout** parameter.

Two types of alarms concerning the heating element are available. The alarm of damage the control element and alarm of the heater burnout. The alarm of the control element damage is realized by the current measurement when the control element is disabled, however the burnout alarm is realized when the control element is enabled.

The alarm configuration consists on the selection of the alarm type. For the alarm of the heater burnout **out2=ALhb**, and for the shorting alarm of the control element **out2=ALoS**

Remaining parameters to set are the alarm set point value **AhSP** and the **AhHY** hysteresis. For a correct detection of the heater alarm burnout, the heating element can not be connected later than the controller.

12. ADDITIONAL FUNCTIONS





12.1. Control Signal Monitoring

The control signal of heating type is displayed with the mark „h” on the first position, of cooling type is displayed with the mark “c”, of valve opening is displayed with the mark “o” and valve closing is displayed with the mark “c”. The accessibility of the control signal depends on the suitable controller configuration. To display the control signal, one must press the  push-button till the moment of its appearance on the lower display (acc. to the fig. 13). The return to the set point value display is set by the manufacturer on 30 sec. but it can be changed, or disabled through the **tout** parameter.

12.2. Manual Control

The input to the manual control mode follows after holding down the  push-button during the control signal display. The manual control is signaled by the pulsation of the LED diode. The controller interrupts the automatic control and begins the manual control of the output. The control signal value is on the lower display, preceded by the symbol “h” – for the main channel and “c” – for the auxiliary channel (cooling).

The  push-button serves to transit between channels (if the heating – cooling control mode has been selected).

 and  push-buttons serve to change the control signal. The exit to the normal working mode follows after the simultaneous pressure of  and  push-buttons.

At set on-off control on the output 1 (parameter PB=0), one can set the control signal on 0% or 100% of the power, however when the PB parameter is higher than zero, one can set the control signal on any value from the range 0...100%.

12.3. Signal Retransmission

The continuous output can be used for the retransmission of selected value, e.g. in order to the temperature recording in the object or the set point value duplication in multi-zone furnaces.

The signal retransmission will be possible if the output 2 is of continuous type. We begin the signal retransmission from setting the **out2** parameter into **retr**. Additionally, one must set the upper and lower limit of the signal to be retransmitted (**Ao.Lo** and **Ao.Hi**). The signal selection for retransmission is carried out through the **Ao.Fn** parameter.

The recounting method of the retransmitted parameter into a suitable analog signal is shown on the fig. 24.

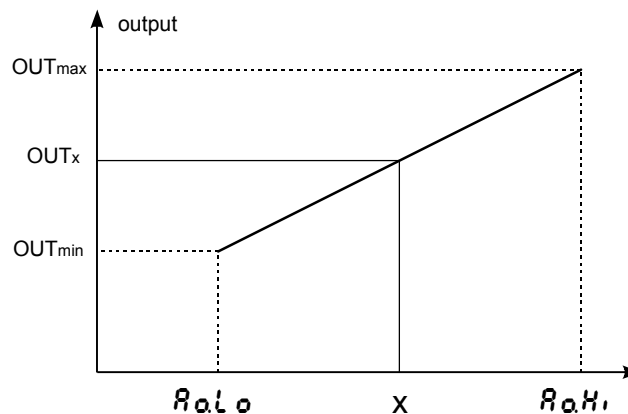

Fig. 24. Recounting of the signal for retransmission

The output signal is calculated acc. to the following formula.

$$wy_x = wy_{\min} + (x - Ao.Lo) \frac{wy_{\max} - wy_{\min}}{Ao.Lo - Ao.Hi}$$

The **Ao.Lo** parameter can be set as higher than **Ao.Hi**, but the output signal will be then, inversed.

12.4. Set Point Change Rate – Soft Start

The limitation of the temperature accretion rate is carried out through the gradually change of the set point value. This function is activated after the controller supply connection and during the change of the set point value. This function allows to reach softly from the actual temperature to the set point value. One must write the accretion value in the **SP.r** parameter and the time unit in the **rRP** parameter. The accretion rate equals zero means that the soft start is disabled.

12.5. Digital Filter

In case when the measured value is instable, one can switch a programmed low-pass filter on. One must set the lowest possible time constant at which the measured value is stable. A high time constant can cause the control instability.

A high time constant can cause a control instability. The time constant of the filter **FLt** can be set from 0.2 sec. up to 100 seconds.

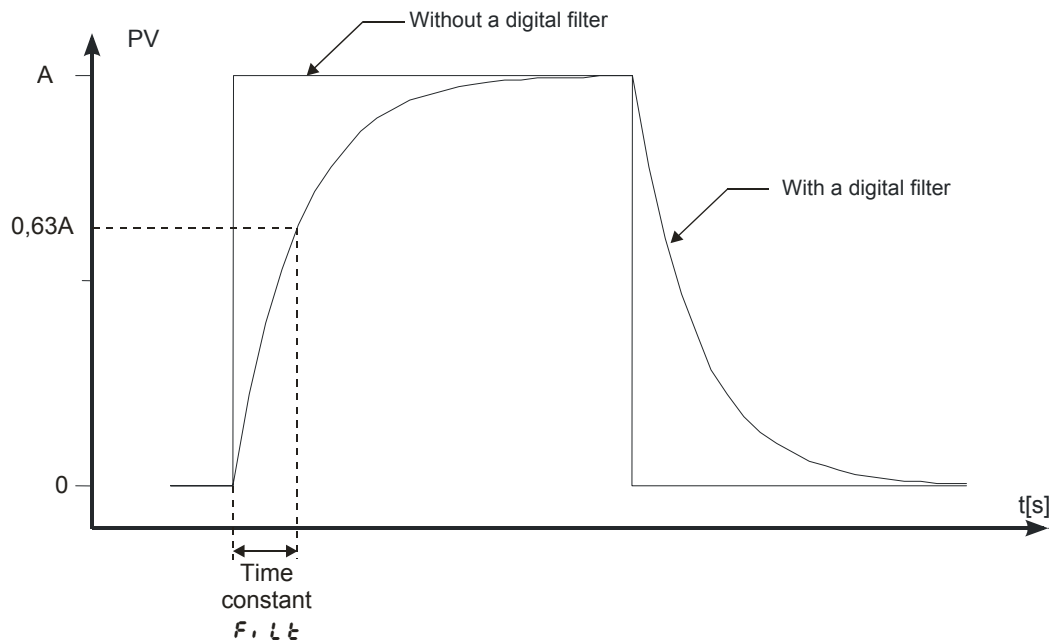

Fig. 25. Time characteristic of the filter

12.6. Manufacturer's Settings

Manufacturer's settings can be restored during the supply connection by holding down and push-buttons, till the moment when the **FAbc** inscription appears on the higher display.

13. PROGRAMMING CONTROL

13.1. Description of Programming Control Parameters

List of configuration parameters

Table 5

PrG – Programming control						
Pr01	Sub-menu of the program no 1					
⋮						
Pr15	Sub-menu of the program no 15					
	PrFG	Sub-menu of program parameters				
		parameter Symbol	Parameter description	Manufacturer's setting	Range of parameter change	
					Sensors	Linear input
		St r t	Way to begin the program	Pu	SP0: from the way defined by SP0 Pu: from the currently measured value	

	SP0	Initial set point value	0,0 °C	MIN...MAX ¹⁾	
	t.n.u.n	Unit for the segment duration time	n.n.SS	n.n.SS: minutes and seconds HH.n.n: hours and minutes	
	r.r.u.n	Unit for the accretion rate of the set point value	n.n	n.n: minutes Hour: hours	
	hold	Locking of the control deviation	d.S	d.S: inactive Lo: lower Hi: upper b.R.n.d: reversible	
	CYC.n	Number of program repetition	1	1...999	
	FR.L	Control after the supply decay	Cont	Cont: program continuation StoP: control stoppage	
	End	Control on the program end	StoP	StoP: Control stoppage L.S.P: fixed set point control with set point from the last segment.	
	P.d	"Gain Scheduling function for the program	oFF	oFF: disabled on: enabled	
St.01	Submenu of program parameters				
:	Submenu of program parameters				
St.15	Submenu of program parameters				
	Parameter symbol	Parameter description	Manufacturer's setting	Range of parameter change	
				sensors	linear input
	tYPE	Kind of segment	t.n.E	t.n.E: segment defined by the time r.R.t.E: segment defined by the accretion d.u.E.L: set point stoppage End: program end	
	t.SP	Set point on the segment end	0.0 °C	MIN...MAX ¹⁾	
	t.n.E	Segment duration	00.01	00.01...99.59 ²⁾	
	r.r	Accretion rate of the set point	0.1	0.1...550.0 °C / time unit ⁴⁾ / (0.1...990.0 °F / time unit ⁴⁾	1...5500 °C ³⁾ / time unit ⁴⁾ / (1...9900 °F ³⁾ / time unit ⁴⁾

		hLdU	Value of the control deviation for which the counting of set point is interrupted	0.0	0.0... 200.0 °C (0.0... 360.0 °F)	0... 2000 °C ³⁾ (0... 3600 °F ³⁾)
		Eu1	State of the auxiliary output no 1	oFF	oFF: disabled oN: enabled	
		Eu2	State of the auxiliary Output no 2	oFF	oFF: disabled oN: enabled	
		P,d	PID set for the segment	P,d1	P,d1 : PID1 P,d2 : PID2 P,d3 : PID3 P,d4 : PID4	

¹⁾ See table 2.

²⁾ The time unit is defined by the parameter **t.u.u.**

³⁾ The resolution to show the given parameter depends on the parameter **dP** – position of decimal point.

⁴⁾ The time unit is defined by the parameter **r.u.u.**

13.2. Definition of Set Point Value Programs.

One can define 15 programs. The maximum number of segments in the program is equal to 15. To render visible parameters related to the programming control in the menu, the parameter **SP.nd** must be set on **PrG**.

For each program, one must set parameters given in the submenu of program parameters. For each segment, one must select the kind of segment and next, parameters depending on the kind of segment, acc. to the table 6. One must also set the output state (only when **out1**, **out2** are set on **Eu1**, **Eu2**) – parameter **Eu1** and **Eu2**.

List of segment configuration parameters

Table 6

tYPE = t,nE	tYPE = rRtE	tYPE = duEL	tYPE = End
t.SP	t.SP	t,nE	
t,nE	rr		
hLdU	hLdU		

The fig. 26 and the table 7 represent an example of set point value program. It is assumed in the program that the temperature in the object has to increase from the initial temperature in the object up to 800°C, with the rate of 20°C per minute, at the active locking from the deviation.

Next, during 120 minutes, the temperature is maintained (locking disabled), after that, the temperature has to decrease to 50°C during 100 minutes (locking disabled). During the object cooling, one must turn on the fan connected to the auxiliary output no 2 (parameter **out2** set on **Eu1**).

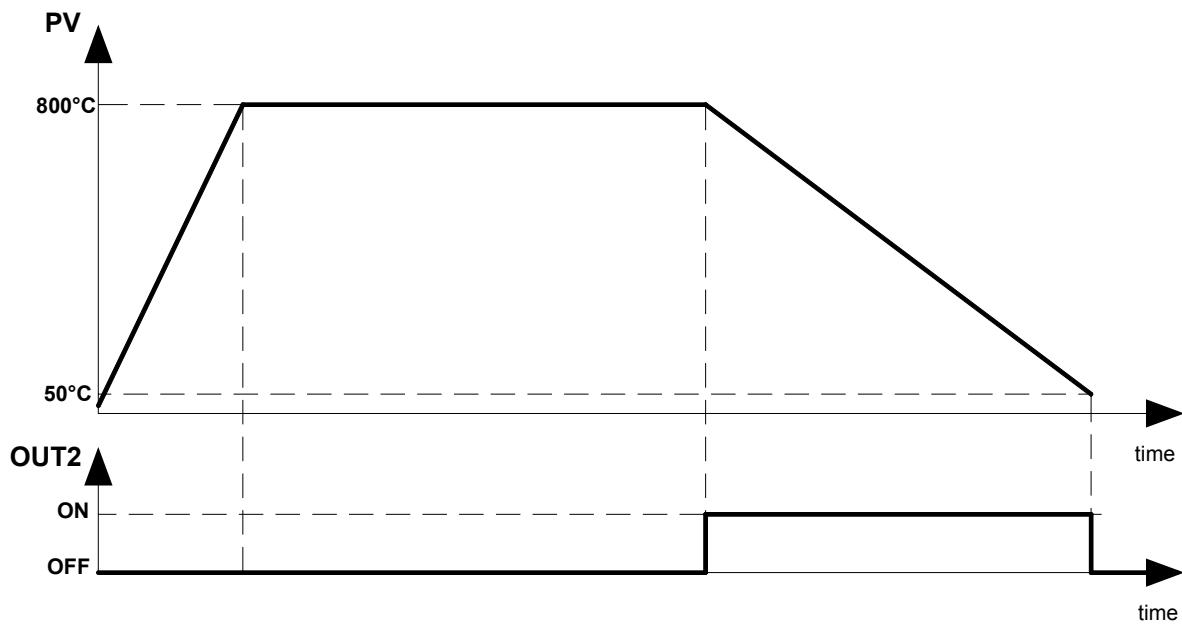

Fig. 26. Example of program

Parameter values for the example as above.

Table 7

	Parameter	value	Meaning
P.C.F.G	St.r.t	P.v	Start to count the set point value from the current temperature
	t.u.u.n	HH:nn	Time unit: hour, minute
	r.r.u.n	nn	Unit for the accretion rate: minute
	h.o.l.d	b.R.n.d	Locking for the program: active – two-sided
	C.Y.C.n	1	Number of program repetitions
	F.R.i.L	c.o.n.t	Program continuation after a supply decay
	E.n.d	S.t.o.p	Control stoppage after the program end
S.t.01	t.Y.P.E	r.R.t.E	Kind of segment: accretion rate
	t.S.P	800,0	Target set point value: 800.0 °C
	r.r	20,0	Accretion rate 20.0 °C / minute
	h.l.d.u	50,0	Active locking, when the deviation exceeds 50.0 °C
	E.v.1	o.F.F	Output 2 as the auxiliary output Ev1: disabled
S.t.02	t.Y.P.E	d.u.E.L	Kind of segment: stoppage of set point value
	t.i.n.E	02.00	Segment time 2h00 = 120 minutes
	E.v.1	o.F.F	Output 2 as the auxiliary output Ev1 – disabled
S.t.03	t.Y.P.E	t.i.n.E	Kind of segment: accretion time
	t.S.P	50,0	Target set point value: 50.0 °C
	t.i.n.E	01.40	Segment time 1h40 = 100 minutes
	h.l.d.u	0,0	Inactive locking
	E.v.1	o.n	Output 2 as the auxiliary output Ev1: enabled
S.t.04	t.Y.P.E	E.n.d	Kind of segment: program end
	E.v.1	o.F.F	Output 2 as the auxiliary output Ev1: disabled

13.3. Control of the Set Point Value Program

When the **SPnd** parameter is set on **PrG**, the controller controls the object in compliance with the set point value changing in time acc. to the given program. Before starting the control with the changeable set point value, one must select the required program (parameter **CPG**).

To start the program, one must press  and  push-buttons when the inscription **StoP** appears on the lower display (fig . 27).

The lighted dot in the right corner of the lower display, means that the programming control is lasting. During the program duration, one can display parameters of the realized program, i.e. program status, program number, number of the operating segment, the number of cycles which still remains to carry out, time which goes by in the segment, time which remained to the end of the segment, time which remained to the program end.

After finishing the program the dot is gone out, or the program is renewed, if the number of the program repetition **CYCn** is higher than 1.

After finishing the control, auxiliary outputs are in the state defined by parameters – output state for the segment set as the program end.

When the parameter **hold** (locking in the program) is set on **Lo**, **H**, or **band** and the locking value **holdu** in the operating segment is higher than zero then, the size of the control deviation is controlled (set point value minus measured value). For **hold=Lo** the locking is active, when the measured value is below the set point value diminished by the locking value. For **hold=H**, the locking is active, when the measured value exceeds the set point value by the locking value. For **hold=band** the locking is active, as for the upper and lower locking. If the locking is active then, the counting of the set point value is interrupted, and the dot in the right corner is flickering. The controller controls acc. to the last calculated set point value.

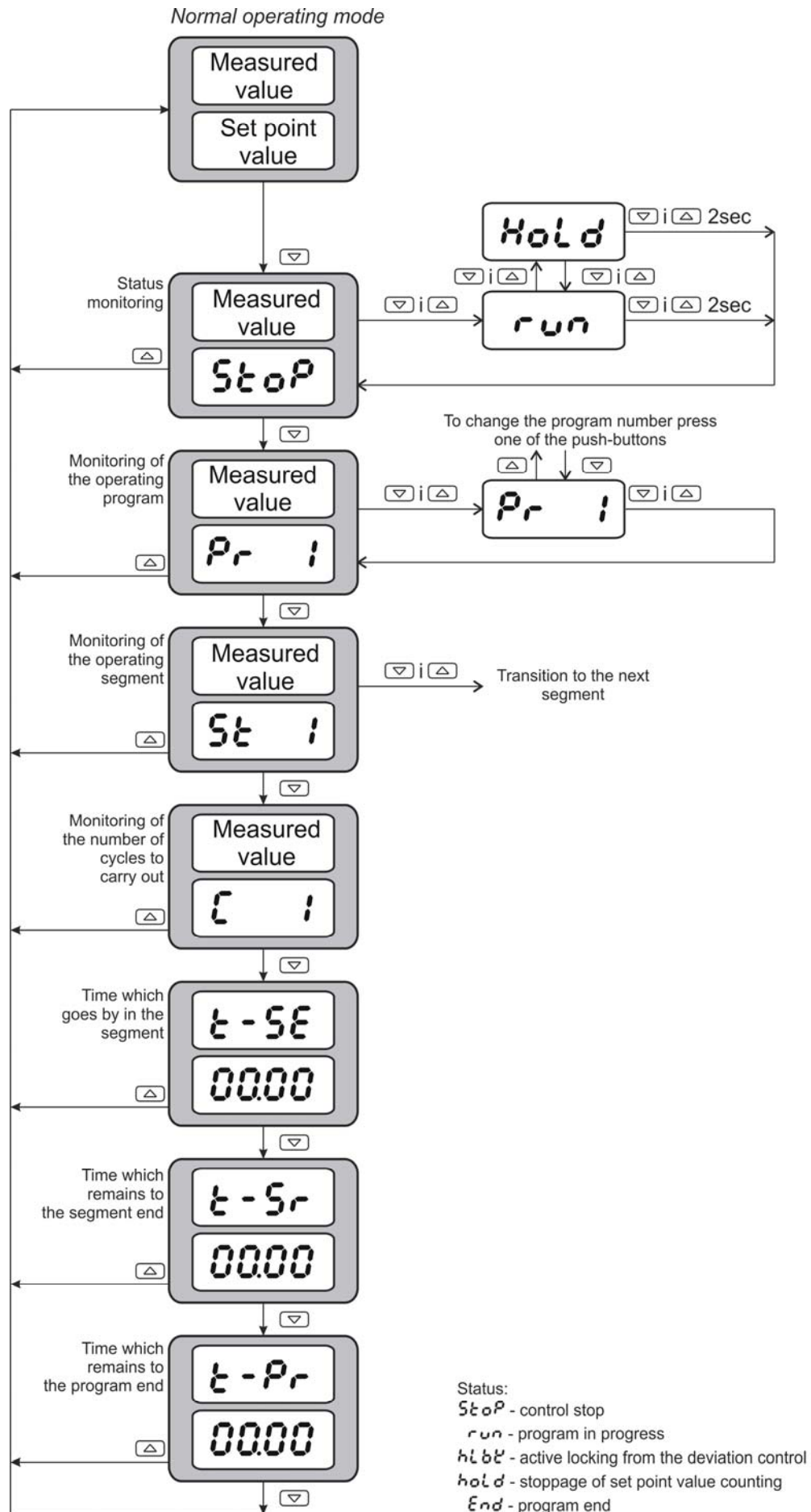

Fig.27. Menu of programming control service

14. RS-485 INTERFACE WITH MODBUS PROTOCOL

14.1. Introduction

This chapter concerns the RE72 controller equipped with a serial interface. The serial interface is in RS-485 standard, with implemented asynchronous communication protocol MODBUS.

Combination of serial interface parameters for the RE72 controller:

- device address: 1..247,
- transmission rate: 4800, 9600, 19200, 38400, 57600 bit/s,
- operating mode: RTU,
- information unit: 8N2, 8E1, 8O1, 8N1,
- data format: integer (16 bit), float (32 bit), float (2x16 bit),
- maximum response time: 500 ms,
- maximum number of registers read out/ stored in one register: 109

The RE72 controller realizes following protocol functions:

Table 8

code	Meaning
03	read out of n-registers
06	write of 1 register
16	write of n-registers
17	identification of the slave device

14.2. Error Codes

If the controller receives a request with a transmission or checksum error, the request will be ignored. For a request synthetically correct but with incorrect values, the controller will send an answer including the error code.

Possible error codes and their meanings are presented in the table 9.

Error codes

Table 9

code	meaning	reason
01	forbidden function	The function is not serviced by the controller
02	forbidden data address	The register address is beyond the range
03	forbidden data value	The register value is beyond the range or the register is only to readout.

14.3. Register Map

Map of register groups

Table 10

Range of addresses	Type of values	Description
4000 – 4099	integer (16 bits)	The value is situated in a 16-bit register
4100 – 5599	integer (16 bits)	The value is situated in a 16-bit register
7000 – 7099	float (2x16 bits)	The value is situated in two successive 16-bit registers; Registers only for readout
7500 – 7599	float (32 bits)	The value is situated in two successive 32-bit registers; Registers only for readout

In the controller, data are situated in 16-bit registers. The list of registers for write and readout is presented in the table 11.

Operation „R-” – means the possibility of readout, and the operation „RW” means the possibility for readout and write.

Map of registers from address 4000

Table 11

Register address	Marking	Operation	Parameter range	Description
4000		-W	1...6	Register of commands: 1 – input in the automatic control mode 2 – input in the manual control mode 3 – beginning of the auto-tuning 4 – erasing of alarm memory 5 – restoration of manufacturer's settings (apart interface settings and defined programs) 6 – restoration of manufacturer's settings of defined programs.
4001		R-	100...999	Number of program version [x100]
4002		R-		Version code of the controller: bit 2 1 0 – OUTPUT 1: 0 0 1 – output 1 – relay 0 1 0 – output 1 – 0/5 V 0 1 1 – output 1 – continuous current : 0/4...20 mA 1 0 0 – output 1 – continuous voltage: 0...10 V bit 5 4 3 – OUTPUT 2: 0 0 1 – output 2 – relay 0 1 0 – output 2 – 0/5 V 0 1 1 – output 2 – continuous current: 0/4...20 mA 1 0 0 – output 2 – continuous voltage: 0...10 V bit 8 7 6 – OPTIONS: 0 0 1 – output 3 - relay 0 1 0 – binary input 0 1 1 – current transformer input 1 0 0 – additional current input: 0/4...20 mA 1 0 1 – supply of transducers: 24V d.c. 30 mA
4003		R-	0...0xFFFF	Controller status – description in table 12
4004		R-	0...0xFFFF	Alarm state – description in table 13
4005		R-	0...0xFFFF	Error status – Description in table 14
4006		R-	acc. to table 17 ¹⁾	Measured value PV
4007		R-	-1999...9999	Measured value on additional input
4008		R-	acc. to table 17 ¹⁾	Current set point value SP
4009		RW	0...1000	Control signal of output 1 [% x10] ²⁾
4010		RW	0...1000	Control signal of output 2 [% x10] ²⁾
4011		R-	0...59994	Timer value [s]
4012		R-	0...500	Heater current when the output is turned on [A x10]
4013		R-	0...500	Heater current when the output is turned off [A x10]
4014	UNIT	RW	0...2	Unit: 0 – Celsius degrees 1 – Fahrenheit degrees 2 – physical units

Register address	Marking	Operation	Parameter range	Description
4015	INPT	RW	0...14	Kind of main input: 0 – resistance thermometer Pt100 1 – resistance thermometer Pt1000 2 – thermocouple of J type 3 – thermocouple of T type 4 – thermocouple of K type 5 – thermocouple of S type 6 – thermocouple of R type 7 – thermocouple of B type 8 – thermocouple of E type 9 – thermocouple on N type 10 – thermocouple of L type 11 – current input: 0-20mA 12 – current input: 4-20mA 13 – voltage input: 0-5 V 14 – voltage input: 0-10 V
4016	DP	RW	0...1 ³⁾⁴⁾ 0...2 ⁵⁾	Position of the decimal point of the main input: 0 – without decimal place 1 – 1 decimal place 2 – 2 decimal places
4017	INLO	RW	-999...9999 ¹⁾	Indication for the lower threshold of the analog main input.
4018	INHI	RW	-999...9999 ¹⁾	Indication for the upper threshold of the analog main input.
4019	SHIF	RW	-999...999 ¹⁾	Shift of the measured value of the main input.
4020	I2TY	RW	0...1	Kind of the additional input: 0 – current input: 0-20mA 1 – current input: 4-20mA
4021	DP2	RW	0...2	Position of the decimal point of the additional input. 0 – without a decimal place 1 – 1 decimal place 2 – 2 decimal places
4022	I2LO	RW	-999...9999 ¹⁾	Indication for the lower threshold of the analog main input.
4023	I2HI	RW	-999...9999 ¹⁾	Indication for the upper threshold of the analog main input.
4024	FILT	RW	0...9	Time-constant of the filter: 0 – OFF 1 – 0.2 sec 2 – 0.5 sec 3 – 1 sec 4 – 2 sec 5 – 5 sec 6 – 10 sec 7 – 20 sec 8 – 50 sec 9 – 100 sec
4025	BNIN	RW	0...7	Binary input function: 0 – none 1 – control stop 2 – switching on manual control 3 – switching SP1 into SP2 4 – erasing of the timer alarm 5 – program start 6 – jump to the next segment 7 – stoppage of set point value counting in the program
4026	-	RW	0...65535	reserved

Register address	Marking	Operation	Parameter range	Description
4027	OUT1	RW	0...9	Function of output 1: 0 – without function 1 – control signal 2 – absolute upper alarm 3 – absolute lower alarm 4 – relative upper alarm 5 – relative lower alarm 6 – relative internal alarm 7 – relative external alarm 8 – control signal of step-by-step control - opening 9 – retransmission ⁸⁾
4028	O1TY	R	1...6	Output 1 type: 1 – relay output 2 – voltage output: 0/5 V 3 – current output : 4-20 mA 4 – current output : 0-20 mA 5 – voltage output: 0-5 V 6 – voltage output:: 0-10 V
		RW	3...4 ⁶⁾	
4029	YFL	RW	0...1000	Control signal of control output for proportional control in case of sensor damage [% x10]
4030	OUT2	RW	0...14	Function of output 2: 0 – without function 1 – control signal 2 – absolute upper alarm 3 – absolute lower alarm 4 – relative upper alarm 5 – relative lower alarm 6 – relative internal alarm 7 – relative external alarm 8 – timer alarm 9 – alarm of heater burning 10 – alarm of output 1 shorting 11 – control signal of step-by-step control- closing 12 – control signal – cooling 13 – retransmission ⁸⁾ 14 – auxiliary output EV1 in the programming control
4031	O2TY	R	0...6	Output 2 type: 0 – without relay 1 – relay output 2 – voltage output: 0/5 V 3 – current output : 4-20 mA 4 – current output : 0-20 mA 5 – voltage output: 0-5 V 6 – voltage output:: 0-10 V
		RW	3...4 ⁶⁾	
4032	OUT3	RW	0...8	Function of output 3: 0 – without function 1 – absolute upper alarm 2 – absolute lower alarm 3 – relative upper alarm 4 – relative lower alarm 5 – relative internal alarm 6 – relative external alarm 7 – timer alarm 8 – auxiliary output EV2 in the programming control
4033	-	RW	0...65535	reserved

Register address	Marking	Operation	Parameter range	Description
4034	ALG	RW	0...1	Control algorithm: 0 – on-off 1 – PID
4035	TYPE	RW	0...1	Kind of control: 0 – direct control – cooling 1 – reverse control – heating
4036	HY	RW	2...999 ¹⁾	Hysteresis HY
4037	GTY	RW	0...2	“Gain Scheduling” function 0 – disabled 1 – from set point value 2 – constant PID set
4038	GSNB	RW	0...2	Number of PID sets for “Gain Scheduling” from the set point value 0 – 2 PID sets 1 – 3 PID sets 2 – 4 PID sets
4039	GL12	RW	acc. to table 17 1)	Switching level for PID1 and PID2 sets
4040	GL23	RW	acc. to table 17 1)	Switching level for PID2 and PID3sets
4041	GL34	RW	acc. to table 17 1)	Switching level for PID3 and PID4 sets
4042	GSET	RW	0...3	Choice of a constant PID set 0 – PID1 1 – PID2 2 – PID3 3 – PID4
4043	PB	RW	0...9999 ¹⁾	Proportional band PB
4044	TI	RW	0...9999	Integration time constant TI [s]
4045	TD	RW	0...9999	Differentiation time constant TD [s x10]
4046	Y0	RW	0...1000	Correction of control signal Y0 (for P or PD control) [% x10]
4047	PB2	RW	0...9999 ¹⁾	Proportional band PB2
4048	TI2	RW	0...9999	Integration time constant TI2 [s x 10]
4049	TD2	RW	0...9999	Differentiation time constant TD2 [s x10]
4050	Y02	RW	0...1000	Correction of control signal Y02 (for P or PD control) [% x10]
4051	PB3	RW	0...9999 ¹⁾	Proportional band PB3
4052	TI3	RW	0...9999	Integration time constant TI3 [s]
4053	TD3	RW	0...9999	Differentiation time constant TD3 [s x10]
4054	Y03	RW	0...1000	Correction of control signal Y03 (for P or PD control) [% x10]
4055	PB4	RW	0...9999 ¹⁾	Proportional band PB4
4056	TI4	RW	0...9999	Integration time constant TI4 [s]
4057	TD4	RW	0...9999	Differentiation time constant TD4 [s x10]
4058	Y04	RW	0...1000	Correction of control signal Y04 (for P or PD control) [% x10]
4059	TO1	RW	5...999	Impulsing period of output 1[s x10]
4060	HN	RW	0...999 ¹⁾	Displacement zone for heating-cooling control or dead zone for step-by-step control
4061	PBC	RW	500...3000	Proportional band PBC [% x10] (in relation to PB)
4062	TIC	RW	0...9999	Integration time constant TIC [s x10]
4063	TDC	RW	0...9999	Differentiation time constant TDC [s]
4064	TO2	RW	5...999	Impulsing period of output 2 [s x10]
4065	A1SP	RW	acc. to table 17 ¹⁾	Set point value for absolute alarm 1
4066	A1DV	RW	-1999...1999 ¹⁾	Deviation from the set point value for relative alarm 1
4067	A1HY	RW	2...999 ¹⁾	Hysteresis for alarm 1
4068	A1LT	RW	0...1	Memory of alarm 1: 0 – disabled 1 – enabled
4069	A2SP	RW	acc. to table 17 ¹⁾	Set point value for absolute alarm 2
4070	A2DV	RW	-1999...1999 ¹⁾	Deviation from the set point value for relative alarm 2
4071	A2HY	RW	2...999 ¹⁾	Hysteresis for alarm 2

Register address	Marking	Operation	Parameter range	Description
4072	A2LT	RW	0...1	Memory of alarm 2: 0 – disabled 1 – enabled
4073	A3SP	RW	acc. to table 17 ¹⁾	Set point value for absolute alarm 3
4074	A3DV	RW	-1999...1999 ¹⁾	Deviation from the set point value for relative alarm 3
4075	A3HY	RW	2...999 ¹⁾	Hysteresis for alarm 3
4076	A3LT	RW	0...1	Memory of alarm 3: 0 – disabled 1 – enabled
4077	-	RW	0...65535	Reserved
4078	-	RW	0...65535	Reserved
4079	-	RW	0...65535	Reserved
4080	-	RW	0...65535	Reserved
4081	AHSP	RW	0...500	Set point value of alarm for the heater current
4082	AHHY	RW	0...500	Hysteresis of alarm for the heater current
4083	SPMD	RW	0...4	Kind of set point value: 0 – set point value SP1 or SP2 1 – set point value with soft start in units per minute 2 – set point value with soft start in units per hour 3 – set point value from the additional input 4 – Set point value acc. to the programmed control
4084	SP	RW	acc. to table 17 ¹⁾	Set point value SP
4085	SP2	RW	acc. to table 17 ¹⁾	Set point value SP2
4086	SP3	RW	acc. to table 17 ¹⁾	Set point value SP3
4087	SP4	RW	acc. to table 17 ¹⁾	Set point value SP4
4088	SPLL	RW	acc. to table 17 ¹⁾	Lower limitation of the fast set point value change
4089	SPLH	RW	acc. to table 17 ¹⁾	Upper limitation of the fast set point value change
4090	SPRR	RW	0...9999 ¹⁾	Accretion rate of the set point value SP or SP2 during the soft start.
4091	ADDR	RW	1...247	Device address
4092	BAUD	RW	0...4	Baud rate: 0 – 4800 1 – 9600 2 – 19200 3 – 38400 4 – 57600
4093	PROT	RW	0...4	Protocol 0 – lack 1 – RTU 8N2 2 – RTU 8T1 3 – RTU 8O1 4 – RTU 8N1
4094	-	RW	0...65535	Reserved
4095	AOFN	RW	0...5	Quantity retransmitted on the main input: 0 – measured value on the main input PV 1 – measured value on the additional input PV2 2 – measured value PV – PV2 3 – measured value PV2 – PV 4 – set point value 5 – deviation (set point value – measured value PV)
4096	AOLO	RW	-1999...9999 ¹⁾	Lower signal limit for retransmission
4097	AOHI	RW	-1999...9999 ¹⁾	Upper signal limit for retransmission
4098	SECU	RW	0...9999	Access code to the menu
4099	STFN	RW	0...1	Auto-tuning function: 0 – locked 1 – unlocked
4100	STLO	RW	acc. to table 17 ¹⁾	Lower threshold for auto-tuning
4101	STHI	RW	acc. to table 17 ¹⁾	Upper threshold for auto-tuning
4102	TOUT	RW	0...250	Time of automatic output from the monitoring mode

Register address	Marking	Operation	Parameter range	Description
4103	TIMR	RW	0...1	Timer function: 0 – disabled 1 – enabled
4104	TIME	RW	1...9999	Time counted down by the timer [min x 10]
4105	DI2	RW	0...1	Monitoring of the auxiliary input: 0 – disabled 1 – enabled
4106	DCT	RW	0...1	Monitoring of heater current: 0 – disabled 1 – enabled
4107	-	RW	0...65535	reserved
4108	-	RW	0...65535	reserved

¹⁾ Value with the decimal point position defined by bits 0 and 1 in the register 4003.

²⁾ Parameter to write only in the manual operating mode

³⁾ Concerns resistance thermometer inputs

⁴⁾ Concerns thermocouple inputs

⁵⁾ Concerns linear inputs

⁶⁾ Range to write for the continuous current output

⁷⁾ Concerns output 1 of binary type

⁸⁾ Concerns output 1 of continuous type.

Register 4003 – controller status

Table 12

bit	Description
0-1	Decimal point position for MODBUS registers from address 4000, depending on the input (0...2) ¹⁾
2-3	Decimal point position for MODBUS registers from address 4000, depending on the additional input (0...2) ¹⁾
4	Auto-tuning finished with failure
5	Soft start: 1 – active, 0 – inactive
6	Timer status: 1 – countdown finished, 0 – remaining states
7	Automatic control/manual: 0 – auto, 1 – manual
8	auto-tuning: 1 – active, 0 – inactive
9-10	Current set of PID parameters: 0 – PID1, 1 – PID2, 2 – PID3, 3 – PID4
11-12	reserved
13	Measured value beyond the measuring range
14	Measured value on the additional input beyond the measuring input
15	Controller error – check the error register

¹⁾ For sensor inputs value is equal 1, for linear inputs the value is depended on the parameter dp (register 4023)

Register 4004 – alarm state

Table 13

bit	Description
0	State of alarm 1.:1 – active, 0 – inactive
1	State of alarm 2.:1 – active, 0 – inactive
2	State of alarm 3.:1 – active, 0 – inactive
3	Reserved
4	Alarm state of heater burning
5	Alarm state of permanent output 1 shorting :1 – active , 0 – inactive
6-15	Reserved

Register 4005 – error register

Table 14

bit	Description
0	Discalibrated input
1	Discalibrated additional input
2	Discalibrated analog output 1
3	Discalibrated analog output 2
4-14	Reserved
15	Checksum error of controller memory

Register map from address 4150

Table 15

Register address		Symbol	operation	Parameter range	Description	
4150			RW	0...14	Program number for realization (0 – means first program)	
4151			RW	0...1	Program start/stop: 0 – program stop 1 – program start (the write causes the program start from the beginning)	
4152			RW	0...1	Stoppage of set point value counting in the program 0 – disabled 1 – enabled	
4153			RW	0...14	Realized segment (0 – means the first program) The write causes the jump to the given segment.	
4154			R-		Control status: 0 – control stop 1 – program in progress 2 – active locking from the control deviation 3 – Stoppage of set point value counting (by the push-button, binary input or interface) 4 – program end	
4155			R-		Number of cycles which remains to the end	
4156			R-		Time which goes out in the segment LSB [s]	
4157			R-		Time which goes out in the segment MSB [s]	
4158			R-		Time to the segment end LSB [s]	
4159			R-		Time to the segment end MSB [s]	
4160			R-		Time to the program end LSB [s]	
4161			R-		Time to the program end MSB [s]	
4162			RW	0...65535	Reserved	
4163			RW	0...65535	Reserved	
4164			RW	0...65535	Reserved	
4165			RW	0...65535	Reserved	
4166			RW	0...65535	Reserved	
4167			RW	0...65535	Reserved	
4168			RW	0...65535	Reserved	
4169			RW	0...65535	Reserved	
4170	Program 1	Program parameters	STRT	RW	0...1	Way to begin the program: 0 – from value defined by SP0 1 – from current measured value
4171			SP0	RW	acc. to table 17 ¹⁾	Initial set point value
4172			TMUN	RW	0...1	Unit for the segment duration: 0 – minutes and seconds 1 – hours and minutes
4173			RRUN	RW	0...1	Unit for the accretion rate of the set point value: 0 – minutes 1 – hours
4174			HOLD	RW	0...3	Locking of control deviations: 0 – inactive 1 – lower 2 – upper 3 – two-sided
4175			CYCN	RW	1...999	Number of program repetitions
4176			FAIL	RW	0...1	Control after a supply decay: 0 – program continuation 1 – control stoppage

Register address		Symbol	operation	Parameter range	Description	
4177	Segment 1	END	RW	0...1	Control on the program end: 0 – control stoppage 1 – fixed set point control with the set point value of the last segment	
4178		PID	RW	0...1	“Gain Scheduling “ function for the program 0 – disabled 1 - enabled	
4179		TYPE	RW	0...3	Kind of segment: 0 – segment defined by the time 1 – segment defined by the accretion 2 – stoppage of the set point value 3 – program end	
4180		TSP	RW	Acc. to table 17 ¹⁾	Set point value on the segment end	
4181		TIME	RW	1...5999	Segment duration	
4182		RR	RW	1...5500 ¹⁾	Accretion rate of the set point	
4183		HLDV	RW	0...2000 ¹⁾	Value of the control deviation, over which the set point value counting is interrupted	
4184			RW	0...3	State of auxiliary outputs (sum of bits): bit 0 is set – auxiliary output EV1 is turned on bit 1 is set – auxiliary output EV2 is turned on	
4185		PID	RW	0...3	PID set for the segment 0 – PID1 1 – PID2 2 – PID3 3 – PID4	
...					...	
4277	Segment 15	TYPE	RW	0...3	Kind of segment	
4278		TSP	RW	acc. to table 17 ¹⁾	Set point value on the segment end	
4279		TIME	RW	0...5999	Segment duration	
4280		RR	RW	1...5500 ¹⁾	Accretion rate of the set point value	
4281		HLDV	RW	0...2000 ¹⁾	Control deviation value, over which the set point value counting is interrupted	
4282			RW	0...3	State of auxiliary outputs	
4283		PID	RW	0...3	PID set for the segment	
...				...		
5766	Program 15	Program parameters	STRT	RW	0...1	Way of program beginning
5767			SPO	RW	acc. to table 17 ¹⁾	Initial set point value
5768			TMUN	RW	0...1	Unit for the segment duration
5769			RRUN	RW	0...1	Unit for the accretion rate of the set point value
5770			HOLD	RW	0...3	Blockings of the control deviation
5771			CYCN	RW	1...999	Number of program repetitions
5772			FAIL	RW	0...1	Way of the controller behaviour after a supply decay.
5773			END	RW	0...1	Way of the controller behaviour on the program end
5774			PID	RW	0...3	“Gain Scheduling” function for the program
5775		TYPE	RW	0...3	Kind of segment	
5776		Segment 1	TSP	RW	acc. to table 17 ¹⁾	Set point value on the segment end
5777			TIME	RW	0...5999	Segment duration
5778			RR	RW	1...5500 ¹⁾	Accretion rate of the set point value
5779			HLDV	RW	0...2000 ¹⁾	Control deviation value, over which the counting of the set point value is interrupted
5780				RW	0...3	State of auxiliary outputs
5781	PID		RW	0...3	PID set for the segment	
...				...		
5873	Segment 1	TYPE	RW	0...3	Kind of segment	

Register address	Symbol	operation	Parameter range	Description
5874	TSP	RW	acc. to table 17 ¹⁾	Set point value on the segment end
5875	TIME	RW	0...5999	Segment duration
5876	RR	RW	1...5500 ¹⁾	Accretion rate of the set point value
5877	HLDV	RW	0...2000 ¹⁾	Control deviation value, over which the counting of the set point value is interrupted
5878		RW	0...3	State of auxiliary outputs
5879	PID	RW	0...3	PID set for the segment

¹⁾ Value with the decimal point position defined by bits 0 and 1 in the register 4002.

Map of registers from address 7000 i 7500

Table 16

Register address	Register address	Symbol	operation	Description
7000	7500		R-	Measured value PV
7002	7501		R-	Measured value on the additional input
7003	7502		R-	Current set point value SP
7006	7503		R-	Control signal of output 1
7008	7504		R-	Control signal of output 2
7010	7505	SP	R-	Set point value SP
7012	7506	SP2	R-	Set point value SP2
7014	7507	A1SP	R-	Set point value for the absolute alarm 1
7016	7508	A1DV	R-	Deviation from the set point value for the relative alarm 1
7018	7509	A2SP	R-	Set point value for the absolute alarm 2
7020	7510	A2DV	R-	Deviation from the set point value for the relative alarm 2
7022	7511	A3SP	R-	Set point value for the absolute alarm 3
7024	7512	A3DV	R-	Deviation from the set point value for the relative alarm 3

Input ranges

Table 17

Kind of sensors	Range		
	UNIT = °C [x10]	UNIT = °F [x10]	UNIT = PU
Pt100	-2000...8500	-3280...15620	
Pt1000	-2000...8500	-3280...15620	
Fe-CuNi (J)	-1000...12000	-1480...21920	
Cu-CuNi (T)	-1000...4000	-1480...7520	
NiCr-NiAl (K)	-1000...13720	-1480...25016	
PtRh10-Pt (S)	0...17670	320...32126	
PtRh13-Pt (R)	0...17670	320...32126	
PtRh30-PtRh6 (B)	0...17670	320...32126	
NiCr-CuNi (E)	-1000...10000	-1480...18320	
NiCrSi-NiSi (N)	-1000...13000	-1480...23720	
chromel – kopel (L)	-1000...8000	-1480...14720	
Linear current (I)			-1999...9999
Linear current (I)			-1999...9999
Linear voltage (U)			-1999...9999
Linear voltage (U)			-1999...9999

15. ERROR SIGNALING

Character messages

Table 18

Error code (upper display)	Reason	Procedure
----	Down overflow of the measuring range or shorting in the sensor circuit.	Check, if the type of chosen sensor is in compliance with the connected one; check, if input signal values are situated in the appropriate range – If yes, check if there is no break in the sensor circuit.
----	Upper overflow of the measuring range or break in the sensor circuit.	Check, if the type of chosen sensor is in compliance with the connected one; check, if input signal values are situated in the appropriate range – If yes, check if there is no break in the sensor circuit.
E-01	Incorrect controller configuration.	After selecting the cooling type control on the output 2, one must choose the reverse control (heating) and the PID algorithm (ALG=PID).
ES--	Auto-tuning is ended with failure	Check the reason of the auto-tuning process interruption in the auto-tuning point.
E-Rd	Input discalibrated	Turn off and turn on again the controller supply, when this not help, contact the nearest service shop.
E-RdR	Continuous output discalibrated	Turn off and turn on again the controller supply, when this not help, contact the nearest service shop.
E-EE	Error of readout verification from the non-volatile memory.	Turn off and turn on again the controller supply, when this not help, contact the nearest service shop. The controller exploitation in his state can cause its unforeseen behaviour.

16. TECHNICAL DATA

Input signalsacc. to table 19

Input signals and measuring ranges

Table 19

Sensor type	Standard	Range		Symbol	
Pt100	EN 60751+A2:1997	-200...850 °C	-328...1562 °F	Pt 1	
Pt1000		-200...850 °C	-328...1562 °F	Pt 10	
Fe-CuNi (J)	EN 60584-1:1997	-100...1200 °C	-148...2192 °F	t - J	
Cu-CuNi (T)		-100...400 °C	-148...752 °F	t - t	
NiCr-NiAl (K)		-100...1372 °C	-148...2501.6 °F	t - k	
PtRh10-Pt (S)		0...1767 °C	32...3212.6 °F	t - S	
PtRh13-Pt (R)		0...1767 °C	32...3212.6 °F	t - r	
PtRh30-PtRh6 (B)		0...1767 °C ¹⁾	32...3212.6 °F ¹⁾	t - b	
NiCr-CuNi (E)		-100...1000 °C	-148...1832 °F	t - E	
NiCrSi-NiSi (N)		-100...1300 °C	-148...2372 °F	t - n	
chromel – kopel (L)		GOST R 8.585-2001	-100...800 °C	-148...1472 °F	t - l
Linear current (I)			0...20 mA	0...20 mA	0 - 20
Linear current (I)		4...20 mA	4...20 mA	4 - 20	
Linear voltage (U)		0...5V	0...5V	0 - 5	
Linear voltage (U)		0...10V	0...10V	0 - 10	

¹⁾ The intrinsic error is related to measuring range: 200...1767 °C (392...3212.6 °F)

Intrinsic error of the real value measurement

0.2%, for resistance thermometer inputs,

0.3%, for inputs for thermocouple sensors (0.5% – for B, R, S);

0.2% ± 1 digit, for linear inputs

Current flowing through the resistance

thermometer sensor0.22 mA

Measurement time 0.2 s

Input resistance:

- for voltage input 150 k Ω
- for current input 5 Ω

Error detection in the measuring circuit:

- thermocouple, Pt100, Pt1000 overrun of measuring range
- 0...10 V..... over 11 V
- 0...5 V..... over 5,5 V
- 0...20 mA..... over 22 mA
- 4...20 mA..... under 1 mA and over 22 mA

Additional input:

- intrinsic error of the real value
Measurement.....0.3% \pm 1 digit
- measurement time 0.5 sec
- input resistance 100 Ω

Setting range of controller parameters:

See table 1

Binary input..... voltageless

- shorting resistance \leq 10 k Ω
- opening out resistance \geq 100 k Ω

Kinds of outputs 1 and 2:

- voltageless relay NOC contact, load capacity 2 A/230 V a.c.,
- voltage transistor 0/5 V, maximum load capacity: 40 mA
- continuous voltage..... 0...5 V, 0...10 V at $R_{load} \geq 1$ k Ω
- continuous current 0...20 mA, 4...20 mA at $R_{load} \leq 500$ Ω

Kinds of output 3:

- voltageless relay NOC contact, load capacity 1 A/230 V a.c.,

Way of output operation:

- reverse for heating
- direct for cooling

Error of analog outputs 0.2% of the range

Digital interface..... RS-485

- protocol..... Modbus
- transmission rate 4800, 9600, 19200, 38400, 57600 bit/s
- mode..... RTU – 8N2, 8E1, 8O1, 8N1
- address..... 1...247
- maximum response time..... 500 ms

Supply of object transducers 24V d.c. \pm 5 %, max.: 30 mA

Signaling:

- switching the output 1 on
- switching the output 2 on
- switching the output 3 on or switching the binary input on
- mode of manual control
- auto-tuning process

Rated operating conditions:

- supply voltage 85...253 V a.c./d.c.
20...40 V d.c.
- frequency 40...440 Hz
- ambient temperature 0...23...50 $^{\circ}$ C

- storage temperature -20...+70 °C
- relative air humidity < 85 % (condensation inadmissible)
- preheating time 30 min
- operating position any
- resistance of wires connecting the
resistance thermometer or the thermocouple
with the controller..... < 20 Ω / wire

Power input < 8 VA

Weight..... < 0.2 kg

Protection grade ensured by the casing acc. to EN 60529

- from the frontal plate IP65
- from the terminal side IP20

Additional errors in rated operating conditions caused by:

- compensation of thermocouple cold
junction temperature changes.....≤ 2 °C,
- ambient temperature change≤100% value of intrinsic error /10 K.

Safety requirements acc. to EN 61010-1

- installation category III,
- pollution level,..... 2
- maximum phase-to-earth operating voltage:
 - for supply circuits, outputs.....300 V
 - for input circuits 50 V
- altitude above sea level.....< 2000 m

Electromagnetic compatibility

- noise immunity.....acc. to EN 61000-6-2 standard
- noise emissions..... acc. to EN 61000-6-4 standard

17. CONTROLLER VERSION CODES

The way of coding is given in the table 20

Table 20

Controller RE72 –		X	X	X	X	XX	X	X
Output 1	relay	1						
	Voltage: 0/5 V	2						
	continuous current: 0/4...20 mA	3						
	continuous voltage: 0...10 V	4						
Output 2	relay ¹⁾		1					
	Voltage: 0/5 V		2					
	continuous current: 0/4...20 mA		3					
	continuous voltage: 0...10 V		4					
Option	none			0				
	output 3 - relay			1				
	binary input			2				
	current transformer input ¹⁾			3				
	additional current input: 0/4...20 mA			4				
	supply of transducers: 24V d.c., 30 mA			5				
Supply	85...253 V a.c. / d.c.				1			
	20...40 V a.c. / d.c.				2			
Version	standard					00		
	custom-made ²⁾					XX		
Language version	Polish						P	
	English						E	
	Other ²⁾						X	
Acceptance tests	without extra quality requirements							0
	with an extra quality inspection certificate							1
	acc. to customer's request ²⁾							X

¹⁾ Only, when a relay or voltage 0/5 V is also selected on the output 1.

²⁾ Only after agreeing by the manufacturer.

Ordering Example

The code: **RE72 – 1.2.2.1.00.E.1** means:

RE72 – controller of RE72 type,

1 – output 1: relay

2 – output 2: voltage 0/ 5 V

2 – option with binary output

1 – supply: 85...253 V a.c./d.c.

00 – standard version

E – documentation and descriptions in English version

1 – with an extra quality inspection certificate.

When ordering please respect the code number.

18. MAINTENANCE AND GUARANTEE

The RE72 controller does not require any periodical maintenance.

In case of some incorrect operations:

In the period of 18 months from the date of purchase:

One should take the controller down from the installation and return it to the Manufacturer's Quality Control Dept.

If the unit has been used in compliance with the instructions, the Manufacturer warrants to repair it free of charge.

After the guarantee period:

One should turn over the controller to repair it in a certified service workshop.

The disassembling of the casing causes the cancellation of the granted guarantee.

Our policy is one of continuous improvement and we reserve the right to make changes in design and specifications of any products as engineering advances or necessity requires and revise the above specifications without notice.

SALES PROGRAM

- DIGITAL AND BARGRAPH PANEL METERS
- MEASURING TRANSDUCERS
- ANALOG PANEL METERS (DIN INSTRUMENTS)
- INDUSTRIAL CONTROLLERS
- DOT, PEN AND PAPERLESS RECORDERS
- POWER CONTROL UNITS AND SOLIDE-STATE RELAYS
- 1-PHASE AND 3-PHASE WATT-HOUR METERS
- ACCESSORIES FOR MEASURING INSTRUMENTS
(SHUNTS AND CURRENT TRANSFORMERS)
- INTEGRATION ELEMENTS OF MEASURING NETWORKS
- LARGE-SIZE ALPHANUMERICAL DISPLAY PANELS
- MEASURING SYSTEMS (ENERGY, HEAT, CONTROL)
- CUSTOM - MADE PRODUCTS

**CONTROL
MEASUREMENT
RECORDING**

WE ALSO OFFER OUR SERVICES IN THE PRODUCTION OF:

- ALUMINIUM ALLOY PRESSURE CASTINGS
- PRECISION ENGINEERING AND THERMOPLASTICS PARTS
- SMT ASSEMBLY SERVICES
- SUBCONTRACTED ELECTRONIC DEVICES

QUALITY PROCEDURES:

According to ISO 9001 and ISO 14001 international requirements.

All our instruments have CE mark .

For more information, please write to or phone our Export Department
or visit our website: www.lumel.com.pl/en/

RE72-09/1 (6.10.2010)



Lubuskie Zakłady Aparatów Elektrycznych - LUMEL S.A.

ul. Sulechowska 1, 65-022 Zielona Góra, POLAND

<http://www.lumel.com.pl>

Tel.: (48-68) 32 95 1 00 (exchange)

Fax: (48-68) 32 95 1 01

e-mail: lumel@lumel.com.pl

<http://www.lumel.com.pl>

Export Department:

Tel.: (48-68) 329 53 02

Fax: (48-68) 325 40 91

e-mail: export@lumel.com.pl