

19" – 32" High Definition Digital Advertising Display

User's Manual

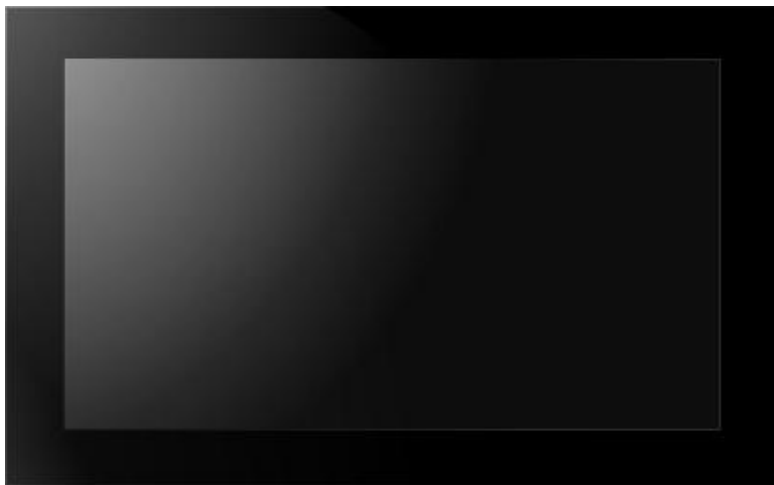

Manual Version PF19-32HDB2.0

Our Full Product Range

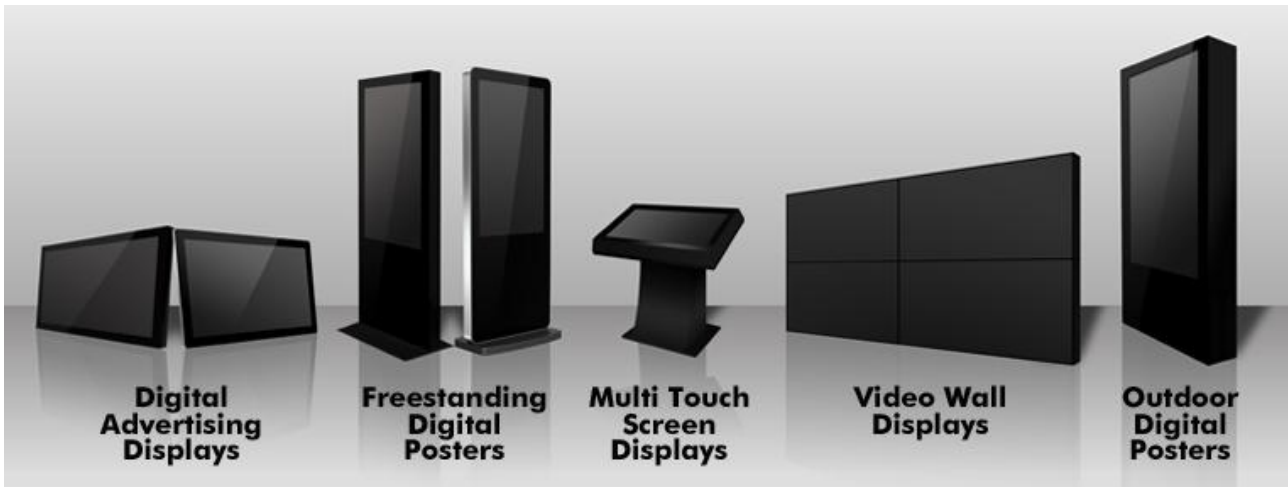

Safety Instructions



- Please keep the display away from any heat sources. Place the display in a stable and well-ventilated place.
- Please handle with care as product contains glass.
- The holes or openings on the display are designed for ventilation. Do not cover or block the ventilation holes or openings with any objects.
- Remove protective covering from the screen before you use the display.
- Shut off the power supply before cleaning. Use a soft lint-free cloth instead of a tissue to wipe the screen.
- You may use a glass cleaner to clean the product as required. However, never spray the cleaner directly onto the display surface.
- Do not attempt to repair this product yourself! Improper disassembly of the product may invalidate the warranty and lead to possible danger
- If you have a problem that cannot be solved using the "Troubleshooting" guidelines, please contact your supplier.

Quick Start Guide

This section of the guide is to allow swift set up and use of the unit. Please refer to the main part of the User Guide for full information on use of the unit.

Please follow the steps detailed below:

1. Unpack unit and place in desired location
2. Take the power lead from the accessories bag, connect power lead and plug into mains outlet. The unit will power ON automatically. After powering up you will be greeted by the home screen.
3. Collect the files you wish to display and make sure they are supported by the unit (see Section 2.1)
4. On a PC copy the files you want to play onto an empty USB drive. These should be in the root directory (without putting them into a folder). Remove USB from PC.
5. Insert USB drive into the one of the USB ports located inside the locker of the unit (see Figure 1).

The screen should indicate that it is copying the files onto the unit. Please note that all files currently stored in the unit will be deleted. Once completed, the screen will display a message to remove the USB drive.

6. Remove the USB drive and the unit will reboot and play the stored files in a loop.



Figure 1 Position of screen inputs

Contents:

1.	Introduction	6
1.1	Box Contents	6
1.2	Product Overview.....	6
1.3	Remote Control	7
1.4	Replacing the Remote Control Battery	8
1.5	System Menu Operation	9
1.5.1	System Settings	10
1.5.2	Playback Control.....	13
1.5.3	Date & Time	15
1.5.4	On/Off Timer	15
1.5.5	Local ID	17
1.5.6	Screen Mode	17
1.5.7	File Management	18
1.5.8	Exit.....	19
1.6	Display Settings	20
2.	System Operation	23
2.1	Supported Media Files	23
2.2	Steps to Load Media Files	24
2.3	Inputs	24
3.	Installation	25
3.1	Wall Mounting – Landscape Orientation	25
3.2	Wall Mounting – Portrait Orientation	27
4.	Advanced Guide.....	29
4.1	Main Menu.....	29
4.2	Creating Playlists	29
4.2.1	Add Schedule.....	30
4.2.2	Add Selected Items.....	30
4.2.3	Saving	33
4.3	Editing Playlists.....	34

4.3.1	Deleting Items	34
5.	F.A.Qs and Troubleshooting Guide	35
5.1	My scrolling text message does not appear on my screen	35
5.2	How do I play PowerPoint presentations on my display?	36
5.2.1	Option 1 (for plain slides with no animation):	36
5.2.2	Options 2 (for presentations with animation):	36
5.3	Wireless connection.....	37
5.4	Video Format Conversion	37
5.4.1	Format Factory	37
5.4.2	HD Video Converter Deluxe	39
5.5	Connecting screen to PC	40
5.6	My media file does not fit properly on the screen	40
5.7	My media file will not display or is missing from the playlist	41
5.8	My media files will not update.....	41
5.9	My moving GIF files will not move.....	41
5.10	My screen is stuck on the "Copy Complete" message.....	41

Table of Figures

Figure 1	Position of screen inputs.....	3
Figure 2	Product Overview.....	6
Figure 3	Home Screen	9
Figure 4	Screen inputs.....	24
Figure 4	Mark out the mounting plate	25
Figure 5	Drill holes	25
Figure 6	Insert wall plugs	26
Figure 7	Security screw	26
Figure 8	Mark out the mounting plate	27
Figure 9	Drill holes	27
Figure 10	Insert wall plugs	28
Figure 11	Security screw	28

1. Introduction

Congratulations on your purchase of our product. Please read carefully and follow all instructions in the manual before first use.

The product should not be exposed to liquids dripping or splashing and no objects filled with liquids, such as vases, should be placed on the product.

For user convenience, a number of operations can be performed through the remote control.

Attention:

1. Do not change any default setting when it is unnecessary.
2. Keep the product far away from water during installation and use.

1.1 Box Contents

- 1 x Digital Advertising Display.
- 1 x Mounting Plate (with Security Screw).
- 1 x Power Cable.
- 1 x CD (User Manual and Software).
- 1 x Remote Control (with 2xAAA batteries).

1.2 Product Overview

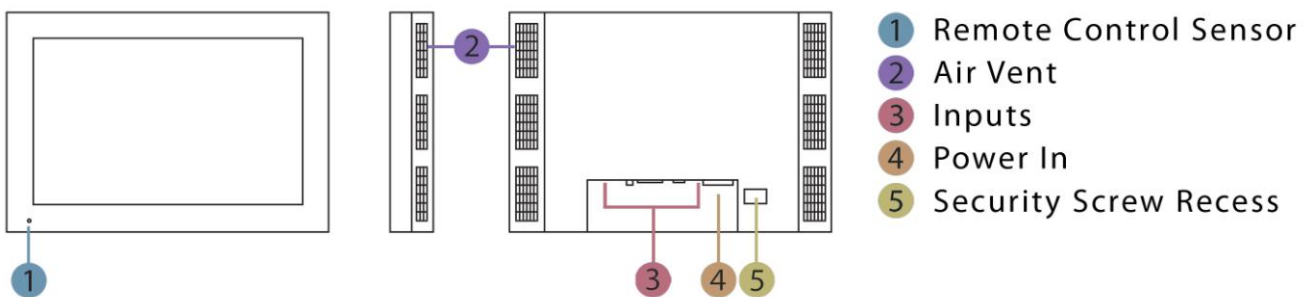

Figure 2 Product Overview

1.3 Remote Control



Button	Function
POWER/⏻	Power on or off
MENU	Display settings
SETUP	Menu settings
SOURCE/↻	Input source
▲	Up (navigation)
◀	Left (navigation)
▶	Right (navigation)
▼	Down (navigation)
▶/	Play media
■	Stop media
◀◀	Previous
▶▶	Next
🔊	Display settings
🔊+	Raise volume
🔊-	Lower volume

1.4 Replacing the Remote Control Battery

1. Slide the battery cover off, as shown below.
2. Remove the used batteries.
4. Insert the two new AAA batteries with their terminals corresponding to the indicators.
5. Put the cover back on.

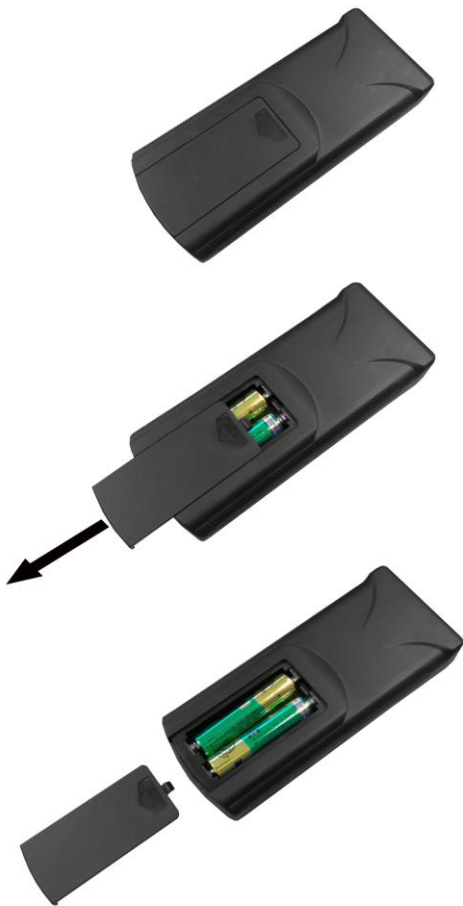

1.5 System Menu Operation

In order to access the Setup Menu you must first press "STOP" button to go back to the home screen (pictured below). You can then bring up the Main Menu by pressing "SETUP".



Figure 3 Home Screen

Main Menu includes following sub-menus: System Settings, Playback Control, Date & Time, ON/OFF Timer, Local ID, Screen Mode, File Management and Exit.

Press ↑ & ↓ to select the right item, press "PLAY" to confirm selection. Choose Exit to exit the Main Menu.

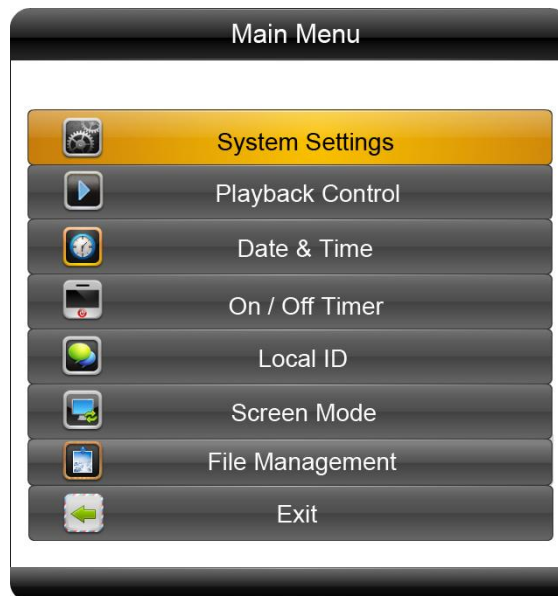

1.5.1 System Settings

The sub-menus within this section are OSD Language, Clock Display, Scrolling Text, USB Port as well as Restore to Factory Settings and Return to Main Menu options.

OSD Language

The On Screen Display supports four languages – Chinese, English, French and Japanese. As with all menu operation press ↑ & ↓ to select the right item, press "PLAY" to confirm selection.

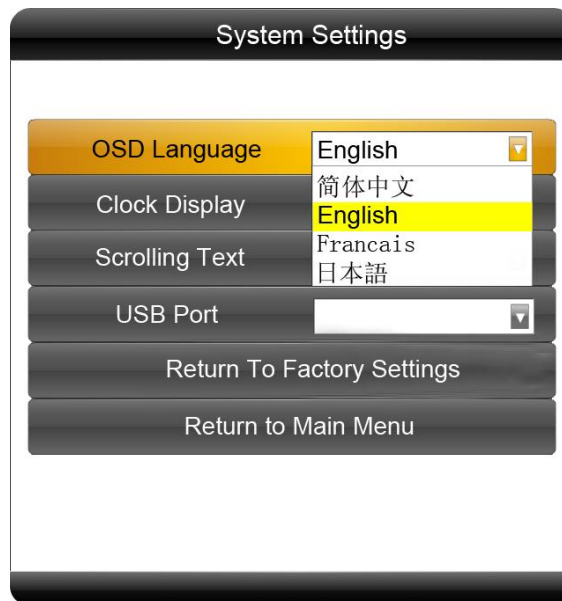

Clock Display

There are 5 options as pictured below:

- Top Left: The time will be displayed on top left of the screen.
- Bottom Left: The time will be displayed on bottom left of the screen.
- Top Right: The time will be displayed on top right of the screen.
- Bottom Right: The time will be displayed on bottom right of the screen.
- Off: The screen doesn't display time.

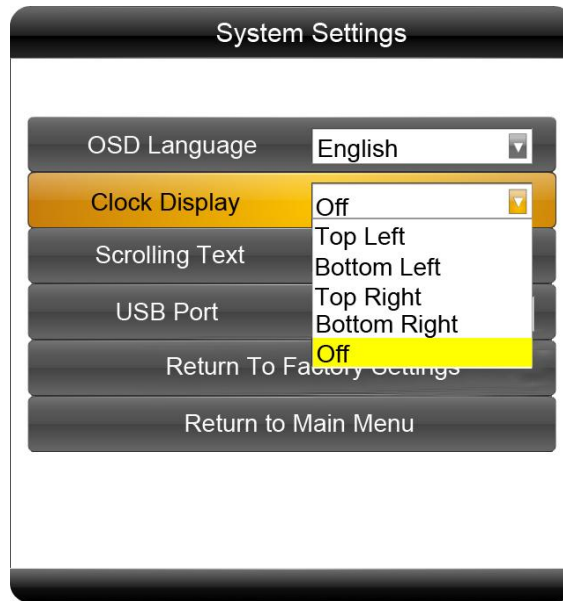

Scrolling Text

There are 2 options as pictured below:

- Off: The screen doesn't display scrolling text.
- On: The screen will display scrolling text from the txt file in the playlist, if there is no playlist or .txt file, the screen doesn't display scrolling text.

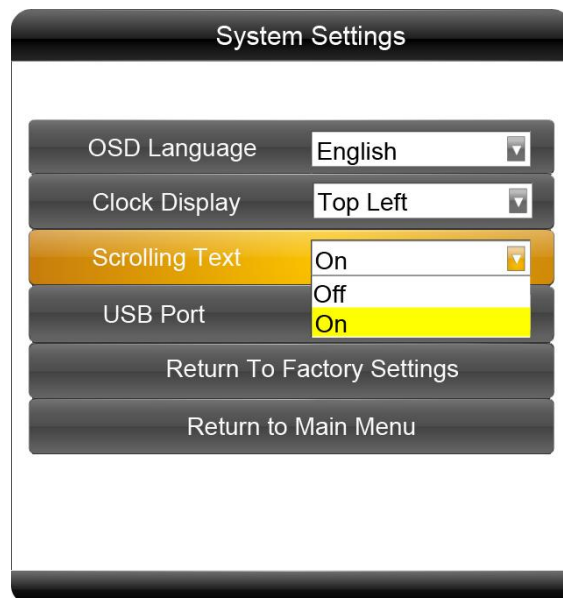

USB Port

There are 2 options as pictured below:

- On: The screen restarts automatically once media is loaded (recommended).
- Off: The screen must be turned off and back on by the mains (or reset button pressed) once media has loaded and media cannot be loaded on home screen.

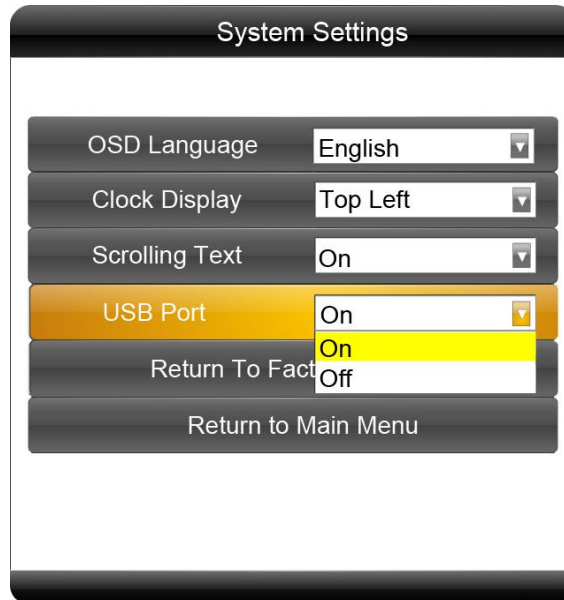

Restore To Factory Settings

Highlight "Yes" and press "PLAY" to restore factory settings; this will restore all system settings back to default.



1.5.2 Playback Control

Storage Priority

This section is used to set where the screen will read the media files from - Internal Storage or USB Disk. There are two options as pictured below:

- Internal Storage: The screen reads media files from internal storage only (updated using USB drive).
- USB Disk: The screen reads media files **directly** from USB disk only.

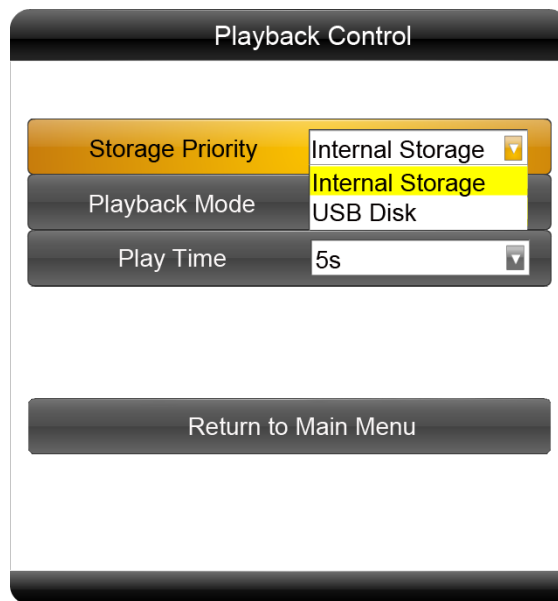

Playback Mode

There are 3 options as pictured below:

- Free: The user copies the media files into USB stick and the screen will read it.
- Encrypted: N/A function, please DO NOT select.
- None Encrypted: N/A function, please DO NOT select.

Note: Under the Free Playback Mode, the screen will display the media files according to the file name. For example, it will play in this order: 001.avi, 002.jpg, 003.mp4, or a.avi, b.jpg, c.mp4.

You must only use alphanumeric characters in the file name (a-z 0-9) DO NOT use spaces or special characters in the file name (!@#¥%&*).

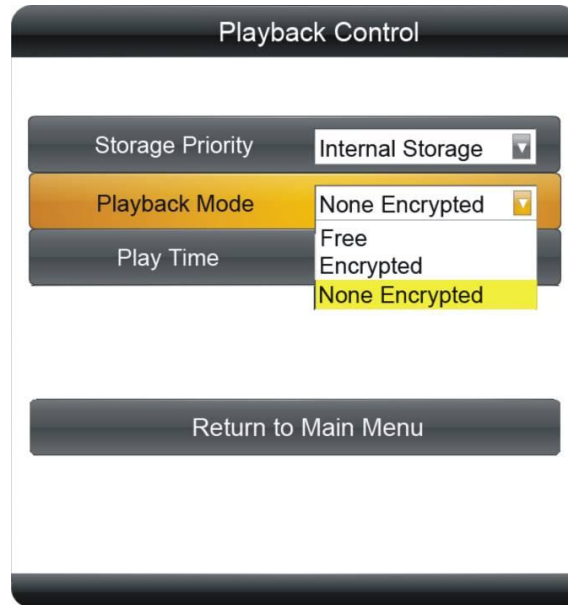

Play Time

This is used to set the display time for image files under the Free Playback Mode without using a playlist file.

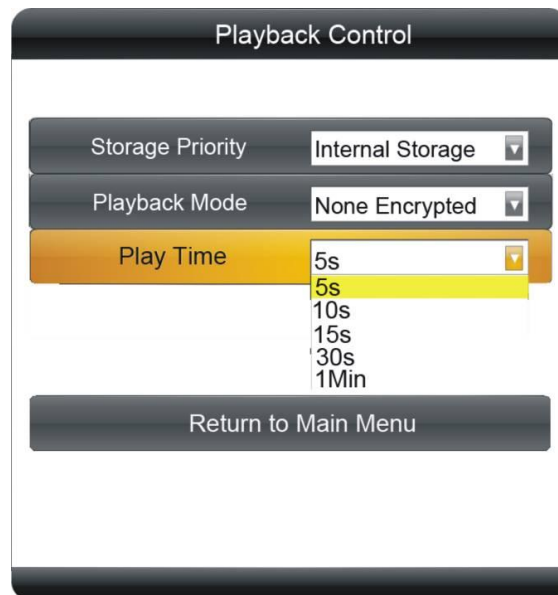

1.5.3 Date & Time

To set accurate date and time first select this menu to open the options pictured below. Next, use ← & → to select which value you wish to modify. Now you can change the setting by pressing ↑ & ↓. Finally highlight "Update Date & Time" and pres "PLAY". The date and time have been updated; you can now select Return to the Main Menu.

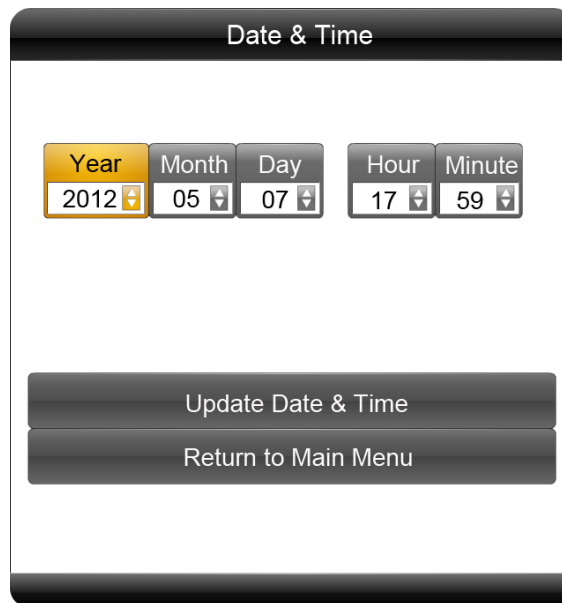

1.5.4 On/Off Timer

There are 2 modes to choose from - Daily and Weekly.

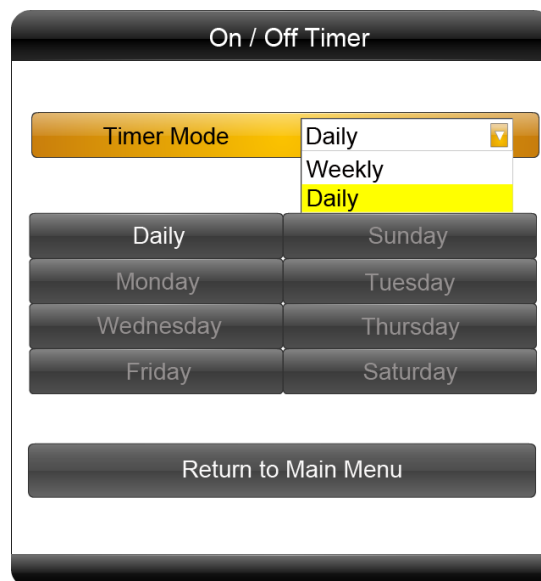

Weekly

You can set the on/off timer for each individual day of the week. For example, on Sunday, 6:00am on, 11:00am off:

1. Choose Weekly in the On/Off Timer menu, press "PLAY" to confirm:

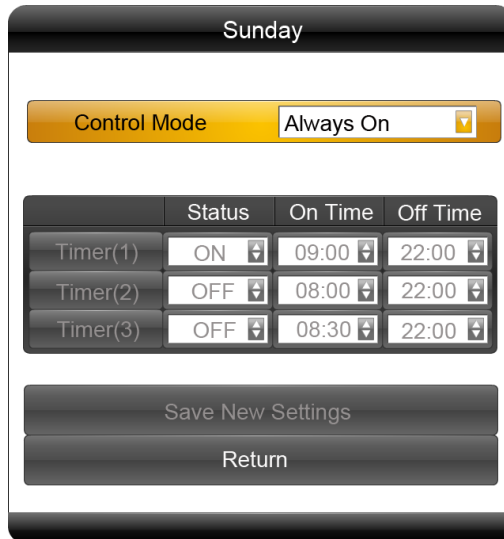

2. Choose Timer in the Timer Mode, then the three Timer items become selectable. Choose the Status of Timer(1) to be ON, then make the On Time to be 06:00, Off Time to be 11:00.

3. Choose Save New Settings to finish the setting. Then highlight and select Return.

Daily

You can also set the on/off timer to be the same every day.

Choose Daily in the On/Off Timer menu, press "PLAY" to confirm:

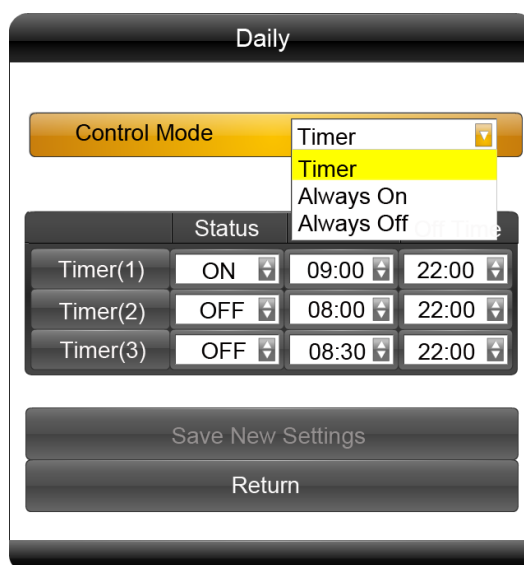

There are 3 options available:

- Timer: user can set 3 timer groups; each group can set "On" or "Off".
- Always On: after connecting the power cable, the product will powered on.
- Always Off: after connecting the power cable, the product will power off automatically one minute later.

1.5.5 Local ID

This function is reserved for network usage (not supported on this screen). Please ensure that the ID is set to "000000" as pictured below, once set, highlight and select Save and then Return to Main Menu.

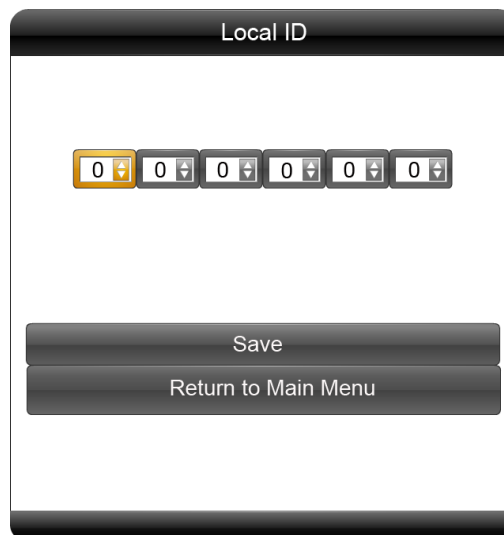

1.5.6 Screen Mode

You can change the orientation of the Home Screen and On Screen Display depending on how your screen is installed. If your screen is mounted in portrait mode please select Vertical then highlight and select Save and Reboot. Your screen will now restart and when it reboots back to the Home Screen your OSD should be in the correct orientation.

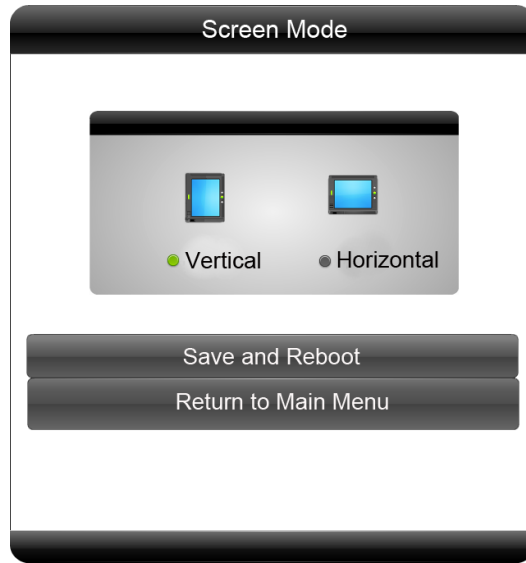

If your screen is mounted in landscape orientation please select Horizontal then highlight and select Save and Reboot. Your screen will now restart and when it reboots back to the Home Screen your OSD should be in the correct orientation.

1.5.7 File Management

Here, you can check storage information such as memory capacity, used space and free space. You can also format the disk. You should be extremely careful here as **formatting the disk will result in a total loss of data.**

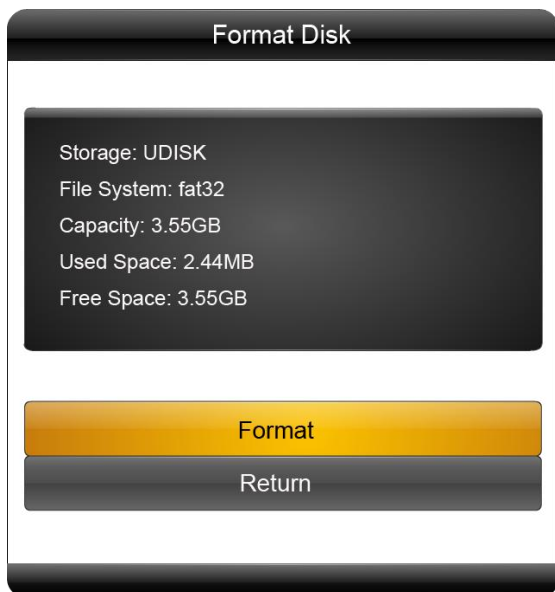

1.5.8 Exit

Highlighting and selecting this section will exit the main menu.

1.6 Display Settings

As well as having a main system menu that can be accessed through your home screen, the unit also has a display setting menu for changing which input source is being displays as well as altering values such as brightness, contrast and saturation. This can be accessed at any time by pressing the "MENU" button on your remote control.

Source

Here you can select which video signal the screen displays. As a default it is set to "Digital Signage" as this plays from the internal media player. You can also select HDMI and VGA, to do so navigate to your desired input source and press the "PLAY" button on your remote control. To go back to the previous menu navigate to Return and press "PLAY" on your remote control.

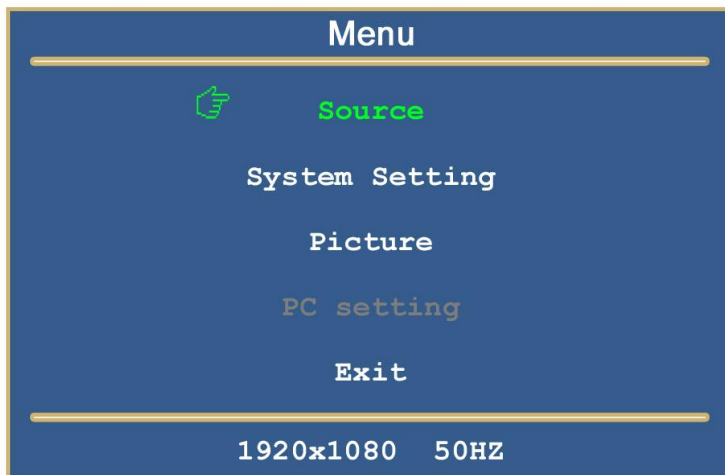

System Setting

Here you can set the OSD Language to either English or Chinese. To go back to the previous menu navigate to Return and press "PLAY" on your remote control.

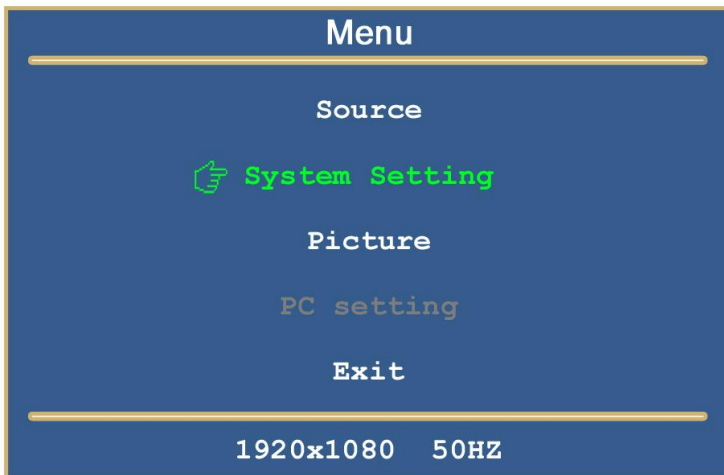

Picture

Here you can alter the overall image settings of your screen. The default value for all the image settings is 50. To adjust the Brightness, Contrast and Saturation of your display navigate to the setting, press "PLAY" on your remote and use the left and right navigation buttons to adjust the value accordingly. You can also alter the colour balance of your screen by highlighting ColourTemp, selecting User and then adjusting Red, Green and Blue balance in the same manner as before. The default value of these settings is 128.

Note: it is recommended not to change the image settings of your screen unnecessarily.

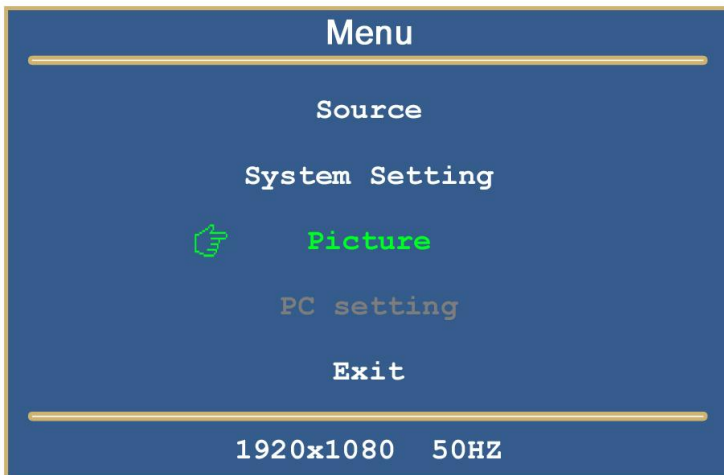

Exit

To exit from this Display Settings menu, navigate to Exit and press "PLAY". If inactive for more than 10 seconds, you will automatically exit this menu.

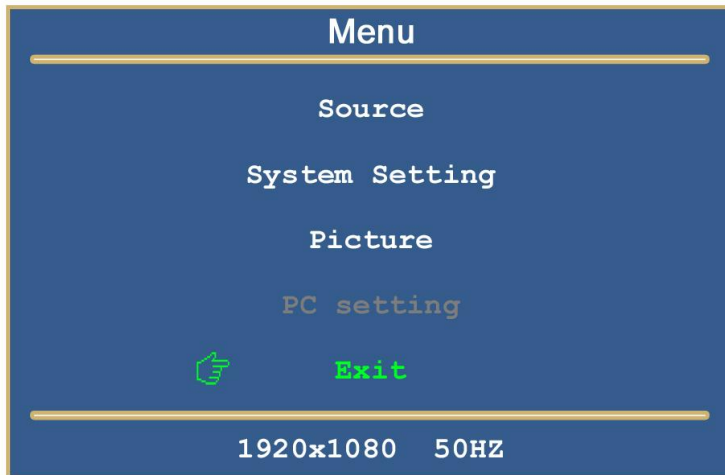

2. System Operation

2.1 Supported Media Files

Media Type	Supported File Type
Image	JPG, BMP, PNG, GIF
Video	MPG, AVI, MP4, TS
Audio	MP3, WMA

1. This unit does NOT support WMV or FLV video file types.
2. This unit does NOT support Sony ATRAC3, DTS or Dobby HD audio file types.

Note: Video and image files should be a maximum 1920x1080 resolution (16:9 aspect ratio).

2.2 Steps to Load Media Files

1. Copy the files you want to play on to USB drive in the root directory (without putting them into a folder).
2. Insert USB drive into the USB slot (see Figure 1).
3. This will automatically delete any files currently stored on the unit's internal memory.
4. The files will then be copied to the internal memory and once completely loaded it will ask you to remove USB drive.
5. Remove the USB drive.
6. The unit will now restart (if it doesn't please turn off and back on via the mains or press the reset button) and play the stored files in a loop.

2.3 Inputs

LAN – Local Area Network Input (this screen does not support network function)

HDMI – High Definition Multimedia Interface Signal Input (for HD Video & Audio signal)

VGA – Video Graphics Array Signal Input (for Video signal)

3.5mm Audio Input

USB – Universal Serial Bus (both for updating internal media player)

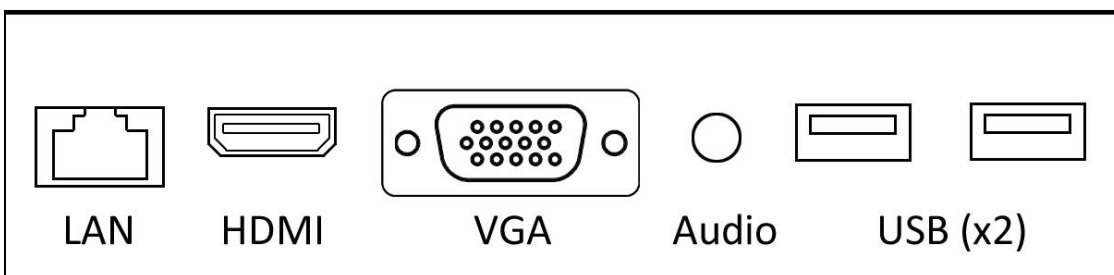

Figure 4 Screen inputs

3. Installation

3.1 Wall Mounting – Landscape Orientation

1. Empty contents of the box and test the screen's power supply before mounting.
2. Clean the wall and mark out the position of the mounting plate.

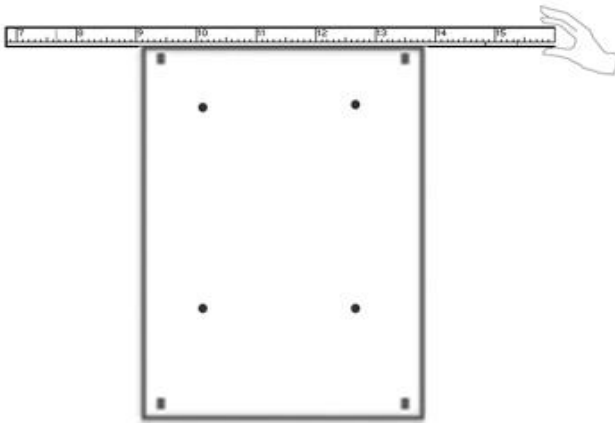

Figure 5 Mark out the mounting plate

3. Mark out the plates hole positions on the wall for drilling (you can drill your own holes in the mounting plate if required).

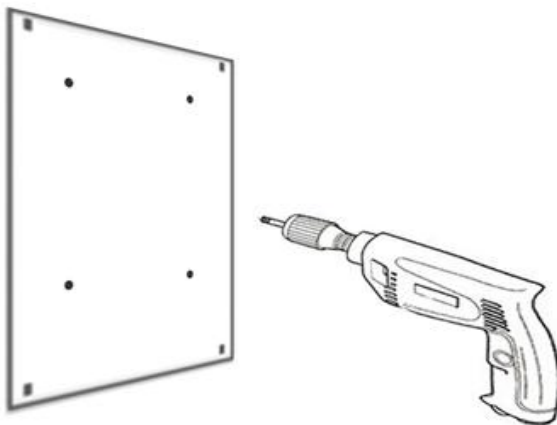

Figure 6 Drill holes

4. Once holes are drilled into the wall insert wall plugs and fix the plate to the wall using additional screws.

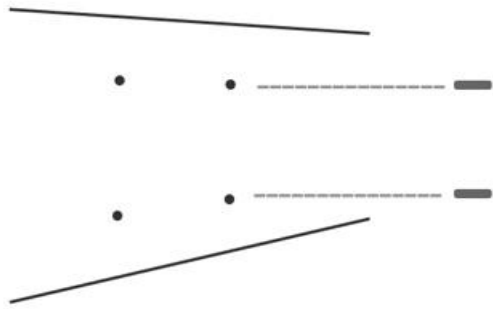

Figure 7 Insert wall plugs

5. Once secured to the wall, hang the display on the bracket and connect to the mains.
6. For an extra security measure secure the display to the wall bracket using the security screw provided.

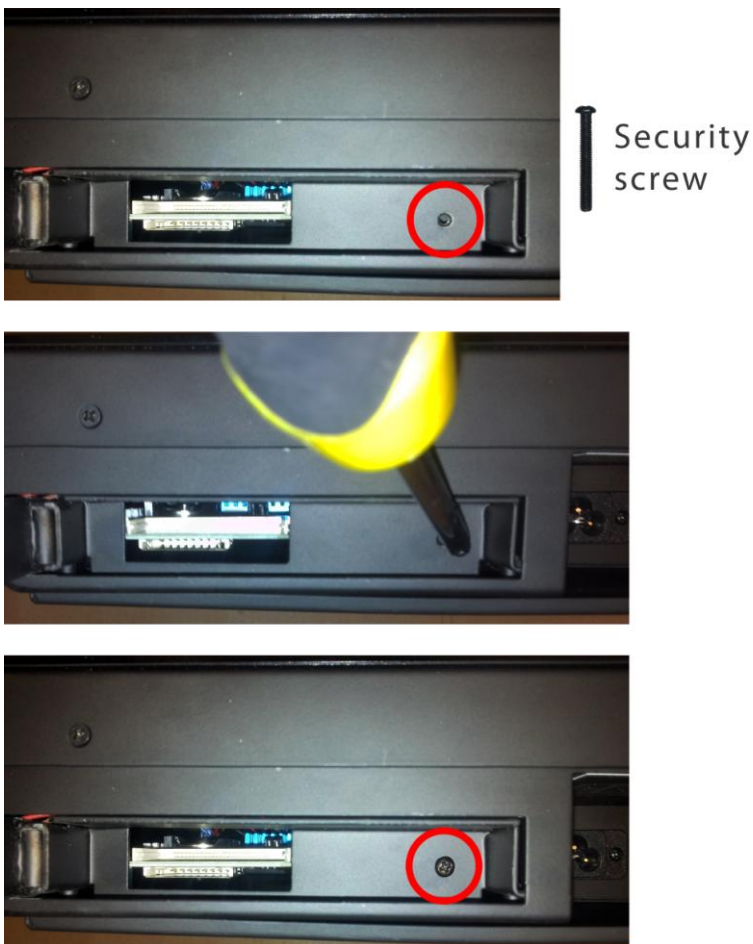

Figure 8 Security screw

3.2 Wall Mounting – Portrait Orientation

1. Empty contents of the box and test the screen's power supply before mounting.
2. Clean the wall and mark out the position of the mounting plate.

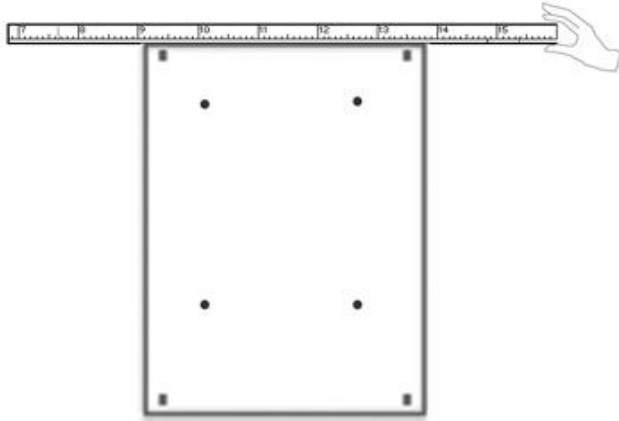

Figure 9 Mark out the mounting plate

3. Mark out the plates hole positions on the wall for drilling (you can drill your own holes in the mounting plate if required).

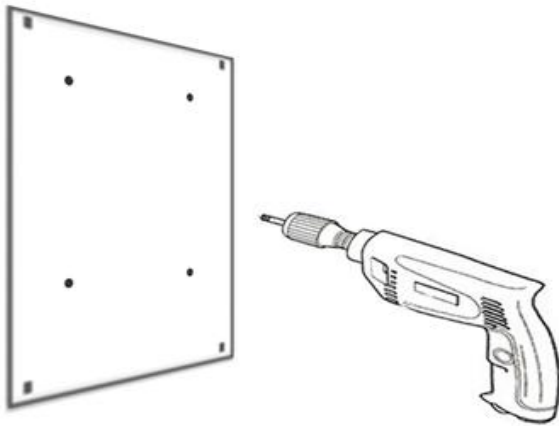

Figure 10 Drill holes

4. Once holes are drilled into the wall insert wall plugs and fix the plate to the wall using additional screws.

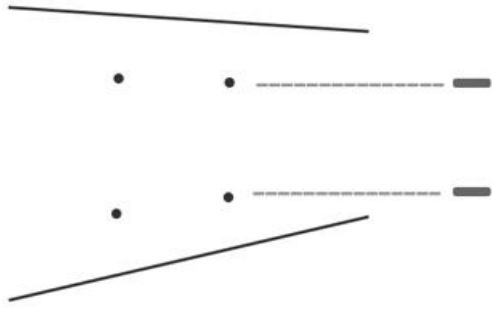

Figure 11 Insert wall plugs

5. Once secured to the wall, hang the display to the bracket by locating the guide holes and sliding right.
6. Connect screen to the mains using the power cable provided.
7. If you are displaying the screen in portrait orientation it is **ESSENTIAL** that you secure the screen to the mounting plate. Do this by fixing the display to the wall bracket using the security screw provided.

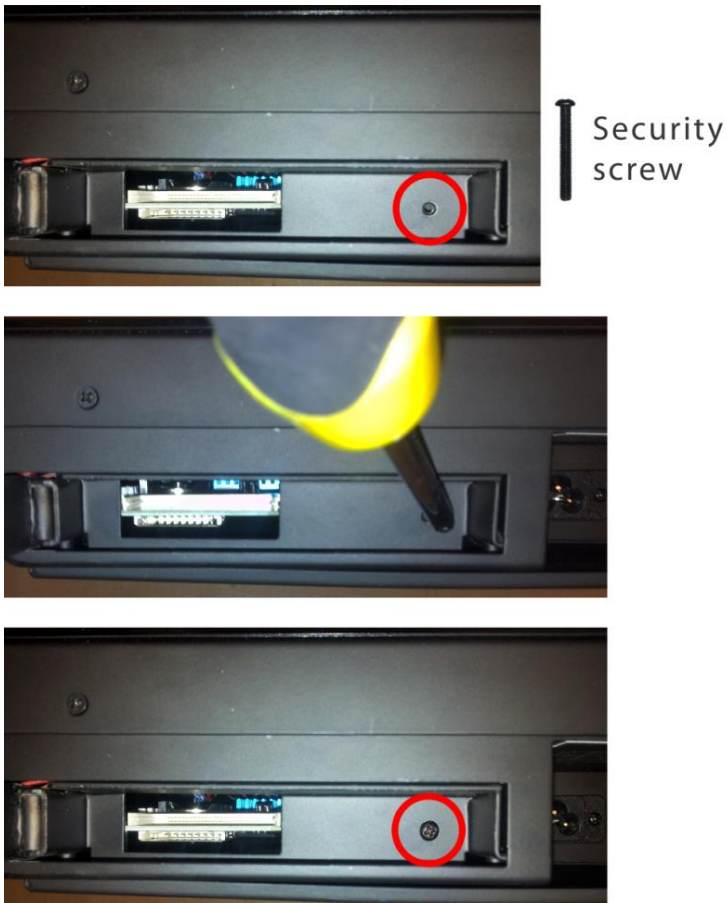

Figure 12 Security screw

4. Advanced Guide

Although this unit can operate without using any additional software, for more advanced applications please copy the Playlist Editor scheduling software (on the CD provided) to your computers' hard drive. The software also allows you to edit existing

4.1 Main Menu

On opening the application you will be greeted by the main menu screen, giving you the options of "Create New Playlist" and "Load Existing Playlist".



4.2 Creating Playlists

Once you have selected "Create New Playlist" the playlist creator will be launched.

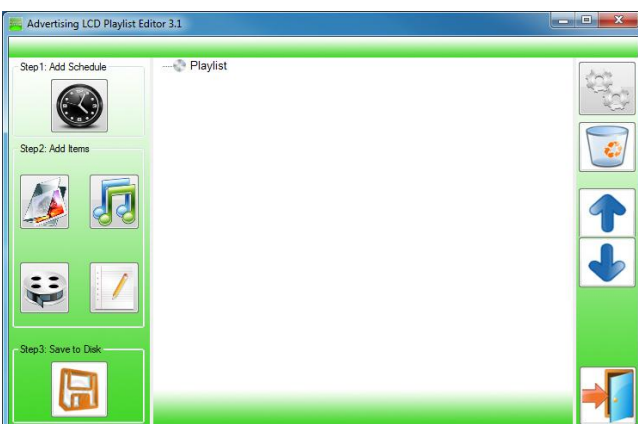

The Playlist Editor is laid out in a user friendly way with the primary functions on the left hand side in easy to follow steps.

4.2.1 Add Schedule

The schedule functions as a timer for the playlists, so you can have between one and eight playlists scheduled to start and end at different times of the day, with up to 50 files in each playlist.

Note: If you enter more than one schedule ensure that the consecutive schedule times do not overlap.

Click on the "Add Schedule" Button

- > Type a Schedule name
- > Select preferred start time
- > Select preferred end time
- > Click "OK"
- > Schedule will appear in the playlist.

To add more schedules simply follow the whole process again for the preferred number of schedules, ensuring you select unique schedule names and times.

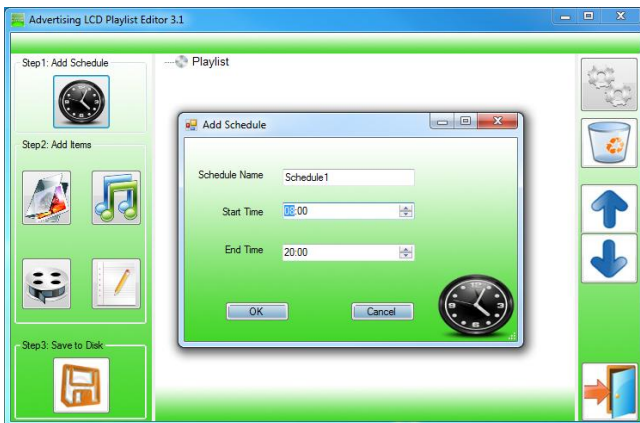

4.2.2 Add Selected Items

Note: For compatible file formats please refer to 2.2 Supported Media Files.

Adding Images

Note: Before adding image files please ensure that it has a file name of 11 characters or less and contain no special characters (!"£\$%^&* etc.) only .

Click the "Add Image" button

- > Select appropriate Schedule
- > Click "Browse" and locate and select files

- > Enter a duration time
- > Select Image switch mode
- > Click "OK"
- > Image appears in Schedule.

You can select multiple image files at once to add to a schedule, you can also move each item up or down in the playlist by using the arrow buttons on the right hand side.

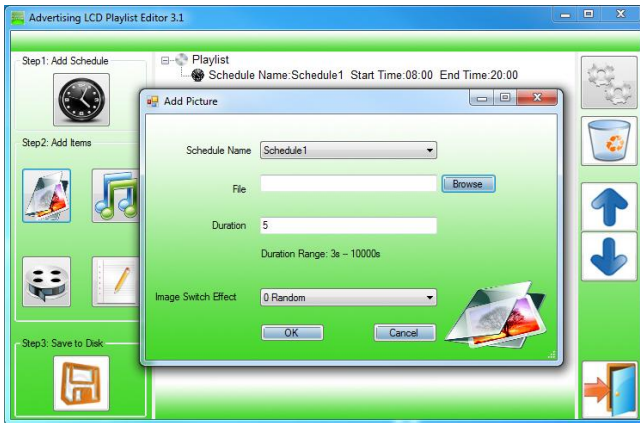

Adding Audio

Note: Before adding audio files please ensure that it has a file name of 11 characters or less and contain no special characters (!"£\$%^&* etc.).

- Click the "Add MP3" button
- > Select Schedule
- > Click "Browse" and select MP3 file
- > Enter volume level
- > Click "OK"
- > MP3 Appears in Schedule.

Note: You must add audio files after all image files.

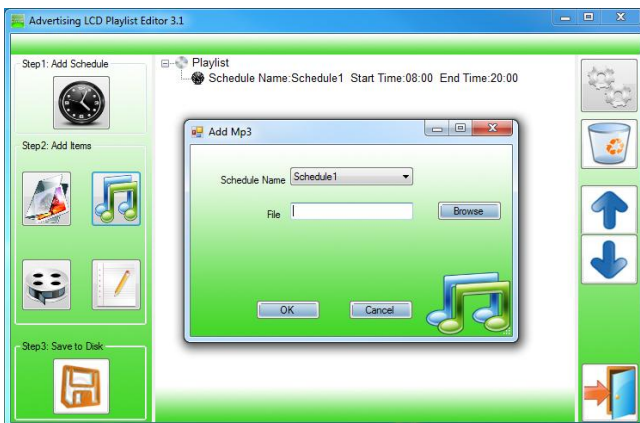

Adding Video

Note: Before adding video files please ensure that it has a file name of 11 characters or less and contain no special characters (!"£\$%^&* etc.).

Click the "Add Video" button

- > Select Schedule
- > Click "Browse" and locate Video file
- > Enter preferred repeat
- > Enter preferred volume
- > Click "OK"
- > Video appears in playlist.

Note: You cannot add Videos and MP3 audio files in the same schedule.

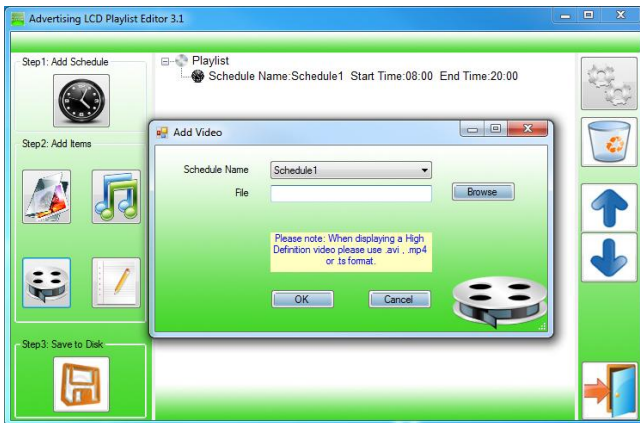

Adding Scrolling Text

Note: you must ensure that the scrolling text function is activated on your display, you can do this by accessing the System Settings of the Main Menu (see 1.5.1 System Settings)

Click the "Add Scroll Message" button

- >Enter the message you would like to run across the bottom of the screen
- Or if you have a pre-existing .txt document containing your message:
 - >Highlight the "Import from file" checkbox and click "Browse"
 - >Locate .txt file and highlight
 - >Click "OK"
 - >Message appears at the bottom of the playlist.

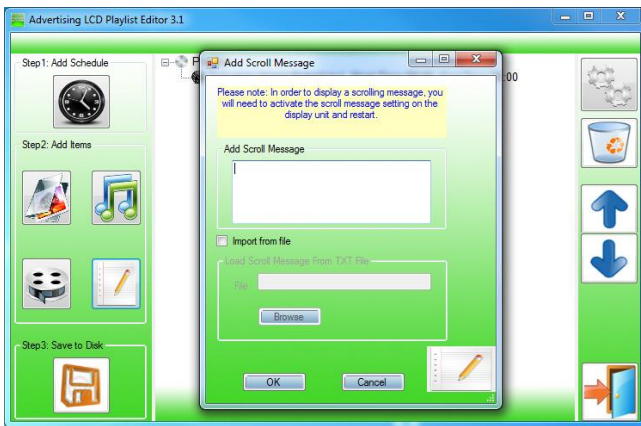

4.2.3 Saving

Note: Before saving please ensure location drive is empty.

Click "Save to Disk"

> Click "Browse" and select the top level of the USB drive as the location of the playlist and files

> Click "Save".

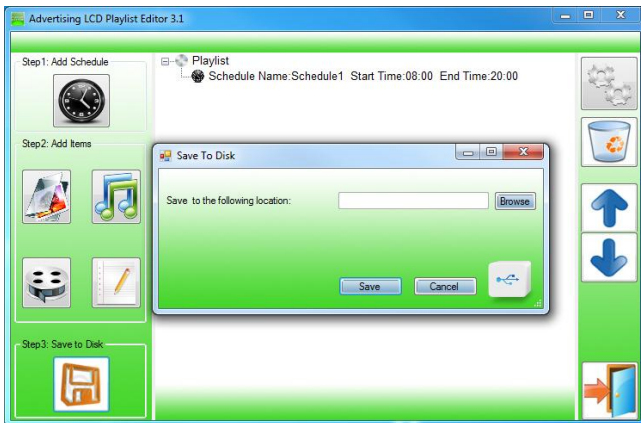

4.3 Editing Playlists

From the main menu click "Load Existing Playlist"

> Locate and select playlist to edit

> Playlist appears in playlist creator

> Select item to edit and click "Edit" button located on the top right hand side of the application.

Note: You can also add items to the playlist and add further schedules.

4.3.1 Deleting Items

To delete items within a playlist, select the item and click "Delete" - located on the right hand side of the application. The item will be removed from the playlist.

5. F.A.Qs and Troubleshooting Guide

5.1 My scrolling text message does not appear on my screen

If you have set up a playlist that includes a scrolling text message it should appear at the bottom of the screen as your media is playing, if it is not, you have not turned this function on. If your media is playing, begin by pressing "STOP" on your remote control to return to the Home Screen. Now press "SETUP" to access the Main Menu, like so:



Highlight System Settings and press "PLAY". Next, navigate to Scrolling Text, press "PLAY" and select ON, like so:

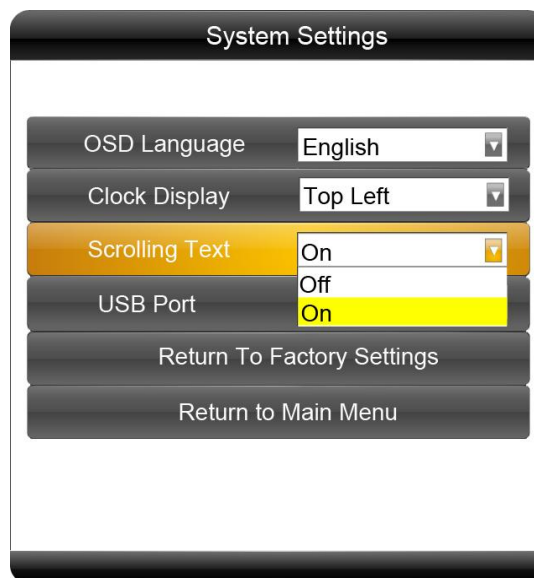

Navigate to Return to Main Menu and press "PLAY". You can now press "PLAY" on the home Screen to display your media – your scrolling text message should now appear.

5.2 How do I play PowerPoint presentations on my display?

5.2.1 Option 1 (for plain slides with no animation):

You can save the PowerPoint presentation as a JPEG File Interchange Format (.JPG). Microsoft PowerPoint software allows the user to do this

- 1) Create or open a PowerPoint presentation.
- 2) Click File > Save As
- 3) Enter a File name
- 4) Click on "Save as type" scroll down and find the file extension "JPEG file interchange format", as shown in the image below.

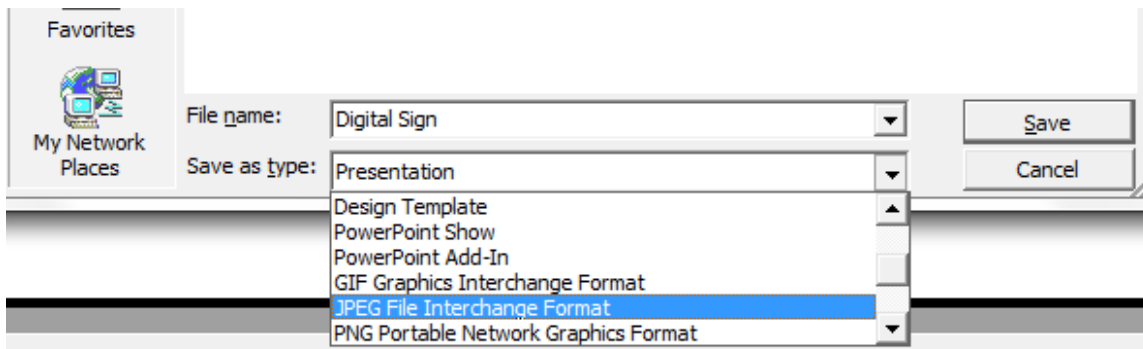

- 5) Click Save.
- 6) A message will appear asking if you would like to save all slides as JPEG's
- 7) Once you have selected your option, The JPEG images will be saved and are ready to use within a playlist or to upload to a storage device.

Note: For the best portrait resolution, you can use this PowerPoint Page Setup: Width 42.6cm; Height 24cm (16:9 Ratio)

5.2.2 Options 2 (for presentations with animation):

You can convert the PowerPoint presentation to a MPEG video clip. For the best display quality you should use the MPEG2 format which gives the best display quality. We suggest that you use the following software:

Software Name: Wondershare PPT2DVD

Web link: <http://www.ppt-to-dvd.com/ppt2dvd/overview.html> :

Select Video Format: PowerPoint to MPEG2 Video Settings:

- TV Standard: NTSC (29.97fps);
- Standard: Standard DVD;

- Aspect Ratio: 16:9 (widescreen);
- Encode Size: Width 720, Height 480.

5.3 Wireless connection

The screen does not have a wireless capability built in. However, with the range of screen inputs available as shown in Figure 44 an external network media player can be easily connected.

5.4 Video Format Conversion

There are two possible tools for converting video

5.4.1 Format Factory

This is a free multipurpose convertor that can be used for normal definition

Standard Definition

1. Download a free convertor (Windows) called Format Factory which can be found at <http://www.formatoz.com/>
2. Start the Software (picture 1).



3. On the left hand window pane select the 'Video' conversion options.
4. Select the 'All to AVI' conversion
5. Click the 'Add File' button and locate the file to be converted.

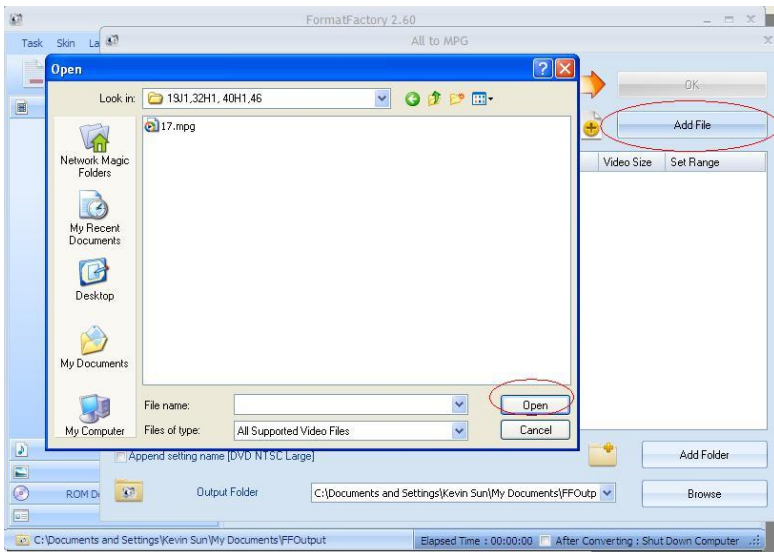

6. Click the 'Output Setting' button and modify it to look like the image shown below. A number of important settings have been highlighted.

7. Select 'OK' to save these changes and then Press 'OK' button to goto main screen

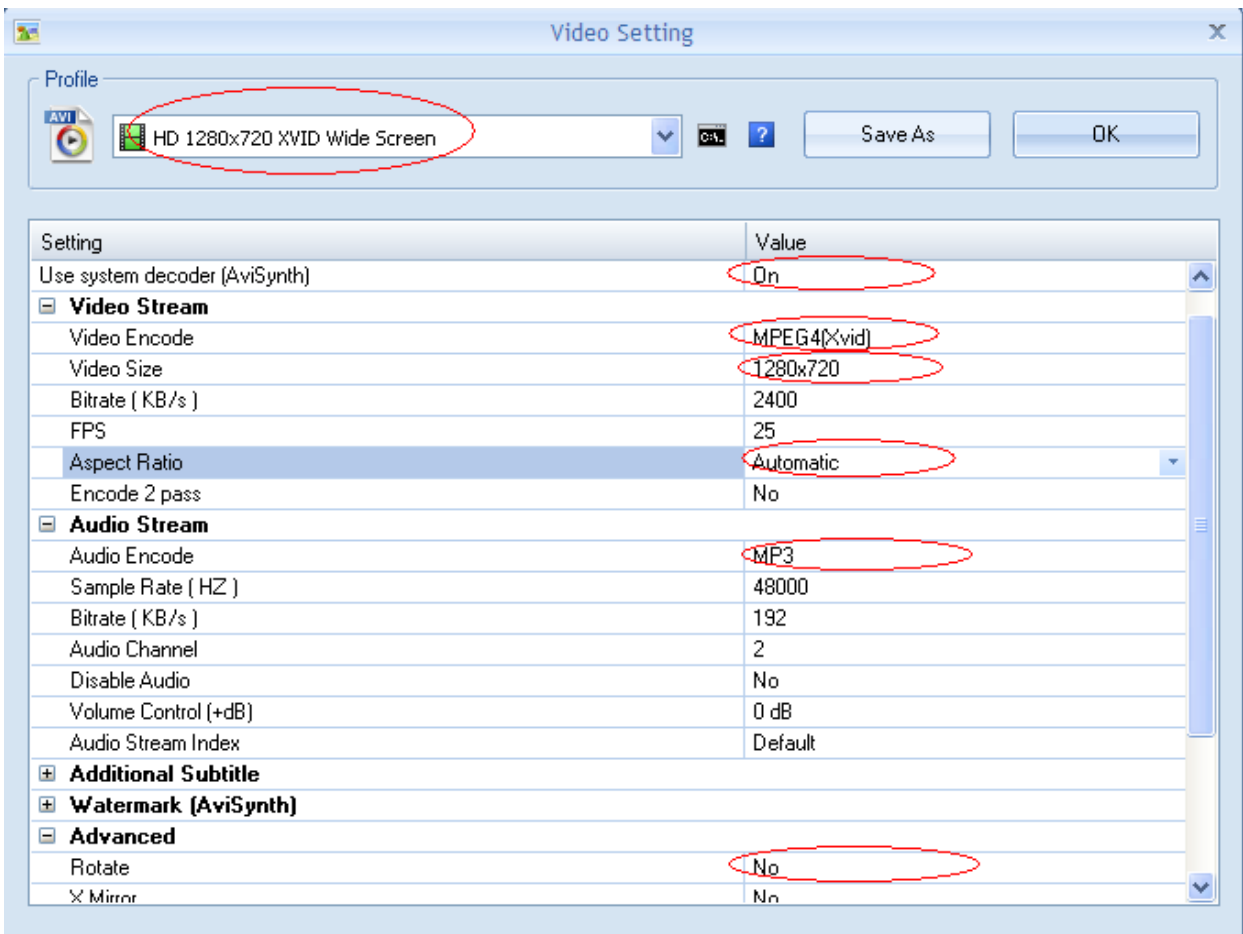

8. Press the 'Start' button along the top to start the conversion. Once completed, press the 'Output Folder' to see the converted video.



5.4.2 HD Video Converter Deluxe

This is only really useful for High Definition videos.

Download link: <http://www.winxdvd.com/hd-video-converter-deluxe/>

This software is not free.

MP4 gives the best display quality. Please follow the following steps:

1. Select "to HD MP4" tab.
2. Change audio quality to 448 kbps, and change video quality to 12000, output image setting to custom size with custom aspect ratio, and video resolution to HD1080P(1920:1080), video codec to MPEG4.

See the screen shot below for the recommend settings.

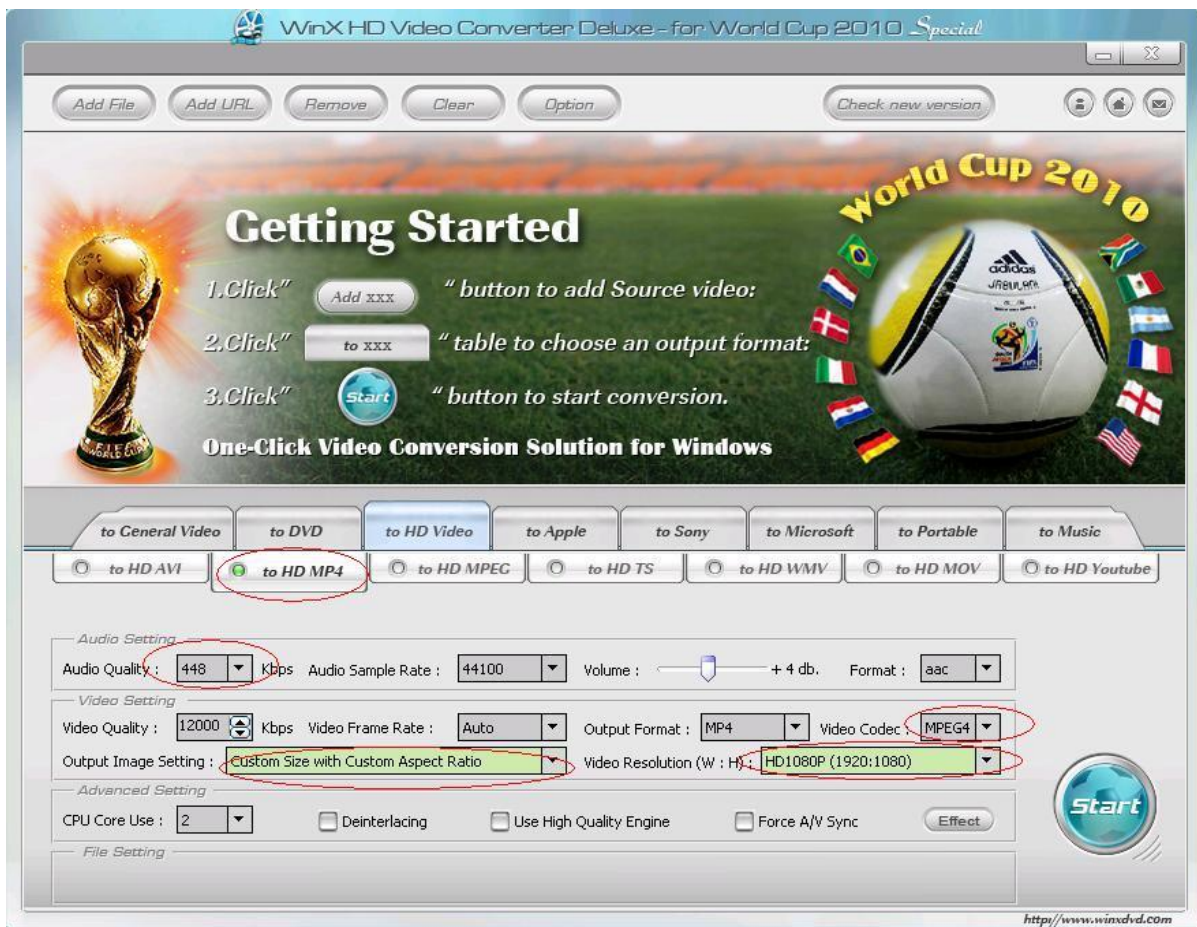

5.5 Connecting screen to PC

If your PC has a HDMI output then this is ideal. Simply connect one end of a HDMI cable to the screens HDMI input (see Figure 4) and the other to your PCs HDMI output port. Using this method will carry both your PCs visual and audio signals. If your PC does not have a HDMI output, connect it to the screen using a VGA cable instead, this carries the video signal. If you wish the audio signal from your PC to be sent to the screen as well, this can be achieved by using a male-to-male 3.5mm audio jack cable. To change the input source of your screen press the SOURCE button located on the top right hand corner of your remote control. Next, navigate to your desired source and press "PLAY" on your remote control.

5.6 My media file does not fit properly on the screen

If your media is being displayed with black edges please refer to section 2.11. This has happened because the file does not have a 16:9 aspect ratio (1920x1080). Please resize file to 1920x1080 pixels and try loading the media onto the display once again.

5.7 My media file will not display or is missing from the playlist

In this situation the first step to take is to start with a blank USB drive. Copy one supported picture file (2.1 Supported Media Files) onto the blank USB drive and insert this into the unit. If this works there are most likely one or more unsupported files or folders on your original playlist.

If this does not work please check first that the media file is the correct size to fit the screen –1920x1080 pixels. If it is any bigger than this it is likely the media file will not display.

Finally make absolutely sure that your media is a supported file type as the screen will not recognise unsupported file types.

5.8 My media files will not update

If you are have problems updating your display follow these steps to ensure it is not a technical issue.

- 1) Ensure that there are no additional unsupported files or folders stored on the USB drive.
- 2) Make sure the USB drive is firmly inserted into USB slot
- 3) Before contacting your supplier try another USB drive to be certain this is not the fault.

5.9 My moving GIF files will not move.

As the screen recognises any .gif file as an image it will display the first frame of a moving gif for the allocated image display time.

5.10 My screen is stuck on the “Copy Complete” message.

If your screen is displaying the following after you have removed your USB drive you will need to turn it off and back on at the mains or press the reset button.

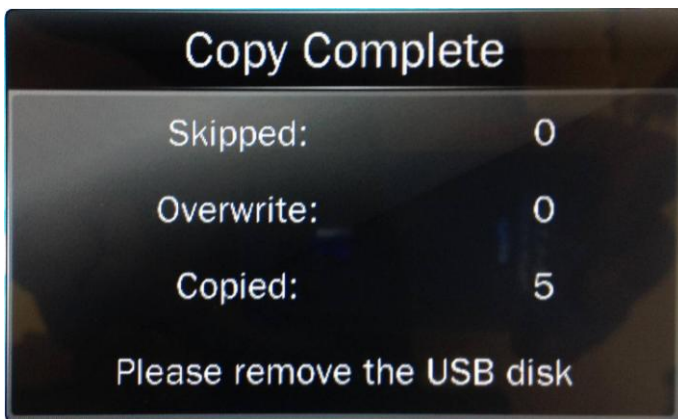

Once you have done this your media should now play in a loop. To stop this from happening in the future first press "STOP" to return to the home screen. Next, press "SETUP" to bring up the Main Menu. Access the System Settings and navigate to USB Port. Change this to "ON" and return to main menu. This should prevent this issue from happening again.