

# User's Manual

## Contents

1. General Warnings	1
2. Safety Warnings	2
3. Names of Components	8
4. Proper Operation	9
5. Advantages of the Product	29
6. Checkpoints before Making Repair Work Order	31
7. Specifications	32

This User's Manual can be modified without prior notification for product quality improvement purposes.



# User's Manual

## 1 General Warnings



This instruction booklet is considered an integral part of the product and must be delivered to the user together with the appliance.

It must follow the appliance also in every passage of property.

Store the booklet in a safe place and read it carefully before using the appliance as it contains important information to ensure safe installation, operation and maintenance.

This appliance must be installed following the National and the Local law and standard in force.

Installation and maintenance must be performed according to National and Local standard in force and according to the manufacturer's instruction and by qualified personnel skilled in the specific sector as foreseen by the law.

Incorrect installation can cause damage or physical injury and the manufacturer declines all liability for failure to observe instruction and standards.

In particular maintenance must be performed by qualified personnel. In this case, an Authorized Manufacturer Service Centre represents a guarantee of professional and qualified services.

The appliance must be used according to the applications as specified in the design.



Any other use has to be considered improper and therefore hazardous.

The manufacturer declines all contractual or not-contractual responsibility for damages caused by incorrect installation and incorrect operation and failure to observe the relative instructions.

## 2 Safety Warnings

 The cautions issued by this user's manual include critical information for the safety while using the product. When the user fails to adhere to the following requirements can cause death, serious damages, and a great property loss.

 For safety, according to the level of danger, we have indicated by '**Danger**', '**Warning**', '**Caution**' and the definitions for these terms are as follows :

 <b>Danger</b>	When the required terms are not followed, it indicates an urgent danger that may cause death or serious bodily injury.
 <b>Warning</b>	When the required terms are not followed, it indicates latent danger that may cause death or serious bodily injury.
 <b>Caution</b>	When the required terms are not followed, it indicates latent danger that may cause light injury or semi-serious injuries.
<b>Caution</b>	When the required terms are not followed, it indicates it may cause property damage, product malfunction or performance reduction.

1) The definitions of the symbols indicated on the product and user's manual are as follows :

 This symbol indicates "Caution" for bodily injury under particular conditions.

 This symbol indicates "Stop" for possible bodily injury or property damage.

 This symbol indicates a "Must" follow sign.

2) Since the specified warnings and cautions in the user's manual are not all inclusive cautions when using the product, more care is necessary for safety when using the product.

 Please read and understand this user's manual completely for safe use of this product.

 When disposing of the product, it must be done through the installer.



## Danger

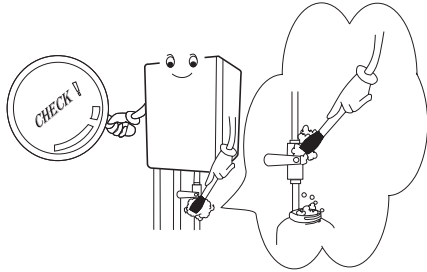

Please check for gas leaks often.

- In case of gas leakage leading to an explosion that can cause serious bodily injury or property damages.

## Warning

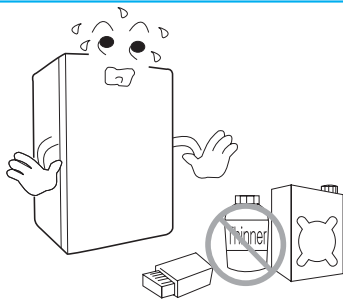

Do not place any flammable items or materials near the boiler.

- If there are any flammable materials such as gasoline, they may cause an explosion or fire.

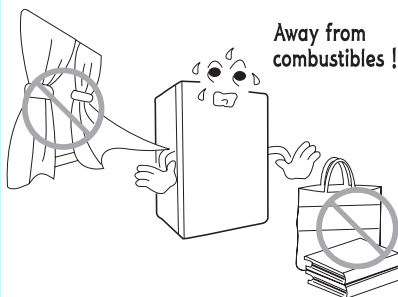

Do not leave any combustibles near the boiler.

- If there are any combustible materials such as plastic near the boiler, they may cause a fire.

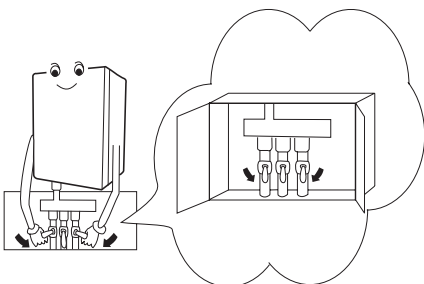

When the boiler is operating, open at least one valve of the distributor.

- When operating the boiler with the distributor valve closed, there is a possibility for fire and damages to the boiler due to overheating.





## Warning

Check the type of Gas used!

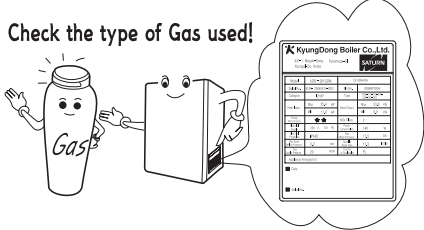

Please use after checking the type of gas used.

- When gas other than the gas type specified on the lower portion of the right side of the boiler, a fire or explosion may occur due to improper combustion.

Close the door!

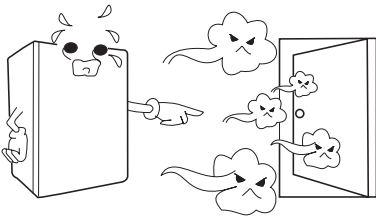

Please close all the doors leading to the inside of the house from the boiler room when using the boiler.

- If the exhaust fumes leaks into the house, carbon monoxide (CO) may cause poisoning (suffocation).

It's Hot!

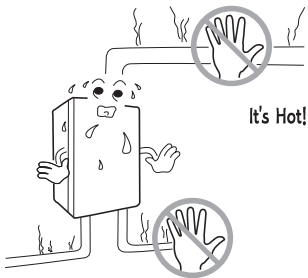

Please do not touch the flue or pipe while the boiler is turned on and operating.

- While operating, the flue or pipe are extremely hot and can cause burns.

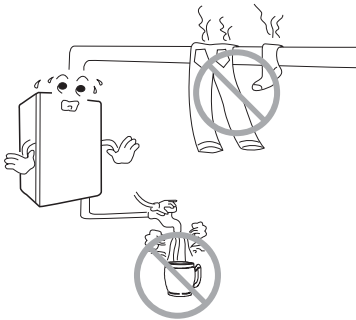

Please do not use the boiler for any other purpose than for heating and hot water.

- If used for drying laundry, a fire may occur.
- If used for cooking, some harm to the person may occur.

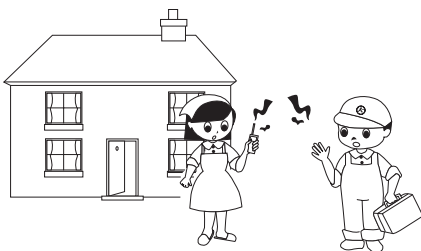

Please request for any gas pipe repair at the Gas pipe professional installers.

- Any such repair by non-accredited gas pipes installer can cause gas leakage and accidents.



## Warning

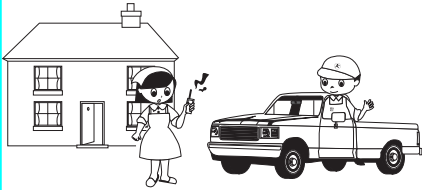

Please inquire about product installation, transfer, and additional Repair to the dealerships where you purchased the product.

- Improper installation of gas boiler may cause an accident.

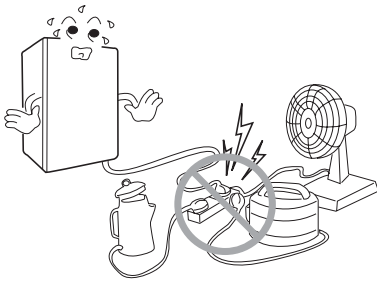

Please use the outlet exclusively for the boiler.

- Using the multiple electrical appliances in a single outlet may cause a fire.

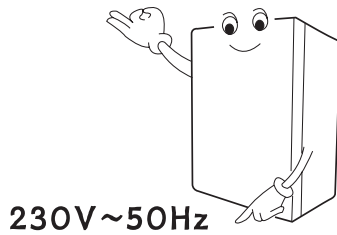

Please check the power source before use.

- The power source for the boiler should be 230V~50Hz. Higher or lower power supply may cause a fire, boiler function reduction and shorten its use life.

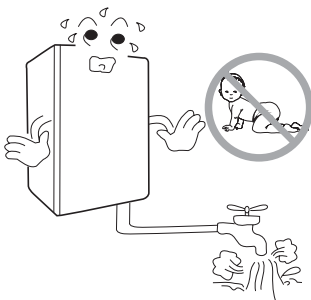

Please use caution when utilizing the hot water.

- When using the hot water, water at a high temperature may flow suddenly depending on the opening of the valve. Thus, use care not to burn yourself when utilizing hot water.



When using a propane gas container, please fix the container in a dry and cool place located outside with good ventilation.

- An explosion may occur.



## Warning

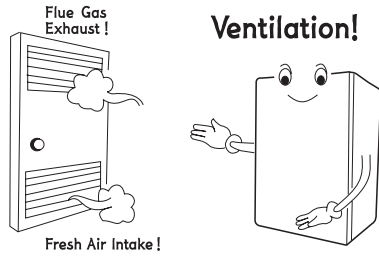

When the boiler takes air from the place where is installed, be sure that the opening ventilation are open.

- Any malfunction in the ventilation may cause improper combustion that may lead to Carbon Monoxide (CO) gas poisoning, a fire, or shorten product use life.

## Caution

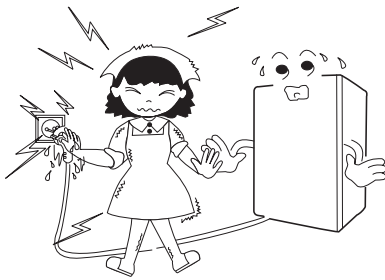

Please do not use water or wet cloth to clean the boiler.

- This may cause an electric shock.

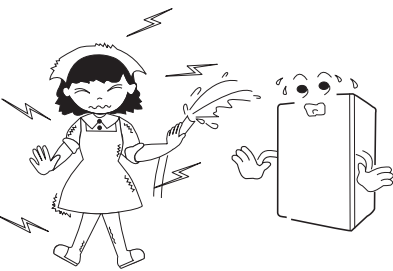

Please do not operate the boiler with wet hands.

- This may cause an electric shock.

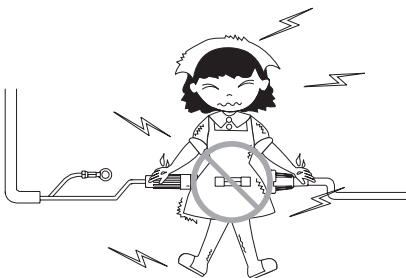

When the fuse is broken, do not replace the fuse on your own.

- This may cause an electric shock.
- Please request a service repair.







## Caution

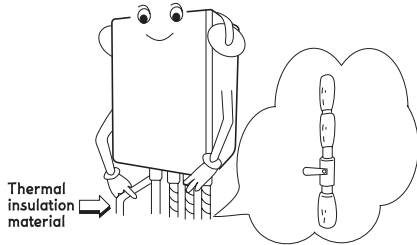

Please insulate the exposed pipes.

- Not covering the exposed pipes with insulation material will cause damages to the pipes due to freezing.

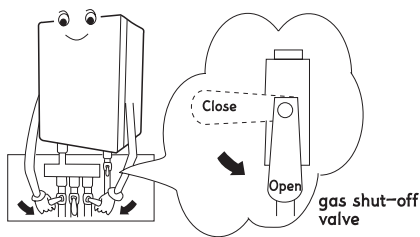

Please leave open distributor valve and gas shut-off valve when not at home for two to three days during the winter.

- For freeze guard, boiler must be left on. If the boiler distributor valve and gas shut-off valve are closed then the boiler will not operate properly to cause freezing leading to damages to boiler and pipes.

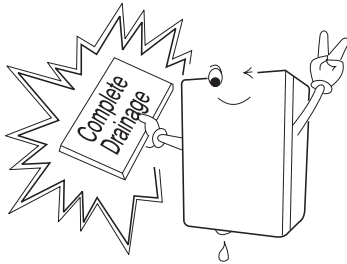

Please completely drain the water from the pipes when not in use for a prolonged period.

- Pipes may freeze when not in use for a prolonged period. (Draining Method Refer to Page 15)

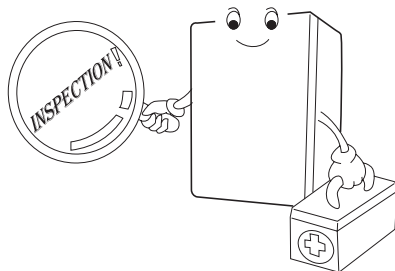

Please submit a request for inspection of your unit at least once a year.

- Please receive A/S regular inspection at least once a year from the dealer where you purchased the unit for safe and lengthened use of your boiler.

## Recommended items

- Please place the unit in a location where there is sufficient space for regular inspection and repair.
- For repair and inspection, there should be at least 600mm of space in front of the unit.



Please should be prepare water discharge hole (Device) at boiler installation.





# 3 Names of Components

KDB - 181/201/251/301 KCA

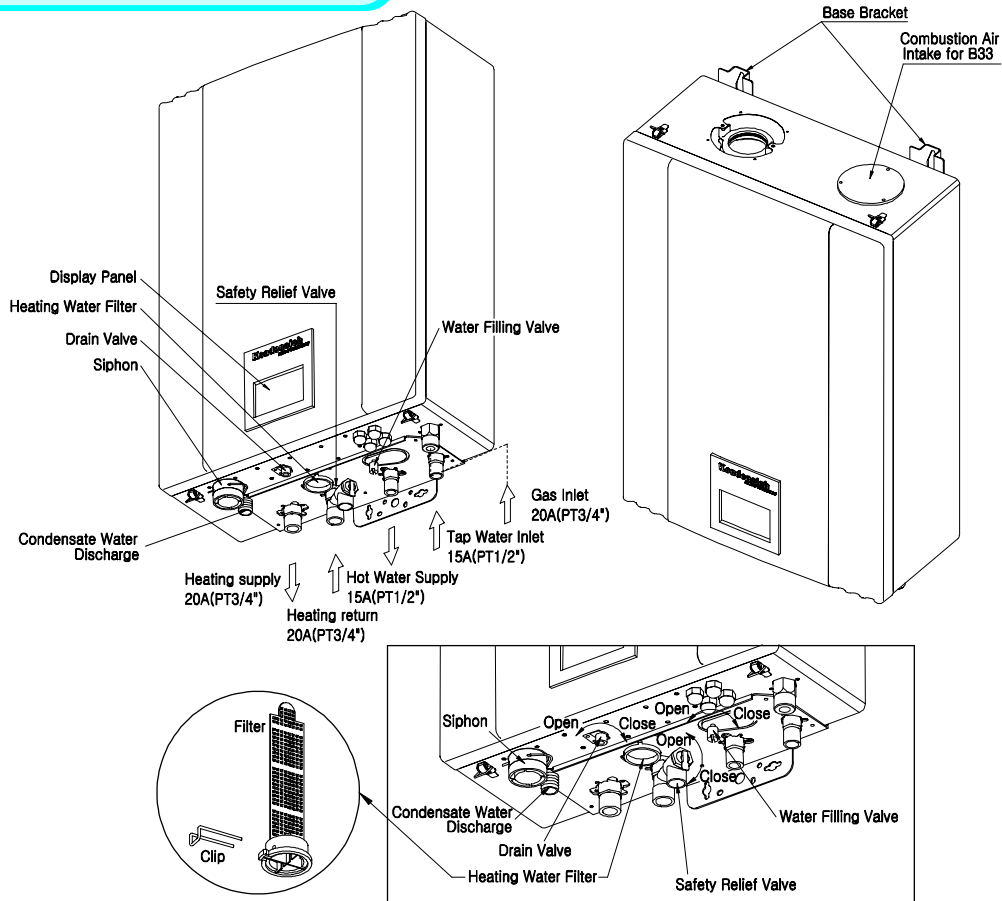

User's Manual

- Pressure Gauge : Indicates the pressure inside the heating pipes. In case the pressure falls below 49kPa (0.5kgf/cm<sup>2</sup>), open the water replenishing valve to automatically refill the water to 49~147kPa (0.5~1.5kgf/cm<sup>2</sup>).
- Water Drain : For a vacation or not at home for a prolonged period of time, to guard against freezing, the water is excreted through this part.
- Pressure Relief Valve : When there is excessive pressure inside the heating pipes, it automatically excretes the water inside the boiler to maintain optimal pressure level. In case of long absence from home, to guard against freezing, the water inside the boiler should be drained.
- Heating Water Filter (Strainer) : Improve the heating function by removing the contaminants inside the heating pipes using an inside filter. When heating is not done properly, remove the clip and clean the filter. (see page 24)





# 4 Proper Operation

## Before operation

### 1 Check the gas type

When using the unit for the first time or moved, check whether the type of gas specified in the product and the supplied gas match. (LPG/LNG/Natural Gas)  
 (The type of gas is indicated on the rating plate located on the lower right portion of the boiler.)

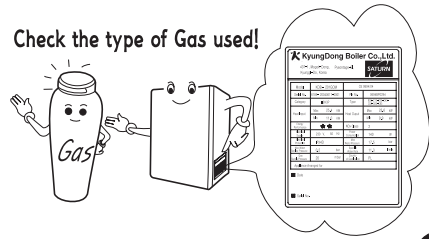

### 2 Check for power supply

Please check whether the boiler is electrically filled properly.

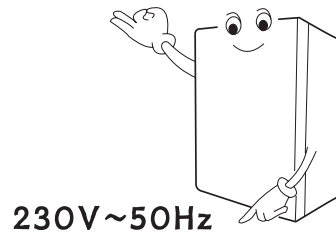

### 3 Check the water supply valve

Please leave the boiler water supply valve in the open position all times of functioning; for water replenishing (up to the boiler will reach around 1,0bar in the pressure gauge) and for domestic hot water production.

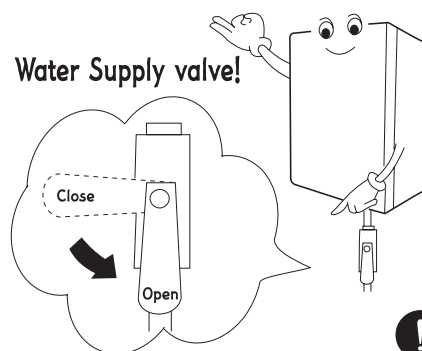



#### 4 Check the gas valve

Please check to make sure the Gas shut-off valve connected to the boiler is open.

##### Gas shut-off Valve

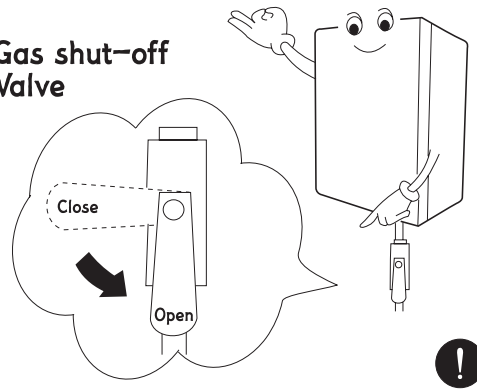

#### 5 Check each room valve connection

Please check to make sure each room valve connected to the boiler is open.

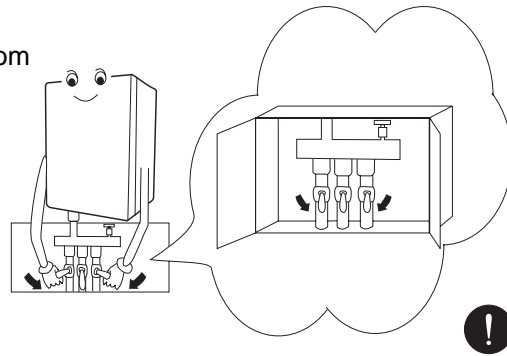

#### 6 Check the area around the boiler room

Please remove any combustible or flammable materials and do not place any wet laundry over the exhaust pipe. This may cause a fire.

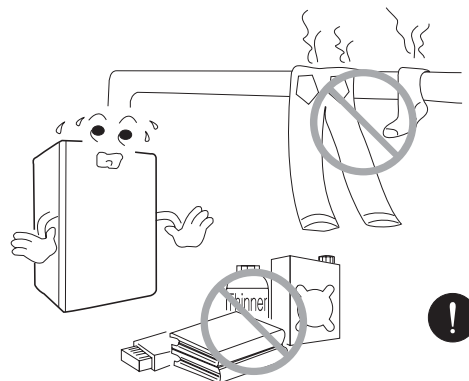

## When in Use

### ! Warning

- Do not use the unit for any other purposes than for hot water and heating.
- Please inspect the unit after completing a repair or exchange of the gas pipes and gas controller before operating the unit.

### 1 Caution for Gas Leaks

Please check for gas leak on the gas connection portion frequently with soapy water. (if any bubbles form then there is a gas leak contact the nearest gas supplier immediately.)

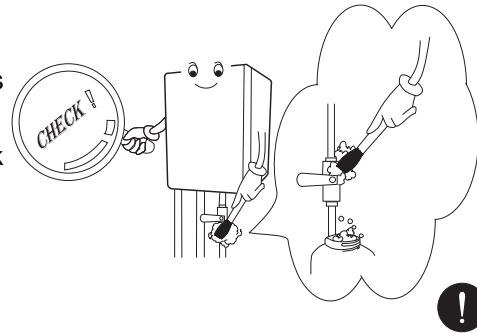

### 2 Caution for Ventilation

- Please make sure there is sufficient inflow and outflow of air for ventilation when using the unit. (supply vent, ventilation open)
- If the ventilation is improper then the combustion condition deteriorates inside the boiler and it may cause shortened use life of the boiler. Also, seepage of exhaust gas into the house may cause Carbon Monoxide Poisoning.

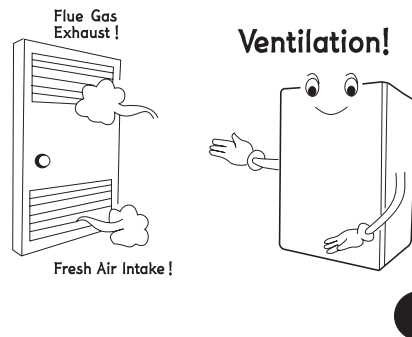

### 3 Burn Warning

While operating, please be careful not to burn yourself on the flue or pipes since they are extremely hot.

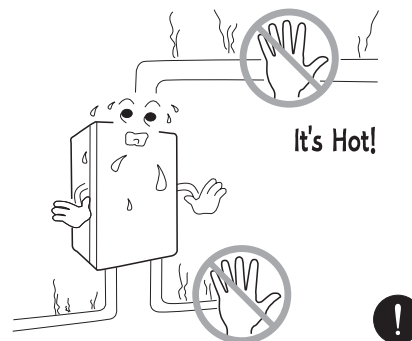



#### 4 Combustibles and flammable material Warning

Please do not store combustibles or flammable material such as gasoline near the boiler. This may cause a fire.

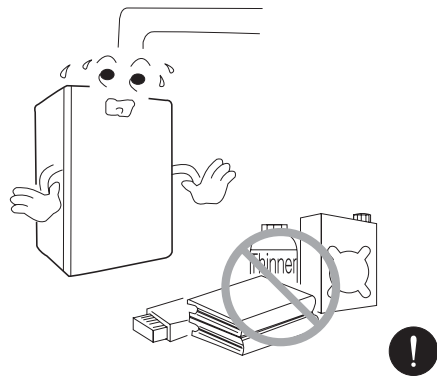

### Cautions to Prevent Freezing during the Winter Months

Exposed pipes must be insulated.

Please insulate the exposed pipes. It is safer to protect the pipes exposed to outside elements with insulation material. Particularly, water supply pipe and hot water pipes must be insulated.

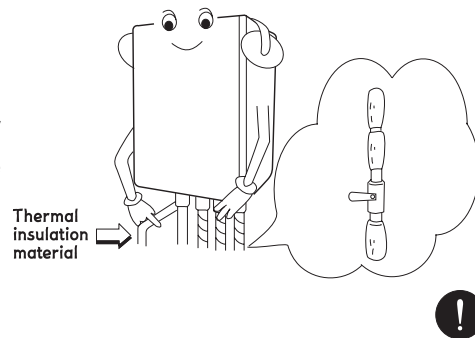



**When not using the unit for short-term (2~3 days)**



Please leave open the distributor valve and Gas shut-off valve even when not using the unit for 2~3 days during the winter.

Please leave switched-on the boiler and open the shut-off gas valve when you leave home for 2~3 days of outing to facilitate freezing guard device for effective and convenient operation.

At that time, do not switched-off the boiler from the power supply by the main switch upstream the unit.

Also, to prevent any damages to boiler and pipes, leave at least one distributor valve.

**Gas shut-off Valve**

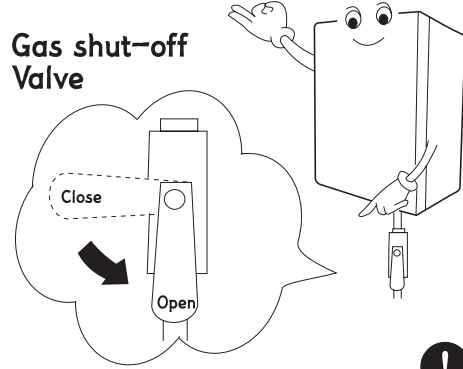

**1 Check water supply valve**

Please check whether the water supply valve connected to the boiler is open.

**Water Supply valve!**

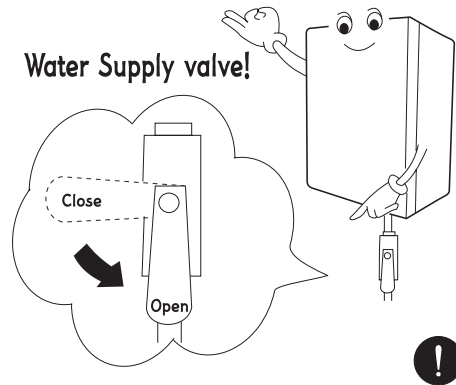



## 2 Check the Gas shut-off valve

Please check whether the Gas shut-off valve connected to the boiler is open.

### Gas shut-off Valve

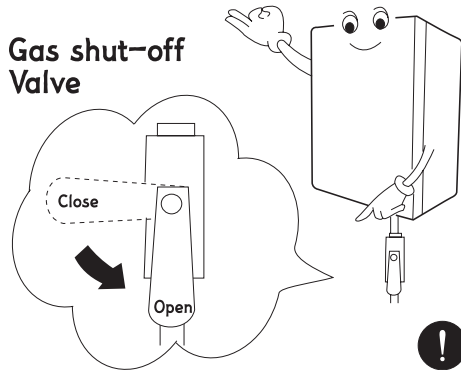

## 3 Check each room valve connection

Please check whether each room valve connected to the boiler is open.

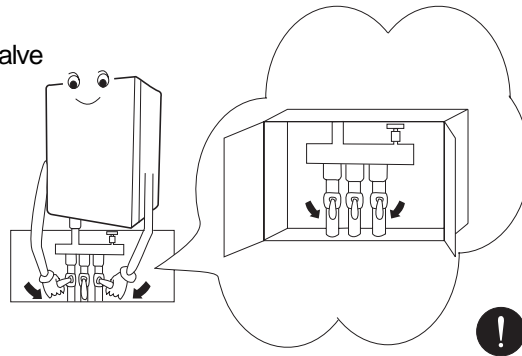

## Long - Term Non - Use (Water Draining Method)

### 1 Switch-off the main switch upstream the boiler

Please switch-off the master switch upstream the boiler.

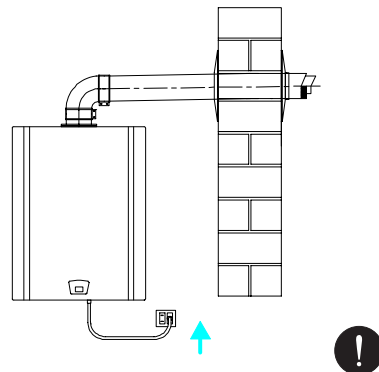



## 2 Shut-off the Gas Supply

Please close the Gas shut-off valve.

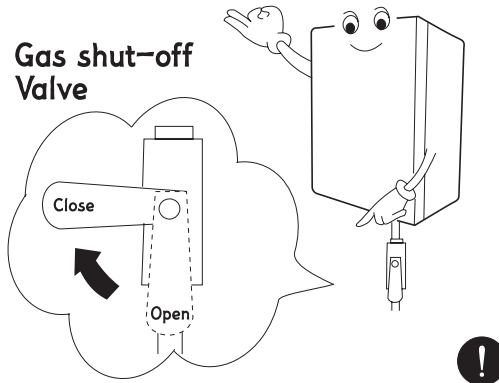

## 3 Shut-off the Water Supply

Please close the water supply valve.

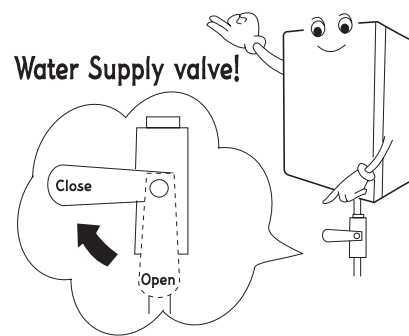

## 4 Exhaust of heating water and hot water

- Open the pressure relief valve (close air type) and drain valve on the bottom of the boiler with a screwdriver to drain the heating water from the boiler.
- Open all the distributor valves in the room to drain all the water.
- Please open the hot water valve to drain the hot water from hot water pipes.
- Please empty the condensate water in the siphon.(But, when you re-start the boiler, you should be filling the water in the siphon.)

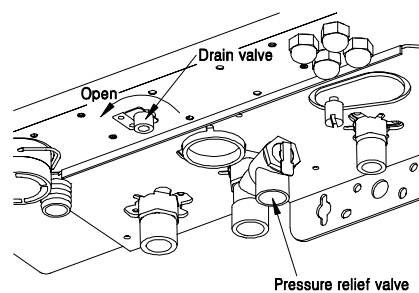



## How to maintain the Unit

### 1 Shut-off the power supply

Please unplug the unit from the wall power supply.

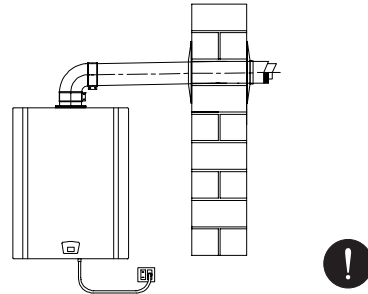

### 2 Shut-off the gas supply

Please close the gas shut-off valve.

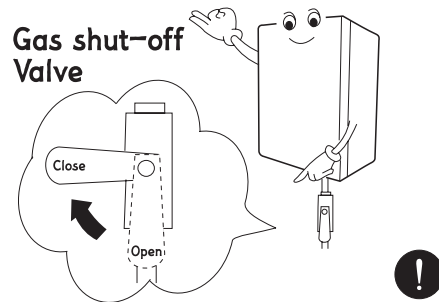

### 3 Please keep the outside of the boiler unit clean.

About 1 hour after unplugging the unit, please clean the unit with dry cloth.

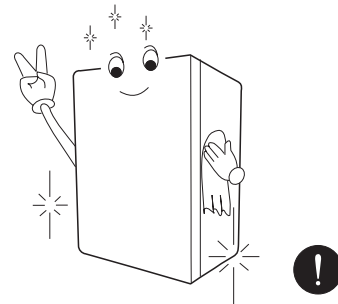

### 4 When there are contaminants on the unit

If the rooms are not as hot as the other times, this indicates there are contaminants present inside the pipes. Please clean the heating filter.(cleaning method : heating filter cleaning method see page 24)

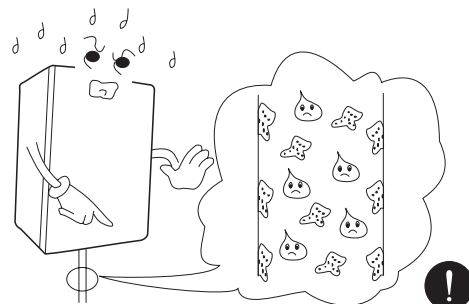



## How to use the thermostat

### Proper use of the thermostat

1. There are two methods of heating. First is the setting of the heating water temperature in the boiler. After the adjusting of the heating water temperature in to the boiler. It detects automatically that the temperature in the installation stay ad set value. It is necessary to set the temperature at 60~70 during spring and fall and 70~80 during the winter. Be careful ; because some country doesn't permit to use this method. But impose to use the room thermostat. Please follows the National and the Local law and standard in force.
2. By monitoring the indoor temperature to heat the house, Install a room thermostat and set it to the desired temperature. The temperature in the house will the stay at the value set in the room thermostat. The temperature in the installation will stay at the value set in the boiler. It is necessary to set the temperature at 60~70 during spring and fall and 70~80 during the winter.
3. By monitoring the indoor temperature and the outdoor temperature. Install the external sensor to the house and the room thermostat. The temperature in the house will stay at the value set in the room thermostat. The temperature in the installation will stay at the value automatically adjusted by the boiler. This value will be high with a low external temperature; will be low with a high external temperature. If it's necessary, this relation between the temperature of the installation and the external temperature may be adjusted in relationship to the particular kind of heating system and of the insulation of the house. This adjustment may be done by the authorized service man. Please look at the paragraph in the "installation manual".



KyungDong Gas Boiler

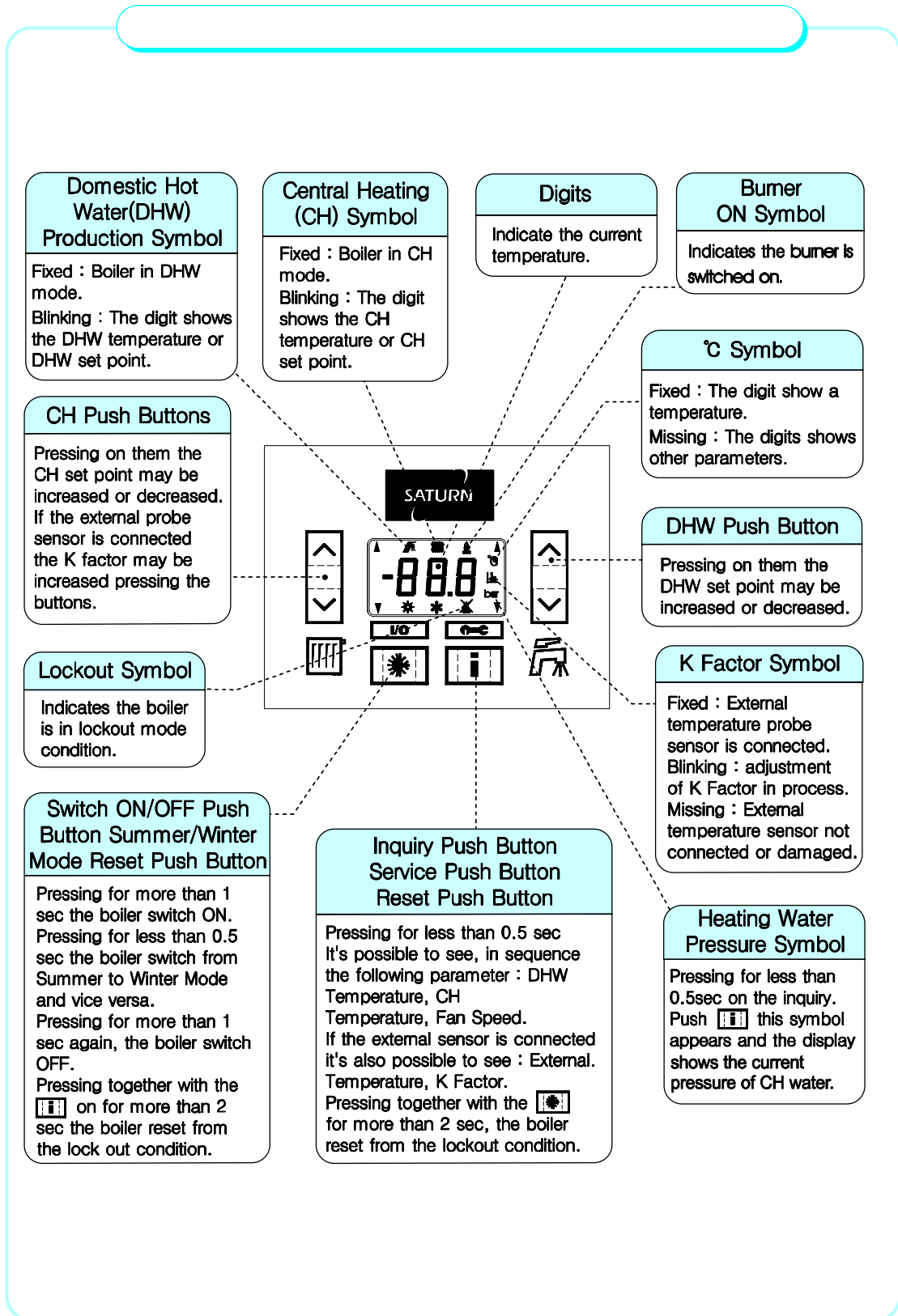

User's Manual







## Start – Switching-on of the boiler

### 1 Switch-on the main switch upstream the boiler

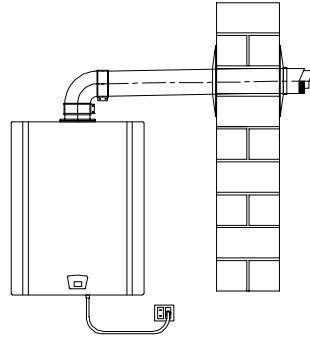
Please switch-on the master switch upstream the boiler. On the display it appears "OFF".



### 2 Switch-on the boiler

Pressing  for more than 1second it's possible to change the working mode of the boiler from OFF to ON and vice versa.

When the working mode is OFF the display shows OFF.

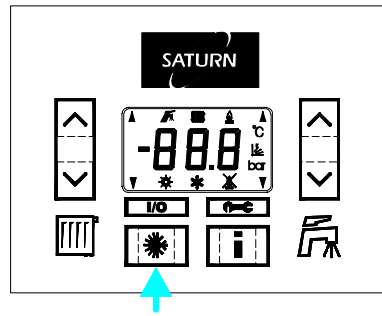

### 3 Choice of the working mode ; "Summer" or "Winter"

When the boiler is in ON position, pressing  for less than 0,5second, it is possible to set the boiler in the "Summer" or in the "Winter" working mode.



It is possible to check the existing working mode looking to the display.

In Summer position it appear the symbol .

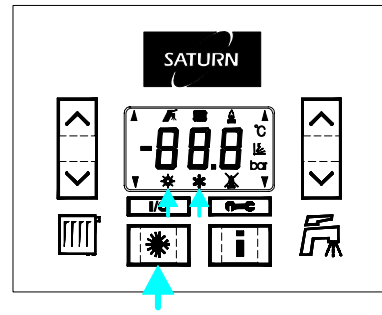
In Winter position it appears the symbol .



## 4 Water central heating (CH) adjustment

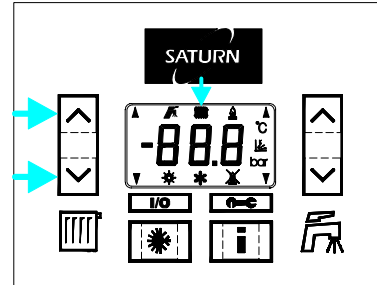

When the boiler is in heating mode the symbol  on the display is always visible. Every time it's possible to adjust the heating temperature from 40 to 80 . Pushing on the  and the  button in the left side it's possible to increase or decrease the setting temperature of the boiler and to check the value set looking to the number on the display.

The value set, will be automatically memorized. During the operation the symbol  blinks on the display.



## 5 Domestic Hot Water(DHW) adjustment

When the boiler is in DHW production mode the symbol  on the display is always visible.

Every time it's possible to change the DHW production temperature from 35 to 60 . Pushing on the  and the  button in the right side it's possible to increase or decrease the setting temperature and check the value set looking to the number on the display.

The value set, will be automatically memorized. During the operation the symbol  blinks on the display.

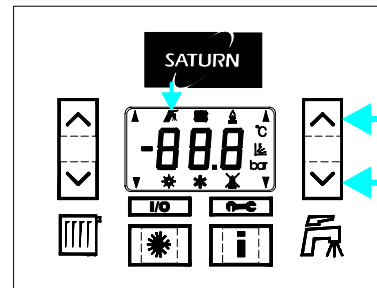

## 6 Operation

Depending on the selected heating water temperature, boiler will operate and when using the hot water, if you open the hot water tap, the heating will convert to the hot water.



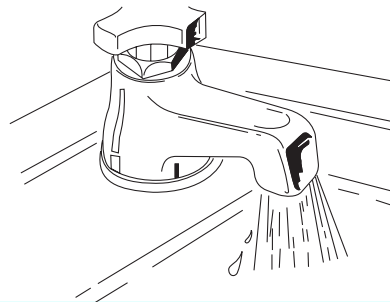

When you stop using hot water, it will automatically revert to heating mode.



## 7 Inquiry

Every time it's possible to check which are the value set in the boiler.

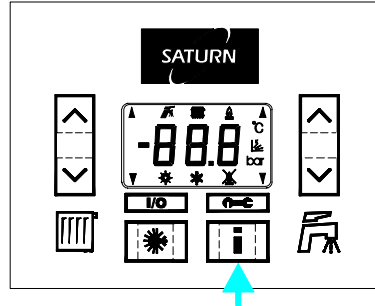

Pushing on  for less than 0,5 seconds it's possible to see on the display (digit), in sequence, the following parameters;

- 1 Heating water pressure (the symbol  appears)
  - 2 DHW temperature (the symbol  and °C appears)
  - 3 CH temperature (the symbol  and °C appears)
  - 4\* External temperature (the symbol  and °C appears)
  - 5\* K factor (the symbol  appears)
  - 6 Fan speed (the fan speed expressed in rpm divided per 100 appears)
  - 7 Tension falling under the limit during lasting 24 hours (only if it occurred)
  - 8 Return to the regular visualization
- \* The external temperature and the K factors appear only if the external probe is installed.



## 8 Reset from lockout

When the boiler falls in a lockout condition the symbol  appears on the display.

Pressing ,  all together for more than 2 seconds it's possible reset the normal functions of the boiler.

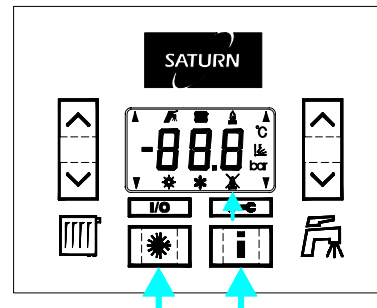

## 9 Antifreeze function

If the temperature detected by the primary temperature probe falls down under 6 °C, the burner switch on (at the minimum capacity) and the pump is activated up to the boiler reaches 35 °C.

The function is activated also with the boiler in the OFF mode.

If the boiler is in a lockout condition, only the pump is activated.

### Be careful

The complete antifreeze function is active only if the master switch upstream the boiler is switched-on and if the gas shut-off valve is open.



## 10 Heating Mode with Outside Temperature Control (OTC) – K Factor



The OTC function is enabled if the external sensor is connected.

In this case the  symbol is lighted on the display. In case of external temperature probe damaged, the symbol is disappears, and the boiler work in CH mode without OTC function included.

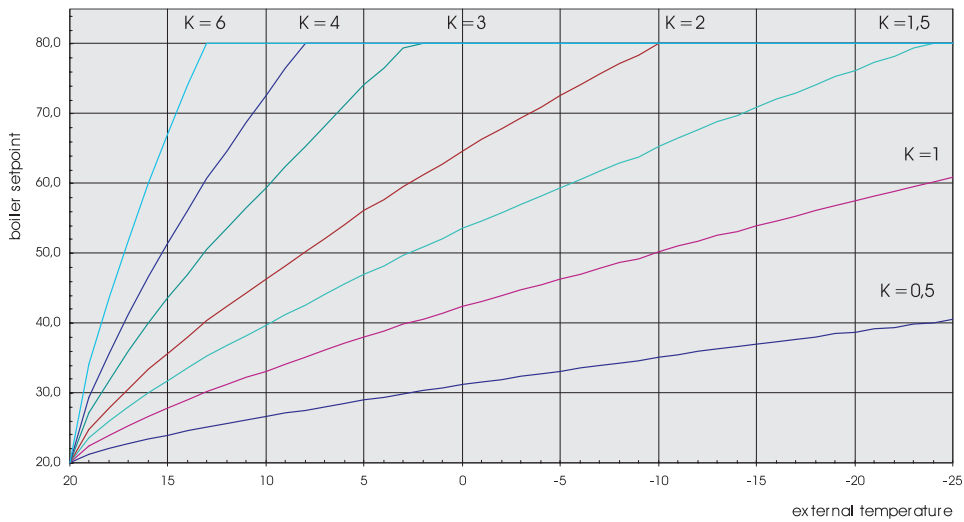
Working with OTC function is the same behaviour of CH mode, the difference that the primary temperature is automatically calculated in relation to the external temperature sensed by the external sensor and to the “K” factor set, as shown in the following graph. In case of overcoming of the minimum set point (40 or 30 , according to the heating range set) or maximum allowable CH set point (80 or 50 ), the boiler set point is limited to the CH set point.



The “K” factor is set as follow;

- Pushing on the  and the  button in the left side it's possible to increase or decrease the K factor who relate the maximum heating temperature to the external temperature. During this operation the  symbol blinks on the display and the display show the set temperature relate to the K factor chosen (from 0,5 to 6,0).

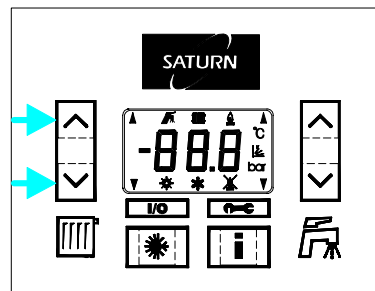





## Heating Filter Cleaning

When the rooms are not as well heated as before, this may indicate that there are contaminants inside the pipes to require heating filter cleaning.

**1 Stop Power Supply**  
Please switch-off the master switch of the boiler.

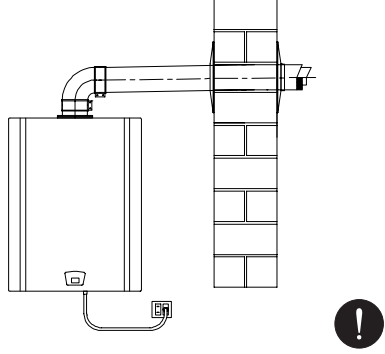

**2 Stop Gas Supply**  
Please close the gas shut-off valve.

**Gas shut-off Valve**

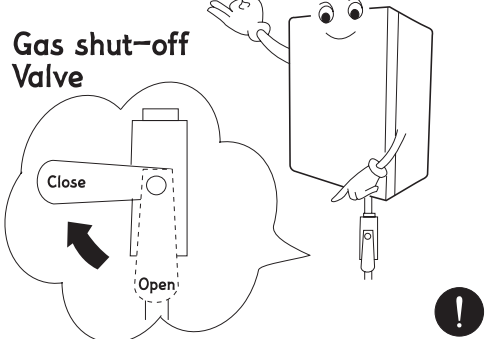

**3 Stop Water Supply**  
Please close the water supply valve.

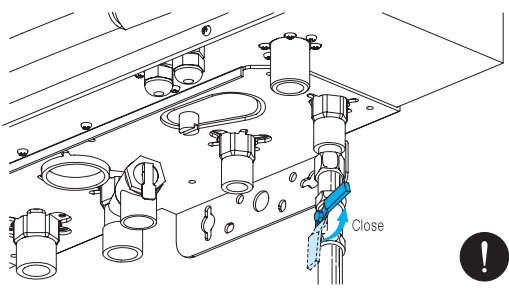



#### 4 Detach Heating Filter

After removing the fixing clip of the heating filter, please detach the heating filter from the unit.



#### WARNING

When detaching the heating filter, be careful not to burn yourself since there may be hot water seepage. (When it is difficult to do this by the customer, please contact your local boiler dealer.)

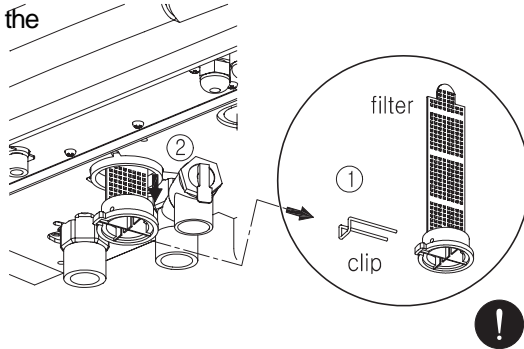

#### 5 Heating filter cleaning

Please clean the heating filter.

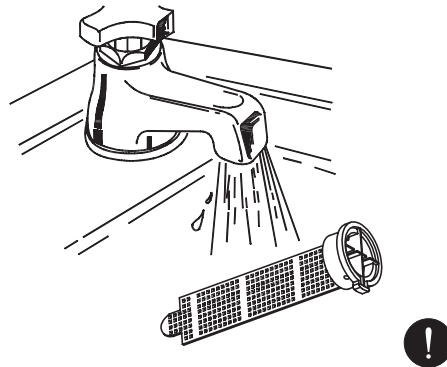

#### 6 Reattach the heating filter

After reattaching the heating filter, fix the filter with the clip.

Order 1 : reinsert the heating filter.

Order 2 : attach the clip to the heating filter.

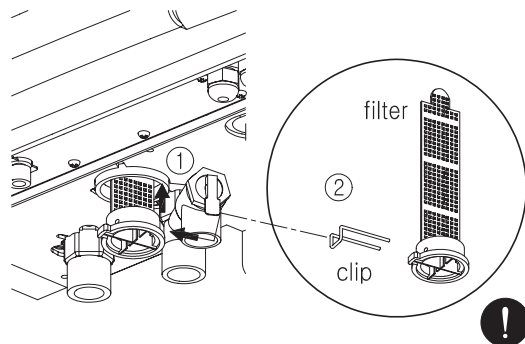

KyungDong Gas Boiler



### 7 Water supply

Please open the water supply valve.

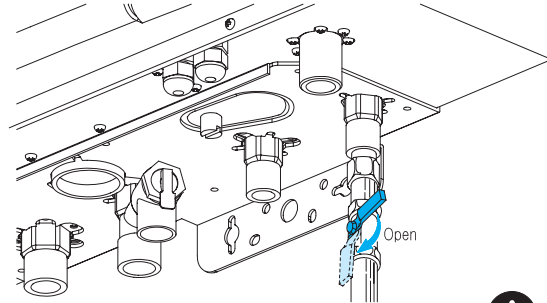

### 8 Power Supply Connection

Please switch-on the main switch upstream the boiler.

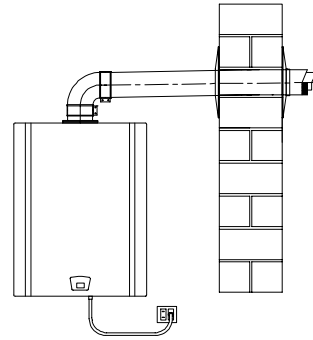

### 9 Gas Supply

Please open the gas shut-off valve.

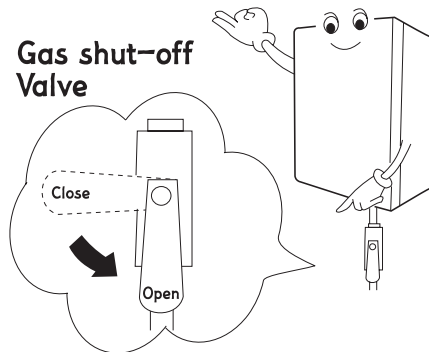

# KyungDong Gas Boiler

## How to Refill the Water

Periodically check the pressure gauge of the boiler.

In order to check the heating water pressure, please press the button on the control panel.

The number 1 appear in the left digit and the inside pressure appear in the 2 right digits.

The pressure of the heating system has to be included between 0,5 ~ 1,5 bar (0,5 ~ 1,5 kgf/cm<sup>2</sup>).

If the pressure is lower than 0,5 bar, error code E10 appear on the display. In this case, please proceed as follow ;

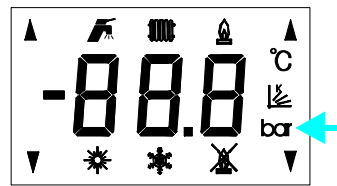
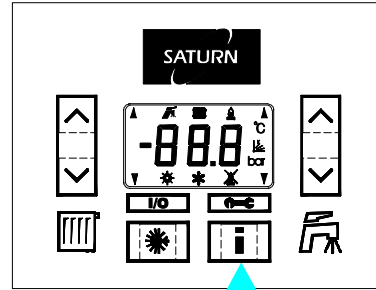

## Bottom Structure

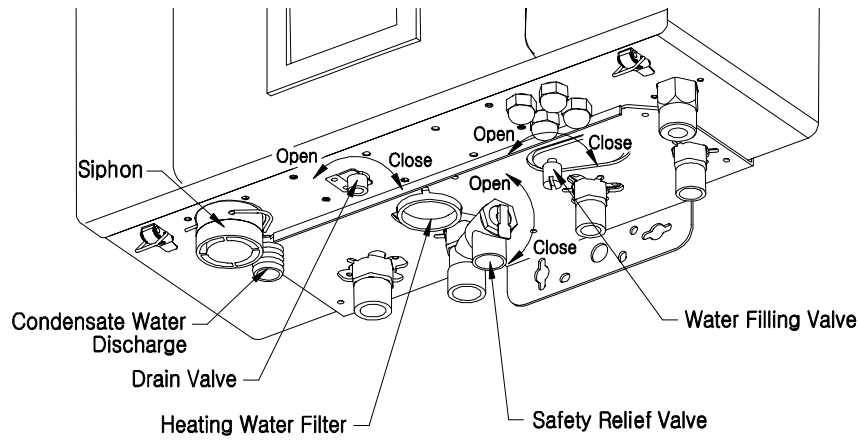

**1** Please close the gas shut - off valve.

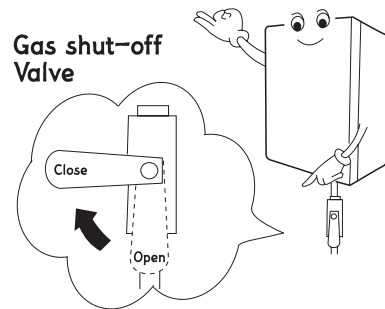



2 Open all the distributor valve.

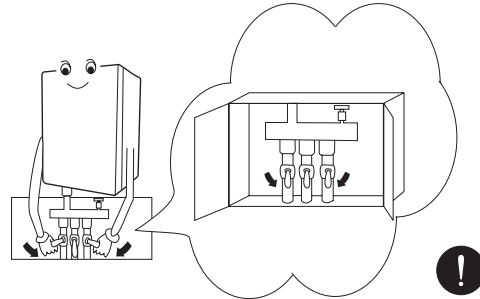

3 Open the water filling valve located on the bottom of the installed boiler by turning it to the left.

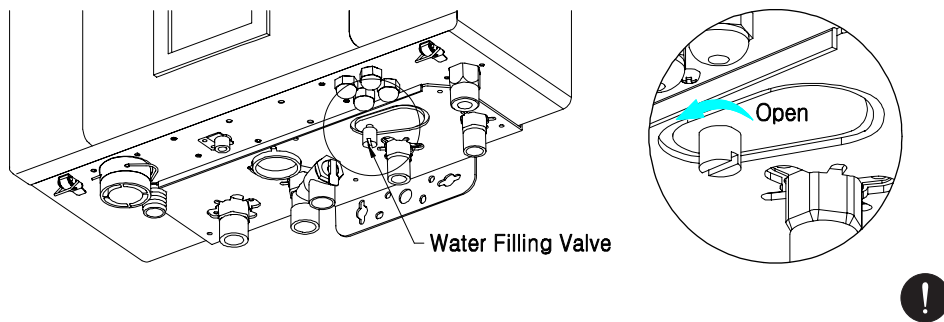

4 When the check lamp on the thermostat turns off and "02" on the temperature indicator window disappears and only the temperature is shown, close the water filling valve by turning it to the right.

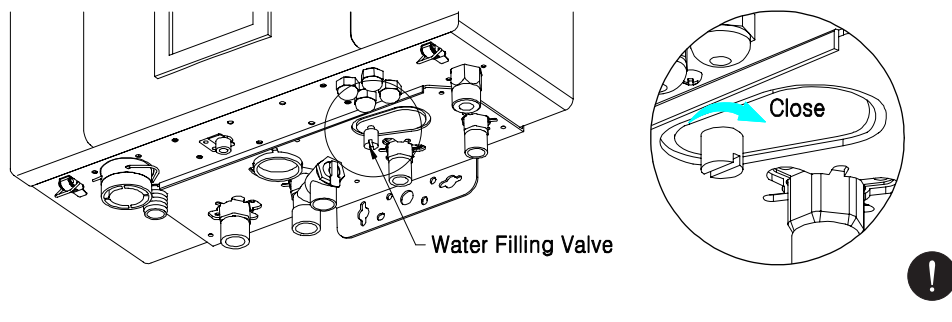



## 5 Open the gas shut-off valve.

- After the air is automatically released from the boiler and the pipes by the automatic air-vent, you may see insufficient water indicated again. Then please refill the water by following the above steps.
- Close the room valves to the rooms that do not need heating.

Gas shut-off Valve

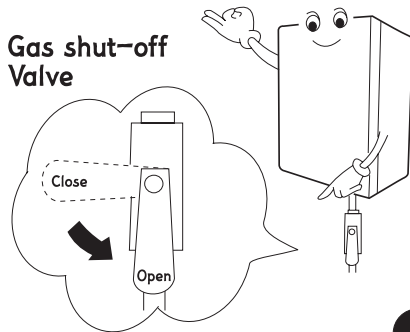

## Gas Leak Prevention

If you think that there is a gas leak, immediately stop using the unit.

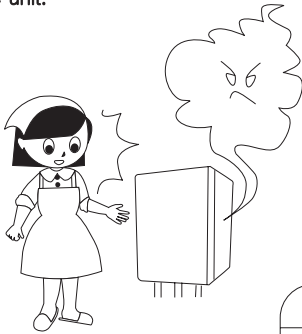

After closing the gas shut-off valve

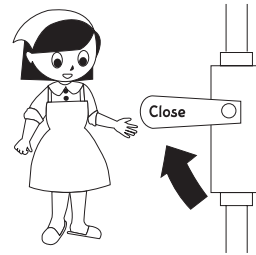

### Warning

Do not use a lighter or match and do not touch the ventilator fan or switch.  
Do not use any electricity and even if you're not using any electricity, there is a possibility of a spark simultaneously with the operation to cause an explosion.

Please contact a your gas supplier as soon as possible.



Open the window for ventilation.

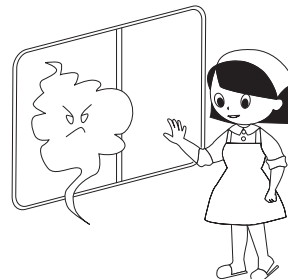

## 5

## Advantages of the Product

## Pleasantness and Saving Operation

With current ratio control method, it maintains the optimal heating conditions. It provides more than enough hot water at a constant temperature and since there is a separate heat exchange device, it saves gas.

## Multi - Function

**1. Indoor Temperature Control Function**

There is a possibility to contact room thermostat that can adjust the indoor temperature with ease and convenience.

**2. Re-ignition Function**

When the fire is extinguished due to harsh winds or due to low gas pressure, it automatically re-ignites the fire for convenience.

**3. Electronic Indicator Device**

On the display placed on the front panel of the boiler, you can check the operation conditions visually (heating, hot water, normal operation) conveniently.

**4. Continuous Discharge Automatic Ignition Method**

Direct ignition method without a pilot burner to reduce costs for gas and it is convenient since it achieves ignition automatically if you press the  button (POWER) button.

**5. Combustion Safety Device**

When you push the power button, if there is no combustion or there is no gas, the flame detector turns on automatically to suspend the unit operation.

**6. Air Safety Device**

It detects any malfunction in the fan, and automatically blocks fumes due to excessive or pressure and when the exhaust pipes are blocked.

**7. Power Outage Safety Device**

In case of a power outage, it automatically suppresses gas and stops combustion.

**8. Air -Ratio Controller**

The air ratio is monitored, adjusted and controlled prior to and during each operating cycle and will automatically adjust the combustion rate. The air-ratio controller prevents unsafe operating conditions and also senses excessive gusts of wind in the flue system.

**9. Condensing Models**

These fully condensing units are engineered to recover and convert the normally wasted heat from the discharge flue gasses to supply additional hot water.

**10. By reducing pressure & flow limit device, you can use pleasant domestic hot water.**

## Safety Device

### 1. Burner Safety Device (Flame Detector)

When the flame is extinguished and the boiler does not restart due to automatic suppression and blowing suppression, the gas route can be automatically blocked.

### 2. Safety Device in case of Re-supply

After power outage during operation, if the power is re-supply, automatic normal operation can be achieved.

### 3. Safety device in case of non-ignition (Flame Detector)

In case of flame is not ignited or ignition is not initiated, it automatically blocks the gas supply route.

### 4. Safety Device for Re-ignition (Explosive Ignition Guard Device)

By using the air ratio control, it can be ignited at an optimal condition without a hitch.

### 5. Overheating Guard Device

If the burner or the heat exchanger overheats then it automatically blocks the gas supply route.

### 6. Fuel Overheating Guard Device

If the exhaust overheat, then it automatically blocks the gas supply route.

### 7. Useless Flame Safety Device (Minimum water level safety device)

It always detects whether there is any water inside the heating pipes, if there is no water in the heating pipes then the boiler does not operate.

### 8. Thermostat Safety Device

If there is any malfunction due to some problem in the thermostat, the combustion stops and the gas supply route is automatically blocked.

### 9. Low Temperature Freezing Guard Device

When the temperature falls suddenly during the cold

winter months around the boiler, boiler will automatically start operation to prevent freezing and even when there is no gas, the circulation pump will automatically start.(Except, when there is any insufficiency in the exposure and insulation of the heating ducts and hot water pipes, the pipes may be damaged by freezing or ice.)

### 10. Gas pressure Control Device(Gas Control Valve)

Even when the gas pressure increases that are supplied to the boiler, it can adjust the pressure at a constant level.

### 11. Shortage Safety Device

In case of any short-circuiting inside the unit, fuse will shorten in order to block the gas route automatically.

### 12. Blower Malfunction Automatic Detection Device

By detecting the number of turns inside the blower (fan) to maintain optimal conditions at all times and if any problems, the operation will be suspended.

### 13. Boiling Guard Safety Device

In case of boiling due to boiler overheating, it will automatically suspend the unit.

### 14. Circulation Pump Stick Guard Device

In order to prevent any sticking of the circulation pump, the circulation pump will operate for 30 seconds for every 24 hours.

### 15. Three Way Valve Stick Guard Device

In order to prevent any sticking of the three way valve, it will operate for 10 seconds every 24 hours.

### 16. Exhaust Duct Blockage Safety Device

In case of any blockage of the exhaust duct, the operation will automatically be suspended.





## 6 Checkpoints before Making Repair Work Order

- In case of any malfunction, before calling an A/S center or dealer for repairs, please check the following items.
- In the display show some error code number, after treating each of the status, restart the unit. (plug the unit again and a minute after the inspection occurs, you must press restart in order to start the unit.
- When the unit fails to restart then please contact the nearest service center.

Condition		Cause	Countermeasure
Boiler doesn't start	• No symbol and Digits appear on the display	• Fuse is out.	• Please call for inspection.
		• Power is out.	• Please wait until electricity comes back on.
	• Heating temperature is indicated but the boiler is not working	• Bad power connection unplugged.	• Please call for inspection.
		• Bad display connection.	• Please call for inspection.
• Display shows error code E10	• Boiler temperature setting is low.	• Increase the boiler temperature setting.	
	• No water in the heating ducts.	• Please replenish the heating water.	
• Display shows error code E02	• Water supply valve malfunction.	• Please call for inspection.	
	• No water supply.	• Please call for inspection.	
• After starting, flame doesn't start and stops, the display show error code E03 and the symbol  appear on the display	• Circulation pump doesn't function.	• Please call for inspection.	
	• Supply gas pressure is low or supply is not adequate.	• Please call for inspection.	
	• Improper flame detection.	• Please call for inspection.	
	• Gas shut-off valve is closed.	• Please open the Gas shut-off valve.	
• Ignition is not done and fan continuous to operate.	• Improper ignition spark.	• Please call for inspection.	
	• Supply pipes are not installed correctly.	• Please call for inspection.	
• Boiler is operating normally, but heating is not done properly.	• Chimney is blocked.	• Please call for inspection.	
	• Heating pipe valve is closed or pipes are blocked.	• Please clean the heating filter. (see page 24) • Open the heating pipe valve.	
	• There is too much air inside of the heating pipes.	• Open the air release valve inside the distributor to remove all the air then close the valve.	
	• Circulation pump is sticking that it does not operate.	• Please call for inspection.	
• Boiler is operating normally, but hot water is not available.	• Heating pipe is leaking.	• Please call for inspection.	
	• Water pressure is low.	• Please call for pressurizer device installation.	
• Boiler pressure keeps falling.	• Three-way valve is malfunctioning.	• Please call for inspection.	
	• There is a leak in the pipes.	• Please call for inspection.	
• During the ignition and combustion, there is a large noise.	• Supply pipes are not installed correctly.	• Please call for inspection.	
	• Supply pipes are blocked.	• Please call for inspection.	
• When using hot water, hot water is not available.	• Hot water line is blocked.	• Please call for inspection.	
	• Hot water flow switch is malfunctioning.	• Please call for inspection.	

User's Manual





# 7 Specifications

Technical Specification		Model					KDB-181KCA					KDB-251KCA					KDB-301KCA				
Heating Input (Max-Min)	kW	21,4 ~ 10,2					23,9 ~ 11,5					29,2 ~ 11,6					34,9 ~ 15,1				
	(kcal/h)	(18.404 ~ 8.772)					(20.555 ~ 9.889)					(25.111 ~ 9.976)					(30.015 ~ 12.986)				
(Flow/Return 80/60 )	kW	20,9 ~ 10,0					23,3 ~ 11,3					28,4 ~ 11,4					33,8 ~ 14,8				
	(kcal/h)	(17.962 ~ 8.597)					(20.000 ~ 9.741)					(24.383 ~ 9.796)					(29.083 ~ 12.765)				
Condensing Heating Output (Max-Min)	kW	22,8 ~ 10,9					25,3 ~ 12,2					30,6 ~ 12,4					36,5 ~ 16,1				
(Flow/Return 50/30 )	(kcal/h)	(19.637 ~ 9.368)					(21.767 ~ 10.522)					(26.317 ~ 10.674)					(31.426 ~ 13.882)				
Useful Efficiency at Max – Min Heating Output (Flow/Return 80/60 )	%	97,6 ~ 98,0					97,3 ~ 98,5					97,1 ~ 98,2					96,9 ~ 98,3				
Useful Efficiency at Max – Min Heating Output (Flow/Return 50/30 )	%	106,7 ~ 107,0					105,9 ~ 106,4					104,8 ~ 107,0					104,7 ~ 106,9				
Useful Efficiency at 30% Max Heating Output (Return 47 )	%	102,4					102,3					102,9					103,2				
Useful Efficiency at 30% Max Heating Output (Return 30 )	%	108,2					108,0					108,3					108,8				
Heat Loss through the Case with Burner ON		0,2					0,5					0,4					0,7				
Heat Loss through the Chimney with Burner ON		2,2					2,2					2,5					2,4				
Energy Performance																					
NOx Class		5					5					5					5				
Gas Type		G20	G25	G27	G30	G31	G20	G25	G27	G30	G31	G20	G25	G27	G30	G31	G20	G25	G27	G30	G31
Nozzle Diameter	mm	5,55	6,30	6,65	3,65	4,25	6,80	7,90	8,40	4,20	5,15	5,95	6,75	7,00	3,95	4,55	6,70	8,05	8,20	4,40	5,15
Diaphragm Diameter	mm	24,5	24,5	24,5	22,0	24,5	28,0	28,0	28,0	24,5	28,0	25,5	25,5	25,5	29,0	25,5	29,0	29,0	29,0	29,0	25,5
Gas Supply Pressure	mbar (mmH <sub>2</sub> O)	20	20	20	30	37	20	20	20	30	37	20	20	20	30	37	20	20	20	30	37
		(204)	(204)	(204)	(306)	(377)	(204)	(204)	(204)	(306)	(377)	(204)	(204)	(204)	(306)	(377)	(204)	(204)	(204)	(306)	(377)
Purpose		Heating and Domestic Hot Water Production																			
Heating Water Circulation Method		Air Close Type																			
Max Heating Water Pressure	bar	3,0																			
Max Heating Temperature		85																			
Adjustable Temperature Heating		30 ~ 50 : 40 ~ 80																			
Total Volume Expansion Tank	L	7,0										10,0									
Expansion Tank Pre Charge	bar	1,0																			
Domestic Hot Water Output	kW (kcal/h)	20,9 ~ 10,0 (17.962 ~ 8.596)					23,3 ~ 11,3 (20.000 ~ 9.741)					28,4 ~ 11,4 (24.383 ~ 9.796)					33,8 ~ 14,8 (29.083 ~ 12.765)				
Min. Dynamic Dom. Hot Water Pressure	bar	0,2																			
Min. Domestic Water Flow Rate	l/min	2,3																			
Max. Domestic Water Pressure	bar	17,5																			
Adjustable Domestic Hot Water Temperature		35 ~ 60																			
Specific Domestic Hot Water	T = 30	10,0					11,1					13,6					16,2				
Other Domestic Hot Water Rate	T = 25	12,0					13,3					16,3					19,4				
Other Domestic Hot Water Rate	T = 40	7,5					8,3					10,2					12,1				
Electric Supply	V/Hz	230V~ / 50																			
Nominal Absorption	A	0,6																			
Power Consumption	W	145																			
Electric Protection		IPX4D																			
Installation Type		Wall Mounting Type																			
Intake/Exhaust Flue System Type	mm	B33 – C13 – C33 – C43 – C53 – C63 – C83																			
Intake/Exhaust Flue Diameter	mm	Concentric 60/100 , Separate 80/80																			
Connecting Diameter	Heating Water Connection	"																			
	Domestic Hot Water Connection	"																			
	Gas Connection	"																			
		3/4																			
		1/2																			
		3/4																			
Physical Dimension	WxDxH(mm)	495x216x695										515x243x715									
Weight	kg	34					34					36					38				
Gas Type		G20					G20					G20					G20				
Exhaust Mass Flow Rate at Max Heating Output	kg/h	34					38					46					56				
Exhaust Mass Flow Rate at Min Heating Output	kg/h	17					19					19					25				
CO <sub>2</sub> at Max Output	%	9,3					9,3					9,4					9,2				
CO <sub>2</sub> at Min Output	%	9,0					9,0					8,9					8,8				
CO(0%O <sub>2</sub> ) at Max Output	ppm	140					151					163					172				
CO(0%O <sub>2</sub> ) at Min Output	ppm	43					55					40					43				
NOx(0%O <sub>2</sub> ) at Max Output	ppm	34					35					38					41				
NOx(0%O <sub>2</sub> ) at Min Output	ppm	26					26					30					35				
Exhaust Temperature at Max Output		67					70					71					70				
Exhaust Temperature at Min Output		56					59					62					61				



# WARRANTY

Product		Purchase date	Year/date	Repair	Name of the repair person	Verification
Model		Date				
Manufacture No.						
Dealer	Dealer Name					
	Telephone					
	Address					

## ■ Product Warranty Guide

- ① For free warranty  
Any malfunction that occurs within the free warranty period calculated from the date of purchase: if the following occurs, the total cost of labor, repair, and component parts will not be charged. Thus, if any manufacturer's defect is detected from the initial installation or when malfunction occurs during normal usage, we will not charge for any of the repairs.
- ② For charged repairs and component parts
- After the free warranty expires
  - Malfunctions due to unforeseeable natural disasters
  - Malfunctions caused by repairs done by someone other than approved dealer repair persons.
  - Malfunctions caused by the purchaser (during transfer or improper usage)
  - Malfunctions due to improper electrical capacity
  - When there is no specification on the warranty or warranty is lost

## ■ Consumer Protection Regulations

Warranty Period	Consumer Damage Types	Compensation Standards	
		Repair	Exchange
Within one year from the date of installation of the unit	<ul style="list-style-type: none"> <li>• Leaks in the unit (manufacturer defect)</li> <li>• Hot water or heating problems</li> <li>• Defective components (ignition device or thermostat)</li> <li>• Noise</li> </ul>	Free	Unit (Free)
Within 3 months of the date of installation of the unit	<ul style="list-style-type: none"> <li>• Damages (external)</li> </ul>	Free	Unit (Free)
Damages compensation regulation after warranty expiration	<ul style="list-style-type: none"> <li>• Same as above</li> </ul>	Charge	Charge

## ■ How to receive service

- ① keep warranty  
At the dealer where the purchase was made, please register the information and check the specifications then keep the warranty for safe keeping.
- ② Where to receive service?  
If there is any defect or malfunction in the unit, please contact the store where you purchased the unit, dealer, or Kyungdong Boiler Consumer Protection Center.
- ③ What information do I need?  
When reporting, you must verify the model, manufacturer number, purchased store name, and the purchase date and specify the malfunction of the unit in detail.
- ④ What are the costs of repair and benefits?  
For repairs, present the warranty to the Kyungdong Boiler service personnel when he or she visits your home for repairs to receive either free or charged repair benefits.

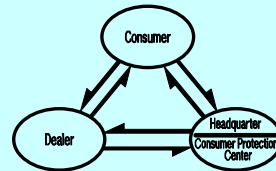

※ Dealers and Installer must complete the necessary items in the above chart on the Warranty.