

Grizzly *Industrial, Inc.*®

MODEL T23092 HIGH-PRESSURE SPRAY GUN OWNER'S MANUAL



COPYRIGHT © APRIL, 2011 BY GRIZZLY INDUSTRIAL, INC.
WARNING: NO PORTION OF THIS MANUAL MAY BE REPRODUCED IN ANY SHAPE
OR FORM WITHOUT THE WRITTEN APPROVAL OF GRIZZLY INDUSTRIAL, INC.

#TS14062 PRINTED IN CHINA

SAFETY

WARNING

For Your Own Safety Read Instruction Manual Before Operating This Equipment

The purpose of safety symbols is to attract your attention to possible hazardous conditions. This manual uses a series of symbols and signal words which are intended to convey the level of importance of the safety messages. The progression of symbols is described below. Remember that safety messages by themselves do not eliminate danger and are not a substitute for proper accident prevention measures.



Indicates an imminently hazardous situation which, if not avoided, **WILL** result in death or serious injury.



Indicates a potentially hazardous situation which, if not avoided, **COULD** result in death or serious injury.



Indicates a potentially hazardous situation which, if not avoided, **MAY** result in minor or moderate injury. It may also be used to alert against unsafe practices.

NOTICE

This symbol is used to alert the user to useful information about proper operation of the equipment.

WARNING

Safety Instructions For Spray Guns

- 1. READ THIS MANUAL.** This gun may cause personal injury if used incorrectly. This manual contains proper safety and operating instructions that must be followed to reduce this risk.
- 2. WEAR EYE PROTECTION.** Material sprayed into eyes may cause serious injury or blindness. Always wear safety goggles ANSI approved for spraying (sealing type) to reduce your risk from this hazard.
- 3. SPRAY IN VENTILATED AREA.** Airborne particles and fumes are toxic and can cause brain damage or death. To reduce your risk, only use the spray gun in a well ventilated area with adequate supply of fresh air.
- 4. WEAR A RESPIRATOR.** Airborne material from spraying can be very hazardous to lungs. Always wear a respirator NIOSH approved for spraying and fumes of your material type; or use a supplied air respirator system that delivers fresh air from an outside location via hoses.
- 5. MAINTAIN EQUIPMENT.** Pressurized spray guns or hoses may burst unexpectedly if damaged or poorly maintained, causing serious injury. Fix air leaks immediately and follow all recommended maintenance. Never operate this spray gun with loose or disassembled components. Never modify the spray gun.

- 6. USE CORRECT AIR PRESSURE.** Exceeding the maximum PSI rating of this spray gun may cause unpredictable operation or bursting.
- 7. DISCONNECT AIR PRESSURE** before servicing, changing accessories, or moving to another location. Never leave this spray gun unattended when connected to air.
- 8. AVOID IGNITION SOURCES.** Spraying around ignition sources may cause fire or an explosion. Do not spray around any ignition sources or potential ignition sources. Be aware of appliances that have pilot lights or machinery that creates sparks during operation. Do not smoke in the spraying area or when spraying.
- 9. FIRE EXTINGUISHERS.** Always have a fully charged multi-class or class B fire extinguisher in the immediate area.
- 10. AVOID UNINTENTIONAL OPERATION.** Always disconnect air when not in use, and do not carry tool with hand on trigger.
- 11. KEEP CHILDREN AWAY.** Prevent children from injury by keeping them away from this spray gun. Disconnect and lock the spray gun away when not in use.
- 12. AVOID USE WHEN TIRED OR ON DRUGS OR ALCOHOL.** Avoid using this spray gun if you are overly tired or intoxicated. Using this spray gun during these times may increase the risk of injury or fire.
- 13. UNTRAINED & UNSUPERVISED USE.** Untrained operators are not aware of the safe use of this spray gun and may injure themselves or cause fire. All untrained operators must be directly supervised at all times if using this spray gun.
- 14. READ MATERIAL LABELS and MATERIAL SAFETY DATA SHEETS (MSDS).** Read and know all the instructions on the packaging label and the MSDS before opening the package. This information could save your life.
- 15. PROTECTIVE CLOTHING.** Protect exposed skin from overspray by wearing a protective suit or other approved garment.
- 16. INAPPROPRIATE USE. DO NOT** point or shoot spray gun directly at yourself or another person or animals. Do not attempt to use the spray gun for any other use than it was intended.
- 17. STORAGE.** Thoroughly clean and dry spray gun before storage. Store in an approved cabinet.
- 18. BE AWARE OF HOSE LOCATION.** Hoses can easily become a tripping hazard when laid across the floor in a disorganized fashion.
- 19. SOLVENTS.** Always store solvents and shop towels soaked in solvent in approved containers.
- 20. LOCAL LAWS.** Consult local authorities regarding exhaust and waste disposal requirements.

SECTION 2: INTRODUCTION

Foreword

The specifications, details, and photographs in this manual represent the Model H8222 as supplied when the manual was prepared. However, owing to Grizzly's policy of continuous improvement, changes may be made at any time with no obligation on the part of Grizzly.

If you have any comments regarding this manual, please write to us at the following address:

Grizzly Industrial, Inc.
C/O Technical Documentation
P.O. Box 2069
Bellingham, WA 98227-2069
Email: manuals@grizzly.com

Most importantly, we stand behind our tools. If you have any service questions or parts requests, please call or write us at the location listed below.

Grizzly Industrial, Inc.
1203 Lycoming Mall Circle
Muncy, PA 17756
Phone: (570) 546-9663
Fax: (800) 438-5901
E-Mail: techsupport@grizzly.com
Web Site: <http://www.grizzly.com>

Specifications

Type of FeedSiphon
Viscosity Range.....Medium to High
Waterborne Material Compatible..... No
Nozzle Size2.0mm
Maximum Pattern Width......9"
Air Inlet Size1/4" NPT
Fluid Cup Capacity..... 1 Liter
Average Air Consumption 6-8.8 CFM
Operating Air Pressure..... 44-58 PSI
Cup Construction.....Aluminum
Gun Body ConstructionPainted Metal
Country of Origin China

WARNING

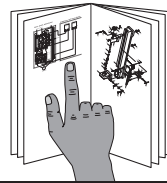

This spray gun presents serious injury hazards to untrained users. Read through this entire manual to become familiar with the controls and operations before using the equipment!

SECTION 3: SET UP

Inventory

Your spray gun was carefully packaged for safe transportation. Remove the packaging materials from around the tool and inspect it. If you discover the spray gun is damaged, *please immediately call Customer Service at (570) 546-9663 for advice.*

Save the containers and all packing materials for possible inspection by the carrier or its agent. Otherwise, filing a freight claim can be difficult.

When you are completely satisfied with the condition of your shipment, inventory the contents.

Model T23092 Inventory (Figure 1)

- A. Fluid Cup..... 1
- B. Spray Gun Body 1



Figure 1. Model T23092 inventory.

Assembly

Prior to assembly and use of the spray gun, it is essential that all parts be thoroughly cleaned and dried. Please refer to **Cleaning** on **Page 10** for more detailed instructions.

Make sure all connections are tight enough to prevent air leaks but not so tight as to damage the tool.

Attach the gun body to the fluid cup assembly, as shown in **Figure 2**. Make sure the connection is tight to prevent leaks.



Figure 2. Attaching the spray gun body to the fluid cup.

NOTICE

For the best results, use a hose that will be dedicated for spray use only. Do not use a hose that has been used with an in-line oiler or other possible contaminant. Always install an air pressure regulator between the air hose and the gun.

Identification & Controls

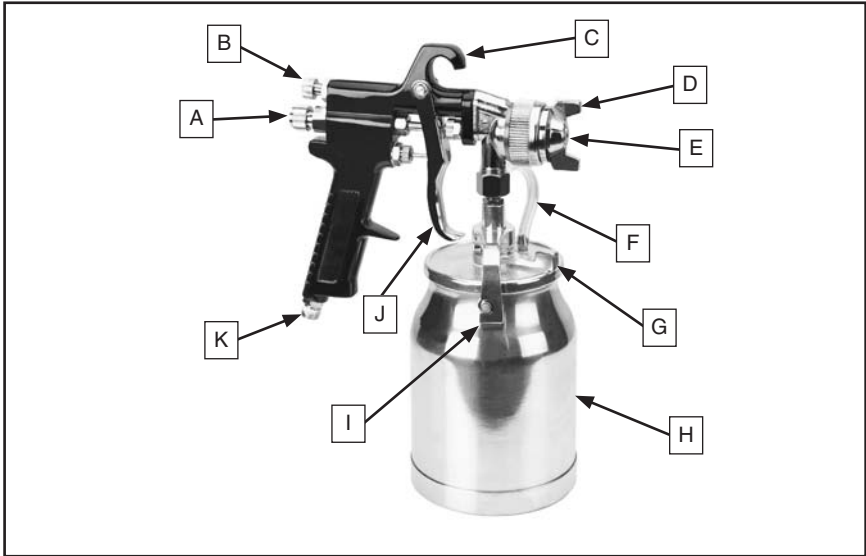

Figure 3. Model T23092 identification and controls.

Refer to **Figure 3** and the following descriptions to gain an understanding of the features and controls of this spray gun. Be sure to read the entire manual before beginning spraying operation to ensure a safe and efficient experience.

- A. Fluid Control.** Controls the volume of material that travels through the fluid nozzle and past the atomizer cap.
- B. Pattern Control.** Adjusts the spray output between a round pattern and a wide fan.
- C. Storage Hook.** Allows the spray gun to be temporarily stored in a vertical position to avoid material spills.
- D. Atomizing Cap.** Atomizes the material as it is sprayed from the nozzle. Adjusts for horizontal or vertical spray stroke patterns.
- E. Fluid Nozzle.** Sprays the material past the atomizer cap.

- F. Vacuum Relief Hose.** Allows air to flow into the fluid cup as needed to prevent a vacuum build-up.
- G. Fluid Cup Lock Lever.** Releases/engages pressure between the cup hooks and pins.
- H. Fluid Cup.** Holds the finish material to be sprayed.
- I. Cup Hook & Pin.** When pressure is applied by the lock lever, secures the lid assembly to the cup.
- J. Two-Stage Trigger.** Stage one only releases compressed air for blowing off the work piece. Stage two sprays material. Lightly squeeze the trigger for stage one or squeeze the trigger all the way to spray material.
- K. Air Inlet.** Provides a 1/4" NPT connection for the compressed air hose.

SECTION 4: OPERATIONS

⚠ DANGER



EXPLOSION HAZARD! DO NOT smoke or have any source of flame or spark near spraying. Vapors will explode if ignited.

⚠ WARNING



To reduce the risk of injuries from compressed air explosion, always disconnect the air line before removing/installing the fluid cup.

⚠ WARNING



EYE/LUNG HAZARD! Always use a NIOSH approved respirator and eye goggles when using spray equipment. Failure to protect your lungs and eyes can lead to respiratory illness, nervous system damage, or blindness.

⚠ WARNING



TOXIC FUMES! Always use an approved spray booth or well ventilated area when spraying. NEVER spray in a confined space where toxic fumes and flammable vapors can accumulate to deadly levels.

Spraying

The Model T23092 high-pressure spray gun is designed to spray a wide variety of materials such as lacquers, stains, primers, multi-component paints, clear coats, acrylics, epoxies, etc. It is ideal for auto body and woodworking projects. This spray gun is not designed to be used with waterborne materials.

Note: Use *Figure 3* to identify the location of controls referenced in these instructions.

To use your spray gun:

1. DISCONNECT GUN FROM AIR!
2. Read and follow the material manufacturer's instructions for spraying, mixing, safety, disposal, and any other instruction on the label or Material Safety Data Sheet (MSDS).

3. Move the cup lock lever against the vacuum hose connection to release the pressure between the cup hooks and pin—this will disengage the cup lid from the cup.
4. Fill the fluid cup with the desired material, then place it on a flat, stable surface.
5. Move the lock lever against the vacuum relief hose connection, then place the cup lid and gun body assembly on the cup
6. Engage the cup pins with the hooks, then rotate the lock lever clockwise until the lid is firmly secured.

CAUTION

To ensure the fluid cup does not leak or spill material during the spraying operation, always make sure the cup is securely sealed to the lid with both pins fully engaged with the hooks.

7. Set the inlet air pressure (the air coming to the spray gun) to the lowest operating air pressure recommended in the **Tool Data Sheet** on **Page 3** or to the material manufacturer's recommendations.
8. Connect the spray gun to the compressed air.
9. Adjust the atomizing cap to vertical or horizontal. See **Atomizing Cap Adjustment** on **Page 8** for a further explanation.

Note: *Trial and error are necessary to achieve the results you want along with a fair amount of practice. Test your material flow and spray pattern on a piece of cardboard or some scrap of material similar to your project.*

10. Adjust the fluid control knob to start with a low volume of material and keep the atomization as low as possible. You will need to use a combination of fluid control, inlet air pressure, air flow control and stroke speed to achieve the results you want. Spray so the material wets out nicely without running or sagging.
11. Use the pattern control knob to adjust the spray fan to your desired pattern.
12. Keep the gun tip perpendicular, parallel and 6-12" from the work at all times when spraying, as shown in **Figure 4**. Do not allow your wrist to bend. This will cause the gun to arc across the surface and distribute the material unevenly, possibly creating sags and dry spots.

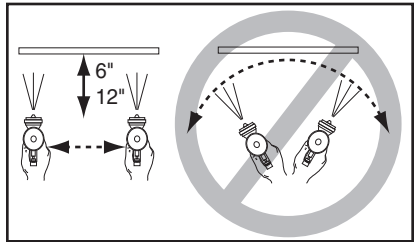

Figure 4. Spraying technique.

NOTICE

Tipping the spray gun may cause material to spill out of the cup. Always hold the spray gun parallel to the ground to avoid potential spills and feed problems.

13. Begin spraying 2-3 inches before the work and continue the motion for a few inches past the work until you are ready for the return stroke.

- Maintain an even speed when spraying and overlap each stroke by 50%. This will ensure even coverage, as shown in on the left of **Figure 5**. Overlapping less than 50%, as shown on the right, may lead to missed spots or streaky results.

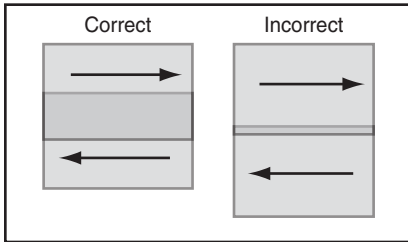

Figure 5. Overlapping technique.

- The spray stroke should have even consistency and parallel edges. If it does not, refer to **Troubleshooting** on **Page 12**.

Pattern Control

The pattern control knob on the rear of the gun body controls the spray output between a round pattern and a wide fan, as illustrated in **Figure 6**.

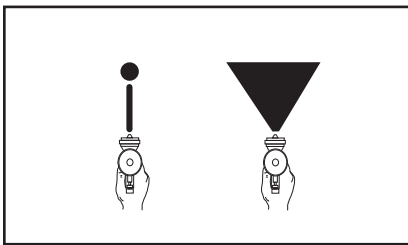

Figure 6. Range of spray patterns.

Atomizing Cap Adjustment

To ensure good spraying results, the atomizing cap must be correctly orientated for the direction of the stroke pattern—either horizontal or vertical.

Spraying in the wrong direction may lead to material build-up on the atomizing cap horn. Many performance problems are caused by clogged atomizing holes. In this case, clean the spray gun (see **Cleaning** on **Page 10**)

If the stroke pattern is side-to-side, the horns of the atomizing cap must be arranged horizontally, as shown in **Figure 7**.

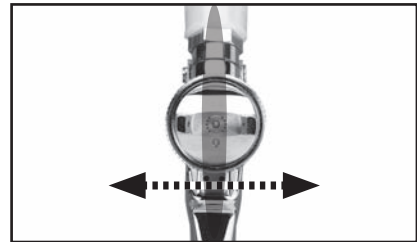

Figure 7. Atomizing cap set up for side-to-side stroke pattern (front view).

Conversely, if the stroke pattern is up-and-down, the atomizing cap horns should be vertical, as shown in **Figure 8**.

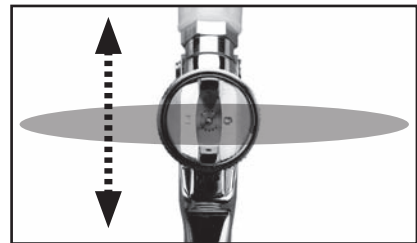

Figure 8. Atomizing cap set up for up-and-down stroke pattern (front view).

SECTION 5: ACCESSORIES

G6261—Campbell Hausfeld™ Water Filter

Remove damaging water vapor before it reaches your spray gun. This highly effective, five micron filter features a see-through bowl and easy in-line connections. 150 PSI maximum air pressure. 1/4" NPT.



Figure 9. G6261 Campbell Hausfeld™ water filter.

H5683—1/4" NPT x 33 ft. Retractable Hose Reel

This hand hose reel can be mounted on the wall or ceiling. The shell is made of impact-resistant polyethylene, which completely covers the hose when not in use. This hose reel features a cloth-reinforced hose, a working pressure of 180 PSI, 1/4" NPT pipe threads, and anti-kinking springs.



Figure 10. H5683 Hose Reel.

H7274—Campbell Hausfeld™ Pressure Regulator

Mini Series. Provides regulated output pressure of 0 to 125 PSI for proper tool operation. Locking pressure knob prevents accidental adjustments. 15 SCFM flow capacity @ 90 PSI. 1/4" NPT.



Figure 11. H7274 Campbell Hausfeld™ pressure regulator.

H3174—Air Blow Gun with 2 Tips

This air blow gun includes a safety tip and rubber tip for all normal air cleaning jobs. 1/4" NPT.



Figure 12. H3174 Air Blow Gun with 2 Tips.

T20555—Campbell Hausfeld™ Air Tool Oil, 8 oz.

Call 1-800-523-4777 To Order

SECTION 6: MAINTENANCE

⚠ WARNING

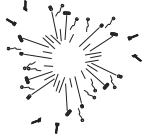

To reduce the risk of injuries from compressed air explosion, always disconnect the air line before performing maintenance or service.

Cleaning

Properly cleaning the spray gun helps to ensure good spraying results and long gun life. Always thoroughly clean the spray gun after each use.

To clean the spray gun:

1. Spray a small amount of cleaning solvent through the gun.

Note: Check with local laws regarding this practice. If you are spraying on a regular basis, spraying solvents into the air may be illegal. A cabinet style spray gun cleaner may be required.

2. DISCONNECT SPRAY GUN FROM AIR!

3. Remove the cup and cup lid, then disassemble the gun by unscrewing the fluid control knob and removing the spring and needle (see **Figure 13**).

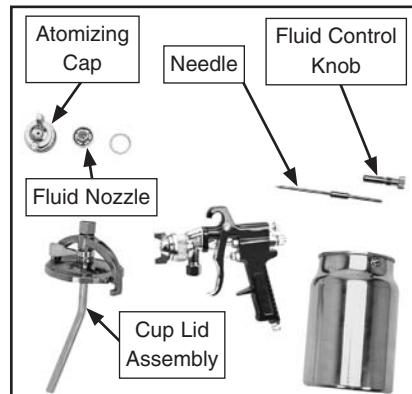

Figure 13. Spray gun disassembled for cleaning.

4. Unscrew the atomizing cap with your fingers, then remove the fluid nozzle with a wrench. The fully disassembled gun should look like **Figure 13**.

⚠ WARNING

EXPLOSION HAZARD! Chlorinated Solvents like 1,1,1-Trichloroethane and Methylene Chloride (methyl chloride) can chemically react with aluminum and may explode. Many parts in spray guns are made of aluminum. Read solvent label carefully before using solvent.

- Rinse these parts thoroughly in solvent, then dry with compressed air or let air dry.

NOTICE

DO NOT soak the spray gun body in solvent. Prolonged exposure to solvent will rapidly deteriorate the spray gun washers and seals.

Note: *If the small holes in the atomizing cap become blocked, soak the cap in clean solvent. If the blockage still exists, clear the blockage with a small needle, taking great care to not enlarge or damage the hole. Damage to the hole will create a disrupted spray pattern.*

- Use an old tooth brush and solvent to clean the inner orifice and other hard to reach areas on the outside of the gun body.
- Wipe the gun body dry with a lint free shop towel.

Lubrication

Lubricate the following areas shown in **Figure 14** with a non-silicon spray gun lubricant after each cleaning.

- Fluid Control Knob
- Pattern Control
- Air Valve Packing
- Atomizing Cap Threads
- Trigger Pin

Allow the lubricant to coat threads and run into the gun body to lubricate all moving parts and seals.

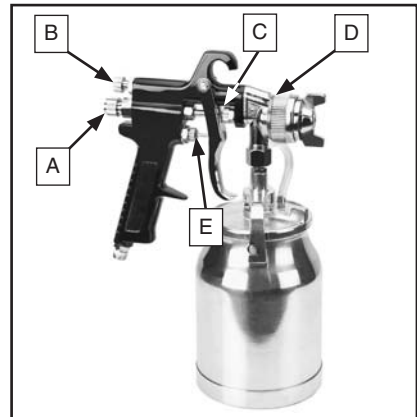







Figure 14. Lubrication locations.

SECTION 7: SERVICE

Troubleshooting

Symptom	Possible Cause	Solution
Fluttering or spitting spray. 	<ol style="list-style-type: none"> 1. Dry or worn fluid nozzle seat permits air to seep into fluid passage. 2. Material level too low. 3. Fluid nozzle obstructed. 4. Dry needle packing. 	<ol style="list-style-type: none"> 1. Tighten fluid tip or replace seat with new one. 2. Add material. 3. Clean. 4. Lubricate needle.
Uneven top or bottom pattern. 	<ol style="list-style-type: none"> 1. Atomizing cap holes are obstructed. 2. Build-up on top or bottom of fluid nozzle. 3. Build-up on atomizing cap or on needle seat. 	<ol style="list-style-type: none"> 1. Clear holes. 2. Clean. 3. Clean.
Right or left arc pattern. 	<ol style="list-style-type: none"> 1. Left or right side horn holes are plugged. 2. Build-up on left or right side of fluid tip. 3. Build-up of material inside atomizing cap. 	<ol style="list-style-type: none"> 1. Clear holes. 2. Clean. 3. Clean.
Heavy deposit of material in center. 	<ol style="list-style-type: none"> 1. The material flow exceeds the atomizing cap capacity. 2. Inlet air pressure is too low. 3. Material is too thick. 	<ol style="list-style-type: none"> 1. Lower fluid flow. 2. Increase inlet air pressure. 3. Thin material.
Narrow center pattern. 	<ol style="list-style-type: none"> 1. Fluid control turned in too far. 2. Inlet air pressure too high. 3. Fluid pressure is too low. 4. Material is too thin. 	<ol style="list-style-type: none"> 1. Lower fluid flow. 2. Reduce inlet air pressure. 3. Increase fluid pressure. 4. Adjust material.
Gun leaks from fluid nozzle.	<ol style="list-style-type: none"> 1. Debris will not let the needle seat with the fluid nozzle. 	<ol style="list-style-type: none"> 1. Clean or replace both.

Symptom	Possible Cause	Solution
No spray output.	<ol style="list-style-type: none"> 1. No pressure at gun. 2. Fluid passages dirty. 3. Fluid control closed. 4. Out of paint. 5. Material too thick. 	<ol style="list-style-type: none"> 1. Check air supply. 2. Clean gun, remove any obstructions. 3. Open. 4. Refill. 5. Thin to manufacturer's recommendations.
Excessive over-spray.	<ol style="list-style-type: none"> 1. Fluid pressure too high. 2. Gun is too far from surface. 3. Spraying too fast. 	<ol style="list-style-type: none"> 1. Reduce fluid pressure. 2. Keep gun at recommended distance. 3. Slow down and maintain consistent, even parallel stroke.
Unable to control spray fan.	<ol style="list-style-type: none"> 1. Pattern adjustment screw is not seating properly. 2. Atomizing cap is loose. 	<ol style="list-style-type: none"> 1. Clean or replace. 2. Tighten atomizing cap.
Runs and sags.	<ol style="list-style-type: none"> 1. Damaged seal. 2. Too much fluid output. 3. Keeping gun in one place too long. 	<ol style="list-style-type: none"> 1. Replace damaged seal(s). 2. Use fluid control to reduce flow. 3. Keep gun moving at a steady pace.
Material leaks from cup.	<ol style="list-style-type: none"> 1. Cap not secure. 2. Cup not tight on gun body. 3. Leaking from cap vent hole. 	<ol style="list-style-type: none"> 1. Tighten. 2. Tighten. 3. Hold gun upright do not tilt.
Material leaks from gun.	<ol style="list-style-type: none"> 1. Fluid tip loose. 2. Dry or damaged seals. 3. Excessive pressure. 	<ol style="list-style-type: none"> 1. Tighten. 2. Replace seals. 3. Reduce pressure.
Thick dimpled finish: orange peel appearance.	<ol style="list-style-type: none"> 1. Holding gun too close to surface. 2. Inlet air pressure too low. 3. Material not properly mixed. 4. Surface is dirty or oily. 	<ol style="list-style-type: none"> 1. Spray at recommended distance. 2. Check inlet air pressure. 3. Follow manufacturer's instructions. 4. More surface prep is required.
Dry spray.	<ol style="list-style-type: none"> 1. Inlet air pressure too high. 2. Gun too far from surface. 3. Gun stroke too fast. 	<ol style="list-style-type: none"> 1. Lower inlet air pressure. 2. Keep gun at recommended distance. 3. Slow down and maintain consistent even parallel stroke.
Contaminated paint: fish eye appearance.	<ol style="list-style-type: none"> 1. Water or oil in the air line. 	<ol style="list-style-type: none"> 1. Install an in-line air filter. 2. Replace air line.

T23092 Parts Breakdown

Parts breakdown provided for reference only. Not all parts shown are available for purchase.

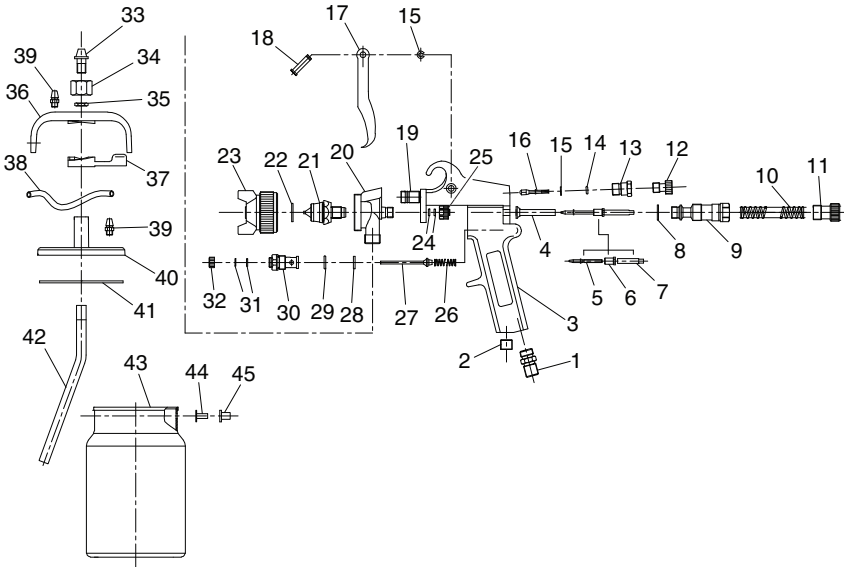

REF PART # DESCRIPTION

1	N/A	AIR INLET CONNECTOR 1/4" NPT
2	N/A	SCREW
3	N/A	GUN BODY
4	N/A	NEEDLE HOUSING
5	N/A	FLUID ADJUSTMENT NEEDLE
6	N/A	NEEDLE SLEEVE
7	N/A	SPRING CORE
8	N/A	O-RING
9	N/A	SPRING HOUSING
10	N/A	NEEDLE COMPRESSION SPRING
11	N/A	FLUID CONTROL KNOB
12	N/A	PATTERN CONTROL KNOB
13	N/A	PATTERN NEEDLE SEAT
14	N/A	O-RING 4.5 X 1.8
15	N/A	RETAINING RING
16	N/A	PATTERN NEEDLE
17	N/A	TRIGGER
18	N/A	TRIGGER PIN
19	N/A	CONNECTOR SCREW
20	N/A	HEAD
21	N/A	NOZZLE
22	N/A	WASHER
23	N/A	ATOMIZING CAP

REF PART # DESCRIPTION

24	N/A	WASHER
25	N/A	DIRECTION SCREW
26	N/A	TRIGGER COMPRESSION SPRING
27	N/A	TRIGGER STEM
28	N/A	STEM WASHER
29	N/A	O-RING 9 X 1.8
30	N/A	STEM SEAT
31	N/A	WASHER
32	N/A	STEM SEAT NUT
33	N/A	FLUID INLET NOZZLE
34	N/A	INLET HEX NUT
35	N/A	INLET THIN NUT
36	N/A	LOCK ARM
37	N/A	LOCK LEVER
38	N/A	FLUID HOSE
39	N/A	HOSE CONNECTOR
40	N/A	CUP LID
41	N/A	LID GASKET
42	N/A	SYPHON TUBE
43	N/A	FLUID CUP
44	N/A	CUP SCREW
45	N/A	CUP PIN

WARRANTY

Grizzly Industrial, Inc. warrants every product it sells for a period of **1 year** to the original purchaser from the date of purchase. This warranty does not apply to defects due directly or indirectly to misuse, abuse, negligence, accidents, repairs or alterations or lack of maintenance. This is Grizzly's sole written warranty and any and all warranties that may be implied by law, including any merchantability or fitness, for any particular purpose, are hereby limited to the duration of this written warranty. We do not warrant or represent that the merchandise complies with the provisions of any law or acts unless the manufacturer so warrants. In no event shall Grizzly's liability under this warranty exceed the purchase price paid for the product and any legal actions brought against Grizzly shall be tried in the State of Washington, County of Whatcom.

We shall in no event be liable for death, injuries to persons or property or for incidental, contingent, special, or consequential damages arising from the use of our products.

To take advantage of this warranty, contact us by mail or phone and give us all the details. We will then issue you a "Return Number," which must be clearly posted on the outside as well as the inside of the carton. We will not accept any item back without this number. Proof of purchase must accompany the merchandise.

The manufacturers reserve the right to change specifications at any time because they constantly strive to achieve better quality equipment. We make every effort to ensure that our products meet high quality and durability standards and we hope you never need to use this warranty.

Please feel free to write or call us if you have any questions about the machine or the manual.

Thank you again for your business and continued support. We hope to serve you again soon.