

**PARKER**  
Etablissement de Dijon  
4 Boulevard Eiffel  
F-21600 Longvic  
www.parker.com



# RTS 2nd Generation

SERVOAMPLIFIER

User and Commissioning Manual

PVD 3487b - GB – 07/2015

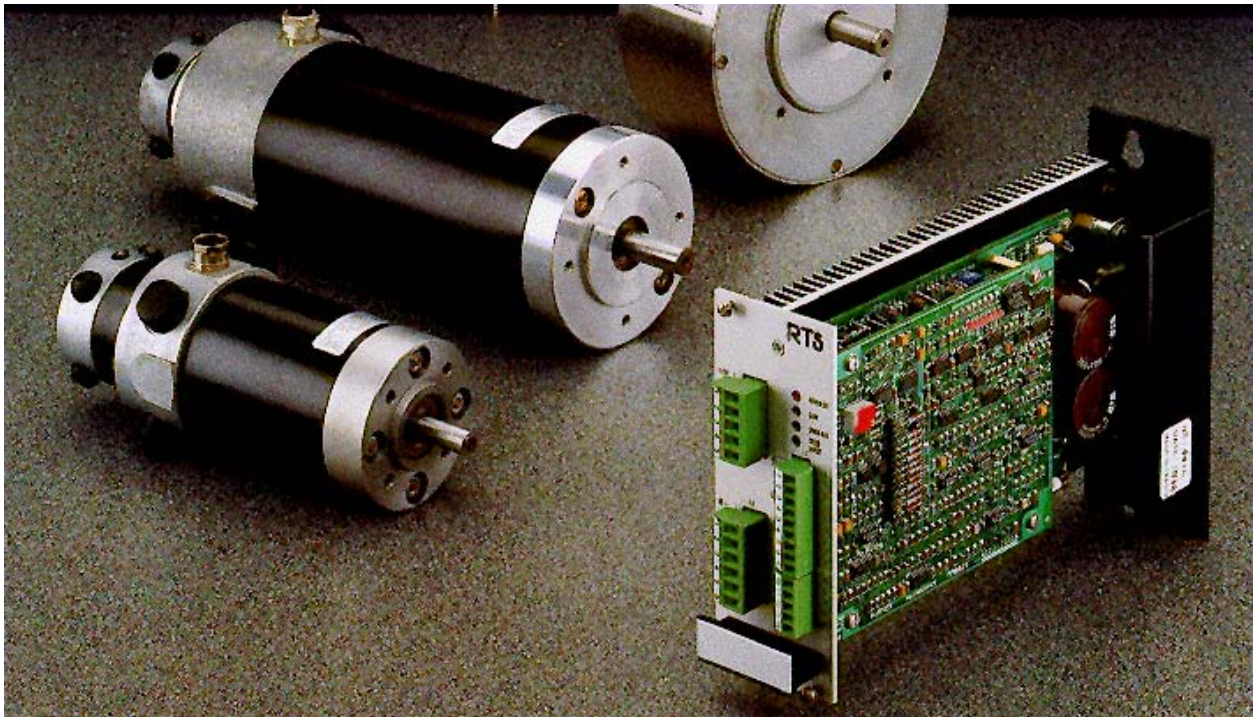

## CONTENTS

<b>SAFETY INSTRUCTIONS</b> .....	<b>3</b>
<b>1. GENERAL</b>	<b>5</b>
<b>2. TECHNICAL SPECIFICATIONS</b>	<b>6</b>
2.1 RTS Servo amplifier performance chart	7
2.2 Block diagram	8
<b>3. DIMENSIONS, LABELLING,</b>	<b>9</b>
3.1 Dimensions	9
3.2 Labelling	23
<b>4. - ELECTRICAL CONNECTIONS</b>	<b>24</b>
4.1 General Wiring Requirements	24
4.1.1 Appliance handling	24
4.1.2 Electromagnetic compatibility	24
4.2 RTS Servo amplifier connection	25
4.3 Front Panel	30
4.4 Terminal blocks X1, X2 AND X3	35
4.5 Terminal block X2 connection	38
4.6 Terminal block X3 connection	38
4.7 Accessories	39
4.7.1 Plug-in Customisation card	39
4.7.2 Extra choke	39
4.7.3 Transformer	40
4.7.4 Mains filter	40
<b>5. LED DISPLAYS</b>	<b>49</b>
<b>6. SERVO AMPLIFIER ADAPTATION</b>	<b>50</b>
<b>7. COMMISSIONING</b>	<b>51</b>

<b>7.1</b>	<b>Speed loop rapid adjustment</b>	<b>52</b>
<b>7.2</b>	<b>Complete speed loop adjustment</b>	<b>53</b>
<b>7.3</b>	<b>Diagnostic help</b>	<b>55</b>
<b>7.4</b>	<b>Calibration</b>	<b>56</b>
7.4.1	Tachometric generator voltage calibration (R104)	58
7.4.2	Rated speed selection (R105)	59
7.4.3	Pulse current adjustment (R113)	60
7.4.4	Current limitation by external resistance or external voltage (terminal block X1)	60
7.4.4.1	By external resistance	60
7.4.4.2	By external voltage	60
7.4.5	Time constant adjustment $I = f(t)$ (R109)	61
7.4.6	Adjustment of function $I = f(t)$ (R103)	61
7.4.7	Adjustment of current limitation curve versus speed $I F(n)$ (R131 - 132)	62
7.4.8	Calibration of function $U - RI$ (R133 - R134)	63
7.4.9	Tripping limit calibration (R135)	64
7.4.10	Current loop gain adaptation to motor inductance (R136)	64
7.4.11	dc voltage calibration (RB)	65

Characteristics and dimensions subject to change without notice.

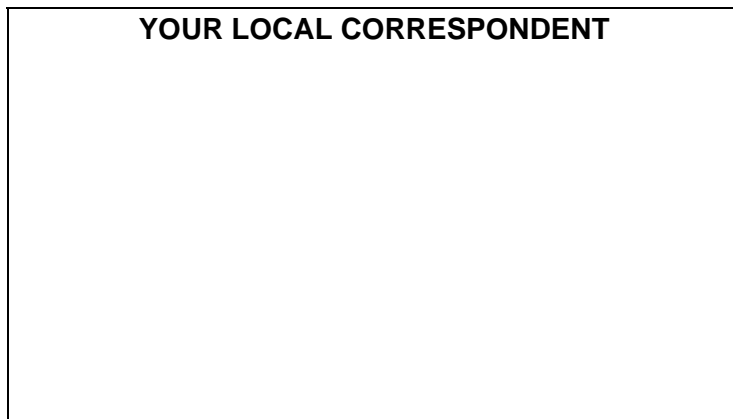

**PARKER**  
**Etablissement de Dijon**  
4 Boulevard Eiffel 21600 Longvic  
Tél. : +33 (0)3 80 42 41 40 / Fax : +33 (0)3 80 42 41 23  
[www.parker.com](http://www.parker.com)

## SAFETY

Servodrives present two main types of hazard :

### - Electrical hazard

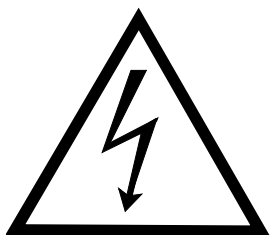

Servoamplifiers may contain non-insulated live AC or DC components. Users are advised to guard against access to live parts before installing the equipment.

Even after the electrical panel is de-energized, voltages may be present for more than a minute, until the power capacitors have had time to discharge.

Specific features of the installation need to be studied to prevent any accidental contact with live components :

- Connector lug protection ;
- Correctly fitted protection and earthing features ;
- Workplace insulation (enclosure insulation humidity, etc.).

### General recommendations :

- Check the bonding circuit;
- Lock the electrical cabinets;
- Use standardised equipment.



### - Mechanical hazard

Servomotors can accelerate in milliseconds. Moving parts must be screened off to prevent operators coming into contact with them. The working procedure must allow the operator to keep well clear of the danger area.

All assembly and commissioning work must be done by **qualified** personnel who are familiar with the safety regulations (e.g. VDE 0105 or accreditation C18510).

**Upon delivery**

All servoamplifiers are thoroughly inspected during manufacture and tested at length for bugs before shipment.

- Unpack the servoamplifier carefully and check it is in good condition.
- Also check that data on the manufacturer's plate comries with data on the order acknowledgement.

If equipment has been damaged during transport, the addressee must file a complaint with the carrier by recorded delivery mail within 24 hours.

Caution :

The packaging may contain essential documents or accessories, in particular :

- User Manual,
- Connectors.

**Storage**

Until installed, the servoamplifier must be stored in a dry place safe from sudden temperature changes so condensation cannot form.

**Special instructions for setting up the equipment**

<b>CAUTION</b>	
	<p>For this equipment to work correctly and safely it must be transported, stored, installed and assembled in accordance with this manual and must receive thorough care and attention..</p> <p>Failure to comply with these safety instructions may lead to serious injury or damage.</p> <p>The cards contain components that are sensitive to electrostatic discharges. Before touching a card you must get rid of the static electricity on your body. The simplest way to do this is to touch a conductive object that is connected to earth (e.g. bare metal parts of equipment cabinets or earth pins of plugs).</p>

# 1. GENERAL

The RTS servo amplifier is designed for four-quadrant control of DC servo motors up to mechanical powers of 2500 W.

It incorporates power and chopping supplies, including the energy dissipation resistor for some versions.

This integration makes for easier wiring and allows front panel access for a more user-friendly appliance.

Two formats are available :

Wall mounted type with rear angle bracket

Europe single 3 u DIN rack type.

Several axes can thus be included in one 19" rack.

## TECHNOLOGY

- CMS components (surface mounted).
- Genuine galvanic insulation to prevent sensitivity to interference.
- Hall effect current sensor.
- Chopping frequency 17 kHz.
- Speed bandwidth up to 150 Hz.
- Integrated short circuit protection.
- Speed range :           With tachometer       1: 10 000  
                                  U-RI                               1 : 10
- $\pm 10$  V differential reference for speed or current.
- Differential tachometer input.

## FUNCTIONS

- Switchable tachometer control in U-RI.
- Current or speed control.
- Current reduction with speed.
- Current reduction with temperature.
- External current reduction.
- Zero speed adjustment.
- Zero torque adjustment.
- Fault clearance (RESET).
- Analogue speed or torque information.
- Servo amplifier status relay.
- $\pm 15$  V available.

**- COMPLIANCE WITH STANDARDS**

RTS bears the CE mark under European Directive 89/336/EEC as amended by Directive 93/68/EEC on electromagnetic compatibility. This European Directive refers to the harmonised generic standards EN50081-2 of December 1993 (Electrical Compatibility - Generic Standard for Emissions - Industrial Environments) and EN50082-2 of June 1995 (Electromagnetic Compatibility - Generic Standard for Immunity - Industrial Environments). These two harmonised generic standards are based on the following standards :

- EN 55011 of July 1991 : Radiated and conducted emissions
- EN 50140 of August 1993 and ENV 50204 : Immunity to radiated electromagnetic fields
- EN 61000-4-8 of February 1994: Mains frequency magnetic fields
- EN 61000-4-2 of June 1995 : Electrostatic discharge
- ENV 50141 of August 1993 : Interference induced in cables
- EN 61000-4-4 of June 1995 : Rapid transient currents

Compliance with the reference standards above implies adherence to the instructions and wiring diagrams in the technical documents supplied with the appliances.

**Incorporation in Machinery**

The design of the equipment means it can be used in machinery covered by Directive 89/392/EEC (Machine Directive) provided that it is integrated (or incorporated and/or assembled) in accordance with the rules-of-the-art by the machinery manufacturer and in keeping with the instructions in this booklet.

**2. TECHNICAL SPECIFICATIONS**

Power reduction with altitude	Above 1000 m, 10% fall in useful power per 1000 m up to maximum 4000 m	
Operating temperature	Normal use: 0 to + 40°C Above 40°C, 35% fall in useful power per 10°C up to maximum 60°C	
Storage temperature	-30°C to +85°C	
Chopping frequency	17 kHz current	
Technology	Photocoupler controlled MOS transistors.	
Bandwidth in current	Up to 1500 Hz	
Bandwidth in speed	Up to 150 Hz at 90° phase shift	
Tachogenerator maximum voltage	100 V at input	
Speed range	1:10 000 with tachogenerator 1:10 with armature reaction (U - RI)	
Static precision of speed for load variation of 0 at $I_n$ and for servo amplifier rated voltage	From $N_{max}$ to $N_{max}/100$	+/- 0.5%
	From $N_{max}/100$ to $N_{max}/1000$	+/-1.5%
	From $N_{max}/1000$ to $N_{max}/10\ 000$	+/-10%
	U-RI control, from $N_{max}$ to $N_{max}/10$	+/-20%
Current control Precision Linearity	+/-2% of rated current at 25°C +/-1% of rated current at 25°C	
Electrical protection	- Galvanic insulation of power bridge - Magnetic current sensor - Power outputs protected against phase-to-phase and phase to-ground short-circuits	
Connections	Plug-in terminal blocks on front panel	
Protection	IP20, IP20 for shrouded versions	

## 2.1 RTS Servo amplifier performance chart

RTS CHARACTERISTICS at 40°C ambient temperature		3/10-40M single-phase	10/20-60 single/three- phase	12/24---B battery	12/24-130T three-phase	20/40-130T three-phase	16/32-190T three-phase
Input voltage range	V	18/36Vac	18/56Vac	16/60Vdc	58/116Vac	58/116Vac	82/164Vac
Rated input voltage	V	32Vac+/-10%	48Vac+/-10%		100Vac+/-10%	100Vac+/-10%	135Vac+/-10%
Maximum output voltage	V=	40	60	V battery -2V	130	130	190
Permanent output current	A	3	10	12	12	20	16
Pulse current (2 sec)	A	10	20	24	24	40	32
Minimum motor choke	mH	1	0.4	0.4	0.8	0.4	0.8
<b>BRAKING ENERGY DISSIPATION CAPACITY</b>							
Mean power	W	15W (option)	30	without	100	180	180
Max pulse power (4% of cycle)	W	400 (option)	800	without	2500	4500	4500
Maximum, non-repetitive	sec	2	1	-	1	2	2
Losses dissipated by RTS	W	15	40	30	80	120	130
<b>DIMENSIONS H x L x D (mm)</b>							
Rack version (single-phase)	mm	130/51/216	--	--	--	--	--
Rack version (three-phase)	mm	--	130/51/216	130/51/216 (battery)	130/61/216	--	--
Wall-mounted (single-phase)	mm	150/61/212	180/61/212	--	--	--	--
Wall-mounted (three-phase)	mm	--	150/61/212	150/61/212 (battery)	150/92/212	150/115/221	150/115/221
Rack/wall-mounted weight	kg	0.8/1	0.8/1.2	0.8/1	0.85/1.8	1.9	1.9



## 2.2 Block diagram

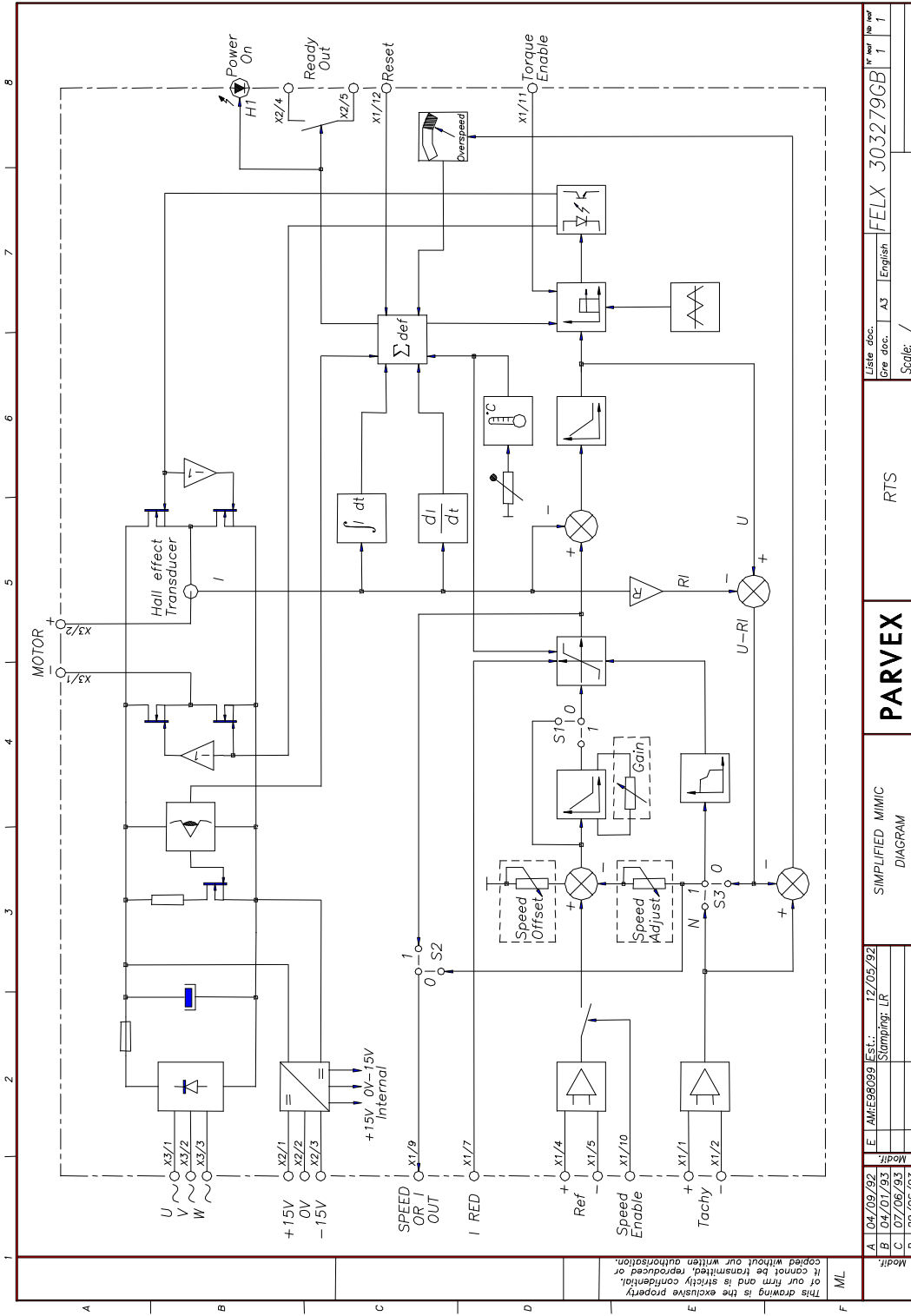

## 3. DIMENSIONS, LABELLING,

### 3.1 Dimensions

RTS servo amplifiers are available in two formats for vertical mounting :

- in single Europe 3U DIN rack, in two widths 10" and 19".
- wall- or panel-mounted, with rear angle bracket.

Racks are available with or without ventilation, while RTS wall-mounted versions have individual ventilation where required (RTS 12/24-130T, RTS 20/40-130T and RTS 16/32-190T). Unventilated racks are for RTS 3/10-40M only.

230 V single-phase fan connection : To terminal block located at the bottom of the rack front panel.

- Power consumption : RACE234V22, 2 x 15W fans.  
RACE238V32, 3 x 15W fans.

CODE	WIDTH	DIMENSIONS
RACE234	42E (10")	FELX 303532 (p12)
RACE234V22 (fan-cooled)	42E (10")	FELX 303532(p12)
RACE238	84E (19")	FELX 303531 (p11)
RACE238V32 (fan-cooled)	84E (19")	FELX 303531 (p11)

**Dimensions :**

	RTS	Parvex Ref.	Input supply	Compulsor y ventilation	Fan supply voltage	Dimensional drawing ref.	
						Without customisation card	With customisation card
R A C K  V e r s i o n	RTS 3/10-40M	RTS 4104-301 *RTS 6104-301	Single-phase	No	<del>230 V Single-phase</del>	<del> </del>	<del> </del>
	RTS 10/20-60T	RTS 43060102R *RTS 63060102R	Three-phase	Yes	230 V Single-phase	FELX 303440 (p13)	FELX 303805 (p15)
	RTS 12/24---B	RTS 42BA0102	Battery			FELX 303814 (p14)	<del> </del>
	RTS 12/24- 130T	RTS 43130102R * RTS 63130102R	Three-phase			FELX 303805 (p15)	

\* With personalizing card RZ6602

**RTS 2nd Generation SERVO AMPLIFIER**

	RTS	PARVEX Ref.	Input supply	Ventilation	Supply	Dimensional drawing (with or without customisation card)
<b>W A L L  M O U N T E D</b>	RTS 3/10-40M	RTS 5104-301 * RTS 7104-301	Single-phase	Not fan-cooled	<del>connection Internal</del>	FELX 304743 (p16)
	RTS 10/20-60T	RTS53060102R *RTS73060102R	Three-phase	Not fan-cooled	<del>connection Internal</del>	
	RTS 12/24---B	RTS 52BA0102 * RTS 72BA0102	Battery	Not fan-cooled	<del>connection Internal</del>	
	RTS 10/20-60M	RTS 51060102R * RTS 71060102R	Single-phase	Not fan-cooled	<del>connection Internal</del>	
<b>V e r s i o n</b>	RTS 12/24-130M	RTS 51130102R * RTS 71130102R	Single-phase	fan-cooled		FELX 304790 (p18)
	RTS 12/24-130T	RTS 53130102R * RTS 73130102R	Three-phase	fan-cooled	connection Internal	FELX 304745 (p19)
	RTS 20/40-130T	RTS 53130204R * RTS 753130204R	Three-phase	fan-cooled	connection Internal	FELX 304747 (p20)
	RTS 16/32-190T	RTS 53190103R * 753190103R	Three-phase	fan-cooled	connection Internal	FELX 304746 (p22)

\* With customisation card RZ6602

**RTS 2nd Generation SERVO AMPLIFIER**

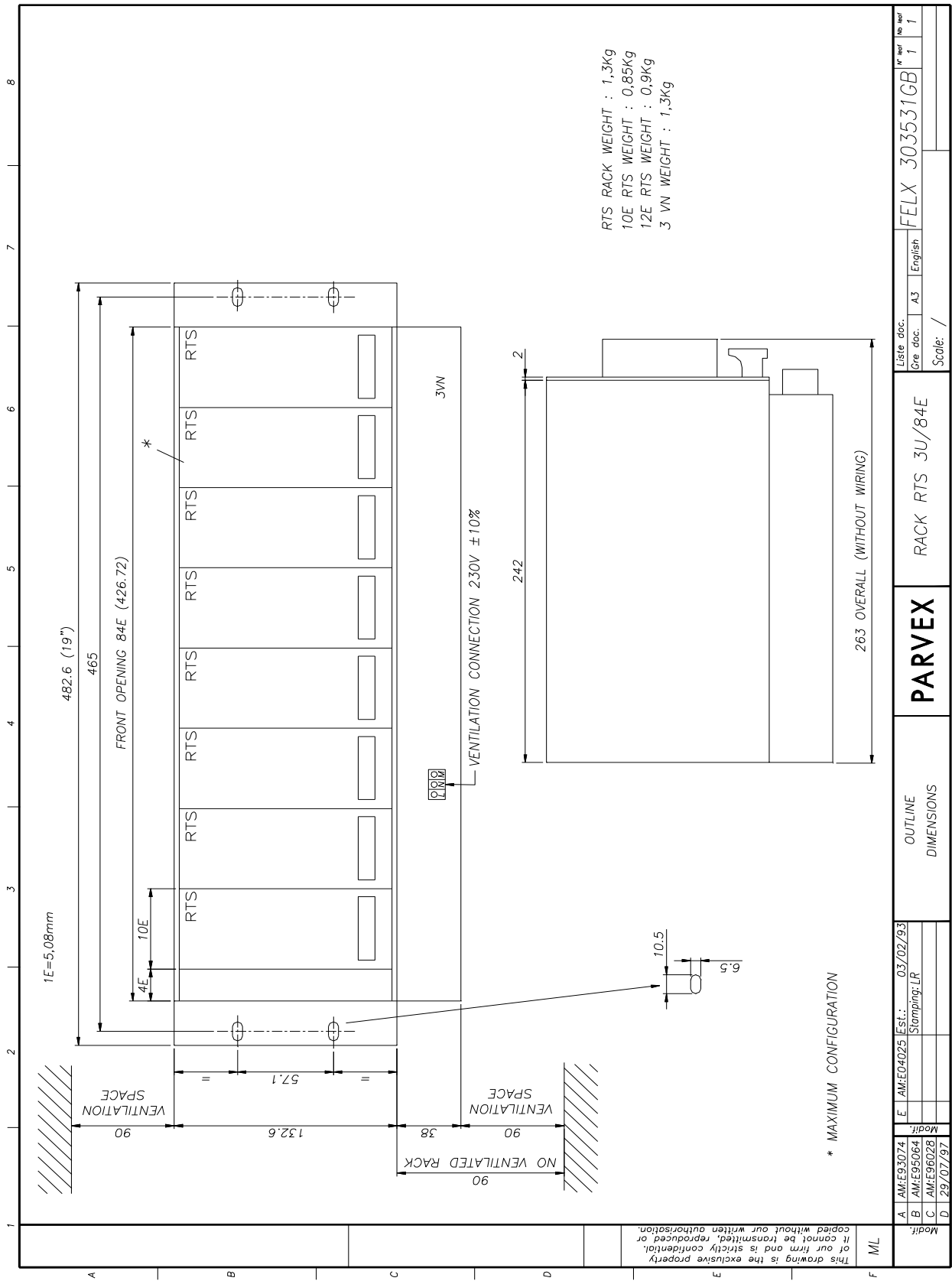

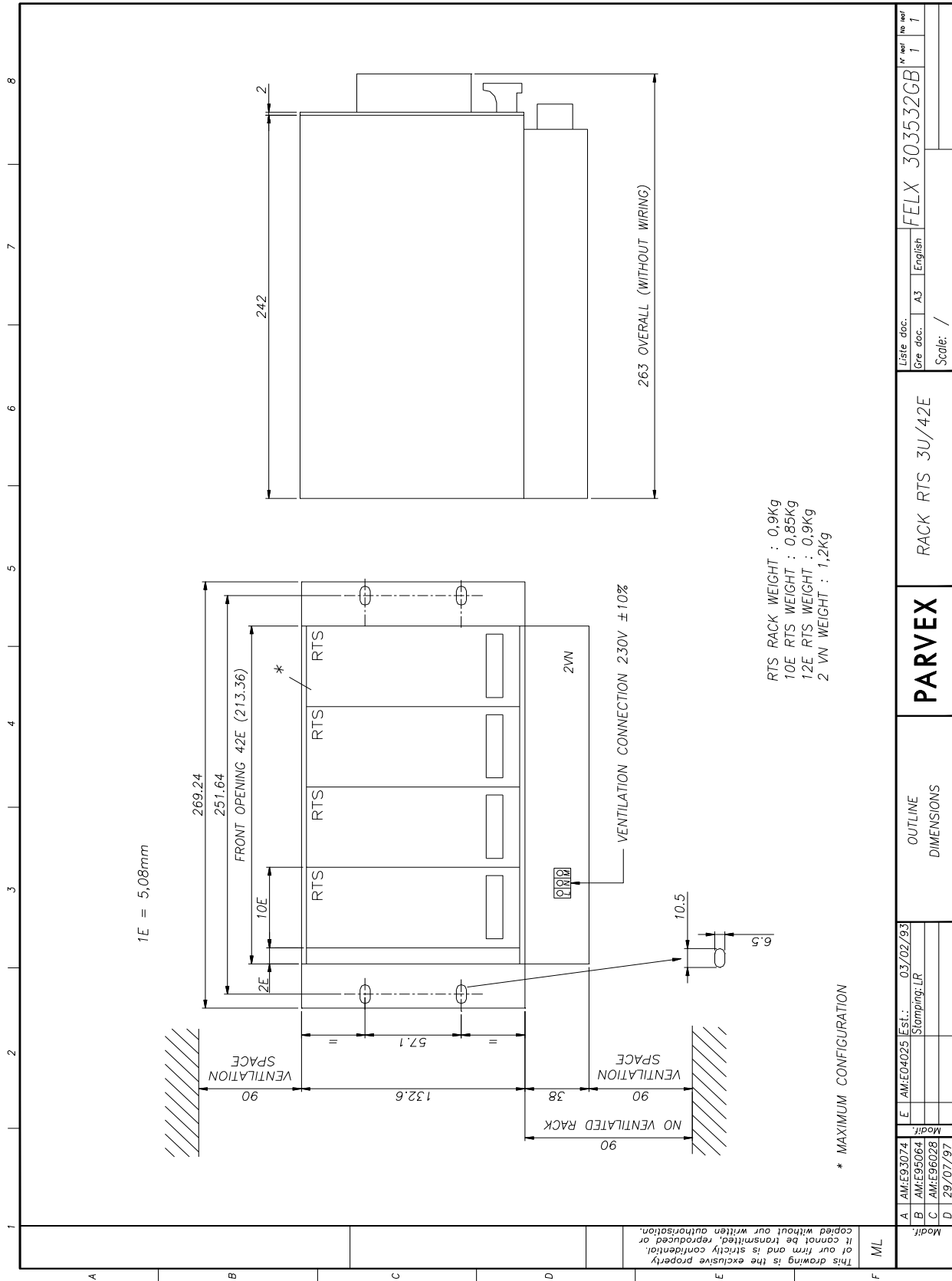

# RTS 2nd Generation SERVO AMPLIFIER

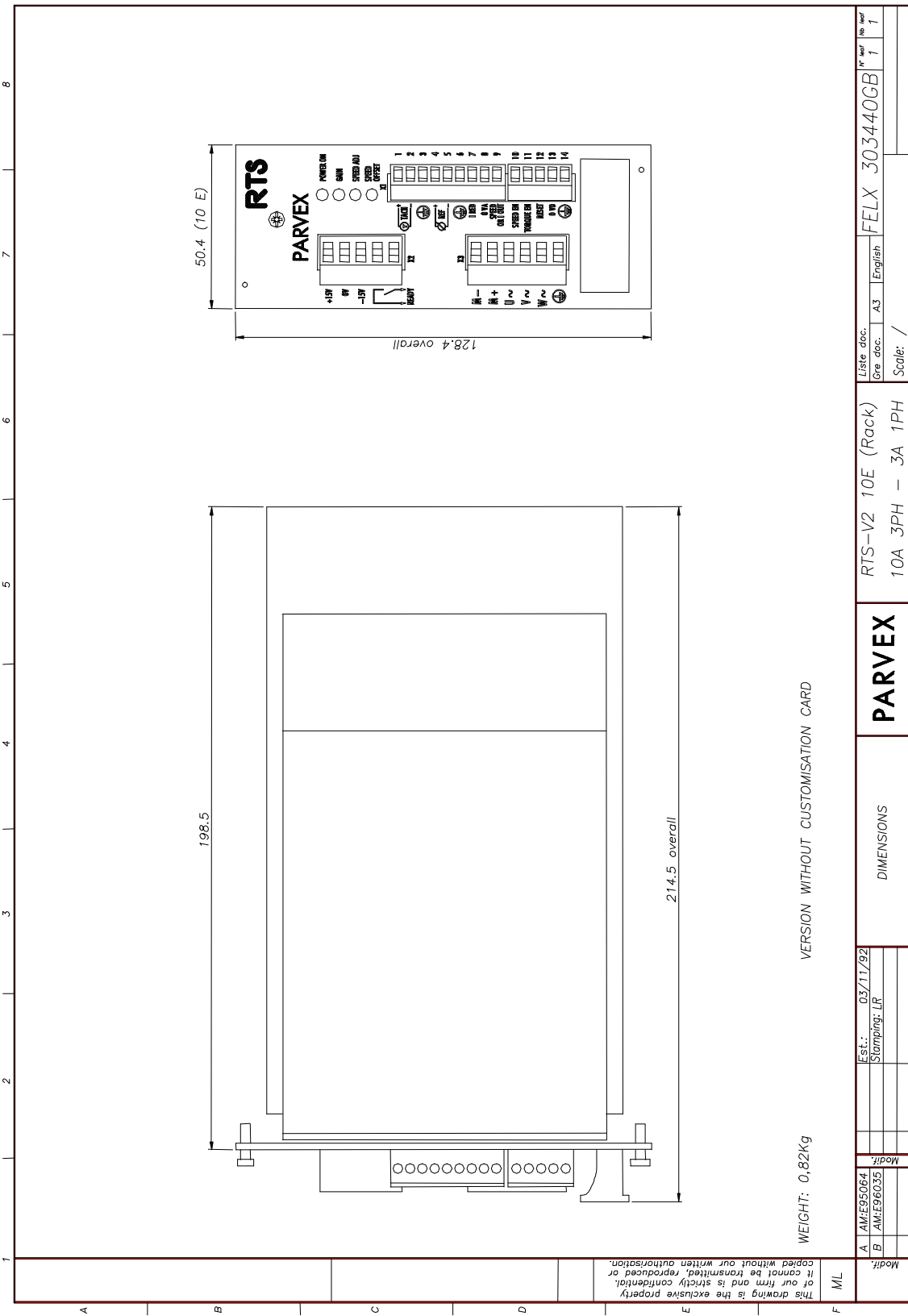

A AME95064		Est. 03/11/92	RTS-V2 10E (Rack)		Liste doc. Gra. doc.	English	3A	English	FELX 303440GB		1	1
B AME96035			10A 3PH - 3A 1PH						Scale: /			
Modif:		Stamping: LR		RTS-V2 10E (Rack)		3A		English		1		1
Modif:		Stamping: LR		10A 3PH - 3A 1PH		3A		English		1		1
Modif:		Stamping: LR		DIMENSIONS		3A		English		1		1
Modif:		Stamping: LR		VERSION WITHOUT CUSTOMISATION CARD		3A		English		1		1
Modif:		Stamping: LR		WEIGHT: 0,82Kg		3A		English		1		1
Modif:		Stamping: LR		This drawing is the exclusive property of our firm and is strictly confidential. It cannot be transmitted, reproduced or copied without our written authorisation.		3A		English		1		1

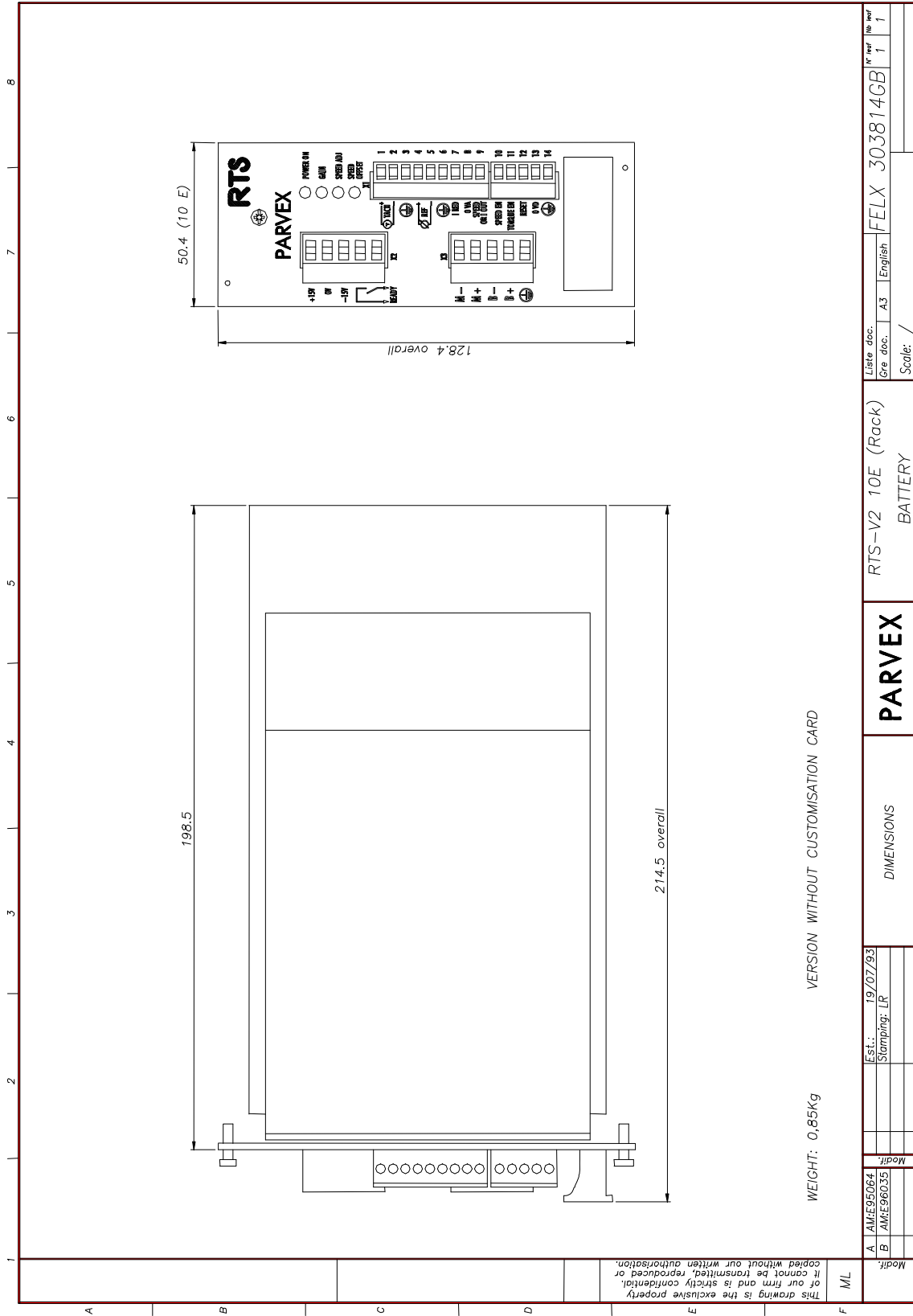

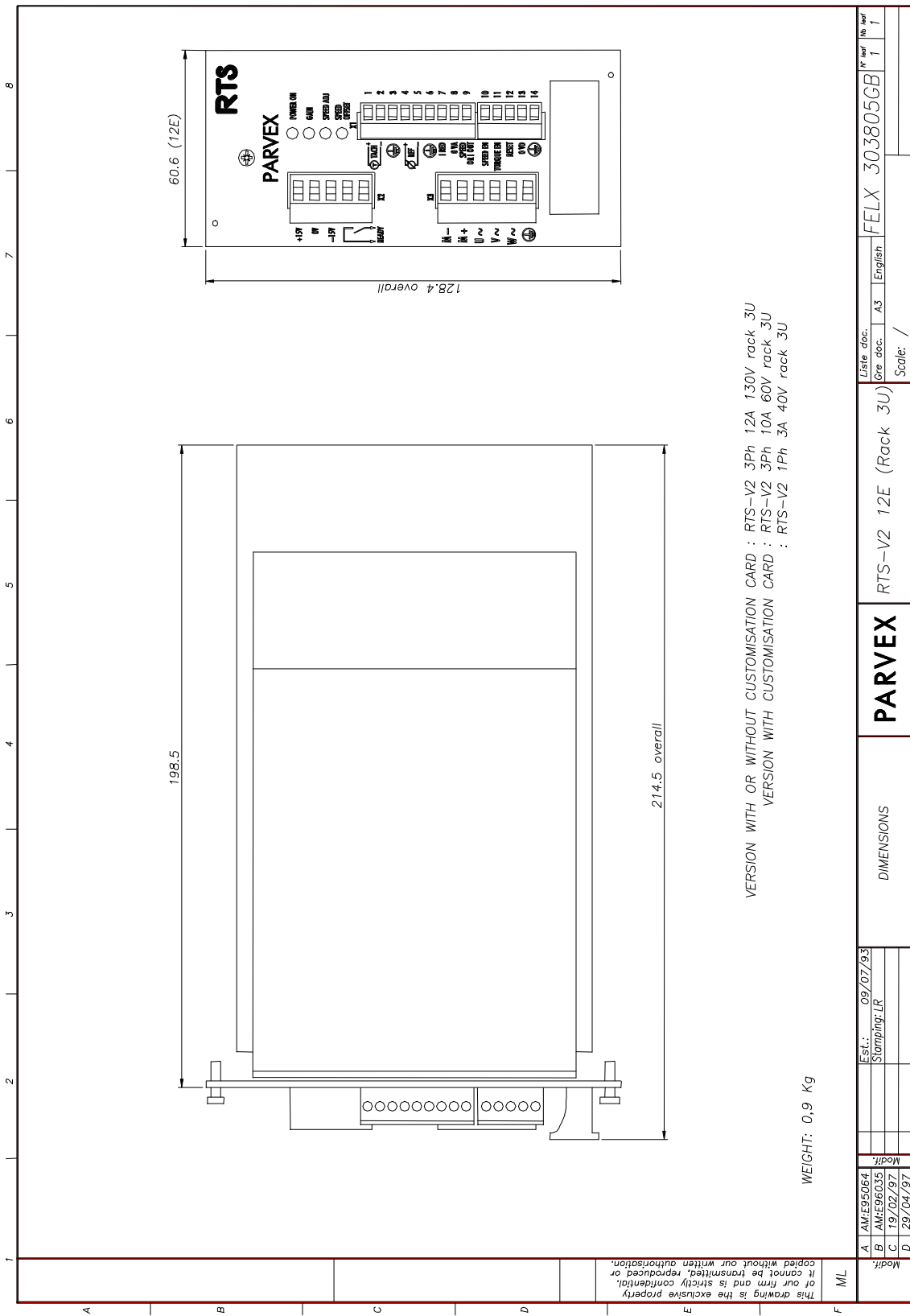





# RTS 2nd Generation SERVO AMPLIFIER

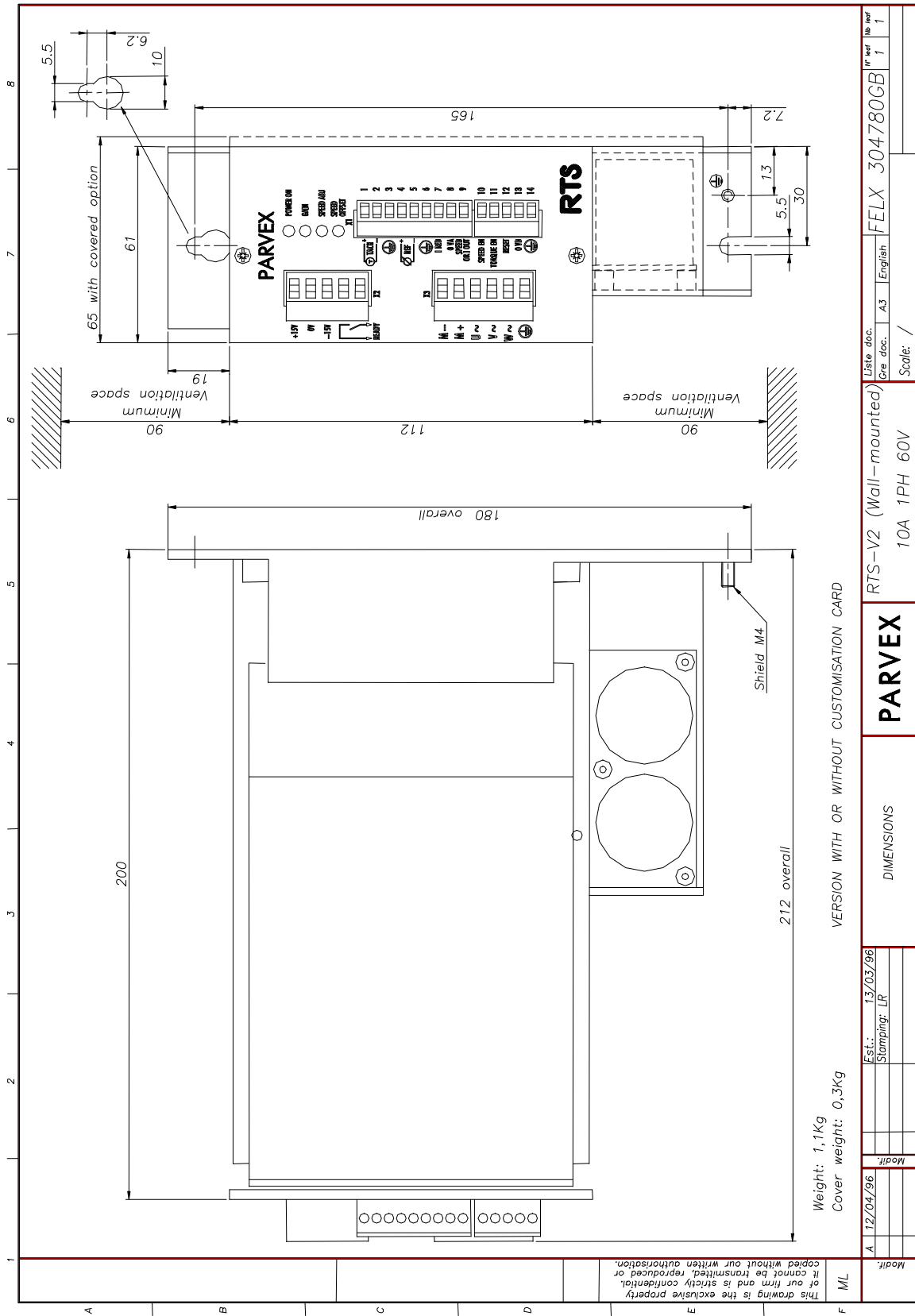

Weight: 1,1Kg  
Cover weight: 0,3Kg

VERSION WITH OR WITHOUT CUSTOMISATION CARD

ML	This drawing is the exclusive property of our firm and is strictly confidential. It cannot be transmitted, reproduced or copied without our written authorisation.	
A	Modif.	12/04/96
	Modif.	13/03/96
	Stamping	LR
DIMENSIONS		
<b>PARVEX</b>		
RTS-V2 (Wall-mounted)		
10A 1PH 60V		
Scale: /		
Liste doc. Cre. doc. English A3		
FELX 304780GB		
1/1 1/1 1/1		

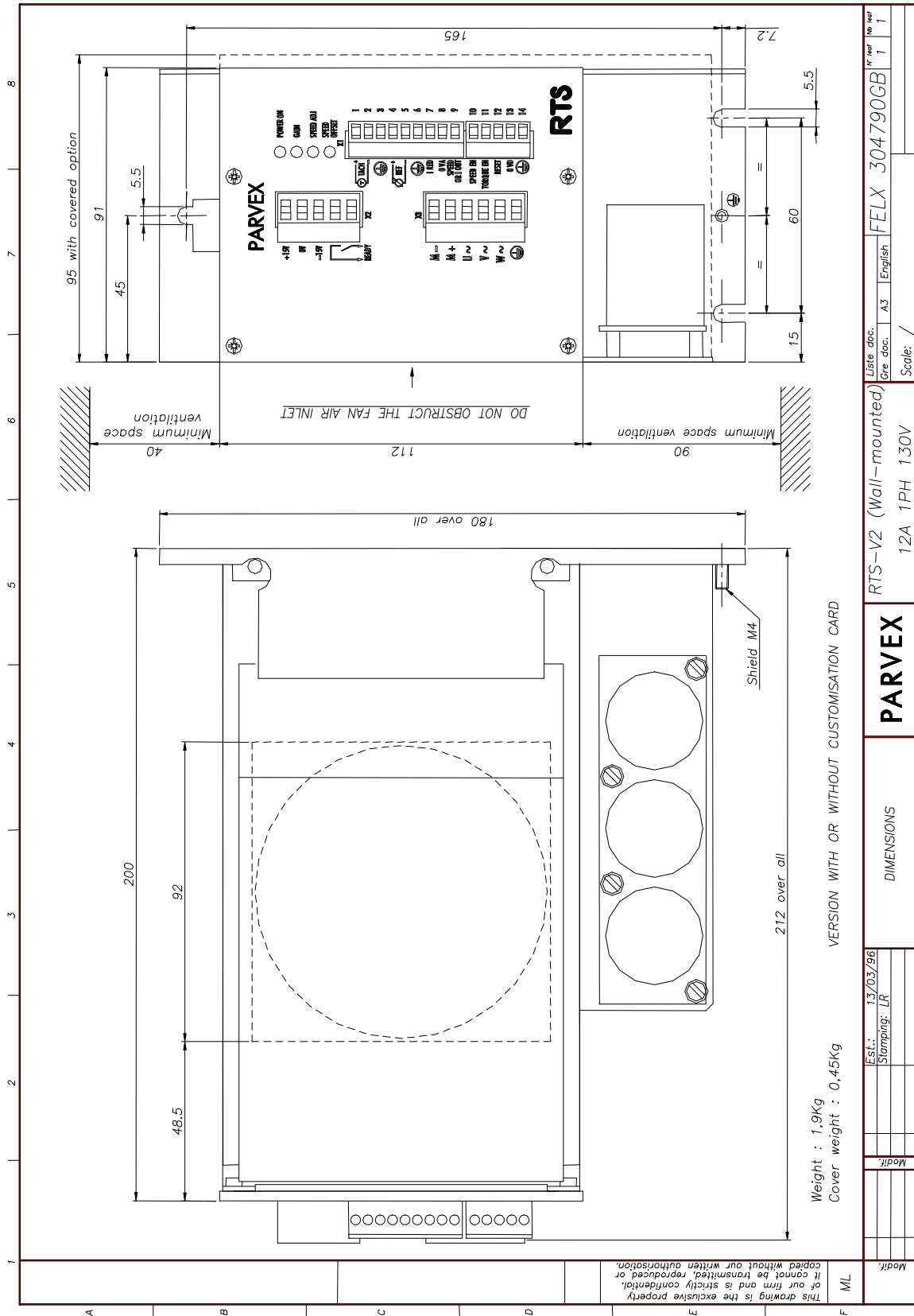

This drawing is the exclusive property of our firm and is strictly confidential. It cannot be transmitted, reproduced or copied without our written authorisation.

Weight : 1,9Kg  
Cover weight : 0,45Kg

VERSION WITH OR WITHOUT CUSTOMISATION CARD

Modif:											
Est.:	13/03/96										
Stamping:	LR										
Modif:											
DIMENSIONS											
RTS-v2 (Wall-mounted)											
12A, 1PH 130V											
FELX 304790GB											
English	A3										
Pre doc.											
Liste doc.											
No part	1										
No part	1										
Scale:	/										

# RTS 2nd Generation SERVO AMPLIFIER

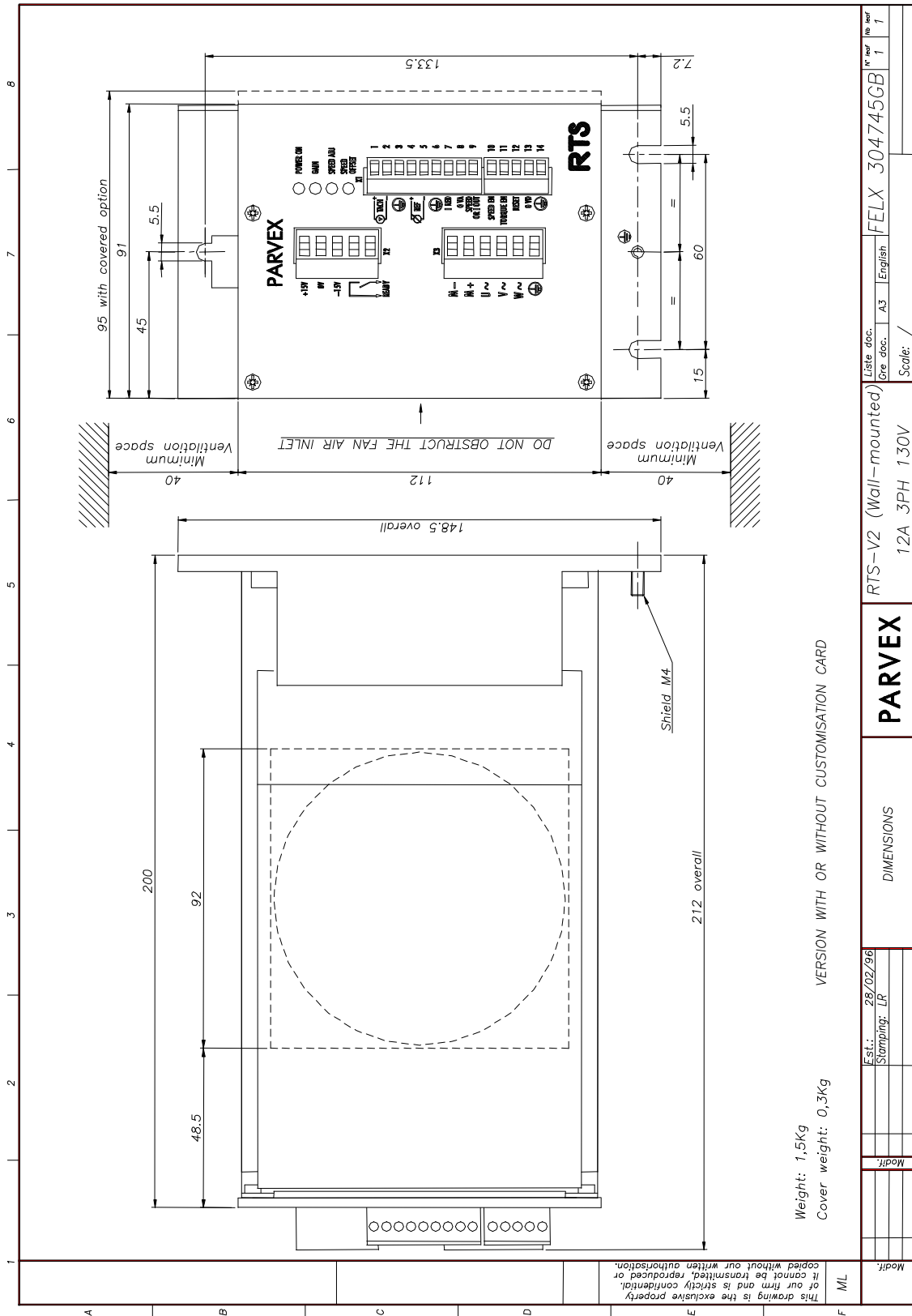

**RTS 2nd Generation SERVO AMPLIFIER**

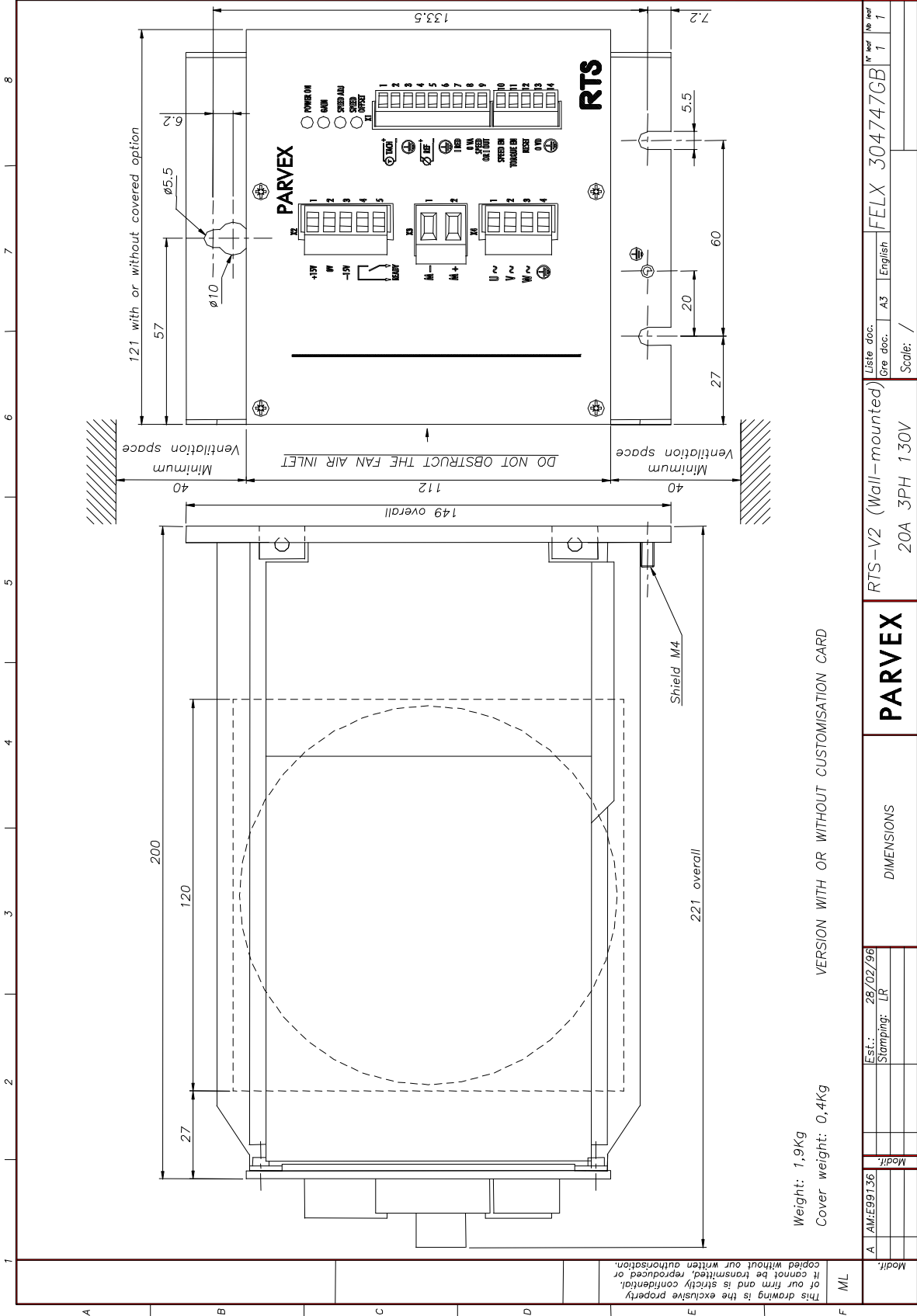

Weight: 1,9Kg  
 Cover weight: 0,4Kg

VERSION WITH OR WITHOUT CUSTOMISATION CARD

A AM: E997.36		Est.: 28/02/96		RTS-V2 (Wall-mounted)		Liste doc. / Gre doc. / A3		English		FELX 304747GB		No part / No part / 1 / 1	
Modif.				DIMENSIONS				PARVEX				Scale: /	
				Stamping: LR				20A 3PH 130V					

This drawing is the exclusive property of our firm and is strictly confidential. It cannot be transmitted, reproduced or copied without our written authorisation.

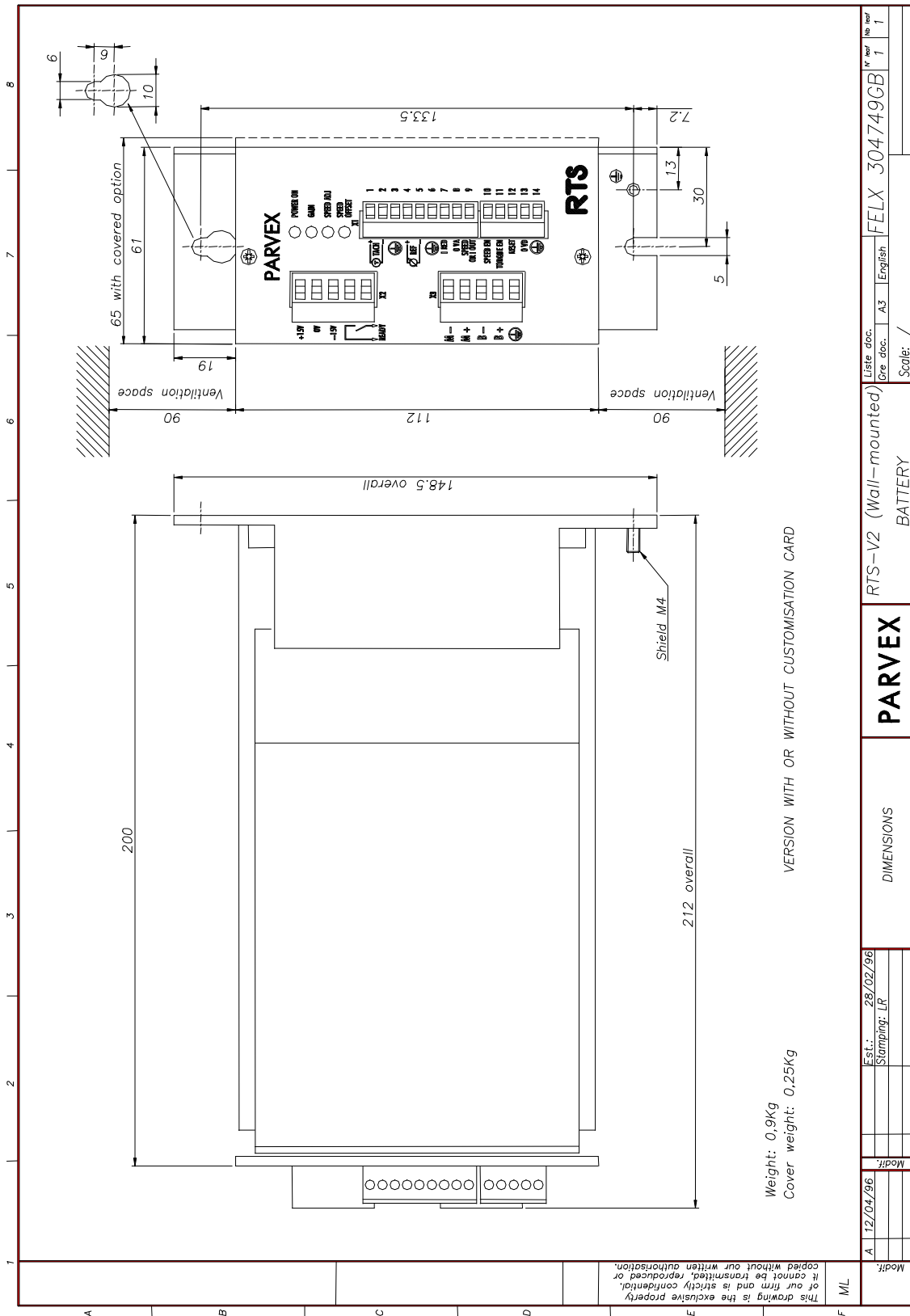

Weight: 0.9kg  
Cover weight: 0.25Kg

VERSION WITH OR WITHOUT CUSTOMISATION CARD

Modif.	A   12/04/96	Modif.	Est.: 28/02/96	Stamping: LR	RTS-V2 (Wall-mounted)	Liste des.			FELX 304749GB		No part	No part
						Gre doc.	A3	English	1	1		
PARVEX						BATTERY						
DIMENSIONS						Scale: /						

This drawing is the exclusive property of our firm and is strictly confidential. It cannot be transmitted, reproduced or copied without our written authorisation.

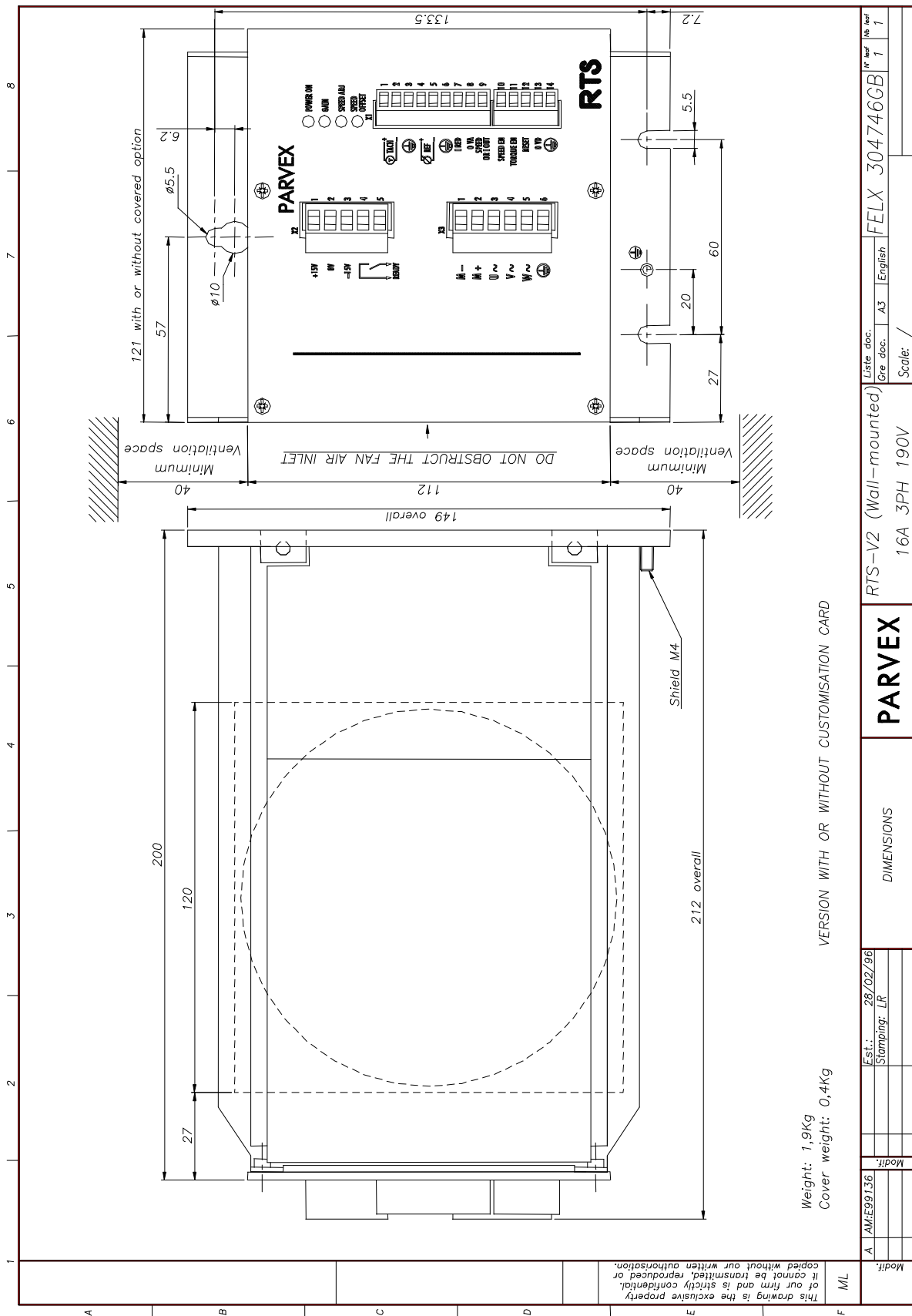

ML	This drawing is the exclusive property of our firm and is strictly confidential. It cannot be transmitted, reproduced or copied without our written authorization.			
Weight: 1,9Kg Cover weight: 0,4Kg VERSION WITH OR WITHOUT CUSTOMISATION CARD				
<b>PARVEX</b>		RTS-V2 (Wall-mounted)		
DIMENSIONS		16A 3PH 190V		
FELX 304746GB		Liste doc. / Gre doc. / A3 / English / Scale: /		
Modif. /		IV Rev / No Rev		

## 3.2 Labelling

### RTS SERVO AMPLIFIER IDENTIFICATION

Each RTS servo amplifier has an identification label affixed either on the metal plate at the rear for wall-mounted versions or on the side of the heat sink for rack versions. The information should be recorded and stored as with the information about the corresponding servo motor. Remember to record the "A" and/or "B" label indications too.

SPECIMEN LABEL :



- |   |                     |   |                     |
|---|---------------------|---|---------------------|
| ① | RTS code            | ② | Number of phases    |
| ③ | Input voltage (ac)  | ④ | Input current (ac)  |
| ⑤ | Output voltage (dc) | ⑥ | Output current (dc) |

The output voltage and current values correspond to those of the RTS model (as in RTS servo amplifier performance chart).

**A self-adhesive label is placed on the RTS front panel. Label "A" records :**

- N ----           :: servo amplifier serial number
- R-----       :: type of motor associated with RTS.
- DT-V            :: emf of tachometric dynamo for 1000 rpm.
- 10V ----TR     :: reference value corresponding to maximum motor speed in rpm (factory set).

Where the RTS is fitted with an **RZ 6602 customisation card**, some of these indications are recorded on the self-adhesive label on the customisation card (**label "B"**). This label also states the model of RTS.

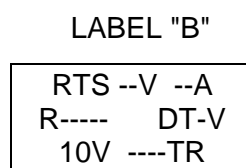
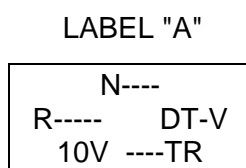



## 4. - ELECTRICAL CONNECTIONS

### 4.1 General Wiring Requirements

---

#### 4.1.1 Appliance handling

See the safety instructions given at the beginning of this manual. In particular, wait for all the front panel LEDs to go off completely before doing any work on the servo-amplifier or servomotor.

#### 4.1.2 Electromagnetic compatibility

##### EARTHING

Comply with all local safety regulations concerning earthing.

Utilize a metal surface as an earth reference plane (e.g. cabinet wall or assembly grid).

This conducting surface is termed the potential reference plate. All the equipment of an electrical drive system is connected up to this potential reference plate by a low impedance (or short distance) link. Ensure the connections provide good electrical conduction by scraping off any surface paint and using fan washers. The drive will then be earthed via a low impedance link between the potential reference plate and the earth screw at the back of the RTS. If this link exceeds 30 cm, a flat braid should be used instead of a conventional lead.

##### CONNECTIONS

Do not run low-level cables (resolver, inputs/outputs, NC or PC links) alongside what are termed power cables (power supply or motor). Do not run the power supply cable and the motor cables alongside one another otherwise mains filter attenuation will be lost. These cables should be spaced at least 10 cm apart and should never cross, or only at right-angles.

Except for the resolver signals, all low-level signals will be shielded with the shielding connected at both ends. At the RTS end, the shielding is made continuous by the Sub-D connector mechanism.

The motor cables are limited to the minimum functional length. The yellow and green motor cable lead must be connected to the box or front panel terminal block with the shortest possible link.

This usually means shielded motor cable is not required. Chokes may also be inserted into the motor phase leads.

### MAINS FILTERING

The mains filter must be mounted as close as possible to the potential reference plate between the mains and the power supply (p.46 and 47). Use shielded cable (or run the cable in metal trunking).

Avoid running cables together, ahead of and after the filter.

Filters sometimes have high leakage currents. In this case, comply with the standard connection diagrams when fitting them.

### OTHER MEASURES

Self-inducting components must be protected against interference: brakes, contactor or relay coils, fans, electro-magnets, etc.

## 4.2 RTS Servo amplifier connection

---

As a supplement to the block diagram, see the appended diagrams :

- |  |                    |
|--|--------------------|
| - RTS single-phase                                 | FELX 303346 (p.26) |
| - RTS three-phase                                  | FELX 303261 (p.27) |
| - RTS battery                                      | FELX 303738 (p.28) |
| - Connecting several RTEs or RTSs with transformer | FELX 305823 (p.29) |

The terminal block description and terminal functions are shown in the following pages :  
The RTS servo amplifiers are factory set to match the characteristics of the servo motor to be used or the application where known.

When the servo motor is fitted with a brake, adhere to the following activating sequence :

- Limit current (to a value less than the RTS setting),
- Engage brake,
- Cut RTS servo amplifier.

To restart, proceed as follows :

- limit current (as above),
- energise RTS,
- release brake,
- remove current limitation.

# RTS 2nd Generation SERVO AMPLIFIER

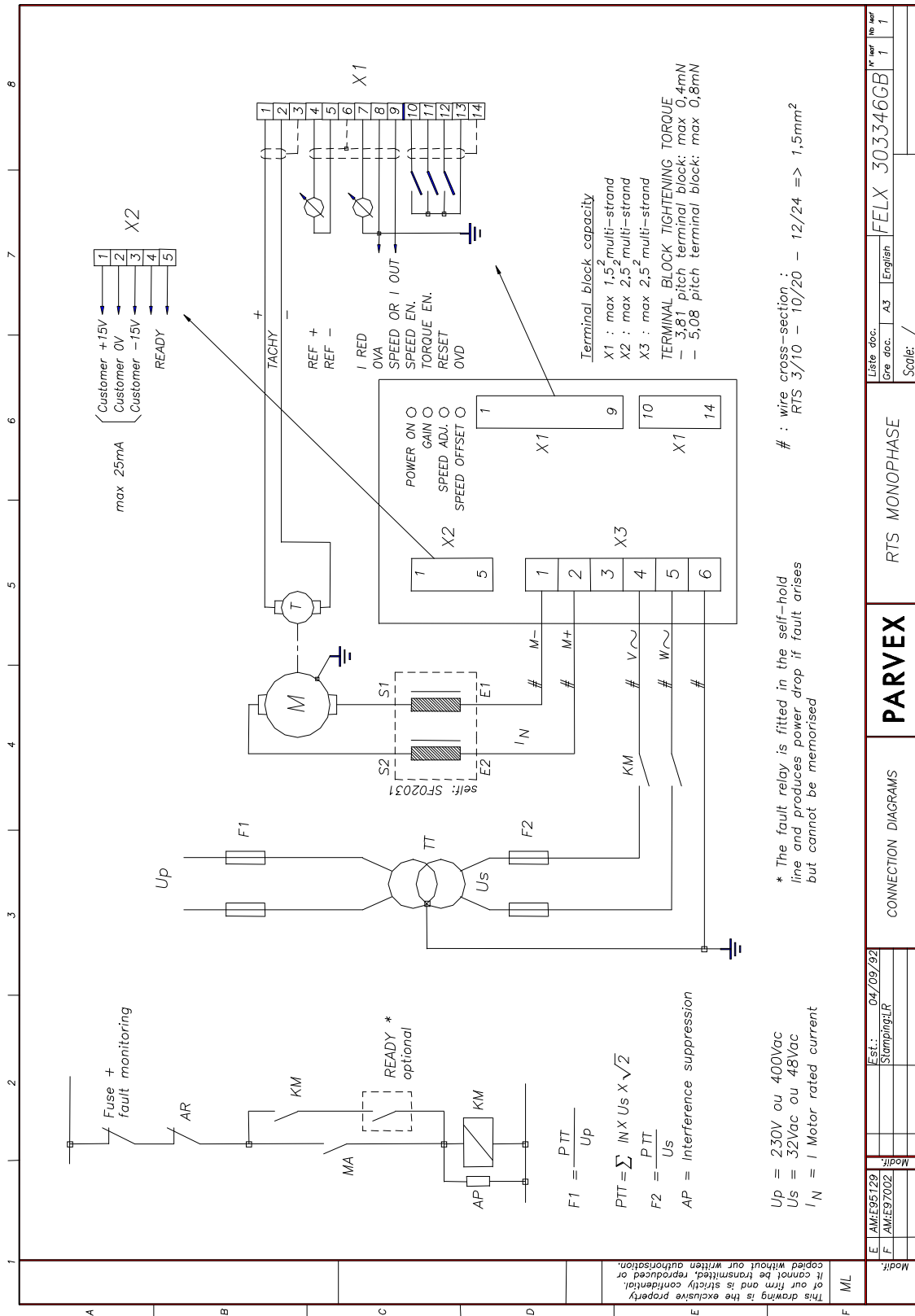

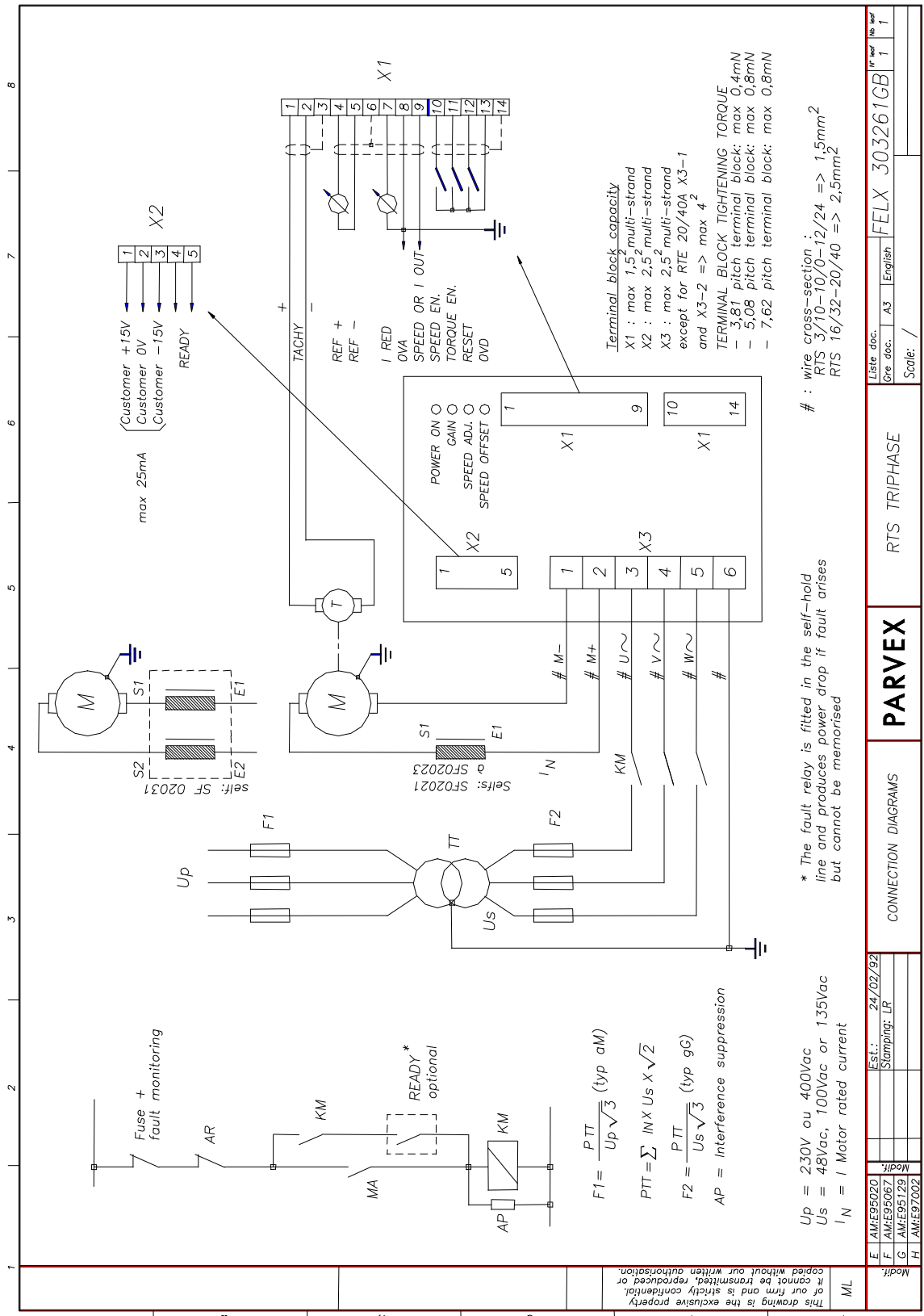

ML	This drawing is the exclusive property of our firm and is strictly confidential. It cannot be transmitted, reproduced or copied without our written authorization.	
E	AM/E95020	Est.: 24/02/92
F	AM/E95067	Stamping: LR
G	AM/E95129	Modif:
H	AM/E97002	Modif:
CONNECTION DIAGRAMS		RTS TRIPHASE
PARVEX		FELX 303261GB 1 1
Litre doc. A3 English		Scale: /

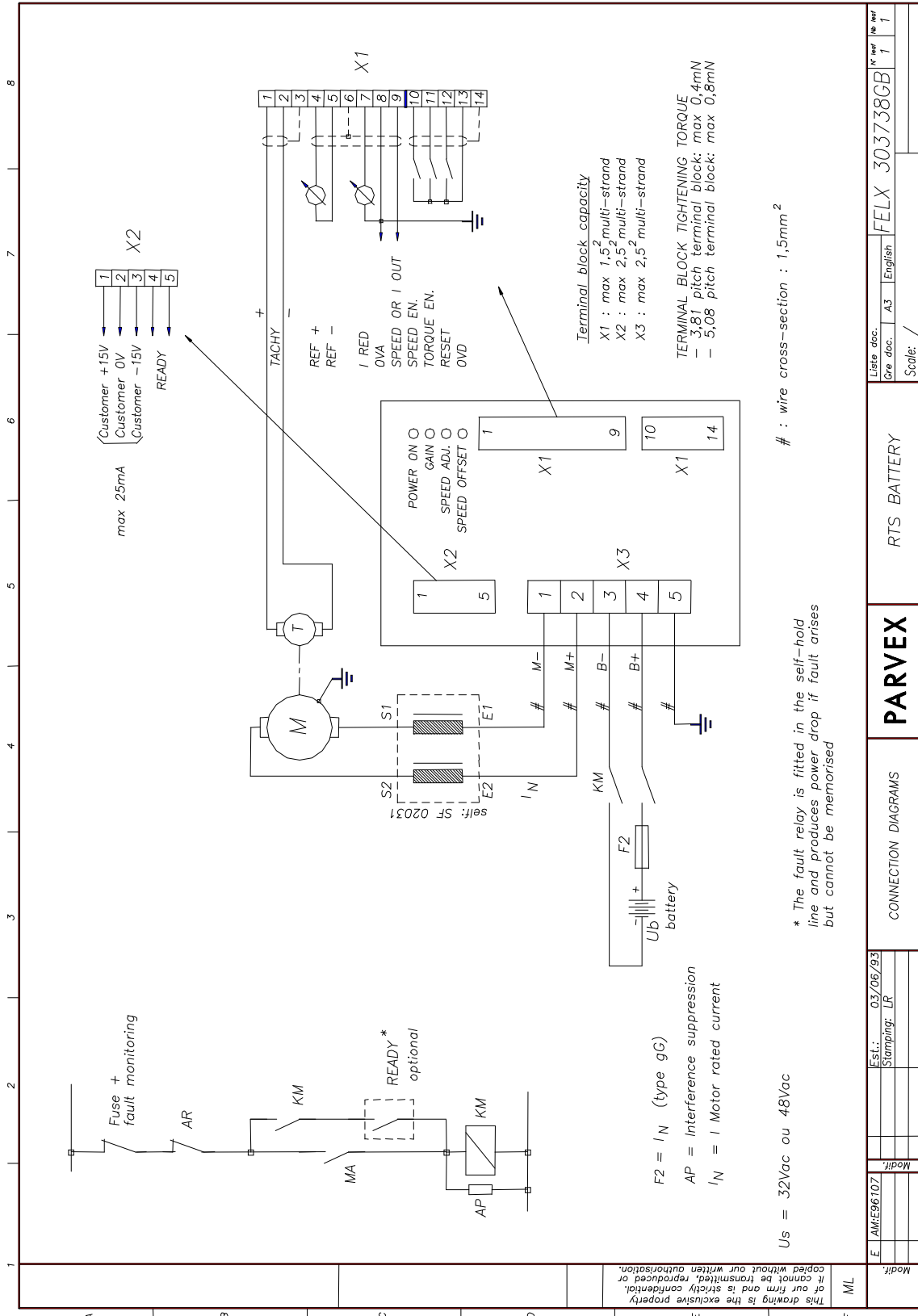

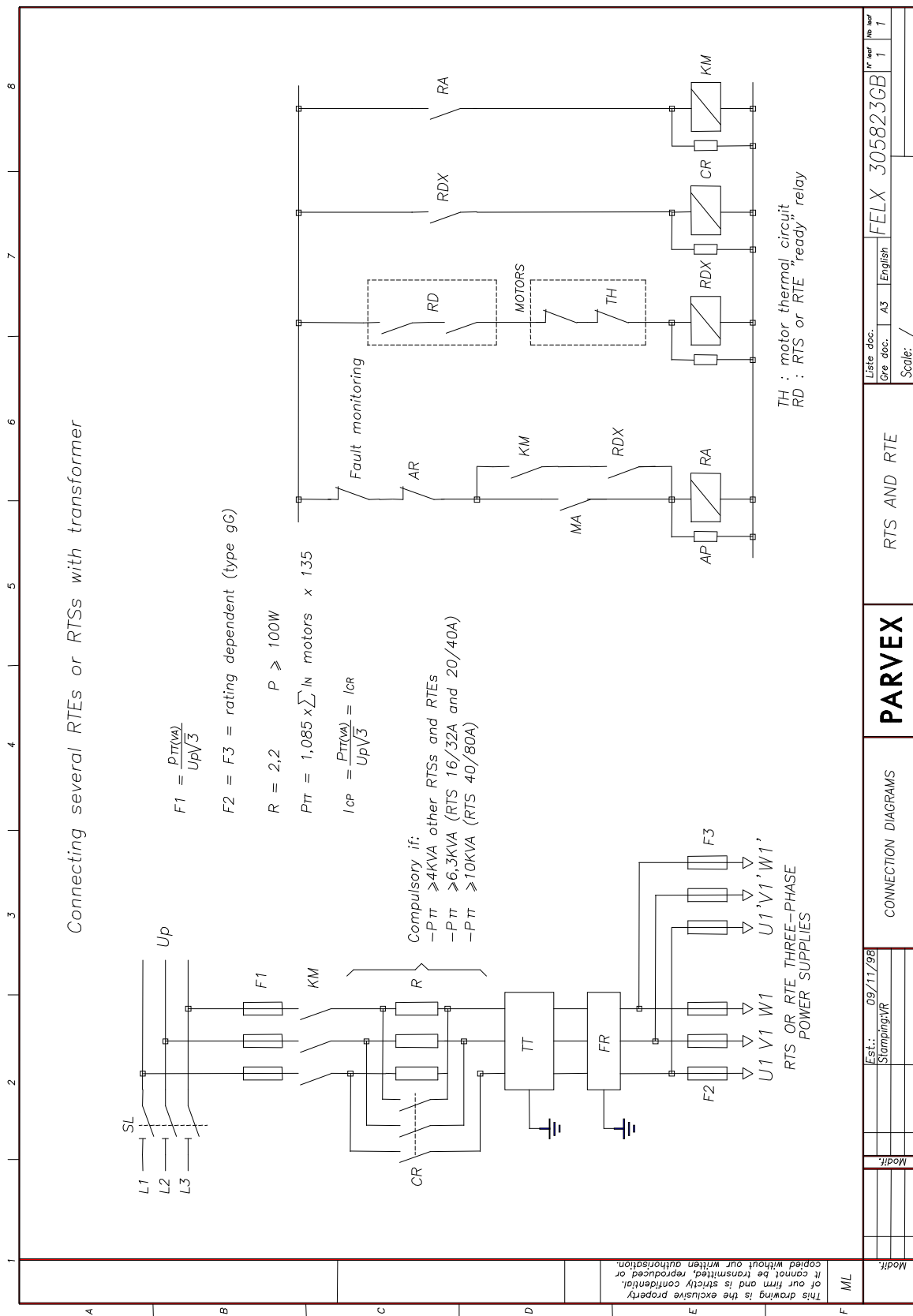

M/L	Modif:	Est.: 09/11/98	Stamping/R	CONNECTION DIAGRAMS	PARVEX	RTS AND RTE	Liste doc. / Cre doc. / Scale: /	FELX 305823GB	No part / 1
-----	--------	----------------	------------	---------------------	--------	-------------	--	---------------	----------------

This drawing is the exclusive property of our firm and is strictly confidential. It must be transmitted, reproduced or copied without our written authorization.

### 4.3 Front Panel

RTS V2 Battery (Rack)

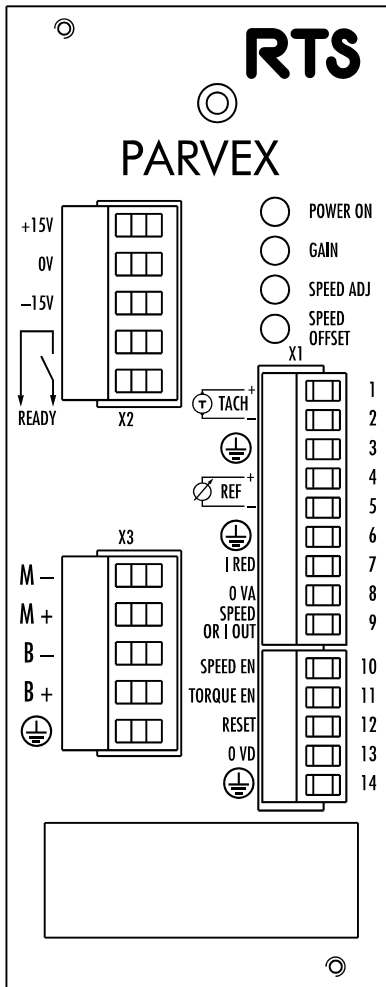

RTS V2 Battery (wall-mounted)

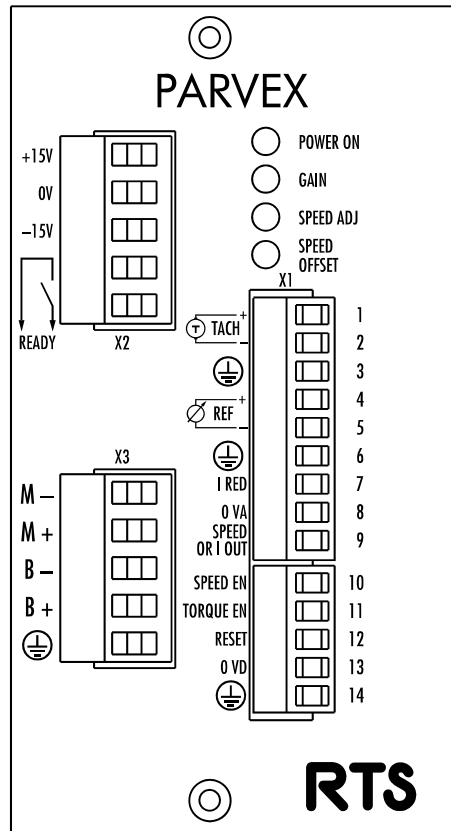

RTS V2 10 E (Rack)

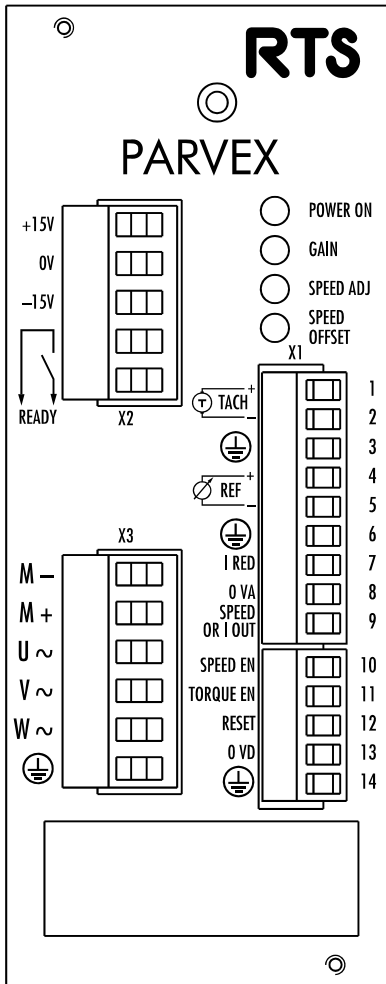

RTS V2 12 E (Rack)

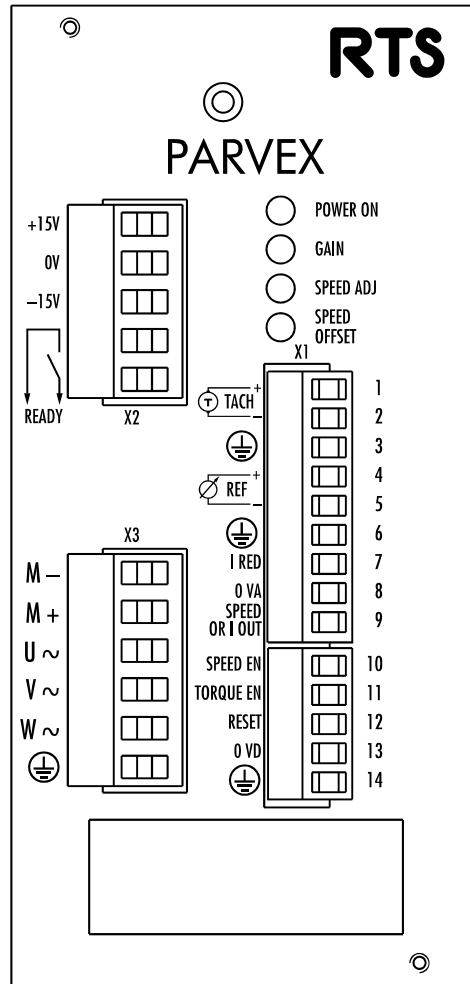



RTS V2 12 E (wall-mounted)

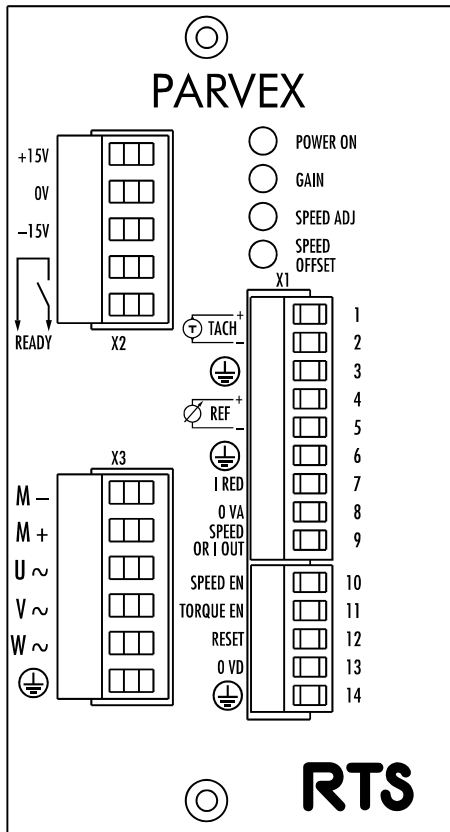

RTS V2 12 A / 130V (wall-mounted)  
1PH and 3PH

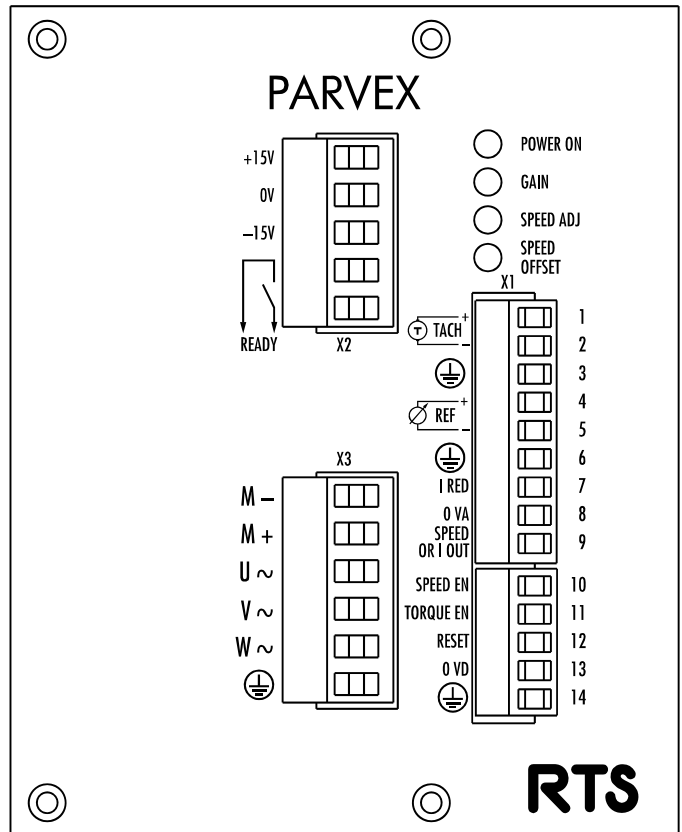

RTS V2 16 A / 190 V (wall-mounted)

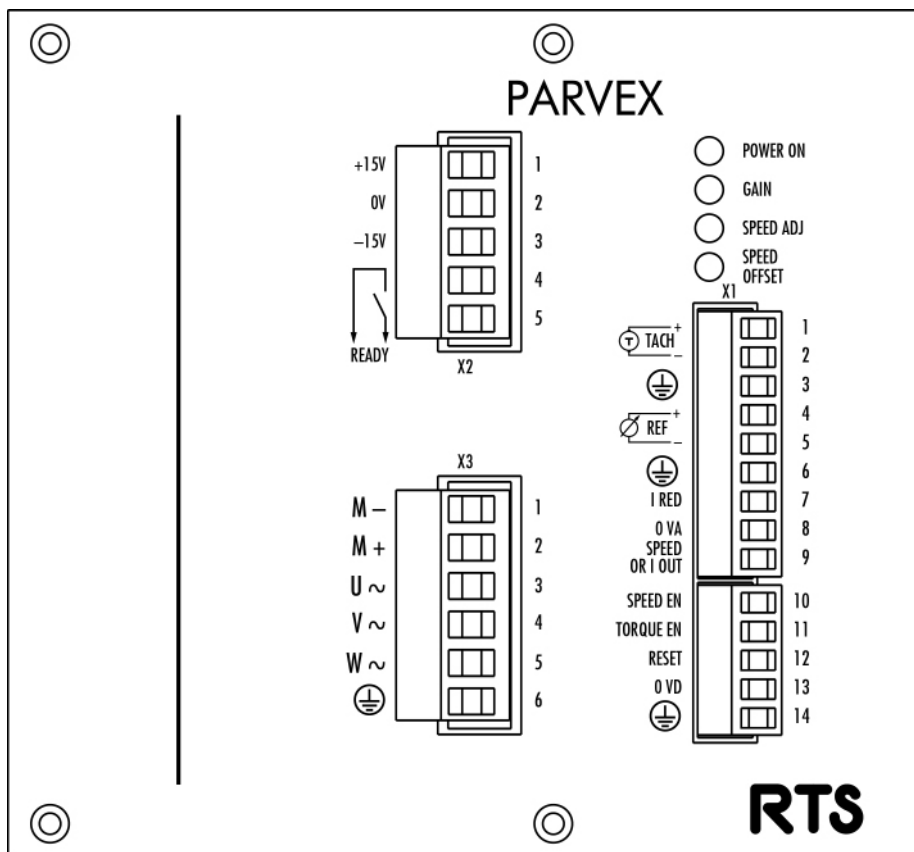

RTS V2 20 A / 130 V (wall-mounted)

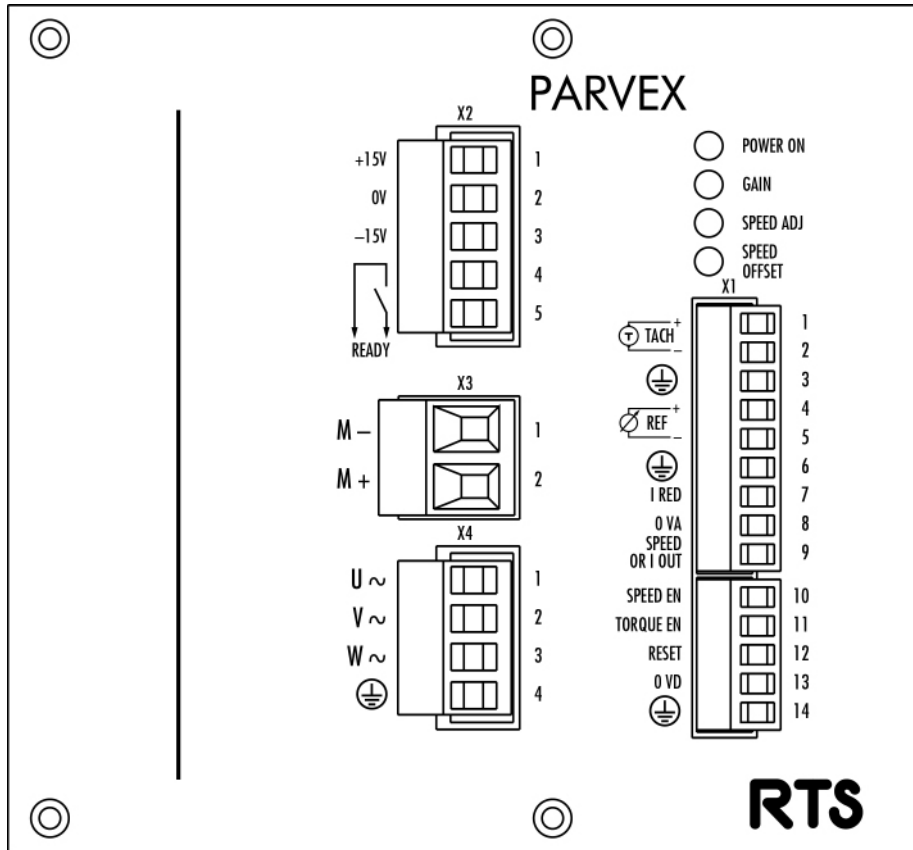

## 4.4 Terminal blocks X1, X2 AND X3

**Torque value :** terminal block X1, 0.4 Nm      terminal blocks X2 and X3, 0.8 Nm.

**Terminal block X1 front panel connection**      Recommended cable cross-section : 0.5 mm<sup>2</sup> -  
- 1.5 mm<sup>2</sup> multi-strand. Use shielded cables with the shielding connected as stated below.

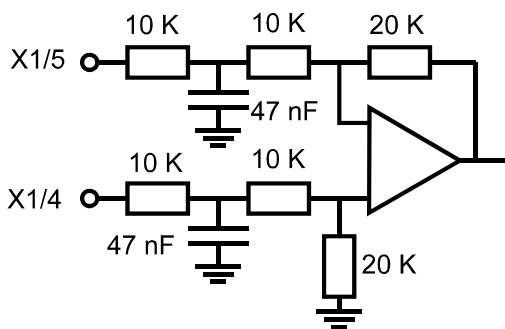
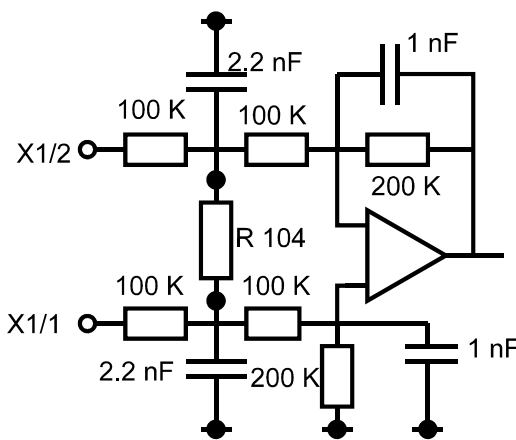

TERMINAL		DESCRIPTION
N°	NAME	
1	TACH+	Tacho differential inputs. Use shielded cable with shielding connected to terminal 3. Input voltage must not exceed 100 V.
2	TACH-	
3		Tachometric cable shielding. Do not connect shielding at tacho end.
4	REF+	Speed or current differential reference depending on position of selector switch S1. ± 10 V corresponds to rated motor speed at speed reference.
5	REF-	
6		Shielding, to be connected at numerical control end also.

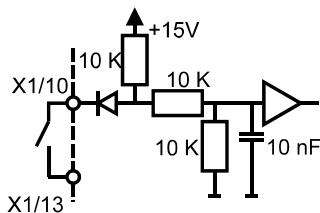
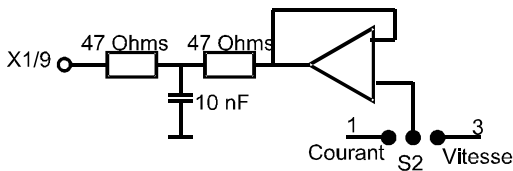
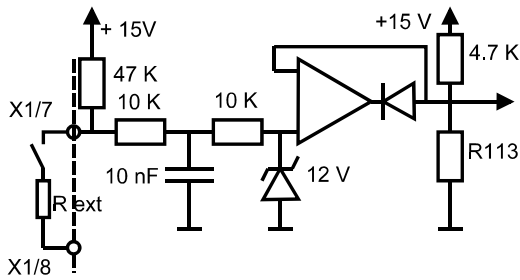

TERMINAL		DESCRIPTION															
N°	NAME	TERMINAL BLOCK X1															
7	I RED	I	<p>Analogue reduction of current. Reduction may be controlled either by voltage or by resistor between 7 and 8. This input may be used for example when the servo motor is against a mechanical abutment. Resistor value :</p> <table border="1"> <tr> <td>% I max</td> <td>10</td> <td>30</td> <td>50</td> <td>70</td> <td>90</td> <td>100</td> </tr> <tr> <td>R(KΩ)</td> <td>3.32</td> <td>10</td> <td>22,1</td> <td>39.2</td> <td>56.2</td> <td>infinity</td> </tr> </table>	% I max	10	30	50	70	90	100	R(KΩ)	3.32	10	22,1	39.2	56.2	infinity
% I max	10	30	50	70	90	100											
R(KΩ)	3.32	10	22,1	39.2	56.2	infinity											
8	0 VA	-	0 V reference to be connected internally in the casing														
9	SPEED OR I OUT	O	<p>Signal providing speed or current image depending on selector switch S2 position. ± 10 V corresponds to max speed or current value. (Pulse current value shown in RTS characteristics chart). See also identification section. Typical uses : motion synchronisation, master-slave mode, cutting tool wear monitoring...</p>														
10	SPEED EN.	I	To be connected via an external contact to terminal 13 to enable speed reference. Typical uses : limit switch, emergency stop														

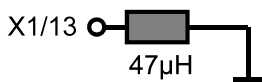
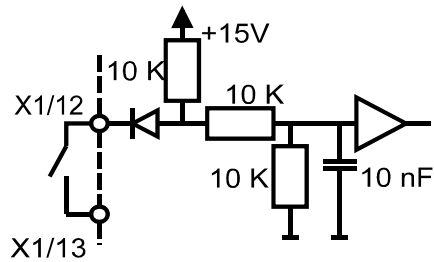
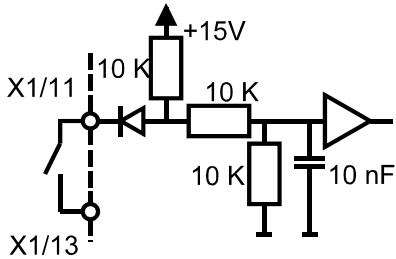

TERMINAL		DESCRIPTION
N°	NAME	
<b>TERMINAL BLOCK X1</b>		
11	TORQUE EN.	I To be connected via an external contact to terminal 13 to enable current; if terminal is not connected, the motor free wheels. When the motor is fitted with a holding brake, synchronise control of this input with brake control.
12	RESET	I Reset. By connecting RESET to terminal 13, faults are cleared and the axis is ready again (if fault has been corrected). Switching the RTS off and then back on has the same effect as RESET.
13		- Logic 0 V, to be connected to terminals 10, 11 and 12 via control contacts.
14		- Logic connection cable shielding (terminals 10, 11 and 12).

## 4.5 Terminal block X2 connection

Recommended cable cross-section : 0.5 - 1.5 mm<sup>2</sup>

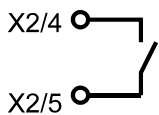
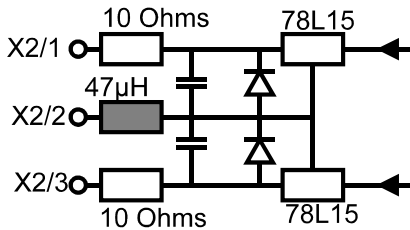

TERMINAL		DESCRIPTION	
N°	NAME	TERMINAL BLOCK X2	
1	+15 V	○	± 15 V (25 mA) available for external applications.
2	0V	-	
3	-15V		
4	READY	○	Output via contact of sum of faults. Contact opens if fault or mains failure occurs. Permissible current : 0.5 A
5	READY	○	Permissible voltage : 220 V ac

## 4.6 Terminal block X3 connection

Recommended cable cross-section :

RTS 3/10 : 1.5 mm<sup>2</sup>; RTS 10/20, 12/24, 16/32, 20/40 : 2.5 mm<sup>2</sup>

TERMINAL		DESCRIPTION	
N°	NAME	TERMINAL BLOCK X3	
1	M-	○	Motor connection, cable cross-section to be used (see motor dimensions section). Minimum motor inductance must be 0.4 to 1 mH depending on RTS rating.
2	M+		
3	U ≈	I	Phase U of three-phase supply. For single-phase supply, this input is not connected.
4	V ≈	I	Phase V.
5	W ≈	I	Phase W
6		-	Ground to be wired to cabinet ground rod by minimum 2.5 mm <sup>2</sup> lead.

## 4.7 Accessories

### 4.7.1 Plug-in Customisation card

The RTS includes a number of components for customising the axis. These components are mounted as standard on the control card and may be mounted on a plug-in customisation card as an option. This means a wider rack version of RTS 3/10-40M, RTS 10/20-60 three-phase and RTS 12/24 Battery (front panel width increased from 51 mm to **61 mm**).

RAMP (Card RG 6601)

The ramp comes as a separate card that plugs into the RTS front panel. The card is also an extension to terminals X1/1 to X1/9 of terminal block X1.

The  $\pm 15$  V available on RTS terminal X2 is used to power the card.

The card protrudes from the RTS by 62 mm. It is 36 mm high and 13 mm wide.

Adjustment : The ramp can be adjusted by potentiometers between 0.06 sec/Volt and 0.6 sec/Volt.

Reference	Minimum time	Maximum time
0 - 5V	0.3 sec	3 sec
0 - 10V	0.6 sec	6 sec

X1 RG 6601		X2 RG 6601	
X1/1 X1/2	Tacho inputs	X2/1	+15 V (to be connected to X2/1)
X1/3	shielding	X2/2	0V (to be connected to X2/2)
X1/4 X1/5	Speed reference inputs	X2/3	-15V (to be connected to X2/3)
X1/6	shielding		
X1/7	Analogue inputs reduction of current		
X1/8	0 VA		
X1/9	Analogue Output speed or current value		

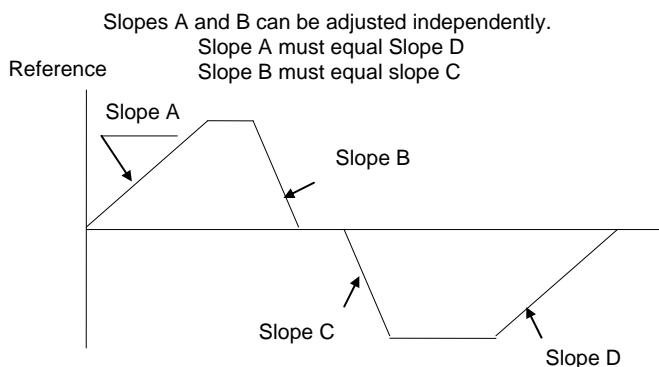

### 4.7.2 Extra choke

The extra choke is connected between the RTS and the servo motor, as near as possible to the RTS. It must be used when the servo motor choke is less than the values in the table on page 7. It should also be used when the RTS and servo motor are more than 50 m apart (or 25 m where shielded cable is used).



**Recommended combinations :**

RTS 3/10-40M single-phase  
 RTS 10/20-60 single-phase  
 or three-phase

SF020231 12A-2x0.25 mH  
 drawing FELX 303434 (p.42).

RTS 12/24-130T three-phase  
 RTS 20/40-130T three-phase  
 RTS 16/32-190T three-phase

SF02023 25A-1.5 mH drawing FELX 302804 (p.41).  
 SF02022 16A-2.5 mH drawing FELX 302804 (p.41).

**4.7.3 Transformer**

**General specifications**

- Power supply 230/400 V - 50/60 Hz - single-phase or three-phase depending on model.
- Neutral brought out for three-phase models.
- Secondary with  $\pm 5\%$  taps (except two models of drawing FELX 303740 (p.45))
- Voltage drop between load and off-load  $\leq 5\%$

**Recommended combinations**

SERVO AMPLIFIER MODEL	NUMBER	TRANSFORMER POWER (VA)	CODE	DRAWING	P
RTS 3/10-40M single-phase	1	120	TT 11133	FELX 303593	43
RTS 3/10-40M single-phase	2 to 4	630	TT 11134	FELX 303593	43
RTS 10/20-60M single-phase	1	630	TT 11135	FELX 303593	43
RTS 10/20-60T three-phase	1	500	TT 11136	FELX 303594	44
RTS 10/20-60T three-phase	2 to 3	1600	TT 11137	FELX 303594	44
RTS 12/24-130T three-phase	1	1600	TT 11139	FELX 303740	45
RTS 12/24-130T three-phase	2	4000	TT 11141	FELX 303740	45
RTS 20/40-130T three-phase	1	2500	TT 11140	FELX 303740	45
RTS 16/32-190T three-phase	1	4000	TT 11118	FELX 302570	46
RTS 16/32-190T three-phase	2	6300	TT 11119	FELX 302570	46
RTS 16/32-190T three-phase	3	10000	TT 11120	FELX 302570	46

**4.7.4 Mains filter**

**Choice of filters :**

FILTER	SERVOAMPLIFIER
<b>FR13020</b> as per drawing PARVEXFELX305144 (p.47)	RTS 3/10-40 RTS 10/20-60 RTS 12/24-130 RTS 20/40-130
<b>FR03016</b> as per drawing PARVEX FELX304967 (p.48)	RTS 16/32-190

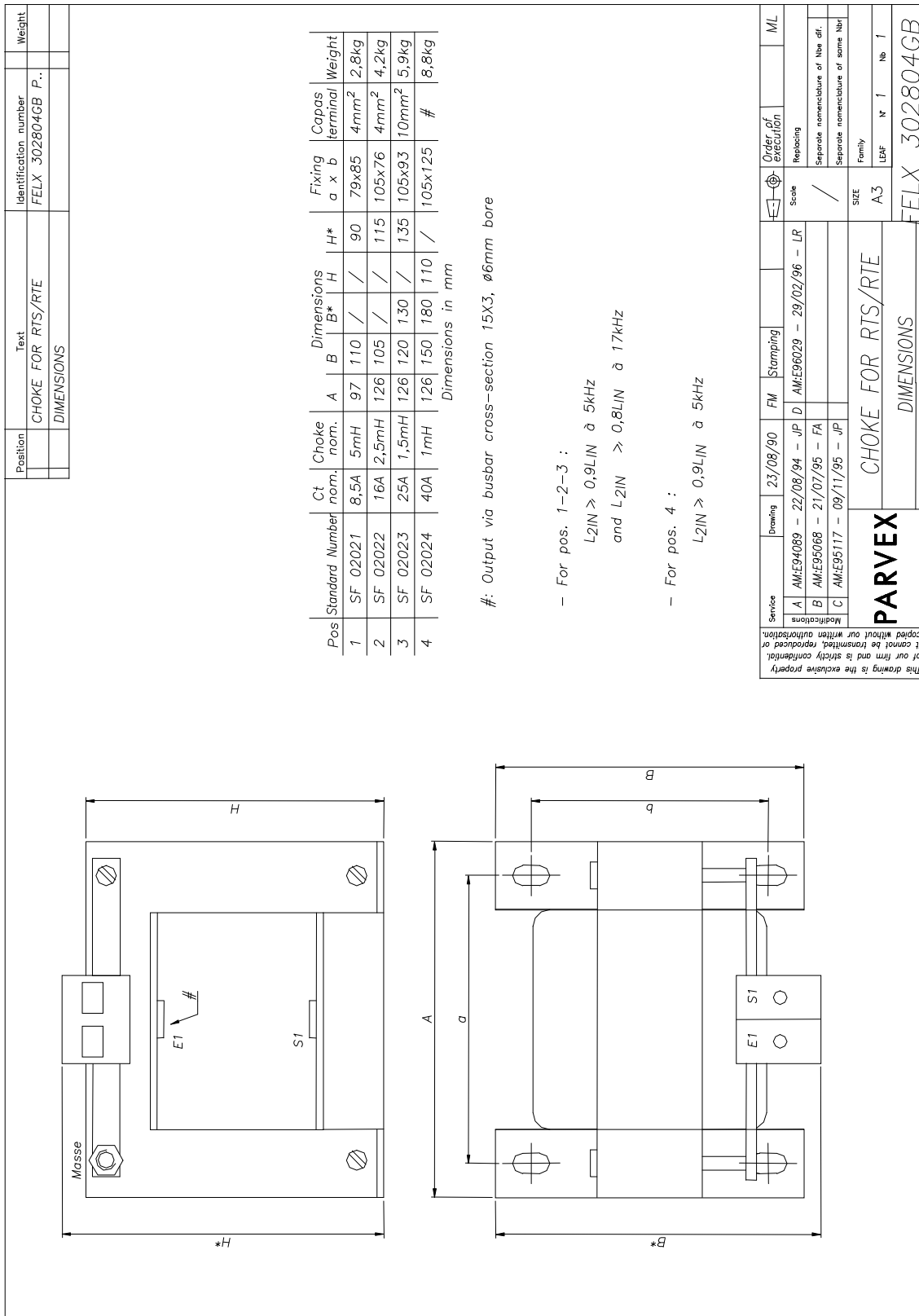

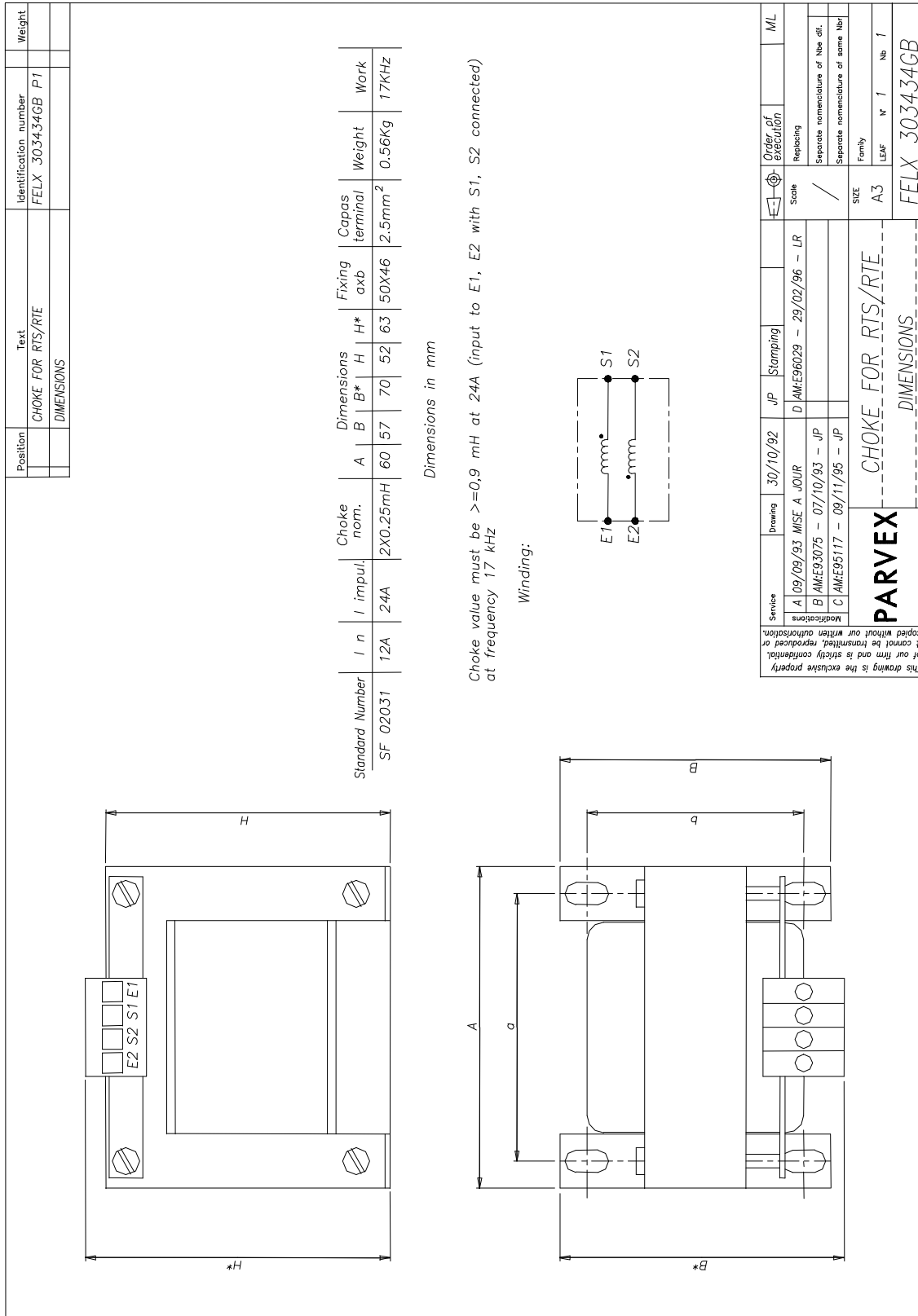

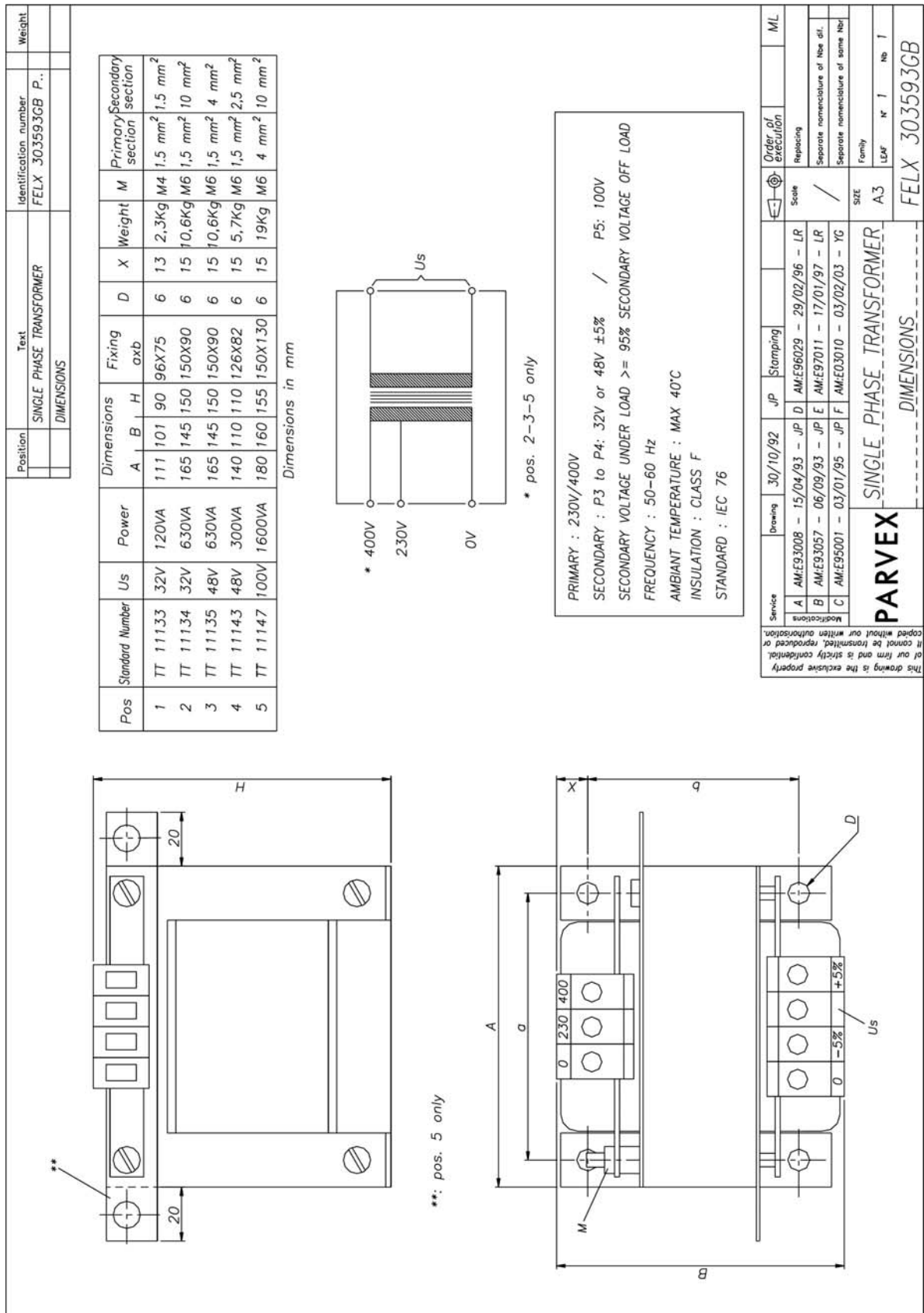

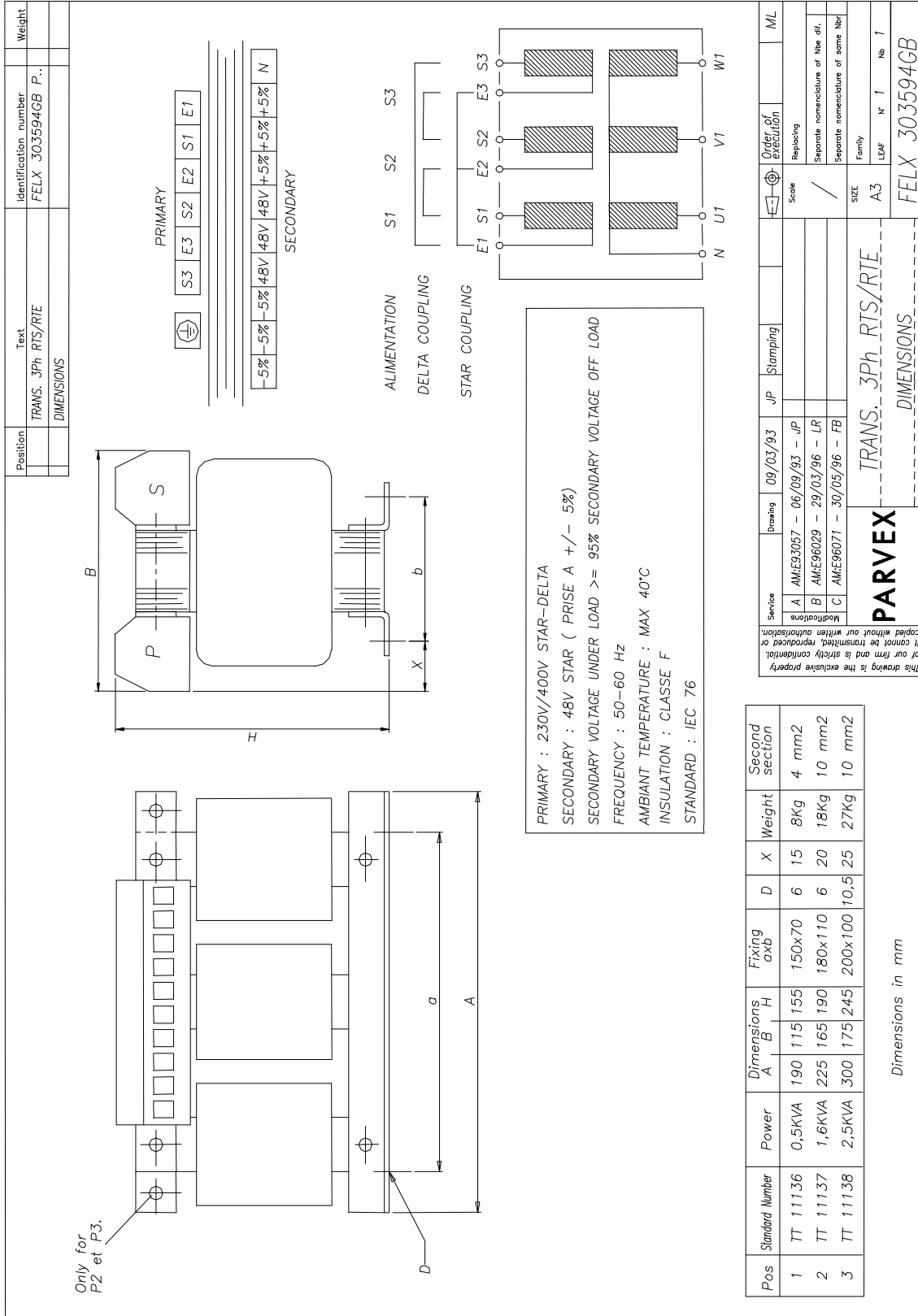

Position	Text	Identification number	Weight
	TRANS. 3Ph RTS/RTIE DIMENSIONS	FELX 303740GB P..	

Only for P1, P2, P3 and P5

PRIMARY

S3	E3	S2	E2	S1	E1
----	----	----	----	----	----

-5% -5% 100V|100V|100V|+5%+5%+5%+5% N  
SECONDARY FOR P1 - P4 - P5  
48V 48V 48V 100V|100V|100V N  
SECONDARY FOR P2 AND P3

ALIMENTATION  
DELTA COUPLING  
230V

STAR COUPLING  
400V

PRIMARY : 230V/400V STAR-DELTA  
SECONDARY : 100V STAR ( PRISE A +/- 5% )  
100V STAR ( PRISE A +/- 5% )  
SECONDARY VOLTAGE UNDER LOAD >= 95% SECONDARY VOLTAGE OFF LOAD  
FREQUENCY : 50-60 Hz  
AMBIANT TEMPERATURE : MAX 40°C  
INSULATION : CLASSE F  
STANDARD : IEC 76

Pos	Standard Number	Power	Dimensions overall	Fixing	Weight	J	Second section
			A B H	a x b	X		
1	TT 11139	1,6KVA	225 160 190	180x120	6	M3	10 mm2
2	TT 11140	2,5KVA	300 190 230	200x115	10,5	M4	10 mm2
3	TT 11141	4KVA	300 210 255	200x145	10,5	M4	16 mm2
4	TT 11144	630VA	185 110 150	150x80	4,5	M3	2,5 mm2
5	TT 11145	1KVA	225 110 160	180x80	6	M3	4 mm2

NOTE: TOTAL POWER MUST BE AVAILABLE ON 48V SECONDARY FOR POSITION 2 AND 3.

Dimensions in mm

Service	Drawing	07/03/93	JP	Stamping	ML
	A AME93057 - 06/09/93 - JP				
	B AME95099 - 03/10/95 - FA				
	C AME96029 - 29/02/96 - LR				
Modifications					
This drawing is the exclusive property of our firm and is strictly confidential. It cannot be transmitted, reproduced or copied without our written authorisation.					
<b>PARVEX</b>		TRANS. 3Ph RTS/RTIE		DIMENSIONS	
				FELX 303740GB	
				Family	
				LEAF N° 1 Nb 1	
				SIZE A3	
				Scale	
				Order of execution	
				Replacing	
				Separate nomenclature of the diff.	
				Separate nomenclature of some Nbr	

# RTS 2nd Generation SERVO AMPLIFIER

	Position	Text	Identification number	Weight
		Trans. 3ph RTS/RTE/SBS DIMENSIONS	FELX 302570GB P..	

PRIMARY

S3 E3 S2 E2 S1 E1

-5% -5% -5% | 35V | 35V | +5% +5% +5% | N

SECONDARY

ALIMENTATION  
DELTA COUPLING  
230V

STAR COUPLING  
400V

S1 S2 S3

E1 S1 E2 S2 E3 S3

N U1 V1 W1

PRIMARY : 230V/400V STAR-DELTA  
 SECONDARY : 135V STAR ( PRISE A +/- 5%)  
 FREQUENCY : 50-60 Hz  
 AMBIANT TEMPERATURE : MAX 40°C  
 INSULATION : CLASSE F  
 STANDARD : IEC 76

Pos	Standard Number	Power	Dimensions overall	Fixing axb	D	Weight
1	TT 11115	1KVA	A 225 B 125 H 155	180x90	6	14Kg
2	TT 11116	1,6KVA	A 225 B 155 H 155	180x120	6	18Kg
3	TT 11117	2,5KVA	A 240 B 130 H 205	200x100	10	21Kg
4	TT 11118	4KVA	A 240 B 160 H 235	200x130	10	28Kg
5	TT 11119	6,3KVA	A 300 B 210 H 330	240x115	10	43Kg
6	TT 11120	10KVA	A 360 B 250 H 360	240x130	10	62Kg
7	TT 11149	0,63KVA	A 190 B 110 H 135	150x80	6	8,5Kg

DIMENSIONS IN mm

Service

C AM: E98025 - 18/02/98 - VR  
H AM: E06079 - 10/11/06 - ST

Modifications

Drawing

12/11/89

FM

Stamping

Order of Execution

Replacing

Separate nomenclature of hbr dif.

Separate nomenclature of some hbr

Family

LEAF N° 1 Nb 1

SIZE A3

Scale /

Trans. 3ph RTS/RTE/SBS

DIMENSIONS

FELX 302570GB

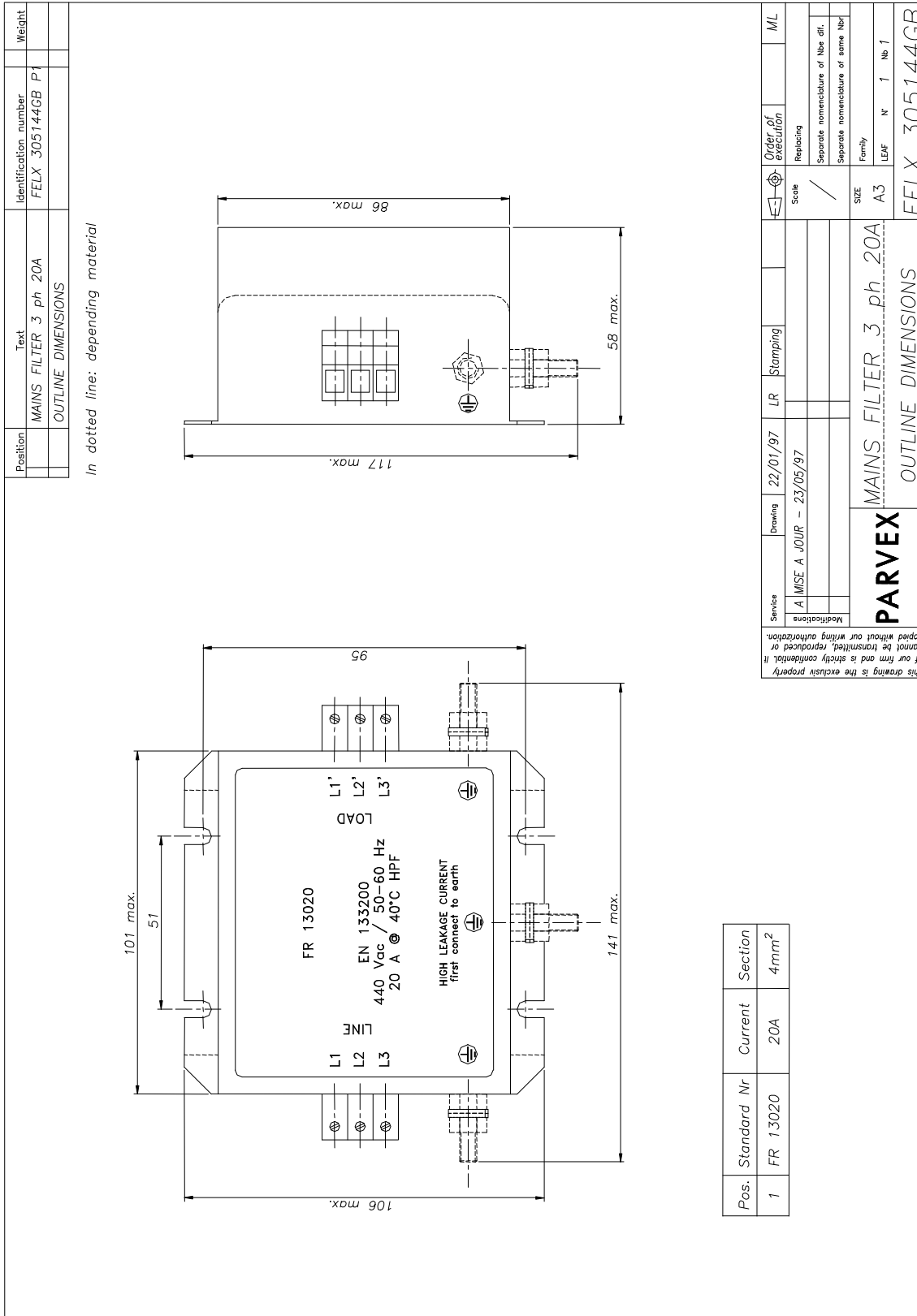



Position	Text	Identification number	Weight
	MAINS FILTER 3 ph OUTLINE DIMENSIONS	FELX_304967GB_P1	

\* permissible section

U<sub>in</sub> : 440 Vac 50/60Hz  
 T<sub>a</sub> : 40°C  
 Norm : EN 133200

Pos.	Standard Nr	Current	Dimensions		* Section	Weight
			A	B		
1	FR 03016	16A	241	201	4mm <sup>2</sup>	3Kg
2	FR 03036	36A	251	201	10mm <sup>2</sup>	3Kg
3	FR 03064	64A	308	231	25mm <sup>2</sup>	4Kg

Standard Nr	Max. leakage current (50/60Hz) in mA	
	three-phase operation	unbalanced operation (start-up)
FR 03016	10	30
FR 03036	3	200
FR 03064	3	170

**PARVEX**

MAINS FILTER 3 ph  
OUTLINE DIMENSIONS

Order of execution

Scale

Separate nomenclature of hba dif.

Separate nomenclature of same hba

Family

LEAF N°: 1 Nb: 1

FELX\_304967GB

This drawing is the exclusive property of our firm and is strictly confidential. It cannot be transmitted, reproduced or copied without our written authorisation.

Modifications

Service	Drawing	26/06/96	LR	Stamping	ML
A	AME97016 - 22/01/97 - LR	D	AME98056 - 12/05/98 - VR		
B	AME97162 - 20/11/97 - VR	E	AME98175 - 09/11/98 - VR		
C	AME98035 - 11/03/98 - VR				

## 5. LED DISPLAYS

LED displays are possible only if the supply voltage is present. The "Ready" relay, in this case, must not be incorporated in the auto-hold of the power supply.

	<p>ON : energised - axis OK</p> <p>OFF : no power on axis. Check wiring, fuses, internal fuse : (FU 5x20) - 5 A (rating 3/10) - 10 A (gauge 10/20; 12/24 16/32; 20/40)</p> <p>FLASHING : axis fault (see corresponding fault on side strip).</p>
---	--

<b>Miniature LED SIDE STRIP on side of RR 6605 card</b> RESET to clear faults (terminal 12)		
FAULT DISPLAY	CAUSE	CORRECTION
TAC	- Tacho wire cut. - Tacho wire inverted. - Overspeed. - Motor wire cut. - Motor wire inverted.	* Check tacho wiring * Check axis works correctly without tacho (selector S3 in position 0) * Check motor wiring
CT	Dissipater temperature too high. LED remains on after cooling. RESET to switch LED off.	* Check ventilation * Ambient temperature too high : fit ventilation system
MIU	Inadequate ac supply voltage (Min U)	* Check supply phases are present * Check input voltages * Check transformer star-delta coupling
MAU	Power voltage too high (Max U). Energy return from load too high. Excessive ac input voltage.	* Check input voltages. * Reduce axis working speed to reduce braking energy. * Increase servo amplifier gain.
dl/dT	Short-circuit of motor terminals	* Check motor wiring. * Inadequate motor choke (Axem motor) : add series choke.
IFT	Excessive mean motor current	* Reduce servo amplifier gain. * Reduce working cycle.

NOTE : Recovery control is also displayed (REC)

# 6. SERVO AMPLIFIER ADAPTATION

## Selector switch positions

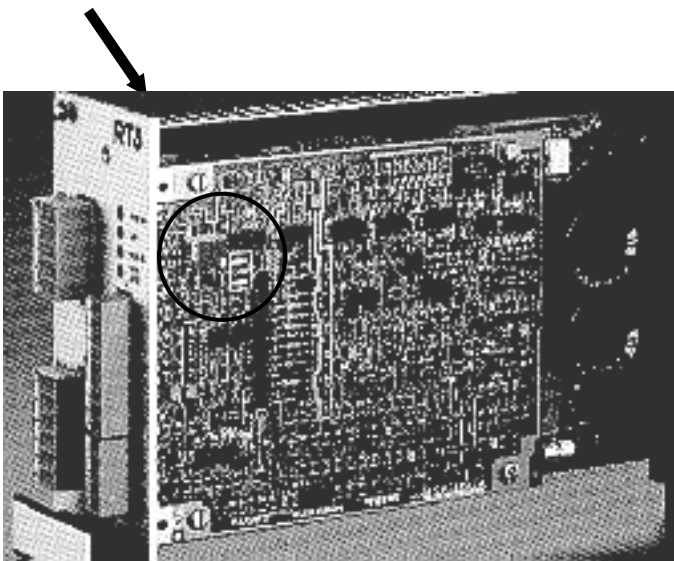
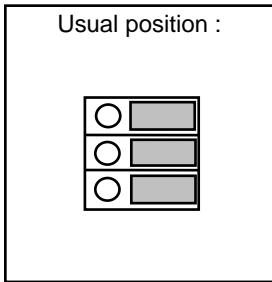
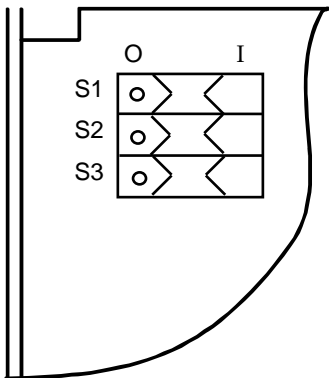

### \* Selector S1

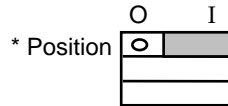

Speed control.  
 Speed feedback is used.  
 Usual case.

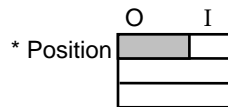

Current control.  
 Speed control is unused.  
 X1/4-X1/5 input becomes a  
 current reference.

### \* Selector S2

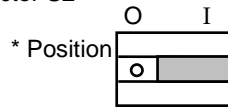

X1/9 output indicates current  
 information.  $\pm 10$  V  
 corresponds to pulse current.

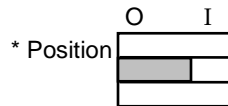

X1/9 output indicates speed  
 information.  $\pm 10$  V  
 corresponds to rated speed of  
 application.

### \* Selector S3

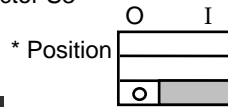

Tacho information is used in  
 speed control.

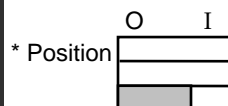

Speed information is  
 calculated from servo motor  
 emf.

## 7. COMMISSIONING

**- Check the connection of the following items :**

- transformer
- relay system, especially the emergency stop
- motor and any smoothing choke
- tachometer system
- ground circuit

**- Speed and current inhibited (X1/10 and X1/11 not connected),**

Connect the power to the servo amplifier. The "POWER ON" LED should light up (if not check the transformer wiring and relay system). If the "POWER ON" LED flashes, measure the transformer secondary voltage :

RTS 10/20 - 60	Us = 48 vac : 43 vac < Usec < 53 vac
RTS 3/10 - 40 M	Us = 32 vac : 29 vac < Usec < 35 vac
RTS 12/24 - 130 T	Us = 100 vac : 90 vac < Usec < 110 vac
RTS 13/32 - 190 T	Us = 135 vac : 122 vac < Usec < 148 vac
RTS 20/40 - 130 T	Us = 100 vac : 90 vac < Usec < 110 vac

Adjust the output voltage as required with the  $\pm 5\%$  transformer terminals.

**- With zero speed reference (X1/4 = X1/5 = 0V)**

Release the servo amplifier (X1/10 and X1/11 at 0V), the motor must be under torque. If the motor races, cut the power and check the signals from the tachometer (cut-out or inversion) before switching on again ("TAC" fault). If the motor "growls" or "vibrates" with possibly an "IFT" fault, reduce servo amplifier gain by turning the front panel potentiometer anti-clockwise. If the servo amplifier had switched to fault mode ("POWER ON" flashing) use RESET (X1/12 to 0V) to clear the fault.

**- Gradually increase servo amplifier reference,**

and monitor motor acceleration. Check the motor rotates in the opposite direction when the reference is reversed. If a fault arises on inversion for a 10 V reference, adjust servo amplifier gain (see paragraph : gain adjustment). If the fault persists, wire the power transformer secondary to the -5% terminals ("MAU" fault on LED strip).

## 7.1 Speed loop rapid adjustment

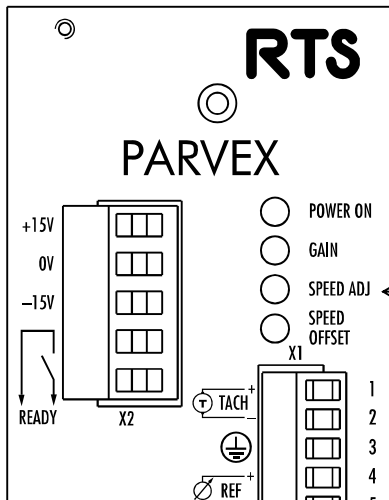

**\* Offset adjustment**

Once ambient temperature is stabilised, adjust zero speed to the mid-position with the "SPEED OFFSET" potentiometer on the front panel.

**\* Speed adjustment**

The "SPEED ADJUST" potentiometer produces fine calibration of speed for a given reference.

**\* Gain adjustment**

By increasing gain, the servo motor becomes more rigid. Turn the "GAIN" potentiometer clockwise until the motor is unstable and vibrates.

Then turn the potentiometer back one or two turns. If there is a large load on the potentiometer, the potentiometer adjustment range may be inadequate and resistance R101 will have to be increased.

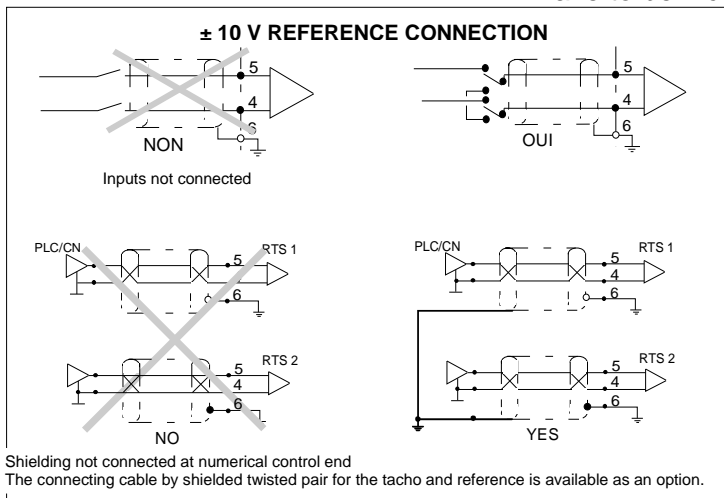

**Application : Potentiometer reference**

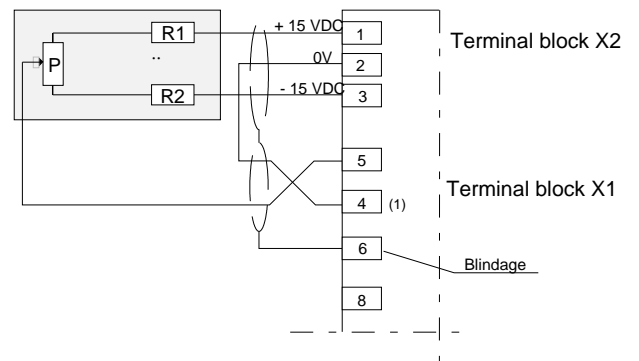

(1) Terminal 4 may be connected to terminal 8

**Example : ± 10 V**  
 P = 10 kΩ linear potentiometer  
 R1 and R2 = 2,2 kΩ, 1/2 W resistor

## 7.2 Complete speed loop adjustment

Systematically applicable when J charge  $\geq 10$  J motors

**Caution** As servo amplifiers are factory set based on parameters provided by the customer, this setting does not usually require adjustment.

Before adjusting the speed loop, all the adjustable parameters must be fixed (current limits, speed scale setting, speed limits). Adjusting the speed scale setting alters loop gain and means readjustments are required.

### Equipment required

- Storage oscilloscope (digital if possible), easy to trip.
- Manual speed reference generator (battery box) or low frequency generator with series capacitor to produce zero mean speed (out and return about a position).
- Decade box for capacitor and resistor adjustment. Reference battery box, with oscillator for automatic control is available as an option.

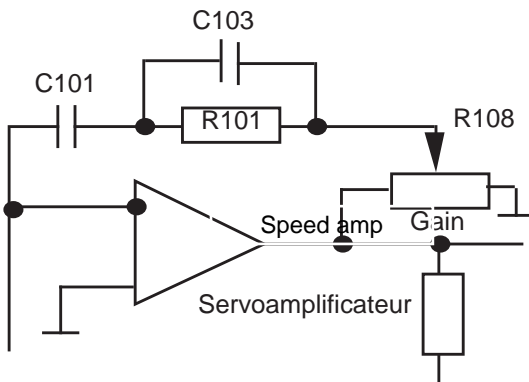

### Method

**FIG 1**

Adjust the gain potentiometer to the centre (so gain may be varied up or down after adjustment).  
Fit a large integration capacitor C101 - 10 $\mu$ F or strap.  
Adjust proportional gain starting by R101 = 10 k $\Omega$ .

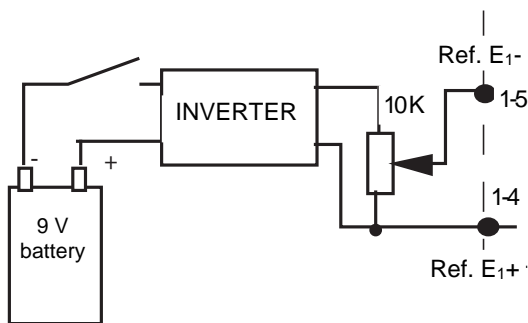

Speed recorded between N measurement and 0 V analogue

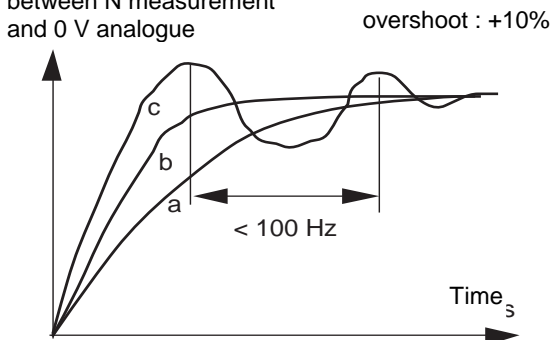

FIG 1 : a, b, c - graphs obtained with increasing R101 values

Increase R101 until 10% overshoot on speed reference increment. Always use small speed reference increments (e.g.  $\pm 100$  rpm or less) so the system remains linear. For large increments, current limitation (= torque limitation) masks the real situation and reduces overshoot. The adjustment obtained with high speed increments would be incorrect.

In many cases, it is not possible to increase gain to produce overshoot especially for high inertia systems.

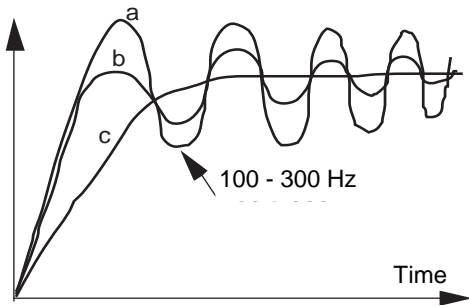

FIG. 2 : a, b, c, - graphs obtained with increasing C103 values

**FIG 2**

In some cases, gain limitation is due to resonance: the motor starts to whistle or vibrate at high frequencies (> 100 Hz). A -1 filter must be included at a frequency 3 to 4 times lower than the oscillation so the gain can be increased by the same ratio. This can be done by connecting a C103 capacitor in parallel with the R101 proportional gain resistor, and increasing the capacitor until the whistling stops (usually several tens of nF) and then continuing to increase gain while monitoring overshoot and torque ripple. The C103 10 nF capacitor is ready fitted as standard in parallel with the R101 gain resistor.

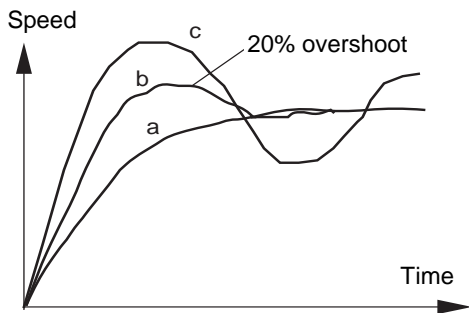
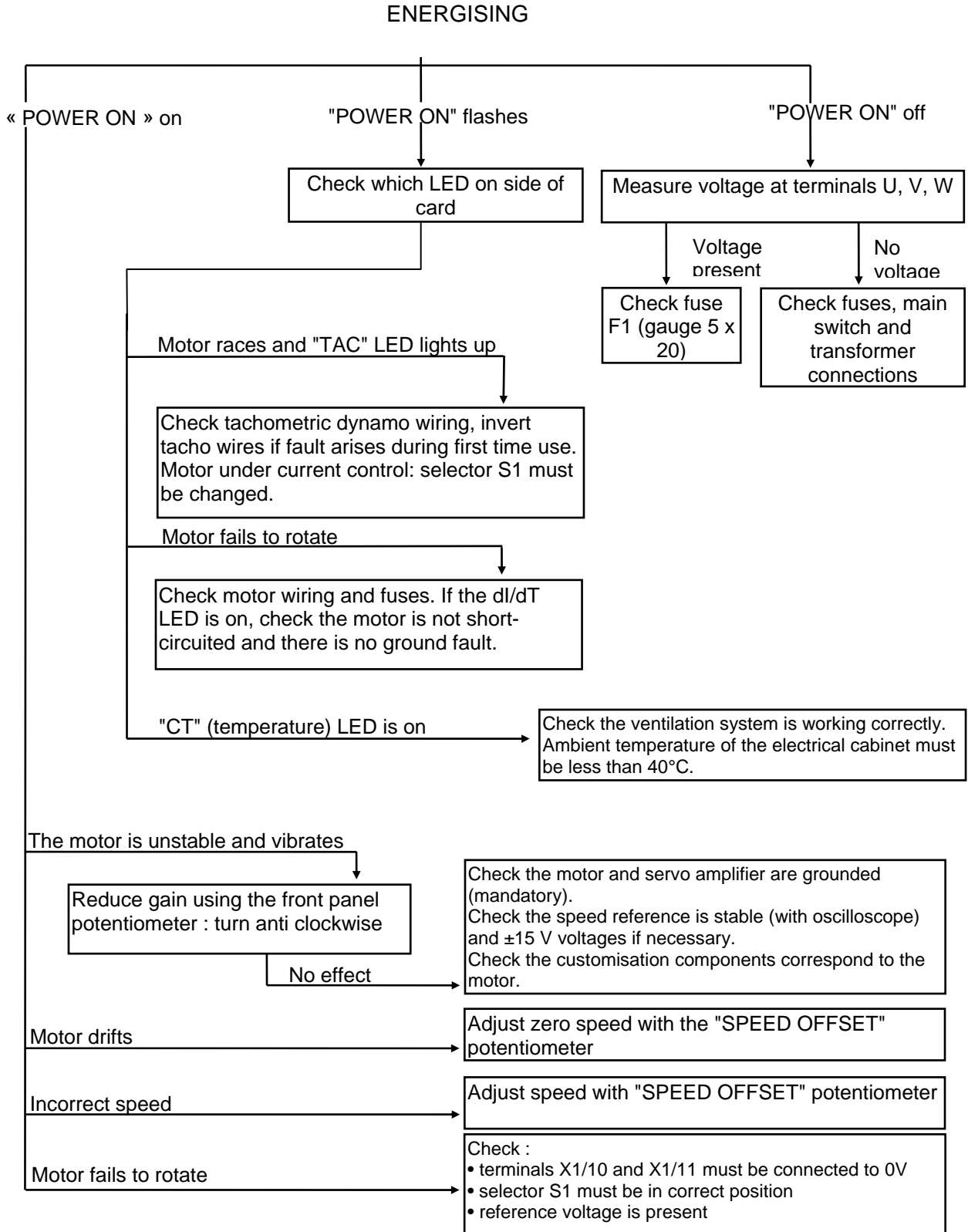

FIG 3 : a, b, c - graphs obtained with decreasing C101 values

**FIG 3**

When the gain is set, the C101 integration capacitor must be reduced to produce 15 - 20% overshoot (still for small speed increments).

## 7.3 Diagnostic help





## 7.4 Calibration

---

**CAUTION : Servo amplifiers are factory set and the information in sections 7.4.1 - 7.4.11 are for reference only.**

The components below are stud mounted and used to calibrate the servo amplifier for the corresponding motor. Calibration is done at the manufacturer's facility before delivery and these components should not be modified.

# RTS 2nd Generation SERVO AMPLIFIER

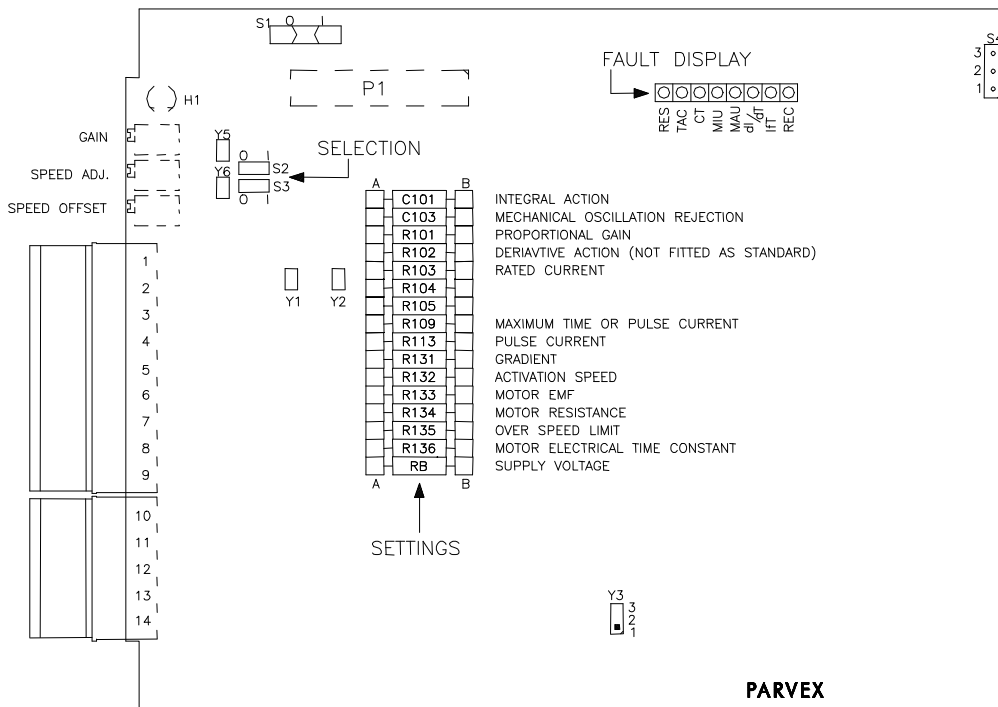
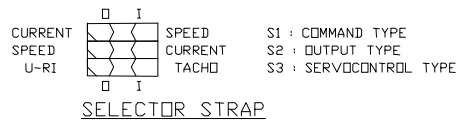
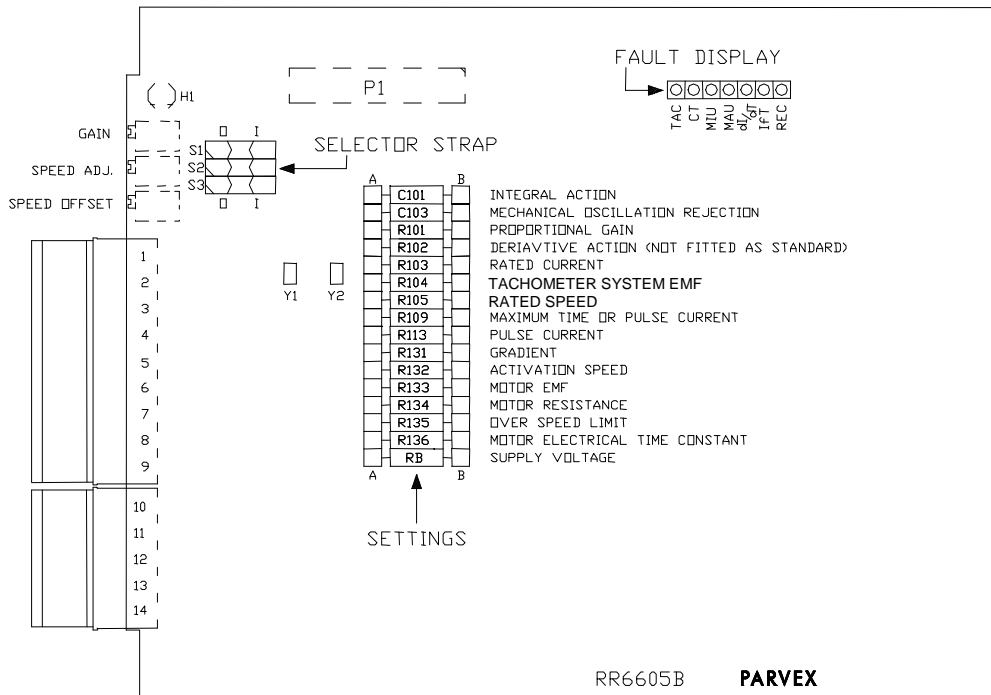

RR 6606B SELECTION

RR 6606B SELECTION

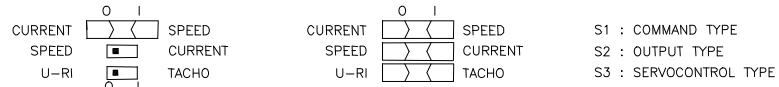

**Symbols used**

- Nn = rated speed of application for 10 V reference speed
- Ilim = maximum pulse current of motor
- I<sub>max</sub> = maximum pulse current of servo amplifier
- I<sub>n</sub> = maximum rated current of motor
- K<sub>et</sub> = gradient of tachometric generator in V per thousands of rpm
- K<sub>e</sub> = back electromotive force of motor in volts per rpm
- r = resistance of motor and its supply circuitry in ohms
- L = inductance of motor in mHenrys
- U<sub>b</sub> = bus voltage in volts (1.35 x V<sub>in</sub> AC)

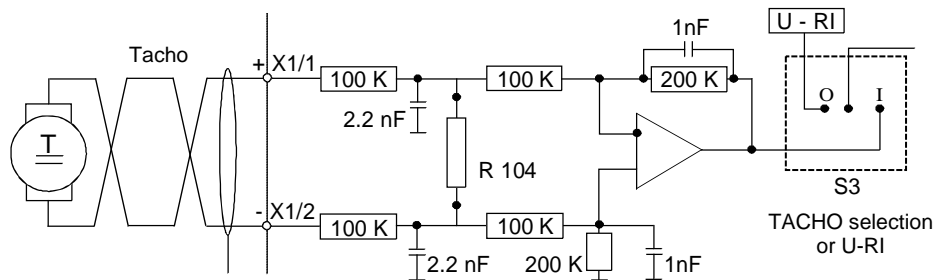

**7.4.1 Tachometric generator voltage calibration (R104)**

Resistor **R104** is used to adapt the tachometric generator gradient to that of the servo amplifier (2V/1000 rpm).

K <sub>et</sub>	2	3	4	5	6	8	10	12	15	20
R 104 (kΩ)	∞	200	100	68	51	33	24	20	15	11

Do not exceed 100V on the tachometer input.

For a gradient of 1 V / 1000 rpm, short-circuit the solder tags Y1 and Y2 with R104 = ∞.

Standard tachometric generator values are :

- 3 V at 1 000 rpm e.g. TBN 103
- 6 V at 1 000 rpm e.g. TBN 206
- 20 V at 1 000 rpm e.g. TBN 420

These values are plated of tachometric generator. e.g.  
K<sub>e</sub> : 6 mVrpm or 6 V at 1000 rpm

### 7.4.2 Rated speed selection (R105)

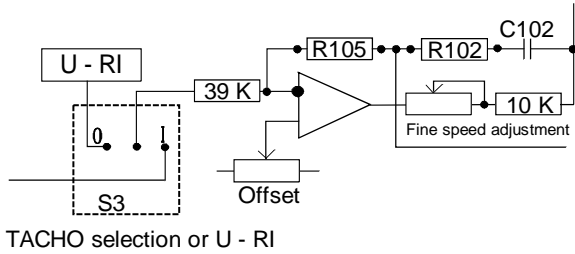

TACHO selection or U - RI

Resistor **R105** calibrates the useful speed of the application. For a speed reference of  $\pm 10$  V, the speed corresponding in rpm to the servo motor will be determined by R105 according to the table below.

Calibration accuracy supposes that R104 calibration value of the tacho is correctly set.

The "SPEED ADJUST" potentiometer on the front panel allows easy fine adjustment of speed. Turning it clockwise increases speed for a given reference.

Speed Nn (rpm)	R 105 (k $\Omega$ )
700	274
770	
869	221
950	
1055	182
1200	
1280	150
1400	
1590	121
1650	
1750	110
1800	
1920	100
2100	
2330	82.5
2600	
2820	68.1
3100	
3420	56.2
3700	
4040	47.5
4400	
4900	39.2
5200	

The equipment may be adapted for speeds lower than those shown above but this hinders servo amplifier performance with regard to drift and gain. The maximum value not to be exceeded for R105 is 4.75 M $\Omega$ .

### 7.4.3 Pulse current adjustment (R113)

R113 modifies the maximum current authorised by the servo amplifier.

The standard pulse current is twice the value of the permanent current. It may be set either internally by using R113 or by using current reduction input X1/7 "Ired".

The table below shows the value of resistor R113 in kΩ versus the percentage of maximum current.

% of maximum current	10	20	30	40	50	60	70	80	90
R113 (kΩ)	0.392	0.825	1.5	2.21	3.32	4.75	7.5	12.1	33.2

### 7.4.4 Current limitation by external resistance or external voltage (terminal block X1)

#### 7.4.4.1 By external resistance

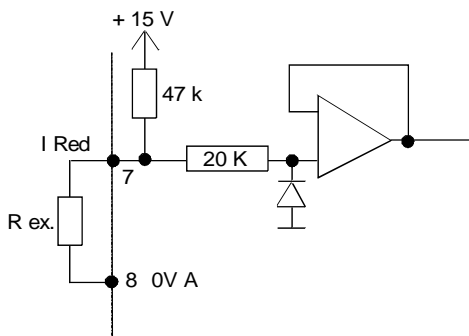

The table below shows the external resistor value in kΩ versus the percentage of maximum current.

Voltage control between terminals 7 and 8 is also possible. In this case, the current is linear with 10 V = I max.

% of maximum current	10	20	30	40	50	60	70	80	90
Rext (kΩ)	3.32	6.81	10	15	22.1	27.4	39.2	47.5	56.2

#### 7.4.4.2 By external voltage

Voltage control between terminals 7 and 8 is also possible. In this case, the current is linear with 10 V = I max.

### 7.4.5 Time constant adjustment I = f(t) (R109)

**CAUTION :** For safety reasons the values of resistors R109 and R103 must not be altered without authorisation from PARVEX - Warranty may be affected.

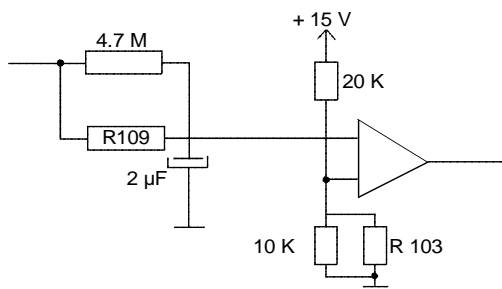

The system time constant is factory set so the servo amplifier accepts maximum current for one second, starting from  $I = 0$ . After one second the servo amplifier switches automatically to safety mode.

Standard resistor **R109** is 562 kΩ for a maximum current lasting 1 second. For a maximum current lasting 2 seconds, resistor R109 must be 1210 kΩ.

### 7.4.6 Adjustment of function I = f(t) (R103)

Function  $I = f(t)$  is designed to protect the servo amplifier and servo motor if the mean current required exceeds the rated current.

Resistor **R103** is used to adjust the tripping limit authorised by the servo amplifier.

**RTS 3/10 - 40**

<b>% of rated current</b>	50	60	70	80	90	100
<b>R103 (kΩ)</b>	1.82	2.74	3.92	4.75	6.81	8.25

- RTS 10/20 - 60
- 12/24 - 130
- 12/24 - 24/48
- 16/32 - 190
- 20/40 - 130

<b>% of rated current</b>	20	30	40	50	60	70	80	90
<b>R103 (kΩ)</b>	1,5	2,21	3,32	4,99	7,5	12,1	20	43,2

**7.4.7 Adjustment of current limitation curve versus speed I F(n) (R131 - 132)**

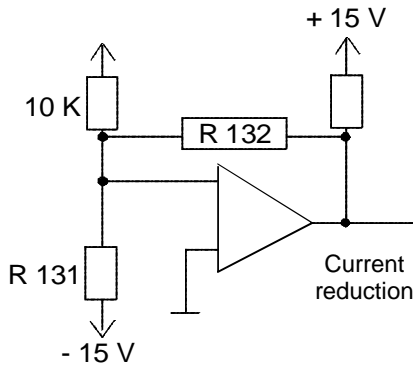

Resistor **R131** is used to select the zero current point on the speed current diagram.

Resistor **R132** determines the speed beyond which pulse current (selected by R113) begins to decrease linearly with speed.

When function  $I = F(n)$  is not required :

$$R131 = 10\text{ K}\Omega$$

$$R132 = 100\text{ K}\Omega$$

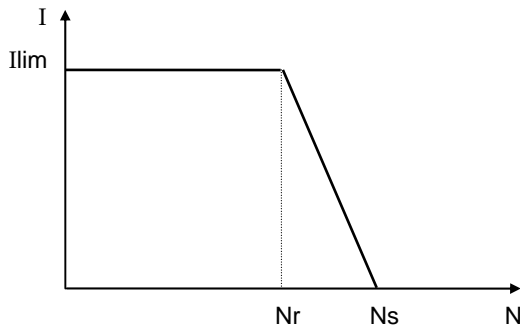

Nr : speed in thousands of rpm above which current decreases

Ns : speed in thousands of rpm at which current is zero

**R131 values**

<b>Ns (rpm)</b>	500	1000	1500	2000	2500	3000	3500	4000	4500	5000	5500	6000	6500	7000
<b>R 131 (kΩ)</b>	16.2	82.5	56.2	39.2	33.3	27.4	22.1	20	18.2	16.2	15	13.7	12.1	12.1

R132 values

Ns - Nr	% of maximum current				
	20	40	60	80	100
500	27.4 kΩ	47.5 kΩ	100 kΩ	82.5 kΩ	121 kΩ
1000	12.1 kΩ	22.1 kΩ	33.2 kΩ	47.5 kΩ	56.2 kΩ
1500	8.25 kΩ	16.2 kΩ	22.1 kΩ	33.2 kΩ	39.2 kΩ
2000	6.81 kΩ	12.1 kΩ	18.2 kΩ	22.1 kΩ	27.4 kΩ
2500	5.62 kΩ	10 kΩ	15 kΩ	18.2 kΩ	22.1 kΩ
3000	4.75 kΩ	6.82 kΩ	10 kΩ	15 kΩ	18.2 kΩ
3500	3.32 kΩ	6.82 kΩ	10 kΩ	13.7 kΩ	16.2 kΩ
4000	3.32 kΩ	5.62 kΩ	8.25 kΩ	12.1 kΩ	15 kΩ

**7.4.8 Calibration of function U - RI (R133 - R134)**

This adaptation is necessary even when operating with a tachogenerator to ensure tacho safety: speed signals from "U - RI" and from the tacho are compared constantly and must be of the same order of magnitude.

**EMF per 1000 rpm** : The electromotive force constant KE indicates the voltage measured on the armature for an off-load speed of 1000 rpm, at 25°C. Under load, for a given voltage, motor speed will be:

$$N = \frac{U - (RI)}{KE} \times 1000$$

- I = current between terminals in Amps
- R = armature resistance in Ohms
- U = voltage across terminals in Volts
- KE = EMF constant in Volts per 1000 rpm



To calculate motor speed, coefficients R and KE must be calibrated by the resistor values below :

	R 133 [kΩ]	R 134 [kΩ]
RTS 3/10 - 40	180/ KE	40 R
RTS 10/20 - 60	260/ KE	60 R
RTS 12/24 - 130	540/ KE	32 R
RTS 12/24 - 24 B 1)	96/ KE	154 R
RTS 12/24 - 48 B	192/ KE	77 R
RTS 16/32 - 190	760/ KE	32 R
RTS 20/40 - 130	540/ KE	64 R

e.g. RX 120 L servo motor with RTS 3/10-40

$$KE = 11.5 \text{ V}/1000 \text{ rpm} \quad R_{133} = 15 \text{ k}\Omega$$

$$R = 2.5 \text{ }\Omega \quad R_{134} = 100 \text{ k}\Omega$$

1) with RR6606C :  $R_{133}(\text{k}\Omega) = 192 / KE$  ;  $R_{134}(\text{k}\Omega) = 77R$

### 7.4.9 Tripping limit calibration (R135)

Resistor **R135** determines the tripping limit of maximum speed for tachometric servo control and U - RI operation.

Nn (rpm)	1000	1500	2000	2500	3000	3500	4000	4500	5000	5500	6000
R 135 (kΩ)	1.5	2.74	3.92	4.75	6.81	8.25	12.1	15	22.1	27.4	39.2

### 7.4.10 Current loop gain adaptation to motor inductance (R136)

RTS	3/10	10/20	12/24	16/32	20/40
R136 kΩ	$\frac{2.5 \cdot 10^3 L}{U_b}$	$\frac{5 \cdot 10^3 L}{U_b}$	$\frac{6 \cdot 10^3 L}{U_b}$	$\frac{8 \cdot 10^3 L}{U_b}$	$\frac{10^4 L}{U_b}$

U<sub>b</sub> : drive bus direct voltage (Volts)

L : motor inductance and any additional inductance (mH)

When selecting R136 take the value immediately below in the following range and multiples thereof::

10 - 12 - 15 - 18 - 22 - 27 - 33 - 39 - 47 - 56 - 68 - 75 - 82 - 100

**7.4.11 dc voltage calibration (RB)**

Resistor **RB** is used to adapt limit values: MAX U, MIN U, tripping of supply voltage recovery.

The standard values are as follows :

SERVO AMPLIFIER MODEL	Input voltage VAC (1)	DC voltage	Max voltage	Min voltage	Dissipation resistance		RB kΩ
					On limit V	Off limit V	
RTS 3/10 - 40	32	43	57	27	53	50	200
RTS 10/20 - 60	48	65	86	40	79	75	∞
RTS 12/24 - 130 20/40 - 130	100	135	179	83	164	156	∞
RTS 12/24 - 48	48	48	64	30	-	-	∞
RTS 12/24 - 24	24	24	34	16	-	-	100
RTS 16/32 - 190	135	190	240	112	221	210	∞

**(1) Remark :** The RTS servo amplifier may be used with supply voltages different from the standard values.

e.g.    RTS 10/20-40 with 32 V supply  
           RTS 16/32-140 with 110 V supply

Please ask for details.