

User Manual



*For 7800 Series
Suction Regulators:*

**7800
7804
7840**



BOEHRINGER®

**Boehringer Laboratories, LLC
300 Thoms Dr.
Phoenixville, PA 19460
800-642-4945**

Contents

Declaration of Conformity.....	2
Definition of Terms/ Symbology	4
Safety Information	5
Clinical Use.....	5
Operation.....	6
Installation	7
Mode Selection.....	8
Test.....	9
Maintenance	9
Cleaning & Disinfection	10
Disassembly	10
Assembly	11
Troubleshooting.....	13
Specifications	14
Warranty	15
Diagram, Continuous Regulators	16
Diagram, Intermittent Regulators	17

Definition of Terms and Symbology

VACUUM	Air or other gases at a sub atmospheric pressure typically expressed as mmHg or cmH ₂ O.
SUCTION	A use of vacuum that causes a fluid or solid to be drawn into an interior space or to adhere to a surface because of the difference between the external and internal pressures.
	Alerts the user to the presence important operating and maintenance instructions in the literature accompanying the device.
WARNING	Alerts user to actions or conditions that could result in injury to user or patient.
CAUTION	Alerts user to actions or conditions that can cause damage to the device <u>or</u> may result in substandard performance of the device or system.
IMPORTANT	Indicates an action that is emphasized to ensure proper operation of equipment.
OFF	Supply suction is off and patient circuit is vented to atmospheric pressure.
REG	Supply suction is on and regulated output is controlled to prescribed setting.
LINE	Supply suction is on and regulation is bypassed to deliver maximum suction to collection circuit.
CONTIN	Intermitting regulator setting that provides continuous regulated suction to the collection circuit.
INT	Intermitting regulator setting that allows periodic, automatic application & venting of the collection circuit.
	<p>Lo Spike: Accuracy of regulation depends primarily on the ability to provide a consistent level of vacuum under changing flow conditions.</p> <p>Involuntary pneumatic biopsy, or tissue damage, can occur when high levels of vacuum are applied to delicate tissue. With a Boehringer regulator, you can depend on very low “spike” compared to our competitor’s models.</p> <p>“Spike” is the variation in indicated suction as flow in the collection circuit changes from an a free flowing condition to an occluded condition. We measure spike as the change in indicated suction from full flow to a no flow condition using a typical collection circuit with a 14 French catheter. To test, set the regulator to 100 mm flowing, and then allow occlude the 14Fr catheter. The change in the indicated suction level is “Spike”.</p> <p>Boehringer regulators are checked on the assembly line to meet a specification of less than 10% of the indicated setting, for example 10mmHg spike at a 100 mmHg setting.</p> <p>An evaluation of a regulator’s spike allows one to determine whether the device is truly “regulating”. A safe and reliable regulator should regulate to its set position regardless of variable flow conditions.</p>
PARALLAX	Inaccuracy caused by observational position of an indicating element (pointer) to a reference element (scale).

Safety Information

WARNING!

- This product is intended for use by or on the order of a physician. It is to be used by individuals who are properly trained in medical suctioning procedures. Please read these instructions carefully.
- Suction regulators must only be attached to vacuum systems. Do not attach to compressed air, nitrogen, or oxygen sources.
- Suction catheters, collection canisters and suction tubing must be carefully evaluated and selected to ensure adequate function for the specific clinical environment and intended field of use.
- Do not use Boehringer suction regulators in the presence of flammable anesthetics.
- There have been reports of increased intracranial pressures associated with endotracheal suctioning procedures. "Persistent, increased ICP has been associated with neurological damage and fatalities". (ECRI, Healthcare Product Comparison System (US). Regulators, Suction. Plymouth Meeting (PA), 1999.).



Always verify regulator operation (Spike, see page 3 for details) before use on a patient. Verify operation by establishing the desired vacuum level with the collection circuit and suction catheter attached to the regulator. Occlude the suction catheter and note that the indicated vacuum does not rise by more than 10% of the original setting.

- Intermittent Regulators: The automatic return of the patient circuit to atmosphere may not eliminate the need for catheter tip irrigation. As with any automatic system, it is important to monitor the results to be sure that drainage is occurring in a safe efficient manner. The fact that the intermitter is cycling is not an indication that effective drainage is occurring.
- The Model 3708 Boehringer MRI Suction Regulator is the only MR conditional regulator with FDA 510K approval.
- The high air flow of the model 3740, 3748, 3840, 7740, and 7840 contraindicate their use with a Vacuum Assisted Delivery (VAD) systems. Please consult our factory engineers if you require suction regulation for these applications.

CAUTION!

- Collection canisters are mandatory for all suction procedures. We strongly recommend the use of an overflow protection device (filter or trap bottle) at all times between the regulator and collection canister. See Accessories at the end of this manual.

CLINICAL USE

The **7800 Series Continuous Suction Regulators** are designed to provide accurate control of wall suction for use in suction therapy procedures in the operating, recovery, intensive care unit, labor and delivery, neonatal, pediatrics, patient bedside, and emergency room.

The **7800 Series Intermittent Suction Regulators** are designed to provide an intermittent suction source for gastrointestinal drainage procedures. They may also be used in procedures needing continuous suction.

Operation

FEATURES

Continuous Models
7800, 7840

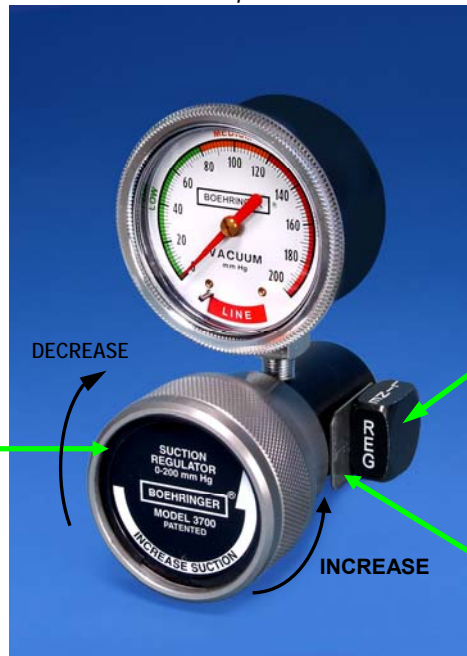

Mode Selector Valve:
Square knob to easily switch
between operating modes.

Adjusting Knob: Extra large, easy grip
knob turns COUNTER-CLOCKWISE
(direction of arrow) to increase suction
setting and CLOCKWISE to decrease
suction setting

Safety Release: Thumb spring
that must be depressed to turn
Mode Selector Valve to LINE

Intermitting Model
7804



Mode Selector Valve:
Large round knob to easily
switch between operating modes
OFF/ INTERMIT/ CONTIN.

Adjusting Knob: Extra large, easy grip
knob turns COUNTER-CLOCKWISE
(direction of arrow) to increase suction
setting and CLOCKWISE to decrease
suction setting







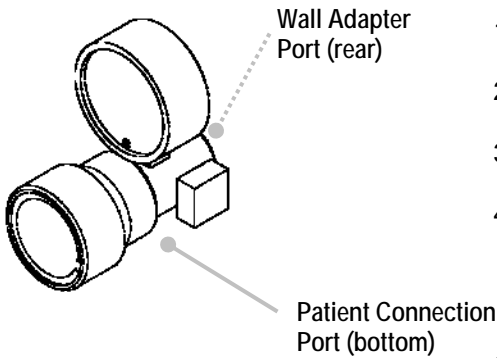

INSTALLATION

All Boehringer suction regulators are supplied with 1/8" NPT female ports. The standard port facilitates simple adaptation to any quick disconnect system. Fittings are available from Boehringer to adapt to your quick connect system. We recommend you purchase the appropriate fittings with your regulator at the time of purchase. The fittings will then be factory installed prior to shipping. By purchasing the regulator and fittings (a complete system) simultaneously, the factory will apply the same FIVE Year Warranty of our suction regulators to the fittings as well. See page 15 for complete warranty details.

In the event that you must assemble or disassemble fittings, please follow these instructions:



1. Assemble desired male quick connect to the wall adapter port on the back of the regulator using Teflon tape or thread sealant.
2. Assemble the desired inlet fitting to the patient connection port bottom of the regulator using Teflon tape or thread sealant.
3. The regulator is now ready to be placed in service on your suction system.
4. For gastric suctioning procedures, position the patient port of the collection canister 12-18" above the patient. This will encourage slight fluid backflow through the catheter when the collection circuit is vented to atmosphere. This action tends to clear the catheter tip and maximize the removal of fluids.
5. An appropriately sized collection canister must be used in between the regulator and the patient connection.

Location	Configuration requirement	Order Number and Description	
Patient Connection Port	Suction tubing attached directly to the suction regulator	Model 2469 High Flow Bubble Barb	
	Suction regulator attached to collection canister, roll stand or trap bottle	Model 1487 DISS Body Adapter	
Wall Adapter Port	 Vacuum outlet requires a 90° twist to release the regulator	Model 1492 Diamond Ohio	
	 Vacuum outlet has a button to release the regulator	Model 1493 Chemetron (NCG) Rectangular Adapter	
	 The adapter screws onto the outlet and then is unscrewed to remove (approximately 3 turns)	Model 1504 DISS Hand-Tight Nut and Gland	

For special adapter requirements, please contact us at 800-642-4945.

MODE SELECTION

Models 7800 and 7840

Safety Release



OFF: With control valve in the OFF position, suction is off and the collection circuit is returned to atmospheric pressure by an internal vent port, a special feature of the Boehringer design.

REG: With control valve in the REG position, wall suction may be controlled to a specific level by turning the large adjusting knob in the direction indicated. A spring opposed diaphragm assembly precisely controls the level of suction provided at the lower port of the Regulator within the range of the gauge. This assembly "senses" changes in the patient collection circuit and makes appropriate adjustments to maintain the suction level that has been selected. Regulated settings are verified by the large, easy to read gauge. Model 7800 regulators incorporate a safe upper limit so they will not deliver any more than 230mmHg in this setting.

LINE: With control valve in the LINE position, the regulating mechanism is bypassed. Full wall suction is applied to the patient collection system through the lower port of the Regulator. The LINE suction mode is engaged by depressing the safety spring release and rotating the control valve to the line position. LINE setting is verified by the exposure of the "LINE" warning at the bottom of the gauge label.

CAUTION! Full line suction may cause damage to sensitive tissue.

Models 7804



OFF: With control valve in the OFF position, suction is off and the collection circuit is returned to atmospheric pressure by an internal vent port, a special feature of the Boehringer design.

INTERMIT: With control valve in the INTERMIT position, regulated suction to the patient is intermittently turned on and off (vented to atmosphere) at a nominal ratio of 2:1 (on:off). The ratio is not adjustable and the cycle time ('on' plus 'off' time) is set at the factory. If the cycle time needs to be adjusted, turn the timing screw (No. 31 on fig. 2) CCW to speed up the cycle time and CW to slow down the cycle time. Suction may be controlled by turning the large adjusting knob in the direction indicated. See CONTIN below for details of the suction control. Model 7804 regulators incorporate a safe upper limit so they will not deliver any more than 230mmHg in this setting.

CONTIN: With control valve in the CONTIN position, suction is continuous and may be controlled to a specific level by turning the large adjusting knob in the direction indicated. A spring opposed diaphragm assembly precisely controls the level of suction provided at the lower port of the Regulator within the range of the gauge. This assembly "senses" changes in the patient collection circuit and makes appropriate adjustments to maintain the suction level that has been selected. Regulated settings are verified by the large, easy to read linear gauge. Model 7804 regulators incorporate a safe upper limit so they will not deliver any more than 230mmHg in this setting.

MAINTENANCE

Your Boehringer Regulators have been designed to provide years of trouble free operation. Most service activity is the result of aspiration of bodily fluids or other foreign materials into the regulator. The routine use of an appropriate collection canister greatly reduces needed service. To determine your cleaning/maintenance schedule:

- Periodically inspect the overall condition of the instrument. Test the gauge accuracy and check the instrument function as described under 'Test'. Simply clearing the small orifices in the gauge view tube and the regulator body can remedy many performance conditions (see troubleshooting). Return to service if the instrument performs appropriately per the 'Test' requirements.
- Based on data from your periodic inspections, determine a cleaning/maintenance schedule appropriate for the operational conditions of your facility. Clean, inspect, lubricate, and test based on your schedule and according to the Instrument Cleaning and Disinfection, Instrument Lubrication and 'Test' section outlined below.

TEST

1. With the control valve in the REG or CONTIN position and a collection system attached with a 14 Fr. catheter, regulator should control vacuum from 10-100% of full scale (FS).
2. With the control valve in the REG or CONTIN position and housing turned all the way off, with suction port occluded, gauge should read zero.
3. With the control valve in the REG or CONTIN, adjust regulator to the middle of the scale and occlude the catheter. Gauge movement should be less than 10% of the setting. This measurement is called spike.
4. The gauge should be accurate to $\pm 5\%$ FS ($\pm 10\text{mmHg}$ for 7800 & 7804; $\pm 38\text{mmHg}$ for 7840) for any measurement within the range of the scale. If this is not the case, please return the gauge to the manufacturer for repair/replacement.

CAUTION: *Inaccurate gauge calibration may lead to a high suction condition applied to the patient.*

5. With the control valve in the OFF position, suction should be at atmospheric and gauge should read zero. With suction port occluded, gauge should read zero.
6. With the control valve in the REG or CONTIN position, with an appropriate collection system attached (>800cc capacity) set the Regulator to the middle of the scale and turn control valve to OFF, then back to REG or CONTIN. Gauge indicator should not travel more than 20% past the set point before settling at the desired level.
7. With the intermitter control valve in the INTERMIT position, the factory calibrated cycle will be 4-5 seconds OFF, with an ON time being a multiple of 1.6X – 3X the OFF time. Adjust the timing screw clockwise to speed up the cycle time and counter clockwise to slow down the cycle time.
8. A final, important step in instrument maintenance is the identification of the instrument. This confirms that a qualified individual performed service to accepted procedures and approved master gauges. An ID tag should accompany the instrument, which indicates (as a minimum): date of service, individual performing the service and the date of next service.

CAUTION: Have the regulator factory serviced if not performing to specifications. See Warranty and Repair on p.16 for details on getting your instrument factory serviced.

Cleaning & Disinfection

Please refer to Boehringer document 7700.192, Boehringer Suction Regulator Recommendations for Decontamination and Autoclaving for guidance. This information is available online at www.boehringerlabs.com, or toll-free at 1-800-642-4945.

DISASSEMBLY

Continuous Models 7800, 7840 (See Fig. 1)

Regulator:

1. Back out lock screw (18) on housing assembly (9) with 1/16 hex wrench.
2. Unscrew diaphragm housing (9) from regulator body.
3. Remove valve retaining screw (12) and washer (13) with 5/32 hex wrench. Pull out control valve. The control valve is factory matched to the particular regulator body. If multiple units are disassembled, take care to keep like parts mated.
4. In the unlikely event suctioned material should enter the regulator diaphragm housing, it will be necessary to disassemble and scrub the unit as follows:
 - a. Remove quad ring (6), lens cap retaining ring (1) and lens cap (2).
 - b. Push out diaphragm (3) by pressing on piston/stem assembly (4).
 - c. Remove piston/stem assembly (4) and spring (8).

Gauge:

5. Grasp the gauge housing in your hands or soft jawed pliers and carefully unscrew it from the regulator housing.

Disassembly – Intermittent Models 7804 (See Fig. 2)

Regulator:

1. Back out lock screw (7) on housing assembly (8) with 1/16 hex wrench.
2. Unscrew housing assembly (8) from regulator body.
3. Remove the dashpot cover (10) and filter (11). Remove the retaining ring (12).
4. Remove the cap (33), spring (30), piston (31) and diaphragm (32). Remove timing screw (34). Note the orientation of the diaphragm for reassembly.
5. Push the movable spool out and inspect for wear and corrosion. Inspect the ring (16) on the spool for misalignment and/or damage. The ring will have a small cut in it. This spool is factory matched to its mating control valve. If disassembling multiple units, take care to ensure like parts remain mated for reassembly.

Note: Only disassemble the relief valve (screw, ball and spring) if the spool needs cleaning. If the relief valve screw is removed, note its position and number of threads of insertion prior to removal and thread the screw back to the same position during reassembly. This sets the intermediate pressure that determines the timing of the spool valve.

6. Unscrew the dashpot body (18) and pull the intermitter control valve out of the regulator body. Remove the detent ball (28) and spring (27) from the regulator body. The regulator control valve is factory matched to its regulator body. If disassembling multiple units, take care to ensure like parts remain mated for reassembly.
7. Replace filter (25) in the regulator body if damaged or clogged. Remove by pressing out from bottom side or prying out with a small tool.
8. In the unlikely event suctioned material should enter the housing assembly (8), it will be necessary to disassemble and scrub the unit as follows:
 - a. Remove quad ring (6), retaining ring (1) and lens cap (2).
 - b. Push out diaphragm (3) by pressing on piston/stem assembly (4).
 - c. Remove piston/stem assembly (4) and spring (5).

Gauge:

9. Grasp the gauge housing in your hands or soft jawed pliers and carefully unscrew it from the regulator housing.

IMPORTANT: Always clean the unit prior to assembly. See Cleaning and Disinfection pg 10 for details.

ASSEMBLY

Assembly and Lubrication – Continuous Models 7800, 7804 (See Fig. 1)

After disassembling and cleaning the instrument, assemble and lubricate as follows. Parts are available from Boehringer Laboratories, LLC and may be ordered by part number (P/N). Part numbers are found in figure 1 at the end of this manual.

1. Lubricate control valve over entire mating surface with synthetic lubricant (P/N 1895).
2. Rotate valve as you insert it into the body. Remove the valve and inspect for dry areas. The valve must have a thin layer of lubricant over its entire diameter without excess in the cross ports.
3. Lubricate the threaded sleeve in diaphragm housing (9) and U-cup (11) with a light coat of synthetic lubricant (P/N 1895).
4. Assemble diaphragm housing in reverse order of disassembly. Do not lubricate the stainless steel shaft of the piston/stem assembly (4) or the inside of the threaded sleeve (9).
5. Inspect quad ring seal (6) for cuts or wear. Replace if needed.
6. Assemble unit in reverse order of disassembly. Place spring (8) on piston/stem assembly (4) and then insert through diaphragm housing assembly (9).
7. Cover piston/stem assembly (4) with lens cover (2) and snap lens cap retaining ring (1) into groove.
8. Assemble quad ring (6) to stem (4), then screw housing into body.
9. Tighten lock screw (18) to retain diaphragm housing on regulator body groove. Typically this is screwed all of the way in, and backed out $\frac{1}{2}$ - $\frac{3}{4}$ of a turn. Ensure this screw does not drag as the regulator setting is adjusted.
10. Insert the control valve, and position the valve retaining washer (13) before securing it with the valve retaining screw (12)

Gauge:

11. A small amount of Teflon tape may be used to seal the threads of the gauge to the regulator housing. Tighten this gauge by hand taking care to ensure an adequate seal and viewing orientation.

Regulator:

IMPORTANT: Always clean the unit prior to assembly. See Cleaning and Disinfection pg 10 for details.

Assembly and Lubrication – Intermittent Models 7804

After disassembling and cleaning the instrument, assemble and lubricate as follows. Parts are available from Boehringer Laboratories and may be ordered by part number (P/N). Part numbers are found in Fig. 1 at the end of this manual.

Intermitter Control Valve

1. Dry all parts to remove excess moisture before assembly. If Autoclaved, the piston (31) may not fit properly in the control valve (29) due to swelling of the outside diameter. If this is the case, allow the piston to air dry for 1 hour and try again. The piston should return to original size within 6 hours. Heated drying (max 270°F) can accelerate the drying process.
2. Seat the diaphragm (32) into the cap (33). The mold mark goes toward the cap. Seat the piston (31) into the diaphragm pocket. Seat the spring (30) into the piston. Holding this assembly, seat the spring into the groove of the intermitter control valve (29), compress the assembly and screw the cap onto the intermitter control valve. Fully seat the cap against the intermitter control valve. Replace timing screw (34).
3. Lightly lubricate the intermitter control valve over the entire OD mating surface with synthetic oil (P/N 1895).

4. Rotate the intermitter control valve as you insert it into the regulator body (26). Remove the intermitter control valve and inspect for dry areas. The intermitter control valve must have a thin layer of lubricant over its entire diameter without excess in the cross-ports and grooves. Place the detent spring (27) and ball (28) into the regulator body and reinsert the control valve into the body.
5. Thread on the dashpot body (18) and hand tighten to the stop. The control valve must rotate freely through its 3 positions.
6. Reinstall the relief valve screw, ball, and spring into the spool, if necessary. See step 5 of Disassembly above.
7. Install the spool ring (16) and insert the spool (17) into the control valve. DO not apply any lubricant to the OD of the spool or the ID of the control valve. Check for a smooth fit/feel. It is normal to feel resistance when near the full insertion.
8. Install the retaining ring (12), filter (11) and vinyl cap (10)

Gauge:

9. A small amount of Teflon tape may be used to seal the threads of the gauge to the regulator housing. Tighten this gauge by hand taking care to ensure an adequate seal and viewing orientation.

Regulator:

10. Lubricate the threaded sleeve in diaphragm housing (8) and U-cup (11) with a light coat of synthetic lubricant (P/N 1895).
11. Assemble diaphragm housing in reverse order of disassembly. Do not lubricate the stainless steel shaft of the piston/stem assembly (4) or the inside of the threaded sleeve (7).
12. Inspect quad ring seal (6) for cuts or wear. Replace if needed.
13. Assemble unit in reverse order of disassembly. Place spring (5) on piston/stem assembly (4) and then insert through diaphragm housing assembly (7).
14. Cover piston/stem assembly (4) with lens cover (2) and snap lens cap retaining ring (1) into groove.
15. Assemble quad ring (6) to stem (4), then screw housing into body.
16. Tighten lock screw (7) to retain diaphragm housing on regulator body groove. Typically this is screwed all of the way in, and backed out $\frac{1}{2}$ - $\frac{3}{4}$ of a turn. Ensure this screw does not drag as the regulator setting is adjusted.

IMPORTANT! Always test the reassembled unit after each maintenance procedure.

 See the Test section, page 9, for exact test procedure.

TROUBLESHOOTING

Complete Technical Manuals and Service Bulletins can be found at
<http://www.boehringerlabs.com/support/suction-regulator-technical-manuals.php>

Video Tips and Techniques for use and repair can be found at:
<http://www.boehringerlabs.com/support/video/product-videos.php>
<http://www.youtube.com/boehringerlabslc>

Boehringer Suction Regulators have been designed for years of trouble-free service. Should you experience difficulty that is not the result of damage to the instrument, the most likely cause is aspiration of dirt and/or fluids into the Regulator.

Symptom	Probable Cause	Solution
Instrument fails to provide suction at the patient port.	The supply or patient fittings are clogged	Replace or clean the fittings
Instrument will not shut off or exhibits high spike.	Dried fluids may have cut the quad ring seal.	Replace the quad ring (5) and Test the unit as per above procedure.
Instrument exhibits high spike or gauge flutters on dead ended circuit.	The small brass orifice on the side of the regulator may be clogged.	Using a small diameter probe, pieces the hole to clear the obstruction. On models 3704, 3714 this orifice is underneath (18) dashpot body.
Instrument fails to regulate suction	Piston/Stem surface is binding with foreign matter	Disassemble and clean the instrument.
The unit will not intermit, or intermits too fast or too slow	The Timing Screw is not adjusted properly	Adjust timing screw (31) CCW to speed up and CW to slow down.

IMPORTANT! Always test the reassembled unit after each maintenance procedure.

SPECIFICATIONS

- Inlet and outlet fittings: 1/8 NPT
- Gauge accuracy ANSI Class B, $\pm 3\%$ FS (± 6 mmHg 7800&7804 ; ± 23 mmHg 7840)
- Regulation Accuracy: $\pm 10\%$ FS from full flow to zero flow with 14 FR catheter attached.
- Leak rate in OFF position: less than 1 cc/min
- Free Air Flow: Greater than 38 LPM with regulator set to 100 mmHg at standard JCAHO supply (305mmHg @ 180 SCFH) and a typical collection circuit.
- Materials: polycarbonate, hard-anodized aluminum, stainless steel, Buna rubber, acetal copolymer.

Model	Regulation Range	User Selectable Modes	Wt. (lb)*	H x W x D (in)
7800	20-200 mm Hg	Off, Regulated Control, Line (source vacuum)	1.35	5½ x 2½ x 4
7804	20-200 mm Hg	Off, Intermitting, Continuous	1.64	5¾ x 4 x 4
7840	76-760 mm Hg	Off, Regulated Control, Line (source vacuum)	1.35	5½ x 2½ x 4

*Regulator weights are without fittings.

Intermitting Specifications - Model 7804

- Intermit Cycle: User adjustable, factory adjusted to a nominal 8:4 secs (On:Off) @ 500 mmHg supply.
- Intermit Ratio: Fixed, nominal 2:1 On:Off @ 500 mmHg supply

Operating and Storage Limits

We recommend that Boehringer Suction regulators be operated and stored at controlled conditions that typically reflect the medical facility environment.

ACCESSORIES



Float Vacuum Safety Bottle – Model 9100

This device will protect your regulators and suction system from fluid overflow. The bottle provides a 250 ml backup overflow volume with shut-off capability provided by a precision float mechanism.

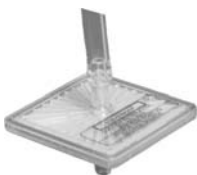

Inline Filter – Model 7791

This device will protect your regulators and suction system from fluid overflow. It is a hydrophobic, high flow, 1.0 micron filter and can be EtO sterilized. The filter goes in the patient circuit between the waste canister and the regulator.

Warranty and Repair

The 7800 Series Suction Regulators have a FIVE year warranty with the exception of the gauge which has a THREE year warranty. Boehringer Laboratories, LLC will also warrant all fittings purchased from and installed by Boehringer Laboratories, LLC for the same warranty period as the suction regulator on which they were originally installed.

Boehringer Laboratories, LLC warrants to the original purchaser, new suction regulators purchased directly from Boehringer Laboratories, LLC or from an authorized dealer or representative. This warranty guarantees the suction regulators to be free from functional defects in materials and workmanship. We also guarantee that our suction regulators will meet our published specifications.

All regulators returned for repair shall be clean and free from contamination prior to shipment to Boehringer Laboratories. This requirement is for the safety of our employees as well as to comply with Federal Law prohibiting the shipment of unmarked biohazard materials. If units are returned contaminated, a cleaning charge may result.

A service charge may be assessed on any unit returned that shows evidence of gross abuse.

Boehringer Laboratories, LLC is the only authorized warranty service center for our suction regulators. Any repair service requesting a return authorization for repair will be asked to provide the name and location of the original equipment purchaser. If this information cannot be provided, the repair is not covered under warranty and will be a chargeable repair.

This warranty excludes acts of God, fire, flood and acts of war, terror or insurrection.

This warranty is not transferable from the original purchaser.

Boehringer Laboratories' sole and exclusive remedy under this warranty is limited to repairing and/or replacing the suction regulator. There are no other express or implied warranties beyond these warranties set forth above. At Boehringer Laboratories, we are committed to lowering your suction regulator costs of operation!



All repairs will be shipped back within five days of receipt of purchase order authorization.

For quality factory service, call 800-642-4945 or 610-278-0900 for your return authorization. Ship returns to:

**Boehringer Laboratories, LLC
Repair Department
300 Thoms Dr.
Phoenixville, PA 19460**

New Products

We are continually striving to reach higher and higher standards of quality. We value your comments and input on our suction regulators. If you are pleased with this instrument, please find out more about Boehringer Laboratories' complete line of suction controls.

FIGURE 1
Models 7800 (pictured), 7840

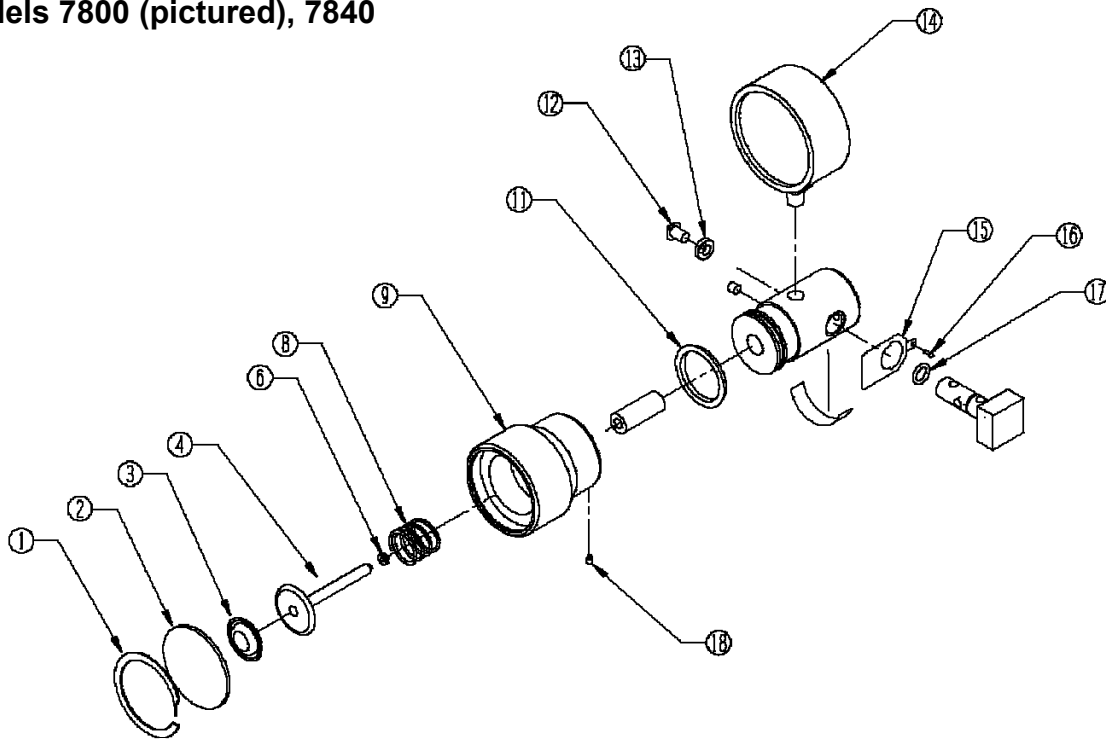

<u>No.</u>	<u>P/N</u>	<u>Description</u>	<u>No.</u>	<u>P/N</u>	<u>Description</u>
1	1465BK	Lens Cap Retaining Ring	12	1468	Control Valve Screw
2	33769	Lens Cap, Model 7800	13	1454	Washer
2	33771	Lens Cap, Model 7840	14	9071	0-200mmHg Gauge (7800)
3	1466	Regulating Diaphragm	14	2277	0-760mmHg Gauge (7840)
4	2297	Piston/Stem Assembly	15	1462	Thumb Spring
6	1461	Quad Ring	16	1480	Thumb Spring Screw
8	1464	Spring, 200 mm Hg (7800)	17	353	O-Ring
8	1501	Spring, 760 mm Hg (7840)	18	1479	Dog point screw
9	33779	Diaphragm Housing Ass'ly			
8	1479	Lock Screw			
9	1468	Control Valve Retaining Screw			
10	1454	Control Valve Retaining Washer			
11	1484	U-cup			

The Control Valve and Regulator Body are factory matched, take care not to interchange parts between units when servicing. For parts not available for sale from this breakaway drawing please consult the factory for appropriate service details.

**FIGURE 2 –
Model 7804**

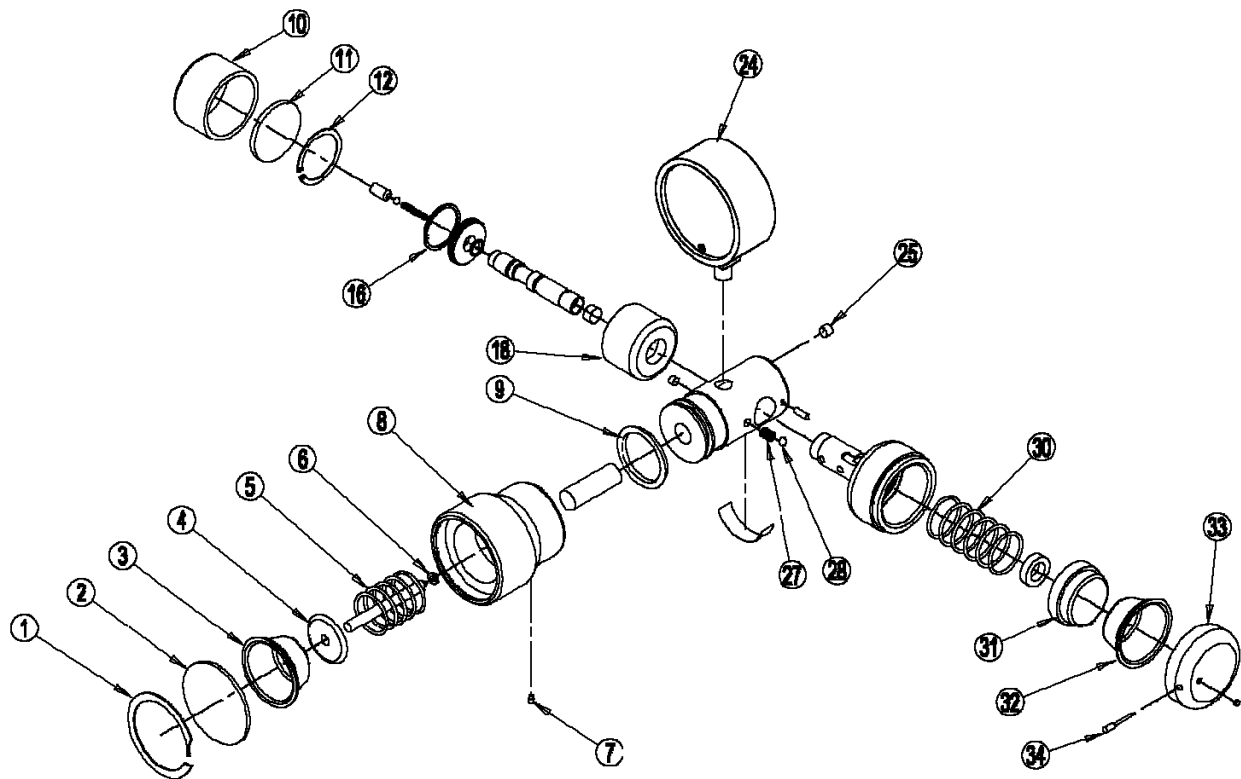

<u>No.</u>	<u>P/N</u>	<u>Description</u>	<u>No.</u>	<u>P/N</u>	<u>Description</u>
1	1465BK	Lens Cap Retaining Ring	18	33418AN	Dashpot Body
2	33770	Lens Cap, Model 7804	24	9071	0-200mmHg dial gauge
3	1466	Regulating Diaphragm	25	33136	Filter
4	2297	Piston/Stem Assembly	27	33124	Detent Spring
5	1464	Spring, 0-200mmHg	28	33311	Detent Ball
6	1461	Quad Ring	30	33429	Intermitter Spring
7	1479	Lock Screw	31	33194	Intermitter Piston w/magnet
8	33779	Diaphragm Housing Assy.	32	33070	Intermitter Diaphragm
9	1484	U-Cup	33	33067AN	Cap
10	33419	Dashpot Cover	34	33260	Timing Screw
11	33423	Dashpot Filter	35	33045	Cap Filter
12	33440	Dashpot Retaining Ring	36	33610	Gauge O-ring
16	33421	Dashpot Split Ring			
17	33426	Spool' with Magnet and Ring			

The Spool, Control Valve, and Reg Body are factory matched, take care not to interchange parts between units when servicing. For parts not available for sale from this breakaway drawing please consult the factory for appropriate service details.

BOEHRINGER®

Boehringer Laboratories, LLC
300 Thoms Dr.
Phoenixville, PA 19460

For
Customer Service
Or
Technical Support

800-642-4945

www.boehringerlabs.com

***A free trial evaluation
of any of our suction regulators
can be arranged by calling
(800) 642-4945 or 610-278-0900.***