

HOOVER

USER MANUAL

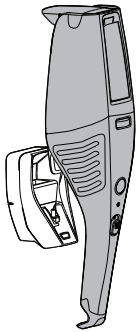

GENERATION FUTURE

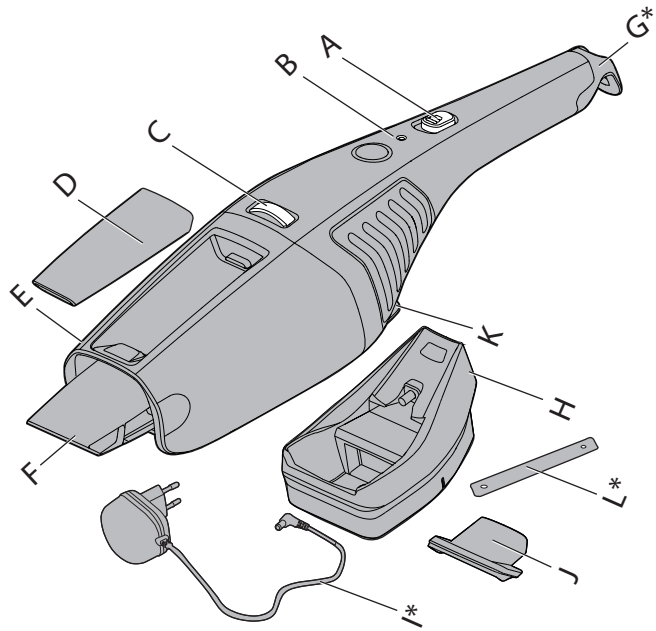

1



2

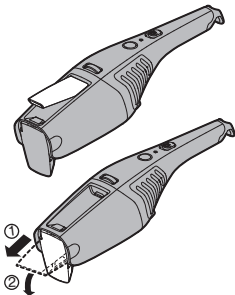

3

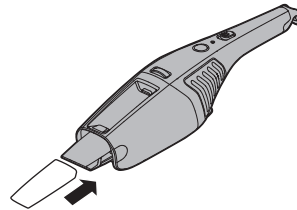

4

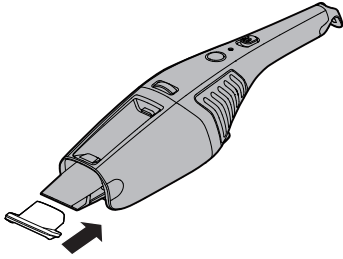

5

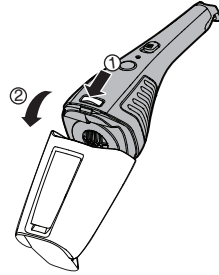

6

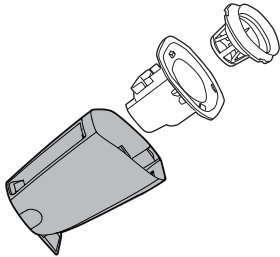

7

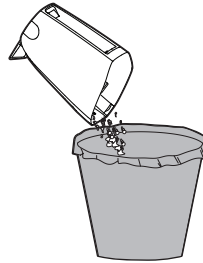

8

INSTRUCTIONS FOR SAFE USE

This appliance should only be used for domestic cleaning, as described in this user guide. Please ensure that this guide is fully understood before operating the appliance.

Always switch off and remove the charger from the socket before cleaning the appliance or any maintenance task.

This appliance can be used by children aged from 8 years and above and persons with reduced physical, sensory or mental capabilities or lack of experience and knowledge if they have been given supervision or instruction concerning use of the appliance in a safe way and understand the hazards involved. Children shall not play with the appliance. Cleaning and user maintenance shall not be made by children without supervision.

If the power cord is damaged stop using the appliance immediately. To avoid a safety hazard, an authorised Hoover service engineer must replace the power cord.

Battery Charging

Never touch the charger with wet hands.

Use only the original charger supplied with the appliance.

Check that your supply voltage is the same as that stated on the charger.

Before being charged the main product must be switched off.

Never charge the batteries in temperatures above 37°C or below 0°C.

Plug the charger delivered with this appliance into a suitable socket.

Do recharge the batteries with Adaptor*/Charging Base*. Occasionally fully discharge the batteries to obtain maximum battery life.

It is normal for the charger to become warm to the touch when charging.

Use only attachments, consumables or spares recommended or supplied by Hoover.

Do frequently clean the dust bin and filter assembly when picking up fine powder.

Do not pick up hard or sharp objects, matches, hot ashes, cigarette ends or other similar items.

Do not spray with or pick up flammable liquids, cleaning fluids, aerosols or their vapours.

Do not continue to use your appliance or charger if it appears faulty.
Hoover service: To ensure the continued safe and efficient operation of this appliance we recommend that any servicing or repairs

are only carried out by an authorised Hoover service engineer.

Do not use the appliance to clean animals or people.

Do not immerse the complete cleaner in liquids, only the nozzle end.

Do not pick up large volumes of liquid.

Do not replace the batteries with non-rechargeable batteries.

Do not use your appliance outdoors.

End of life battery removal

If the appliance is to be disposed of the batteries must first be removed. The appliance must be disconnected from the supply mains when removing the battery. Dispose of the batteries safely. Run the appliance until it stops because the batteries are fully discharged. Used batteries should be taken to a recycling station and not disposed of with household waste. To remove the batteries, please contact the Hoover Customer Centre or proceed according to the following instructions.

Remove dust container. Unscrew 3 screws and open the unit. Remove motor assembly and disconnect the cables. Remove the batteries.

Note: Should you experience any difficulty in dismantling the unit or for more detailed information on treatment, recovery and recycling of this appliance, please contact your local city office or your household waste disposal service.

The Environment

The symbol on this appliance indicates that this appliance may not be treated as household waste. Instead it must be handed over to the applicable collection point for the recycling of electrical and electronic equipment. Disposal must be carried out in accordance with local environmental regulations for waste disposal. For more detailed information about treatment, recovery and recycling of this appliance, please contact your local city office, your household and waste disposal service or the shop where you purchased the appliance.



This appliance complies with the European Directives 2006/95/EC, 2004/108/EC and 2011/65/EU.

HOOVER Limited, Pentrebach, Merthyr Tydfil, Mid Glamorgan, CF48 4TU, UK

FEATURES

- | | |
|----------------------------|--------------------|
| A. On/off Switch | G. Storage Hook |
| B. Charging Indicator | H. Charging Base* |
| C. Dust Cup Release Button | I. Adaptor* |
| D. Crevice Tool | J. Squeegee Tool |
| E. Dust Cup | K. Charging Socket |
| F. Nozzle | L. Measure* |

Electrical requirements.

This HOOVER appliance is supplied with a double insulated battery charger which is only suitable for insertion in a 230V (UK 240V) socket outlet. Ensure that the Charging rating label matches your voltage supply.

STORAGE/CHARGING

MOUNT Charging BASE* (* only for certain models)

TOOLS REQUIRED: SCREWDRIVER AND DRILL

CHARGING/STORAGE BASE

Designed to sit in the charging base on a flat surface or mount vertically. [1]

For tidy storage wrap excess cord on the back of the charging base and exit either side or bottom.

TO WALL MOUNT

1. Place the Measure* on the mounting surface vertically. Mark the centres of the holes.
2. Move the Measure* then drill 4.8mm holes.
3. Fit wall plug.
4. insert the Rawlplugs into the holes, and adjust the screws height to ensure Charging Base* is fixed firmly to the mounting surface.

UNIT STORAGE

Hold the unit by the handle and push firmly down onto the Charging base*.

Be sure that the red light is on to indicate charging.

Other storage methods are hanging the unit up using the storage hook, or adjusting Nozzle [3] to allow the unit to stand upright. [2]

CHARGING

NOTE: Use only the charger supplied with your cleaner to recharge, leave the appliance to charge for at least 16 hours

IMPORTANT: BEFORE FIRST USE, CHARGE YOUR CLEANER FOR AT LEAST 24 HOURS.

When charging the Cleaner power switch must be Off.

Keep the charger plugged into a Charging Socket at all times. It is normal for the charger to become warm to the touch when charging.

If the operating time reduces after repeated use, let the cleaner run until it stops, then recharge for 24 hours and repeat this monthly for best results.

IMPORTANT: Never charge the batteries in temperatures above 37°C or below 0°C.

HOW TO USE

TO USE: Remove cleaner from storage base, slide the power switch to the ON position. Empty and clean the unit and filter after each use or when the unit becomes full.

ATTACHMENTS

CREVICE TOOL

The crevice tool is used to clean corners and hard to reach areas and is stored on board the dust cup. To use, remove the crevice tool from the dust cup [3] then fit the crevice tool onto the nozzle to clean corners and hard to reach areas. [4]

*certain models only

WET PICK-UP

The Squeegee Tool is stored in the Charging Base*. Fit the Squeegee Tool into the Container nozzle to assist in collecting liquids. [5] Do not fill beyond the Max. Line.

Important: Always keep the cleaner vertical (nozzle end down) during and after collection of liquids, to prevent spillage or liquid entering the motor. Always empty the liquid out of the Container immediately after use. Do not pick up solvent based solutions, inflammable or combustible liquids. After picking up liquids, the Container, Deflector and Filter MUST be thoroughly dried and the squeegee removed before picking up dry dust.

CONTAINER & FILTER: REMOVAL and REPLACEMENT

IMPORTANT: FOR BEST RESULTS CLEAN THE DEFLECTOR AND FILTER AFTER EACH USE

1. Holding cleaner in the vertical position, depress the release button and remove Container assembly.[6]
2. Gently remove Filter and Deflector. Empty the Container.[7]
3. Brush the dust and dirt off the filter or shake the filter inside the waste bin.[8]
4. The Container, Deflector and Filter may be washed in warm soapy water, make sure all are completely dry before replacing in your cleaner.
5. Replace the Deflector and Filter into the Container and reassemble the Container to the cleaner

End of product life battery disposal.

If the cleaner is to be disposed of the batteries should be removed. Used batteries should be taken to a recycling station and not disposed with household waste.

IMPORTANT: Always fully discharge the batteries before removal.

Battery removal

Remove dust container. Unscrew 3 screws and open the unit. Remove motor assembly and disconnect the cables. Remove the batteries.

Note: Should you experience any difficulties in dismantling the unit or for more detailed information about treatment, recovery and recycling of this product, please contact your local city office, your household waste disposal service.

YOUR GUARANTEE

The guarantee conditions for this appliance are as defined by our representative in the country in which it is sold. Details regarding these conditions can be obtained from the dealer from whom the appliance was purchased. The bill of sale or receipt must be produced when making any claim under the terms of this guarantee. Subject to change without notice.

HOOVER spares and Consumables

Always replace parts with genuine HOOVER spares. These are available from your local HOOVER dealer or direct from HOOVER. When ordering parts always quote your model number.

Wet and Dry Filter - T112 35601350

*certain models only



®

GENERATION FUTURE

PRINTED IN P.R.C
48016205