

# *Grizzly* *Industrial, Inc.*®

## SPRAY GUN MODEL G5352 INSTRUCTION MANUAL



COPYRIGHT © MAY, 2006 BY GRIZZLY INDUSTRIAL, INC.  
WARNING: NO PORTION OF THIS MANUAL MAY BE REPRODUCED IN ANY SHAPE  
OR FORM WITHOUT THE WRITTEN APPROVAL OF GRIZZLY INDUSTRIAL, INC.  
#PC8211 PRINTED IN TAIWAN

# SECTION 1: SAFETY

## **WARNING**

### **For Your Own Safety Read Instruction Manual Before Operating This Equipment**

The purpose of safety symbols is to attract your attention to possible hazardous conditions. This manual uses a series of symbols and signal words which are intended to convey the level of importance of the safety messages. The progression of symbols is described below. Remember that safety messages by themselves do not eliminate danger and are not a substitute for proper accident prevention measures.



Indicates an imminently hazardous situation which, if not avoided, WILL result in death or serious injury.



Indicates a potentially hazardous situation which, if not avoided, COULD result in death or serious injury.



Indicates a potentially hazardous situation which, if not avoided, MAY result in minor or moderate injury. It may also be used to alert against unsafe practices.

**NOTICE**

This symbol is used to alert the user to useful information about proper operation of the equipment.

## **WARNING**

### **Safety Instructions For Pneumatic Tools**

- KEEP ALL SAFETY DEVICES IN PLACE** and in working order.
- REMOVE ADJUSTING KEYS AND WRENCHES.** Form habit of checking to see that keys and adjusting wrenches are removed from tool before operation.
- KEEP WORK AREA CLEAN.** Cluttered areas and benches invite accidents.
- DO NOT USE IN DANGEROUS ENVIRONMENT.** Do not use pneumatic tools in damp or wet locations, or where any flammable or noxious fumes may exist. Keep work area well lighted.
- KEEP CHILDREN AND VISITORS AWAY.** All children and visitors should be kept at a safe distance from work area.
- MAKE WORKSHOP CHILD PROOF** by locking your shop and shutting off air valves.
- DO NOT FORCE TOOL.** It will do the job better and safer at the rate for which it was designed.
- USE THE RIGHT TOOL.** Do not force tool or attachment to do a job for which it was not designed.
- DO NOT USE UNDER THE INFLUENCE OF DRUGS OR ALCOHOL.**

# **WARNING**

## **Safety Instructions For Pneumatic Tools**

10. **USE PROPER AIR HOSE** for the tool. Make sure your air hose is in good condition and is long enough to reach your work without stretching.
11. **WEAR PROPER APPAREL.** Do not wear loose clothing, gloves, neckties, rings, bracelets, or other jewelry which may get caught in moving parts. Non-slip footwear is recommended. Wear a protective hair covering to contain long hair.
12. **ALWAYS USE SAFETY GLASSES.** Also use a face or dust mask if cutting operation is dusty. Everyday eyeglasses only have impact resistant lenses—they are NOT safety glasses.
13. **WEAR APPROVED HEARING PROTECTION.** Air escaping from pneumatic tools can exceed safe exposure limits and may cause hearing damage with prolonged exposure.
14. **SECURE WORK.** Use clamps or a vise to hold work when practical. It is safer than using your hand and frees both hands to operate tool.
15. **MAINTAIN TOOLS WITH CARE.** Keep tools lubricated and clean for best and safest performance. Follow instructions for lubricating and changing accessories.
16. **REDUCE THE RISK OF UNINTENTIONAL STARTING.** Do not carry tool with hand on trigger and always disconnect from air when not in use.
17. **DISCONNECT TOOLS** before servicing and changing accessories.
18. **DO NOT OVERREACH.** Keep proper footing/balance at all times.
19. **USE THE RECOMMENDED ACCESSORIES.** Consult owner's manual for recommended accessories. The use of improper accessories may cause risk of injury.
20. **CHECK FOR DAMAGED PARTS BEFORE USING.** Check for binding and alignment of parts, broken parts, part mounting, loose bolts, and any other conditions that may affect machine operation. Repair or replace damaged parts.
21. **NEVER LEAVE UNATTENDED TOOL CONNECTED TO AIR.** Disconnect the air hose and do not leave tool until it is relieved of any built up pressure.
22. **NEVER ALLOW UNTRAINED USERS TO USE THIS TOOL WHILE UNSUPERVISED.**
23. **IF YOU ARE UNSURE OF THE INTENDED OPERATION, STOP USING TOOL.** Seek formal training or research books or magazines that specialize in pneumatic tools.
24. **BE AWARE OF HOSE LOCATION WHEN USING PNEUMATIC TOOLS.** Hoses can easily become a tripping hazard when laid across the floor or spread out in a disorganized fashion.

# WARNING

## Additional Safety Instructions for Spray Guns

- 1. READ THIS MANUAL.** This manual contains proper operating instructions for this spray gun.
- 2. READ MATERIAL LABELS and MATERIAL SAFETY DATA SHEETS (MSDS).** Read and know all the instructions on the packaging label and the MSDS before opening the package. This information could save your life.
- 3. RESPIRATORY PROTECTION.** Always wear a NIOSH approved respirator when spraying or working around finishing materials.
- 4. FIRE EXTINGUISHERS.** Always have a fully charged multi-class or class B fire extinguisher in the immediate area.
- 5. FLAMMABLE MATERIAL.** NEVER spray near open flame or where any spark could occur.
- 6. FRESH AIR.** Always provide adequate exhaust to keep area free of built-up vapors. NEVER spray in an enclosed space.
- 7. DISCONNECT COMPRESSED AIR.** Always disconnect the spray gun from compressed air before cleaning, changing attachments or when performing maintenance of any kind on this tool.
- 8. PROTECTIVE CLOTHING.** Protect exposed skin from overspray by wearing a protective suit or other approved garment.
- 9. INAPPROPRIATE USE.** DO NOT point or shoot spray gun directly at yourself or another person or animals. Do not attempt to use the spray gun for any other use than it was intended.
- 10. STORAGE.** Thoroughly clean and dry spray gun before storage. Store in an approved cabinet.
- 11. SOLVENTS.** Always store solvents and shop towels soaked in solvent in approved containers.
- 12. EYE PROTECTION.** Wear eye protection whenever spraying or cleaning. Solvents and chemicals can cause serious eye injury, which could lead to blindness.
- 13. OPERATING PRESSURE.** DO NOT exceed the recommended inlet air pressure. Excessive pressure could cause the spray gun to burst or cause other internal equipment damage.
- 14. LOCAL LAWS.** Consult local authorities regarding exhaust and waste disposal requirements.

# SECTION 2: INTRODUCTION

---

---

## Foreword

---

---

We are proud to offer the Grizzly Model G5352 Spray Gun. This model is part of a growing Grizzly family of fine tools. When used according to the guidelines set forth in this manual, you can expect years of trouble-free, enjoyable operation, and proof of Grizzly's commitment to customer satisfaction.

It is our pleasure to provide this manual with the Model G5352. It was written to encourage safety considerations and guide you through general operating procedures and maintenance.

The specifications, details, and photographs in this manual represent the Model G5352 as supplied when the manual was prepared. However, owing to Grizzly's policy of continuous improvement, changes may be made at any time with no obligation on the part of Grizzly.

## Contact Information

---

---

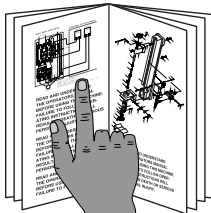
If you have any comments regarding this manual, please write to us at the following address:

Grizzly Industrial, Inc.  
C/O Technical Documentation  
P.O. Box 2069  
Bellingham, WA 98227-2069

Most importantly, we stand behind our tools. If you have any service questions or parts requests, please call or write us at the location listed below.

Grizzly Industrial, Inc.  
1203 Lycoming Mall Circle  
Muncy, PA 17756  
Phone: (570) 546-9663  
Fax: (800) 438-5901  
E-Mail: [techsupport@grizzly.com](mailto:techsupport@grizzly.com)  
Web Site: <http://www.grizzly.com>

**⚠ WARNING**



**Read the manual before operation. Become familiar with this tool, its safety instructions, and its operation before beginning any work. Serious personal injury may result if safety or operational information is not understood or followed.**

**GRAVITY FEED SPRAY GUN MODEL  
G5352**

<b>MODEL</b>	<b>G5352</b>
<b>CUP SIZE</b>	600 ml
<b>TYPE OF FEED</b>	Gravity
<b>FLUID TIP</b>	1.4 mm
<b>AIR CONSUMPTION</b>	5 CFM
<b>INLET AIR PRESSURE</b>	1.5-3.5 BAR 21-50 PSI
<b>FLUID PRESSURE</b>	Greater Than 10 PSI
<b>CUP MATERIAL</b>	Aluminum
<b>MAX. PATTERN WIDTH</b>	250mm
<b>BODY MATERIAL</b>	Painted Metal
<b>MATERIAL USAGE</b>	Medium Solids, i.e.. Enamels & Lacquers
<b>WATERBORNE MATERIAL COMPATIBLE</b>	NO

# SECTION 3: SET UP

## Inventory

Your spray gun left our warehouse in a carefully packed box. If you discover the spray gun is damaged after you have signed for delivery, *please immediately call Customer Service at (570) 546-9663 for advice.*

Save the containers and all packing materials for possible inspection by the carrier or its agent. *Otherwise, filing a freight claim can be difficult.*

After you have unpacked the carton you should find the following:

### Model G5352 Inventory (Figure 1)

- A. Large Spray Gun ..... 1
- B. Cup ..... 1
- C. Service Wrench..... 1
- D. Cleaning Brush ..... 1
- E. Baffle Wrench ..... 1
- F. Spare Filter ..... 1

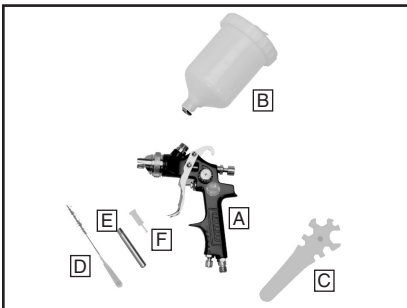


Figure 1. Model G5352 inventory.

## Assembly

Prior to assembling and using the spray gun, it is essential that all parts be thoroughly cleaned and dried. Please refer to **Cleaning** in the **MAINTENANCE** section on **Page 13** for more detailed instructions.

Make sure all connections are tight enough to prevent air leaks but not so tight as to damage the tool.

### To assemble the spray gun:

1. Insert the filter into the gun body (see **Figure 2**).

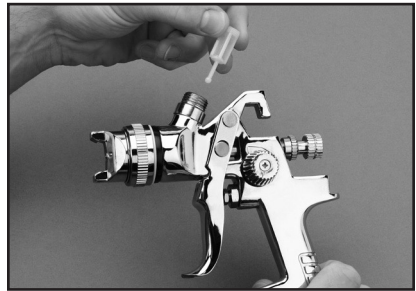


Figure 2. Installing filter.

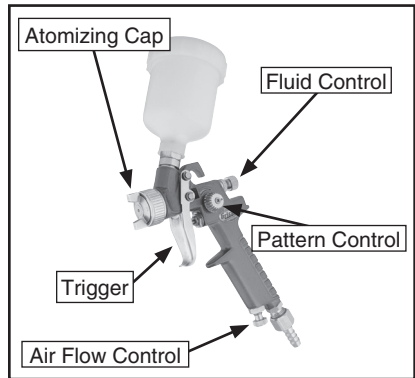
*Continued on next page* →

2. Screw the cup onto the top of the body.
3. Attach the air hose directly to the air fitting on the spray gun or with a ¼" NPT quick connect fitting (not included).
4. Attach the spray gun to a filtered, regulated air source. See the **Tool Data Sheet** on **Page 8** for your spray gun air requirements.

**Note:** For the best results, use a hose that will be dedicated for spray use only. Do not use a hose that has been used with an in-line oiler or other possible contaminant.

If you need additional help with this assembly, call our Technical Support at: (570) 546-9663.

## Controls



**Figure 3.** Controls.

1. **Fluid Control:** Controls the volume of material that travels through the fluid tip.
2. **Pattern Control:** Adjusts the spray pattern from a round pattern to a wide fan.
3. **Air Flow Control:** Controls the fluid pressure inside the spray gun.
4. **Atomizing Cap:** Controls the spray pattern from vertical to horizontal.
5. **Trigger:** Two stage trigger. Stage one only releases compressed air for blowing off the work piece. Stage two sprays material. Lightly squeeze the trigger for stage one. Squeeze the trigger all the way to spray.



# SECTION 4: OPERATIONS

**! DANGER**



**EXPLOSION HAZARD! DO NOT smoke or have any source of flame or spark near spraying. Vapors will explode if ignited.**

**! WARNING**



**RESPIRATORY HAZARD! Always use a NIOSH approved respirator when using spray equipment. Failure to protect your lungs can lead to respiratory illness and nervous system damage.**

**! WARNING**



**TOXIC FUMES! Always use an approved spray booth or well ventilated area when spraying. NEVER spray in a confined space where toxic fumes and flammable vapors can accumulate to deadly levels.**

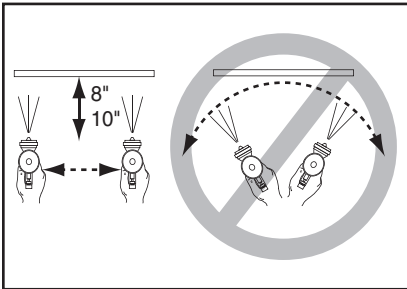
## Spraying

The Model G5352 gravity feed spray gun set is designed to spray a wide variety of materials such as lacquers, stains, primers, multi-component paints, clear coats, acrylics, epoxies etc. It is ideal for auto body and woodworking projects. The spray guns are not designed to be used with waterborne materials.

### To use your spray gun:

1. Read and follow the material manufacturer's instructions for spraying, mixing, safety, disposal, and any other instruction on the label or Material Safety Data Sheet (MSDS).
2. Ensure the cup is securely tightened and all other fittings are secure to avoid air leaks or material spills.
3. Set the inlet air pressure (the air coming to the spray gun) to the lowest pressure recommended in **Tool Data Sheet** on **Page 6** or to the material manufacturer's recommendations.
4. Adjust the atomizing cap to vertical or horizontal. See **Atomizing Cap and Fan Adjustments** on **Page 11** for further explanation.
5. Fill the cup with material.
6. Trial and error are necessary to achieve the results you want along with a fair amount of practice. Test your material flow and spray pattern on a piece of cardboard or some scrap of material similar to your project.

7. Adjust the fluid control knob to start with a low volume of material and keep the atomization as low as possible. You will need to use a combination of fluid control, inlet air pressure, air flow control and stroke speed to achieve the results you want. Spray so the material wets out nicely without running or sagging.
8. Use the pattern control knob to adjust the spray fan to your desired pattern.
9. Keep the gun tip perpendicular, parallel and 8-10" from the work at all times when spraying as shown in **Figure 4**. Do not allow your wrist to bend. This will cause the gun to arc across the surface and distribute the material unevenly, possibly creating sags and dry spots.

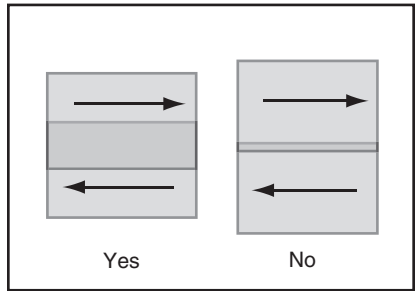


**Figure 4.** Spray technique.

## **NOTICE**

Tipping the spray gun may cause material to spill out of the cup. Always hold the spray gun perpendicular to the ground to avoid potential spills and feed problems.

10. Begin spraying 2-3 inches before the work and continue to the end of the work. Continue the motion for a few inches past the work until you are ready for the return stroke.
11. Maintain an even speed when spraying.
12. Overlap each stroke by 50%. This will ensure even coverage as shown in **Figure 5**. Overlapping less than 50%, as shown in the figure to the right, may lead to missed spots or streaky results.



**Figure 5.** Overlap technique.

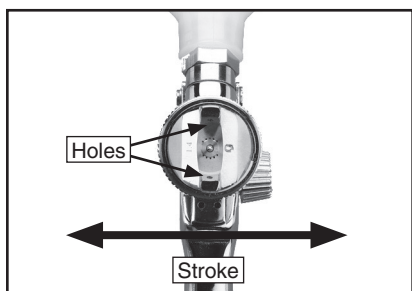
13. The spray stroke should have even consistency and parallel edges. If it doesn't, please refer to **Troubleshooting** on **Page 15**.

## **CAUTION**

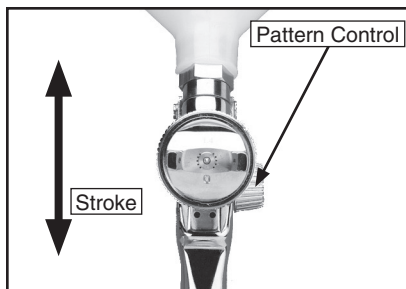
**CONTAMINATION HAZARD!** Dispose of paint waste in a responsible manner! Follow manufacturer's recommendations and local laws regarding disposal.

## Atomizing Cap and Fan Adjustments

The atomizing cap needs to be adjusted for horizontal or vertical spraying patterns. Spraying in the wrong direction may lead to material build up on the atomizing cap horn. Many performance problems are caused by clogged atomizing holes on the atomizing cap horns (see **Cleaning** on **Page 13**).

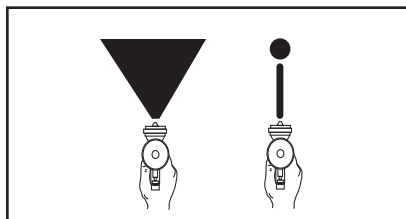


**Figure 6.** Set up for horizontal stroke direction with vertical fan pattern.



**Figure 7.** Set up for vertical spray stroke with horizontal fan pattern.

Rotating the pattern adjustment control in **Figure 7** will give you a range between the two patterns in **Figure 8**.



**Figure 8.** Fan adjustment.

# SECTION 5: ACCESSORIES

## G6261—Campbell Hausfeld™ Water Filter

Remove damaging water vapor before it reaches your pneumatic tools. This highly effective, five micron filter features a see-through bowl and easy in-line connections. 150 PSI maximum air pressure. ¼" NPT.



**Figure 9.** G6261 Campbell Hausfeld™ water filter.

## G8114—¾" x 25 Ft. Air Hose G8115—¾" x 50 Ft. Air Hose G8116—¾" x 100 Ft. Air Hose

Multi-purpose red rubber air hose is flexible and abrasion resistant. Rated for 200 PSI, this air hose has a bursting strength of 800 PSI and ¼" NPT ends.



**Figure 10.** Red rubber air hose.

## H7274—Campbell Hausfeld™ Pressure Regulator

Mini Series. Provides regulated output pressure of 0 to 125 PSI for proper tool operation. Locking pressure knob prevents accidental adjustments. 15 SCFM flow capacity @ 90 PSI. ¼" NPT.



**Figure 11.** H7274 Campbell Hausfeld™ pressure regulator.

## H3174—Air Blow Gun with 2 Tips

This air blow gun includes a safety tip and rubber tip for all normal air cleaning jobs. ¼" NPT .



**Figure 12.** H3174 Air Blow Gun with 2 Tips.

**Call 1-800-523-4777 To Order**

# SECTION 6: MAINTENANCE

## Cleaning

Proper cleaning is the best way to ensure trouble free performance from your spray gun. If your gun is not thoroughly cleaned, damage and poor spraying will result. Problems caused by improper cleaning will not be covered by the warranty. Clean the spray gun immediately after each use.

### To clean your spray gun:

1. Spray a small amount of solvent through the spray gun.

**Note:** Check with local laws regarding this practice. If you are spraying on a regular basis, spraying solvents into the air may be illegal. A cabinet style spray gun cleaner may be required.

2. **Disconnect the gun from the compressed air!**
3. Unscrew the cup.
4. Unscrew the fluid control knob and remove the spring and needle.

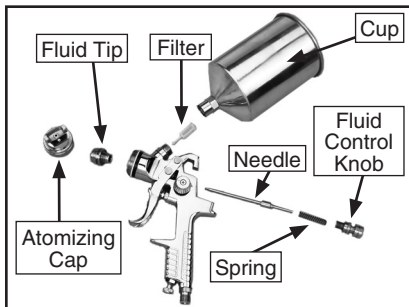


Figure 13. Disassembly for cleaning.

5. Unscrew the atomizing cap with your fingers and the fluid tip with the service wrench. The fully disassembled gun should look like **Figure 13**.
6. Rinse these parts thoroughly in solvent, then dry with compressed air or let air dry.

**Note:** If the small holes in the atomizing cap become blocked, soak in clean solvent. If the blockage still exists, clear the blockage with a small needle, taking great care to not enlarge or damage the hole. Damage to the hole will create a disrupted spray pattern.

7. Use the cleaning brush with solvent to clean the inner orifice and other hard to reach areas on the outside of the spray gun body.
8. Wipe the rest of the gun body with a shop towel and dry.

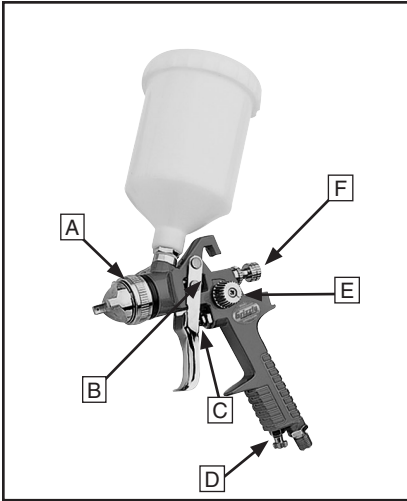
## ⚠ WARNING

**EXPLOSION HAZARD!** Chlorinated Solvents like 1,1,1-Trichloroethane and Methylene Chloride (methyl chloride) can chemically react with aluminum and may explode. Many parts in spray guns are made of aluminum. Read solvent label carefully before using solvent.

## NOTICE

**DO NOT** soak the spray gun body in solvent. Prolonged exposure to solvent will rapidly deteriorate the spray gun washers and seals. Ignoring this notice will void your warranty.

# Lubrication








**Figure 14.** Lubrication points.

Lubricate the following areas with a non-silicon spray gun lubricant after cleaning.

- A. Atomizing Cap Threads
- B. Air Valve Packing
- C. Trigger Pin
- D. Air Flow Control Valve
- E. Pattern Control
- F. Fluid Control Knob

Allow the lubricant to coat threads, and run into gun body to lubricate all moving parts and seals.

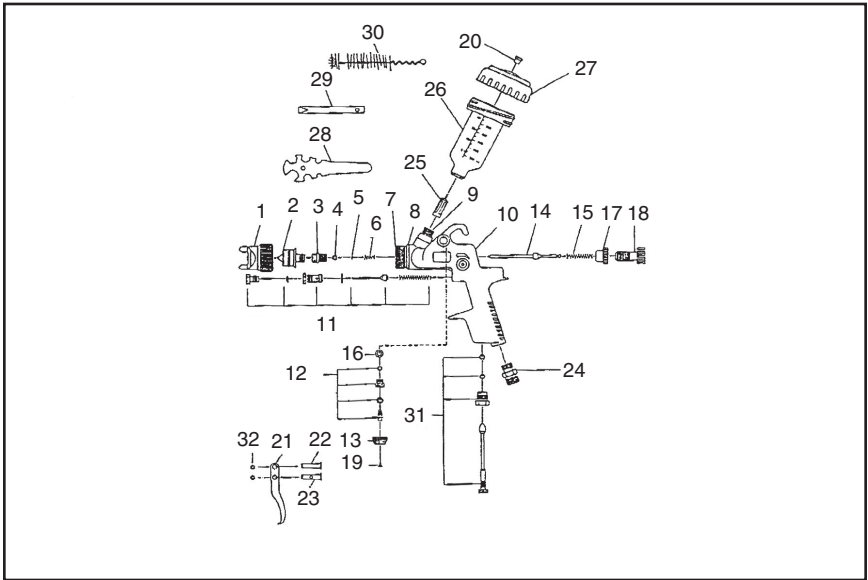
# Troubleshooting

Symptom	Possible Cause	Solution
Fluttering or spitting spray. 	<ol style="list-style-type: none"> <li>1. Dry or worn fluid tip seat permits air to seep into fluid passage.</li> <li>2. Material level too low.</li> <li>3. Fluid tip or filter obstructed.</li> <li>4. Dry needle packing.</li> </ol>	<ol style="list-style-type: none"> <li>1. Tighten fluid tip or replace seat with new one.</li> <li>2. Add material.</li> <li>3. Clean.</li> <li>4. Lubricate needle.</li> </ol>
Uneven top or bottom pattern. 	<ol style="list-style-type: none"> <li>1. Atomizing cap holes are obstructed.</li> <li>2. Build-up on top or bottom of fluid tip.</li> <li>3. Build-up on atomizing cap is on needle seat.</li> </ol>	<ol style="list-style-type: none"> <li>1. Clear holes.</li> <li>2. Clean.</li> <li>3. Clean.</li> </ol>
Right or left arc pattern. 	<ol style="list-style-type: none"> <li>1. Left or right side horn holes are plugged.</li> <li>2. Build-up on left or right side of fluid tip.</li> <li>3. Build-up of material inside atomizing cap.</li> </ol>	<ol style="list-style-type: none"> <li>1. Clear holes.</li> <li>2. Clean.</li> <li>3. Clean.</li> </ol>
Heavy deposit of material in center. 	<ol style="list-style-type: none"> <li>1. The material flow exceeds the atomizing cap capacity.</li> <li>2. Inlet air pressure is too low.</li> <li>3. Material is too thick.</li> </ol>	<ol style="list-style-type: none"> <li>1. Lower fluid flow.</li> <li>2. Increase inlet air pressure.</li> <li>3. Thin material.</li> </ol>
Narrow center pattern. 	<ol style="list-style-type: none"> <li>1. Volume control turned in too far.</li> <li>2. Inlet air pressure too high.</li> <li>3. Fluid pressure is too low.</li> <li>4. Material is too thin.</li> </ol>	<ol style="list-style-type: none"> <li>1. Increase volume.</li> <li>2. Reduce inlet air pressure.</li> <li>3. Increase fluid pressure.</li> <li>4. Adjust material.</li> </ol>
No spray output.	<ol style="list-style-type: none"> <li>1. No pressure at gun.</li> <li>2. Fluid passages dirty.</li> <li>3. Fluid control closed.</li> <li>4. Out of paint.</li> <li>5. Material too thick.</li> </ol>	<ol style="list-style-type: none"> <li>1. Check air supply.</li> <li>2. Clean gun, remove any obstructions.</li> <li>3. Open.</li> <li>4. Refill.</li> <li>5. Thin to manufacturer's recommendations.</li> </ol>

<b>Symptom</b>	<b>Possible Cause</b>	<b>Solution</b>
Excessive over-spray.	<ol style="list-style-type: none"> <li>1. Fluid pressure too high.</li> <li>2. Gun is too far from surface.</li> <li>3. Spraying too fast.</li> </ol>	<ol style="list-style-type: none"> <li>1. Reduce fluid pressure.</li> <li>2. Keep gun at recommended distance.</li> <li>3. Slow down and maintain consistent, even parallel stroke.</li> </ol>
Unable to control spray fan.	<ol style="list-style-type: none"> <li>1. Pattern adjustment screw is not seating properly.</li> <li>2. Atomizing cap is loose.</li> </ol>	<ol style="list-style-type: none"> <li>1. Clean or replace.</li> <li>2. Tighten atomizing cap.</li> </ol>
Runs and sags.	<ol style="list-style-type: none"> <li>1. Damaged seal.</li> </ol>	<ol style="list-style-type: none"> <li>1. Replace damaged seals.</li> </ol>
Material leaks from cup.	<ol style="list-style-type: none"> <li>1. Cap not secure.</li> <li>2. Cup not tight on gun body.</li> <li>3. Leaking from cap vent hole.</li> </ol>	<ol style="list-style-type: none"> <li>1. Tighten.</li> <li>2. Tighten.</li> <li>3. Hold gun upright, do not tilt.</li> </ol>
Material leaks from gun.	<ol style="list-style-type: none"> <li>1. Fluid tip loose.</li> <li>2. Dry or damaged seals.</li> <li>3. Excessive pressure.</li> </ol>	<ol style="list-style-type: none"> <li>1. Tighten.</li> <li>2. Replace seals.</li> <li>3. Reduce pressure.</li> </ol>
Thick dimpled finish: orange peel appearance.	<ol style="list-style-type: none"> <li>1. Holding gun too close to surface.</li> <li>2. Inlet air pressure too low.</li> <li>3. Material not properly mixed.</li> <li>4. Surface is dirty or oily.</li> </ol>	<ol style="list-style-type: none"> <li>1. Spray at recommended distance.</li> <li>2. Check inlet air pressure.</li> <li>3. Follow manufacturer's instructions.</li> <li>4. More surface prep is required.</li> </ol>
Dry Spray.	<ol style="list-style-type: none"> <li>1. Inlet air pressure too high.</li> <li>2. Gun too far from surface.</li> <li>3. Gun stroke too fast.</li> </ol>	<ol style="list-style-type: none"> <li>1. Lower inlet air pressure.</li> <li>2. Keep gun at recommended distance.</li> <li>3. Slow down and maintain consistent even parallel stroke.</li> </ol>
Gun leaks from fluid tip.	<ol style="list-style-type: none"> <li>1. Debris will not let the needle seat with the fluid tip.</li> </ol>	<ol style="list-style-type: none"> <li>1. Clean or replace both.</li> </ol>
Contaminated paint: fish eye appearance.	<ol style="list-style-type: none"> <li>1. Water or oil in the air line.</li> </ol>	<ol style="list-style-type: none"> <li>1. Install an in-line air filter.</li> <li>2. Replace air line.</li> </ol>



# Parts Breakdown G5352



REF	PART #	DESCRIPTION
1	P5352001	AIR NOZZLE WITH BRASS CAP
2	P5352002	FLUID NOZZLE
3	P5352003	PACKING SCREW
4	P5352004	TEFLON SEAL
5	P5352005	WASHER
6	P5352006	COMPRESSION SPRING
7	P5352007	BRASS RING
8	P5352008	GASKET
9	P5352009	CONNECTOR FOR 0.6 CUP
10	P5352010	GUN BODY
11	P5352011	AIR VALVE ASSEMBLY
12	P5352012	SPRAY REGULATING NUT
13	P5352013	CONTROL KNOB
14	P5352014	PAINT NEEDLE COMPLETE
15	P5352015	SPRING FOR PAINT NEEDLE
16	P5352016	GASKET

REF	PART #	DESCRIPTION
17	P5352017	LOCK FLUID CONTROL KNOB
18	P5352018	FLUID CONTROL KNOB
19	P5352019	COUNTERSUNK SCREW
20	P5352020	NON-DRIP CONTROL DEVICE
21	P5352021	TRIGGER
22	P5352022	SCREW
23	P5352023	PIN
24	P5352024	AIR CONNECTION PIECE
25	P5352025	MATERIAL SLEEVE
26	P5352026	PLASTIC CUP
27	P5352027	COVER
28	P5352028	SERVICE WRENCH
29	P5352029	BAFFLE WRENCH
30	P5352030	CLEANING BRUSH
31	P5352031	AIR ADJUSTING VALVE ASSY
32	P5352032	E-RING

# WARRANTY AND RETURNS

---

---

Grizzly Industrial, Inc. warrants every product it sells for a period of **1 year** to the original purchaser from the date of purchase. This warranty does not apply to defects due directly or indirectly to misuse, abuse, negligence, accidents, repairs or alterations or lack of maintenance. This is Grizzly's sole written warranty and any and all warranties that may be implied by law, including any merchantability or fitness, for any particular purpose, are hereby limited to the duration of this written warranty. We do not warrant or represent that the merchandise complies with the provisions of any law or acts unless the manufacturer so warrants. In no event shall Grizzly's liability under this warranty exceed the purchase price paid for the product and any legal actions brought against Grizzly shall be tried in the State of Washington, County of Whatcom.

We shall in no event be liable for death, injuries to persons or property or for incidental, contingent, special, or consequential damages arising from the use of our products.

To take advantage of this warranty, contact us by mail or phone and give us all the details. We will then issue you a "Return Authorization Number," which must be clearly posted on the outside as well as the inside of the carton. We will not accept any item back without this number. Proof of purchase must accompany the merchandise.

The manufacturers reserve the right to change specifications at any time because they constantly strive to achieve better quality equipment. We make every effort to ensure that our products meet high quality and durability standards and we hope you never need to use this warranty.

Please feel free to write or call us if you have any questions about the machine or the manual.

**Grizzly Industrial, Inc.**  
**1203 Lycoming Mall Circle**  
**Muncy, PA 17756**  
**Phone: (570) 546-9663**  
**Fax: (800) 438-5901**

**E-Mail:**  
**techsupport@grizzly.com**

**Web Site: <http://www.grizzly.com>**

Thank you again for your business and continued support. We hope to serve you again soon!



# WARRANTY CARD

Name \_\_\_\_\_

Street \_\_\_\_\_

City \_\_\_\_\_ State \_\_\_\_\_ Zip \_\_\_\_\_

Phone # \_\_\_\_\_ Email \_\_\_\_\_ Invoice # \_\_\_\_\_

Model # \_\_\_\_\_ Order # \_\_\_\_\_ Serial # \_\_\_\_\_

*The following information is given on a voluntary basis. It will be used for marketing purposes to help us develop better products and services. **All information is strictly confidential.***

1. How did you learn about us?

Advertisement     Friend     Catalog  
 Card Deck     Website    Other: \_\_\_\_\_

2. Which of the following magazines do you subscribe to?

Cabinet Maker     Popular Mechanics     Today's Homeowner  
 Family Handyman     Popular Science     Wood  
 Hand Loader     Popular Woodworking     Wooden Boat  
 Handy     Practical Homeowner     Woodshop News  
 Home Shop Machinist     Precision Shooter     Woodsmith  
 Journal of Light Cont.     Projects in Metal     Woodwork  
 Live Steam     RC Modeler     Woodworker West  
 Model Airplane News     Rifle     Woodworker's Journal  
 Modeltec     Shop Notes     Other:  
 Old House Journal     Shotgun News

3. What is your annual household income?

\$20,000-\$29,000     \$30,000-\$39,000     \$40,000-\$49,000  
 \$50,000-\$59,000     \$60,000-\$69,000     \$70,000+

4. What is your age group?

20-29     30-39     40-49  
 50-59     60-69     70+

5. How long have you been a woodworker/metalworker?

0-2 Years     2-8 Years     8-20 Years     20+ Years

6. How many of your machines or tools are Grizzly?

0-2     3-5     6-9     10+

7. Do you think your machine represents a good value?     Yes     No

8. Would you recommend Grizzly Industrial to a friend?     Yes     No

9. Would you allow us to use your name as a reference for our customers in your area?

Note: *We never use names more than 3 times.*     Yes     No

10. Comments: \_\_\_\_\_

\_\_\_\_\_

\_\_\_\_\_

\_\_\_\_\_

Send a Grizzly Catalog to a friend:

Name _____
Street _____
City _____ State _____ Zip _____

FOLD ALONG DOTTED LINE



Place  
Stamp  
Here



GRIZZLY INDUSTRIAL, INC.  
P.O. BOX 2069  
BELLINGHAM, WA 98227-2069



TAPE ALONG EDGES--PLEASE DO NOT STAPLE