

ENGINEERING TEST REPORT

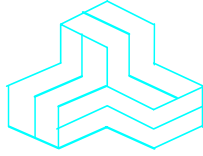

Procaster
Model No.: AMTX100
FCC ID: VCJ-AMTX100

Applicant:
ChezRadio
18 Kingsgate Place
Bolton, Ontario
Canada L7E 5Z5

In Accordance With

FEDERAL COMMUNICATIONS COMMISSION (FCC)
Part 15, Subpart C
Unlicensed Low Power Transmitter
Operating in the band 510-1705 kHz

UltraTech's File No.: VIDC001_F15C219

This Test report is Issued under the Authority of
Tri M. Luu, Professional Engineer,
Vice President of Engineering
UltraTech Group of Labs



Date: September 27, 2007

Report Prepared by: Dharmajit Solanki, RF Engineer

Tested by: Mr. Hung Trinh, RFI Technician

Issued Date: September 27, 2007

Test Dates: August 14 – September 11, 2007

- *The results in this Test Report apply only to the sample(s) tested, and the sample tested is randomly selected.*
- *This report must not be used by the client to claim product endorsement by NVLAP or any agency of the US Government.*

UltraTech

3000 Bristol Circle, Oakville, Ontario, Canada, L6H 6G4
Tel.: (905) 829-1570 Fax.: (905) 829-8050
Website: www.ultratech-labs.com, Email: vic@ultratech-labs.com, Email: tri@ultratech-labs.com



0685



31040/SIT



C-1376



46390-2049



200093-0



SL2-IN-E-1119R

TABLE OF CONTENTS

EXHIBIT 1. INTRODUCTION	1
1.1. SCOPE.....	1
1.2. RELATED SUBMITTAL(S)/GRANT(S)	1
1.3. NORMATIVE REFERENCES	1
EXHIBIT 2. PERFORMANCE ASSESSMENT	2
2.1. CLIENT INFORMATION	2
2.2. EQUIPMENT UNDER TEST (EUT) INFORMATION	2
2.3. EUT'S TECHNICAL SPECIFICATIONS	3
2.4. LIST OF EUT'S PORTS.....	3
2.5. ANCILLARY EQUIPMENT	3
2.6. GENERAL TEST SETUP.....	4
EXHIBIT 3. EUT OPERATING CONDITIONS AND CONFIGURATIONS DURING TESTS.....	5
3.1. CLIMATE TEST CONDITIONS	5
3.2. OPEPERATIONAL TEST CONDITIONS & ARRANGEMENT FOR TESTS	5
EXHIBIT 4. SUMMARY OF TEST RESULTS.....	6
4.1. LOCATION OF TESTS.....	6
4.2. APPLICABILITY & SUMMARY OF EMC EMISSION TEST RESULTS	6
4.3. MODIFICATIONS INCORPORATED IN THE EUT FOR COMPLIANCE PURPOSES	6
EXHIBIT 5. MEASUREMENTS, EXAMINATIONS & TEST DATA FOR EMC EMISSIONS.....	7
5.1. TEST PROCEDURES.....	7
5.2. MEASUREMENT UNCERTAINTIES	7
5.3. MEASUREMENT EQUIPMENT USED	7
5.4. COMPLIANCE WITH FCC PART 15 – GENERAL TECHNICAL REQUIREMENTS	7
5.5. OCCUPIED BANDWIDTH	8
5.6. TOTAL INPUT POWER TO THE FINAL RADIO FREQUENCY STAGE OF AMPLIFIER [47 CFR 15.219 (A)]	11
5.7. TOTAL LENGTH OF THE ANTENNA, TRANSMISSION LINE & GROUND LEAD [47 CFR 15.219 (B)]	14
5.8. FIELD STRENGTH OF EMISSIONS INSIDE & OUTSIDE THE PERMITTED BAND 510-1705 KHZ [47 CFR 15.219 (C)]	15
5.9. RADIATED EMISSIONS FROM CLASS B UNINTENTIONAL RADIATORS (DIGITAL DEVICES) [47 CFR 15.109(A)].....	18
5.10. AC POWERLINE CONDUCTED EMISSIONS [47 CFR 15.107(A) & 15.207].....	20
EXHIBIT 6. MEASUREMENT UNCERTAINTY.....	23
6.1. LINE CONDUCTED EMISSION MEASUREMENT UNCERTAINTY	23
6.2. RADIATED EMISSION MEASUREMENT UNCERTAINTY	24

EXHIBIT 1. INTRODUCTION

1.1. SCOPE

Reference:	FCC Part 15, Subpart C, Sec.15.219 - Operation within the band 510-1705 kHz.
Title:	Telecommunication - Code of Federal Regulations, CFR 47, Part 15, Subpart C
Purpose of Test:	To obtain Certification Authorization from FCC
Test Procedures:	Both conducted and radiated emissions measurements were conducted in accordance with American National Standards Institute ANSI C63.4 - American National Standard for Methods of Measurement of Radio-Noise Emissions from Low-Voltage Electrical and Electronic Equipment in the Range of 9 kHz to 40 GHz.
Environmental Classification:	Residential Commercial, industrial or business environment

1.2. RELATED SUBMITTAL(S)/GRANT(S)

None.

1.3. NORMATIVE REFERENCES

Publication	Year	Title
FCC CFR Parts 0-19	2006	Code of Federal Regulations – Telecommunication
ANSI C63.4	2003	American National Standard for Methods of Measurement of Radio-Noise Emissions from Low-Voltage Electrical and Electronic Equipment in the Range of 9 kHz to 40 GHz
CISPR 22 +A1 EN 55022	2003-04-10 2004-10-14 2003	Limits and Methods of Measurements of Radio Disturbance Characteristics of Information Technology Equipment
CISPR 16-1-1	2003	Specification for radio disturbance and immunity measuring apparatus and methods. Part 1-1: Measuring Apparatus
CISPR 16-2-1	2003	Specification for radio disturbance and immunity measuring apparatus and methods. Part 2-1: Conducted disturbance measurement
CISPR 16-2-3	2003	Specification for radio disturbance and immunity measuring apparatus and methods. Part 2-3: Radiated disturbance measurement

EXHIBIT 2. PERFORMANCE ASSESSMENT

2.1. CLIENT INFORMATION

APPLICANT	
Name:	ChezRadio
Address:	18 Kingsgate Place, Bolton, ON Canada L7E 5Z5
Contact Person:	Mr. Gerry Herlinger, Phone #: 416-402-6172 Fax #: 905-857-5198 Email Address: krimles@yahoo.com

MANUFACTURER	
Name:	ChezRadio
Address:	18 Kingsgate Place, Bolton, ON Canada L7E 5Z5
Contact Person:	Mr. Gerry Herlinger, Phone #: 416-402-6172 Fax #: 905-857-5198 Email Address: krimles@yahoo.com

2.2. EQUIPMENT UNDER TEST (EUT) INFORMATION

The following information (with the exception of the Date of Receipt) has been supplied by the applicant.

Brand Name:	ChezRadio
Product Name:	Procaster
Model Name or Number:	AMTX100
Serial Number:	Test sample
Type of Equipment:	Low Power Transmitter
Input Power Supply Type:	120 VAC, 60Hz, AC Adaptor
Primary User Functions of EUT:	AM Broadcast Transmitter

2.3. EUT’S TECHNICAL SPECIFICATIONS

Transmitter	
Equipment Type:	▪ Fixed
Intended Operating Environment:	▪ Residential ▪ Commercial, light industry & heavy industry
Power Supply Requirement:	12 VDC, 60mA
Field Strength:	75 dBµV/m at 10 m
Operating Frequency Range:	1290 - 1700 kHz
RF Output Power Rating:	100mW
20 dB Bandwidth:	2.655 kHz
Modulation Type:	AM
Clock Frequency:	10.24 MHz
Antenna Connector Type:	None, Permanently Attached
Antenna Description:	Manufacturer: ChezRadio Type: Whip

2.4. LIST OF EUT’S PORTS

Port Number	EUT’s Port Description	Number of Identical Ports	Connector Type	Cable Type (Shielded/Non-shielded)
1	Audio Input	1	Terminal Block	Non Shielded
2	Power Supply	1	Terminal Block	Non-Shielded

2.5. ANCILLARY EQUIPMENT

The EUT was tested while connected to the following representative configuration of ancillary equipment necessary to exercise the ports during tests:

Ancillary Equipment # 1	
Description:	AC Adaptor
Brand name:	GlobTek Inc
Model Name or Number:	GT-21089-1512-W3
Serial Number:	N/A
Connected to EUT’s Port:	Studio Interface

2.6. GENERAL TEST SETUP

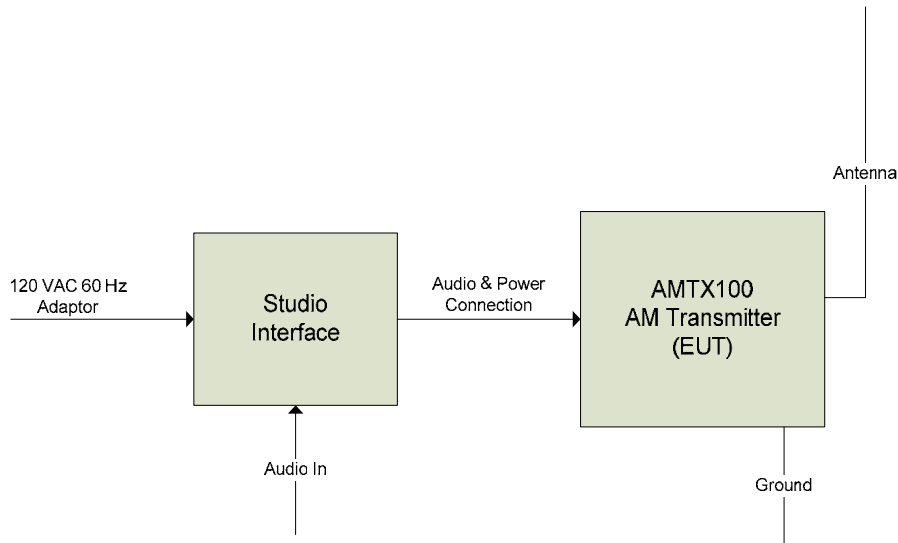

EXHIBIT 3. EUT OPERATING CONDITIONS AND CONFIGURATIONS DURING TESTS

3.1. CLIMATE TEST CONDITIONS

The climate conditions of the test environment are as follows:

Temperature:	23°C
Humidity:	54%
Pressure:	102 kPa
Power input source:	12 VDC (AC Adaptor)

3.2. OPEPERATIONAL TEST CONDITIONS & ARRANGEMENT FOR TESTS

Operating Modes:	Normal
Special Test Software:	None
Special Hardware Used:	None
Transmitter Test Antenna:	External, Permanently Attached

Transmitter Test Signals:	
Frequency:	1500 kHz
Transmitter Wanted Output Test Signals:	
▪ RF Input Power to Final RF Stage(measured):	93.85mW
▪ Normal Test Modulation:	AM
▪ Modulating signal source:	Internal

EXHIBIT 4. SUMMARY OF TEST RESULTS

4.1. LOCATION OF TESTS

All of the measurements described in this report were performed at Ultratech Group of Labs located in the city of Oakville, Province of Ontario, Canada.

- AC Power Line Conducted Emissions were performed in UltraTech's shielded room, 24'(L) by 16'(W) by 8'(H).
- Radiated Emissions were performed at the Ultratech's 3-10 TDK Semi-Anechoic Chamber situated in the Town of Oakville, province of Ontario. This test site been calibrated in accordance with ANSI C63.4, and found to be in compliance with the requirements of Sec. 2.948 of the FCC Rules. The descriptions and site measurement data of the Oakville 3-10 TDK Semi-Anechoic Chamber has been filed with FCC office (FCC File No.: 31040/SIT 1300B3) and Industry Canada office (Industry Canada File No.: IC2049-1). Last Date of Site Calibration: June 20, 2007.

4.2. APPLICABILITY & SUMMARY OF EMC EMISSION TEST RESULTS

FCC Regulations	Test Requirements	Compliance (Yes/No)
15.203 & 15.204	The transmitter shall use a transmitting antenna that is an integral part of the device	Yes
	20 dB & 99% Bandwidth	Yes
15.219(a)	Total Input Power to the Final RF Stage \leq 100mW	Yes
15.219(b)	Total Length of the Transmission Line, Antenna and Ground Lead \leq 3 meters	Yes*
15.219(c)	Field Strength of Emissions Outside the Permitted Band 510 - 1705 kHz	Yes
15.107 & 15.207	Class B - AC Power Line Conducted Emissions	Yes
15.109(b)	Class B - Radiated Emissions from Unintentional Radiators	Yes

* Note: Manufacturer has confirmed and listed as warning statement on page no.3 of the user manual.

4.3. MODIFICATIONS INCORPORATED IN THE EUT FOR COMPLIANCE PURPOSES

None

EXHIBIT 5. MEASUREMENTS, EXAMINATIONS & TEST DATA FOR EMC EMISSIONS

5.1. TEST PROCEDURES

This section contains test results only. Details of test methods and procedures can be found in ANSI C63.4 and ULTR-P001-2004.

5.2. MEASUREMENT UNCERTAINTIES

The measurement uncertainties stated were calculated in accordance with requirements of UKAS Document LAB 34 with a confidence level of 95%. Please refer to Exhibit 6 for Measurement Uncertainties.

5.3. MEASUREMENT EQUIPMENT USED

The measurement equipment used complied with the requirements of the Standards referenced in the Methods & Procedures ANSI C63.4 and CISPR 16-1-1.

5.4. COMPLIANCE WITH FCC PART 15 – GENERAL TECHNICAL REQUIREMENTS

FCC Section	FCC Rules	
15.203	<p>Described how the EUT complies with the requirement that either its antenna is permanently attached, or that it employs a unique antenna connector, for every antenna proposed for use with the EUT.</p> <p>The exception is in those cases where EUT must be professionally installed. In order to demonstrate that professional installation is required, the following 3 points must be addressed:</p> <ul style="list-style-type: none">• The application (or intended use) of the EUT• The installation requirements of the EUT• The method by which the EUT will be marketed	External whip antenna permanently mounted directly to transmitter PCB without any transmission line.
15.204	<p>Provided the information for every antenna proposed for use with the EUT:</p> <p>(a) type (e.g. Yagi, patch, grid, dish, etc...), (b) manufacturer and model number (c) gain with reference to an isotropic radiator</p>	Yes. Manufacturer: ChezRadio Type: Whip

5.5. OCCUPIED BANDWIDTH

5.5.1. Limits

The bandwidth shall show band-edge compliance.

5.5.2. Method of Measurements

Refer to Ultratech Test Procedures, File # ULTR P001-2004 and ANSI C63.4 for measurement methods

5.5.3. Test Equipment List

Test Instruments	Manufacturer	Model No.	Serial No.	Frequency Range
Spectrum Analyzer/ EMI Receiver	Rohde & Schwarz	FSEK20/B4/B21	834157/00 5	9 kHz – 40 GHz
Loop Antenna	EMCO	6502	2611	10 kHz - 30 MHz

5.5.4. Test Data

Test Frequency (kHz)	Occupied Bandwidth (kHz)	
	20 dB BW	99 % BW
1500	2.655	2.505

Plot 1: 20dB Bandwidth
Test Frequency: 1500 kHz

tip LOOP6502 17:02:35 SEP 11, 2007

ACTV DET: PEAK
MEAS DET: PEAK QP AVG
MKR 2.655 kHz
-.05 dB

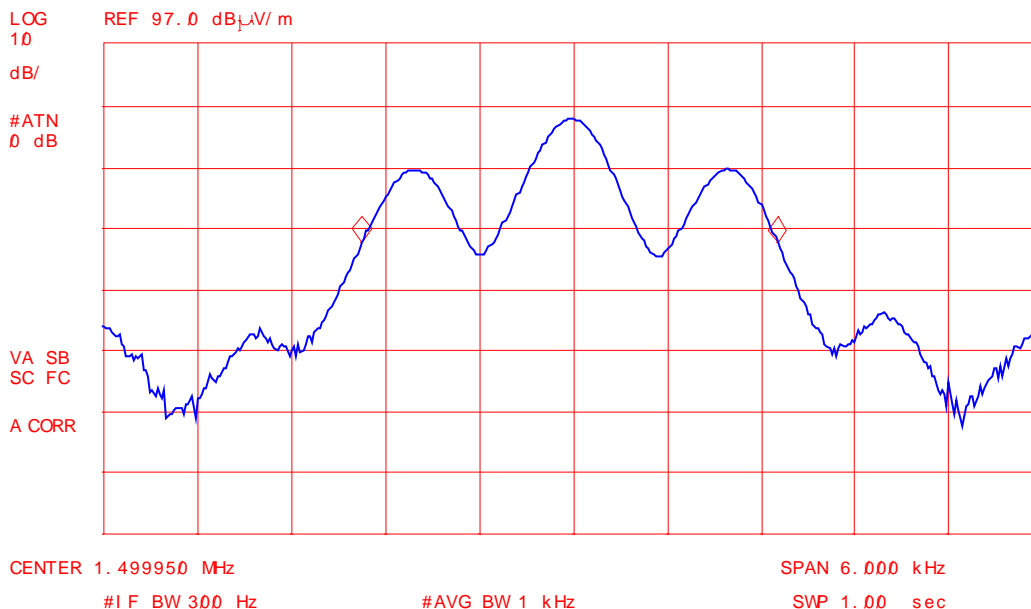

Plot 2: 99% Occupied Bandwidth
Test Frequency: 1500 kHz

hp LOOP6502 17:02:35 SEP 11, 2007

ACTV DET: PEAK
MEAS DET: PEAK QP AVG
MKR 2.505 kHz
.54 dB

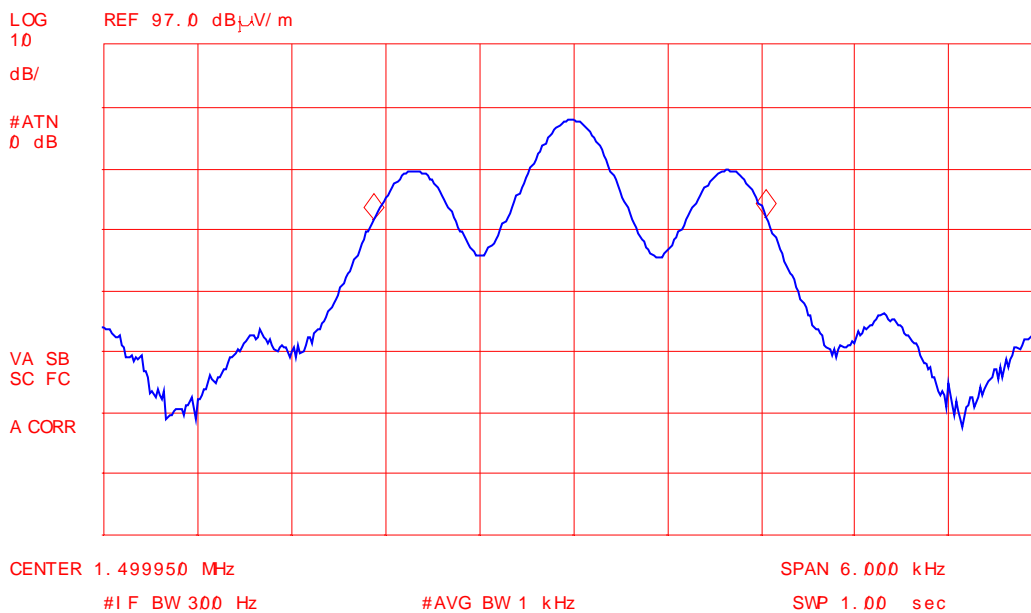

5.6. TOTAL INPUT POWER TO THE FINAL RADIO FREQUENCY STAGE OF AMPLIFIER [47 CFR 15.219 (a)]

5.6.1. Limits

- (a) The total input power to the final radio frequency stage (exclusive of filament or heater power) shall not exceed 100 milliwatts.

Note:- The following measurements and test results were supplied by the manufacturer and are copied here to show compliance with this requirement.

5.6.2. Over View

It can be proven mathematically that maximum power is delivered across the load when the effective load resistance presented by the final amplifier (the voltage across the final amplifier divided by the current) is equal to R . If an equivalent resistance equal to R is added between a power supply set at double the voltage across the final amplifier, then automatic power regulation is achieved.

Through experimentation, it was found that the final output stage in the AMTX100 transmitter works most efficiently when 2.5V is applied resulting in a current flow of 40mA. This is an input power of 100mW and a resulting final resistance of 62.5 ohms (R).

If the external voltage source is doubled to 5V and a series resistor equivalent to 62.5 ohms is added then 100mW will be maintained across all frequencies.

Through experimentation, it was found that 82 ohms was the best choice to maintain final amplifier input power under 100mW.

5.6.3. Test Diagram

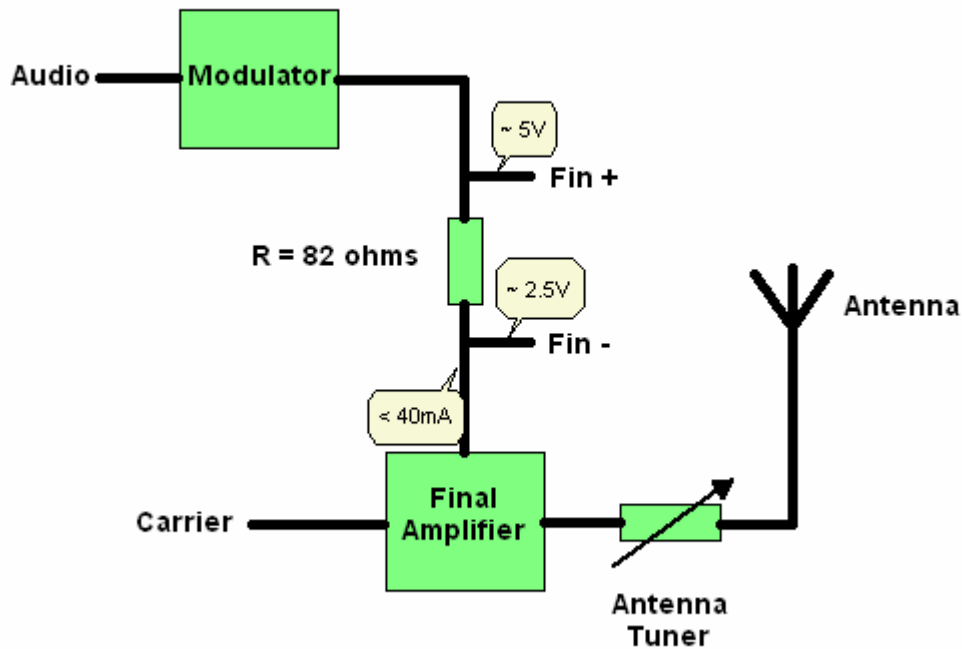

Fig - Final output stage configuration

5.6.4. Test Data

The following measurements were made at the low (1290kHz), mid (1500kHz) and high (1700kHz) frequency ranges of the AMTX100 transmitter with the antenna tuned to resonance (maximum power).

At 1290 kHz:

Voltage across FIN+ and FIN- = 2.096V
Current through R = 25.56mA
Voltage at FIN- wrt ground = 3.536V
Power input to final amplifier = 90.4mW

At 1500 kHz:

Voltage across FIN+ and FIN- = 2.373V
Current through R = 28.93mA
Voltage at FIN- wrt ground = 3.229V
Power input to final amplifier = 93.4mW

At 1700 kHz:

Voltage across FIN+ and FIN- = 2.376V
Current through R = 28.97mA
Voltage at FIN- wrt ground = 3.239V
Power input to final amplifier = 93.85mW

5.7. TOTAL LENGTH OF THE ANTENNA, TRANSMISSION LINE & GROUND LEAD [47 CFR 15.219 (b)]

5.7.1. Limits

(b) The total length of the transmission line, antenna and ground lead (if used) shall not exceed 3 meters.

5.7.2. Results

The manufacturer ChezRadio has confirmed that the installation will meet the above requirement and listed as a warning statement on page no.3 of the user manual as per below.

Warning: FCC rules (47 part 15.219) state: " the total length of the transmission line, antenna and ground lead (if used) shall not exceed 3 meters." [3 meters = 118 inches]

The PROCASTER™ has an attached 103 inch antenna measured from its tip to the lower mounting bolt which is the connection of the transmitter output. It has no transmission line. A 15 inch maximum ground lead is allowed from the grounding lug to a massive ground.

5.8. FIELD STRENGTH OF EMISSIONS INSIDE & OUTSIDE THE PERMITTED BAND 510-1705 kHz [47 CFR 15.219 (c)]

5.8.1. Limits

(c) All emissions below 510 kHz or above 1705 kHz shall be attenuated at least 20 dB below the level of the unmodulated carrier. Determination of the compliance with the 20 dB attenuation specification may be based on the measurements at the intentional radiator's antenna output terminal unless the intentional radiator uses a permanently attached antenna, in which case compliance shall be demonstrated by measuring the radiated emissions.

Remarks:

FCC CFR 47, Part 15, Subpart C, Para. 15.205(a) - Restricted Frequency Bands

MHz	MHz	MHz	GHz
0.090 - 0.110	162.0125 - 167.17	2310 - 2390	9.3 - 9.5
0.49 - 0.51	167.72 - 173.2	2483.5 - 2500	10.6 - 12.7
2.1735 - 2.1905	240 - 285	2655 - 2900	13.25 - 13.4
8.362 - 8.366	322 - 335.4	3260 - 3267	14.47 - 14.5
13.36 - 13.41	399.9 - 410	3332 - 3339	14.35 - 16.2
25.5 - 25.67	608 - 614	3345.8 - 3358	17.7 - 21.4
37.5 - 38.25	960 - 1240	3600 - 4400	22.01 - 23.12
73 - 75.4	1300 - 1427	4500 - 5250	23.6 - 24.0
108 - 121.94	1435 - 1626.5	5350 - 5460	31.2 - 31.8
123 - 138	1660 - 1710	7250 - 7750	36.43 - 36.5
149.9 - 150.05	1718.8 - 1722.2	8025 - 8500	Above 38.6
156.7 - 156.9	2200 - 2300	9000 - 9200	

**FCC CFR 47, Part 15, Subpart C, Para. 15.209(a)
 -- Field Strength Limits within Restricted Frequency Bands --**

FREQUENCY (MHz)	FIELD STRENGTH LIMITS (microvolts/m)	DISTANCE (Meters)
0.009 - 0.490	2,400 / F (KHz)	300
0.490 - 1.705	24,000 / F (KHz)	30
1.705 - 30.0	30	30
30 - 88	100	3
88 - 216	150	3
216 - 960	200	3
Above 960	500	3

5.8.2. Method of Measurements

Refer to Ultratech Test Procedures, File # ULTR P001-2004 and ANSI C63.4 for measurement methods

Applies to harmonics/spurious that fall in the restricted bands listed in Section 15.205. the maximum permitted average field strength is listed in Section 15.209. A Pre-Amp and high-pass filter are used for this measurement.

- For measurements from 9 KHz to 150 KHz, set RBW = 200 Hz, VBW \geq RBW, SWEEP=AUTO.
- For measurements from 150 KHz to 30 MHz, set RBW = 10 KHz, VBW \geq RBW, SWEEP=AUTO.
- For measurements from 30 MHz to 1 GHz, set RBW = 100 KHz, VBW \geq RBW, SWEEP=AUTO.
- For measurement above 1 GHz, set RBW = 1 MHz, VBW = 1 MHz, SWEEP=AUTO.

If the emission is pulsed, modified the unit for continuous operation, then use the settings above for measurements, then correct the reading by subtracting the peak-average correction factor derived from the appropriate duty cycle calculation. See Section 15.35(b) and (c).

5.8.3. Test Equipment List

Test Instruments	Manufacturer	Model No.	Serial No.	Frequency Range
EMI Receiver System/ Spectrum Analyzer with built- in Amplifier	Hewlett Packard	HP 8546A	3520A00248	9KHz-5.6GHz, 50 Ohms
Active Loop Antenna	EMCO	6507	8906-1167	1 kHz – 30 MHz
Log Periodic/Bow-Tie Antenna	EMCO	3143	1029	20 - 1000 MHz

5.8.4. Test Data

5.8.4.1. Field Strength level of Un-modulated Carrier

Frequency (MHz)	Measured Field Strength @ 10m (dBµV/m)	Detector Used (Peak/QP)	Antenna Plane	Limit
1.5	75.0	Peak	0°	N/A
1.5	63.4	Peak	90°	N/A

5.8.4.2. Field Strength of Emissions Outside the Permitted Band (10 kHz to 30 MHz)

Frequency (MHz)	Measured Field Strength @ 10m (dBµV/m)	Detector Used (Peak/QP)	Antenna Plane	§ 15.219(c) Limit (dBµV/m)	§ 15.205 (Restricted Band) Limit (dBµV/m)	Margin (dB)
3.0	47.8	Peak	0°	55.0	N/A	-7.2
4.5	38.0	Peak	0°	55.0	N/A	-17.0
6.0	30.8	Peak	0°	55.0	N/A	-24.2
7.5	29.4	Peak	0°	55.0	N/A	-25.6
9.0	27.1	Peak	0°	55.0	N/A	-27.9
10.5	27.5	Peak	0°	55.0	N/A	-27.5
13.5	27.3	Peak	0°	55.0	N/A	-27.7
15.0	34.3	Peak	0°	55.0	N/A	-20.7
15.0	28.4	Peak	90°	55.0	N/A	-26.6

5.9. RADIATED EMISSIONS FROM CLASS B UNINTENTIONAL RADIATORS (DIGITAL DEVICES) [47 CFR 15.109(a)]

5.9.1. Limits

The equipment shall meet the limits of the following table:

Frequency of emission (MHz)	Class B Limits	
	(dBµV/m at 3 m)	(dBµV/m at 10 m)
30 – 88	40.0	29.5
88 – 216	43.5	33.1
216 – 960	46.0	35.6
Above 960	54.0	43.5

5.9.2. Method of Measurements

Refer to Ultratech Test Procedures ULTR-P001-2004 & ANSI C63.4 for method of measurements.

The spectrum shall be investigated from the lowest radio frequency signal generated or used in the device, without going below the lowest frequency for which a radiated emission limit is specified, up to the frequency shown in the following table:

Highest frequency generated or used in the device or on which the device operates or tunes (MHz)	Upper frequency of measurement range (MHz)
Below 1.705	30
1.705 – 108	1000
108 – 500	2000
500 -1000	5000
Above 1000	5 th harmonic of the highest frequency or 40 GHz, whichever is lower

5.9.3. Test Equipment List

Test Instruments	Manufacturer	Model Nos.	Serial No.	Frequency Range
Spectrum Analyzer/EMI Receiver	Rohde & Schwarz	FSEK20/B4/B21	834157/005	9 kHz – 40 GHz with external mixer
EMI Receiver System / Spectrum Analyzer	Hewlett Packard	HP 8546A	3520A00248	9KHz-5.6GHz, 50 Ohms
Microwave Amplifier	Hewlett Packard	HP 83017A	311600661	1 GHz to 26.5 GHz
Biconilog Antenna	EMCO	3143	1029	20 MHz to 2 GHz
Horn Antenna	EMCO	3155	9701-5061	1 GHz – 18 GHz

ULTRATECH GROUP OF LABS

3000 Bristol Circle, Oakville, Ontario, Canada L6H 6G4
 Tel. #: 905-829-1570, Fax. #: 905-829-8050, Email: vic@ultratech-labs.com, Website: <http://www.ultratech-labs.com>

File #: VIDC001_F15C219
 September 27, 2007

All test results contained in this engineering test report are traceable to National Institute of Standards and Technology (NIST)

5.9.4. Test Data

5.9.4.1. Field Strength of Radiated Emissions (30 MHz to 1 GHz)

Frequency (MHz)	Measured Field Strength @ 10m (dBµV/m)	Detector Used (Peak/QP)	Antenna Plane (H/V)	§ 15.219 Limit (dBµV/m)	§ 15.109 Field Strength Limits (dBµV/m)	Margin (dB)
33.0	25.2	QP	V	55.0	29.5	-4.3
33.0	22.1	Peak	H	55.0	29.5	-7.4
34.5	24.2	Peak	V	55.0	29.5	-5.3
36.3	20.4	Peak	V	55.0	29.5	-9.1
45.3	24.4	Peak	V	55.0	29.5	-5.1
47.0	20.4	Peak	V	55.0	29.5	-9.1
48.3	21.8	Peak	V	55.0	29.5	-7.7
61.5	24.3	Peak	V	55.0	29.5	-5.2
82.0	27.8	QP	V	55.0	29.5	-1.7
82.0	17.3	Peak	H	55.0	29.5	-12.2
88.5	21.3	Peak	V	55.0	33.0	-11.7
92.5	23.4	Peak	V	55.0	33.0	-9.6
92.5	15.7	Peak	H	55.0	33.0	-17.3
113.0	17.0	Peak	V	55.0	33.0	-16.0
169.9	18.8	Peak	V	55.0	33.0	-14.2
872.0	26.0	Peak	V	55.0	35.5	-9.5
872.0	26.8	Peak	H	55.0	35.5	-8.7

5.10. AC POWERLINE CONDUCTED EMISSIONS [47 CFR 15.107(a) & 15.207]

5.10.1. Limits

The equipment shall meet the limits of the following table:

Test Frequency Range (MHz)	Class B Limits (dB μ V)		Measuring Bandwidth
	Quasi-Peak	Average	
0.15 to 0.5	66 to 56*	56 to 46*	RBW = 9 kHz VBW \geq 9 kHz for QP VBW = 1 Hz for Average
0.5 to 5	56	46	RBW = 9 kHz VBW \geq 9 kHz for QP VBW = 1 Hz for Average
5 to 30	60	50	RBW = 9 kHz VBW \geq 9 kHz for QP VBW = 1 Hz for Average

* Decreasing linearly with logarithm of frequency

5.10.2. Method of Measurements

Refer to Ultratech Test Procedures, File # ULTR P001-2004 and ANSI C63.4 for measurement methods

5.10.3. Test Equipment List

Test Instruments	Manufacturer	Model No.	Serial No.	Frequency Range
Spectrum Analyzer/ EMI Receiver	Hewlett Packard	HP 8593EM	3412A00103	9 kHz – 26.5 GHz
Transient Limiter	Hewlett Packard	11947A	310701998	9 kHz – 200 MHz 10 dB attenuation
L.I.S.N.	EMCO	3825/2	89071531	9 kHz – 200 MHz 50 Ohms / 50 μ H
RF Shielded Chamber	RF Shielding	--	--	--

5.10.4. Test Data

Plot 3: AC Power Line Conducted Emission
 Line Tested: L1
 Line Voltage 120 VAC 60 Hz

Current Graph

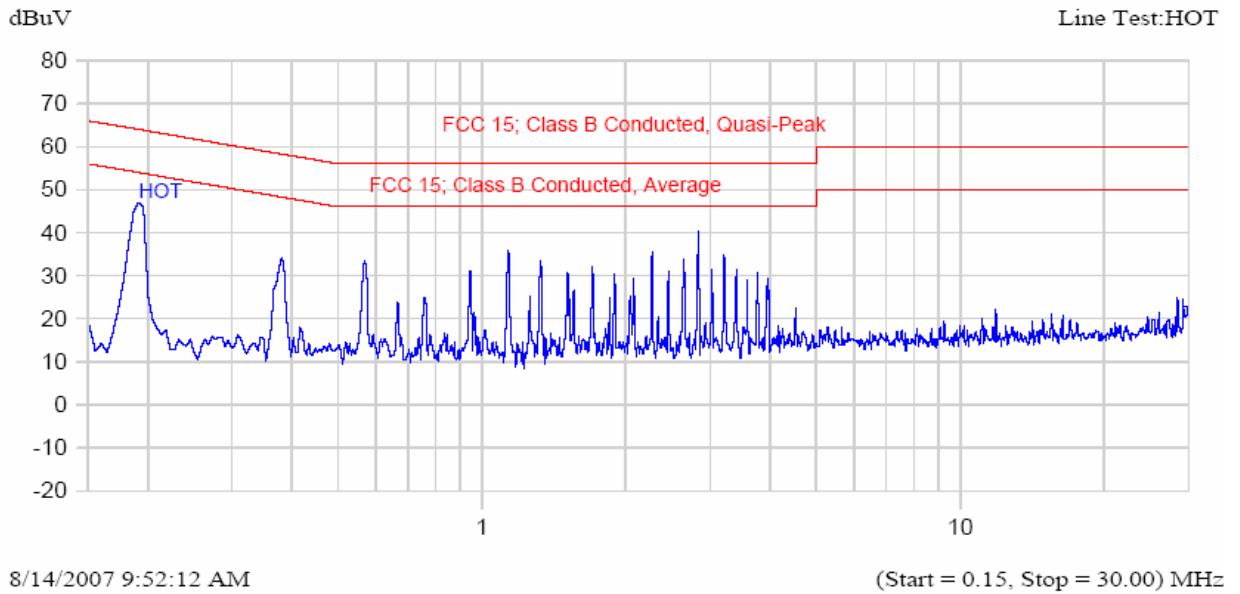

Current List

Frequency MHz	Peak dBuV	QP dBuV	Delta QP-QP Limit dB	Avg dBuV	Delta Avg-Avg Limit dB	Trace Name
0.188	51.9	49.2	-15.7	43.3	-11.6	HOT
0.375	38.1	34.7	-24.8	32.8	-16.7	HOT
2.823	40.0	38.8	-17.2	32.1	-13.9	HOT

Plot 4: AC Power Line Conducted Emission
 Line Tested: L2
 Line Voltage 120 VAC 60 Hz

Current Graph

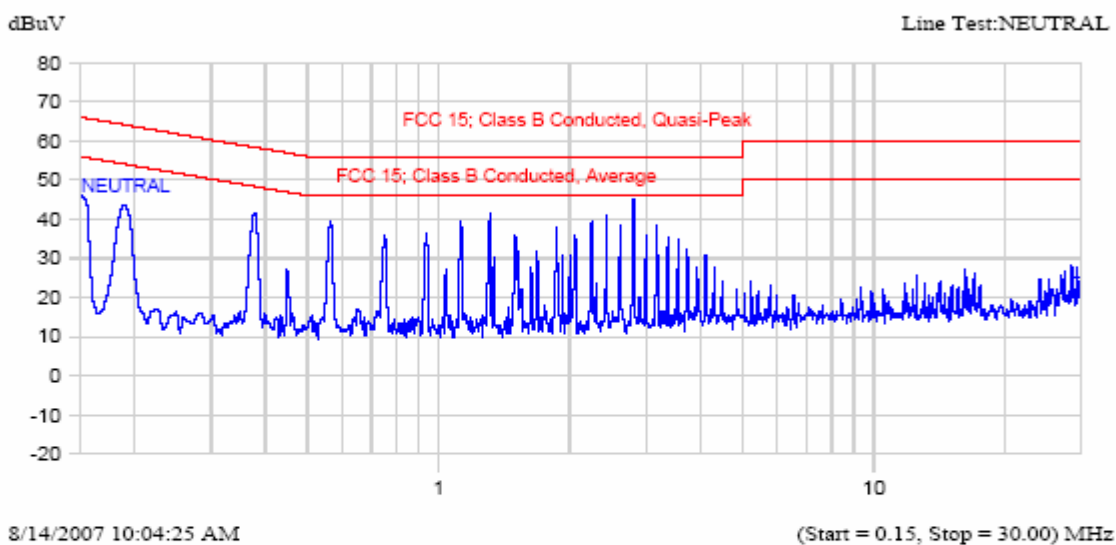

Current List

Frequency MHz	Peak dBuV	QP dBuV	Delta QP-QP Limit dB	Avg dBuV	Delta Avg-Avg Limit dB	Trace Name
0.187	50.8	50.2	-14.7	42.5	-12.4	NEUTRAL
0.374	42.5	41.4	-18.1	40.8	-8.7	NEUTRAL
0.559	41.5	40.1	-15.9	39.5	-6.5	NEUTRAL
2.797	45.5	44.3	-11.7	37.4	-8.6	NEUTRAL

EXHIBIT 6. MEASUREMENT UNCERTAINTY

The measurement uncertainties stated were calculated in accordance with the requirements of NIST Technical Note 1297 and LAB 34.

6.1. LINE CONDUCTED EMISSION MEASUREMENT UNCERTAINTY

CONTRIBUTION (Line Conducted)	PROBABILITY DISTRIBUTION	UNCERTAINTY (dB)	
		9-150 kHz	0.15-30 MHz
EMI Receiver specification	Rectangular	±1.5	±1.5
LISN coupling specification	Rectangular	±1.5	±1.5
Cable and Input Transient Limiter calibration	Normal (k=2)	±0.3	±0.5
Mismatch: Receiver VRC $\Gamma_1 = 0.03$ LISN VRC $\Gamma_R = 0.8(9 \text{ kHz}) 0.2 (30 \text{ MHz})$ Uncertainty limits $20\text{Log}(1 \pm \Gamma_1 \Gamma_R)$	U-Shaped	±0.2	±0.3
System repeatability	Std. deviation	±0.2	±0.05
Repeatability of EUT	--	--	--
Combined standard uncertainty	Normal	±1.25	±1.30
Expanded uncertainty U	Normal (k=2)	±2.50	±2.60

Sample Calculation for Measurement Accuracy in 450 kHz to 30 MHz Band:

$$u_c(y) = \sqrt{\sum_{i=1}^m u_i^2(y)} = \pm \sqrt{(1.5^2 + 1.5^2)/3 + (0.5/2)^2 + (0.05/2)^2 + 0.35^2} = \pm 1.30 \text{ dB}$$

$$U = 2u_c(y) = \pm 2.6 \text{ dB}$$

6.2. RADIATED EMISSION MEASUREMENT UNCERTAINTY

CONTRIBUTION (Radiated Emissions)	PROBABILITY DISTRIBUTION	UNCERTAINTY (+ dB)	
		3 m	10 m
Antenna Factor Calibration	Normal (k=2)	±1.0	±1.0
Cable Loss Calibration	Normal (k=2)	±0.3	±0.5
EMI Receiver specification	Rectangular	±1.5	±1.5
Antenna Directivity	Rectangular	+0.5	+0.5
Antenna factor variation with height	Rectangular	±2.0	±0.5
Antenna phase center variation	Rectangular	0.0	±0.2
Antenna factor frequency interpolation	Rectangular	±0.25	±0.25
Measurement distance variation	Rectangular	±0.6	±0.4
Site imperfections	Rectangular	±2.0	±2.0
Mismatch: Receiver VRC $\Gamma_1 = 0.2$ Antenna VRC $\Gamma_R = 0.67(Bi) 0.3 (Lp)$ Uncertainty limits $20\text{Log}(1 \pm \Gamma_1 \Gamma_R)$	U-Shaped	+1.1 -1.25	±0.5
System repeatability	Std. Deviation	±0.5	±0.5
Repeatability of EUT		-	-
Combined standard uncertainty	Normal	+2.19 / -2.21	+1.74 / -1.72
Expanded uncertainty U	Normal (k=2)	+4.38 / -4.42	+3.48 / -3.44

Calculation for maximum uncertainty when 3m biconical antenna including a factor of k = 2 is used:

$U = 2u_c(y) = 2x(+2.19) = +4.38 \text{ dB}$ And $U = 2u_c(y) = 2x(-2.21) = -4.42 \text{ dB}$