



# ADC-SUMMIT

*User Manual*

## 1.0 General Guide

Thank you for purchasing your new ADC. We recommend reading this manual, and practicing the operations before using your ADC in the field.

The ADC is designed to provide you with information essential to your needs. Data such as temperature, wind speed, barometric pressure, altitude and humidity are features specific to four different ADC models: Wind, Summit, Pro and JetSet.

Each ADC model is constructed to withstand water submersion and is ideal for conditions you endure during outdoor activities such as hiking, climbing, hunting, kayaking, skiing, and racing. Every ADC also includes current time, daily alarm, chronograph and race timer functions. ADCs are equipped with a propeller and other precise sensors to measure outdoor conditions.

### **WARNING !**

- Make sure that you fully understand the functions and limitations of the ADC before relying on it.
- The ADC is an assisting device for the outdoor user, and is not a substitute for weather advisories from a weather station. It is helpful to check the readings provided by this product periodically with those broadcasted by the weather station.

## **2.0 Care and Maintenance**

Prevent getting dirt in the ADC propeller. It could clog the mechanism.

Avoid exposing this product to extreme heat or extreme cold for an unreasonable amount of time.

Avoid severe impacts to the ADC.

Store the ADC in a dry place when it is not in use.

Clean the ADC with a soft moistened cloth occasionally.

**DO NOT** expose the ADC to strong chemicals such as gasoline and alcohol, as they will damage this product.

### 3.0 Part description

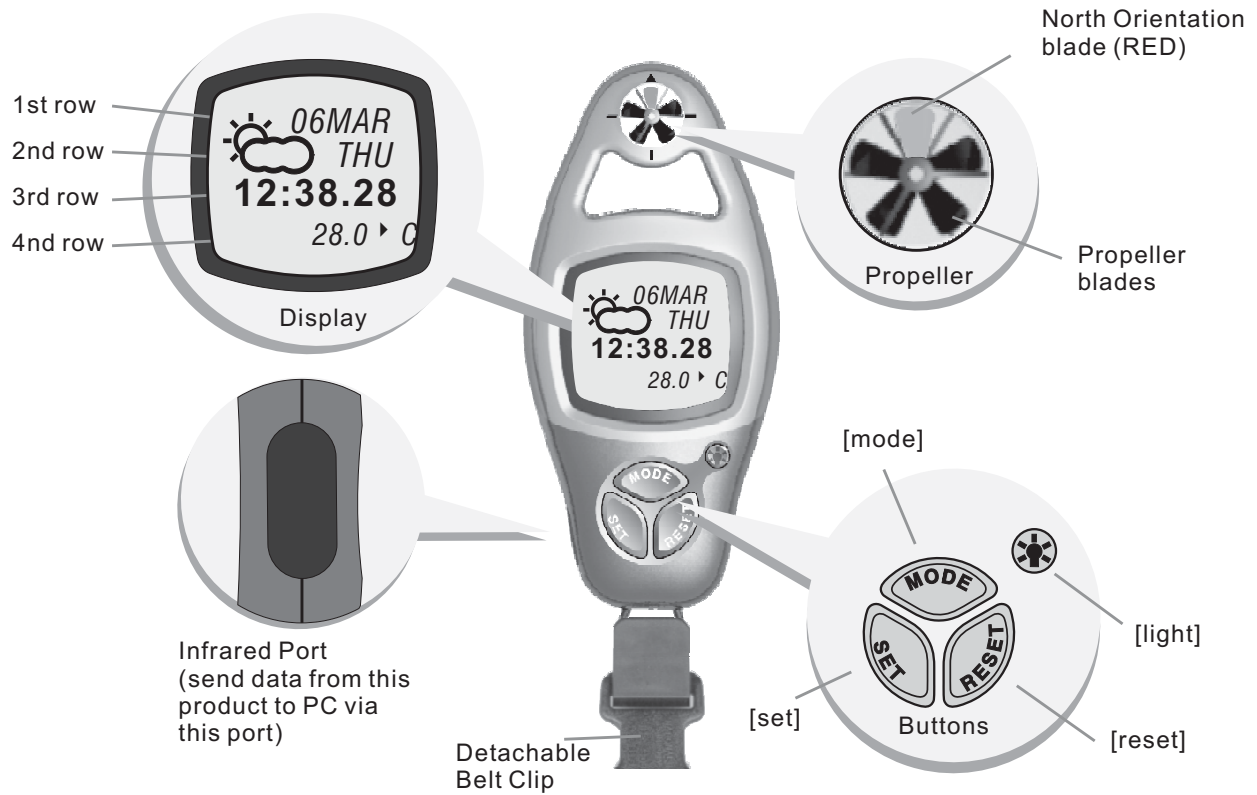

## 4.0 Button Operation Summary 1

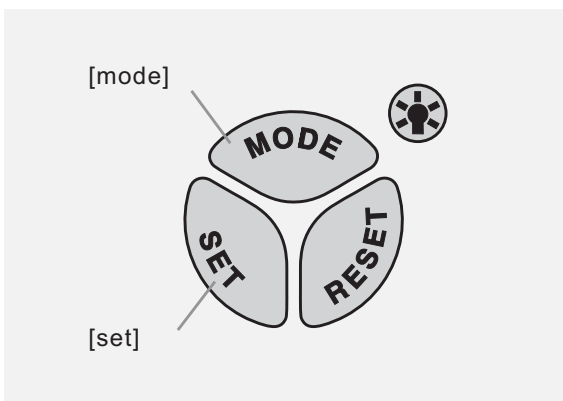

**Note:**

The button operations are summarized in the following paragraphs, for detail operating instructions, please continue reading.

**[mode] Button**

Press the mode button to select among the major function modes

In function modes: Press and hold the mode button to select setting display

In any setting display: Press the mode button to select among different settings. Press and hold the mode button to exit setting sequence.

**[set] Button**

In Current Time Mode: press the set button to select the Daily Alarm Display.

In Daily Alarm Mode: Press the set button to switch the daily alarm between ON and OFF.

In Chronograph Mode and Race Timer Mode: Press the set button to start or stop the counting.

In Lap Time Recall Mode: Press the set button to select the available lap time(s).

In setting displays: press the set button to scroll the through the settings.

## 4.1 Button Operation Summary 2

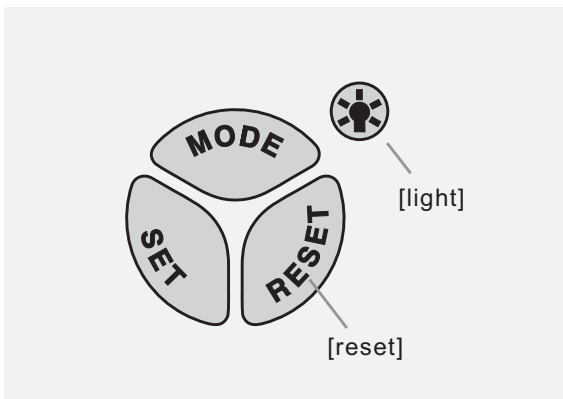

**Note:**

The button operations are summarized in the following paragraphs, for detail operating instructions, please continue reading.

**[reset] Button**

In Chronograph Mode (counting): Press the reset button to get Lap Time Display.

In Chronograph Mode (stop-counting): Press the reset button to reset the display to zero.

In Timer Mode (stop-counting): Press the reset button to reset the timer to target time.

In Lap Time Recall Mode: Press the reset button to select the available lap time(s).

In setting displays: press the reset button to scroll the through the settings.

**[light] Button**

In any functional mode/display, press the light button once to turn ON the EL backlight for about 3 seconds.

## 5.0 Major Functional Modes

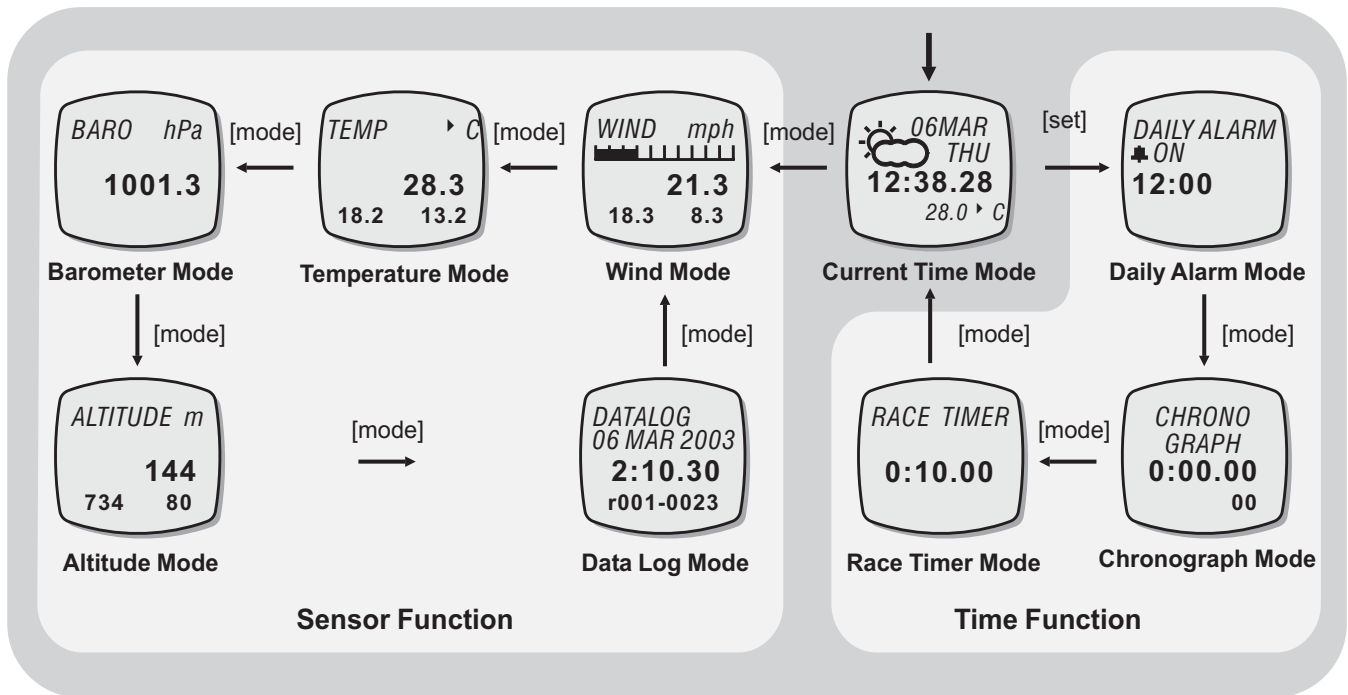

Major Functional Modes

## 6.0 Current Time Mode - Functional Displays

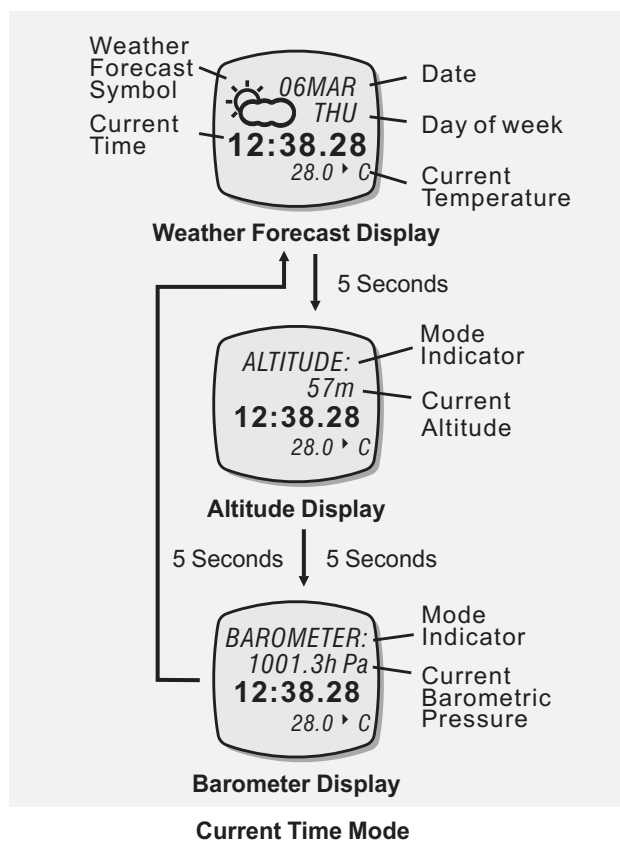

### Functional Displays

- Current Time Mode includes three different displays: the Weather Forecast Display, Altitude Display and Barometer Display.
- The above displays rotate through every 5 seconds.
- The current time, relative humidity and current temperature appear on the 3rd and 4th row of the display respectively.

### Weather Forecast Display

- In Weather Forecast Display, the weather forecast symbol and day of week appear on the 1st and 2nd row of the display respectively. Check the coming 'Weather Forecast Symbols' section below for more detail on the means of the weather forecast symbols

### Altitude Display

- The indicator 'ALTITUDE' appears on the 1st row of the display. The altitude at the current location appears on the 2nd row of the display.

### Barometer Display

- The indicator 'BAROMETER' appears on the 1st row of the display. The current barometric pressure appears on the 2nd row of the display.



## 6.1 Current Time Mode - Setting the Current Time Mode

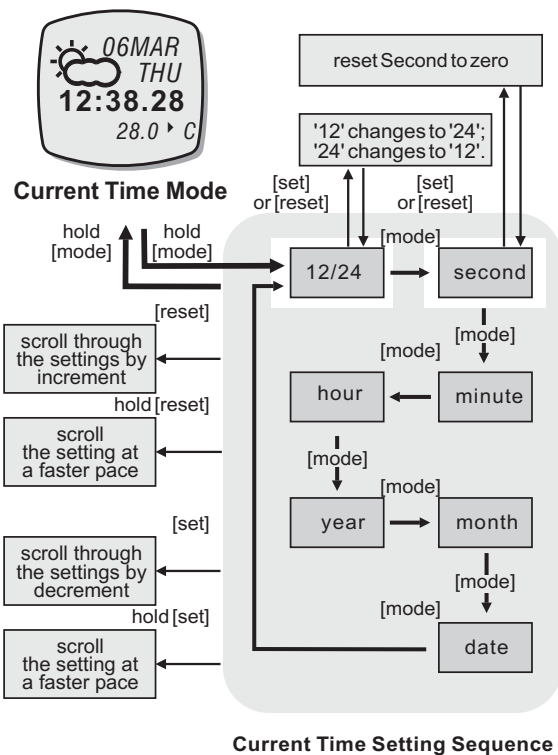

### To Select Setting Display

- Setting the current time and date, and their display formats, press and hold the [mode] button for about 2 seconds to select the setting display (the '12' indicator will start flashing).

### The Setting Sequence

- In setting display, press the [mode] button to move the setting following the adjacent diagram.
- When the '12' or '24' digits starts flash, press the [set] or [reset] button to switch between '12' (12 hour format) and '24' (24 hour format). When the 'second' digits starts flash on the display, press [set] or [reset] button to reset the second to zero.
- If one of the settings (minute, hour, year, month, date) starts flash, press the [set] or [reset] button to scroll through the setting (hold down the button to scroll the setting at a faster pace).
- When the above settings finished, press and hold the [mode] button for about 2 seconds to exit the setting sequence.

## 6.2 Current Time Mode - Weather Forecast Symbols

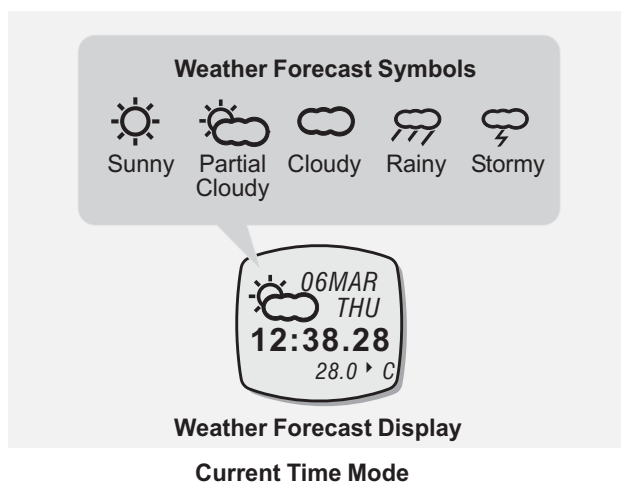

### Note:

- When the ADC has been reset or the battery has been replaced, partial cloudy symbol will be displayed. To get an accurate weather forecasting, the ADC must stay at the same altitude for over 12 hours.

### Weather Forecast Symbol

- The ADC includes a weather forecast function that predicts the weather for the next 12 hours.
- The ADC will display the forecasted weather by the weather forecast symbol. There are five kind of weather forecast symbols, they are the Sunny, Partial Cloudy, Cloudy, Rainy and Stormy.

### What Does the Weather Forecast Symbol indicate

- A 'Sunny' symbol generally indicates improving weather or sunny weather ahead.
- A 'Partial Cloudy' symbol generally indicates slightly cloudy weather ahead.
- A 'Cloudy' symbol generally indicates deteriorating weather or cloudy weather ahead.
- A 'Rainy' symbol generally indicates adverse weather or rainy weather ahead.
- A 'Stormy' symbol generally indicates stormy weather ahead.

## 7.0 Daily Alarm Mode - Daily Alarm Display

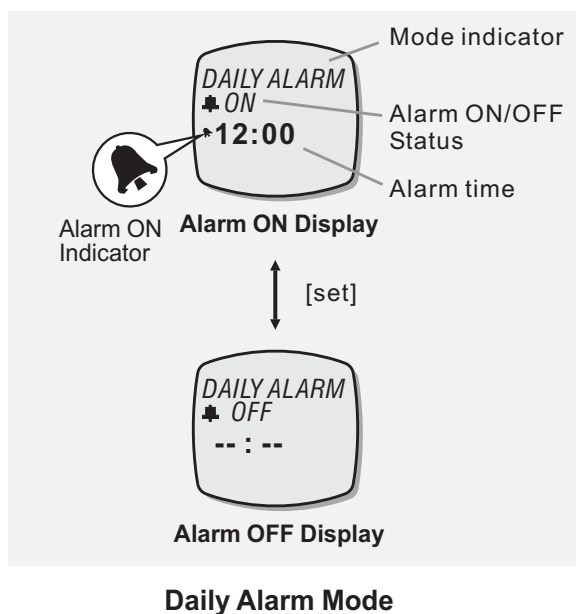

### Daily Alarm Display

- In Daily Alarm Mode, the display will show the following:
  - 1) The mode indicator 'DAILY ALARM' appears on the 1st row of the display.
  - 2) The 'ON' or 'OFF' status indicator appears on the 2nd row of the display.
  - 3) The alarm time (hour and minute) appears on the 3rd row of the display.

### To Select Daily Alarm between ON and OFF

- To select the daily alarm between ON and OFF, press the [set] button once.
- When the daily alarm is ON, the Alarm ON Indicator '🔔' appear otherwise it is OFF.

### Daily Alarm Sound

- When the daily alarm is ON, the product will beep at the predefined alarm time for about 30 seconds.
- When the beep sounds, it can be stopped prematurely by pressing any of the buttons except the [light] button.

## 7.1 Daily Alarm Mode - Setting the Daily Alarm Mode

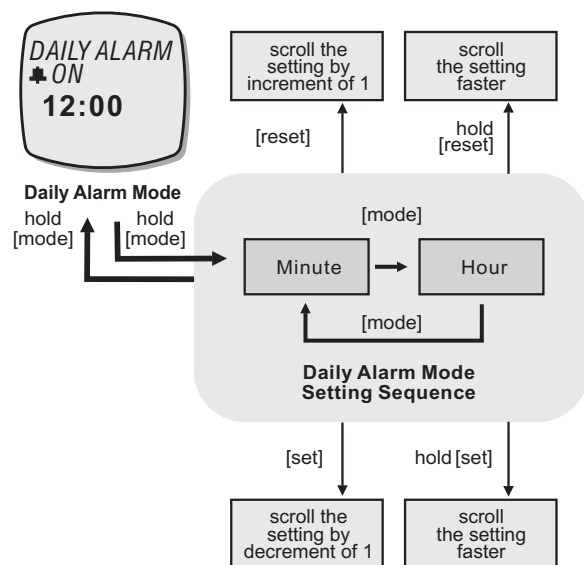

### To Select the Setting Display

- Setting the Daily Alarm Time, press and hold the [mode] button for about 2 seconds to select the setting display (the 'minute' digits will start flashing).

### The Setting Sequence

- In setting display, press the [mode] button to move the setting between minute and hour settings.
- When one of the settings (minute and hour) digits start to flash on the display, press the [set] or [reset] button to scroll through the setting (hold down the button to scroll the setting at a faster pace).
- When the setting finished, press and hold the [mode] button to exit the setting sequence.
- The setting display will change to Current Time Mode automatically if no key-stroke has been activated for about 1 minute.

## 8.0 Chronograph Mode - Chronograph Display

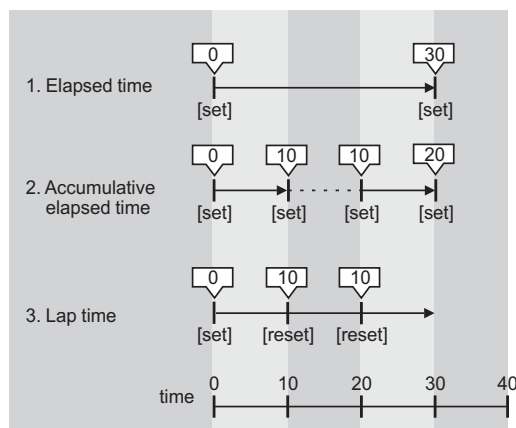
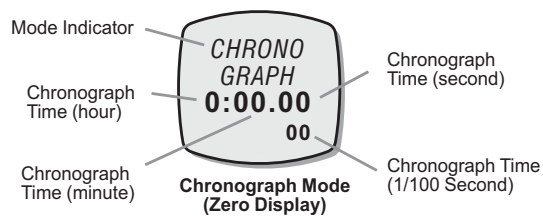

Elapsed Time, Accumulative Elapsed Time and Lap Time

..... : Stop Counting    ————— : Counting

### Chronograph Function

- The ADC is equipped with a Chronograph Mode, it can measure 3 different periods of time. They are:
  - 1) Elapsed time,
  - 2) Accumulative elapsed time
  - 3) Lap time

### Chronograph Display

- In Chronograph Mode, the display will show the following:
  - 1) The mode indicator 'CHRONOGRAPH' appears on the 1st and 2nd row of the display.
  - 2) The chronograph time (hours, minutes, seconds) appears on the 3rd row of the display.
  - 3) The lap number and chronograph time (1/100 second) appears on 4th row of the display.
- The display shows the 'Zero' display, if the product or the chronograph has been reset.
- The maximum counting range of the chronograph is 99 hours, 59 minutes and 59.99 seconds. The chronograph can record up to 50 laps.

## 8.1 Chronograph Mode - Using the Chronograph

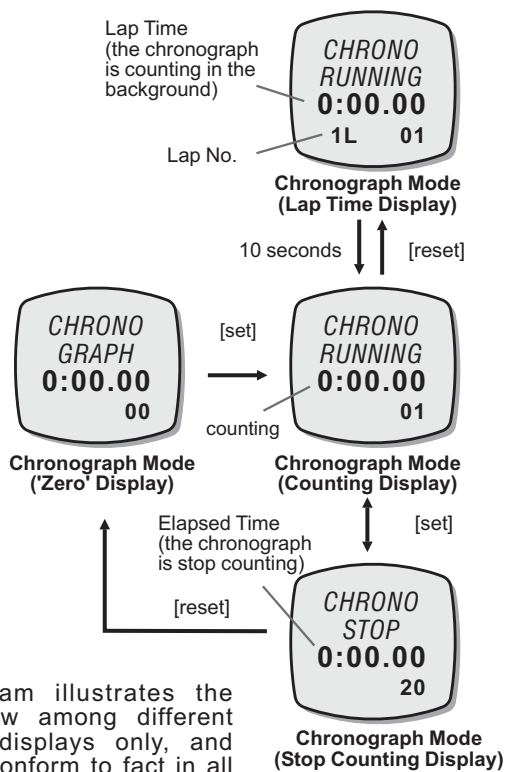

### Note:

This diagram illustrates the general flow among different functional displays only, and may NOT conform to fact in all instances.

### Chronograph Function

- In 'Zero' Display, press the [set] button once to start the counting. When it is counting, press the [set] button again to stop the counting, and the elapsed time of which the chronograph is counting will appear.
- When the elapsed time is displaying, repeat the key operations above to get the accumulative elapsed time or press the [reset] button to reset the chronograph. Check the below 'To Reset the Chronograph' section for more detail on how to reset the chronograph.

### To Record a Lap Time

- When the chronograph is counting in the previous operations, press the [reset] button to display Lap Time Display for 10 seconds.
- When the Lap Time is displaying, the chronograph remains counting in the background.

### To Reset the Chronograph

- To reset the chronograph, to be ready for a new operation, press the [reset] button once when the chronograph has stopped counting. The display will then return to 'Zero' Display.

## 8.2 Chronograph Mode - Recall the Lap Time

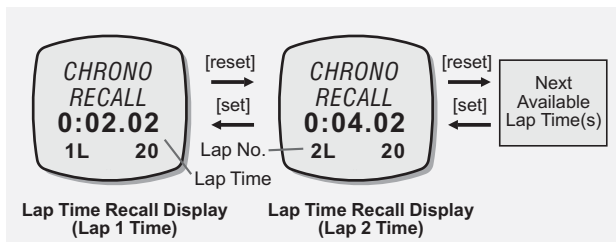
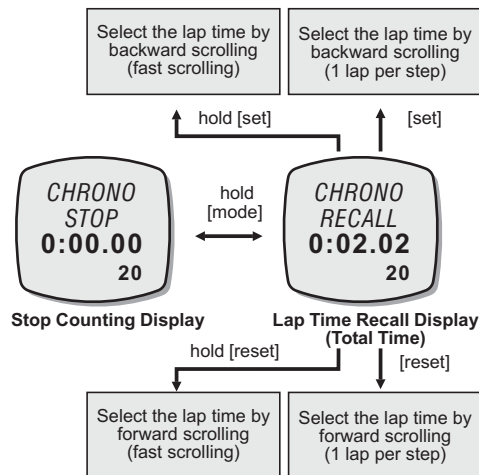

### To Recall the Lap Time

- In Stop Counting Display, press and hold the [mode] button to select the Chronograph Recall Display.
- In Chronograph Recall Display, the total elapsed time will appear. To recall the individual lap time, press the [set] or [reset] button to select the target lap time (hold down the button to scroll the setting faster) following the adjacent diagram.
- In Chronograph Recall Display, press and hold the [mode] button to return to the Stop Counting Display.

### Chronograph Recall Display

- In Chronograph Recall Display, the display will show the following:
  - 1) The mode indicator 'CHRONO RECALL' appears on the 1st and 2nd row of the display.
  - 2) The lap time (hours, minutes, seconds) appears on the 3rd row of the display.
  - 3) The lap number and lap time (1/100 second) appears on the 4th row of the display.

## 9.0 Race Timer Mode - Race Timer Display

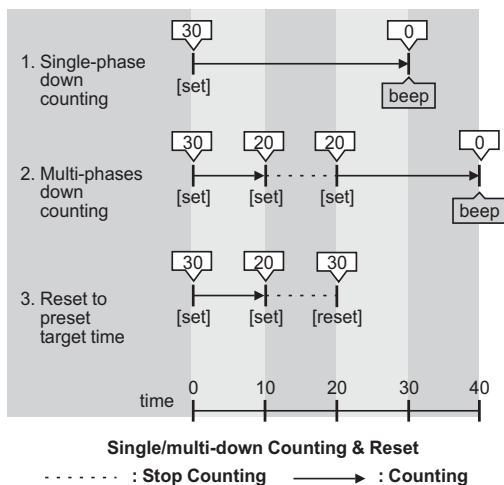
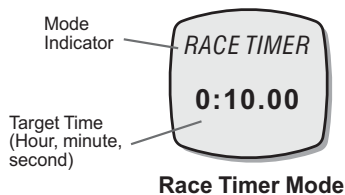

### The Target Time

- The ADC is equipped with a countdown timer to keep track of a fixed period of time (target time).
- The user can set a target time of up to 99 hours, 59 minutes 59 seconds.
- Check the coming '*Setting the Race Timer Mode*' section for more detail on how to set the target time in Racer Timer Mode.

### Race Timer Display

- In Race Timer Mode, the display will show the following:
  - 1) The mode indicator '*RACE TIMER*' appears on the 1st row of the display.
  - 2) The target time (hours, minutes, seconds) appears on the 3rd row of the display.
- The maximum counting range of the Race Timer is 99 hours, 59 minutes and 59 seconds.



## 9.1 Race Timer Mode - Setting the Race Timer Mode

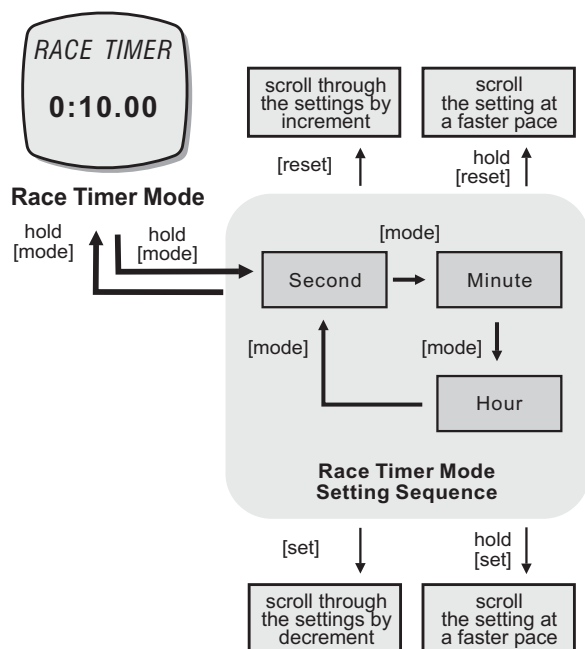

### To Select the Setting Display

- Setting the target time in Race Timer Mode, press and hold the [mode] button for about 2 seconds to select the setting display (the second digits will start flashing).

### Setting Sequence

- In setting display, press the [mode] button to move setting following the adjacent diagram.
- When the one of the settings (second, minute, hour) start to flash, press the [set] or [reset] button to scroll through the settings (hold down the button to scroll at a faster pace).
- When the setting finished, press and hold the [mode] button for about 2 seconds to exit the setting sequence.
- The setting display will change to Race Timer Mode automatically if no key-stroke has been activated for about 1 minute.

## 9.2 Race Timer Mode - Using the Race Timer

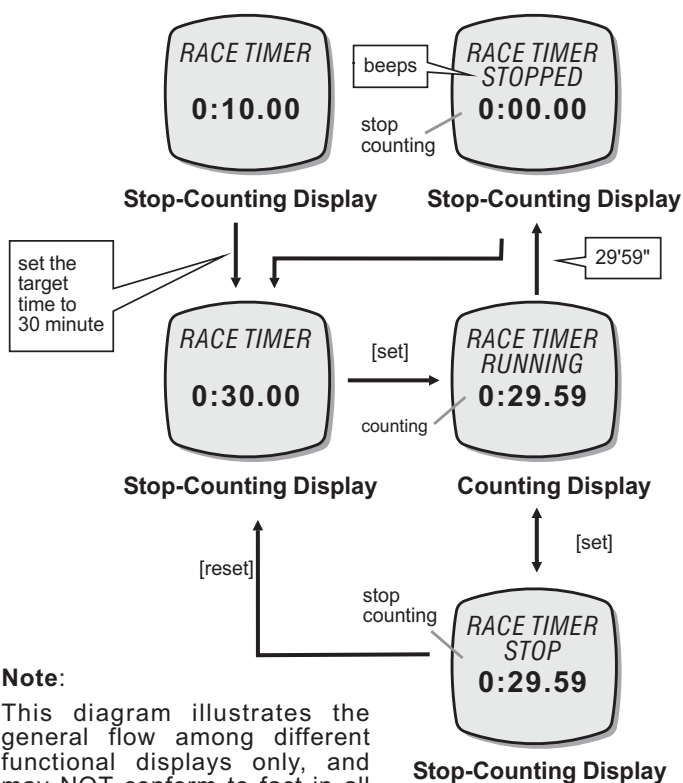

### Note:

This diagram illustrates the general flow among different functional displays only, and may NOT conform to fact in all instances.

### To Use the Race Timer

- Once a target time has been set, press the [set] button once to start the countdown. When it is running, press the [set] button again to stop the countdown.
- The countdown time will be displayed continuously throughout the operation.

### To Reset the Timer

- To reset the timer to the preset target time before the countdown reaches zero, press the [reset] button once when the timer has been stopped.
- To set a new value for the target time, check the previous 'Setting the Race Timer Mode' section for more detail on how to set the Racer Timer Mode.

### Race Timer Alarm Sound

- At the last 10 minutes, the Alarm will beep once for every minute.
- At the last 10 seconds, the Alarm will beep once for every second.
- At zero, the Alarm will beep for about 2 seconds.

## 10.0 Sensor Functions Mode - Manual Data Log Function

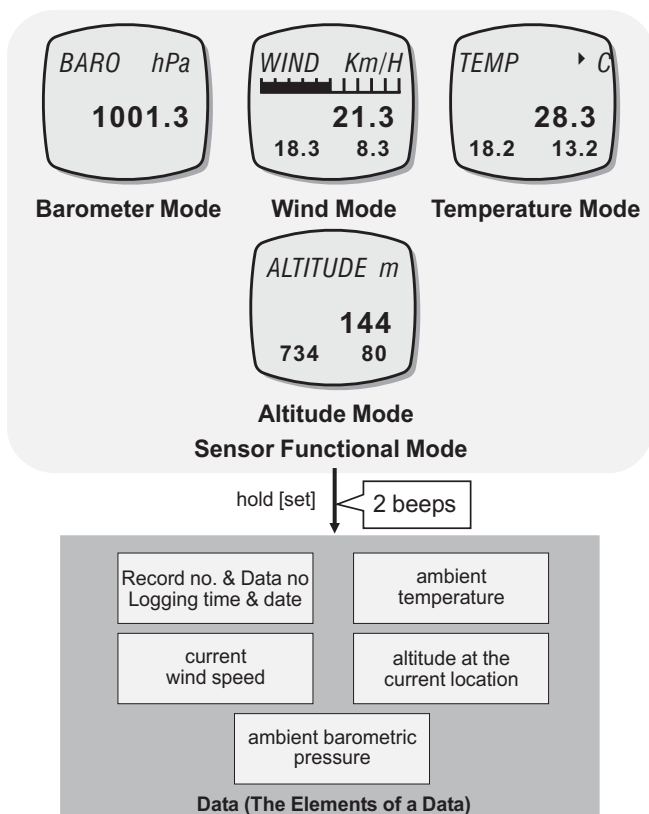

### Data Log Function

- The ADC is equipped with a function to log the sensor functional mode readings. They are the current wind speed, ambient temperature, barometric pressure and the altitude at current location.
- The record also includes the time and date that data was logged.
- The ADC can log data automatically or manually. Check the 'Automatic Data Log' section below for more detail on how to log data automatically.

### To Log the Data Manually - Manual-Log

- To log a data manually, press and hold the [set] button for about 2 seconds in one of the functional modes (Temperature, Wind Speed, Barometer and Altimeter).
- When two beeps sounds, the record is logged.
- You can log another record at any desirable moment as long as there is sufficient memory.
- Check the coming 'Logged Record and Data' section for more detail on how to review the logged data.

## 11.0 Wind Speed Mode - Before Using the Wind Speed Mode

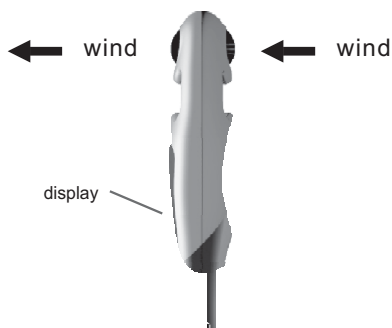
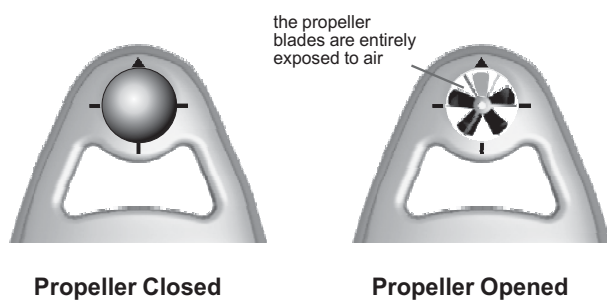

**Point the Propeller towards the wind direction**

### How Wind Speed is Measured

- The ADC is equipped with a propeller that is similar to a traditional anemometer.
- When the propeller faces the wind, it rotates and generates signal. This product will pick up the signal and converts it into wind speed.

### Before and After Measuring a Wind Speed

- Turn the ball-shaped propeller by your thumb and index finger until the propeller blades are entirely exposed, and it is not sheltered by the case.
- After a wind speed measurement, rotate the propeller to a closed position to prevent dirt from getting into it.

### To Measure Wind Speed

- Select Wind Speed Mode. Point the blades directly towards the wind direction, and make sure that the blades rotate freely.
- When the wind passes through the propeller, the blades rotate. The ADC starts to measure, and shows the current, average and maximum wind-speed readings.

## 11.1 Wind Speed Mode - Wind Speed Mode Function

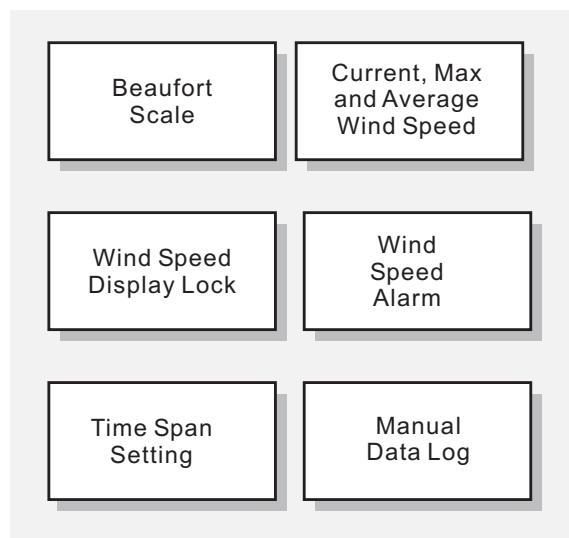

**Wind Speed Mode Functions**

### Wind Speed Mode Functions

- This ADC has the following wind speed functions:
  - 1) The Beaufort Scale: The longest and most widely used set of criteria to describe the wind conditions. Check the coming '*Beaufort Scale*' section for more detail on Beaufort Scale.
  - 2) The Current, Maximum and Average Wind Speed.
  - 3) Wind Speed Alarm: alarm that alerts the user when the current wind speed is higher than the predefined level.
  - 4) Wind Speed Display Lock: This feature can lock the wind speed display for 5 seconds.
  - 5) Time Span Setting: This feature defines the time for the Average Wind Speed Calculation. Check the coming '*Time Span Setting for Average Wind Speed*' section for more detail on the setting.
  - 6) Manual Data Log: The function to log the sensor functional mode readings that is currently obtained from sensors.

## 11.2 Wind Speed Mode - Wind Speed Display

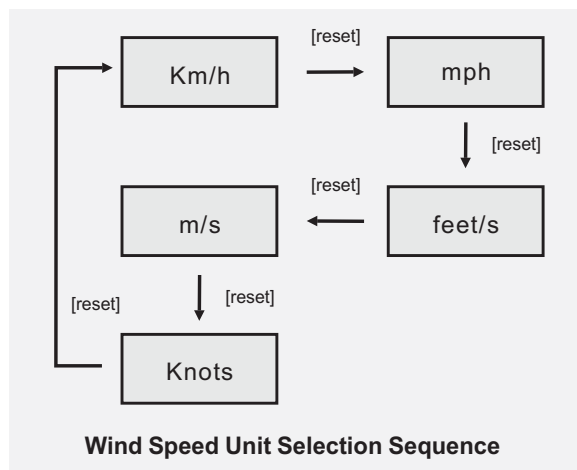
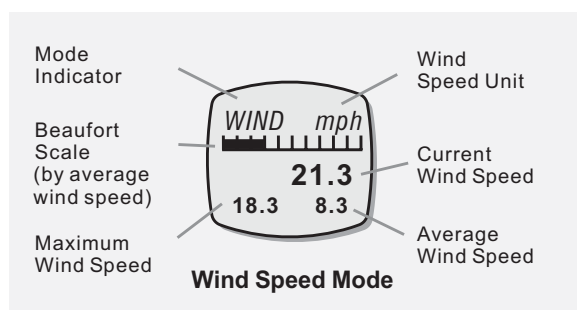

### Wind Speed Display

- In Wind Speed Mode, the display will show the following:
  - 1) The 'WIND' Indicator and the wind speed unit appear on the 1st row of the display.
  - 2) The Beaufort Scale (calculated by average wind speed) appears on the 2nd row of the display.
  - 3) The Current Wind Speed appears on the 3rd row of the display.
  - 4) The maximum and average wind speed appears on the 4th row of the display.

### To Change Wind Speed Unit

- This ADC can display wind speed in the following wind speed units:
  - 1) Km/h (Kilometer per hour),
  - 2) mph (mile per hour),
  - 3) feet/s (feet per second)
  - 4) m/s (meter per second) and
  - 5) Knots.
- In Wind Speed Mode, press the [reset] button to change the wind speed unit following the adjacent diagram.

## 11.3 Wind Speed Mode - What is Beaufort Scale?

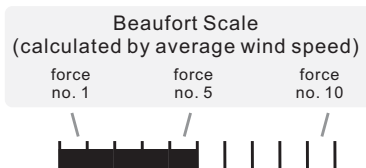
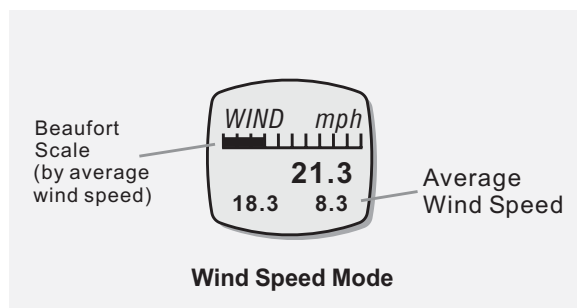

**Example A: Number 5 of Beaufort Scale**

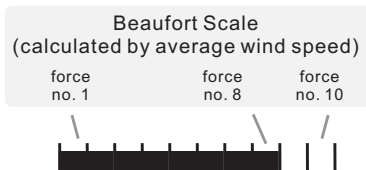

**Example B: Number 8 of Beaufort Scale**

### What is Beaufort Scale?

- Beaufort Scale is the longest and most widely used set of criteria to describe the wind conditions and its effects on land as well as on sea.
- It categorizes the wind speed into 13 force numbers, from 0 (calm) to 12 (hurricane). Check the 'Beaufort Scale Table' section below for more detail on the Beaufort Scale.

### Beaufort Scale Bar

- For user's convenience, the ADC displays Beaufort Scale for average wind speed.
- The ADC exhibits Beaufort Scale by displaying different number of bars on the upper row of the display. One exhibited bar is equivalent to one Beaufort Scale force number. For example, if there are 5 bars on the display, the average wind speed is equivalent to force number 5 of Beaufort Scale.
- The ADC displays the Beaufort Scale force number from 0 to 10 (if the average wind speed is higher than force number 10, the ADC will display 10).

## 11.4 Wind Speed Mode - Beaufort Scale Table

Beaufort number	m/s	MPH	International Description	Observed conditions
0	< 1	<1	Calm	Calm; smoke rises vertically
1	1	1-3	Light air	Directions of wind shown by smoke drift but not by wind vanes
2	2	4-7	Light breeze	Wind felt on face; leaves rustle, vanes moved by wind
3	4	8-12	Gentle breeze	Leaves and small twigs in constant motion; wind extends light flag
4	7	13-18	Moderate	Raises duct, loose paper; small branches moved
5	10	19-24	Fresh	Small trees in leaf begin to sway; crested wavelets form on inland waters
6	12	25-31	Strong	Large branches in motion; whistling heard in telephone wires; umbrellas used with difficult
7	15	32-38	Near gale	Whole trees in motion; resistance felt walking against wind
8	18	39-46	Gale	Breaks twigs off trees; impedes walking
9	20	47-54	Strong gale	Slight structural damage occurs
10	26	55-63	Storm	Trees uprooted; considerable damage
11	30	64-72	Violent storm	Widespread damage
12	≧33	>73	Hurricane	

**Beaufort Scale**



## 11.5 Wind Speed Mode - Wind Speed Display Lock, Reset Max Wind Speed

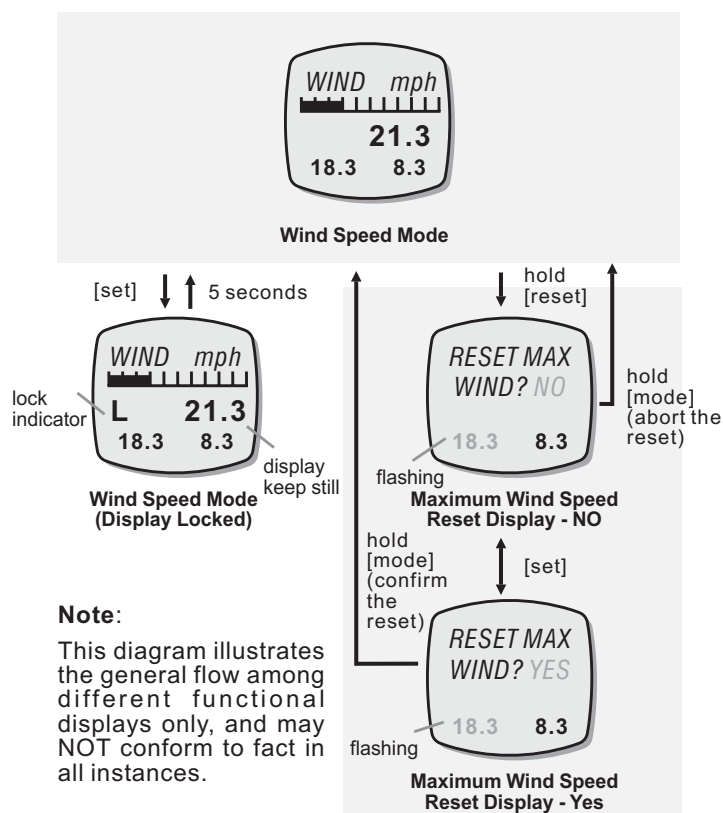

### Wind Speed Display Lock

- The ADC is equipped with a function to hold the fluctuating wind speed reading on the display.
- In Wind Speed Mode, press the [set] button to lock the wind speed reading (the display will hold the current reading for 5 seconds).

### Reset the Maximum Wind Speed

- To reset the maximum wind speed, press and hold the [reset] button for 2 second to select the Reset Display.
- When the Reset Display is displayed, press the [set] button to select between 'YES' and 'NO'.
- In the 'YES' display, press and hold the [mode] button for 2 about seconds to confirm the reset (the maximum wind speed will reset to zero).
- To abort the reset, press and hold the [mode] button for 2 seconds in the 'NO' display.

## 11.6 Wind Speed Mode - Wind Speed Alarm

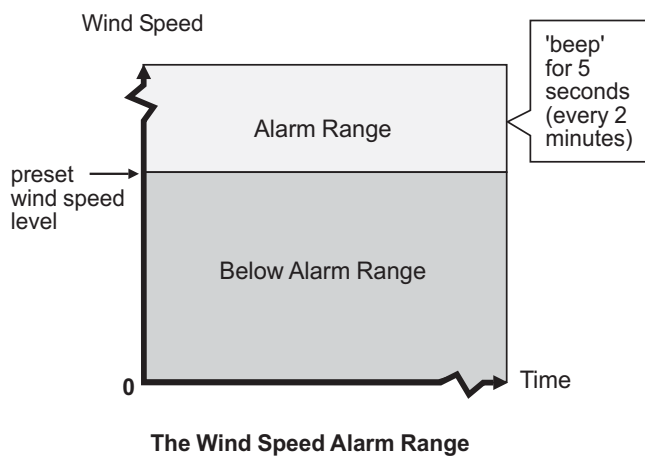

### Wind Speed Alarm

- The ADC is equipped with a wind speed alarm.
- That alarm alerts user when the current wind speed is equal to or higher than the preset wind speed level.

### Wind Speed Alarm Sound

- In Wind Speed Mode, if the Current Wind Speed is equal to or larger than the preset wind speed level, the ADC will start beeping for about 5 seconds.
- After the first beeping, the ADC will beep again for every 2 minutes if the current wind speed holds above the preset level.
- The above repeated alarm will stop unless the wind speed again exceeds the preset level or the wind speed alarm is set to OFF.

## 11.7 Wind Speed Mode - Setting the Wind Speed Alarm and Time Span

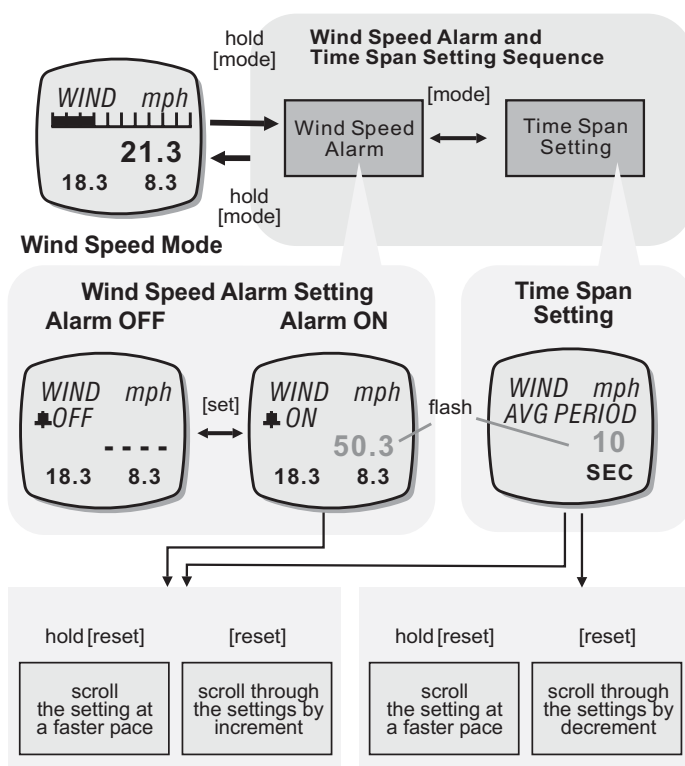

To Set the Wind Speed Alarm, and Time Span for Average Wind Speed Calculation

- To set the wind speed alarm, press and hold the [mode] button for about 2 seconds to select the setting display (wind speed starts flashing).
- When the 'wind speed' is flashing, press the [mode] button to select between time span setting and wind speed alarm setting.
- When 'wind speed' is flashing, press the [reset] button to scroll the target wind speed level by 1 step (hold down the button to scroll the setting faster). To select the wind speed alarm between ON and OFF, press the [set] button.
- When 'time' is flashing, press the [set] or [reset] button to scroll the target time span for average wind speed calculation by 1 (hold down the button to scroll the setting faster).
- Press and hold the [mode] button for about 2 seconds to exit the setting sequence.
- The setting display will change to Wind Mode automatically if no key-stroke has been activated for about 1 minute.

## 11.8 Wind Speed Mode - Using the Propeller as a Mechanical Compass

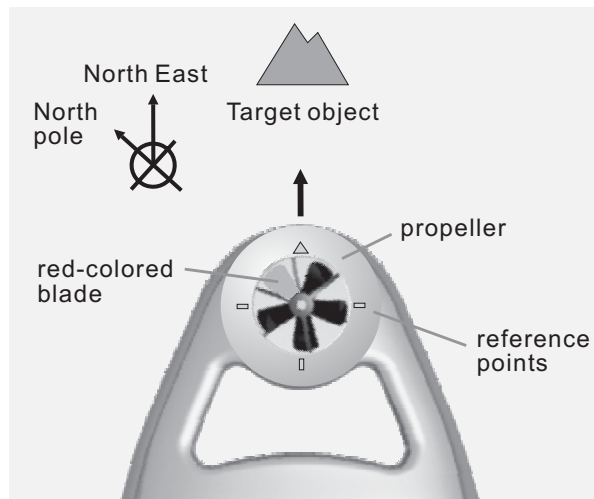

**Using the Propeller as a Mechanical Compass**

### Propeller as a Mechanical Compass

- The ADC measures ambient temperature, wind speed, and it also tells compass directions.
- One of the propeller blades is red-colored to indicate the magnetic north pole.
- Four reference points were engraved on the ADC as reference points.

### To use the Mechanical Compass

- To check bearing of an object, make sure that the propeller cover is opened, and the blades are entirely exposed to air.
- Tilt the ADC until the propeller blades are parallel to the horizon, and the propeller blades rotate freely.
- The red-colored blade of the propeller will point to the magnetic north pole. Make use of the reference points (marked on the product) to check the direction of the target object.

## 12.0 Temperature - Temperature Functions

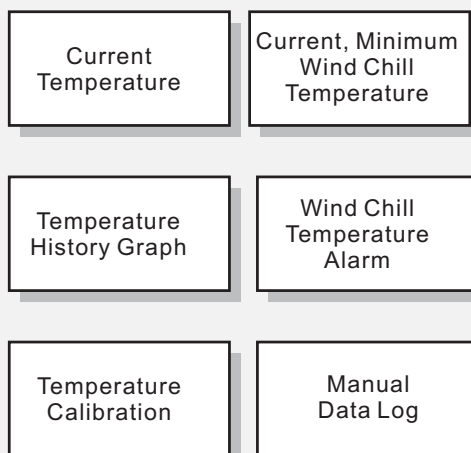

**Temperature Mode Functions**

### Temperature Mode Functions

- The ADC has the following temperature functions:
  - 1) The Current Temperature: The Current Temperature readings.
  - 2) The Current and Minimum Wind Chill temperature: The wind effect on temperature. Check the 'WindChill Temperature' section below for more detail on Wind Chill Temperature.
  - 3) The Temperature History Graph: The temperature memory for the last 24 hours.
  - 4) The Wind Chill Temperature Alarm: alarm to alert the user when the current Wind Chill Temperature is lower than the predefined limit.
  - 5) The Calibration: The process to calibrate the temperature reading.
  - 6) Manual Data Log: The function to log the sensor functional mode readings that is currently obtained from sensors.

## 12.1 Temperature - Temperature Display

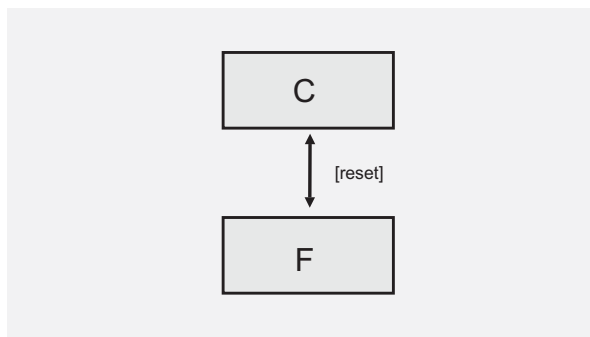
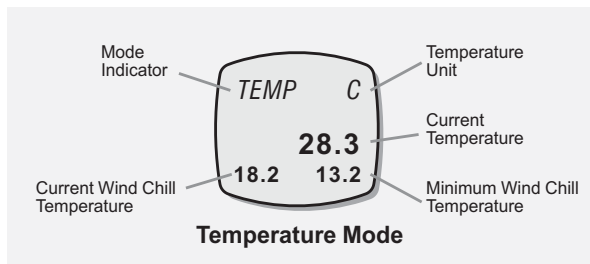

### Temperature Display

- In Temperature Mode, the display will show the following:
  - 1) The 'TEMP' Indicator and the temperature unit appear on the 1st row of the display.
  - 2) The Current Temperature appears on the 3rd row of the display.
  - 3) The Current and Minimum Wind Chill Temperature appear on the 4th row of the display.

### To Change Temperature Unit

- The ADC can display temperature in the following units:
  - 1) Degree Celsius ( ° C)
  - 2) Degree Fahrenheit ( ° F)
- In Temperature Mode, press the [reset] button once to change the temperature unit. See adjacent figure.

## 12.2 Temperature Mode- Wind Chill Temperature

Case	Wind Conditions	Current Temperature	Wind Chill Temperature	Weather
1.	NO wind	15F/ -9.4C	15F/ -9.4C	Cold
2.	wind speed at 50 mph/ 80.5 km/h	15F/ -9.4C	-10F/ -23.3C	Very Cold
3.	NO wind	-10F/ -23.3C	-10F/ -23.3C	Very Cold

**Wind Chill Temperature Effects**

### What is Wind Chill Temperature

- Wind chill is a temperature factor that combines air temperature and the effect of blowing wind.
- As blowing wind makes you feel as though the temperature is lower than simple air temperature.
- For example, if it is -9.4 degrees Celsius and the wind blows at 80.5 km per hour: People will feel as if the temperature is -23.3 degrees Celsius. In this case, the wind chill temperature is -23.3 degrees Celsius.
- The ADC is also equipped with wind chill temperature functions, including displaying current and minimum wind chill temperature, and having a wind chill temperature alarm.

### Note:

- Wind chill temperature is the effect that combines wind speed and temperature, the ADC must measure the wind speed in order to display the wind chill temperature.
- Check the previous '*Before Using the Wind Speed Mode*' section for more detail on Wind Speed Measurement.

## 12.3 Temperature Mode - To Reset Minimum Wind Chill Temperature

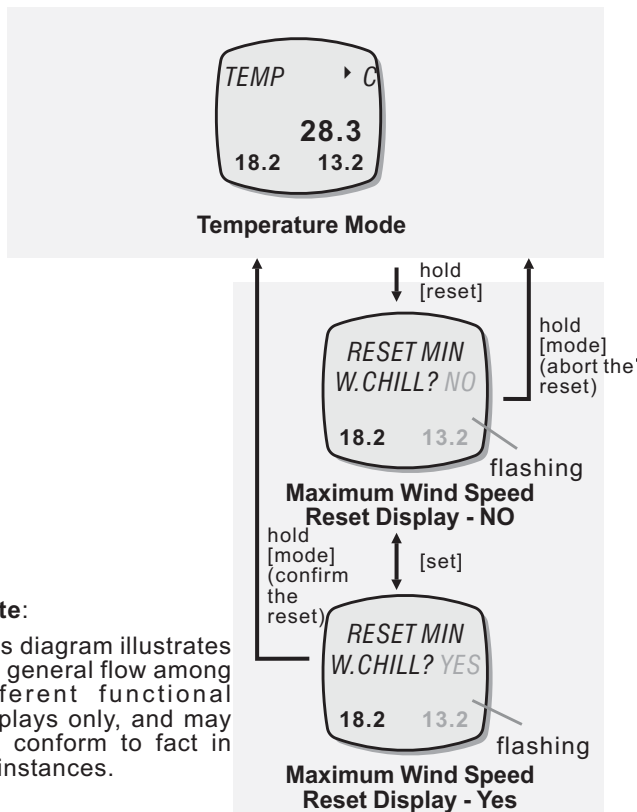

**Note:**

This diagram illustrates the general flow among different functional displays only, and may not conform to fact in all instances.

### To Reset the Minimum Wind Chill Temperature

- To reset the minimum wind chill temperature, press and hold the [reset] button for 2 seconds to select the Reset Display.
- When the Reset Display is displaying, press the [set] button to select between the 'YES' and 'NO' Display.
- In the 'YES' display, press and hold the [mode] button for about 2 seconds to confirm the reset (the minimum wind chill temperature will reset to zero).
- To abort the reset, press and hold the [mode] button for 2 seconds in the 'NO' display.



## 12.4 Temperature Mode - Temperature History Graph for the Last 24 Hours

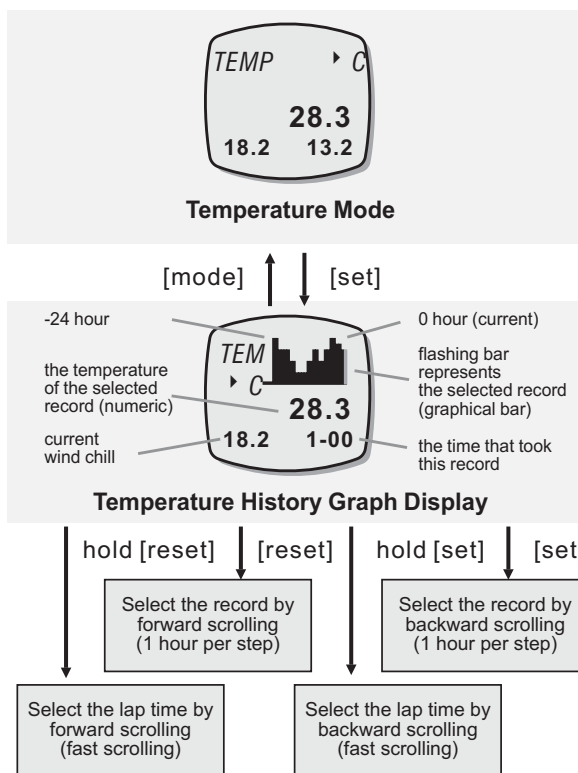

### Temperature History Graph

- The ADC is equipped with a temperature memory function. It records the last 24-hour temperature and displays them by bar-graph.
- In Temperature Mode, press the [set] button to select the Temperature History Graph Display.
- While in the Temperature History Graph Display setting, the right most bar will start flashing.
- The right most bar represents the current temperature (0 hour). While the other bars represent the temperature records of the last 24 hours. Each temperature record is taken at the hour (i.e. 12:00, 1:00, 2:00 ...)
- To browse the temperature record at different times, press the [set] button to select the record by backward scrolling or [reset] button to select time by forward scrolling (hold down the button to scroll the setting at a faster pace).
- Press the [mode] button once to exit the Pressure History Graph Display.

## 12.5 Temperature Mode - Wind Chill Temperature Alarm

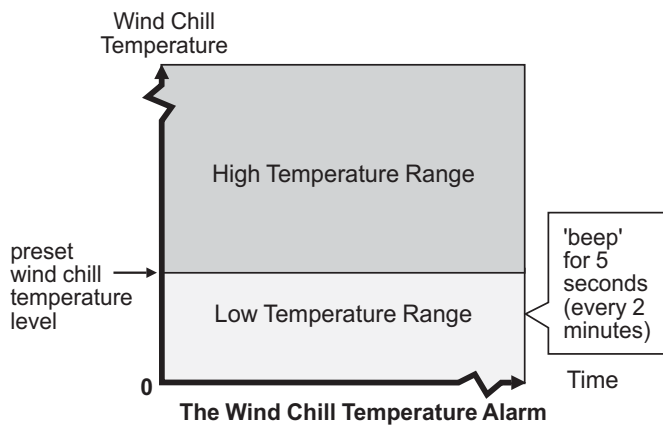

### Wind Chill Temperature Alarm

- The ADC is equipped with a wind chill temperature alarm.
- That alarm alerts user when the current wind chill temperature is equal to or lower than the preset wind chill temperature level.

### Wind Chill Temperature Alarm Sound

- In Temperature Mode: When the Current Wind Chill Temperature is equal to or lower than the preset wind chill temperature level, the ADC starts beeping for about 5 seconds.
- After the first beeping, the ADC will beep again for every 2 minutes if the current wind chill temperature holds at or below the preset value.
- The above repeated alarm will stop unless the wind chill temperature equals or drops below the preset value or the wind chill temperature alarm is set to OFF.



## 12.7 Temperature Mode - Calibrating the Temperature

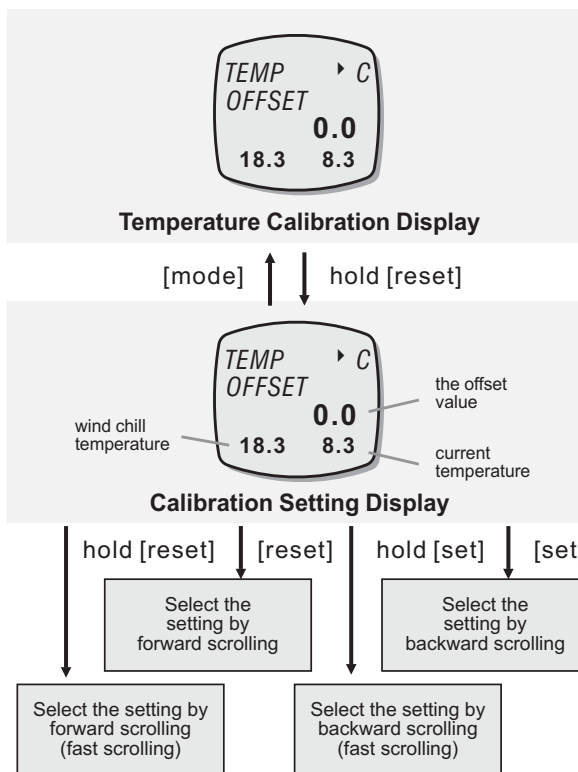

### To Select Setting Display

- Following the previous 'Setting the Wind Chill Temperature Alarm' section to select the Calibration Display.
- In the Calibration Display, press and hold the [reset] button for 2 seconds to select the Calibration Setting Display.

### The Setting Sequence

- When the 'offset value' digits are flashing, press the [set] or [reset] buttons scroll through to select target offset value (hold down the button to scroll the setting at a faster pace).
- When the above settings finished, press the [mode] button once to exit the setting sequence.

### Note:

1) When the temperature has been calibrated, the ADC will offset the current temperature by the target offset value. For example: If the offset value is +2 and the current temperature is 26 degrees C, the ADC will display 28 degrees C (26+2).

2) The current wind chill temperature will be updated as above accordingly.

## 13.0 Barometer Mode - Barometer Mode Function

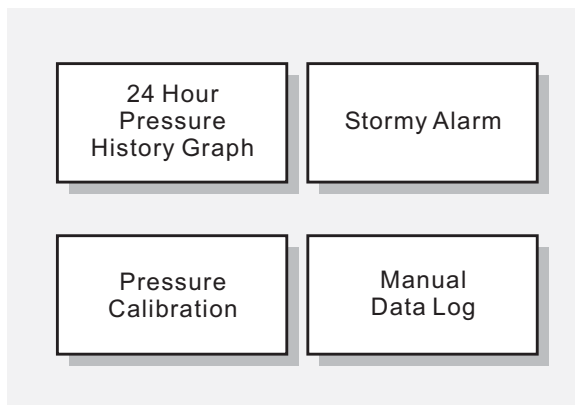

**Barometer Mode Functions**

### Barometer Mode Functions

- The ADC has the following barometric pressure functions:
  - 1) The 24-Hour Pressure History Graph: The Barometric Pressure Memory for the last 24 hours.
  - 2) Storm Alarm: The alarm that alerts the user when the upcoming weather is stormy. Check the coming 'Storm Alarm' section for more detail on the Storm Alarm.
  - 3) Calibration: The process to calibrate the Barometric Pressure reading.
  - 4) Manual Data Log: The function to log the sensor functional mode readings that are currently obtained from sensors.

## 13.1 Barometer Mode - Barometer Display

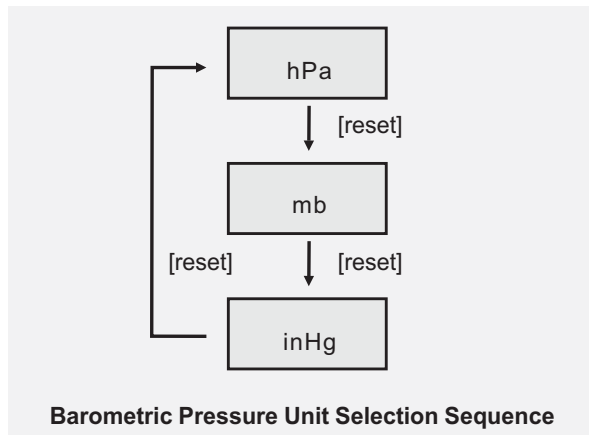
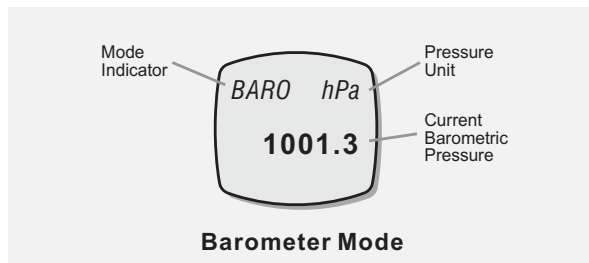

### Barometer Display

- In Barometer Mode, the display will show the following:
  - 1) The mode indicator 'BARO' Indicator and the barometric pressure unit appear on the 1st row of the display.
  - 2) The ambient Barometric Pressure appears on the 3rd row of the display.

### To Change Barometric Pressure Unit

- The ADC can display Barometric Pressure in the following units:
  - 1) Hecto-Pascal (hPa)
  - 2) milli-bar (mb)
  - 3) Inches of mercury (inHg)
- In Barometer Mode, press the [reset] button to change the barometric pressure unit following the adjacent diagram.

## 13.2 Barometer Mode - Pressure History Graph for the Last 24 Hours

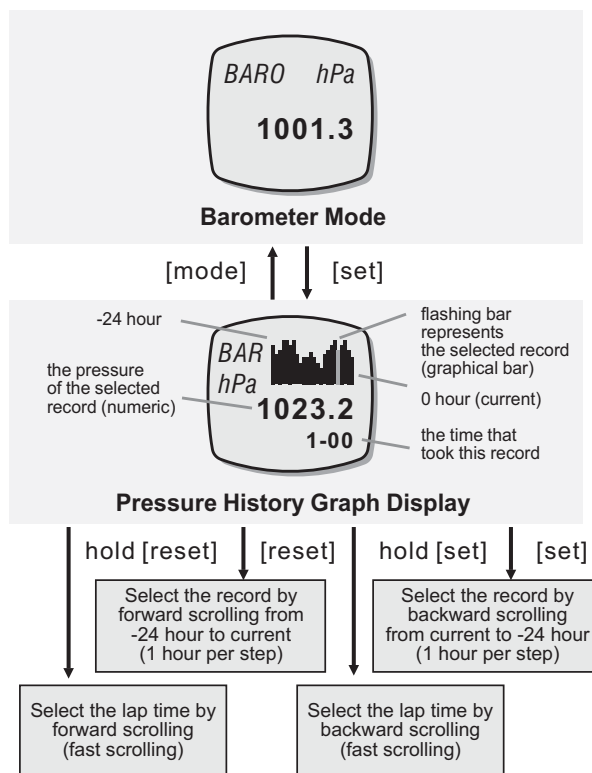

### Pressure History Graph

- The ADC is equipped with a barometric pressure memory function. It records the last 24 hours barometric pressure readings, and it can display them by bar-graph.
- In Barometer Mode, press the [set] button to select the Pressure History Graph Display.
- While in the Temperature History Graph Display, the right most bar will start flashing.
- The right most bar represents the current temperature (0 hour), while the other bars represent the pressure records of the last 24 hours. Each pressure record is taken at the hour (i.e 12:00, 1:00 and 2:00 ... ).
- To browse the pressure record at different times, press the [set] button to scroll the record backward (from the current record to the -24 hour record) or press the [reset] button to scroll the record forward (from the -24 hour record to the current record).
- Press the [mode] button once to exit the Pressure History Graph Display.

### 13.3 Barometer Mode - About Storm Alarm

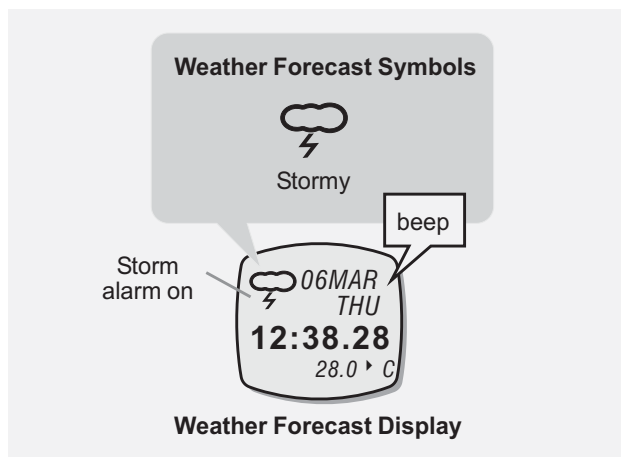

#### About Stormy Alarm

- The alarm gives beep alert when the ADC predicts the upcoming weather as stormy.
- Then, in the Current time - Weather Forecast Display, the 'stormy' weather forecast symbol will appear.

#### Storm Alarm Sound

- If the 'stormy' weather forecast symbol appears, the ADC starts beeping for about 30 seconds.
- The ADC will NOT beep again unless another 'stormy' condition is predicted.



## 13.4 Barometer Mode - Setting the Storm Alarm

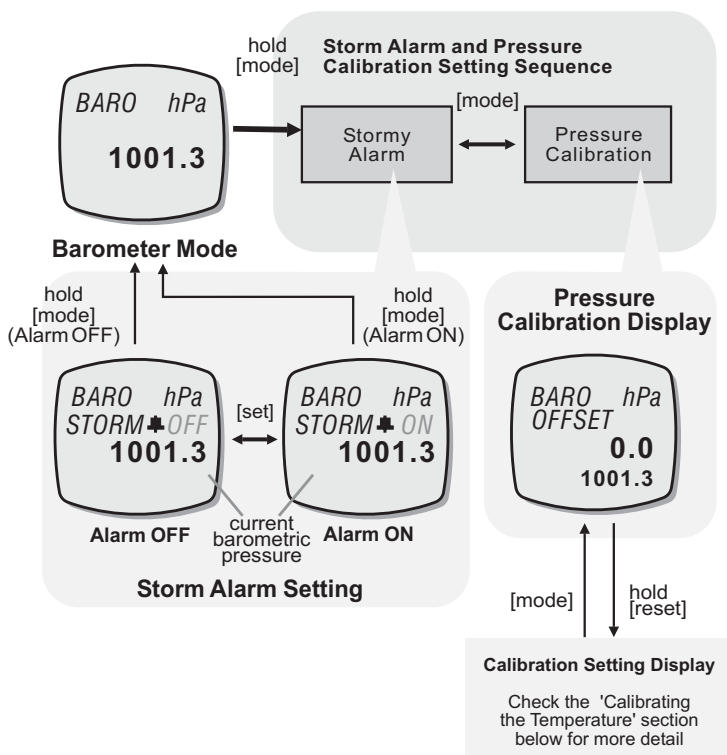

### Select the Setting Display

- Press and hold the [mode] button for about 2 second to select the setting display (the 'ON' or 'OFF' will start flashing).

### Setting Sequence

- In the setting display, press the [mode] button to move the setting following the adjacent diagram.
- When the 'ON' or 'OFF' starts to flash, press the [set] button to select the Stormy Alarm between ON and OFF.
- When the above settings finished, press and hold the [mode] button for about 2 seconds to exit the setting sequence.

## 13.5 Barometer Mode - Calibrating the Barometric Pressure

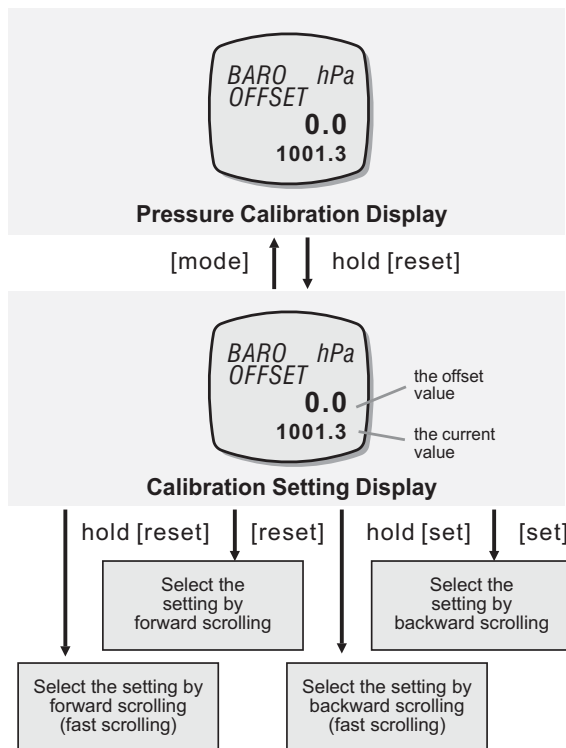

### To Calibrate the Barometric Pressure

- Following the previous 'Setting the Storm Alarm' section to select the Calibration Display.
- In the Calibration Display, press and hold the [reset] button for 2 seconds to select the Calibration Setting Display.
- When the 'offset value' digits are flashing, press the [set] or [reset] button to scroll to select the target offset value (hold down the button to scroll the setting at a faster pace).
- When the above settings finished, press the [mode] button once to exit the setting sequence.

### Setting Pressure relative to Sea Level

1) When the barometric pressure has been calibrated, the current barometric pressure will be offset by the target offset value.

2) To be able to read the current barometric pressure as a pressure referring to sea-level although at an altitude, calibrate as follows:

Check the current altitude (for example 1000m). Divide 1000/8 (since 1 hPa/mbar is 8m altitude). Result 125 hPa/mbar. Set offset to +125hPa/mbar. The reading will now refer to the pressure at sea-level.

## 14.0 Altimeter Mode - Altimeter Mode Functions

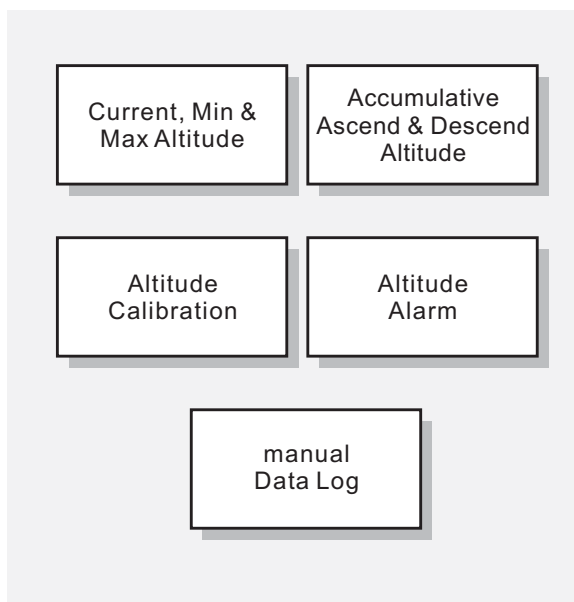

**Altimeter Mode Functions**

### Altimeter Mode Functions

- This mode has the following functions:
  - 1) The different altitude readings: Current, Minimum and Maximum Altitude.
  - 2) The Accumulative Ascend and Descent Altitude: The sums of the ascending/descending distance for ski sport.
  - 3) The Altitude Alarm: Alarm sounds when the current altitude is higher than the predefined level.
  - 4) Altitude Calibration: The process to calibrate the altitude reading.
  - 5) Manual Data Log: The function to log the current sensor readings.

### WARNING !

- The ADC estimates altitude by air pressure. Hence, these altitude values may be changed if air pressure changes. **DO NOT** rely on the ADC for those activities that demands commercial standard.

## 14.1 Altitude Mode - Functional Displays

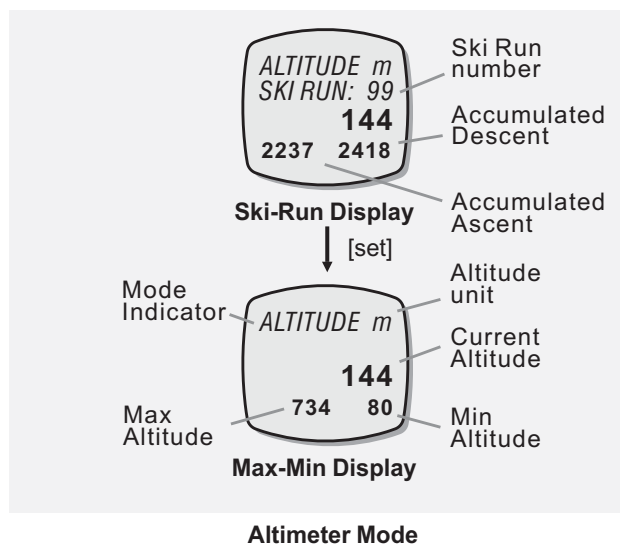

### Functional Displays

- Altimeter Mode includes three different functional displays, they are the Ski-Run Display, Max-Min Display and Air-Density Display.
- In Altimeter Mode, press the [set] button to select between the above displays following the adjacent diagram.
- In the above displays, the indicator 'ALTITUDE' and altitude unit appear on the 1st row of the display, and the current altitude appears on the 3rd row of the display.

### Altitude Ski-Run Display

- In this display, the number of Ski Runs appears on the 2nd row of the display, and the accumulated ascent and descent appear on the 4th row of the display.

### Altitude Max-Min Display

- In this display, the maximum and minimum altitude appears on the 4th row of the display.

## 14.2 Altimeter Mode - To Change Altitude Units

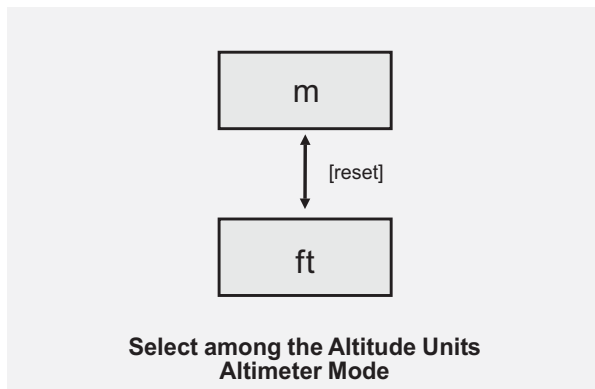

### To Change Altitude Units

- The ADC can display altitude in the following units:
  - 1) Meter (m)
  - 2) Feet (ft).
- In any of the functional displays (Ski-Run, Max-Min and Air-Density Display), press the [reset] button to select the altitude unit following the adjacent diagram.

### 14.3.0 Altimeter Mode - Altitude Ski-Run Display

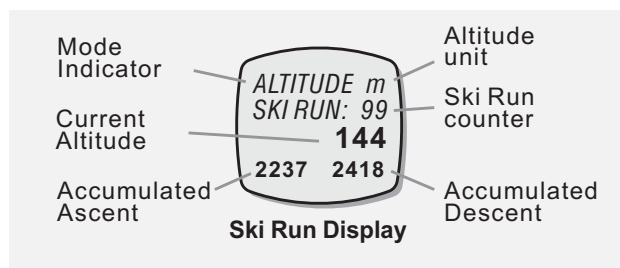

Altimeter Mode

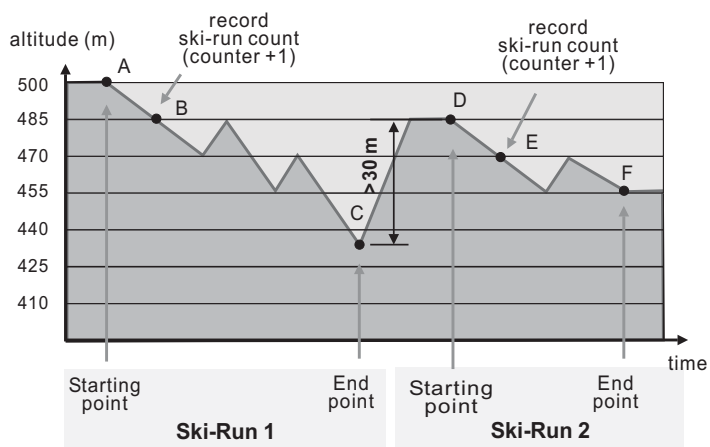

#### Ski-Run Display

- The ADC is equipped with functions to register ski runs. They are the Ski-Run Counter, Accumulative Ascending Altitude and Accumulative Descending Altitude.
- The Ski Run Counter registers the number of ski runs.
- The Accumulative Ascending Altitude and Accumulative Descending Altitude registers the total ascend or descend altitude during the ski runs.
- When the Ski-Run functions is ON:
  - 1) The ADC will record a Ski-Run count (Counter +1) automatically when a ski run has descended 15 meters (point A to B or point D to E).
  - 3) The ADC will record a new ski-run record (Counter +1) once a 30 meters ascend (point C to D) is completed before another ski-run record is allowed to be registered.
- Check the 'To Turn the Ski-Run Function ON and OFF' section below for more detail on how to set the function ON and OFF.

### 14.3.1 Altimeter Mode - To Turn Ski-Run Function ON and OFF

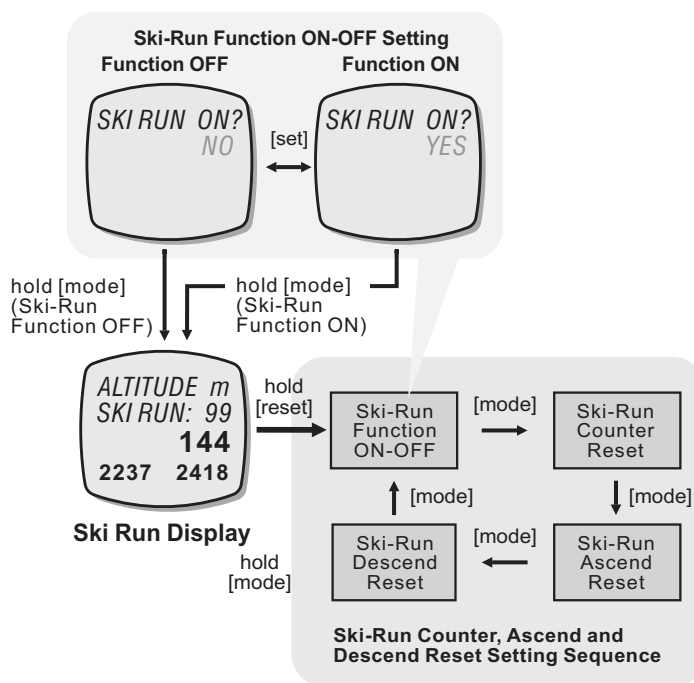

#### To Turn Ski-Run Function ON and OFF

- To select the setting display, press and hold the [reset] button for about 2 seconds (the 'YES' or 'NO' will start flashing).
- In setting display, press the [mode] button to select between the Ski-Run Function ON-OFF Setting and the Ski-Run Reset Settings following the adjacent diagram. Check the 'To Reset the Ski-Run Counter, Ascend & Descend' section below for more detail on reset setting.
- When the Ski-Run Function ON-OFF Setting 'YES' or 'NO' is flashing, press the [set] button to select between the Ski-Run Function ON and OFF.
- When the 'YES' Display is flashing, press and hold the [mode] button for about 2 seconds to confirm the setting and exit the setting sequence (Ski-Run Function will turn ON).
- When the 'NO' Display is flashing, press and hold the [mode] button for about 2 seconds to abort the setting and exit the setting sequence.

### 14.3.2 Altimeter Mode - To Reset the Ski-Run Counter, Ascend & Descend

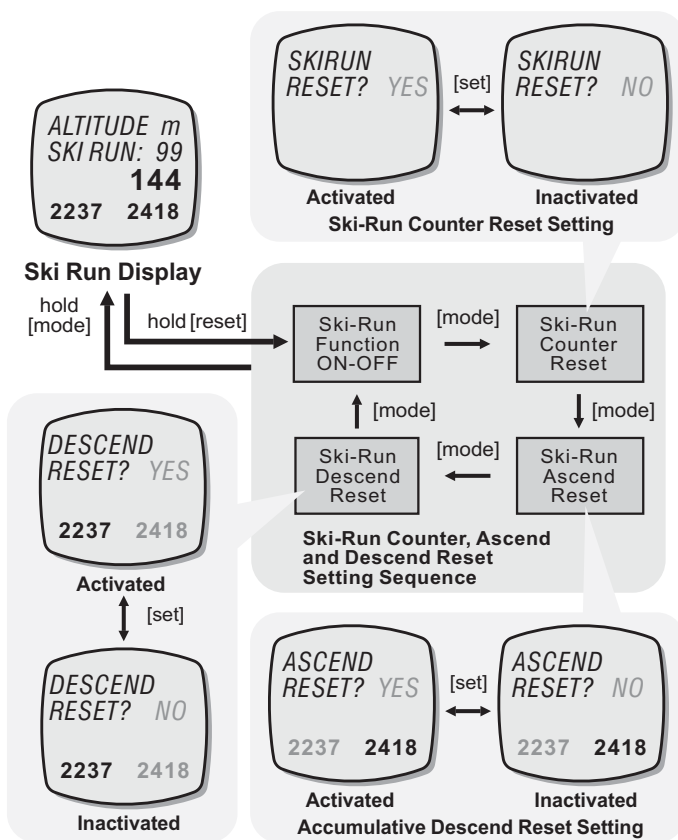

#### To Reset Ski-Run Counter, Ascending and Descending Altitude.

- Following the previous 'To Turn Ski-Run Function ON and OFF' section to enter the Ski-Run Reset Setting.
- Press the [mode] button to select between the Ski-Run Function ON-OFF Setting and the Ski-Run Reset Settings following the adjacent diagram.
- When one of the 'YES' Displays is flashing, press and hold the [mode] button for about 2 seconds to confirm the reset and exit the setting sequence (the respective Ski-Run reading will be reset to zero).
- When one of the 'NO' Displays is flashing, press and hold the [mode] button for about 2 seconds to abort the reset and exit the setting sequence.
- **IMPORTANT**  
Accumulative ascend and descend will only work when Ski-Run function is activated (ON)





## 14.4.1 Altimeter Mode - To Reset Minimum and Maximum Altitude

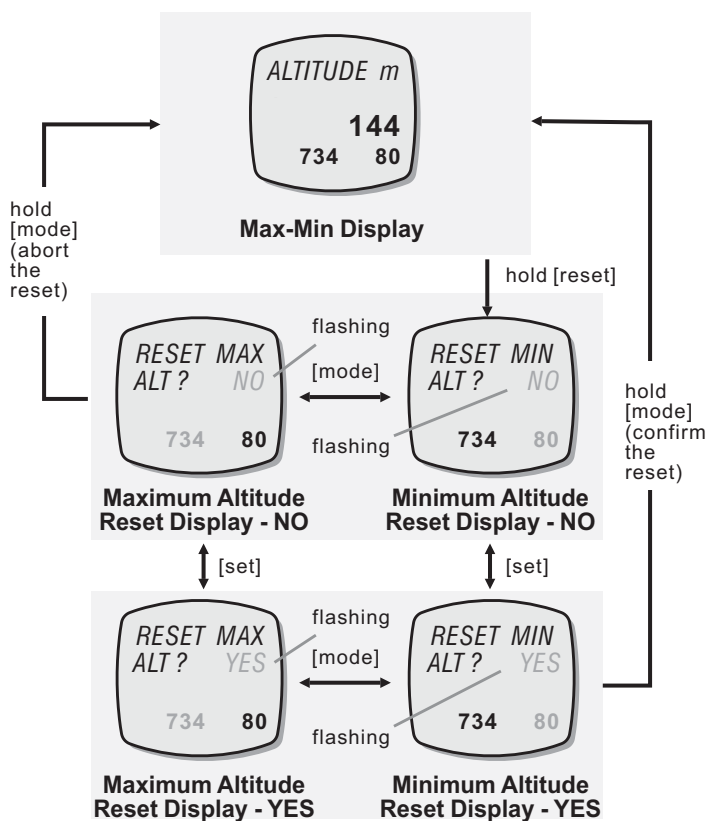

### To Reset the Maximum and Minimum Altitude

- To reset the maximum and minimum altitude, press and hold the **[reset]** button for about 2 seconds to select the Reset Display.
- When the Minimum Altitude Reset Display is displaying, press the **[mode]** button to select between the Maximum and Minimum Altitude Reset Display.
- When the 'NO' or 'YES' Display is displaying, press the **[set]** button to select between the 'YES' and 'NO' Display.
- When the 'YES' Display is displaying, press and hold the **[mode]** button for about 2 seconds to confirm the reset of the respective altitude (i.e. the maximum or minimum altitude), the maximum or minimum altitude will be reset to zero.
- To abort the reset, press and hold the **[mode]** button for 2 seconds in the 'NO' Display.

## 14.5 Altimeter Mode - Altitude Alarm

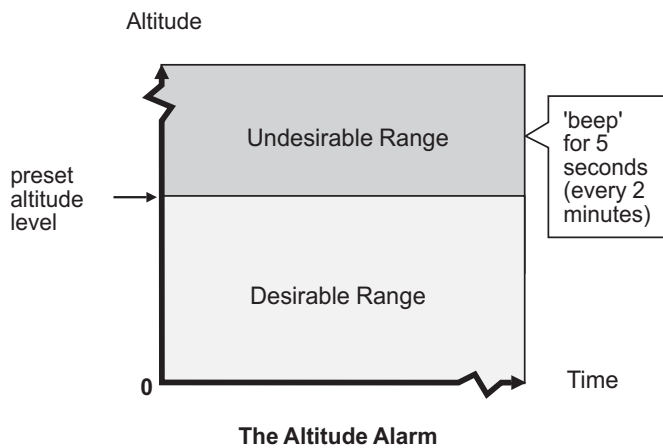

### Altitude Alarm

- The ADC is equipped with an altitude alarm.
- That alarm alerts user when the current altitude is equal to or higher than the preset altitude level.
- Check the 'Setting the Altimeter Mode' section below for more detail on how to set the altitude level for the alarm.

### Altitude Alarm Sound

- In Altitude Mode: When the current altitude is equal to or higher than the preset altitude level, the ADC starts beeping for about 5 seconds.
- After the first beeping, the ADC will beep again for every 2 minutes if the current is still equal or higher than the preset value.
- The repeated alarm beeps will stop until the altitude is equal or higher than the preset value or the Altitude Alarm is set to OFF.

## 14.6.0 Altimeter Mode - Altitude Mode Setting

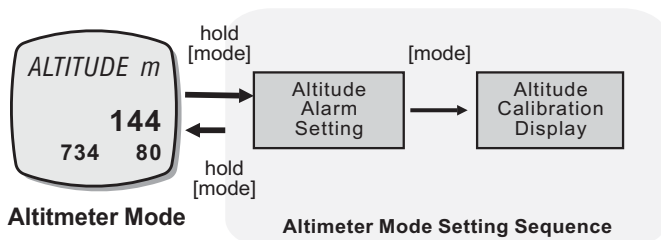

### Altimeter Mode Setting

- The following functions can be performed in the Altimeter Setting Mode.
  - 1) Altitude Alarm Settings,
    - a) ON or OFF
    - b) Target Altitude Level for alarm
  - 2) Altitude Calibration

### To Select the Setting Display

- To select the setting display, press and hold the [mode] button for about 2 seconds (altitude digits will start flashing).
- In the setting display, press the [mode] button to select between the Altitude Alarm Setting and Altitude Calibration Display.
- Check the 'Altitude Alarm Setting' and 'Altitude Calibration' sections below for more detail on the above settings.

## 14.6.1 Altimeter Mode - Setting the Altitude Alarm

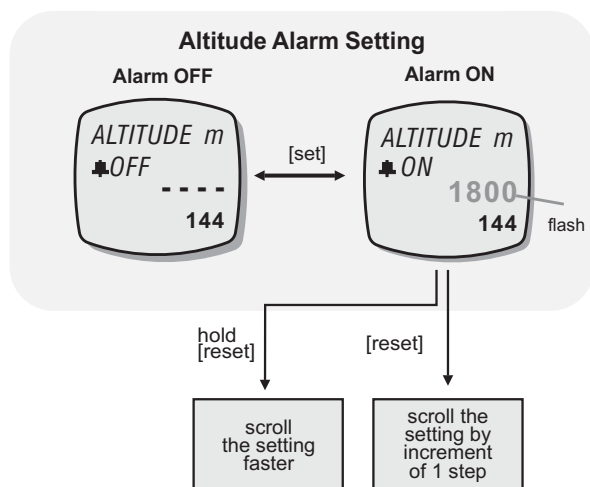

### To Set the Altitude Alarm

- Following the previous 'Altimeter Mode Setting Sequence' to select the Altitude Alarm Setting Display.
- When the altitude alarm digits are flashing, press the [reset] button to scroll by 1 to select target altitude level (hold down the button to scroll the setting faster), or press the [set] button to select the between altitude alarm ON and OFF.
- When the above settings finished, press and hold the [mode] button for about 2 seconds to exit the setting sequence or press the [mode] button to set the other settings.

## 14.6.2 Altimeter Mode - Calibrating the Altitude

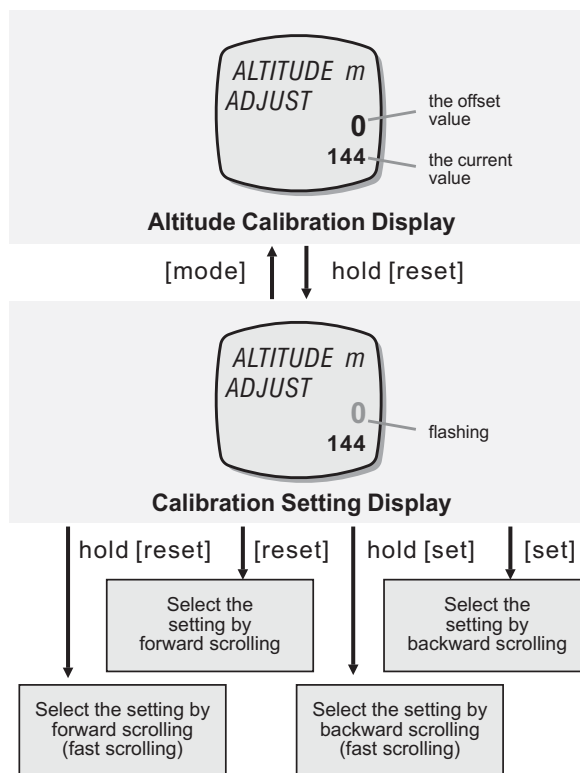

### To Calibrate the Altitude

- Following the previous 'Altimeter Mode Setting Sequence' enter the Calibration Display. When the Calibration Display appears, press and hold the [reset] button for about 2 seconds to select the Calibration Setting Display.
- When the 'offset value' digits are flashing, press the [set] or [reset] button to scroll by 1 to select the target offset value (hold down the button to scroll the setting faster).
- When the above settings finished, press the [mode] button once to exit the calibration setting sequence. To return to Altimeter Mode, press and hold the [mode] button for about 2 seconds to exit the setting sequence or press the [mode] button to set the other settings.
- **Note:**
  - 1) When the altitude has been calibrated, the ADC will offset the current altitude by the target offset value. For example: If the offset value is +20 and the current altitude is 144 the ADC will display 164 (144+20).
  - 2) The maximum and minimum altitude will NOT be updated as the above.

## 15.0 Data Log Mode - Data Log Function

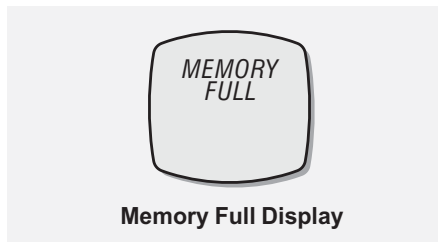
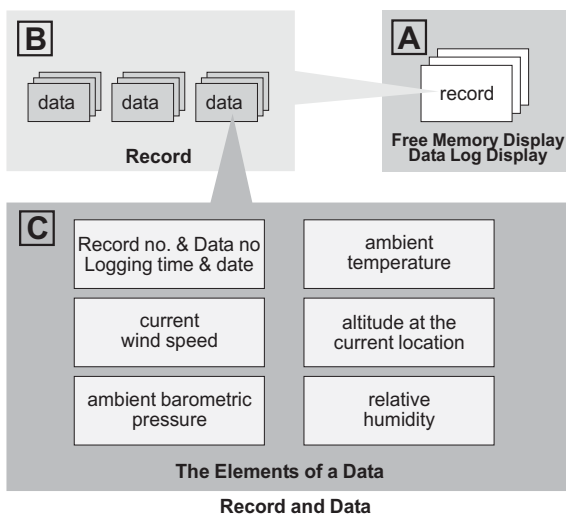

### Data Log Function

- The ADC is equipped with a function to log the sensor functional mode data. These data are the current wind speed, ambient temperature, barometric pressure, relative humidity and the altitude at the current location.
- This data also includes the time and date that the logging was taken.
- The ADC can log data automatically (log a data at a preset interval) or manually.
- For logging data automatically, check the 'Automatic Data Log' section below. For logging data manually, check the previous 'Manual Data Log'.

### Note:

- 1) The log memory can log up to 256 records and 1980 data.
- 2) If log memory is full, a 'MEMORY FULL' message will display for few seconds. Delete some data, or transfer the data to PC if necessary.
- 3) Always check the memory level before data logging.

## 15.1 Data Log Mode - Data Log Display and Free Memory Display

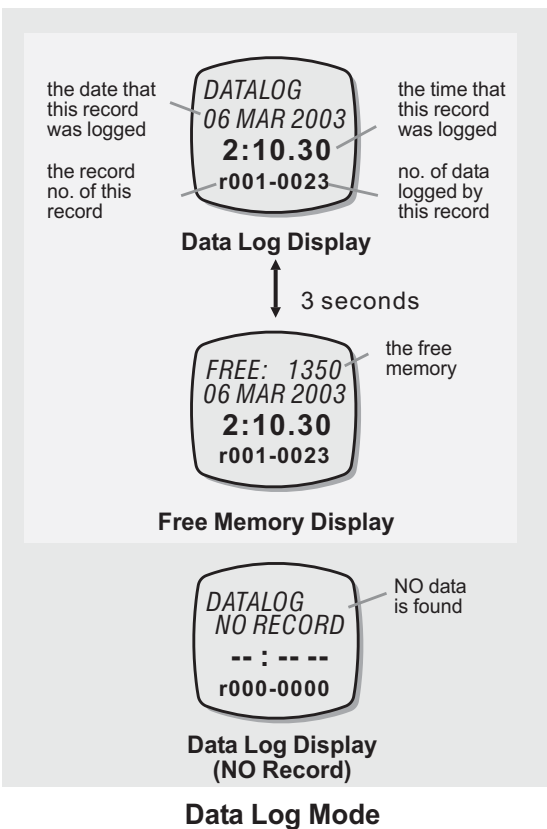

### Functional Displays

- Data Log Mode includes two different functional displays; they are the Free Memory Display and Data Log Display.
- Free Memory Display and Data Log Display will be appeared alternatively for every 3 seconds.
- In the above displays, the date of which the record was logged appears on the 2nd row of the display. The time of which the record was logged appears on the 3rd row of the display. The data number and record number appear on the 4th row of the display.
- If NO data is found on the Data Log Mode, the 'NO RECORD' display appears.

### The Data Log Display

- The mode indicator '*DATALOG*' appears on the 1st row of the display.

### The Free Memory Display

- The free memory appears on the 1st row of the display.
-



## 15.2 Data Log Mode - Automatic Data Log

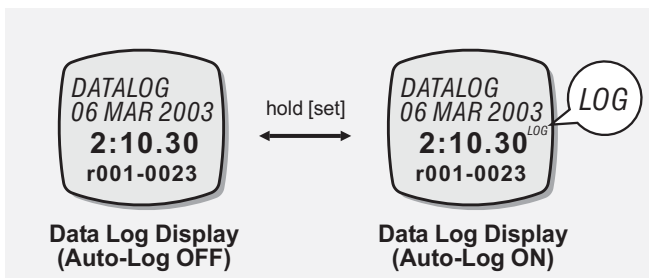

### To Log Data Automatically (Auto-Log)

- Press and hold the [set] button for about 2 seconds in the Data Log Mode to enable or disable the automatic log function.
- When the function is enabled, a 'LOG' indicator appears, the ADC will log a data at the predefined interval.
- Check the 'Setting the Data Log Mode' section below for more detail on how to set the interval..

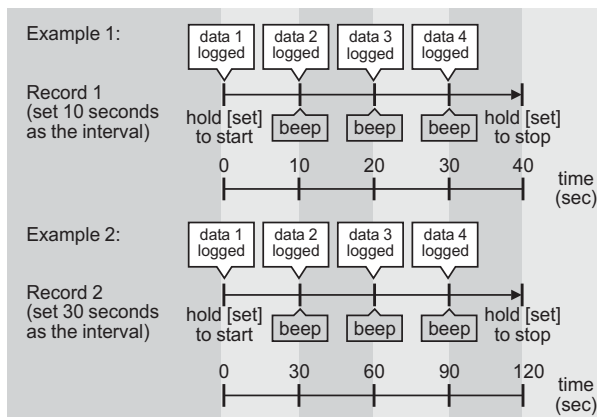

Automatic Data Log

## 15.3 Data Log Mode - Data and Record Administration

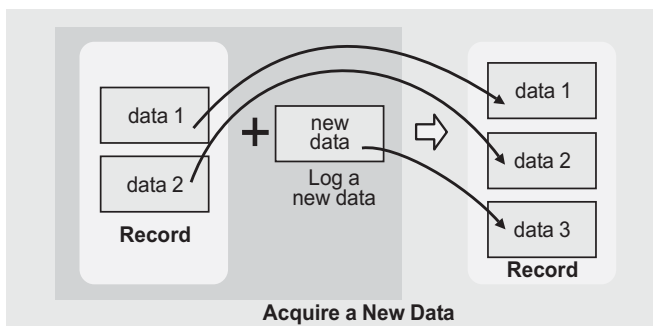

### Log a New Data

- When a new data is logged, this data will become the last one of the data list.

### Delete a Existing Record

- If the displaying record is erased, the record will shift it's location onward following the adjacent diagram.

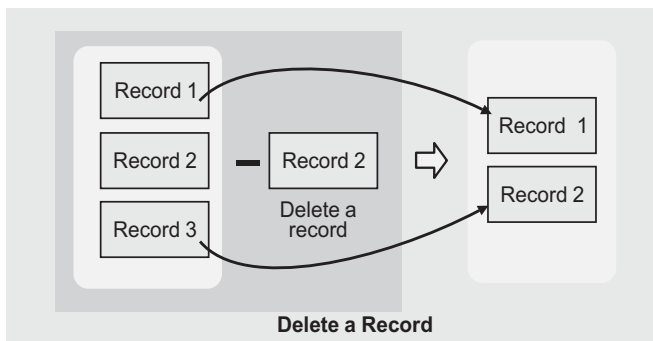

## 15.4.0 Data Log Mode - Data Log Mode Setting

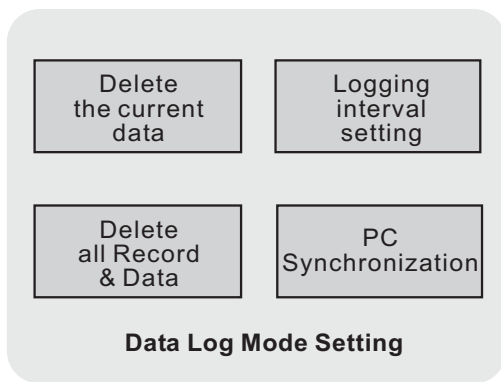

### Data Log Mode Setting

- The following functions can be performed in the Data Log Mode Setting.
  - 1) Delete the current data
  - 2) Set the logging interval for auto log
  - 3) Enable the PC Synchronization (transfer data from the ADC to PC)
  - 4) Delete all data
- Check the 'PC Synchronization' section below for more detail on the communication between the ADC and PC.

## 15.4.1 Data Log Mode - Setting Data Log Mode

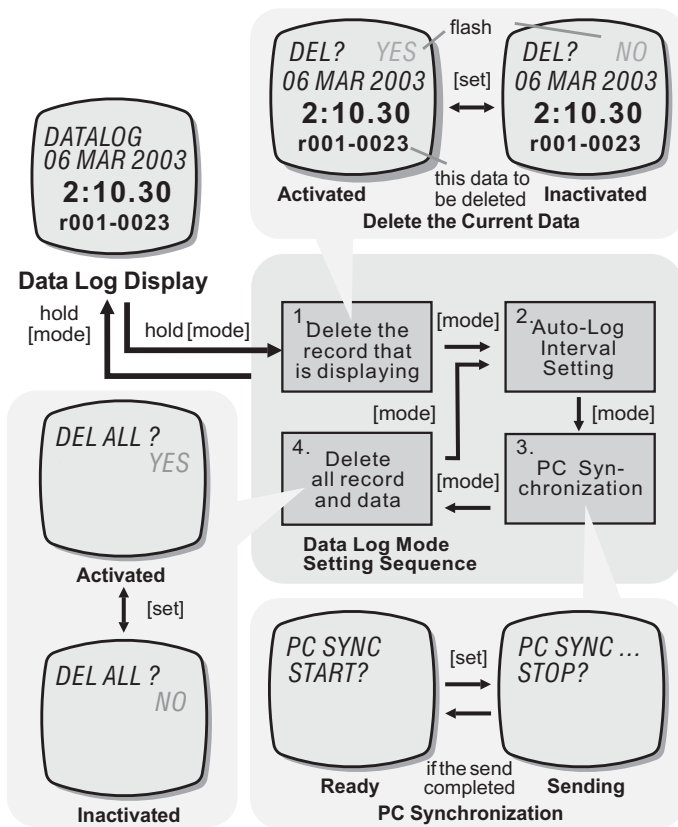

### To Select Setting Display

- Press and hold the [mode] button for about 2 seconds to select the Data Log Mode Setting Display (the 'NO' starts flashing).
- In setting display, press the [mode] button to select among the settings following the adjacent diagram.
  - 1: When the 'NO' starts to flash, press the [set] button to select between 'YES' (delete the record that is displaying) and 'NO' Display.
  - 2: When the interval digits starts to flash, press the [set] or [reset] button to scroll to select the target auto-log interval (hold down the button to scroll the setting at a faster pace).
  - 3: When the 'PC SYNC START?' starts to flash, press [set] button to send the data from the ADC to PC.
  - 4: When the 'NO' starts to flash, press the [set] button to select between 'YES' (delete all records) and 'NO' Display.
- When the above setting completed, press and hold the [mode] button for about 2 seconds to confirm the setting and exit the setting sequence.

## 15.5 Data Log Mode - PC Synchronization

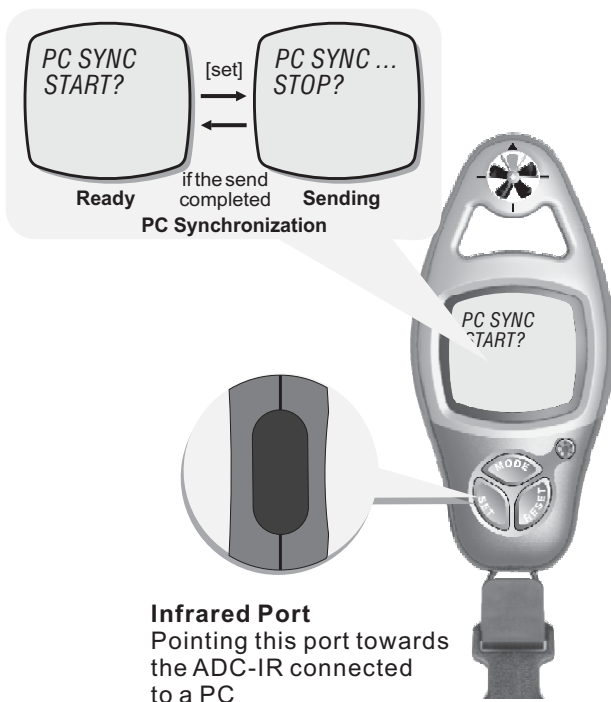

### Transfer Data from the ADC to PC

- The ADC is equipped with a function to transfer/backup the data from the ADC to PC.
- To be able to transfer data to a PC, the accessory ADC-IR (optional extra) is needed.
- Following the previous 'Data Log Mode Setting Sequence' to select the PC Synchronization Display.
- In the above PC Synchronization Display, press the [set] button once to activate the synchronization. The data of the ADC will send to the target PC.

### Note:

- Start the PC's communication software prior to the transmission.
- Check the PC's hardware and software manual for the detail on how to transfer and receive data via infrared device.
- Make sure that the infrared port (of the ADC) is pointing towards the target ADC IR infrared port during the transmission.

## 15.6.0 Data Log Mode - Logged Record and Data

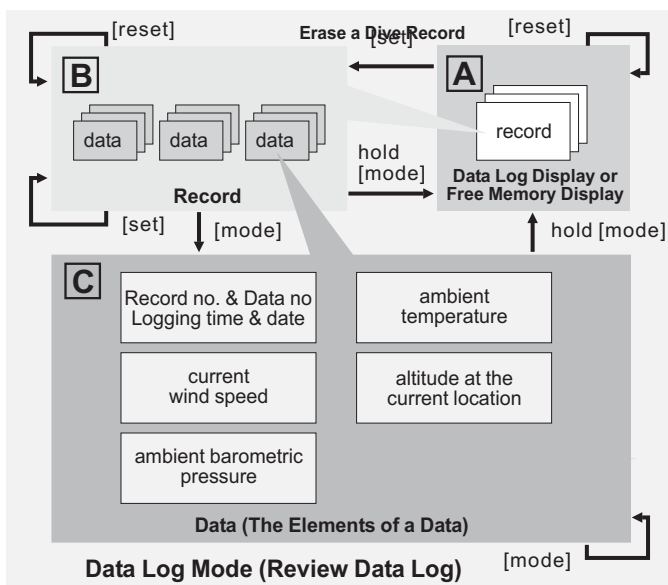

### To review Logged Data

- The adjacent diagram shows the operations for employing a review on the logged data.
- Check the 'To Select the Logged Record' and 'To Review the Logged Data' sections below for more detail on how to review logged data.

## 15.6.1 Data Log Mode - To Select the Logged Record

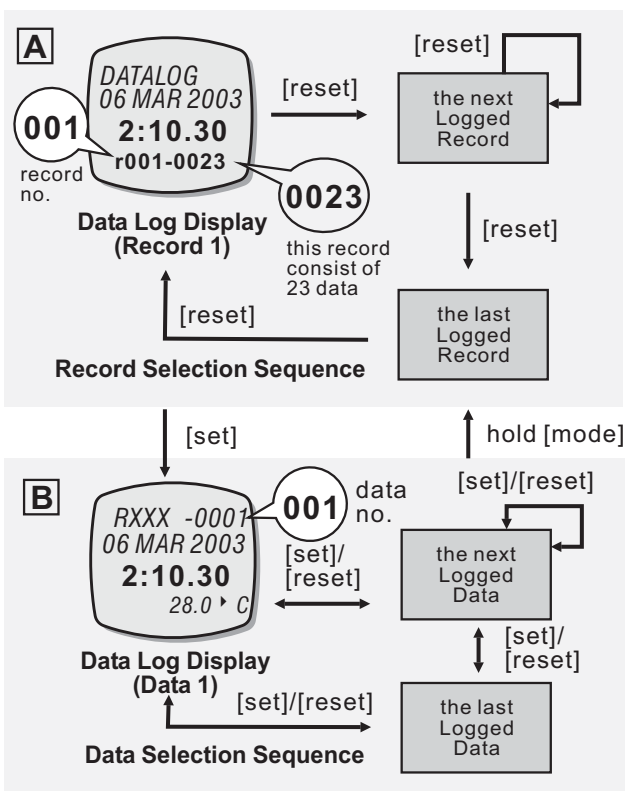

### To Select the Logged Record

- Press the [reset] button to scroll forward to select the target record (the logging time and date) among the logged records (from record 1 to the last record) following the adjacent diagram.
- If a record is selected, the logging date and time appear on the 2nd and 3rd row of the display. The record number and the total number of data (stored by such record) appear on the 4th row of the display.
- When the target record is displaying, press the [set] to enter the Data Selection Sequence. Check the 'To Review among Logged Data' section below for more detail on how to select target data.

## 15.6.2 Data Log Mode - To Review the Logged Data

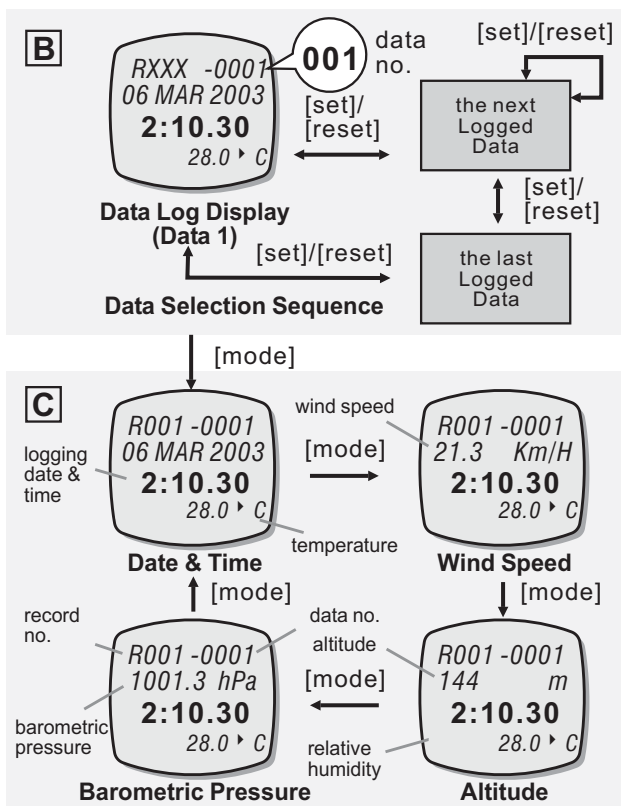

### To Review the Logged Data

- Following the previous 'To Select the Logged Record' section to select the target record.

Once a record is selected:

- Press the [reset] button to scroll forward to select the target data among the logged data (from data 1 to the last data) following the adjacent diagram.
- Or press the [set] button to scroll backward to select the target data among the logged data (from last data to data 1) following the adjacent diagram.
- If a data is selected, the record number and data number appear on the 1st row of the display. The logging date and time (the time such data was logged) appear on the 2nd and 3rd row of the display. The temperature and relative humidity appear on the 4th row of the display.
- To review the other information of the selected data, press the [mode] button following the adjacent diagram. The wind speed, temperature, barometric pressure, and the altitude at the current location will appear one by one.



## 16.0 Specifications A

### Current Time Mode

- Hour, minute and second
- Month, day, day of week and year
- 12 / 24 hour format selectable
- Auto calendar from year 2003 to 2099

### Wind Speed Mode

- Current, Average and Maximum Wind Speed
- Beaufort Scale for Average Wind Speed
- 5 Wind Speed Unit Selection (Km/h, mph, feet/s, m/s, and Knots).
- User defined time span for Average Wind Speed calculation.
- User defined Wind Speed Alarm.

### Temperature Mode

- Current Temperature, and Current and Minimum Wind Chill Temperatures.
- User defined Wind Chill Temperature Alarm.
- Graphical and numerical displays for temperature for the last 24 hour

### Barometer Mode

- Current Barometric pressure
- Storm Alarm
- User defined offset for Calibration
- Graphical and numerical displays for barometric pressure for the last 24 hours

### Altitude Mode

- Current, Average and Maximum Altitude
- Air Density and Relative Air Density
- Density Altitude
- Altitude Alarm
- User defined offset for Calibration
- Ski Run Counter, Ascending and Descending Distance.

## 16.1 Specifications - B

### Data Log Mode

- Log data includes logging time and date, wind speed, barometric pressure, altitude and temperature.
- Manual and Automatic Data Log
- User define logging interval for automatic data log
- Data transfer from the ADC to PC via the infrared synchronization, ADC-IR unit is required.

### Daily Alarm Mode

- Daily Alarm: 1 daily alarm
- Alarm Duration: about 30 seconds

### Chronograph Mode

- Resolution: 1/100 second
- Counting range: 99 hours, 59 minutes, 59.99 seconds
- Measurement: Elapsed time, accumulative elapsed time and lap time.
- Lap memory: 50 laps

### Race Timer Mode

- Resolution: 1 second
- Setting limit: 99 hours, 59 minutes, 59 seconds
- Alarm sound:
  - Last 10 minutes: beep once for every minute.
  - Last 10 seconds: beep once for every second.
  - 0 second: beeps for about 2 seconds.

### Others

- Electro-luminescent back-light turns on for 3 seconds when activated.

## 16.2 Accuracy, resolution and units

### Wind Speed

Up to 3.0 m/s, better than +/-10%

Over 3.0 m/s, better than +/-5%

Resolution: 0.1 m/s

Units: m/s, km/h, mph, knots, ft/s

### Temperature

Better than +/-1 Celsius degree (offset calibration possible)

Resolution: 0.1 degree

Units: Celsius, Fahrenheit

### Barometer

Better than +/-1.5mb (700 ~ 1100 mb) (offset calibration possible)

Resolution: 0.1 hPa

Units: hPa, mbar, inHg

### Altimeter

Better than +/- 3 meter provided properly calibrated.

Resolution: 1 meter

Units: meter, feet

### Time

Better than +/- 1 sec/day

### Weather Forecast

5 weather forecast symbols that predict the coming 12-hour weather.

## 17 Warranty

### Brunton Two Year Warranty

Brunton warrants this product to be free of defects in materials and workmanship for a period of two years. This warranty extends to the original purchaser from the date of purchase. This warranty is void and a charge for repair will be made if the ADC has been damaged by negligence, accident or mishandling, or has not been operated in accordance with standard operating procedures, or if the ADC was altered or repaired by anyone other than a Brunton repair facility. This warranty gives you specific legal rights, and you also have rights, which vary from state to state. No other warranty, expressed or implied, applies to the Brunton product, nor is any person or company authorized to assume any other warranty for Brunton. Brunton does not assume any responsibility for any consequential damages occasioned by this product. Should the product prove defective, contact Brunton, and you will be provided with a Return Authorization Number (RA#). Send a copy of your proof of purchase, the RA#, a short description of the problem and the product to Brunton at the following address. Brunton suggests insuring the product in case of damage or loss in shipment.

#### Brunton

Warranty Repair (307) 857-4700  
2255 Brunton Court support@brunton.com  
Riverton, WY 82501 www.brunton.com

### To register this product:

Print this form, fill out, and Send to Brunton at:

BRUNTON  
WARRANTY  
2255 Brunton Court  
Riverton, WY 82501

-----  
Name: \_\_\_\_\_  
Address: \_\_\_\_\_  
City: \_\_\_\_\_ State: \_\_\_\_\_ Zip: \_\_\_\_\_  
Phone: \_\_\_\_\_ Email: \_\_\_\_\_  
Date Purchased: \_\_\_\_\_  
Amount Paid: \_\_\_\_\_

Would you like to receive a Brunton Catalog? ( ) Yes ( ) No

Please let us know where you purchased your ADC

Store Name: \_\_\_\_\_  
City: \_\_\_\_\_ State: \_\_\_\_\_ Zip: \_\_\_\_\_  
( ) Online site \_\_\_\_\_ ( ) Catalog \_\_\_\_\_  
( ) Gift \_\_\_\_\_ ( ) Brunton \_\_\_\_\_  
( ) Other \_\_\_\_\_

Do you own another Brunton Product?

( ) Yes. Product: \_\_\_\_\_ ( ) No.

I purchased this Brunton ADC primarily for...

( ) Professional Use ( ) It was a gift ( ) It looked cool  
( ) Recreational Use ( ) Other \_\_\_\_\_

---

***BRUNTON***

**ADC°SUMMIT**

---