

Repair

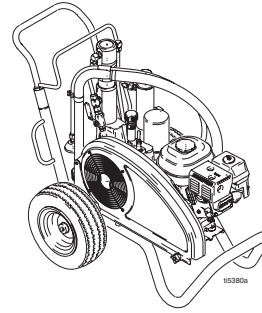

GH™ 200, GH 230, GH 300; Series A & B EH™ 200, Series A Hydraulic Sprayers



Korean Patent:10-0647761

310778N







- Use with Architectural Coatings and Paints -

3300 psi (2.8 MPa, 228 bar) Maximum Working Pressure

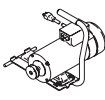
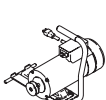
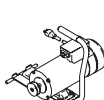

Important Safety Instructions

Read all warnings and instructions in this manual.
Save these instructions.







		 GH200	 GH230	 GH300	 120 Vac 60 Hz	 CSA/UL 120 Vac 60 Hz	 240 Vac 50 Hz	
248559	✓	✓						
248560	✓	✓						✓
248565	✓	✓			✓			
248566	✓	✓				✓		
248949					✓			
248950						✓		
248943		✓						
248944			✓					
248561	✓		✓					
248562	✓		✓					✓
248563	✓			✓				
248564	✓			✓				✓
248567	✓						✓	
248945				✓				
248946							✓	

PROVEN QUALITY. LEADING TECHNOLOGY.









Table of Contents

WARNING	3	Displacement Pump	15
General Repair Information	5	Parts	16
Maintenance	6	GH 200 Sprayers with Spray Gun and Hoses ...	22
Troubleshooting	7	GH 230 Sprayers with Spray Gun and Hoses ...	22
Hydraulic Pump	8	GH 300 Sprayers with Spray Gun and Hoses ...	23
Fan Belt	10	Technical Data	25
Engine	11	Graco Standard Warranty	26
Hydraulic Motor Rebuild	12		
Hydraulic Oil/Filter Change	14		

The following Warnings are for the safe setup, use, grounding, maintenance and repair of this equipment. The exclamation point symbol alerts you to a general warning and the hazard symbols refer to procedure-specific risks. Refer back to these Warnings.

 WARNING	
	<p>FIRE AND EXPLOSION HAZARD</p> <p>Flammable fumes, such as solvent and paint fumes, in work area can ignite or explode. To help prevent fire and explosion:</p> <ul style="list-style-type: none"> • Use equipment only in well ventilated area. • Do not fill fuel tank while engine is running or hot; shut off engine and let it cool. Fuel is flammable and can ignite or explode if spilled on hot surface. • When flammable liquid is sprayed or used for flushing or cleaning, keep sprayer at least 20 feet (6 m) away from explosive vapors. • Eliminate all ignition sources; such as pilot lights, cigarettes, portable electric lamps, and plastic drop cloths (potential static arc). • Keep work area free of debris, including solvent, rags and gasoline. • Do not plug or unplug power cords, or turn power or light switches on or off when flammable fumes are present. • Ground equipment and conductive objects in work area. See Grounding instructions. • Use only grounded hoses. • Hold gun firmly to side of grounded pail when triggering into pail. • If there is static sparking or you feel a shock, stop operation immediately. Do not use equipment until you identify and correct the problem.
	<p>SKIN INJECTION HAZARD</p> <p>High-pressure fluid from gun, hose leaks, or ruptured components will pierce skin. This may look like just a cut, but it is a serious injury that can result in amputation. Get immediate surgical treatment.</p> <ul style="list-style-type: none"> • Do not point gun at anyone or at any part of the body. • Do not put your hand over the spray tip. • Do not stop or deflect leaks with your hand, body, glove, or rag. • Do not spray without tip guard and trigger guard installed. • Engage trigger lock when not spraying. • Follow Pressure Relief Procedure in this manual, when you stop spraying and before cleaning, checking, or servicing equipment.
	<p>PRESSURIZED EQUIPMENT HAZARD</p> <p>Fluid from the gun/dispense valve, leaks, or ruptured components can splash in the eyes or on skin and cause serious injury.</p> <ul style="list-style-type: none"> • Follow Pressure Relief Procedure in this manual, when you stop spraying and before cleaning, checking, or servicing equipment. • Tighten all fluid connections before operating the equipment. • Check hoses, tubes, and couplings daily. Replace worn or damaged parts immediately.
	<p>ELECTRIC SHOCK HAZARD</p> <p>Improper grounding, setup, or usage of the system can cause electric shock.</p> <ul style="list-style-type: none"> • Turn off and disconnect power cord before servicing equipment. • Use only grounded electrical outlets. • Use only 3-wire extension cords. • Ensure ground prongs are intact on sprayer and extension cords.
	<p>RECOIL HAZARD</p> <p>Brace yourself; gun may recoil when triggered and cause you to fall, which could cause serious injury.</p>

 **WARNING**

	<p>MOVING PARTS HAZARD</p> <p>Moving parts can pinch or amputate fingers and other body parts.</p> <ul style="list-style-type: none"> • Keep clear of moving parts. • Do not operate equipment with protective guards or covers removed. • Pressurized equipment can start without warning. Before checking, moving, or servicing equipment, follow the Pressure Relief Procedure in this manual. Disconnect power or air supply.
	<p>EQUIPMENT MISUSE HAZARD</p> <p>Misuse can cause death or serious injury.</p> <ul style="list-style-type: none"> • Do not exceed the maximum working pressure or temperature rating of the lowest rated system component. See Technical Data in all equipment manuals. • Use fluids and solvents that are compatible with equipment wetted parts. See Technical Data in all equipment manuals. Read fluid and solvent manufacturer's warnings. • Check equipment daily. Repair or replace worn or damaged parts immediately. • Do not alter or modify equipment. • Use equipment only for its intended purpose. Call your Graco distributor for information. • Route hoses and cables away from traffic areas, sharp edges, moving parts, and hot surfaces. • Do not use hoses to pull equipment. • Keep children and animals away from work area. • Comply with all applicable safety regulations.
	<p>PRESSURIZED ALUMINUM PARTS HAZARD</p> <p>Do not use 1,1,1-trichloroethane, methylene chloride, other halogenated hydrocarbon solvents or fluids containing such solvents in pressurized aluminum equipment. Such use can cause serious chemical reaction and equipment rupture, and result in death, serious injury, and property damage.</p>
	<p>SUCTION HAZARD</p> <p>Never place hands near the pump fluid inlet when pump is operating or pressurized. Powerful suction could cause serious injury.</p>
	<p>CARBON MONOXIDE HAZARD</p> <p>Exhaust contains poisonous carbon monoxide, which is colorless and odorless. Breathing carbon monoxide can cause death. Do not operate in an enclosed area.</p>
	<p>TOXIC FLUID OR FUMES HAZARD</p> <p>Toxic fluids or fumes can cause serious injury or death if splashed in the eyes or on skin, inhaled, or swallowed.</p> <ul style="list-style-type: none"> • Read MSDS's to know the specific hazards of the fluids you are using. • Store hazardous fluid in approved containers, and dispose of it according to applicable guidelines.
	<p>BURN HAZARD</p> <p>Equipment surfaces and fluid that's heated can become very hot during operation. To avoid severe burns, do not touch hot fluid or equipment. Wait until equipment/fluid has cooled completely.</p>
	<p>PERSONAL PROTECTIVE EQUIPMENT</p> <p>You must wear appropriate protective equipment when operating, servicing, or when in the operating area of the equipment to help protect you from serious injury, including eye injury, inhalation of toxic fumes, burns, and hearing loss. This equipment includes but is not limited to:</p> <ul style="list-style-type: none"> • Protective eyewear • Clothing and respirator as recommended by the fluid and solvent manufacturer • Gloves • Hearing protection

General Repair Information

WARNING



MOVING PARTS HAZARD
To reduce risk of serious injury, do not touch moving parts with fingers or tools while testing repair. Shut off sprayer when repairing. Install all covers, gaskets, screws and washers before operating sprayer.

1. Keep all screws, nuts, washers, gaskets, and electrical fittings removed during repair procedures. These parts are not normally provided with replacement assemblies.
2. Test repair after problem is corrected.
3. If sprayer does not operate properly, review repair procedure to verify procedure was done correctly. If necessary, see Troubleshooting Guide, page 7, for other possible solutions.

WARNING



HOT SURFACES HAZARD
EXPLOSION HAZARD
Hydraulic system and engine may be very hot during operation and could burn skin if touched.

Flammable materials spilled on hot engine could cause fire or explosion.

4. Install belt guard before operation of sprayer and replace if damaged. Belt guard reduces risk of pinching and loss of fingers; see preceding WARNING.

Grounding

Ground sprayer with grounding clamp to earth ground for safe sprayer operation. Fig. 1.

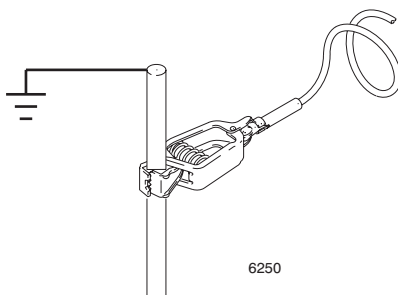
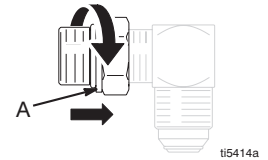

FIG. 1

SAE O-Ring Installation

1. Unscrew lock nut to touch fitting.



2. Lubricate o-ring (A).

3. Screw in fitting hand tight.

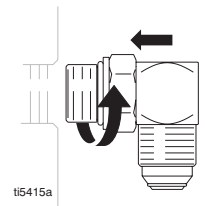

4. Unscrew fitting until oriented properly.

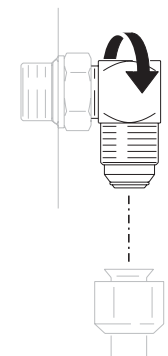

5. Tighten lock nut to indicated torque. (Make sure washer is seated properly without pinching o-ring).

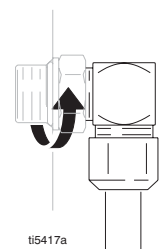

Maintenance

WARNING



SKIN INJECTION HAZARD

The system pressure must be manually relieved to prevent the system from starting or spraying accidentally. Fluid under high pressure can be injected through the skin and cause serious injury. To reduce the risk of an injury from injection, splashing fluid, or moving parts, follow the Pressure Relief Procedure whenever you:

- are instructed to relieve the pressure,
- stop spraying,
- check or service any of the system equipment,
- or install or clean the spray tip.

Pressure Relief Procedure

1. Lock gun trigger safety.
2. Turn engine ON/OFF switch to OFF.
3. Move pump valve to OFF (down) and turn pressure control knob fully counterclockwise.
4. Unlock trigger safety. Hold metal part of gun firmly to side of grounded metal pail, and trigger gun to relieve pressure.
5. Lock gun trigger safety.
6. Open pressure drain valve. Leave valve open until ready to spray again.

If you suspect that the spray tip or hose is completely clogged, or that pressure has not been fully relieved after following the steps above, VERY SLOWLY loosen tip guard retaining nut or hose end coupling to relieve pressure gradually, then loosen completely. Now clear tip or hose.

CAUTION

For detailed engine maintenance and specifications, refer to separate Honda Engines Owner's Manual, supplied.

DAILY: Check engine oil level and fill as necessary.

DAILY: Check hydraulic oil level and fill as necessary.

DAILY: Check hose for wear and damage.

DAILY: Check gun safety for proper operation.

DAILY: Check pressure drain valve for proper operation.

DAILY: Check and fill the gas tank.

DAILY: Check that displacement pump is tight.

DAILY: Check level of TSL in displacement pump packing nut. Fill nut, if necessary. Keep TSL in nut to help prevent fluid buildup on piston rod and premature wear of packings and pump corrosion.

AFTER THE FIRST 20 HOURS OF OPERATION:

Drain engine oil and refill with clean oil. Reference Honda Engines Owner's Manual for correct oil viscosity.

WEEKLY: Remove engine air filter cover and clean element. Replace element, if necessary. If operating in an unusually dusty environment: check filter daily and replace, if necessary.

Replacement elements can be purchased from your local HONDA dealer.

WEEKLY/DAILY: Remove any debris or media from hydraulic rod.

AFTER EACH 100 HOURS OF OPERATION:

Change engine oil. Reference Honda Engines Owner's Manual for correct oil viscosity.

SEMI-ANNUALLY:

Check belt wear, page 10; replace if necessary.

YEARLY OR 2000 HOURS:

Replace hydraulic oil and filter element with Graco hydraulic oil 169236 (5 gallon/20 liter) or 207428 (1 gallon/3.8 liter) and filter element 246173; page 6.

Replace belt.

SPARK PLUG: Use only BPR6ES (NGK) or W20EPR-U (NIPPONDENSO) plug. Gap plug to 0.028 to 0.031 in. (0.7 to 0.8 mm). Use spark plug wrench when installing and removing plug.

Troubleshooting

Problem	Cause	Solution
Gas engine pulls hard (won't start)	Hydraulic pressure is too high	Turn hydraulic pressure knob counter-clockwise to lowest setting
Gas engine will not start	Switch OFF, low oil, no gasoline	Consult engine manual, supplied
Gas engine doesn't work properly	Elevation	Consult engine manual, supplied. Refer to 6.5 HP Engine Repair Kit 246311.
Gas engine operates, but displacement pump doesn't operate	Pump valve is OFF	Set pump valve ON
	Pressure setting too low	Increase pressure. See manual 310765
	Displacement pump outlet filter (if used) is dirty or clogged	Clean filter
	Tip or tip filter (if used) is clogged	Remove tip and/or filter and clean
	Hydraulic fluid too low	Shut off sprayer. Add fluid*. See page 6.
	Belt worn or broken	Replace
	Hydraulic pump worn or damaged	Bring sprayer to Graco distributor for repair
	Dried paint seized paint pump rod	Service pump. See manual 309277.
Gas engine operates, but displacement pump doesn't operate	Hydraulic motor not shifting	Set pump valve OFF. Turn pressure down. Turn engine OFF. Pry rod up or down until hydraulic motor shifts
Displacement pump operates, but output is low on upstroke	Piston ball check not seating properly. Piston packings worn or damaged.	Service piston ball check. See manual 309277. Replace packings. See manual 309277.
Displacement pump operates but output is low on downstroke and/or on both strokes	Piston packings worn or damaged.	Tighten packing nut or replace packings. See manual 309277.
	Intake valve ball check not seating properly.	Service intake valve ball check. See manual 309277.
	Suction tube air leak	Tighten suction tube
Paint leaks and runs over side of wet-cup	Loose wet-cup	Tighten packing nut enough to stop leakage
	Throat packings worn or damaged	Replace packings. See manual 309277
Excessive leakage around hydraulic motor piston rod wiper	Piston rod seal worn or damaged	Replace these parts
Fluid delivery is low	Pressure setting too low	Increase pressure. See manual 310765.
	Displacement pump outlet filter (if used) is dirty or clogged	Clean filter
	Intake line to pump inlet is not tight	Tighten
	Hydraulic motor is worn or damaged	Bring sprayer to Graco distributor for repair
	Large pressure drop in fluid hose	Use larger diameter or shorter hose
The sprayer overheats	Paint buildup on hydraulic components	Clean
	Oil level is low	Fill with oil. See page 6.
Spitting from gun	Air in fluid pump or hose	Check for loose connections on siphon assembly, tighten, then reprime pump
	Loose intake suction	Tighten
	Fluid supply is low or empty	Refill supply container
Excessive hydraulic pump noise	Low hydraulic fluid level	Shut off sprayer. Add fluid*. See page 6.

*Check hydraulic fluid level often. Do not allow it to become too low. Use only Graco approved hydraulic fluid, page 6.

Hydraulic Pump

Removal



Let hydraulic system cool before beginning service.

1. Place drip pan or rags under sprayer to catch hydraulic oil that leaks out during repair.
2. Remove drain plug (40) and oil filter (47) and allow hydraulic oil to drain.
3. Fig. 2. Disconnect suction tube (114).
4. Disconnect paint pump (111), page 15.
5. Remove screw (172), nut (173) and belt guard (117).
6. Raise motor and remove belt (44).
7. Remove two set screws (133) and fan pulley (96).
8. Remove case drain tube (97).
9. Remove elbow (22).
10. Remove tube (94) from elbow (37). Remove elbow (37) from hydraulic pump (98).
11. Remove eight screws (27) reservoir cover (68) filter assembly (46) and gasket (62).
12. Remove four screws (5) and hydraulic pump (98) from reservoir cover (68).

Installation

1. Install hydraulic pump (98) to reservoir cover (68) with four screws (5); torque 100 in-lb (11 N·m).
2. Install gasket (62) and reservoir cover (68) with eight screws (27); torque 90 in-lb (10 N·m).
3. Install elbow (37) in hydraulic pump (98). Install elbow (37) in tube (94). Torque to 15 ft-lb (20.3 N·m).
4. Install elbow (22); torque to 15 ft-lb (20.3 N·m).
5. Install case drain tube (97); torque to 25 ft-lb (33.9 N·m).
6. Install fan pulley (96) with two set screws (133).
7. Raise motor and install belt (44).
8. Install belt guard (117) with screw (172) and nut (173).
9. Connect paint pump (111), page 15.
10. Fig. 2. Connect suction tube (114).
11. Install drain plug (40); torque to 110 in-lb (12.4 N·m). Install oil filter (47); tighten 3/4 turn after gasket contacts base. Fill hydraulic pump with Graco hydraulic oil, page 6, through elbow (22) port until full. Fill reservoir with remaining hydraulic oil.
12. Start up and allow pump to operate at low pressure for approximately 5 minutes to purge all air.
13. Check oil hydraulic oil and top off, if required.

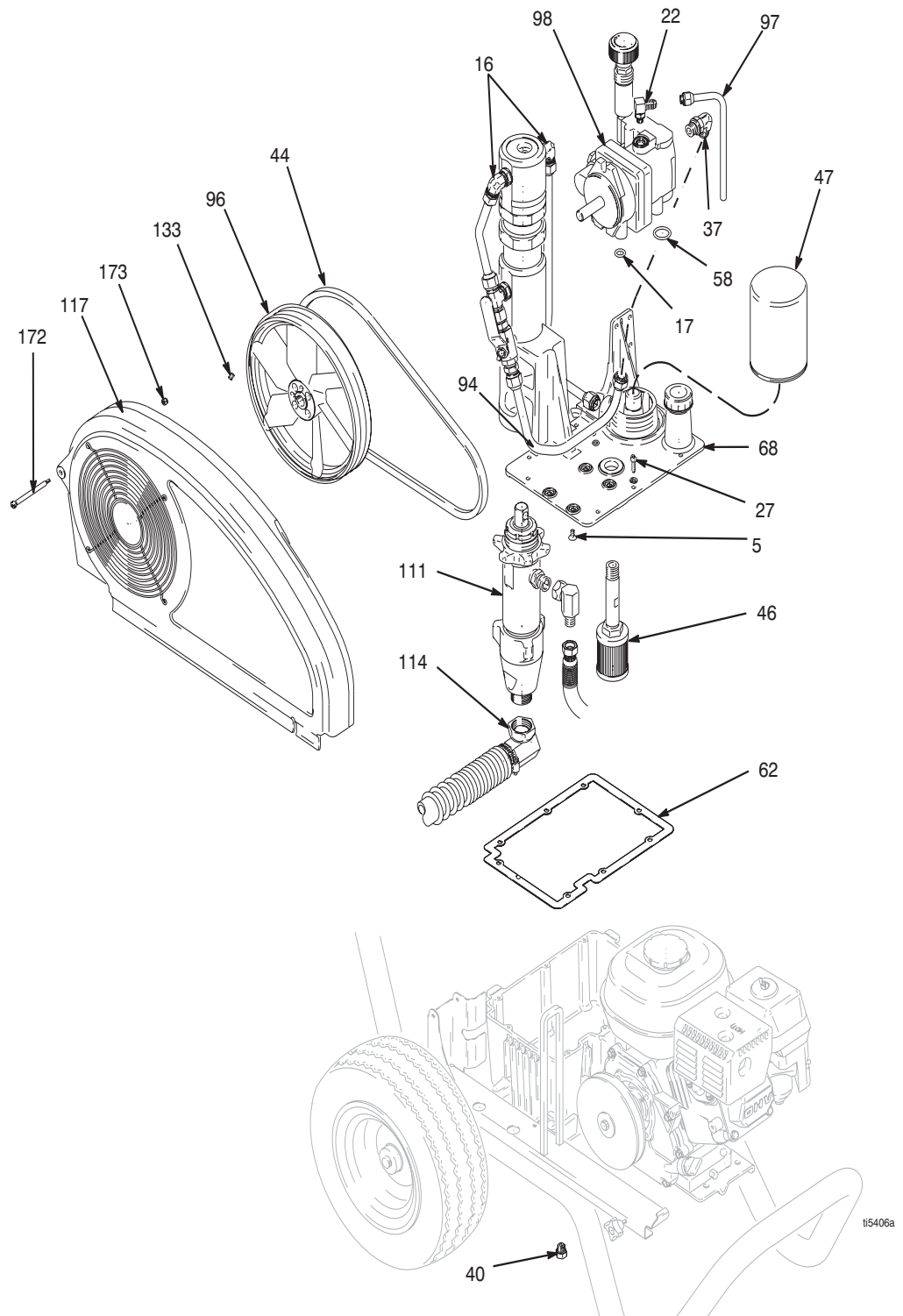

FIG. 2

Fan Belt

Removal



1. Fig. 3. Loosen belt guard knob (55).
2. Rotate belt guard (117) up.
3. Lift engine (119) up to remove tension on belt (44).
4. Remove belt from pulley (43) and fan pulley (96).

Installation

1. Thread belt (44) around drive pulley (43) and fan pulley (96).
2. Let engine (119) down to put tension on belt.
3. Rotate belt guard (117) down.
4. Tighten belt guard knob (55).

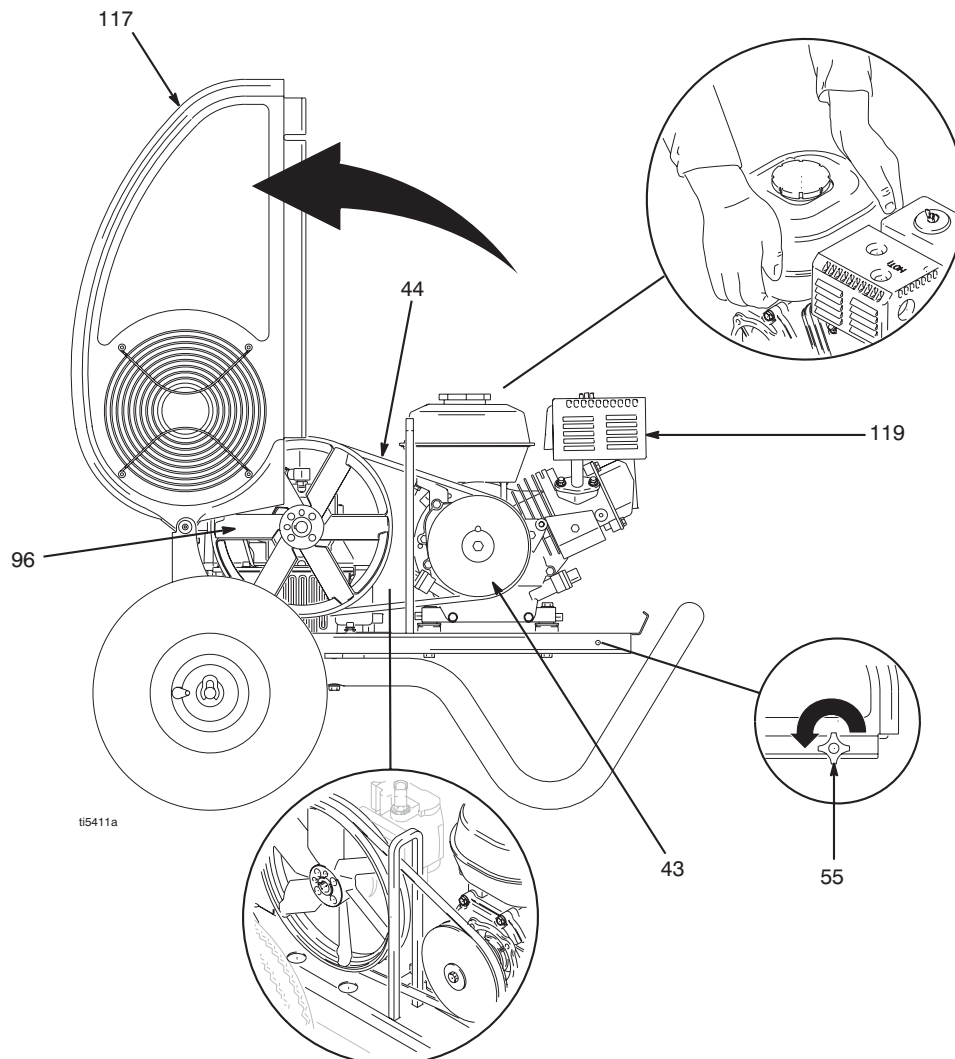

FIG. 3

Engine

Removal

NOTE: All service to the engine must be performed by an authorized HONDA dealer.

WARNING



Relieve pressure; page 6.

1. Do **Fan Belt, Removal**; page 10.
2. Fig. 4. Loosen motor knob (55). Swing motor retainer bracket (105) out.
3. Remove engine (119) and rocker plate (99) from sprayer.
4. Remove four screws (23), washers (7) and nuts (24) and remove rocker plate (99), dampeners (153) and washers (154) from engine (119).

Installation

1. Install rocker plate (99), dampeners (153) and washers (154) on engine (119) with four screws (23), washers (7) and nuts (24); torque to 125 in-lb (14.1 N-m).
2. Install engine and rocker plate (99) on sprayer.
3. Swing motor retainer bracket (105) in. Tighten motor knob (55).
4. Do **Fan Belt, Installation**; page 10.

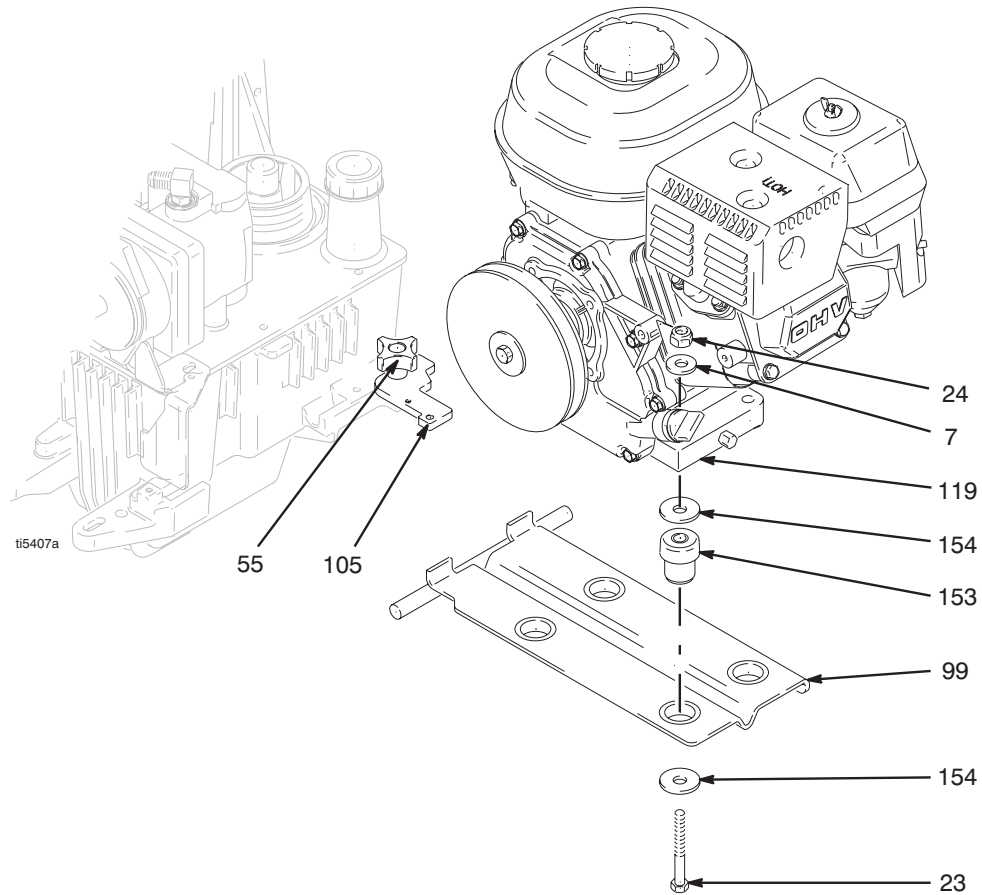



FIG. 4

Hydraulic Motor Rebuild

Removal



 **WARNING**

Relieve pressure; page 6.

1. Place drip pan or rags under sprayer to catch hydraulic oil that leaks out during repair.
2. Remove pump pin (92) and retainer clip (120), page 15.
3. Fig. 5. Remove hydraulic lines (93, 95) from fittings (16) at top left and right side of hydraulic motor.
4. Loosen jam nut (65).
5. Unscrew and remove hydraulic motor cap (64).
6. Slide piston rod/hydraulic motor cap assembly (A) from hydraulic motor cylinder.
7. Remove yoke (78).
 - a. Fig. 5. Clamp hydraulic motor cap in vise with hydraulic motor piston rod facing up.
 - b. Use shortened Allen wrench to remove two screws (13) from spring retainer (83). Remove yoke, spring retainer, piston and trip rod assembly from hydraulic motor cap.

 **WARNING**

 



FLYING PARTS HAZARD

Detent spring has high energy potential. If detent spring is released without due care detent spring and balls could fly into the eyes of the disassembler. Wear safety glasses when removing or installing detent spring and balls. Failure to wear safety glasses when removing detent spring could result in eye injury or blindness.

- c. Cover spring retainer (83) with a rag to contain detent spring (20) and balls (8) when they are removed from yoke. Remove detent balls and spring. Remove spring retainer.
- d. Put yoke in vise and remove piston rod assembly from yoke.

Installation

 **WARNING**

FLYING PARTS HAZARD

Detent spring has high energy potential. If detent spring is released without due care detent spring and balls could fly into the eyes of the disassembler. Wear safety glasses when removing or installing detent spring and balls. Failure to wear safety glasses when removing detent spring could result in eye injury or blindness.

1. Fig. 5. Put hydraulic motor cap (64) in vise.
2. Install yoke, spring retainer, piston and trip rod assembly in hydraulic motor cap. Use shortened Allen wrench to install two screws (13) in spring retainer to secure piston rod assembly to hydraulic motor cap.
3. Slide piston rod assembly (A) into hydraulic motor cylinder (67).
4. Screw down hydraulic motor cap (64). Unscrew hydraulic motor cap until inlet and outlet align with hydraulic line fittings and test hole in hydraulic motor cap points toward belt guard (117).
5. Torque jam nut (65) against hydraulic motor cap (64) to 150 ft-lb (17 N·m).
6. Fig. 5. Install hydraulic lines (93, 95) to fittings (16) to top left and right side of hydraulic motor; torque to 40 ft-lb (54.2 N·m).
7. Pull start rope slowly to align pin holes of hydraulic motor and displacement pump (111). Connect with pump pin (92); install retainer clip (120), page 15.
8. Start engine and operate pump for 30 seconds. Turn engine OFF. Check hydraulic oil level and fill with Graco hydraulic oil, page 6.

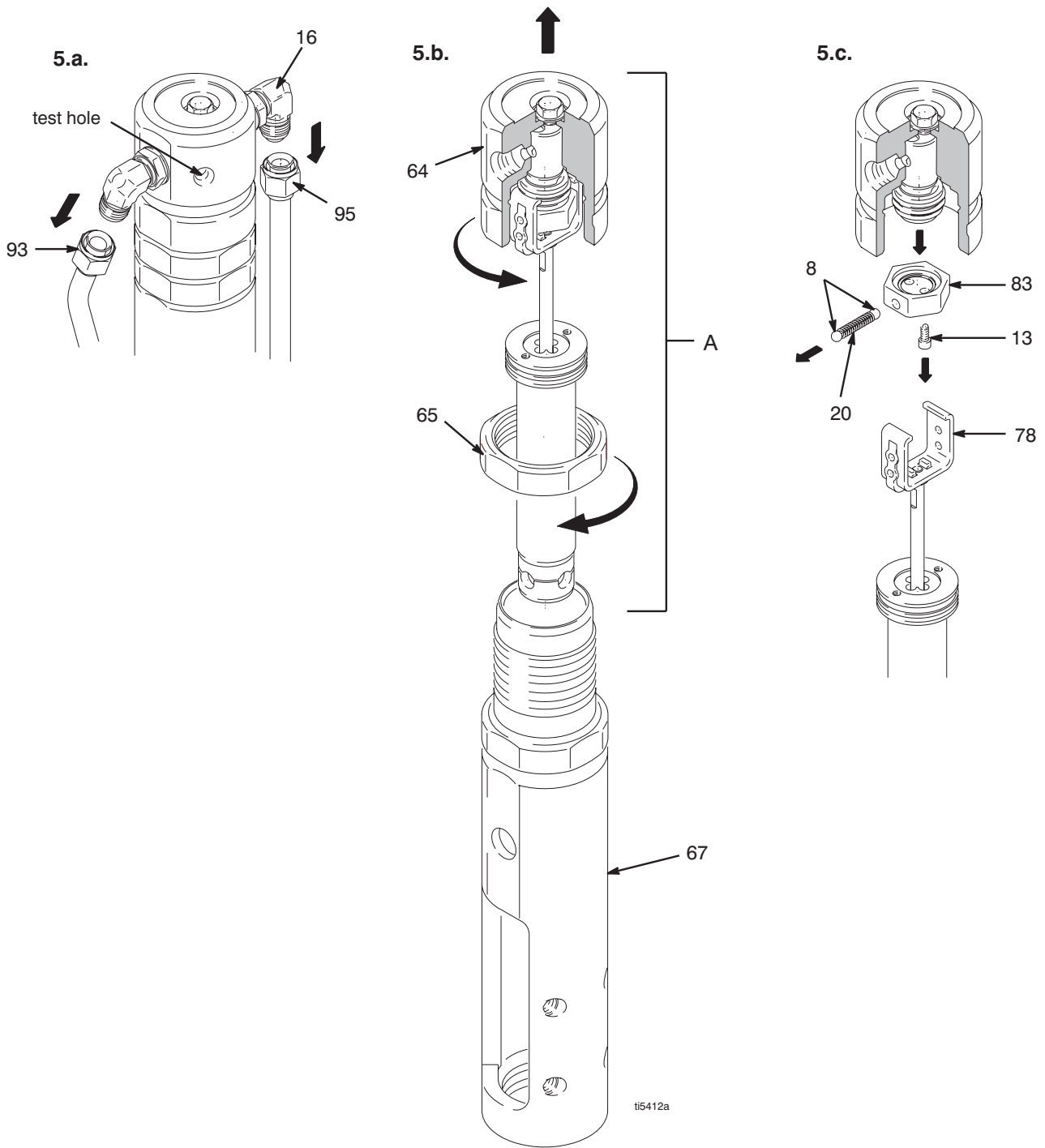

FIG. 5

Hydraulic Oil/Filter Change

Removal

 **WARNING**

Relieve pressure; page 6.

1. Fig. 6. Place drip pan or rags under sprayer to catch hydraulic oil that drains out.
2. Remove drain plug (40). Allow hydraulic oil to drain.
3. Unscrew filter (47) slowly - oil runs into groove and drains out rear.

Installation

1. Install drain plug (40) and oil filter (47). Tighten oil filter 3/4 turn after gasket contacts base.
2. Fill with five quarts of Graco hydraulic oil 169236 (5 gallon/20 liter) or 207428 (1 gallon/3.8 liter).
3. Check oil level.

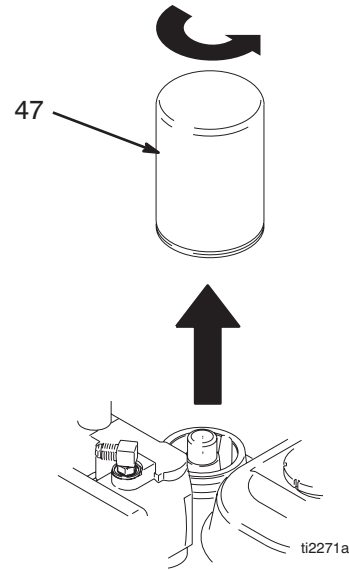

FIG. 6

Displacement Pump

See manual 309277 for pump repair instructions

Removal

1. Flush pump.

⚠ WARNING



Relieve pressure; page 6.

1. Fig. 7. Remove suction tube (114) and paint hose (63) (remove at swivel end).

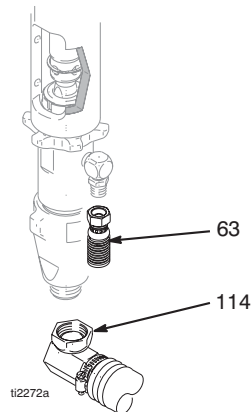

FIG. 7

2. Fig. 8. Push retaining spring up; push out pin (92).

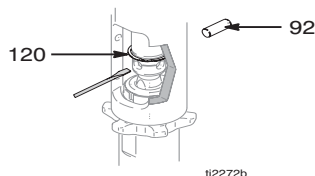

FIG. 8

3. Fig. 9. Loosen jam nut. Unscrew pump.

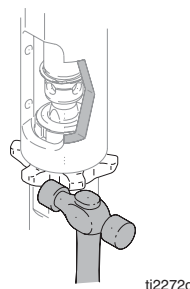

FIG. 9

Installation

⚠ WARNING

If pin works loose, parts could break off and project through the air and result in serious injury or property damage. Make sure pin is properly installed.

CAUTION

If the pump jam nut loosens during operation, the threads of the bearing housing and drive train will be damaged. Tighten jam nut as specified.

1. Fig. 10. Screw jam nut to bottom of pump threads. Screw pump completely into manifold. Unscrew pump from manifold until pump outlet aligns with hose. Hand tighten jam nut, then tap 1/8 to 1/4 turn with hammer or torque to 200 ft-lb (270 N·m).

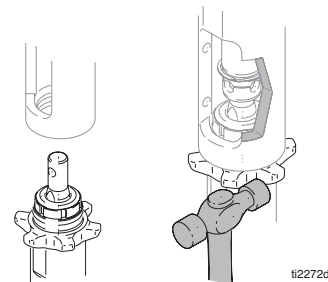

FIG. 10

2. Fig. 11. Slowly pull engine starter rope until pump rod pin hole is aligned with hydraulic rod hole. Fig. 8. Push pin (92) into hole. Push retaining spring (120) into groove.

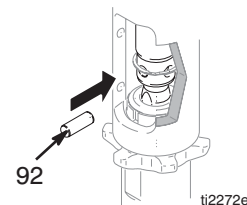

FIG. 11

3. Fig. 12. Fill packing nut with Graco TSL.

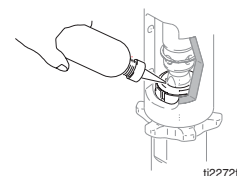
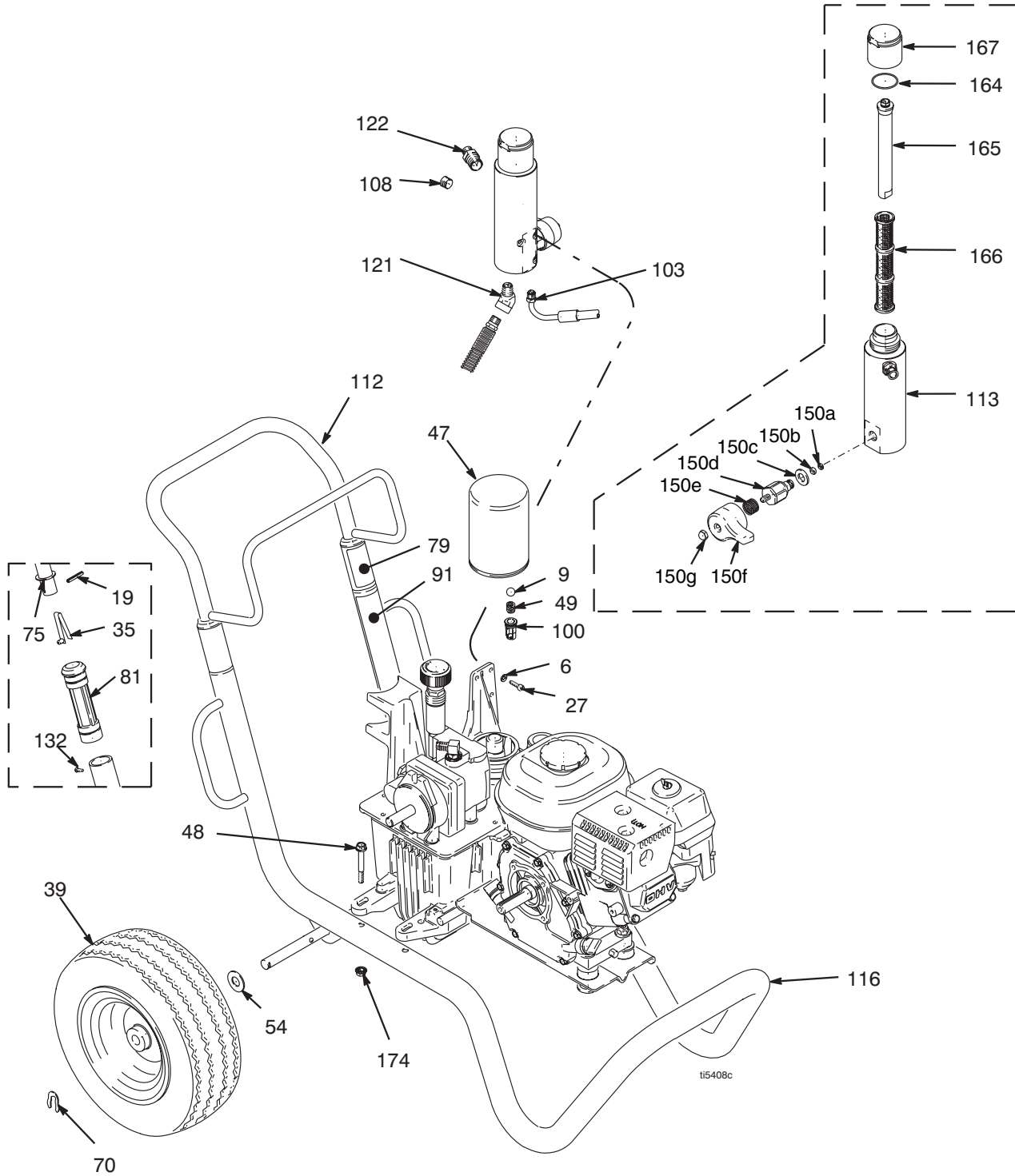

FIG. 12

Parts

Parts Drawing - GH 200, GH 230, GH 300, EH 200 Sprayers



Parts List - GH 200, GH 230, GH 300, EH 200 Sprayers

Ref. No.	Part No.	Description	Qty.	Ref. No.	Part No.	Description	Qty.
6	100016	WASHER, lock	12	122	162485	NIPPLE, adapter	2
9	100084	BALL, metallic	1	132	109032	SCREW, mach, pnh	4
19	108068	PIN, spring straight	2	150	245103	DRAIN VALVE	
27	112166	SCREW, cap, sch	12	150a*	193710	SEAL, seat, valve	1
35	112827	BUTTON, snap	2	150b*	193709	SEAT, valve	1
39	119408	WHEEL, pneumatic	2	150c*	114797	GASKET,	1
47	246173	FILTER, oil, spin on	1	150d*		VALVE ASSEMBLY	1
48	116923	SCREW, hex head	4	150e*	114708	SPRING, compression	1
49	116967	SPRING, compression	1	150f*	15G563	HANDLE, valve cap	1
54	111841	WASHER, plain 5/8	2	150g*	116424	NUT, cap	1
70	15B563	CLIP, retainer	2	164#	117285	O-RING	1
75	183350	WASHER	2	165#	15C766	TUBE, diffusion	1
79▲	189246	LABEL, warning	1	166	244067	FILTER, fluid, 60 mesh, black	1
81	192027	SLEEVE, cart	2	167#	15C765	CAP, filter	1
91▲	194317	LABEL, Danger, English	1	174	110966	NUT	2
100	198841	RETAINER, ball, press bypass	1				
103	246169	HOSE, drain	1				
108	101754	PLUG	1				
112	248818	HANDLE, cart	1				
113	15E599	HOUSING, filter	1				
116	248815	CART, frame, GH	1				
121	116756	FITTING, elbow, street 45 deg	1				

▲ Replacement Danger and Warning labels, tags, and cards are available at no cost

Included in Manifold Kit 287285

* Included in Drain Valve Kit 245103

Parts Drawing - GH 200, GH 230, GH 300, EH 200 Sprayers

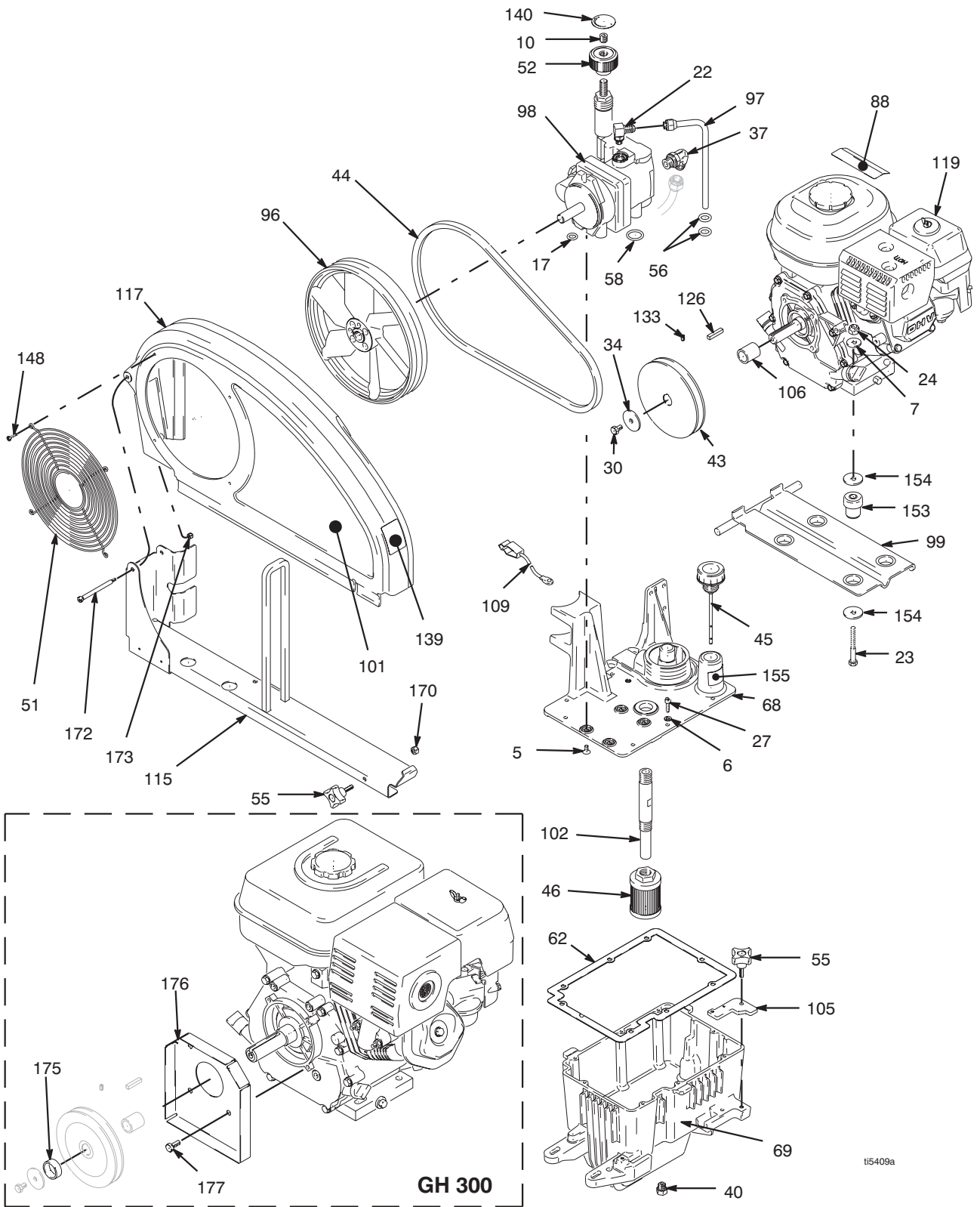

Parts List - GH 200, GH 230, GH 300, EH 200 Sprayers

Ref. No.	Part No.	Description	Qty.	Ref. No.	Part No.	Description	Qty.
				101		LABEL, brand	
5	117471	SCREW, 1/4-20 flat head mach	4	15E674	GH 200		1
6	100016	WASHER, lock	12	15E677	GH 230		1
7		WASHER, flat		15E679	GH 300		1
	100023	GH 200, GH 230, EH 200	4	15E681	EH 200		1
	100132	GH 300	4	102	15E587	TUBE, suction	1
10	117560	SCREW, set, socket head	1	105	15E476	BRACKET, retainer, motor	1
17	107188	O-RING	4	106		SPACER, shaft, engine	
22	110792	ELBOW, male, 90 deg	1	248978	GH 200, GH 230; includes 43, 133		1
23		SCREW, cap, hex hd		15E586	GH 300		1
	113664	GH 200, GH 230, EH 200	4	15B314	EH 200		1
	106212	GH 300	4	109	237686	WIRE, ground assembly w/clamp	1
24		NUT, lock		115	248976	RAIL, belt guard, assembly	1
	110838	GH 200, GH 230, EH 200	4			includes 55, 170, 172, 173	
	101566	GH 300	4	117	248973	GUARD, belt, assembly, painted	1
27	112166	SCREW, cap, sch	12			includes 51, 139, 148	
30		SCREW, cap, hex hd		119		ENGINE	
	108842	GH 200, GH 230	1			includes 7, 23, 24, 26, 30, 34, 99,	
	116645	GH 300	1			106, 33, 153, 154	
34		WASHER		248943	ENGINE, GX160K1QX2, 5.5 HP		1
	112717	GH 200, GH 230, EH 200	1	248944	ENGINE, GX200QX2, 6.5 HP		1
	119438	GH 300	1	248945	ENGINE, GX270QA2, 9.0 HP		1
37	116793	FITTING, elbow, hydraulic	1	248946	MOTOR, electric; see Manual 310812		1
40	116754	PLUG, hex head, hydraulic	1	119		ENGINE without kit parts	
43		PULLEY, 5.50 in. dia.		802264	ENGINE, GX160K1QX2, 5.5 HP		1
	248978	GH 200, GH 230; includes 106, 133	1	116298	ENGINE, GX200QX2, 6.5 HP		1
	119401	GH 300	1	803900	ENGINE, GX270QA2, 9.0 HP		1
	15E588	EH 200	1	126		KEY, square, 3/16 x 1.25	
44		BELT, V, gripnotch		117632	GH 200, GH 230, EH 200		1
	119433	GH 200, GH 230, EH 200 ax41 in	1	119484	GH 300		1
	119432	GH 300, ax44 in.	1	133	100002	SCREW, set, sch	3
45	116915	CAP, breather filler	1	139▲	198492	LABEL, warning	1
46	116919	FILTER, hydraulic, suction	1	140	15A464	LABEL, control	1
51	117284	GRILL, fan guard	1	148	115477	SCREW, mach., torx pan hd	4
52	15B438	KNOB, pressure	1	153		DAMPENER, motor mount	
55	15D862	NUT, hand	2	15E888	GH 200, GH 230		4
56	154594	O-RING	2	195515	GH 300		4
58	156401	O-RING	1	154	108851	WASHER, plain	8
62	246172	GASKET, reservoir	1	155	198585	LABEL, hydraulic fluid, GH	1
68	15E457	COVER, reservoir	1	170	102040	NUT, lock, hex	1
69	15E342	TANK, reservoir	1	172	119434	SCREW, shoulder, socket head	1
88▲	194126	LABEL, warning	1	173	116969	NUT, lock	1
96	15E410	PULLEY, fan	1	175	15E764	SPACER, shaft, engine, GH 300	1
97	246167	TUBE, hydraulic, case drain	1	176	15E973	GUARD, shield, engine, GH 300	1
		includes 56		177	C20010	SCREW, cap, socket	2
98		PUMP, hydraulic					
	246178	GH 200	1				
	249003	GH 300, GH 230, EH 200	1				
99		BRACKET, engine mount					
	15F157	GH 200, GH 230	1				
	15E583	GH 300	1				
	15E585	EH 200	1				

▲ Danger and Warning labels, are available at no cost

Parts Drawing - GH 200, GH 230, GH 300, EH 200 Sprayers

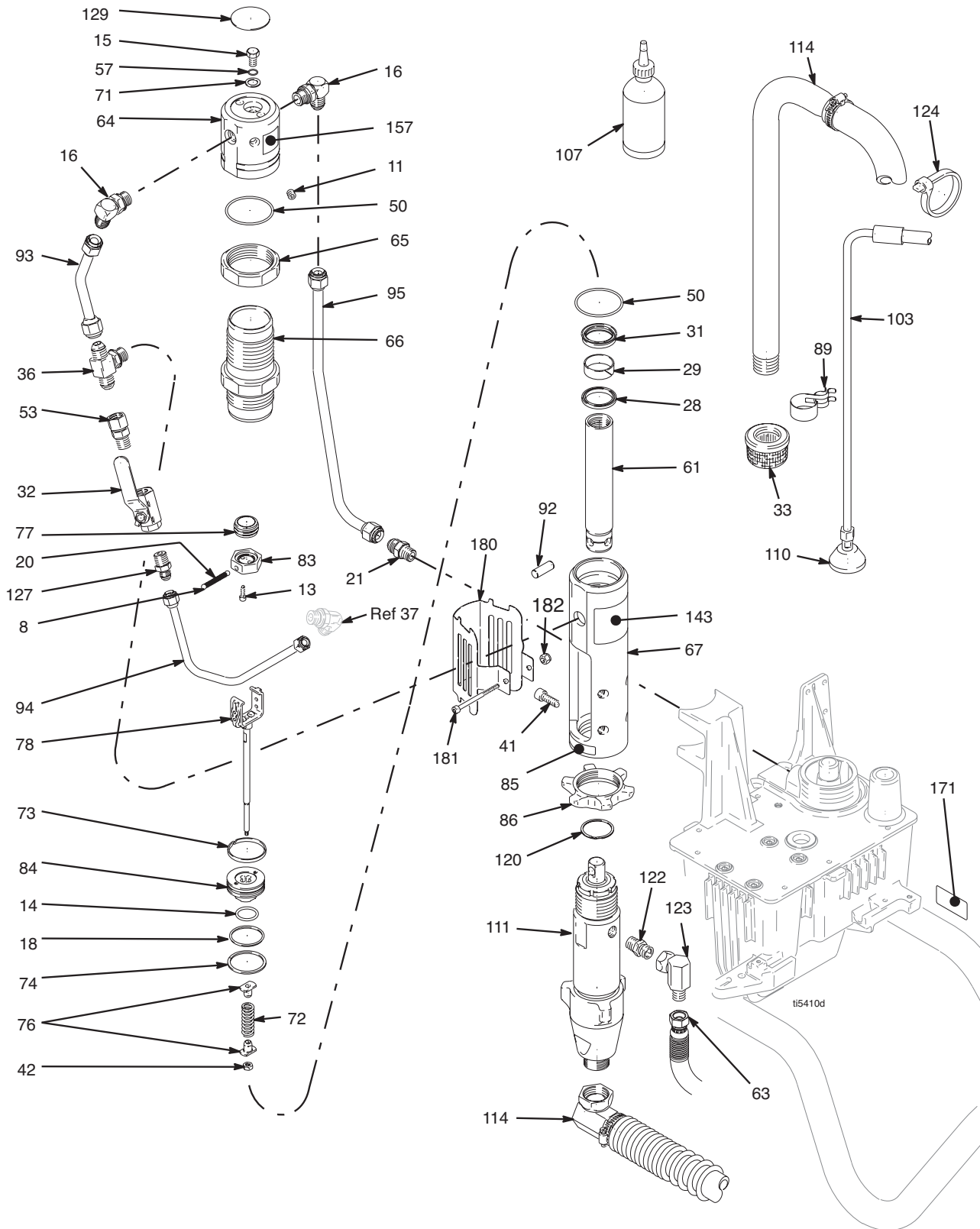

Parts List - GH 200, GH 230, GH 300, EH 200 Sprayers

Ref. No.	Part No.	Description	Qty.	Ref. No.	Part No.	Description	Qty.
					15E594	GH 200, EH 200	1
8†★◆	100069	BALL	2		15E597	GH 230, GH 300	1
11†◆	100139	PLUG, pipe	1	95		TUBE, hydraulic, return	
13†★◆	104092	SCREW, cap, sch	2		15E595	GH 200, EH 200	1
14†★◆	105765	O-RING	1		15E598	GH 230, GH 300	1
15†◆		SCREW, cap, hex hd	1	103	246169	HOSE, drain	1
16◆	117607	FITTING, elbow std thd	2			includes 110	
18†◆	108014	O-RING	1	107	206994	FLUID, TSL, 8 oz	1
20†★◆	120990	SPRING, compression	1	110	241920	DEFLECTOR, threaded	15E676
21	117608	FITTING, nipple, straight	1	111		PUMP, displacement	
28◆	117739	WIPER, rod	1			Manual 309277	
29◆	112342	BEARING, rod	1		248971	GH 200, EH 200, Series A	1
31◆	112561	PACKING, block	1		248736	GH 230, GH 300, Series A	1
32	117441	VALVE, ball	1		287814	GH 200, Series B	1
33	189920	STRAINER, (1-11 1/2 npsm)	1		287815	GH 230, GH 300, Series B	1
36◆	117609	FITTING, tee, branch, str thd	1	114	246168	TUBE, suction, 5 gallon	1
41◆	15B564	SCREW, cap, socket low head	4			includes 33	
42†★◆	114231	NUT, lock, hex	1	120	116551	RING, retaining	1
50†◆	117283	O-RING	1	122	162485	NIPPLE, adapter	2
53	117328	FITTING, nipple, straight	1	123	155494	UNION, swivel, 90 deg	1
57†◆		O-RING	1	124	114958	STRAP, tie	4
61†★◆		ROD, hydraulic motor	1	127	116813	FITTING, nipple, hydraulic	1
	15A693	GH 200, EH 200	1	129†◆	15B063	LABEL	1
	15E241	GH 230, GH 300	1	143◆		LABEL	
63	243814	HOSE, coupled	1		15E676	GH 200	1
64†◆		CAP, hydraulic head assembly	1		15E678	GH 230	1
65◆	15A726	NUT, jam	1		15E680	GH 300	1
66†◆		SLEEVE, hydraulic cylinder			15E682	EH 200	1
	246176	GH 200, EH 200	1	157	15B804	LABEL, Graco logo	2
	248991	GH 230, GH 300	1	171	15E683	LABEL	1
67◆		MANIFOLD, adapter		180✓	15F242	GUARD, pump rod	1
	15A728	GH 200, EH 200	1	181✓	113263	SCREW	1
	15E243	GH 230, GH 300	1	182✓	114231	NUT	1
71†◆		WASHER, sealing		183†◆		STOP, valve	1
72†★◆	117645	SPRING, compression	1	184◆		FITTING, cap nut	2
73†◆	178207	BEARING, piston	1				
74†◆	178226	SEAL, piston	1				
76†★◆	15B463	RETAINER, spring	2				
77†◆		SLEEVE, valve					
78†◆		YOKE, assembly (with trip rod)					
	246610	GH 200, EH 200	1				
	248823	GH 230, GH 300	1				
83★	192654	STOP, valve	1				
84†★◆	192656	PISTON	1				
85▲◆	192840	LABEL	1				
86	193394	NUT, retaining	1				
89	196723	CLIP, spring	1				
92	197443	PIN, pump	1				
93◆		TUBE, hydraulic, supply					
	198629	GH 200, EH 200	1				
	15E596	GH 230, GH 300	1				
94		TUBE, hydraulic, supply					

▲ Danger and Warning labels, are available at no charge

† Included in Trip Rod/Piston/Cap Kit
288754 (GH200); 288755, (GH230, GH 300)

‡ Included in (hydraulic cylinder) Sleeve Kit:
246176 (GH 200); 248991 (GH 230, GH 300)

★ Included in Trip Rod/Piston Kit:
246255 (GH 200); 248975 (GH 230, GH 300)

* Included in Seal Kit 246174

◆ Included in Hydraulic Motor Repair Kit
248021 (GH200); 248977; (GH 230, GH 300)

✓ Used on EH 200

GH 200 Sprayers with Spray Gun and Hoses

248560 Includes 201 and 202

Ref No.	Part No.	Description	Qty.
201	248559	GH 200 See cover and Parts, pages 16 - 21	1
202	287037	KIT, gun, Contractor 3300 psi (227 bar, 22.7 MPa) Includes 202a - 202d	1
202a	240797	HOSE, grounded, nylon; 3/8 in. ID; cpld 3/8-18 npsm; 50 foot (15 m); spring guards both ends 3300 psi (227 bar, 22.7 MPa)	1
202b	238358	HOSE, grounded, nylon; 3/16 in. ID; cpld 1/4 npt(m) x 1/4 npsm(f); 3 foot (0.9 m); spring guards both ends 3300 psi (227 bar, 22.7 MPa)	1
202c	246220	Contractor Spray Gun Includes 517 RAC [®] X SwitchTip and HandTite [™] Guard See 309639 for parts	1
202d	159841	ADAPTER, 3/8 X 1/4 in. npt	1

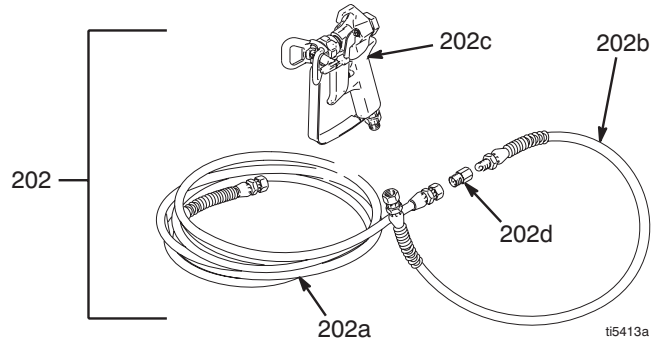

GH 230 Sprayers with Spray Gun and Hoses

248562 Includes 201 and 202

Ref No.	Part No.	Description	Qty.
201	248561	GH 230 See cover and Parts, pages 16 - 21	1
202	287042	KIT, gun, Silver 3300 psi (227 bar, 22.7 MPa) Includes 202a - 202d	1
202a	240797	HOSE, grounded, nylon; 3/8 in. ID; cpld 3/8-18 npsm; 50 foot (15 m); spring guards both ends 3300 psi (227 bar, 22.7 MPa)	1
202b	238358	HOSE, grounded, nylon; 3/16 in. ID; cpld 1/4 npt(m) x 1/4 npsm(f); 3 foot (0.9 m); spring guards both ends 3300 psi (227 bar, 22.7 MPa)	1
202c	246240	Silver Spray Gun Includes 517 RAC [®] X SwitchTip and HandTite [™] Guard See 309740 for parts	1
202d	159841	ADAPTER, 3/8 X 1/4 in. npt	1

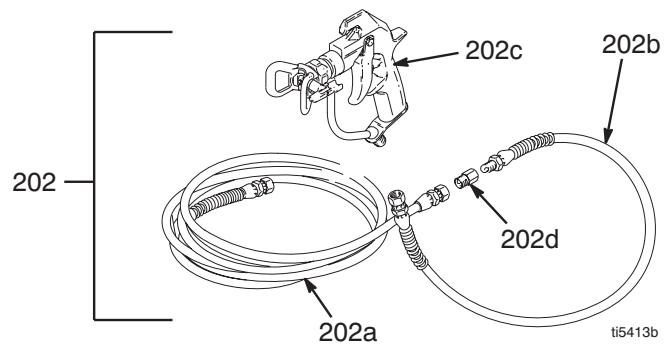

GH 300 Sprayers with Spray Gun and Hoses

248564 Includes 201 and 202

Ref No.	Part No.	Description	Qty.
201	248563	GH 300 See cover and Parts, pages 16 - 21	1
202	287042	KIT, gun, Silver 3300 psi (227 bar, 22.7 MPa) Includes 202a - 202d	1
202a	240797	HOSE, grounded, nylon; 3/8 in. ID; cpld 3/8-18 npsm; 50 foot (15 m); spring guards both ends 3300 psi (227 bar, 22.7 MPa)	1
202b	238358	HOSE, grounded, nylon; 3/16 in. ID; cpld 1/4 npt(m) x 1/4 npsm(f); 3 foot (0.9 m); spring guards both ends 3300 psi (227 bar, 22.7 MPa)	1
202c	246240	Silver Spray Gun Includes 517 RAC [®] X SwitchTip and HandTite [™] Guard See 309740 for parts	1
202d	159841	ADAPTER, 3/8 X 1/4 in. npt	1

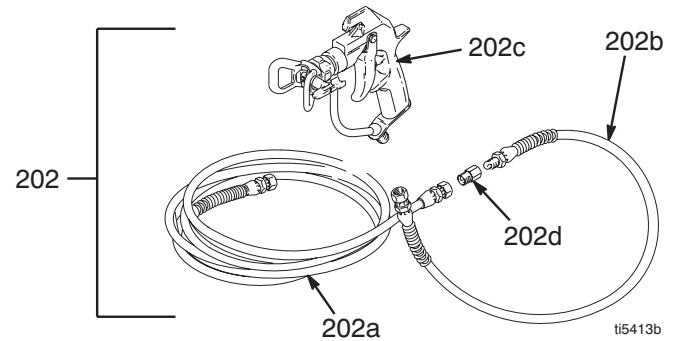



A series of horizontal lines for writing, consisting of 20 evenly spaced lines extending across the width of the page.

Technical Data

Sprayer	Hydraulic Pressure psi (bar)	Hydraulic Reservoir Capacity Gallons (Liters)	Motor HP (kW)	Maximum Delivery gpm (lpm)	Maximum Tip size		Fluid Inlet in.	Fluid Outlet in.	
					1 gun	2 guns		npsm(m)	npt(f)
GH 200 Gas	1825 (125.8)	1.25 (4.75)	5.5 (4.1)	2.0 (7.6)	0.046	0.033	1 npsm(m)	3/8	3/8
GH 230 Gas	1825 (125.8)	1.25 (4.75)	6.5 (4.8)	2.3 (8.7)	0.052	0.037	1 npsm(m)	3/8	3/8
GH 300 Gas	1825 (125.8)	1.25 (4.75)	9.0 (6.7)	3.0 (11.4)	0.057	0.039	1 npsm(m)	3/8	3/8
GH 200 120 Vac	1825 (125.8)	1.25 (4.75)	2.0 (1.5)	1.2 (4.5)	0.031	0.021	1 npsm(m)	3/8	3/8
EH 200 240 Vac	1825 (125.8)	1.25 (4.75)	3.0 (2.2)	1.5 (5.7)	0.037	0.025	1 npsm(m)	3/8	3/8

Basic Sprayer Wetted Parts:

Zinc and nickel-plated carbon steel, stainless steel, PTFE, acetal, chrome plating, leather, V-Maxt UHMWPE, aluminum, stainless steel, tungsten carbide, ceramic, nylon, aluminum

Dimensions

Sprayer	Weight lb (kg)	Height in. (cm)		Width in. (cm)	Length in. (cm)
		Handle Up	Handle Down		
GH 200 Gas	163 (73.35)	39 (99)	32 (81.3)	24 (61)	48 (121.92)
GH 230 Gas	168 (75.6)	39 (99)	32 (81.3)	24 (61)	48 (121.92)
GH 300 Gas	195 (87.75)	39 (99)	32 (81.3)	24 (61)	48 (121.92)
GH 200 120 Vac	186 (83.7)	39 (99)	32 (81.3)	24 (61)	48 (121.92)
EH 200 240 Vac	186 (83.7)	39 (99)	32 (81.3)	24 (61)	48 (121.92)

Sound Levels*

Sound Pressure96 dB(A)

Sound Power110 dB(A)

*Measured at maximum normal load conditions (Gas only)

Accessories

Must be purchased separately.

GRACO-APPROVED HYDRAULIC OIL

169236 5 Gallons (19 liters)
207428 1 Gallons (3.8 liters)

Graco Standard Warranty

Graco warrants all equipment referenced in this document which is manufactured by Graco and bearing its name to be free from defects in material and workmanship on the date of sale to the original purchaser for use. With the exception of any special, extended, or limited warranty published by Graco, Graco will, for a period of twelve months from the date of sale, repair or replace any part of the equipment determined by Graco to be defective. This warranty applies only when the equipment is installed, operated and maintained in accordance with Graco's written recommendations.

This warranty does not cover, and Graco shall not be liable for general wear and tear, or any malfunction, damage or wear caused by faulty installation, misapplication, abrasion, corrosion, inadequate or improper maintenance, negligence, accident, tampering, or substitution of non-Graco component parts. Nor shall Graco be liable for malfunction, damage or wear caused by the incompatibility of Graco equipment with structures, accessories, equipment or materials not supplied by Graco, or the improper design, manufacture, installation, operation or maintenance of structures, accessories, equipment or materials not supplied by Graco.

This warranty is conditioned upon the prepaid return of the equipment claimed to be defective to an authorized Graco distributor for verification of the claimed defect. If the claimed defect is verified, Graco will repair or replace free of charge any defective parts. The equipment will be returned to the original purchaser transportation prepaid. If inspection of the equipment does not disclose any defect in material or workmanship, repairs will be made at a reasonable charge, which charges may include the costs of parts, labor, and transportation.

Graco's sole obligation and buyer's sole remedy for any breach of warranty shall be as set forth above. The buyer agrees that no other remedy (including, but not limited to, incidental or consequential damages for lost profits, lost sales, injury to person or property, or any other incidental or consequential loss) shall be available. Any action for breach of warranty must be brought within two (2) years of the date of sale.

GRACO MAKES NO WARRANTY, AND DISCLAIMS ALL IMPLIED WARRANTIES OF MERCHANTABILITY AND FITNESS FOR A PARTICULAR PURPOSE, IN CONNECTION WITH ACCESSORIES, EQUIPMENT, MATERIALS OR COMPONENTS SOLD BUT NOT MANUFACTURED BY GRACO. These items sold, but not manufactured by Graco (such as electric motors, switches, hose, etc.), are subject to the warranty, if any, of their manufacturer. Graco will provide purchaser with reasonable assistance in making any claim for breach of these warranties.

In no event will Graco be liable for indirect, incidental, special or consequential damages resulting from Graco supplying equipment hereunder, or the furnishing, performance, or use of any products or other goods sold hereto, whether due to a breach of contract, breach of warranty, the negligence of Graco, or otherwise.

FOR GRACO CANADA CUSTOMERS

The Parties acknowledge that they have required that the present document, as well as all documents, notices and legal proceedings entered into, given or instituted pursuant hereto or relating directly or indirectly hereto, be drawn up in English. Les parties reconnaissent avoir convenu que la rédaction du présente document sera en Anglais, ainsi que tous documents, avis et procédures judiciaires exécutés, donnés ou intentés, à la suite de ou en rapport, directement ou indirectement, avec les procédures concernées.

ADDITIONAL WARRANTY COVERAGE

Graco does provide extended warranty and wear warranty for products described in the Graco Contractor Equipment Warranty Program".

TO PLACE AN ORDER, contact your Graco distributor, or call **1-800-690-2894** to identify the nearest distributor.

All written and visual data contained in this document reflects the latest product information available at the time of publication.

Graco reserves the right to make changes at any time without notice.

This manual contains English. MM 310778

Graco Headquarters: Minneapolis

International Offices: Belgium, China, Japan, Korea

GRACO INC. P.O. BOX 1441 MINNEAPOLIS, MN 55440-1441

<http://www.graco.com>

8/2004, Revised 10/2008