



PROTEXT - GSM REMOTE CONTROL

- Remote Control From a Mobile Phone
- Easy to Install and Configure using SMS commands
(No PC required).
- 4 Digital Inputs (Volt Free)
- Upto 8 Relay Outputs rated 240Vac 5A
- User Can set inputs and outputs Names
- Up to 5 mobiles per input
- Outputs controlled by SMS text message
- Request Status via SMS
- Enclosure Rated IP68 (Pressure Washer Proof)
- Automatically Sends SMS message when input activated
- Accepts all major SIM Cards.
- Tri-band GSM for use in Europe & USA



PROTEXT

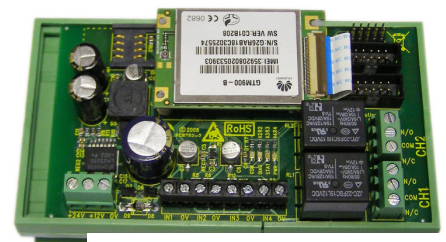

PROTEXT-DIN RAIL

Applications

- Remote control by GSM Mobile phone.
- Remote Maintenance, warnings / Alarms.
- Irrigation Systems.
- Remote system monitoring.
- Plant Maintenance.
- Security Systems
- Alert / Panic caller

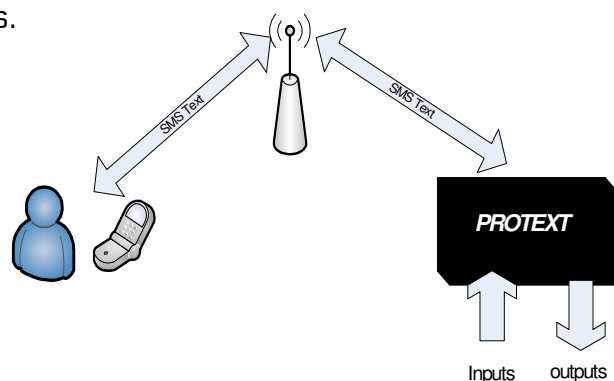

Ordering Information

PART No	Description
PROTEXT	GSM Telemetry System IP68 Enclosure
PROTEXT-DIN	GSM Telemetry System DIN Rail Module



PROTEXT - GSM REMOTE CONTROL

User Manual

1. Introduction	4
2. Hardware Features.....	4
PROTEXT Features	4
PROTEXT DIN Features.....	4
SIM card	5
Power Connections.....	5
Input Connections and Output Relays	5
Signal Strength / LED Indication	7
Power Loss.....	7
Wall Mounting	7
3. Optional Power Supply.....	8
4. PROTEXT-DIN Optional Modules.....	9
215 Relay Output Module	9
230 Relay Output Module	9
Enclosure c/w Mains Power Supply.....	9
5. Extending the Antenna.....	10
CBA-UFLSMA-1	10
External Mount Gain Antenna	10
GSM20-ANT	10
ANT-GSMPUKS	10
ANT-GSMSTUB3	10
ANT-GSM5WM.....	10
6. User Set-Up Commands	11
Definitions.....	11
User Set-Up of PROTEXT	11
Unit Password.....	12
Unit Identity	12
Input number-to-text.....	12
Power Failure number-to-text	13
Deleting numbers-to-text	13
Response on/off.....	13
Output delay time.....	14
Combining Set-Up Commands into one SMS Text.....	14



1. Introduction

PROTEXT is a self contained Remote Control Solution which provides a Relay Switch outputs and 'no volt' switch inputs.

The user can send a Text message to control the output relays and PROTEXT will automatically send an SMS Text message to upto five telephone numbers.

Outputs can be given custom names and Text messages that PROTEXT Generates can be preset by the user.

2. Hardware Features

PROTEXT Features

- Integrated Antenna connector
- 2 x Relay outputs

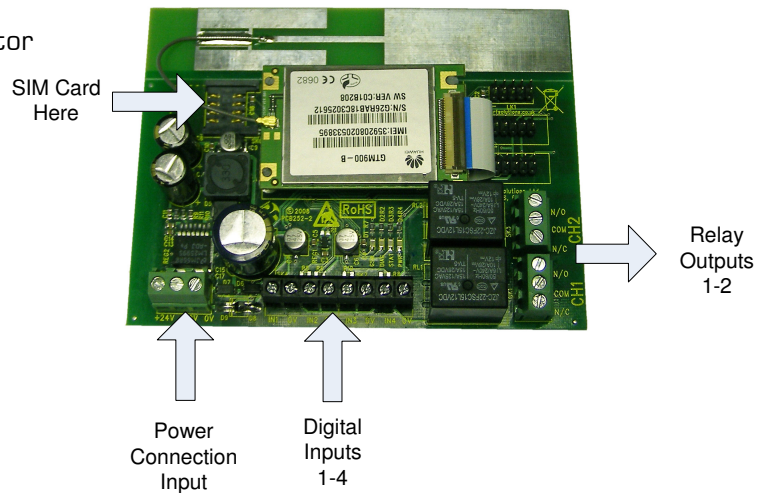

PROTEXT DIN Features

- External Antenna connector via UFL connector
 - 2 x Relay outputs on board
 - 8 Outputs using Relay Module
- (These simply plug and play no additional connections required)

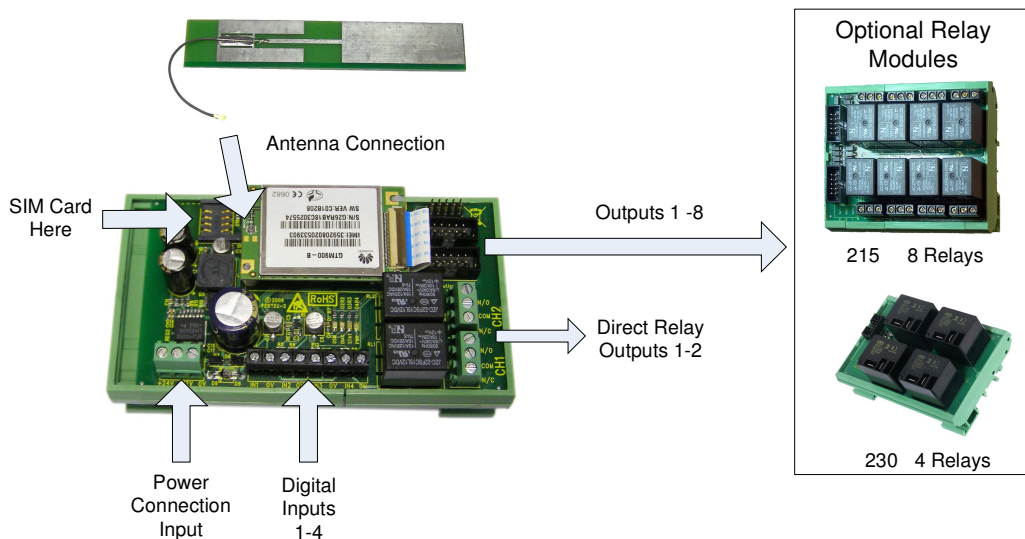



PROTEXT - GSM REMOTE CONTROL

SIM card

The unit will accept SIM cards of most types subject to the following restrictions.

1. Only 3 Volt SIM cards will be correctly read and older 5 Volt types will be ignored.
2. The message memory of the SIM card should be clear before it is fitted to the PROTEXT unit.
3. SIM cards that have been protected by means of a PIN (in a mobile phone) will not operate in the unit.
4. Some types of pay-as-you-go SIM cards may require regular call activity (once every six months) to remain registered.
5. It is recommended to bar Incoming voice calls to the SIM card before it is used in the PROTEXT unit to avoid any error messages being sent back to the user. This can be achieved by calling the service provider.

The SIM card should be inserted into PROTEXT before applying power

RF Solutions recommends O2 and Videophone SIM card and has carried out extensive testing using the SIM cards we have for these two networks.

Problems have been identified with Orange SIM cards with this product.

No guarantee can be given for the operation of this product with any network except those that have been tested by RF Solutions.

Power Connections

The PROTEXT unit can be powered from 12 or 24Vdc, a mains power supply is also available. Power is connected via the Power Screw Terminal

Input Connections and Output Relays

The four inputs are provided via screw terminals

0V/IN1
0V/IN2
0V/IN3
0V/IN4

These are volt-free digital inputs are designed to be actuated by contact 'switch' closures across the input pins.

Two relay outputs are provided on PROTEXT and PROTEXT-DIN, which provide a 'switch' output as below.

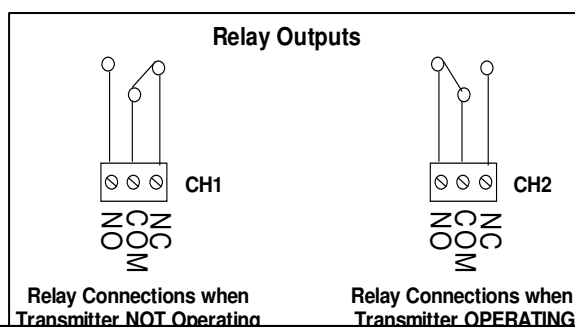
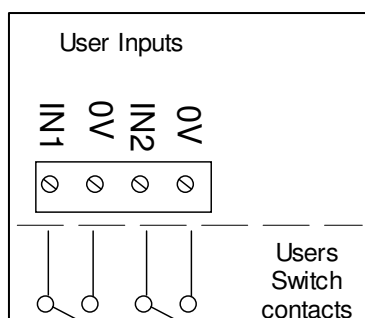



PROTEXT - GSM REMOTE CONTROL

PROTEXT-DIN can also provide a further six additional outputs by using the Relay Modules which connect directly to the PROTEXT-DIN.



Signal Strength / LED Indication

There are four LEDs on the circuit board. The Green LED indicates power is applied
The three Red LEDs indicate the status of PROTEXT as below

During Initialisation After Power UP	
RED LED Action	Description
LED's illuminate alternately	PROTEXT is undergoing power up initialisation (can take many seconds)
All LED's flash together	No Simcard present

Normal Operation	
RED LED Action	Description
No LEDs	No signal
One LED on Steady	Low signal strength
Two LEDs on Steady	Medium signal strength
Three LEDs on Steady	High signal strength

When Transmitting or Receiving a TEXT	
RED LED Action	Description
One LED Flashing	PROTEXT is Receiving an SMS
TWO LED's Flashing	PROTEXT is transmitting an SMS

Power Loss

The PROTEXT has a facility to text a specific number when power fails. This number will be notified once power is re-applied to the PROTEXT after failure.
In the event of power loss to the PROTEXT the unit will maintain the user configured data entered during the User set-up sequence, as this information is stored in non-volatile memory. However the status of the relays will be lost.

Wall Mounting

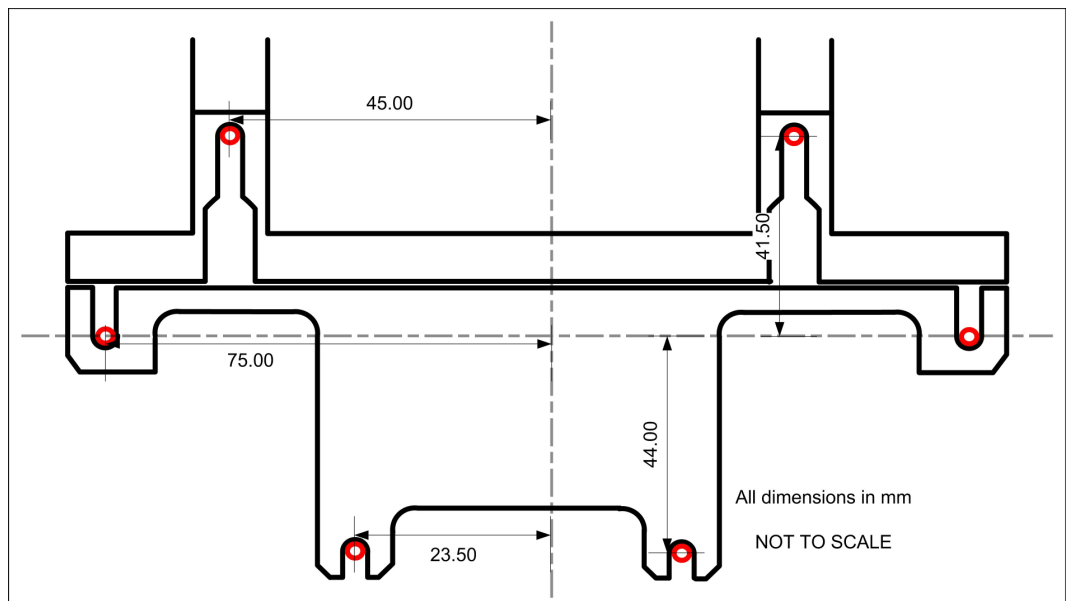

3. Optional Power Supply

- Sealed Unit to IP67
- Resin Potted Unit
- Input 100-240Vac
- Output 12Vdc 1A
- Miniature Size 83 x 37 x 30mm
- 2.1mm Female Jack
- Wall Fixing Lugs
- Supplied with 3.3m lead

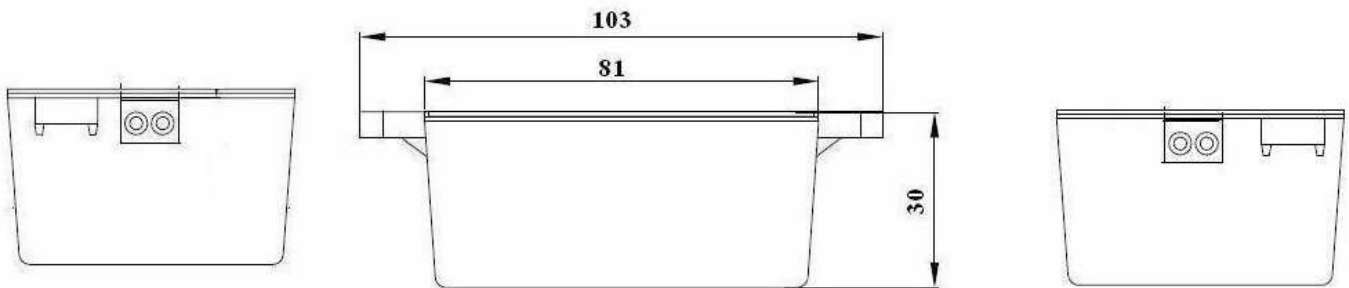

All dimensions are in mm

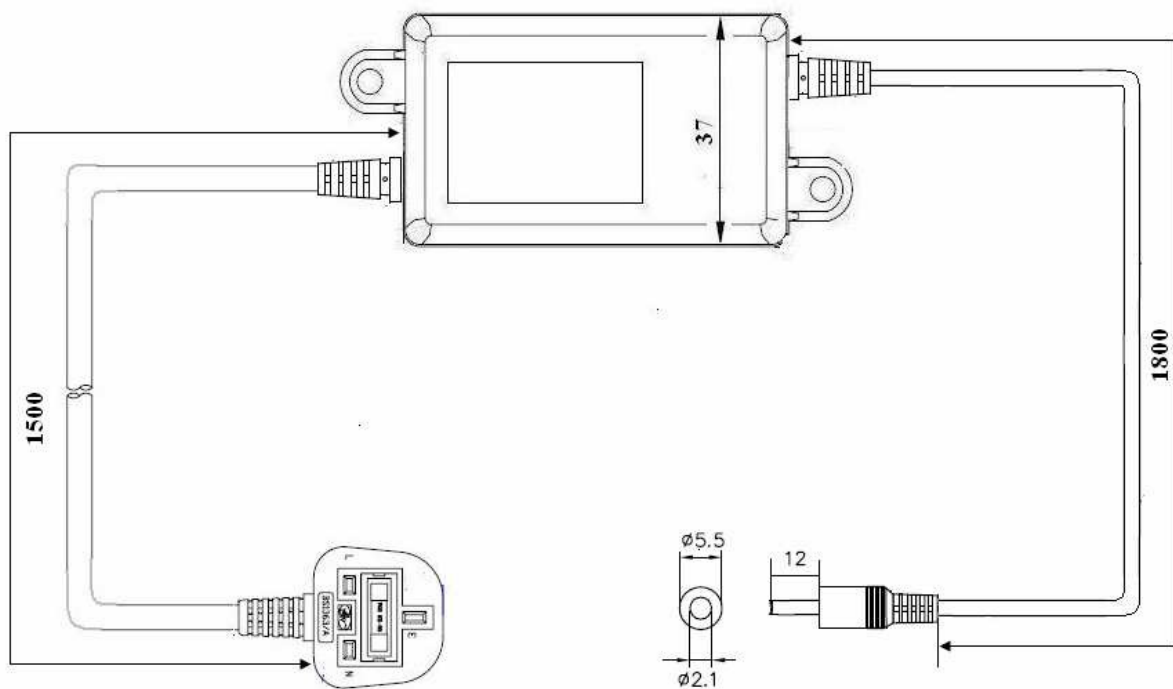

Part No	Description
PSU12V1AIN-IP	Power Supply 110-240Vac input, 12Vdc 1A Output IP67

4. PROTEXT-DIN Optional Modules

215 Relay Output Module

- 8 relay switches rated 230Vac at 5A
- Each relay provides 'input' and 'normally open' screw terminals
- Connect 215, RLY1-4 to PROTEXT LK3 & RLY5-8 to PROTEXT LK2

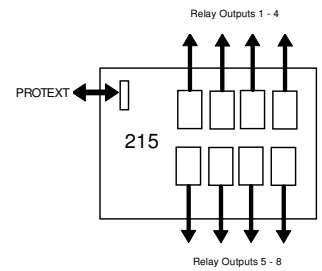
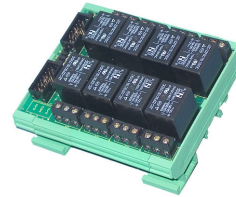

Dimensions: Within DIN Rail: 93 x 82 mm (PCB: 90 x 72mm)

Storage Temperature: -10 to +70° Celsius.

Operating Temperature: 0 to +55° Celsius.

Electrical Characteristics	Min	Typical	Max	Units
Supply Voltage	From PROTEXT-DIN			
Relay* output Rating Type KB12	Max rating is 3A/220VAC/30VDC			

*The relay contacts in this unit are for functional use only and must not be used for isolation purposes

230 Relay Output Module

- 4 relay (type K7SFA12) outputs rated for up to 30A at 230Vac.
- Each relay provides 'input' and 'normally open' Spade Terminals.
- Connect 230, J1 to PROTEXT LK3

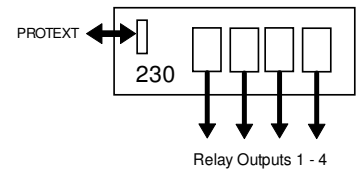

Dimensions: Within DIN Rail: 115 x 82 mm (PCB: 109 x 72mm)

Storage Temperature: -10 to +70° Celsius.

Operating Temperature: 0 to +55° Celsius.

Electrical Characteristics	Min	Typical	Max	Units
Supply Voltage	From PROTEXT-DIN			
Relay output Rating @ 230Vac*			30	A
@ 12Vdc			20	A

*The relay contacts in this unit are for functional use only and must not be used for isolation purposes

Enclosure c/w Mains Power Supply

- IP56 Insulation Class 2
- DIN Rails mounted on Steel Plate
- 12Vdc 1A PSU incorporated accepts 110-240Vac (5A Fused)

Dimensions

External	315 x 235 x 130mm
Internal	300 x 220 x 120mm
DIN Rail length 1	285mm
DIN Rail length 2	180mm

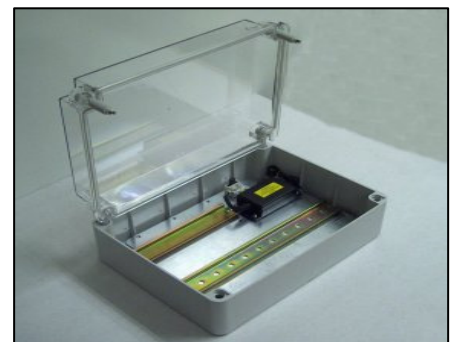

Part No	Description
ENC-DA3	DIN Rail Enclosure Assembly, Two Mounting Rails, 12Vdc PSU Fitted

5. Extending the Antenna

C20 is supplied with an internal integrated antenna. For low signal areas this may be removed and an external antenna fitted. The following products are available as optional extras.

Please Note: Fitting the bulkhead connector in the enclosure will mean that the enclosure is no longer IP68! Additional water sealing will be required if the unit is exposed.

CBA-UFLSMA-1

This cable which replaces the on-board cable connecting directly onto the GSM engine and provides a bulkhead SMA connector which may be fitted to the enclosure



External Mount Gain Antenna

GSM20-ANT

Magnetic mount type
Gain 3db
VSWR < 1.5:1
Height ~ 236 mm (including magnetic base)
Cable : Coax Type RG-174U length 2.5m

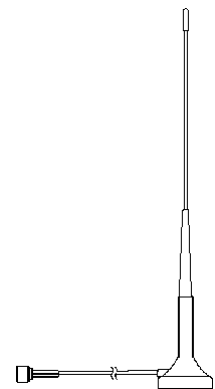

ANT-GSMPUKS

GSM Screw Mount 3m coax SMA(M)
Low Profile Package
World-Wide Use
+2dBi Gain
Rugged Screw Fix connector
3metres Cable



ANT-GSMSTUB3

GSM Stubby +3dB Mag Mount SMA(M)
Active gain: +3dBi
Omni directional
3m Connecting Lead

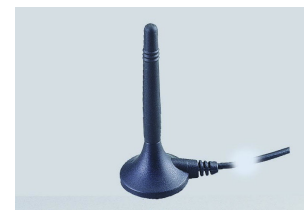

ANT-GSM5WM

GSM DB +5dB Wall Mount SMA(M)
Wall Mount Whip Antenna
900 / 1800MHz
Active gain: +5dB





PROTEXT - GSM REMOTE CONTROL

6. User Set-Up Commands

Definitions

The following definitions are used throughout this document and generally in connection with PROTEXT.

Message An SMS ('text') message sent from one mobile station to another.
~ Denotes a 'space' in the message.

Alphanumeric. Characters in the range A to Z (upper and lower case), numbers in the range 0 – 9.

Mobile. A mobile telephone that is used to send and receive SMS messages.

User Set-Up of PROTEXT

Note that the **User Password is case sensitive** but the commands are not case sensitive and will be converted into upper case before the unit handles them. This means that any user command responses, which echo the original command will do so in upper case.



PROTEXT - GSM REMOTE CONTROL

Command	Description	Command Syntax	Example
Unit Password (UPW)	<p>The User Password can be an alphanumeric string containing from 5 to 10 characters.</p> <p>Selection of the UPW must be completed within 5 minutes from power applied. Setting the UPW is carried out by sending a text message to the unit.</p> <p>If for any reason the unit password is lost the user must remove all power to the unit for 1 minute, then start the process of entering a UPW again.</p>	UPW~<UNIT PW>	Command: UPW~Password123456 Response: UPW~OK
Unit Identity (UID) <i>(Optional)</i>	<p>The <UNIT ID> is an alphanumeric string consisting 4 to 10 characters.</p> <p>This sets the 'identity' of the PROTEXT unit, and is included in any response to from PROTEXT so that the user can identify the PROTEXT.</p>	<UNIT PW>~UID~<UNIT ID>	Command: Password123456~UID~Identity7 Response: Identity7~UID~OK
Input number-to-text (INUM) <i>(Optional)</i>	<p>This command sets the mobile number that the SMS Text message is sent to when input is changed. The number must be in full international format including country code and leading zeros.</p> <p>Note the country code for the United Kingdom is 44.</p> <p>Note the PROTEXT can store up to 5 mobile numbers per input.</p>	<UNIT PW>~INUMn~<num to text> n=1 for input 1 n=2 for input 2 n=3 for input 3 n=4 for input 4	Command: Password123456~INUM1~0033612345678 Response: Identity7~INUM1~0033612345678~OK This example selects a French mobile (country code 33) with national number 06 12 34 56 78 (leading 0 omitted), this number will be text if IN1 changes state.



PROTEXT - GSM REMOTE CONTROL

User Setup Commands cont...

PLEASE NOTE: ~ denotes a 'space' in the format of a message

Command	Description	Command Syntax	Example
Power Failure number-to-text (PNUM) <i>(Optional)</i>	This command is used to identify the mobile number which is to be text if power has been removed and re-applied to the PROTEXT. PNUM can store up to 5 mobile numbers.	<code><UNIT PW>~PNUMn~ <number to text></code>	Command: Password123456~PNUM~0033612345678
Deleting numbers-to-text	If either of INUMn or PNUM contain a mobile number that is already present in the phone number list then this number will be deleted. After deletion a text will be sent to the user to confirm the deletion of that number.	<code><UNIT PW>~x~<num to text></code> Where x represents either INUMn or PNUM	Command: Password123456~PNUM~0033612345678 Response: UID~PNUM~<0033612345678>~deleted
Response on/off (RESPONSE)	This command is used to control the responses that are to be sent from PROTEXT following receipt and carrying out of a command. NOTE: messages which specifically demand a response such as requests for input status will always be responded to as will the UPW, UID and RESP~OFF messages. The default setting is for response to be turned off.	<code><UNIT PW>~RESPONSE~x</code> x=ON or OFF	Command: Password123456~RESPONSE~ON Response: Identity7~RESPONSE~ON~OK



PROTEXT - GSM REMOTE CONTROL

User Setup Commands cont...

PLEASE NOTE: ~ denotes a 'space' in the format of a message

Command	Description	Command Syntax	Example
Output delay time (ODEL)	<p>This command sets an activation time of the relay outputs. The default is to remain on following an ON command and turn off following an OFF command.</p> <p>If 't' is set to a value from 1 to 9 then this sets the number of seconds for which the output remains on after an ON command. The OFF command is then ignored. If 't' is set to '0', then the output returns to default setting</p>	<p><UNIT PW>~ODELn~t</p> <p>n=Relay number t=Delay time (seconds)</p>	<p>Command: Password123456~ODEL1~7</p> <p>Response: Identity7~ODEL1~7~OK</p>

Combining Set-Up Commands into one SMS Text

In order to reduce the number of text messages to be sent when setting up, several commands may be combined together within a single Text message sent to PROTEXT.

Any commands may be sent together, (the limit being that a text message can only be 160characters in total). Each command is separated by a ,
Commands Excluded from Multiple messages are : initial setting of password. Status Request

Command Syntax <UNIT PW>~Command1, Command2, Command3, Command4,.....

Example In the following example the text message sends the following commands in one text, (the Password is 'Password123456')

- Input Number3 to Text the number '01273 898000'
- Output1 identity to be 'Sprayer'

Text to be sent: < Password1234>~UID~<GATWICK>,~INUM3~<01273898000>, OSTRING1 Sprayer

Response GATWICK~INUM3~<01273898000>~OSTRING1~Sprayer





PROTEXT - GSM REMOTE CONTROL

7. Control Commands

PLEASE NOTE: ~ denotes a 'space' in the format of a message

Command	Description	Command Syntax	Example
Report GSM Signal Strength (SIGQ)	This command is used to check and report the GSM signal strength Where 'Level' = 'POOR' (in this case consider adding an external antenna or re-siting the PROTEXT) 'OK' 'Good' 'Excellent'	<UNIT PW> ~SIGQ	Example: Password1234~SIGQ Response Identity7~SIGQ~Good
Activate and deactivate outputs (OUT)	This command is used to turn a relay output on or off.	<UNIT PW> ~OUTn~x n=Relay number = 1 to 8 x=Relay Status = ON, OFF	Command: Password123456~OUT1~ON Response: Identity7~OUT1~ON~OK
Retrieve status of inputs and outputs (STATUS)	This command requests that the status of the inputs and outputs be returned to this caller.	<UNIT PW> ~STATUS	Command: Password123456~STATUS Response: Identity7~IN1ON~IN2OFF~OUT1ON~OUT2ON
Retrieve unit settings (SETTINGS)	This command requests that the settings of the unit be returned to the caller.	<UNIT PW> ~SETTINGS	Command: Password123456~SETTINGS Response: Identity7~SETTINGS~ODEL1~2~ODEL2~0



PROTEXT - GSM REMOTE CONTROL

Control Commands Cont...

PLEASE NOTE: ~ denotes a 'space' in the format of a message

<p>Customising input names <i>(ISTRING)</i></p>	<p>The <ISTRING> is an alphanumeric string consisting of up to 15 characters.</p> <p>This string of characters sets the custom input name. For example if input 1 is a detector on a door then input 1 can be assigned the name DOOR.</p>	<p><UNIT PW>~ISTRINGn~name</p> <p>n=Input number to assign to. name=Custom name to assign.</p>	<p>Command: Password123456~ISTRING1~AIRCON</p> <p>Response: Identity7~ISTRING1~AIRCON~OK</p>
<p>Customising output names <i>(OSTRING)</i></p>	<p>The <OSTRING> is an alphanumeric string consisting of up to 15 characters.</p> <p>This string of characters sets the custom name for outgoing data. For example if output 1 is used to open/close a vent then output 1 can be assigned the name VENT.</p>	<p><UNIT PW>~OSTRINGn~name</p> <p>n=Output number to assign to. name=Custom name to assign.</p>	<p>Command: Password123456~OSTRING1~AIRCON</p> <p>Response: Identity7~OSTRING1~AIRCON~OK</p>
<p>Activate and deactivate outputs using custom names <i>(OUT)</i></p>	<p>This command is used to turn a relay on or off using its custom name</p>	<p><UNIT PW>~name~x</p> <p>n=Relay number = 1 or 2 x=Relay Status = ON, OFF name=Custom name</p>	<p>Command: Password123456~AIRCON~ON</p> <p>Response: Identity7~AIRCON~ON~OK</p>



PROTEXT - GSM REMOTE CONTROL

Control Commands Cont...

PLEASE NOTE: ~ denotes a 'space' in the format of a message

<p>Retrieve saved numbers to text for INUMn</p>	<p>This command requests the mobile phone numbers for inputs 1 to 4 (INUMn) to be returned to this caller.</p>	<p><UNIT PW>~ SETTINGS~INUMn</p> <p>Where n=1 for input 1 n=2 for input 2 n=3 for input 3 n=4 for input 4</p>	<p>Command: Password123456~settings~INUM1</p> <p>Where n=1 for input1</p> <p>Response: <UNIT ID>~SETTINGS~INUM1~<numbers to text></p> <p>For example: Identity7~SETTINGS~INUM1~00331245577 84</p>
<p>Retrieve saved numbers to text for PNUM</p>	<p>This command requests the mobile phone numbers to text in the event of power failure to be returned to this caller.</p>	<p><UNIT PW>~ SETTINGS~PNUM</p>	<p>Command: Password123456~settings~PNUM</p> <p>Response: <UNIT ID>~SETTINGS~PNUM1~<numbers to text></p> <p>For example: Identity7~SETTINGS~PNUM1~00331245577 84</p>





PROTEXT - GSM REMOTE CONTROL

8. Messages generated by PROTEXT

PLEASE NOTE: ~ Denotes a 'space' in the format of a message

Message	Description	Message Syntax	Example
Change Of Status Of Inputs (IN)	<p>This message reports a change of input state to the designated mobile number (set using the INUM command). A message is sent with the following format.</p> <p>A change of input will only be 'valid' after 5mSecs Where the PROTEXT unit is processing an SMS messages then the response time could be up to 250mS.</p>	<p><UNIT ID>~INn~x</p> <p>n=input channel = 1 or 2 x=input status=ON or OFF</p>	Identity7~IN1~ON
Error in received message (!!ERROR!!)	<p>When an incoming SMS contains an error in the message format, no action will be taken by the unit other than to send an error message back to the calling mobile along with a copy of the erroneous message itself.</p>	<p><UNIT ID>~m~!!ERROR!!</p> <p>m=Your Message Returned</p>	Identity7~UPW~OUTn~OFF~!!ERROR!!
Text user after power reset: (FAILED)	<p>Texts will be sent to mobile phone numbers stored in PNUM on reboot after a power failure or reset (when power is reapplied).</p> <p><i>Note this feature is enabled or disabled by simply either having mobile phone numbers in PNUM or not.</i></p>	<p><UNIT ID>~</p> <p>Reboot~power~had~failed</p>	Identity7~Reboot~power~had~failed





PROTEXT - GSM REMOTE CONTROL

9. Advanced Input Commands

PLEASE NOTE: ~ denotes a 'space' in the format of a message

Command	Description	Command Syntax	Example
Setting a Time delay on Input (INUMDLY)	<p>This command is used to delay PROTEXT sending a text message when and input is activated. This command sets the starting number delay counter (Max 65535). When the input is activated the counter starts to down-count in seconds. When the delay counter reaches zero, providing the input is still activated the text message will be sent.</p>	<p><UNIT PW>~INUMDLY1~xxxxx</p> <p>Where 'xxxxx' is a number from 0 to 65535</p>	<p>Command: Password1234~INUMDLY1 60 Response UID~INUMDLY1~60~OK</p>
Setting Input Pulse Counts (INUMCNT)	<p>This command is used to set the number of times an input must be activated before PROTEXT sends a text message. An example is where you want to receive a text message only after an input has been triggered 5 times. This command also resets the counter to the original value</p>	<p><UNIT PW>~INUMCNT1~xxxxx</p> <p>Where 'xxxxx' is a number from 0 to 65535</p>	<p>Command: Password1234~INUMCNT3 44332 Response UID~INUMCNT3~44332~OK</p> <p>Now the Input 3 will only send a text message after the input has been triggered 44332 times.</p>
Reporting the value of the Input Pulse Counter (INUMCNTVAL)	<p>This command reports the current number in the Pulse counter</p>	<p><UNIT PW>~INUMCNTVAL1</p>	<p>Example: Password1234~INUMCNTVAL3 Response UID~INUMCNTVAL3=yyyyy~OK</p> <p>Where yyyyy is the current value of the input pulse timer counter</p>



PROTEXT - GSM REMOTE CONTROL

<p>RF Solutions Ltd RECYCLING NOTICE rfsolutions.co.uk Meets the following EC Directives</p> 
<p>DO NOT Discard with normal waste, please recycle.</p>
<p>ROHS Directive 2002/95/EC Specifies certain limits for hazardous substances.</p>
<p>WEEE Directive 2002/96/EC Waste Electrical & Electronic Equipment. This product must be disposed of through a licensed WEEE collection point. RF Solutions Ltd fulfills its WEEE obligations by membership of an approved compliance scheme. <u>Environment Agency producer registration number WEE-IP0104WV</u></p>
<p>Waste Batteries and Accumulators Directive 2006/66/EC Where batteries are fitted, before recycling the product, the batteries must be removed and disposed of at a licensed collection point.</p>

*RF Solutions Ltd.,
Unit 21, Cliffe Industrial Estate,
Lewes, E. Sussex. BN8 6JL. England.*

Email : sales@rfsolutions.co.uk <http://www.rfsolutions.co.uk>

Tel: +44 (0)1273 898 000 Fax: +44 (0)1273 480 661

Information contained in this document is believed to be accurate, however no representation or warranty is given and no liability is assumed by R.F. Solutions Ltd. with respect to the accuracy of such information. Use of R.F.Solutions as critical components in life support systems is not authorised except with express written approval from R.F.Solutions Ltd.