

Operating Instructions

Sartorius ME and SE Series

ME and SE Models from 2005 and Later
Electronic Analytical and Semi-microbalances

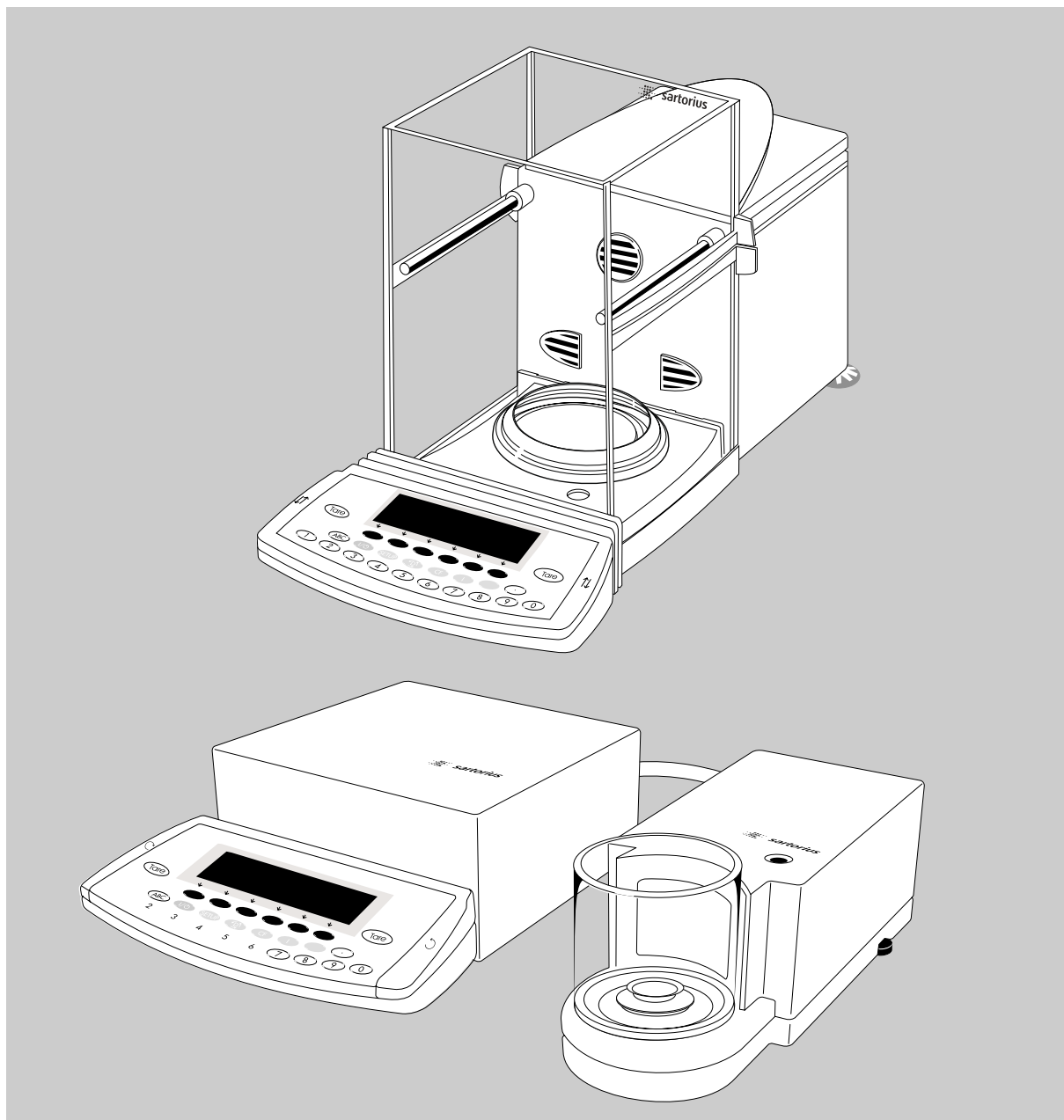

Intended Use

ME and SE models are high-resolution balances of special accuracy for extremely precise measurement of mass. These series cover a range from 0.001 mg to 610 g.

A broad range of special performance features makes the ME and SE balances ideal for use as measuring and test equipment in ISO or GLP quality management systems. These features include:

- The fully automatic self-calibrating and adjustment function, isoCAL (time- and temperature-dependent)
- reproTEST for quick determination of the standard deviation to check the repeatability of results
- ISO/GLP-compliant recording capability for printouts
- Password-protected menu lock
- Display of maintenance | service intervals when due

ME and SE balances meet the highest requirements placed on the accuracy and reliability of weighing results through the following features:

- Efficient filtering-out of vibration
- Fully automatic draft shield with three motorized, self-teaching draft shield elements and soft-touch technology
- Stable and repeatable results
- Excellent readability under any lighting conditions
- Rugged design and durable weighing system

ME215/235/254/414/614:

- Integrated static electricity eliminator feature to neutralize interfering electrostatic charges (ionizer)

ME and SE balances save work and speed up both simple and complex routine applications through:

- Ultrafast response times

Built-in application programs; application level 1:

- Second weight unit
- Counting
- Weighing in percent
- Animal weighing
- Recalculation
- Calculation
- Density determination
- Differential weighing
- Air buoyancy correction
- Air density determination for ME5, SE2

Application level 2:

- Checkweighing
- Time-controlled functions

Application level 3:

- Totalizing
- Formulation
- Statistics

with the following additional functions:

- Second tare memory
- Identification codes
- Product data memory
- SQmin function
- Manual data storage in application level 3
- DKD uncertainty of measurement
- Automatic initialization when you switch on the balance
- Easy input of IDs for samples or other weighed objects
- If requested: control using an external computer

Symbols

The following symbols are used in these instructions:

- indicates steps you must perform
- indicates steps you must perform only under certain conditions
- > describes what happens after you have performed a certain step
- indicates an item in a list
-  indicates a hazard

Conventions Used in These Operating Instructions:

- The pictures in these Operating Instructions are based on the ME215S model. On other models, some display readouts and printouts may differ slightly from the ones shown. This will be explained in cases where this is important for operation of the balance.

Hotline:

For advice on the use of applications, just call or fax your local Sartorius office. For the address, please visit our Internet website at: www.sartorius.com

Contents

2	Intended Use	107	Extra Functions
3	Contents	107	Second Tare Memory
4	Warning and Safety Instructions	109	Individual Identification Codes
5	General Views of the Balances	113	Saving Values Manually in M+
7	Operating Design	114	Changing the Resolution
11	Getting Started	116	Product Data Memory
11	Storage and Shipping Conditions	118	SQmin Function
11	Unpacking the Balance	120	DKD Uncertainty of Measurement
11	Carrying the Balance	122	Combining Applications
11	Equipment Supplied	123	Practical Combination of Several Applications (Example)
12	Installation Instructions	125	Data Output Functions
12	Remote Operation of the Display and Control Unit	127	Interfaces
14	Connecting the Balance to AC Power	130	Printouts
15	Warmup Time	134	Serial Communications Port
16	Leveling the Balance	139	Pin Assignment Charts
17	Configuring the Balance	140	Cabling Diagram
17	Selecting the Language	141	Error Codes and Messages
18	Navigating in the Setup Menu	144	Care and Maintenance
19	Entering the Time and Date	145	Recycling
20	Setting the Balance Functions	146	Overview
23	Setting the Device Parameters	146	Specifications
23	Entering a Password	152	Accessories (Options)
27	Setting the Application Parameters	153	Dimensions (Scale Drawing)
36	Selecting the Printout Function	155	Declarations of Conformity
38	Printout Configuration	158	EC Type-Approval Certificate
40	Device Information	160	Plates and Markings
40	Factory Settings	162	Index
41	Operating the Balance		Appendix
41	Basic Weighing Function		Entering the General Password
41	General Instructions for “Analytical Weighing”		Brief Instructions
42	Below-Balance Weighing		
45	Device Parameters		
45	Opening and Closing the Draft Shield		
47	Static Electricity Eliminator (Ionizer)		
49	Calibration, Adjustment, Linearization		
59	Repeatability Test		
60	Application Programs		
61	Toggle between Two Weight Units		
63	Counting		
66	Weighing in Percent		
69	Calculation		
72	Density Determination		
77	Differential Weighing		
89	Air Buoyancy Correction		
96	Diameter Determination		
99	Time-Controlled Functions		
102	Statistics		

Warning and Safety Instructions

This balance complies with the European Council Directives as well as international regulations and standards for electrical equipment, electromagnetic compatibility, and the stipulated safety requirements. Improper use or handling, however, can result in damage and/or injury.

Read these operating instructions thoroughly before using your balance to prevent damage to the equipment. Keep these instructions in a safe place.

Follow the instructions below to ensure safe and trouble-free operation of your balance:



Do not operate in a hazardous area/location



Make sure that the voltage rating printed on the AC adapter is identical to your local line voltage



If you use electrical equipment in installations and under ambient conditions requiring higher safety standards, you must comply with the provisions as specified in the applicable regulations for installation in your country.

- The only way to switch the power off completely is to disconnect the AC adapter
- The balance housing is protected against the penetration of solid objects with a diameter of more than 2.5 mm (such as accumulated dust) and dripping water falling vertically (IP32) – the housing is not completely dust- and leak-tight, however
- Protect the AC adapter from contact with liquid
- Note on Installation:
The operator shall be responsible for any modifications to Sartorius equipment and for any connections of cables or equipment not supplied by Sartorius and must check and, if necessary, correct these modifications and connections. On request, Sartorius will provide information on the minimum operating specifications (in accordance with the Standards listed above for defined immunity to interference).
- Connect only Sartorius accessories and options, as these are optimally designed for use with your balance

When cleaning your balance, make sure that no liquid enters the balance housing; use only a slightly moistened cloth to clean the balance.

Do not open the balance housing. If the seal is broken, this will result in forfeiture of all claims under the manufacturer's warranty.

In case you have any trouble with your balance:

- contact your local Sartorius office, dealer or service center

General Views of the Balance

Models ME215/235/254/414/614

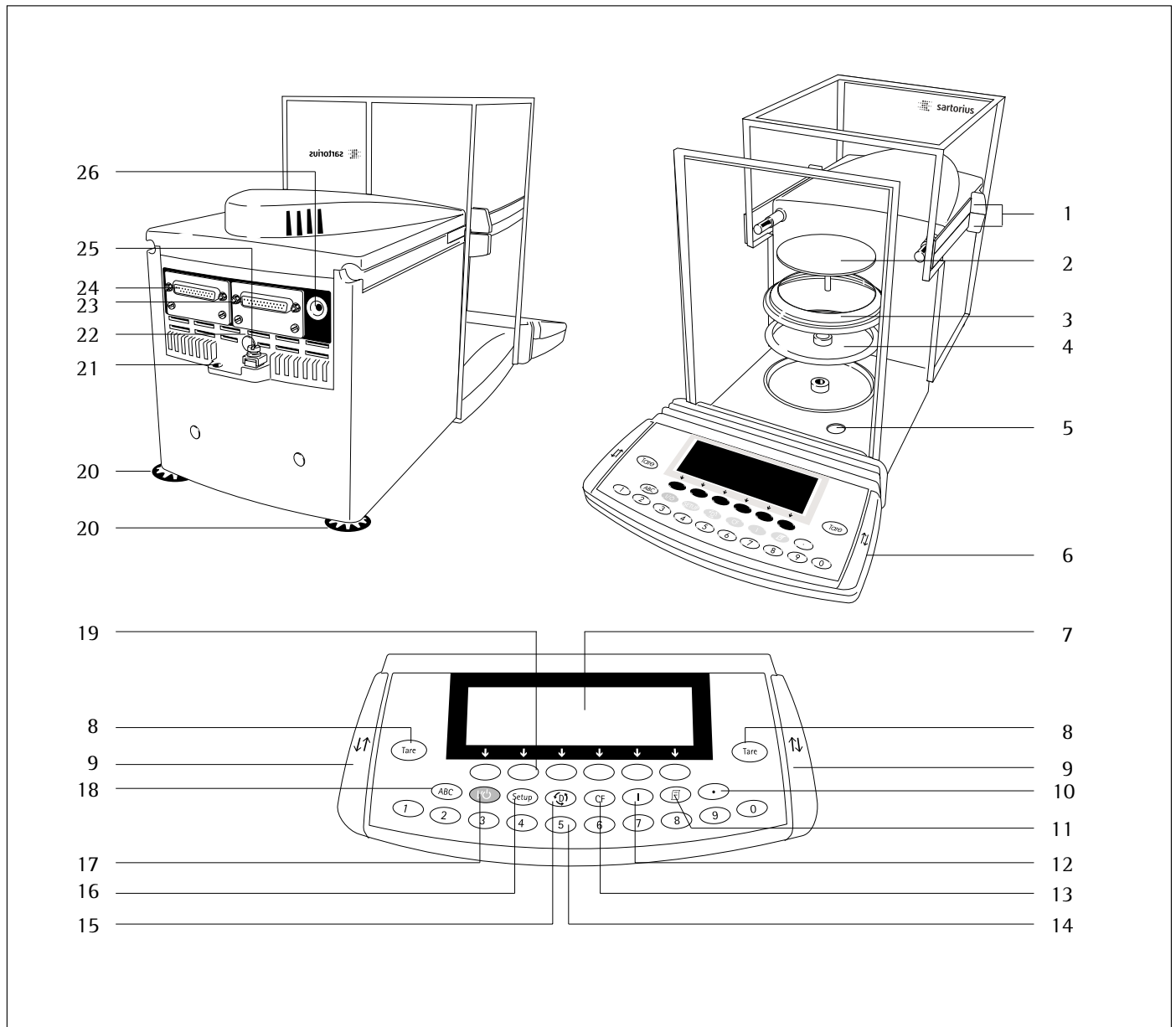

Pos. Designation	Spare Part Order No.	Pos. Designation	Spare Part Order No.
1 Draft shield door grips		17 On/off key	
2 Weighing pan	69 ME0001	18 Toggle key for alphabetic input	
3 Shield disk (ME235S/P only)		19 Function keys	
4 Shield plate	69 ME0002	20 Leveling foot	69MA0091
5 Level indicator		21 Lug for attaching antitheft locking device	
6 Operating panel		22 Menu access switch	
7 Display		23 Serial printer port (PRINTER)	
8 Tare key		24 Serial communications port (PERIPHERALS)	
9 Key for opening/closing draft shield	69ME0007 (set of small parts)	25 Terminal for connecting an equipotential bonding conductor	
10 Decimal point key		26 DC jack	
11 Print key		Not shown:	
12 Ionizer on/off key		Set of dust covers	6960ME01
13 CF key (clear function)		Set of small parts (operating panel)	69ME0007
14 Numeric keys		Set of caps	69ME0008
15 Toggle key for changing the application program			
16 Setup key for configuring the balance			

General Views of the Balance

Models ME5 and SE2

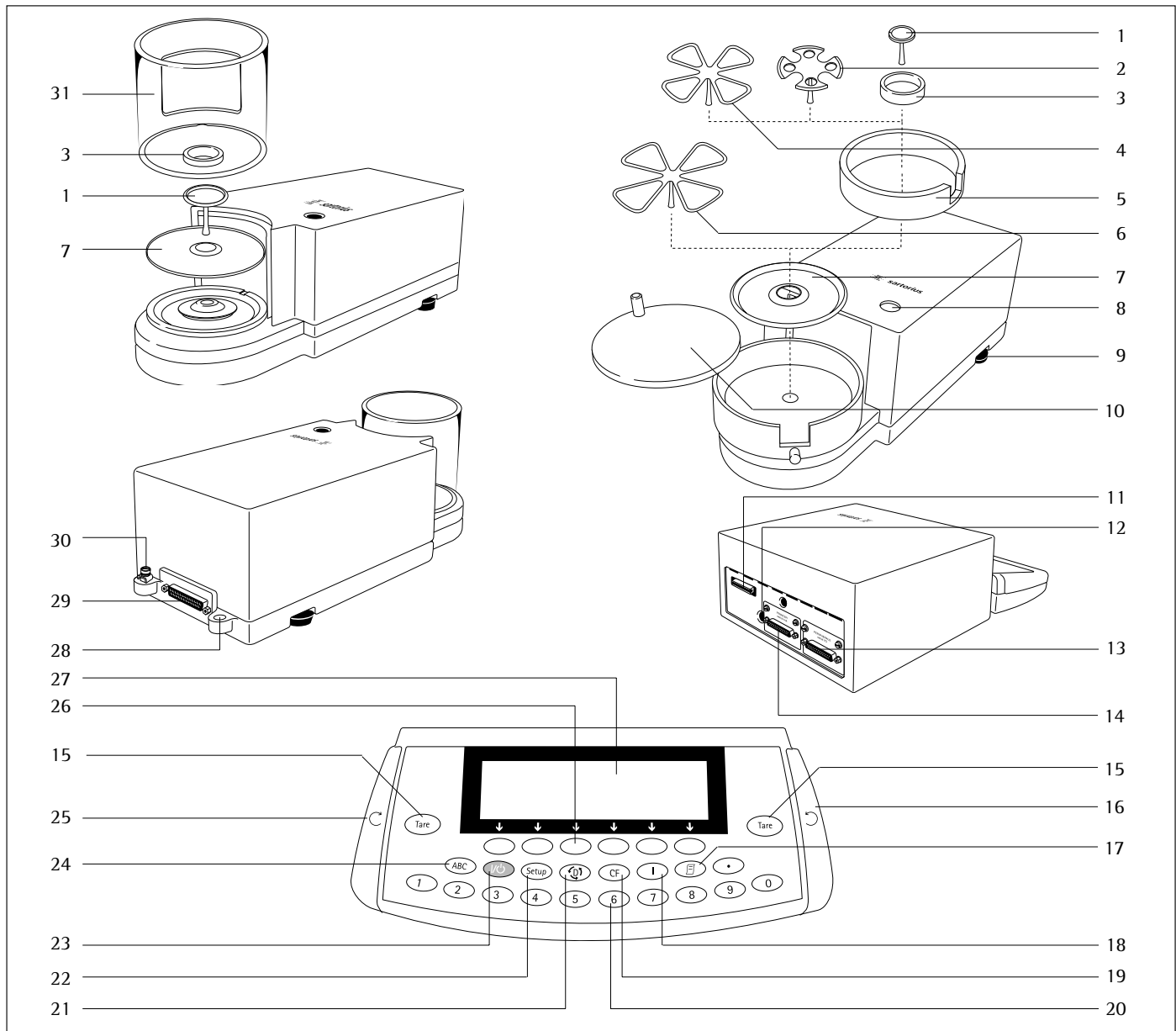

Pos. Designation

- 1 Weighing pan
- 2 Filter pan, 50 mm Ø
- 3 Interior draft shield (only for SE2)
- 4 Optional filter pan, 75 mm Ø
- 5 Shield ring
- 6 Optional filter pan, 90 mm Ø
- 7 Shield disk
- 8 Level indicator
- 9 Leveling foot
- 10 Draft shield cover
- 11 Female connector for weigh cell
- 12 DC jack for AC power
- 13 Communications port (PERIPHERALS)
- 14 Printer port (PRINTER)
- 15 Tare key

Pos. Designation

- 16 Key for opening the draft shield counterclockwise
- 17 Print key
- 18 Info key for displaying device information
- 19 CF key (clear function)
- 20 Numeric keys
- 21 Toggle key for changing to the next application program
- 22 Key for accessing Setup mode (settings)
- 23 On/off key
- 24 Toggle key for alphanumeric input
- 25 Key for opening the draft shield clockwise
- 26 Function keys
- 27 Display
- 28 Lug for attaching antitheft locking device
- 29 Female connector for evaluation unit
- 30 Terminal for connecting an equipotential bonding conductor
- 31 Draft shield

Operating Design

The balance consists of a weighing cell, a draft shield and a display and control unit. In addition to the choice of power supply, via AC adapter or external rechargeable battery pack, your balance also has interface ports for connecting additional devices, such as a printer, computer, or universal remote control switch, etc.

The display and control unit is fastened to the weighing cell. Operation of the balance follows a uniform “philosophy,” which is described in this manual.

Where not expressly indicated otherwise, the uses described in this manual apply to verified balance versions (indicated by the suffix “-.0CE” in the model number), as well as the standard version.

Combination of Several Applications

You can combine the use of various application programs to meet your more complicated requirements.





To select application programs one after the other, press  (toggle function).

Keys









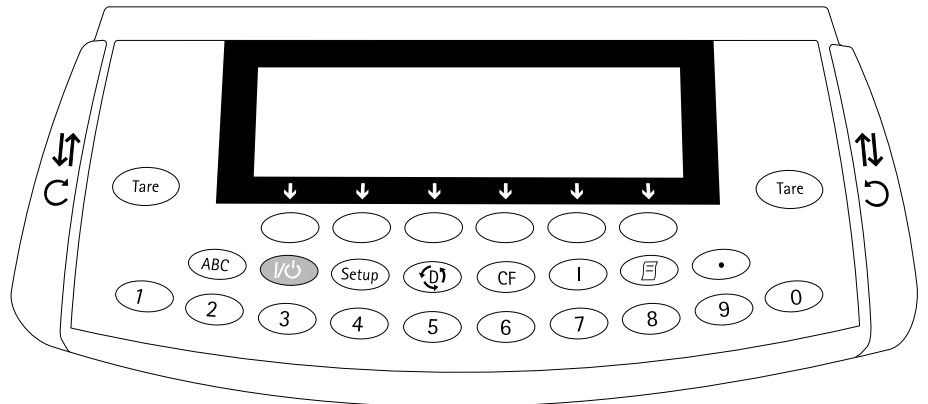

You can operate the balance either by using the keys on the display and control unit or from an on-line PC. This manual describes operation using the balance keys.

Labeled Keys

These keys always have the function indicated by their label, but are not available at all times. Availability of their functions depends on the current operating status of the balance and the menu settings.





- | Meaning |
|---|
|  Alphabetic keys
Please see section on “Text Input” |
|  On off key
Turns the balance on and off or switches it to the standby mode |
|  Menu settings
Accesses and exits the Setup menu |
|  Toggles to the next application program |
|  Clear function
Deletes keypad input
Interrupts a calibration and adjustment routine in progress
Quits application programs |



-  ME215/235/254/414/614:
Turns the ionizer on and off
-  ME5, SE2:
Displays device information
-  Print key
Outputs displayed values or data logs to the serial communications and | or printer port
-  Enters a decimal point
-    keys
See the section on “Numeric Input”
-  Tares the balance
-    Opens | closes the draft shield

Numeric Input





To enter numbers: press

 ...   

To store numbers entered: press the corresponding function key directly below the soft key label

To delete an entire numeric input digit by digit: press the  key

Text Input

- To enter numbers:
see the section on “Numeric Input”
- To enter letters or characters:
press the  key
- > Letters are displayed in the bottom line for selection
- To select a different letter:
press the corresponding soft key to change the letter shown
- To select the letter | character shown:
press the corresponding function key below the soft key label
- > The selected letter is shown on the display
- Enter the next letter | character, if desired, as described above
- To exit the letter input mode (e.g., if the last character entered is a letter): press the  key
- To store a word: press the corresponding function key (soft key), such as ID
- To delete an input character by character:
press the  key
- To delete user data: enter  or a space and save

Operating Design

Function Keys (Soft Keys)

The current function of soft keys is indicated in the bottom line of the display (footer).

Texts (abbreviations) or symbols can be displayed.

Texts (Examples)

C a l: Start calibration | adjustment
S I D: Save ID

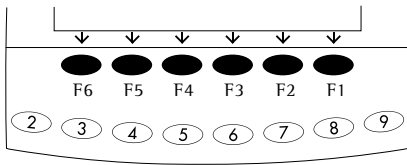

The function keys are numbered from right (F1) to left (F6).

Symbols

The bottom line shows the following symbols:

- ◀ Back to the initial state
(in the Setup menu: exit Setup)
- ◀ Go to the higher selection level
- Show sub-items under the active item
- ⤴ Move upward in the input | output window
- ⤵ Move downward in the input | output window
- ⤴ Set the selected menu parameter

There are basically two different types of displays:

- display for weights and calculated values
- display for menu parameter settings (Setup)

Operation

Display for Weights and Calculated Values

This display is subdivided into 9 areas.

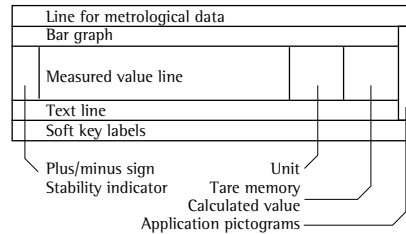

Line for Metrological Data:

When the balance is used in legal metrology, the following metrological specifications of the balance are shown here:

- Max** Maximum capacity (upper range limit) of the balance
- Min** Minimum capacity (lower range limit) of the balance
- e** Verification scale interval
- d** Readability | scale interval

On standard balances, only **Max** and **d** are displayed.

Bar Graph:

The bar graph indicates how much of the balance's capacity is "used up" by the current load; during checkweighing, it indicates the control limits.

The following symbols may be displayed:

- 0% Lower load limit
- 100% Upper load limit
- ▬ Bar graph showing 10% intervals
- Minimum for checkweighing
- = Target for checkweighing
- + Maximum for checkweighing

Plus/Minus Sign, Stability Symbol:

A plus or minus sign (+ or -) is shown here for a weight (or a calculated value, such as that for counting), or the \square symbol indicating that a verified balance has been zeroed or tared.

Line for Measured Values:

This area shows the weighed or calculated value and the alphanumeric input.

Unit and Stability:

When the balance reaches stability, the weight unit or calculated unit is displayed here.

When the \triangle symbol is displayed here, the value indicated in the readout cannot be used in legal metrology.

Tare Memory, Calculated Values:

The symbols displayed here indicate when there is a value in one of the tare memories or when the value shown is a result of calculation rather than direct measurement.

These symbols are as follows:

 Calculated value

NET1 Net value | tare memory

NET2 used by an application program (e.g., formulation, second tare memory)

Application Pictograms:

The pictograms displayed here indicate the application(s) selected. The pictogram is displayed inversely (white on a black background) when the corresponding application is active.

For example, the following symbols may be displayed simultaneously:

 The counting application is active

 Checkweighing is also active

 Print

 Data record

Text Line:

Additional information is displayed here (e.g., operator guidance prompts, name of the active program, etc.)

Soft Key Labels:

The current functions of the soft keys above the function keys (arrow keys) are indicated here; during calibration | adjustment, this line shows up- and down-arrows (↕ and ↘) for selecting calibration and adjustment functions.

Display for Menu Parameter Settings (Setup)

This display is divided into three sections.

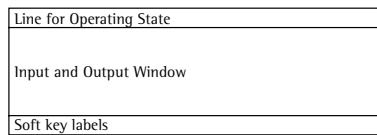

Status Line:

The status line of shows the function of the display screen page. In the Setup menu, the current menu “path” is shown here.

Setup Menu Example: “Balance/scale functions”:

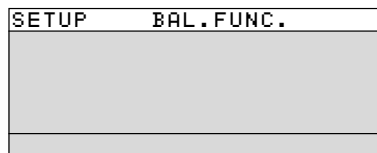

Input and Output Window

This window contains either detailed information (e.g., on the active application) or a pick list. A selected item is displayed inversely (white characters on a black background). You can also enter information in an active field in this window using the alphabetic and numeric keys.

Setup Menu Example,

“Device parameters, Adapt filter”:

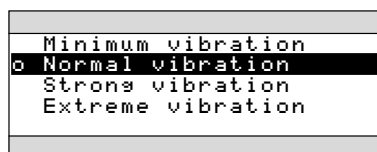

The following symbol may be displayed in the input and output window:

-  this symbol marks the saved menu setting

Soft Key Labels

See the description “Function Keys (Soft Keys)” on the previous page

To set a parameter:

- Press the ↕ or ↘ soft key repeatedly until the desired setting is selected (displayed inversely)

- Confirm your selection: press the ↵ soft key

To change the numeric value of a parameter:

- Press the ↕ or ↘ soft key repeatedly, if necessary, until the desired setting is selected (displayed inversely)

- Enter a new value or character: use the 0 1 ... 9 . keys or the ABC key and enter the desired letters

- Confirm your selection: press the ↵ soft key

To exit Setup: press the << soft key

Input



Bar Code Scanner or Keyboard Input

You can use a bar code scanner or an external keyboard to input alphanumeric values. These inputs are processed in the same manner as keypad inputs on the display and control unit of the balance. Bar code and keyboard inputs are only displayed; they cannot activate any function.

To assign a bar code scanner or keyboard input to a function, press one of the following soft keys:

- Lot
- Samples
- Measured values
- Sample number
- Tare value
- Initial weight
- Backweighed value
- Sample ID

Foot or Hand Switch Input

You can connect a foot switch or a hand switch to the balance to have this device perform a keypad function (such as  or .

PC Input

You can use a computer to control the functions of the balance and display and control unit via the communications port (see the “Data Output Function” section in the chapter entitled “Operating the Balance”).

Data Output

The balance provides two interface ports for outputting weights, calculated values and parameter settings:

- Serial communications port (PERIPHERALS – Serial I/O)
- Serial printer port (PRINTER – Serial Out)

Serial Printer Port

In addition to Sartorius printers (such as the YD003-OCE), you also have the choice of connecting a remote display or an external checkweighing display to the printer port.

You can configure the data output functions in the Setup menu to meet your various requirements, including ISO | GLP requirements.

ISO: International Organization for Standardization

GLP: Good Laboratory Practice

You can have printouts generated automatically, or by pressing ; generation can be dependent on or independent of the stability or time parameters.

See the section on “Data Output Functions” in the chapter entitled “Operating the Balance” for a detailed description.

Serial Communications Port

You can connect a PC, a remote display, an external checkweighing display or a standard (non-verifiable) printer to this port.

Request messages are sent via the interface to initiate functions in the weighing cell and in the display and control unit. Some of the functions generate response messages.

See the section on “Data Output Functions” in the chapter entitled “Operating the Balance” for a detailed description.

Error Codes

If you press a key that has no function, or which is blocked at a certain point in an application program, this error is indicated as follows:

- a double beep is sounded as an acoustic signal if the key has no function
- a double beep is sounded and the message “No function” is displayed in the text line if the key function is not available at that time

The response to an operator error is identical in all operating modes. See the chapter entitled “Error Codes” for a detailed description.

Storing Settings

Saving Parameter Settings

The settings configured remain stored in the balance’s non-volatile memory. In addition, you can reload the factory settings.

Saving Settings

Under “Setup > Device parameters > password” you can assign passwords in order to block access to:

- Balance | scale functions
- Device parameters
- Application parameters
- Printout
- Factory settings

Getting Started

Storage and Shipping Conditions

Allowable storage temperature: +5 ...+40°C | +41 ... +104°F

The packaging has been designed to ensure that the balance will not be damaged even if it is dropped from a height of 80 centimeters (about 32 inches). Do not expose the balance to extreme temperatures, jolts, impact, vibration or moisture.

Unpacking the Balance

- After unpacking the balance, check it immediately for any visible damage as a result of rough handling during shipment
- If this is the case, proceed as directed in the chapter entitled “Care and Maintenance,” under the section on “Safety Inspection”

It is a good idea to save the box and all parts of the packaging until you have successfully installed your balance. Only the original packaging provides the best protection for shipment. Before packing your balance, unplug all connected cables to prevent damage. The strip of cardboard between the display and control unit and the weighing platform is important for protecting the equipment during shipment!

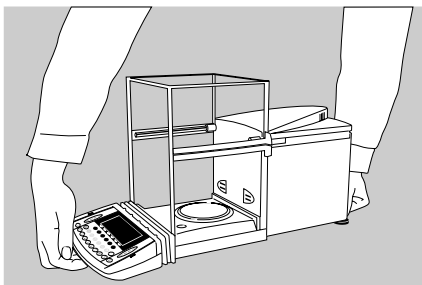

Carrying the Balance

- To carry the balance, use one hand to support display unit in the front and the other hand to support the balance housing in the back

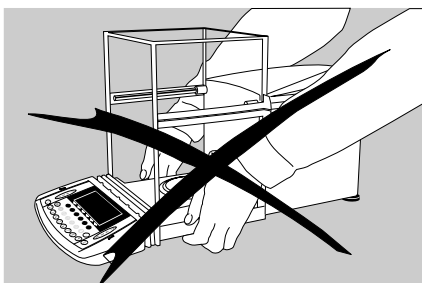

Do not lift the balance by the shield

Equipment Supplied

The following individual components are supplied:

- | | |
|---|--|
| ME215/235/254/414/614 | ME5-F, SE2-F |
| - Balance | - Weigh cell |
| - AC adapter with power cord | - Draft shield cover |
| - Weighing pan with hanger for below-balance weighing | - Shield ring |
| - Shield disk | - Electronic evaluation unit |
| - Dust cover for the balance housing | - Connecting cable |
| - Dust cover for the display and control unit | - AC adapter with power cord |
| - Instruction manual | - Accessories kit |
| ME5, SE2 | The accessories kit includes: |
| - Weigh cell | - Filter pan, 50 mm Ø |
| - Draft shield | - Weighing pan |
| - Electronic evaluation unit | - Shield disk |
| - Connecting cable | - Interior draft shield (only for SE2) |
| - AC adapter with power cord | - Brush |
| - Accessories kit | - Forceps |
| | - Cloth |

The accessories kit includes:

- Weighing pan
- Shield disk
- Interior draft shield (only for SE2)
- Brush
- Forceps
- Cloth

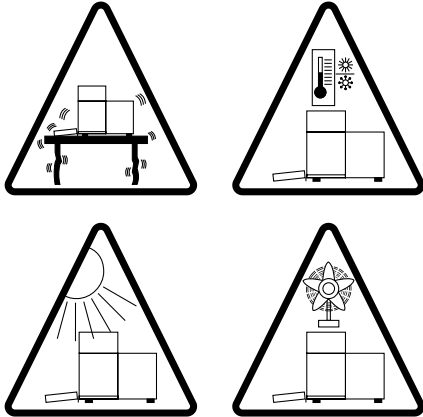

Installation Instructions

The ME/SE balances are designed to provide reliable weighing results under normal ambient conditions in the laboratory and in industry. Choose the right location to set up your balance by observing the following so that you will be able to work with added speed and accuracy:

- Set up the balance on a completely even surface on a low-vibration balance table or wall console
- Avoid placing the balance in close proximity to a heater or otherwise exposing the balance to heat or direct sunlight, as this can considerably increase the temperature inside the draft shield (greenhouse effect), resulting in incorrect readouts due to convection currents, turbulence and buoyancy effects.
- Protect the balance from drafts that come from open windows or doors
- Avoid brief fluctuations in room temperature
- Protect the balance from aggressive chemical vapors
- Do not expose the balance to extreme moisture

Linearization after Transport

After transporting the balance, its linearity may be outside the allowable tolerances (please refer to the “Specifications” in the “Overview” chapter). After transporting the balance, be sure to perform internal linearization. Repeat this process to obtain optimal accuracy. For directions on this procedure, please refer to the section on “Linearization.”

Conditioning the Balance

Moisture in the air can condense on the surfaces of a cold balance whenever it is brought into a substantially warmer place. If you transfer the balance to a warmer area, make sure to condition it for about 2 hours at room temperature, leaving it unplugged from AC power. Afterwards, if you keep the balance connected to AC power, the continuous positive difference in temperature between the inside of the balance and the outside will practically rule out the effects of moisture condensation.

Setting Up the Balance ME215/235/254/414/614

- Place the components listed below inside the weighing chamber in the order given:
 - Shield plate
 - Position the weighing pan and turn to the left or right until it snaps into place
 - Shield disk (ME235S/P only)
- Note: the shield disk minimizes the effects of drafts within the weighing chamber

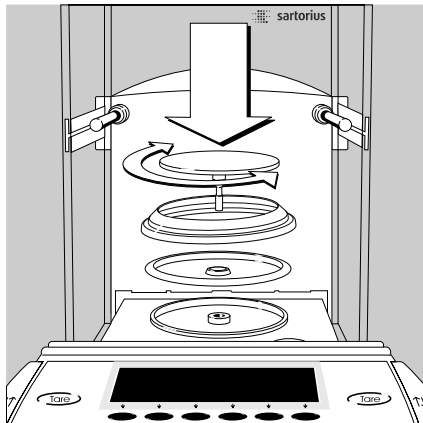

Remote Operation of the Display and Control Unit

- Unplug the cables, turn the balance on its side and lay it on a padded surface to avoid damaging the weighing system and draft shield
 - Use an Allen wrench to remove the three fastening screws
 - Remove the display unit and attach the connecting cable
- > Length of the connecting cable: 44 cm (17 inches)
- For information on longer cables, please see the “Accessories” section
 - If you wish to use a longer cable, it must be installed by authorized Sartorius service technicians

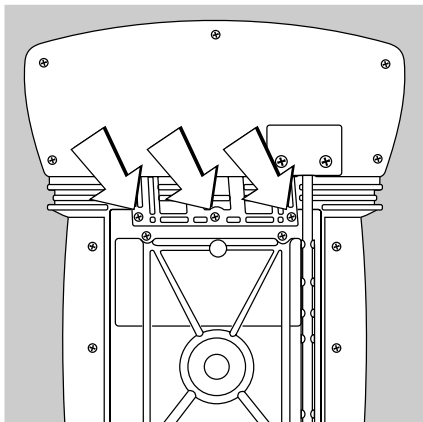

ME5, SE2:

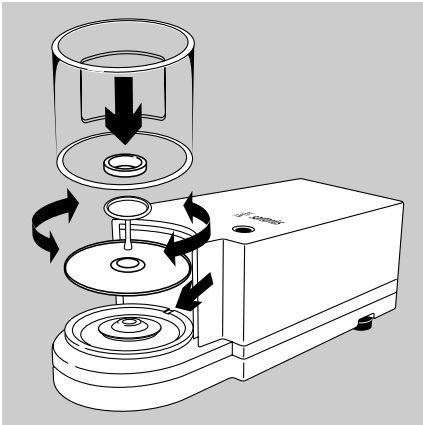

Setting Up the ME5 or SE2 Balance

- Place the components below on the weigh cell base in the order given:
 - Shield disk
 - Weighing pan
Please note: after placing the weighing pan on the base, turn the pan slightly towards the left then the right while pressing down on it to lock.
 - Interior draft shield (only for SE2)
 - Draft shield: center the hole over the pan (see arrows)

ME5-F, SE2-F:

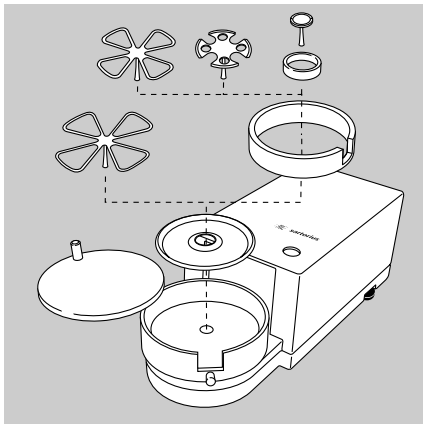

Setting Up the ME5-F or SE2-F Balance

- Place the components below on the weigh cell base in the order given:
 - Shield disk
 - Interior draft shield ring
 - 50 mm dia. filter pan or weighing pan (or, optionally, the 75 or 90 mm dia. filter pan)
Please note: after placing the pan on the base, turn the pan slightly towards the left then the right while pressing down on it to lock
 - Interior draft shield (only for SE2)

⚠ If the weighing pan is removed during operation, turn the balance off and then on again after you return it to the balance.

- Draft shield cover

Setting Up the Filter Balance for Left-handed Persons:

- Remove the draft shield cover
- Detach the pin on the right and re-attach on the left

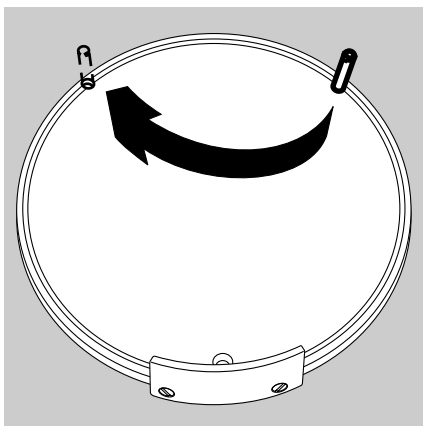

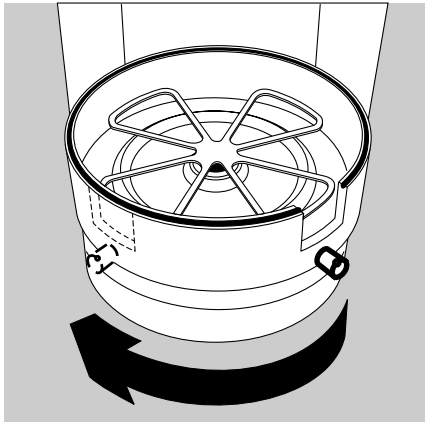

- Turn draft shield assembly by approx. 90 degrees toward the left (loosen knurled knob to turn)

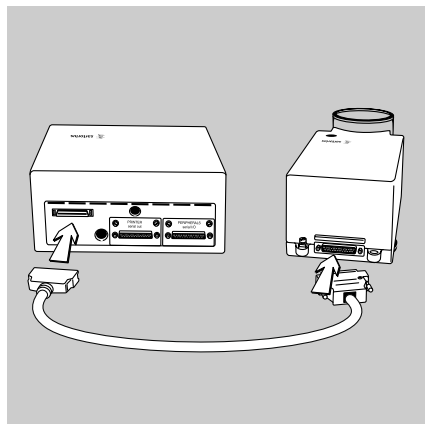

- **Connect the weigh cell to the evaluation unit**
 - Use a screwdriver to tighten the screws to the female connector on the weigh cell

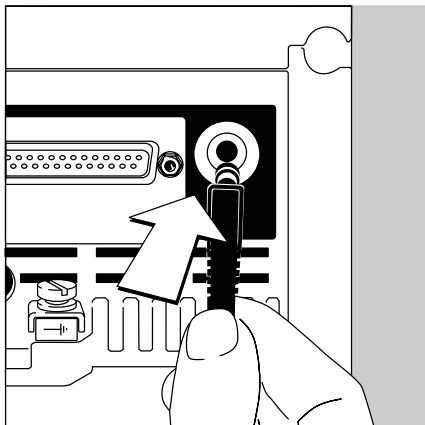

Connecting the Balance to AC Power

The wide-range AC adapter is designed for 100 V to 240 V.

- Check the plug design of the power cord
 - If it does not fit your wall outlet (mains supply), please contact your Sartorius office or dealer
- Use only
 - Original Sartorius AC adapters and power cords
 - AC adapters with a registered approval rating from a national testing laboratory
- To use a main feeder cable from the ceiling or to mount a CEE plug, have a certified electrician install it
- To use an external rechargeable battery pack, refer to the “Accessories” in the “Overview” chapter
- Insert the AC adapter plug with the angle facing downward into the jack on the balance

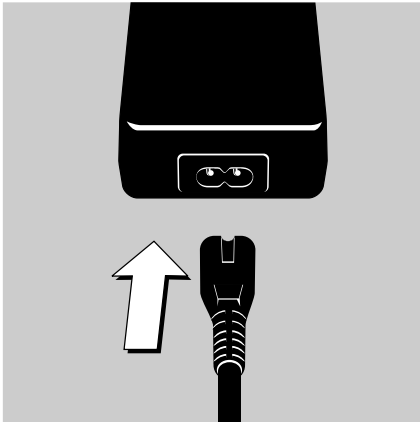

- Plug power cord into the AC adapter
- To power the balance with AC current, plug the power cord into a wall outlet (mains supply)

Charging the Rechargeable Battery for Saving Data:

All data is saved in the battery-backed memory. When initially operating the balance, leave it connected to AC power for one day to charge the battery. When the balance is disconnected from AC power, the balance-generated data will remain stored for approximately three months. In the standby mode, data is retained in the memory via the power supply. Be sure to print out data before storing your balance for a relatively long period.

Safety Precautions

The AC adapter rated to Class 2 can be plugged into any wall outlet without requiring any additional safety precautions. The ground or earth terminal is connected to the scale housing, which can be additionally grounded, if required. The data interface is also electrically connected to the balance housing (ground).

Note:

This equipment has been tested and found to comply with the limits for a Class A digital device, pursuant to Part 15 of the FCC rules. These limits are designed to provide reasonable protection against harmful interference when the equipment is operated in a commercial environment. This equipment generates, uses and can radiate radio frequency energy and, if not installed and used in accordance with the instruction manual, may cause harmful interference to radio communications. Operation of this equipment in a residential area is likely to cause harmful interference in which case the user will be required to correct the interference at his own expense. Changes or modifications not expressly approved by Sartorius AG could void the user's authority to operate the equipment.

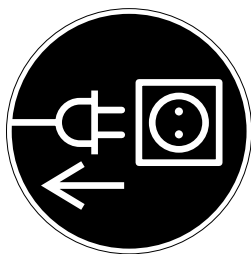

Connecting Electronic Peripheral Devices

- Make absolutely sure to unplug the balance from AC power before you connect or disconnect a peripheral device (printer or PC) to or from an interface port

Warmup Time

Each time you move your balance to another location, you must condition it for at least 12 hours to the new location. To deliver exact results, the balance must warm up for at least 12 hours after initial connection to AC power. Only after this time will the balance have reached the required operating temperature.

Using Balances Verified as Legal Measuring Instruments in the EU*:

- The balance must warm up for at least 24 hours after initial connection to AC power
- Warmup time each time power is turned on the ME614S-OCE, ME414S-OCE: at least 30 minutes
- Always wait for the power-on adjustment routine to be completed: for requirements see page 57.

* including the Signatories of the Agreement on the European Economic Area

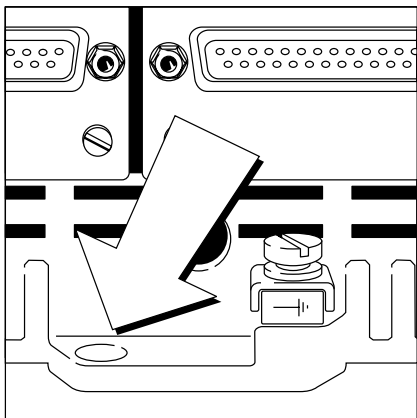

Antitheft Locking Device

To fasten an antitheft locking device, use the lug located on the rear panel of the balance.

- Secure the balance at the place of installation, e.g., with a chain or a lock

ME215/235/254/414/614:

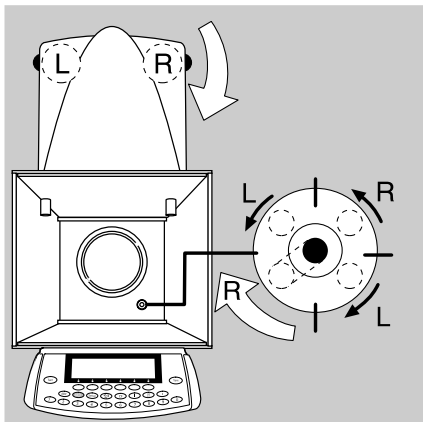

Leveling the Balance

Purpose:

- To compensate for unevenness at the place of installation
- To achieve perfectly horizontal positioning of the balance for consistent repeatability of the weighing results

Always level the balance again any time it has been moved.

Only the 2 front feet are used for leveling.

- Turn the leveling feet as shown in the diagram until the air bubble is centered exactly within the circle of the level indicator
- > Several leveling steps are usually required

MES, SE2:

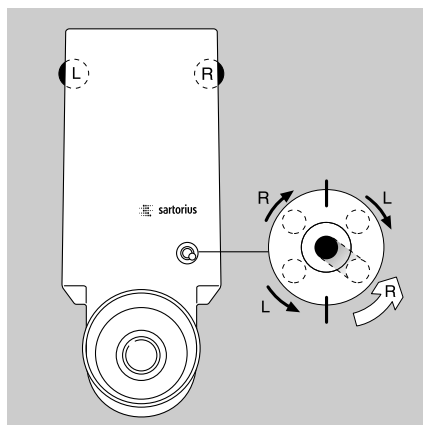

Setting the Language

- > See the section on “Setting the Language” in the chapter “Configuring the Balance”

Setting the Date and Time

- > See the example on page 17, in the chapter “Configuring the Balance”

Configuring the Balance

Purpose

You can configure your ME/SE balance to meet individual requirements by entering user data and setting parameters in the Setup menu.

The Setup menu is divided into the following items:



- Balance/scale functions
- Device parameters
- Application parameters
- Printout
- Device information
- Language
- Factory settings

Setting the Language

You can choose from 5 languages for the information display:

- German
- English (factory setting)
- English with U.S. date | time format
- French
- Italian
- Spanish

Example: Selecting the Language "U.S. Mode"

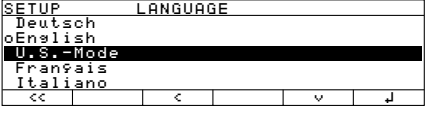
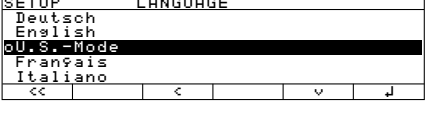
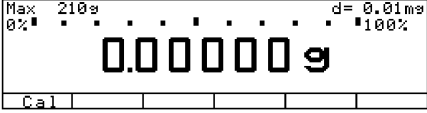
Step	Press key(s) (or follow instructions)	Display Printout
1. Select "Setup" menu		
2. Select "Language" and confirm	Repeatedly press \downarrow soft key, then \rightarrow soft key	
3. Select "U.S. mode"	\downarrow soft key	
4. Save language	\downarrow soft key	
5. Exit the Setup menu	$\leftarrow \leftarrow$ soft key	

Navigating in the Setup Menu (Examples):

Example: Adapt the balance to “Extreme vibration” by selecting this setting

Step	Press key(s) (or follow instructions)	Display Printout
1. Select Setup menu		<pre> SETUP Balance/scale functions Device parameters Application parameters Printout Info << v >> </pre>
2. Confirm “Balance/scale functions”	> soft key	<pre> SETUP BAL.FUNC. Calibration/adjustment Adapt filter Application filter Stability range Taring << v >> </pre>
3. Select menu item “Adapt filter” and confirm	v soft key, then > soft key	<pre> SETUP BAL.FUNC. ADAPT FILT. Minimum vibration oNormal vibration Strong vibration Extreme vibration << v j </pre>
4. Select menu item “Extreme vibration”	v soft key	<pre> SETUP BAL.FUNC. ADAPT FILT. Minimum vibration oNormal vibration Strong vibration Extreme vibration << v j </pre>
5. Confirm menu item “Extreme vibration”	j soft key	<pre> SETUP BAL.FUNC. ADAPT FILT. Minimum vibration Normal vibration Strong vibration oExtreme vibration << v j </pre>
6. If required, select further menu items	v ^ soft keys	
7. Save setting and exit Setup menu	<< soft key	

Exiting the Setup Menu

If you use the << soft key:

- The software will be restarted if you have changed a setting.
 - The software will not be restarted if you have kept the same settings.
- In this case, the program will return to its initial state before you press the  key.

If you press the  key:

- When you exit , the software is generally restarted.

Example: Entering the time and date

Step	Press key(s) (or follow instructions)	Display Printout
1. Select Setup menu; select "Device parameters"	(Setup), then ⏏ and ⏏ soft keys	<pre> SETUP DEVICE Draft shield Ionizer* Password User ID Clock << < v > </pre>
2. Set clock	press ⏏ repeatedly, then press ⏏	<pre> SETUP DEVICE CLOCK Time: Date: 14.07.42 12.09.97 << < ^ > </pre>
3. Enter the time	1 1 . 1 2 · 3 0	<pre> SETUP DEVICE CLOCK Time: Date: 11.12.30 12.09.97 ESC ↓ </pre>
4. Set the time according to your local clock	↓ soft key	<pre> SETUP DEVICE CLOCK Time: Date: 11.15.16 13.08.00 << < ^ > </pre>
5. Enter the date	1 3 . 0 3 · 0 0	
6. Store the date	↓ soft key	
7. Enter other data, if desired	⏏ ^ soft keys	
8. Exit Setup menu	<< soft key	

* = not on ME5, SE2

Setting the Balance Functions (BAL.FUNC.)

Purpose

This menu item enables you to configure the balance functions, i.e., to meet individual requirements by selecting predefined parameters in the Setup menu. You can block access to the menu by assigning a password.

Features

The balance functions are combined in the following groups (1st menu level):

- Calibration | adjustment
 - Adapt filter
 - Application filter
 - Stability range
 - Taring
 - Auto zero
 - Weight unit 1
 - Display accuracy 1
 - Tare/zero with power on
 - Factory settings: only wgh. param. (only the balance functions)
- For legal metrology, the selection of individual parameters is limited.

Factory Settings

Parameters: The factory settings are identified by the symbol "o" in the list starting on page 21.

Preparation

Show available balance functions:

- Select Setup menu: press the  key

> SETUP is displayed

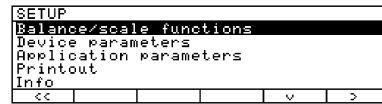

- Select "Balance functions": press the \rightarrow soft key

If you already assigned a password:

> The password prompt is displayed

- If access is blocked by a password: enter the password using the numeric | alphabetic keys
- If the last character of the password is a letter: conclude input by pressing 

- Confirm your password and have the balance functions displayed: Press the \downarrow soft key

> Balance functions are displayed:

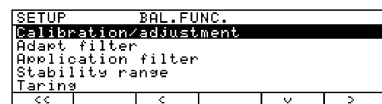

- To select the next group: press the \downarrow soft key (down arrow)
- To select the previous item of a group: press the \uparrow soft key (up arrow)
- To select the next sub-item within a group: press the \rightarrow soft key (right arrow)
- To select the previous group: press the \leftarrow soft key (left arrow)
- To confirm: press the \downarrow soft key

Extra Functions

- Exit the Setup menu: press the $\leftarrow \leftarrow$ soft key
- > Restart your application
- Print parameter settings:
 - When the balance functions are displayed, press 
- > Printout (example)
 - Texts with more than 20 characters are cut off

SETUP

BAL.FUNC.

```

-----
Calibration/adjustm
CAL/isoTST key fun
Selection mode
Cal/adjustment seq
Calibrate, then auto
adjust
isoCAL function
On without resetting
app.
Start automatic ad
isoCAL
Print GLP/GMP adju
Automatic if GLP is
selected
Parameter for exte
Wt. ID (W ID):

Cal./adj. wt:
200.00000 g
Adapt filter
Normal vibration
Application filter
Final readout
Stability range
2 digits

Auto zero
On
Weight unit 1
Grams /g
Display accuracy 1
All digits
-----
    
```

Balance Functions (Overview)

- o factory setting
- √ user-defined setting(s)

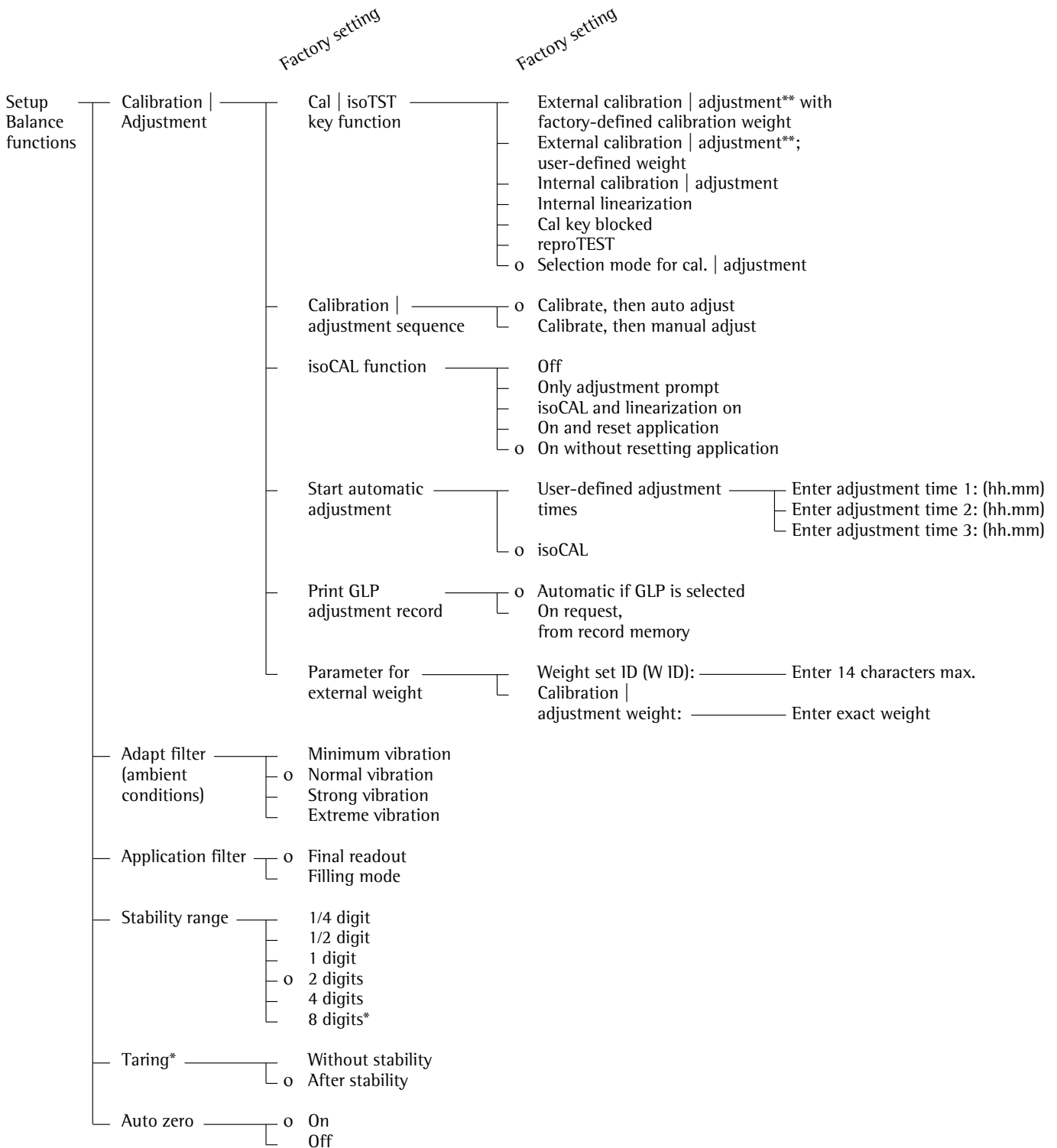

* = not applicable to verified balances
 ** = only external calibration is possible for verified balances

Factory setting

Setup – Balance functions	Weight unit 1	o	Grams g
			Kilograms kg*
			Carats ct
			Pounds lb*
			Ounces oz*
			Troy ounces ozt*
			Hong Kong tael tlh*
			Singapore tael tls*
			Taiwanese tael tlt*
			Grains GN*
			Pennyweights dwt*
		#	Milligrams mg
			Parts per pound lb*
			Chinese tael tlc*
			Momme mom*
			Austrian carats K*
			Tola tol*
			Baht bat*
			Mesghal MS*
	Display accuracy 1	o	All digits
			Fewer for weight change
			Last digit off*
	Tare zero with power on*	o	On
			Off
	Factory settings: only weighing parameters (= balance scale functions)		No
			Yes

* = not applicable to verified balances

= factory setting on ME5, SE2

Setting the Device Parameters (Device)

Purpose

This menu item enables you to configure the balance, i.e., to meet individual requirements by selecting predefined menu parameters in the Setup menu. You can block access to the menu by assigning a password.

Features

The device parameters are combined in the following groups (1st menu level):

- Draft shield
- Ionizer*
- Password
- User ID
- Clock
- Interfaces
- Display
- Keys
- Extra functions
- Factory settings: only device parameters

Factory Settings

Parameters: The factory settings are identified by the symbol "o" in the list starting on page 25.

Preparation

Display available device parameters

- Select the Setup menu:
press **Setup**

> SETUP is displayed:

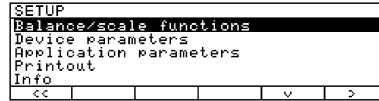

- Select "Device parameters":
use the **↓** and **→** soft keys

If no password has been assigned, anyone can access the Setup menu device parameters

If a password has already been assigned:

> The password prompt is displayed

- If access is blocked by a password: enter the password using the numeric and | or alphabetic keys
- If the last character of the password is a letter:
conclude input by pressing the **ABC** key

- Press **I** to confirm the password

> Device parameters are now displayed:

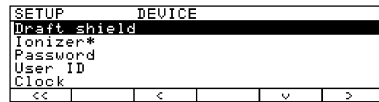

- To select the next group:
press the **↓** soft key (down arrow)
- To select the previous menu item of a group: press the **↑** soft key (up arrow)
- To select the next sub-item within a group: press the **→** soft key (right arrow)
- To select the previous group:
press the **←** soft key (left arrow)
- Press **↓** to confirm the selected menu item

Entering or Changing a Password

- Let's assume that a password with 8 characters max. has already been assigned to access the Setup device parameters

- Select the Setup menu:
press **Setup**

> SETUP is displayed

- Select device parameters:
Use the **↓** and **→** soft keys

If you have already assigned a password:

> The password prompt is displayed:

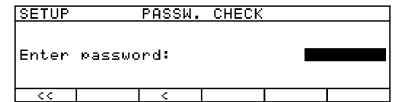

- Enter the password
- Press the **↓** soft key to confirm your password and view the device parameters
- Write down your password here for easy reference:
Password =
If you assign a password and then forget what the word is:

- Enter the General Password (see Appendix)

- Press the **↓** soft key to confirm and display the password

> The device parameters are displayed

- Select the device parameter "Password":
If necessary, repeatedly press **↓** or **↑** and **→**, until you see

> Password: and any existing password

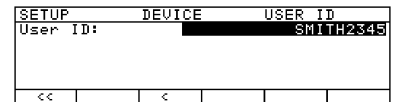

* = not on ME5, SE2

- New password: Enter the numbers and/or letters for the new password (8 characters max.)
If "none" is displayed, this means no password has been assigned
To delete the user password:
Press **.** or **CF** and confirm
- To confirm:
press the **↓** soft key
- Exit the Setup menu:
press the **←** soft key
- > Restart the application

Extra Functions

- Exit the Setup menu:
press the **←** soft key
- > Restart the application
- Print the parameter settings:
- If the device parameters are displayed: press **☰**
- > Printout (example)

```

-----
SETUP
      DEVICE
-----
Draft shield
Left/right key
  Same function
Automatic mode
                               Off
Weight resolution
Show all decimal places
                               ces
Ionizer
On
  Auto-off time:
                               10 sec
User ID
User ID:

Interfaces
Serial communication
SBI
  Baudrate
                               1200 baud
  Number of data bits
                               7 data bits
  Parity
                               Odd
  Number of stop bits
                               1 stop bit
  Handshake mode
Hardware handshake
  after 1 character
Serial printer (PR
YDP03
  Baudrate
                               1200 baud
  Parity
                               Odd
  Handshake mode
Hardware handshake
  after 1 character
  Function: external
                               Print key
  Function: control
                               Output
Display
Contrast
                               2

```

etc.

Device Parameters (Overview)

- o factory setting
- √ user-defined setting(s)

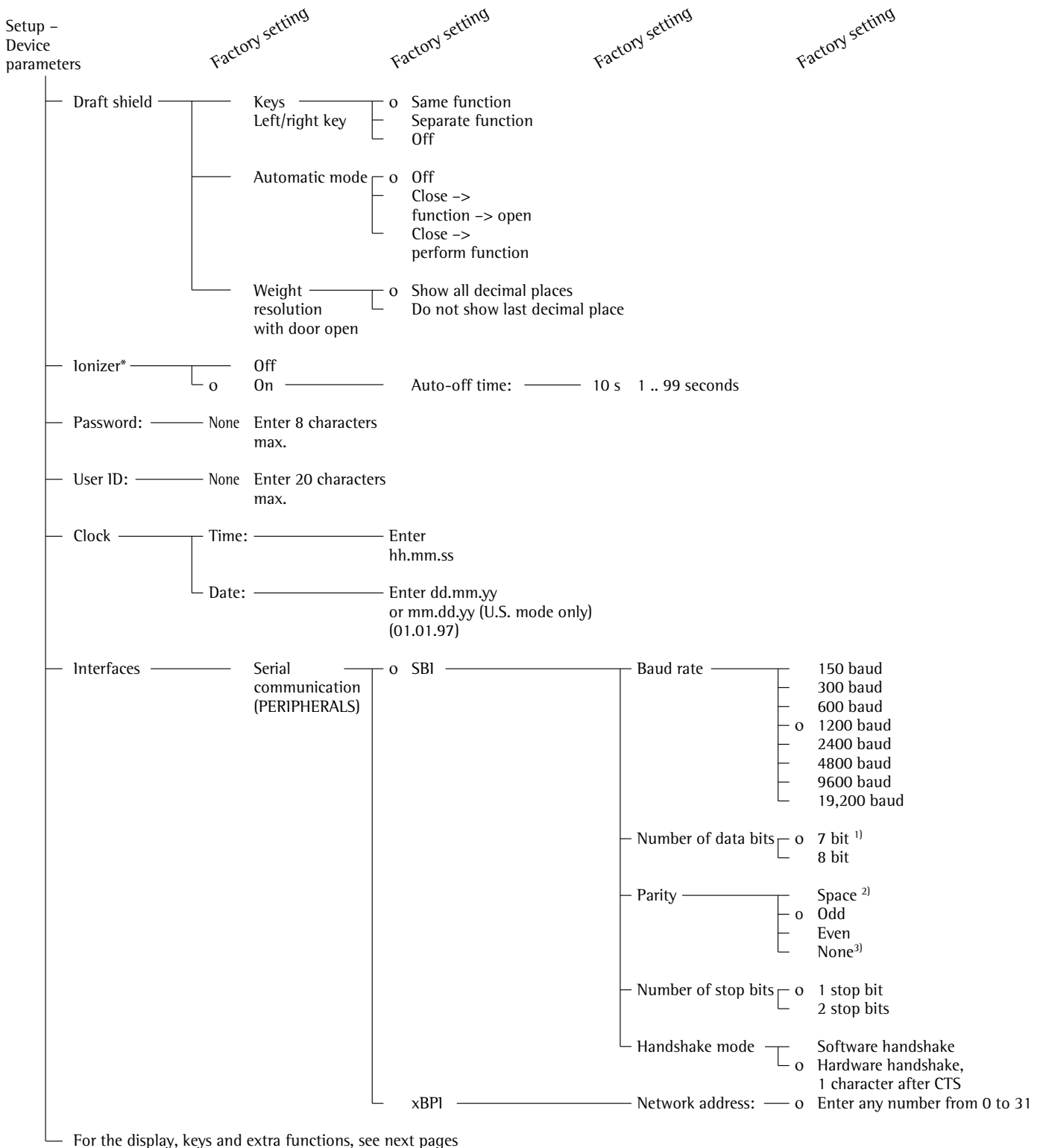

For the display, keys and extra functions, see next pages

- * = not on ME5, SE2
- 1) not if "None" parity is selected
- 2) only if 7 data bits selected
- 3) only if 8 data bits selected

Setup –
Device
parameters

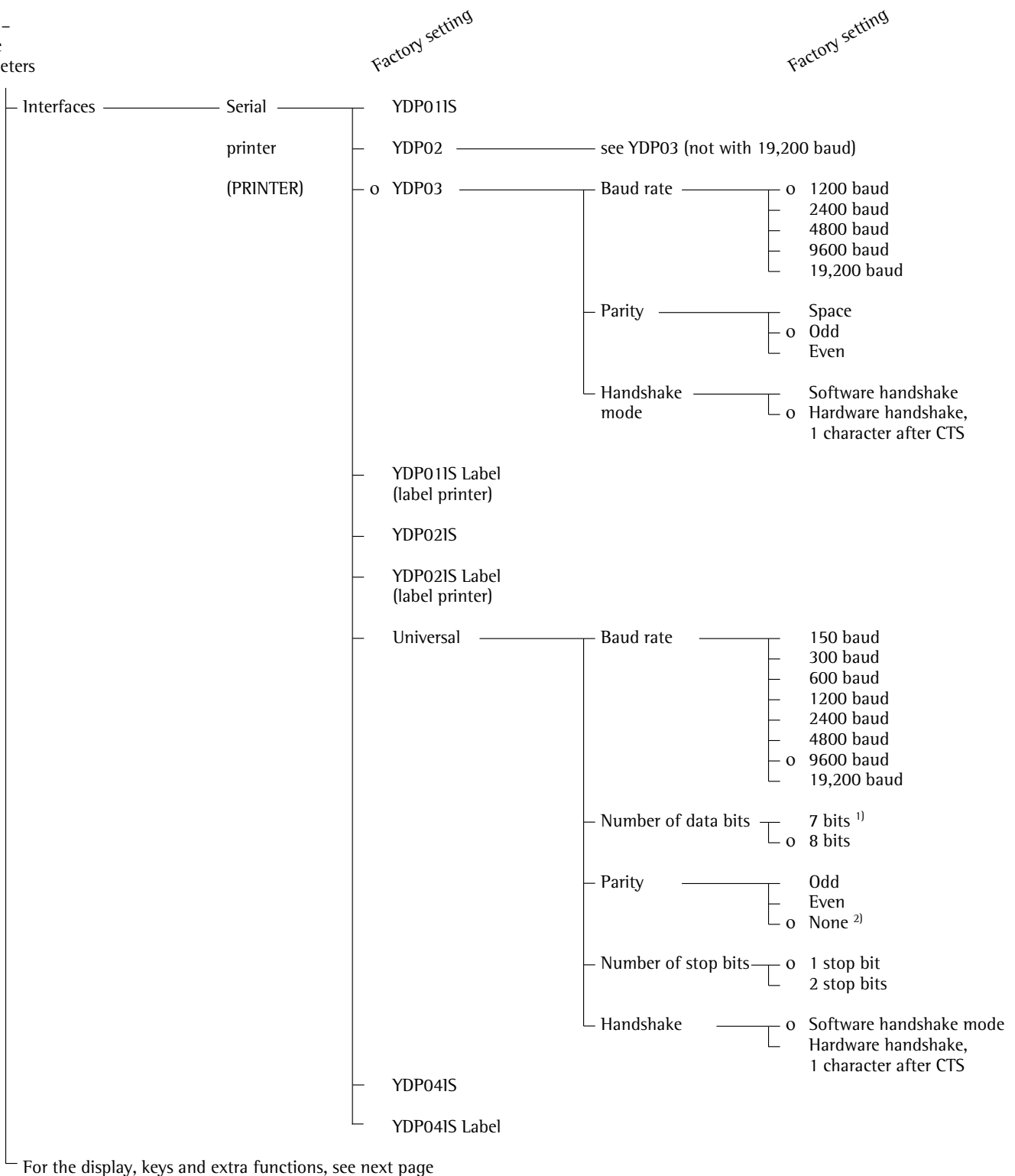

1) not if "None" parity is selected
2) only if 8 data bits selected

Setup –
Device
parameters

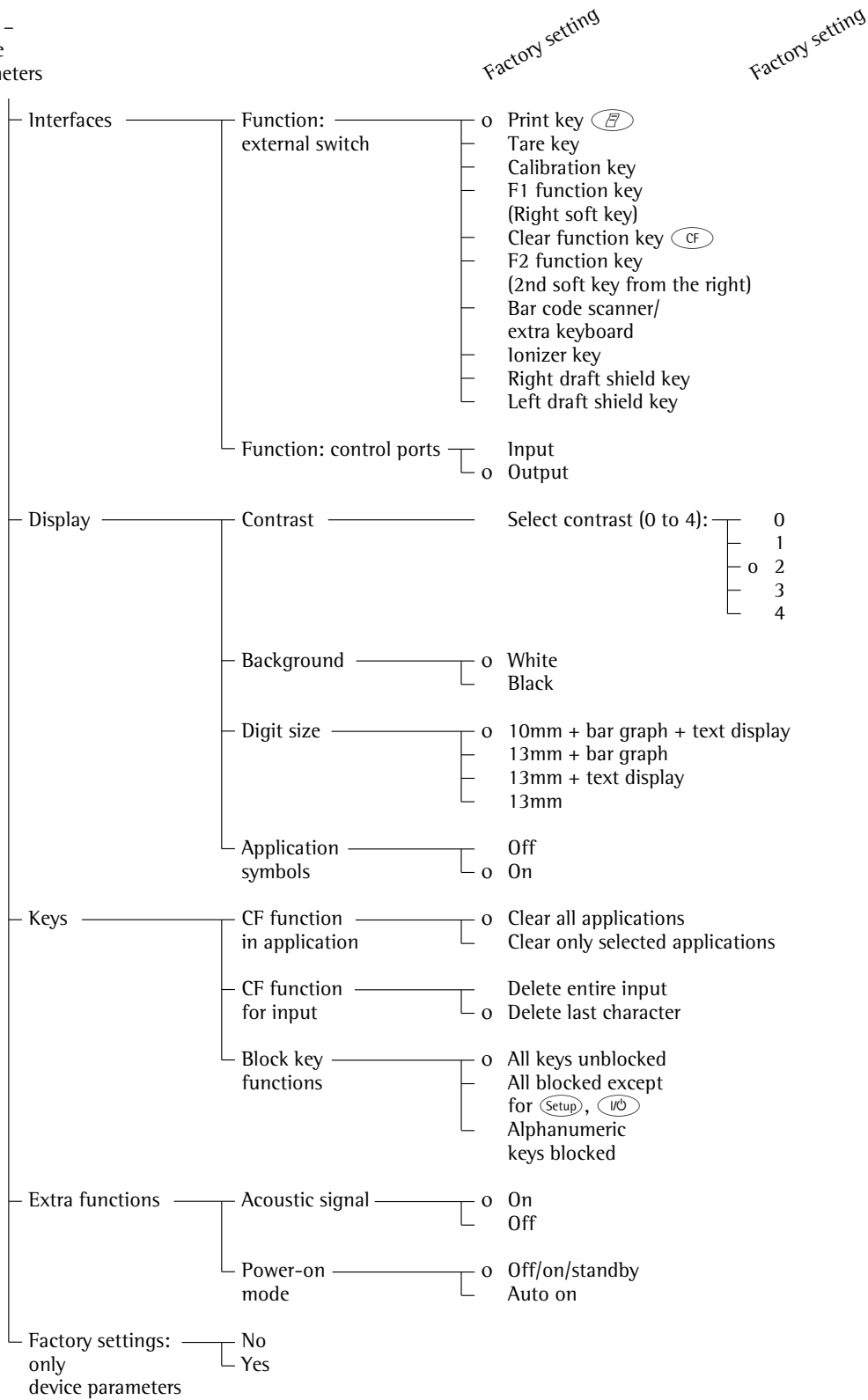

Setting the Application Parameters (Application)

Purpose

This menu item enables you to configure the balance, i.e., adapt the balance to your individual requirements by selecting from a list of parameter options in a menu. You can block access to this menu by assigning a password.

Features

The simple weighing function is available at all times. You can select one from each of the following application groups. This means a number of combinations are possible.

Application 1 (basic settings)

- Toggle weight units
- Counting
- Weighing in percent
- Animal weighing (averaging)
- Calculation
- Recalculation
- Density determination
- Differential weighing
- Air buoyancy correction and air density determination
- Diameter determination

Application 2 (control functions)

- Checkweighing
- Time-controlled functions

Application 3 (data records)

- Totalizing
- Formulation
- Statistics

In addition, you can assign 2 extra functions to each of the soft keys, in some cases (depending on the Setup configuration):

- Second tare memory
- Identification codes
- Manual storage in app. 3 memory (M+ key)
- Changing the resolution
- Product data memory
- SQmin function*
- DKD uncertainty of measurement*

Auto-start application when the balance is switched on

Factory settings:
only application parameters

Factory Settings for the Parameters

The factory settings are identified by the symbol "o" in the list starting on page 29.

Preparation

Display available application parameters:

- Select the Setup menu:
press the **(Setup)** key
- > SETUP is displayed

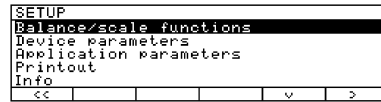

- Select parameters: repeatedly press the **↵** and **➤** soft keys

If you have already assigned a password:

- > The password prompt is displayed:
 - If access is blocked by a password: enter the password using the numeric/alphanumeric keys
 - If the last character of the password is a letter: conclude input by pressing **(ABC)**
- Confirm your password and have the application parameters displayed: press the **↵** soft key

> The application menu is displayed:

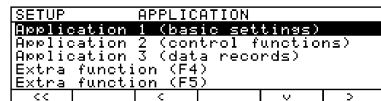

- To select the next group: press the **↵** soft key (down arrow)
- To select the previous item of a group: press the **↶** soft key (up arrow)
- To select the next sub-item within a group: press the **➤** soft key (right arrow)
- To select the previous group: press the **↶** soft key (left arrow)
- To confirm: press the **↵** soft key

Extra Functions

- Exit the Setup menu:
press the **↶** soft key
- > Restart your application
- Print parameter settings:
 - When the balance/scale functions are displayed, press **(Printout)**
- > Printout (example)
Texts with more than 20 characters are truncated

SETUP

Application

```
-----  
Application 1 (basic settings)      Off  
Application 2 (control functions)   Off  
Application 3 (data records)        Off  
Extra function (F4)                  Off  
Extra function (F5)                  Off  
Auto-start app. when switched on    Off  
-----
```

* must be activated by service technician

Application Parameters (Overview)

- o factory settings
- √ user-defined setting(s)

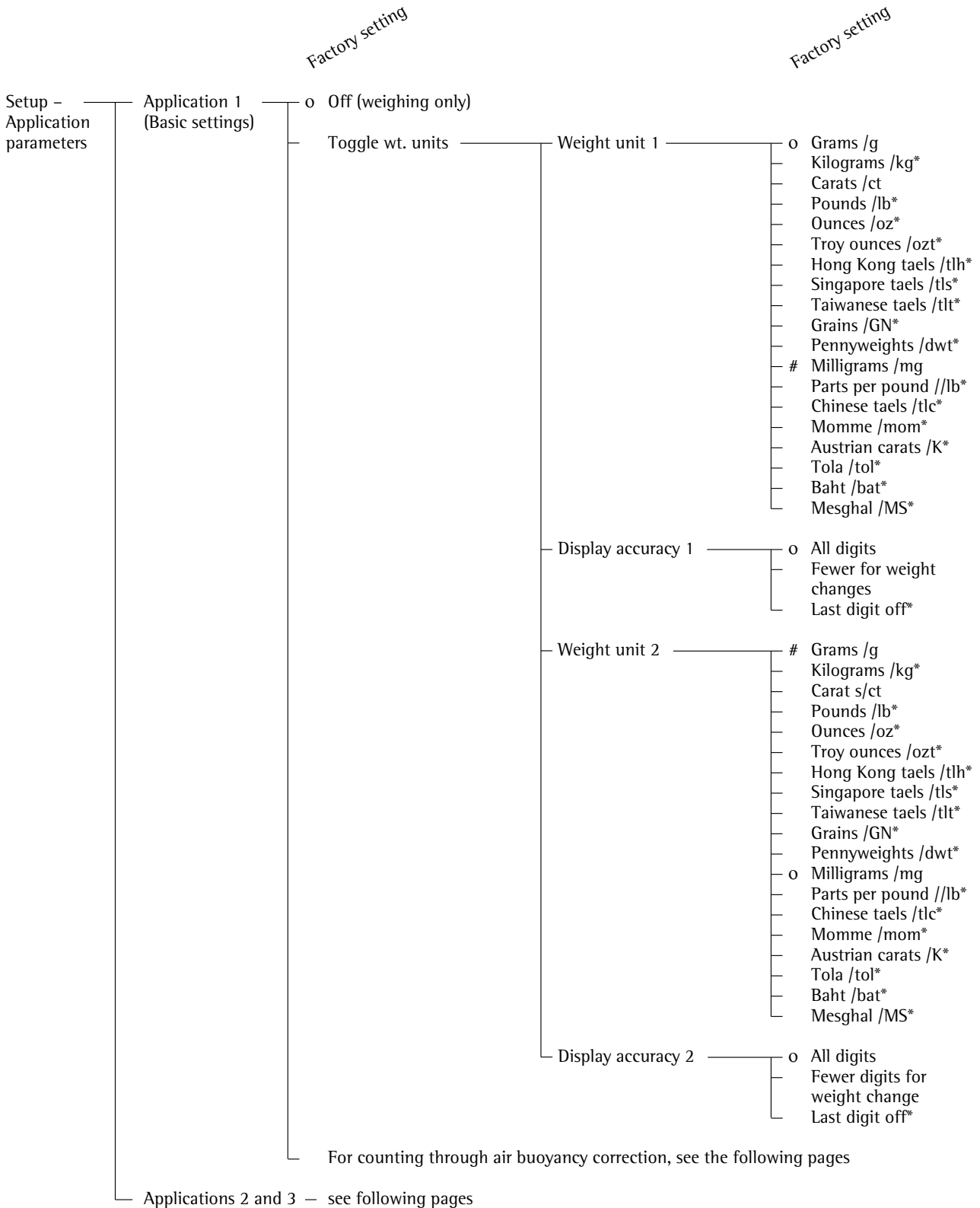

* not applicable to verified balances
 # = factory setting on ME5, SE2

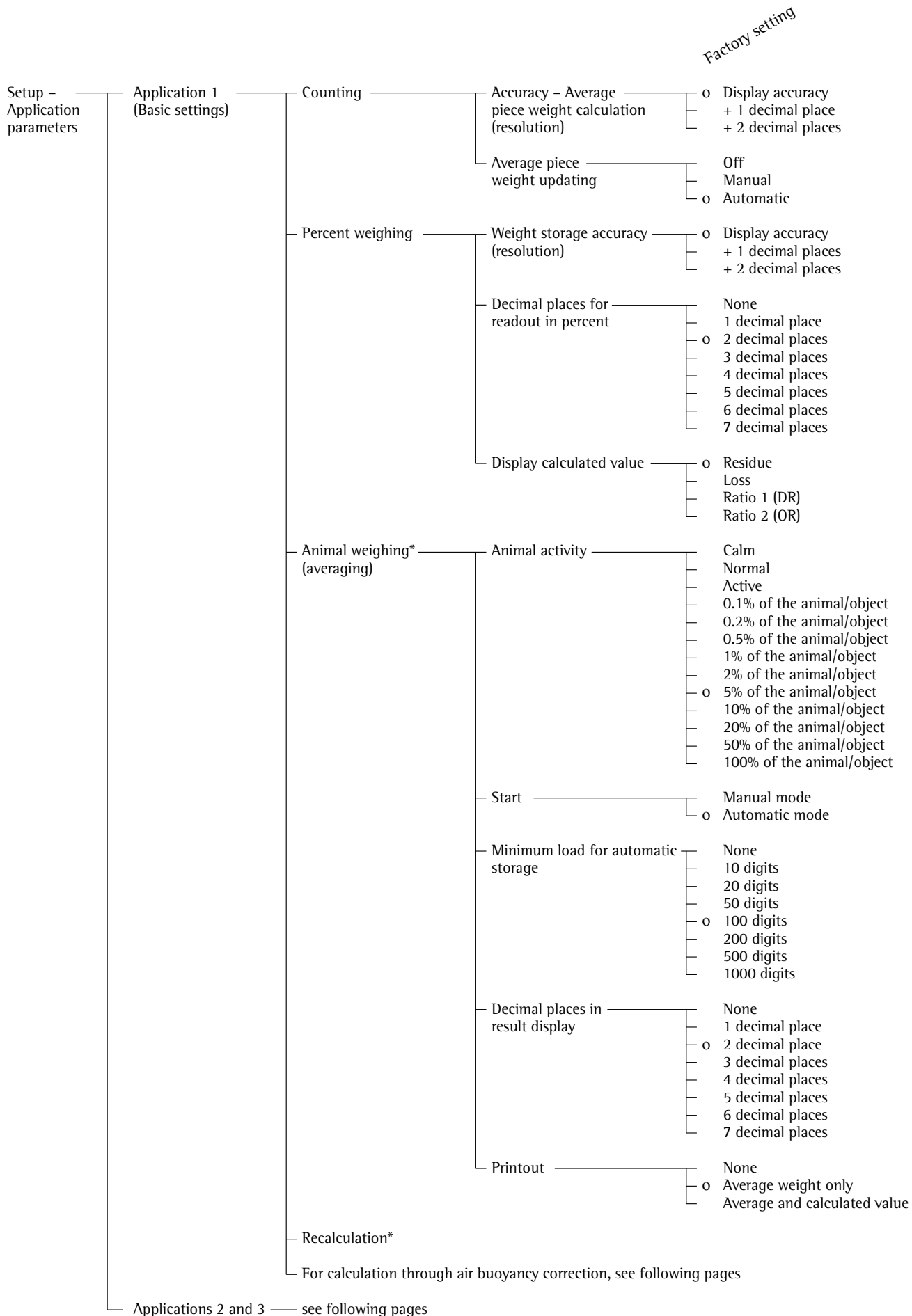

* = How to run this application is described in detail in our Masterpro “LA...” Installation and Operating Instructions. Request your copy directly from Sartorius or download it from the Internet (www.sartorius.com; see “download”)

Factory setting

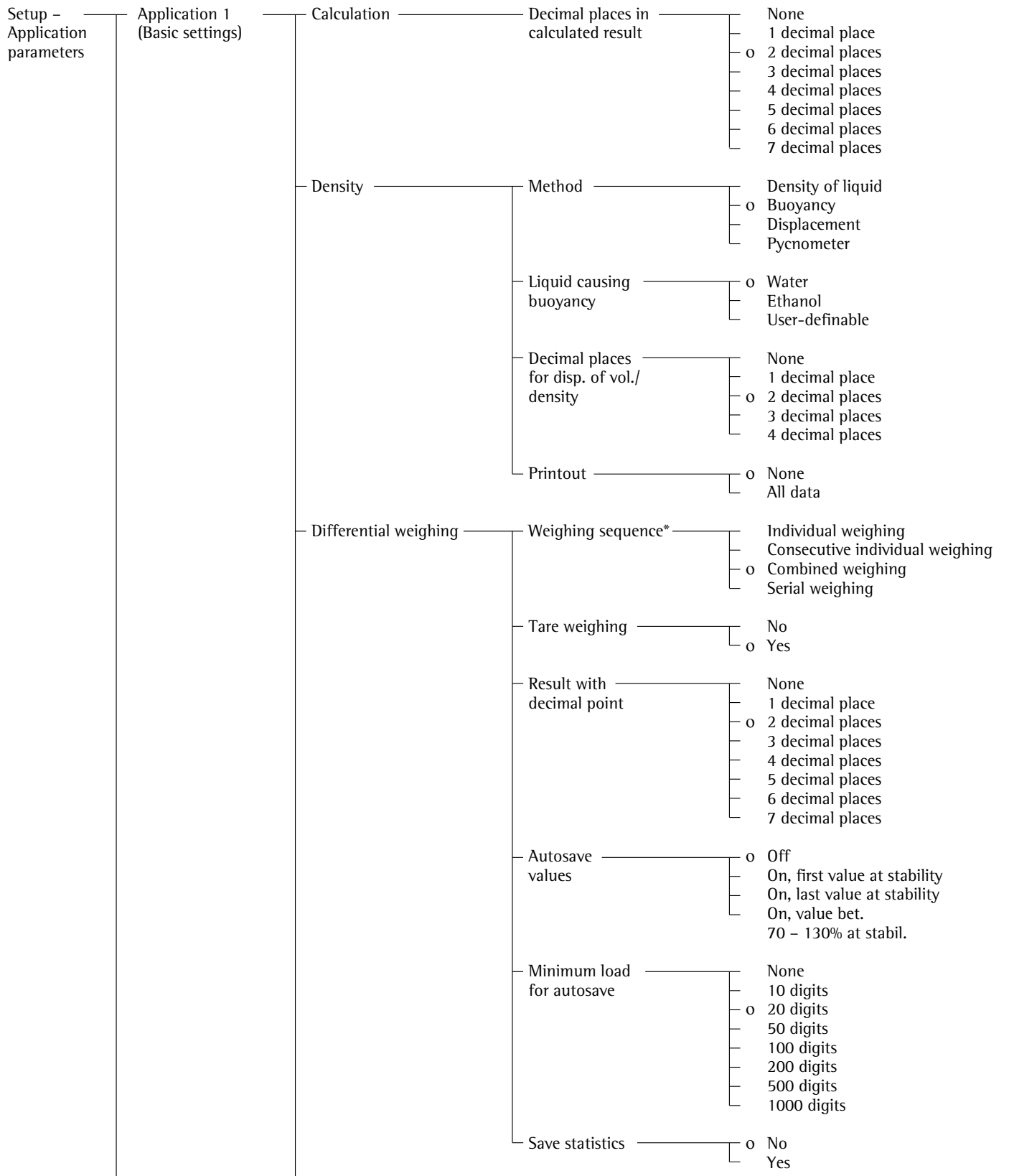

Air buoyancy correction: See next page

Applications 2 and 3: see following pages

* = Setting can only be changed when the program is initially run and when the **W.S.E.A.** key option is set to "No"

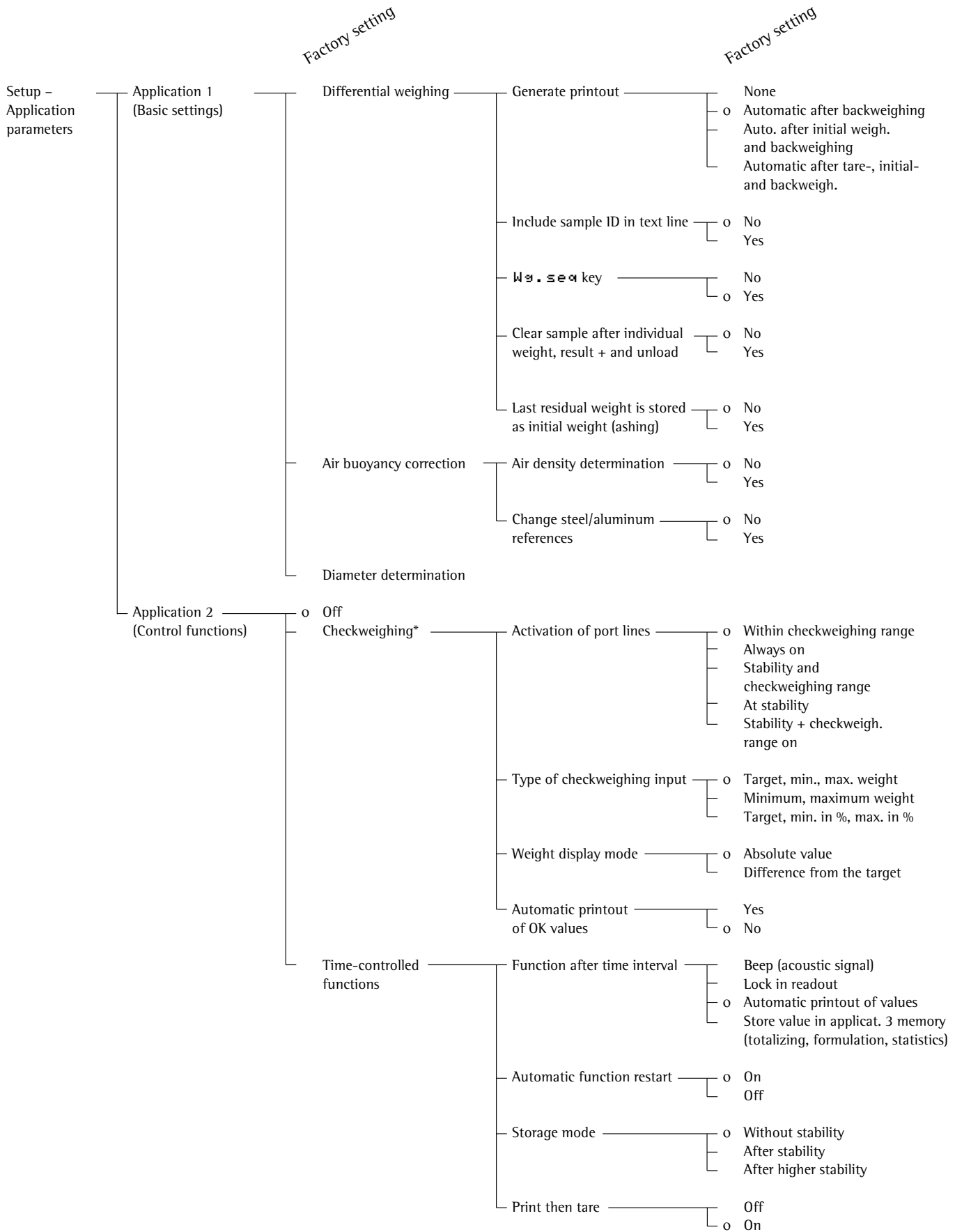

* = How to run this application is described in detail in our Masterpro “LA...” Installation and Operating Instructions. Request your copy directly from Sartorius or download it from the Internet (www.sartorius.com; see “download”)

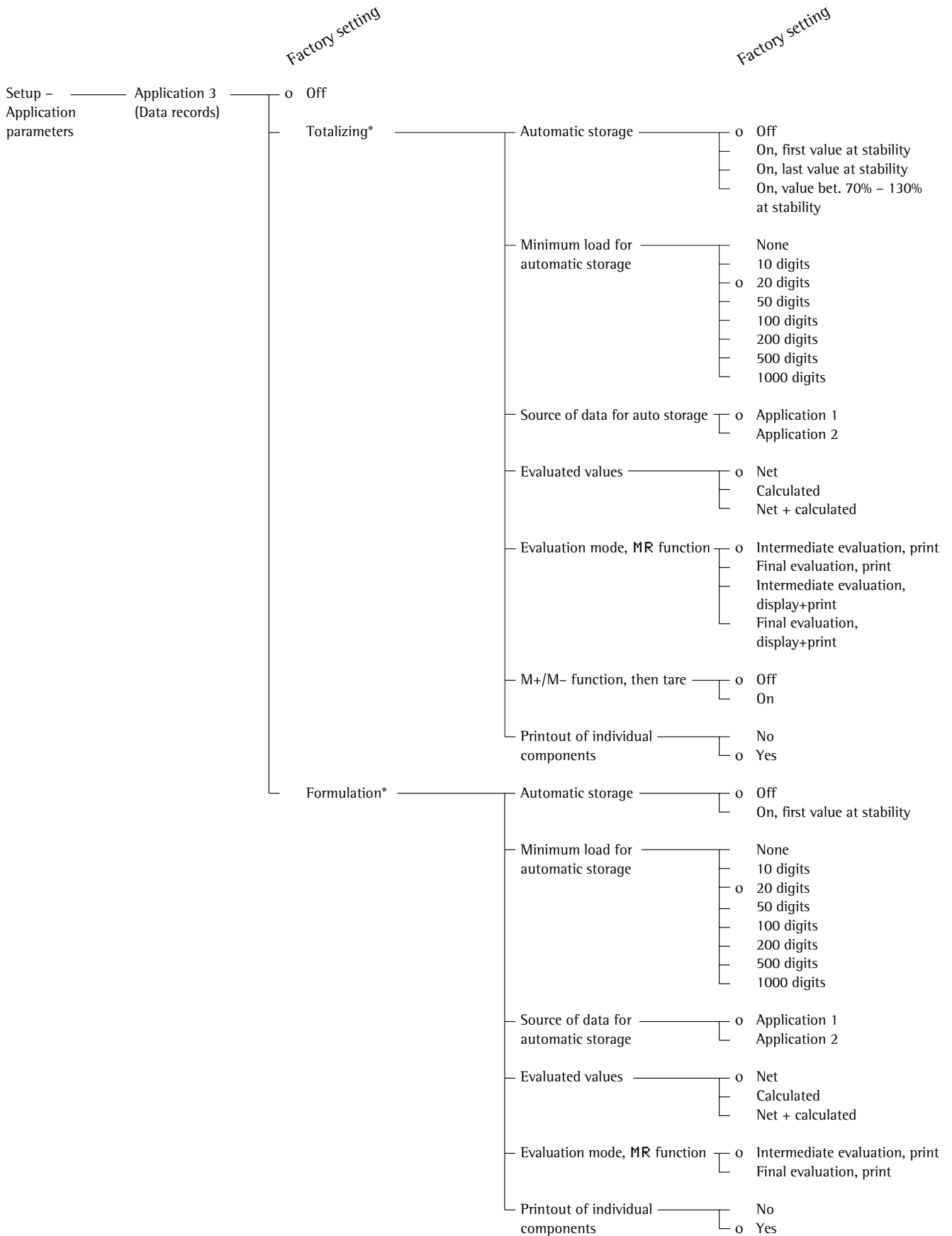

* = How to run this application is described in detail in our Masterpro “LA...” Installation and Operating Instructions. Request your copy directly from Sartorius or download it from the Internet (www.sartorius.com; see “download”)

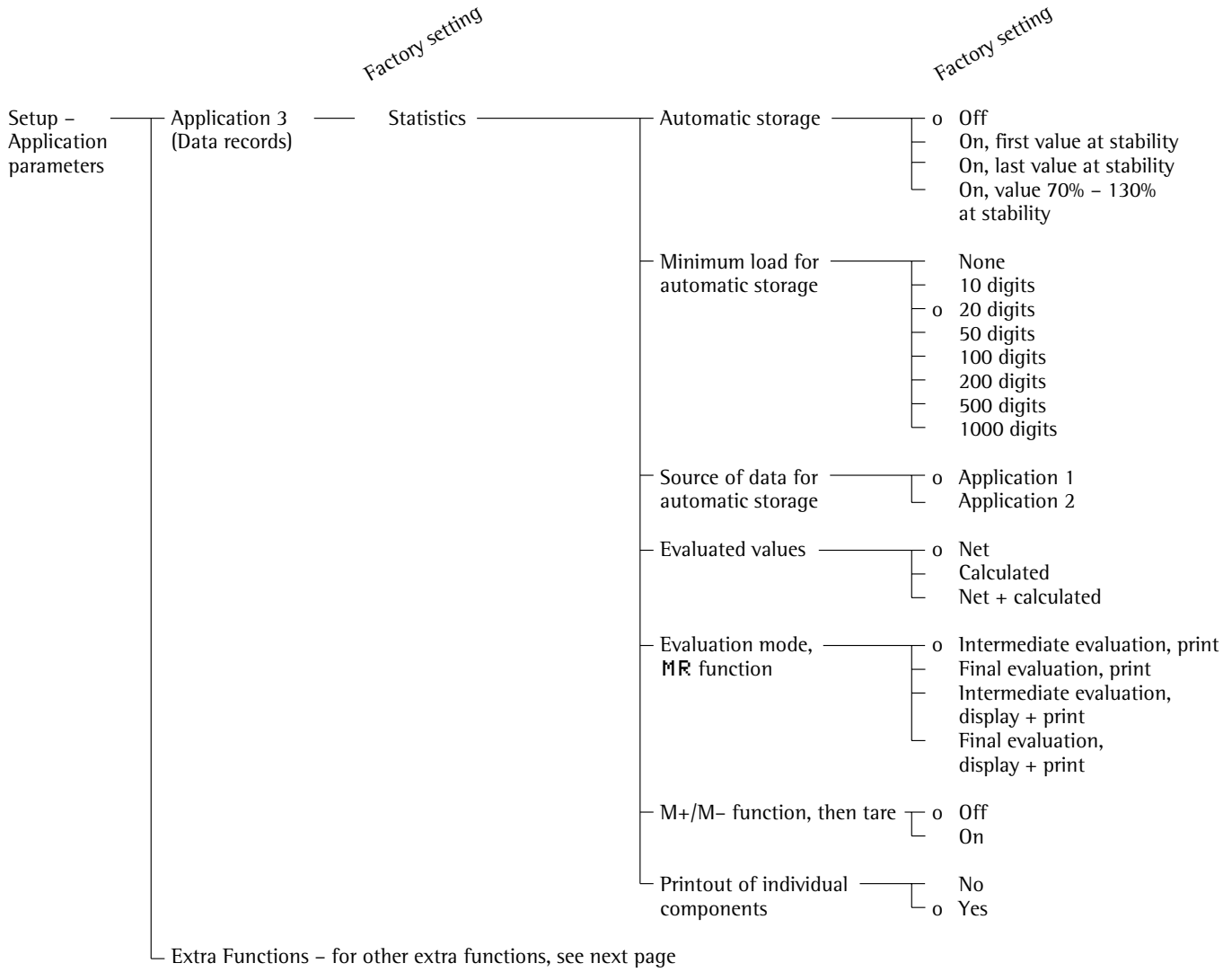

Selecting the Printout Function (Printout)

Purpose

This menu item enables you to configure the printout to meet your individual requirements by selecting predefined menu parameters in the Setup menu. Printouts of weights and other measured or calculated values and IDs enable you to document your data. You can select the particular data you wish to print. To prevent changes to your settings, you can block access to the menu by assigning a password.

Features

The device parameters are combined in the following groups (1st menu level):

- Application-defined output
- Automatic output of displayed values
- Output to interface ports
- Line format
- ISO/GLP printout
- Identification # (identifier)
- Factory settings – only printout

Factory Settings

Parameters: The factory settings are identified by the symbol “o” in the list on the next page.

Preparation

Display available printout parameters

- Select the Setup menu:
press (Setup)

> SETUP is displayed:

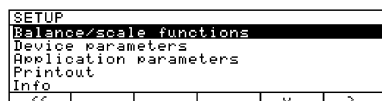

- Select "Printout":
use the \downarrow and \rightarrow soft keys
If no password has been assigned, anyone can access the printout parameters in the Setup menu

If a password has already been assigned:
> The password prompt is displayed

○ If access is blocked by a password: enter the password using the numeric and/or alphabetic keys

○ If the last character of the password is a letter: conclude input by pressing the (ABC) key

- Press \downarrow to confirm the password

> Printout parameters are now displayed:

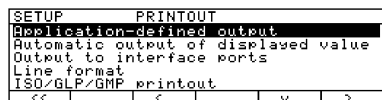

- To select the next group:
press the \downarrow soft key (down arrow)
- To select the previous item of a group: press the \uparrow soft key (up arrow)
- To select the next sub-item within a group: press the \rightarrow soft key (right arrow)
- To select the previous group:
press the \leftarrow soft key (left arrow)
- To confirm: press the \downarrow soft key

Extra Functions

- Exit the Setup menu:
press the $\leftarrow \leftarrow$ soft key
> Restart your application

- Print parameter settings:
- When the printout parameters are displayed, press (E)

> Printout (Example)

```

-----
SETUP
      PRINTOUT
-----
Application-defined
Stability paramete
  With stability
Print on request t
      Off
Auto print upon in
      All values
Configured printou
  Individ.: Printout
Automatic output of
Stability paramete
  Witout stability
Stop auto print
      Not possible
Time-dependent aut
  1 display update
Output to interface
  Serial communicati
Application-defined
  output
  Serial printer (PR
Application-defined
  output
  Line format
For other apps/GLP (
  22 characters)
  ISO/GLP/GMP printou
      Off
Identification #
  Lot (L ID):

  ID1:
etc.
  
```

Printout Parameters (Overview)

o factory setting
 √ user-defined setting(s)

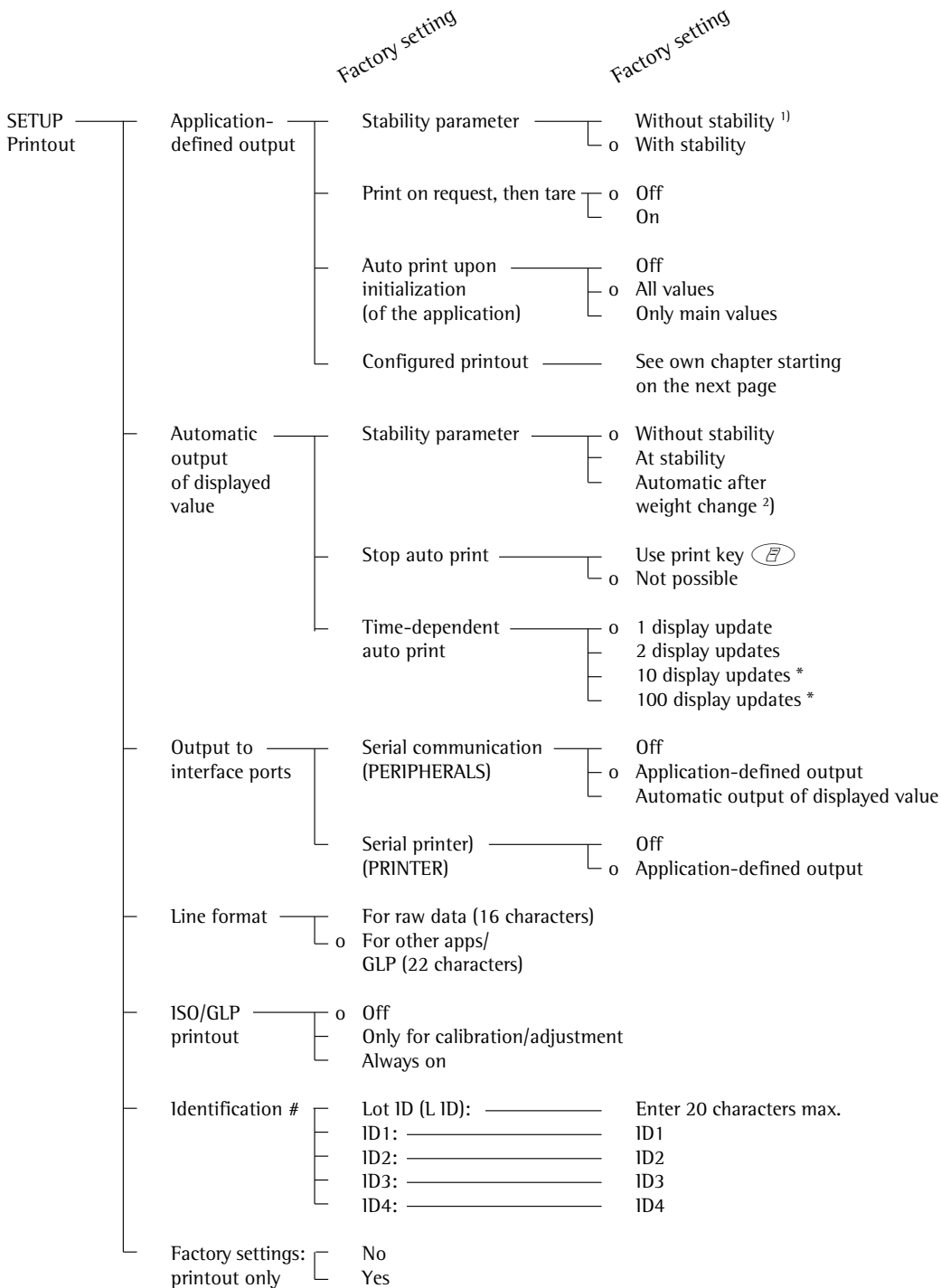

* = changing settings not applicable to verified balances

¹⁾ = Information on use in legal metrology: Only permitted for control purposes; printouts are not allowed

²⁾ = auto print when load change is > 10 d and stability is reached: no printout until residual difference in load value is < 5 d

Printout Configuration

Purpose



This menu item enables you to configure individual printout formats. With the formulation, totalizing and statistics application, you can also define the values to be included on the total printout when the MR key is pressed.

Under "Setup > Printout > Application-defined output > Configured printout", you can configure individual, component or total data records that contain the items in each application that are available for printouts. Configure these printouts after you have configured the applications, because some entries in the data record depend on the particular application.

Features

- Maximum items in a data record: 60
- Separate configuration of printout formats for individual weights, components, total, backweighing and statistics
- Individual printout generation: press the  key

Automatic printout of application data: e.g., results from animal weighing or density application (Setup menu: Application 1: Density: Printout: All data) OK values from checkweighing application, time-controlled printouts, 2nd tare memory

- Component printout: For results from totalizing, formulation or statistics applications, press **M+** or **M-** (Setup: Application 3: ..., Printout of individual components: On)
- Total printout: For totalizing, formulation or statistics applications, press **MR**
- Backweighing printouts or records: automatically generated after backweighing or manually by pressing the  key when the result is displayed at the end of backweighing
- Statistics printout or output: To generate, press the  key when the statistics are displayed

Printouts for Differential Weighing: These printouts can be generated as standard or configured (user-defined) reports.

You can configure the following printouts:

- Individual printout
- Backweighing printout
- Statistics printouts

Printouts are generated in one of two ways:

- at the request of the user by pressing the  key (print on request)
- automatically, if configured in the Setup menu [Application parameters: Application 1: Differential weighing: Generate printout: Auto]

You can turn off automatic printout generation in the Setup menu [Application parameters: Application 1: Differential weighing: Generate printout: None]

- Data records are deleted after you have switched to a different application or activated or de-activated an extra function in the application parameters of the Setup menu
- A new pick list for a data record is created based on the currently active application programs and extra functions
- Printout items can be deleted individually
- No printout is generated when the following setting is configured: Setup: Printout: Line format: For raw data (16 characters)
- Print item "Form feed" for footer: Advance to beginning of next label in the "YDP011S-Label" and "YDP021S-Label" [printer] interface mode

Extra Functions

- Exit printout configuration: press **<<** soft key
- > Restart application
Printing "Select" and "List" Settings
- **LIST**: print the currently selected list
SELECT: printout items that can still be selected
- When the select bar is on **LIST** or **SELECT**: press the  key
- > Printout (Example)

```
BACKW. PRINT.LIST
=====
Sample date
Net initial wt.
Backweighed res
Loss in %
=====
etc.
```

Example:

Configure an Individual Printout for Counting Application to Include Dotted Line, Date/Time, Piece Count and Net Weight

Settings (changes in the factory settings required for this example):

Setup: Application parameters: Application 1: Counting

Exit the Setup menu: press the << soft key

Then call Setup again: Printout: Application-defined output: Configured printout

Step	Press key(s) (or follow instructions)	Display/Output
1. Select Setup menu, then "Printout"	Ⓢ, then ↓ repeatedly and > soft key	<pre> SETUP PRINTOUT Application-defined output Automatic output of displayed value Output to interface ports Line format ISO/GLP/GMP printout << < v > </pre>
2. Confirm "Application-defined output"	> soft key	<pre> SETUP PRINTOUT APPLICATION Stability parameter Print on request then tare Auto print upon initialization Configured printout << < v > </pre>
3. Select and confirm "Configured printout"	↓ soft key 3x and > soft key	<pre> PRINTOUT APPLICATION CONFIG Indiv.: Printout f. app./weighing << < > </pre>
4. Confirm "Indiv. printout"	> soft key	<pre> LIST INDIV.PRT SELECTION Blank line Form feed Date/time Time << Delete > </pre>
5. Select "Blank line"	>, v, ↓ soft keys	<pre> LIST INDIV.PRT SELECTION Blank line Form feed Date/time Time << < n v ↓ </pre>
6. Select "Date/time"	↓ soft key twice, then ↓ soft key	<pre> LIST INDIV.PRT SELECTION Date/time Blank line Form feed Time GLP header << < n v ↓ </pre>
7. Select "Piece count"	↓ soft key repeatedly, then ↓ soft key	<pre> LIST INDIV.PRT SELECTION Date/time Gross (G#) Piece count Ref. quantity Ref. weight Target << < n v ↓ </pre>
8. Select "net weight"	↖ soft key repeatedly, then ↓ soft key	<pre> LIST INDIV.PRT SELECTION ID1 Date/time ID2 Piece count ID3 Net (N) ID4 Gross (G#) << < n v ↓ </pre>
9. Exit "Printout" configuration	<< soft key	
10. Perform weighing operations, then print	Ⓢ	<pre> ----- 14.01.2000 09:19 Qty + 598 pcs N + 2003.13 g </pre>

Device Information

Purpose

This menu item enables you to have information displayed about the specific balance ("device").

Display Device Information on ME215/235/254/414/614

- Select the Setup menu:
press the **Setup** key

> "SETUP" is displayed:

SETUP
Balance/Scale functions
Device parameters
Application parameters
Printout
Device information
<< < > >>

- Select "Info":
Repeatedly press the **v** soft key, then press the **>** soft key
- Select "Device information":
press the **>** soft key

> Device information is displayed:

SETUP	INFO
Version no.:	01-41-05
Wgh. sys. ver. #:	00-21-09
Draft sh. ver. #:	05-01-03
Model:	ME215S
Serial no.:	91205355
<< < > >>	

Display Device Information on ME5 or SE2

- Select "Device Information":
Press the **I** key
- > Device information is displayed

- Print device information:
Press the **Print** key
- > Printout (Example)

```

-----
23.12.2001      13:02
Model          ME215S
Ser. no.       91205355
Ver. no.       01-41-05
                (Version of the operating program)
ID             BECKER123
                (User ID)
-----
L ID           LOT 23
                (Lot ID)
SETUP

```

```

                INFO
-----
Version no.:   01-41-05
                (Version of the operating program)
Wgh. sys. ver. #: 00-21-09
                (Version no. of the weighing cell)
Dft. shield v. no.: 05-01-03
                (Program version no. of the
draft shield)
Model:        ME215S
Serial no.:   91205355
Next mainten.: 01.01.2003
Service phone: 00495513080
SQmin:       0.0300 g
-----

```

- Return to SETUP overview:
press the **<** soft key
 - Exit Setup menu:
Press the **<<** soft key
- > Original settings are restored

Factory Settings

Each parameter category has a factory setting. In the Setup menu, you can restore all factory settings by confirming the selection **YES**.

The following settings are not restored:

- Language
- Password
- Display contrast
- Time (clock)

Operating the Balance

Basic Weighing Function

Purpose

The basic weighing function is always accessible and can be used alone or in combination with an application program (Toggle between Weight Units, Counting, Weighing in Percent, etc.).

Features

- Taring the balance
- Assigning IDs to weights
- Printing weights
- Printing ID codes for weights

Soft Key Functions

C a l Start calibration/adjustment
i s o C A L Press when necessary to start calibration and adjustment
S I D Stored ID entered

General Instructions for "Analytical Weighing"

Handling Samples and Containers

The sample should be conditioned to the temperature inside the balance. This is the only way to avoid errors caused by air buoyancy and deviations caused by convection currents at the surface of the sample.

Since these effects increase proportionally to the volume and surface of the sample, make sure that the size of the tare vessel selected is appropriate for the initial sample.

Never use your bare hands to touch samples to be weighed. In addition to the effect of the temperature, the extremely hygroscopic behavior of fingerprints left on the sample will otherwise cause considerable interference during weight measurement.

Use forceps or a similar utensil that is appropriate to place your sample carefully on the pan. Working with your balance requires a steady hand and a smooth, uninterrupted technique.

If the weighing chamber has not been opened for a relatively long period, it may have a temperature different from that of the balance's surrounding environment. When you open the weighing chamber, a change in temperature will inevitably occur, due to the laws of physics, and may show up as a change in the weight readout.

Therefore, we recommend that before you begin the actual weighing series you open and close the weighing chamber at the same rate as you will be doing during weighing. After the weighing chamber has been closed, the weight readout will usually stabilize after about 8 seconds. The accuracy of the weight readouts will increase as you continue weighing with greater consistency.

Weighing Electrostatically Charged Samples and Containers

Major measuring errors can occur when electrostatically charged samples and containers are weighed. This problem particularly involves samples that have extremely poor conductivity (glass, plastic, filters) since they can discharge electrostatic – i.e., friction-induced – charges only over a relatively long period of time. The result is an interaction of forces among the charges adhering to the sample and the stationary components of the balance (weighing chamber base plate, draft shield construction, balance housing). This is noticeable when the weight readout drifts. At high humidity, this effect is not very pronounced or may not occur at all, due to the thin layer of water that condenses on the sample and, through conductive discharge, counteracts interfering static electricity.

In addition to taking purely mechanical counteractive measures (protecting the sample using a special antistatic weighing pan – see the "Accessories"), you can neutralize the surface charges by "bombarding" them with ions of the opposite polarity (see page 47 for instructions on activating the ionizer). This is a highly effective procedure for eliminating static electricity.

The balance's environment, including the operator, can considerably interfere with weighing results, due to static electricity. The balances of the ME/SE series have been designed to counteract this phenomenon: the glass surfaces of the draft shield have a special metallic coating.

The rear panel of the balance has a terminal for connecting an equipotential grounding conductor. It is used for additional grounding of a peripheral device (for example, a vibrating spatula). This terminal is designed for single grounding wires up to .25" standard gauge or 6 mm² stranded wires and for .18" standard gauge or 4mm² stranded wires.

Weighing Magnetic or Magnetizable Samples

It is technically impossible to avoid the use of magnetizable materials in the manufacture of balances. Ultimately, the operating principle of high-resolution balances is based on electromagnetic force compensation of the load placed on the weighing pan.

When magnetic or magnetizable samples or containers (e.g., a beaker with a stirrer) are weighed, interactions among the above-mentioned components of the balance may occur, distorting weight readouts.

Unlike deviations caused by electrostatic charges, magnetic interference is usually constant over time. However, it is sensitive to and dependent on the position of the sample container on the weighing pan and is also characterized by poor repeatability.

To reduce the effect described above, we recommend increasing the distance between the sample and the weighing pan by inserting a non-magnetizable material between them (the reduction in force is proportional to the quadrate of the distance). In special cases, soft-magnetic plates should be used to shield against interfering magnetic effects.

In the presence of extremely strong magnetic fields – for instance, when measuring the susceptibility of a sample in an electromagnet – you should use the below-balance weighing port, which comes standard on your balance.

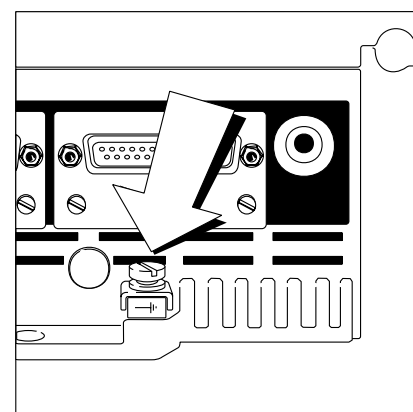

Operating the Balance

Below-Balance Weighing

A below-balance weighing hanger is located on the bottom of the balance.

Not allowed in legal metrology applications

- Open cover plate (1) on the bottom of the balance

- Lift off weighing pan 2
- Unscrew hanger 3
- Insert opposite end of hanger 3 into port and refasten
- Place weighing pan 2 back on balance
- Hang sample on the notched hook

- Remove both screws from beneath the weigh cell and detach the cover
- Attach a wire to the sample, if necessary, and hang it on the notched hook



- If necessary, install a shield for protection against drafts

Preparation for Operation

- Turn on the balance: press 
- > The Sartorius logo is displayed
- If it is time for the next maintenance, the following appears:

NEXT MAINTENANCE:	
Date:	01.01.2002
Service phone:	00495513080
<<	

To exit this screen: press the << soft key

- Call your nearest Sartorius Service Center to schedule a maintenance appointment
- To tare the balance, if desired, press 
- > The  symbol is displayed when a verified balance is zeroed or tared (± 0.25 digit)

ME215/235/254/414/614:

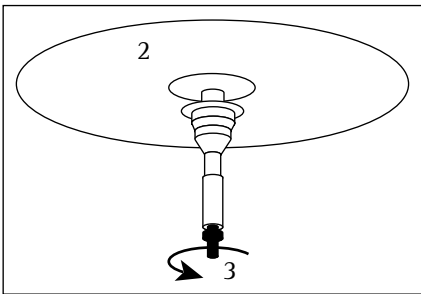
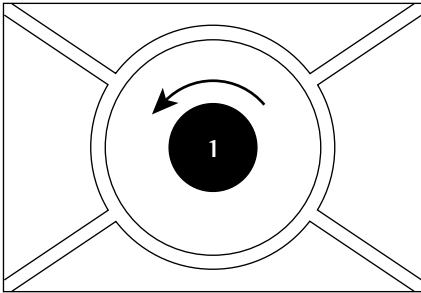

ME5/SE2:

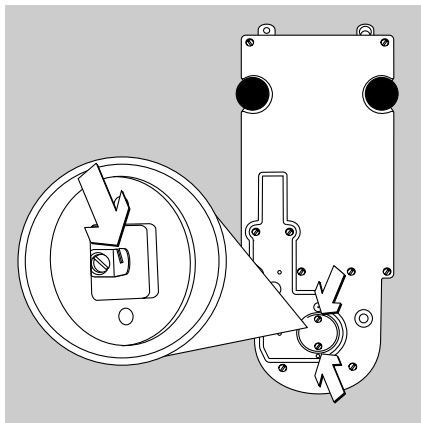

For Service:

Using Verified Balances as Legal Measuring Instruments in the EU*: This balance is not allowed to be used for weighing goods intended for direct sale to the public. The type-approval certificate for verification applies only to non-automatic weighing instruments; for operation with or without auxiliary measuring devices, you must comply with the regulations of your country applicable to the place of installation of your balance.

- Before using the balance as a legal measuring instrument, calibrate and adjust it at the place of use: see the section on “Calibration, Adjustment” in this chapter
- The temperature range (°C) indicated on the verification label may not be exceeded during operation.
Example:
BE BK 100
① 0...+40 °

* including the Signatories of the Agreement on the European Economic Area

Additional Functions

In addition to the functions:

- alphanumeric input
- taring (not during alphanumeric input)
- printing

you can also access the following functions from the weighing application:

- calibration/adjustment (not during alphanumeric input)
- setup
- turning off the balance

Calibration

- Press the **Cal** soft key
- > See the section on “Calibration/Adjustment” for further instructions

Setup

- Press **Setup**
- > See the chapter entitled “Configuring the Balance” for further instructions

Turning Off the Balance

- Press **Off**
- > The balance shuts off
- > The display goes blank

Examples

Example W1: Simple weighing

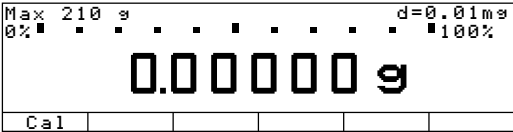
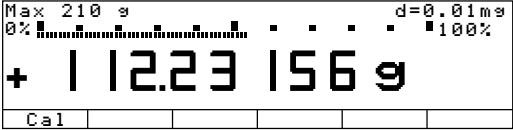

Step	Press key(s) (or follow instructions)	Display/Output				
1. If necessary, tare the balance (0 symbol: balance is tared – verified balances only)	Tare					
2. Enter sample ID	see example W2					
3. Determine sample weight (example)	Place sample on balance					
4. Print weight	Print	<table border="1" style="width: 100%; text-align: center;"> <tr> <td>S ID</td> <td>ABC123</td> </tr> <tr> <td>N</td> <td>+112.23156 g</td> </tr> </table>	S ID	ABC123	N	+112.23156 g
S ID	ABC123					
N	+112.23156 g					

Example W2

Enter "ABC123" as the sample ID

Note:

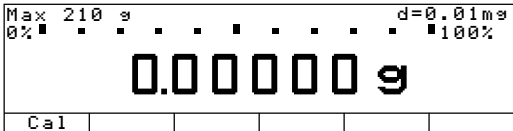
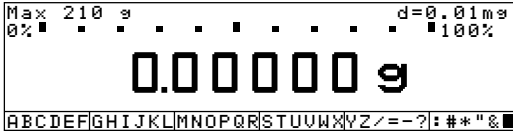
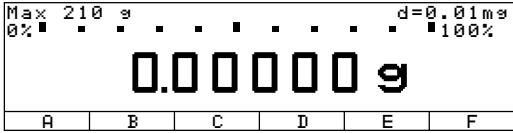
- The sample ID generally applies to one weighing operation only
- The ID is deleted after data output

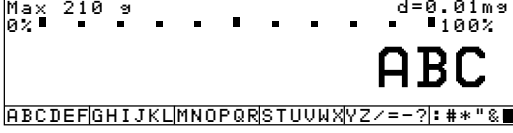
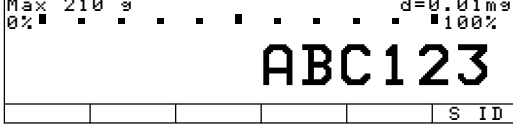
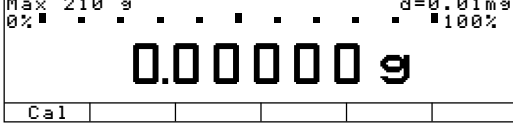
Step	Press key(s) (or follow instructions)	Display/Output
Initial state (balance unloaded) (ID can also be entered while balance is loaded)		
1. Select alphabetic input	(ABC)	
2. Select the required letter group "A"	ABCDEF soft key	
3. Enter the letter "A" (To delete a letter:	A soft key (CF), (CF)	
4. Select the letter group and enter "B"	ABCDEF soft key B soft key	
5. Select the letter group and enter "C" (If you enter only letters, conclude input	ABCDEF soft key C soft key (ABC)	
6. Enter the numbers 1, 2 and 3	(1) (2) (3)	
7. Store the ID (20 characters max.) - The next printout will include the sample ID	S ID soft key	

Device Parameters

Opening and Closing the Draft Shield

Purpose

The ME/SE balance is a high-resolution weighing instrument. It has a draft shield so that convection currents cannot affect the weighing result. To load a sample on and remove it from the weighing pan, a draft shield door must be opened and closed. You can do this in various ways, depending on the menu setting you select.

Features

- The draft shield doors can be opened and closed at any time, regardless of the application used
- The draft shield doors can be opened and closed by pressing the respective keys, by activating an external switch or by sending a command to the balance's interface port
- The draft shield doors can be set so that they operate automatically in one of the following ways when a specific balance function is performed, such as taring (zeroing):
 - Close automatically
 - Close automatically, then open

This function can be deactivated. If not, the draft shield doors will close automatically if the balance has not been used for 2 minutes (protects chamber from dust).

- The function "Close draft shield automatically when function is activated" can be combined with functions and applications that require the "with stability" parameter in order for weights to be accepted:
 - Turn on the balance (tare when the power goes on)
 - Tare after stability
 - Print on request after stability
 - Start all adjustment functions
 - 2nd tare memory
 - Manual weight storage mode for the following functions:
 - Counting, weighing in percent, recalculation, density determination, differential weighing
 - Checkweighing, time-controlled functions with storage mode
 - Totalizing, formulation, statistics

- A lower weight resolution is possible when the draft shield doors are open.
- The left and right \updownarrow keys for operating the draft shield doors can
 - have the same function
 - have separate functions
 - be switched off.

Draft Shield on ME215|235|414|614:

- You can define which draft shield door(s) will open and close when you press the left or right \updownarrow key (the Genius balance has a self-teaching capability)
- If a door encounters an obstacle while moving, the following will happen:
 - While opening: the door will stop
 - While closing: the door will re-open

Factory Settings of the Parameters

Left/right draft shield keys:

Same function

Automatic mode: **Off**

Weight resolution when door is open:

Show all decimal places

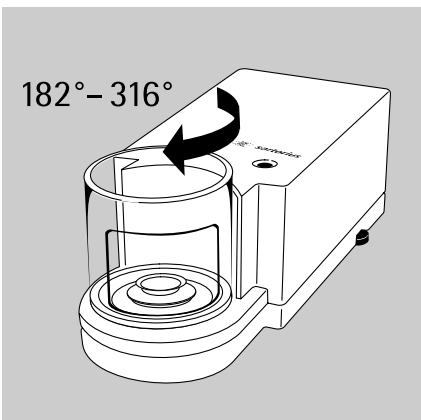
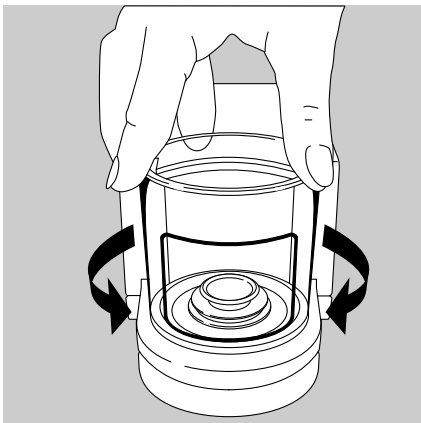

Draft Shield on ME5 | SE2

- You can define the function of the draft shield

Keys	Setup, draft shield keys:	
	Same function	Different (separate) function
\odot , \ominus key	<ul style="list-style-type: none"> - Opens according to predefined opening position - Numeric input of the aperture - Closes 	<ul style="list-style-type: none"> - Opens 100° clockwise - Closes
Numeric keys + \odot , \ominus key	<ul style="list-style-type: none"> - Enter and save value for aperture - 44° - 181°: Opens counterclockwise - 182° - 316°: Opens clockwise - 0° - 43°: Deletes stored value 	No function
Numeric keys + \odot key	Counterclockwise opening aperture between 46° and 180°	No function
Learning mode	Yes; define desired opening position manually	No

Preparation

- Turn on the balance: press 

> The Sartorius Logo is displayed

- Configure the draft shield function in the Setup menu: press 
- Select “Device parameters”: press the ∇ soft key, then the \triangleright soft key
- Select **Draft shield**: press the \triangleright soft key

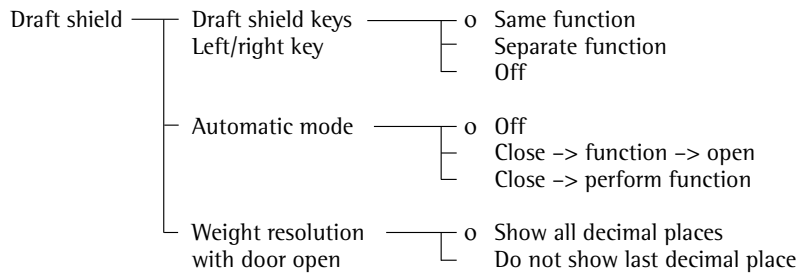

= factory setting

See also section on “Device Parameters” (Overview) in the chapter entitled “Configuring the Balance”

- Store settings and exit the Setup menu: press the \llcorner soft key

Assigning the Open Door Function to the ME215/235/414/614 models:

Example: Open and close top and right-hand draft shield doors using the right-hand \updownarrow key

Setting different from factory setting:
none

- If open, close all draft shield doors
- Apply moderate pressure to both door grips for top and right-hand draft shield doors (2 and 3) to move them simultaneously towards the back
- Press the right-hand \updownarrow key to save this door-opening mode; the doors now close. If you press the right-hand \updownarrow key afterwards, the top and right-hand doors will open and close.

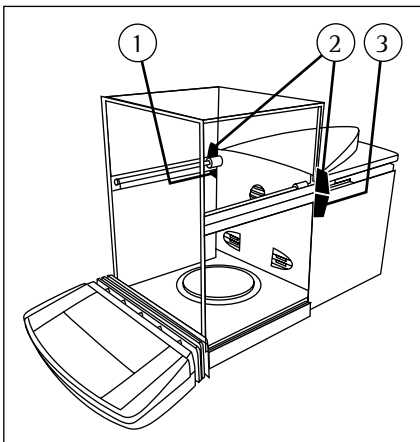

Example 2: Open and close right-hand draft shield door using the left-hand \updownarrow key. Open and close left-hand door using the right-hand \updownarrow key.

Change in factory settings: separate function

- If open, close all draft shield doors
- Apply moderate pressure to the right-hand draft shield door (3) to slide it toward the back so that the door is opened by motor.
- Press the left-hand \updownarrow key to save this door-opening mode; the door now closes. If you press the left-hand \updownarrow key afterwards, the right-hand draft shield door will open and close.
- Apply moderate pressure to the left-hand draft shield door (1) to slide it toward the back so that the door is opened by motor.
- Press the right-hand \updownarrow key to save this door-opening mode; the door now closes. If you press the right-hand \updownarrow key afterwards, the left-hand draft shield door will open and close.

**ME215/235/414/614 Models:
Static Electricity Eliminator
(Ionizer) **

Purpose
Ionization of air (i.e., charging the air with ions of both positive and negative charges) causes the air surrounding a sample to become electrically conductive. Charges are neutralized in the air stream or grounded.

Be especially careful when weighing electrostatically charged samples.

Features

- The ionizer can be turned on and off independently of the position of the draft shield doors
- When the draft shield doors are open, the static electricity eliminator (ionizer) will shut off after the preset time has elapsed. However, the ionizing time will start over if the static electricity eliminator is still running when a door closes.
- The static electricity eliminator (ionizer) can be configured in the Setup menu so that it will stay on only for a certain time.
- When the ionizer is active, this is indicated by the flashing symbol  (flashes from the outside toward the inside and vice versa)

Factory Setting for the Parameters

Static electricity eliminator (ionizer):
On: Auto off after 10 sec.

Configuring the Static Electricity Eliminator (Ionizer)

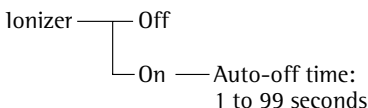

Function key  Ionizer key

Password

You can enter a password to block access to the menu parameter settings and to ID code and exact calibration weight inputs. See the detailed description in the chapter on “Configuring the Balance: Setting the Device Parameters.”

User ID

You can enter your own personal password (20 characters max.)

Clock

ISO/GLP printouts in particular must be generated with the date and time stamp of the specific measurement. This date and time stamp is optional on other printouts.

See the chapter on “Configuring the Balance: Setting the Device Parameters.”

Interfaces

Purpose
This item enables you to set the parameters for the following interfaces:

- Serial communications port
- Serial printer port
- External switch function
- Control port function

Serial Communications Port
You can set the serial communications port to use for the following modes:

- **SBI**
- **XBPI**
- **Sartonet**

Serial Printer Port
You can set the serial printer port to use for the following printers:

- **YDP01IS**
- **YDP02**
- **YDP03**
- **YDP01IS Label**
- **YDP02IS**
- **YDP02IS Label**
- **Universal**
- **YDP04IS**
- **YDP04IS Label**

External Universal Remote Switch
You can connect an external universal remote switch (foot switch or bar code scanner or an external keyboard) to one of the two serial ports. Then you can assign one of the following functions to be performed when the switch is activated:

- **Print key**
- **Tare key**
- **Cal key**
- **F1 function key**
- **CF key**
- **F2 function key**
- **Bar code scanner/extra keyboard** (requires a special connecting cable)
- **Ionizer key**
- **Right draft shield key**
- **Left draft shield key**

Control Port Function

You can connect either a checkweighing display or an external universal switch to the serial communications port on the balance (factory setting).

To do so, you need to configure the interface for **input** or **output**.

Pin Assignment Chart of the Female Interface Connector

Pin	Function: Input
15	E key; see "Universal switch"
16	Left $\uparrow\downarrow$ key
17	Soft key 6 (Cal) Print Mem Cal
18	Soft key 1 (F)
19	Tare key

Pin	Function: Output
15	"External switch" (see above)
16	Control port 1: lighter
17	Control port 2: equal
18	Control port 3: heavier
19	Control port 4: "set"

For further information on the pin assignment chart, see the section on "Pin Assignment Charts" in the chapter entitled "Overview".

Display

You can configure the display for your individual needs.

The contrast can be adjusted in 5 levels: **Contrast**

Characters can be displayed in black on white or vice versa: **Background**



You can blank out either the bar graph or the text line or both

Digit size

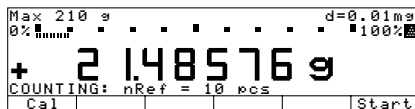

10mm + bar graph
+ text display

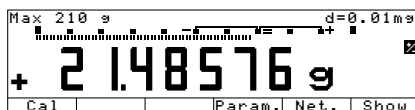

13mm + bar graph

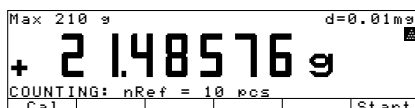

13mm + text display

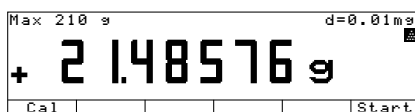

13mm

You can blank out the display of application symbols

Application symbols

Keys

You can assign different functions to the CF key for deleting input and applications.

When you delete applications, you can delete either the data stored for all applications or just selected data.

CF function in application

When you delete input, you can either delete all the data input in a field, or only the last character entered.

CF function for inputs

You can block key functions; you can choose whether to block all keys (except IO , Setup , draft shield left/right and ionizer) or just the alphanumeric keys.

Block key functions

Extra Functions

Acoustic Signal

An acoustic signal is emitted when you press a key. When the key pressed is allowed, the signal is a single beep-tone; when it is not allowed, this is signaled by a double-beep (key does not initiate a function). In the Setup menu, you can configure whether

- the acoustic signal should sound (On)
- the acoustic signal should not sound (Off)

Power-On Mode

You can configure the balance so that when a power supply is connected,

- the balance is off (Off/on/standby or Off/on)

- the balance switches on automatically (Auto on)

You can also set the configurations so that when the balance is turned off after use, it is

- off (Off/on)
- in the standby mode (Off/on/standby)

After you turn on the balance, a self-test of the functions is run (TEST is displayed in the text line; the bar graph is shown)

Calibration, Adjustment, Linearization

Purpose

Calibration is the determination of the difference between the weight readout and the true weight (mass) of a sample. Calibration does not entail making any changes within the balance.

Adjustment is the correction of this difference between the measured value displayed and the true weight (mass) of the sample, or the reduction of the difference to an allowable level within maximum permissible error limits.

Linearization is the procedure used to eliminate the deviation from weight readout plotted on the balance's ideal characteristic calibration curve and the actual weight readout. In other words, linearization reduces the amount of error of a weight displayed to its maximum permissible error limits. The ideal characteristic curve is a straight line plotted between zero load and maximum load.

Using Verified Balances as Legal Measuring Instruments in the EU*:

Before using your balance as a legal measuring instrument, you must perform "internal calibration" at the place of installation after the warmup period.

* including the Signatories of the Agreement on the European Economic Area

Features

You can configure whether the calibration mode

- will be activated according to the specific setting (external/internal) or

- can be selected by the user after pressing the **Cal** soft key:
Selection mode.

Your balance can be calibrated externally: (Balance menu: **CAL** key function; menu item **Ext. cal./adj.;** **factory-def. wt.** or **Ext. cal./adj.;** **user-defined wt.;** or internally: (**Internal cal./adjustment**).

- Adjustment can be performed
- automatically following calibration:
Cal., then auto adjust. or
 - if desired, the adjustment operation can be started manually after calibration:
Cal., then manual adjust

Linearization is performed if you have selected **Internal linearization** in the Setup menu or you have set this using the **Selection mode.**

You can have the balance automatically display an adjustment prompt after a certain time interval has elapsed since the last calibration/adjustment or when the ambient temperature changes by a defined amount.

You can also configure the balance to perform calibration and adjustment automatically (isoCAL) when the pre-set time and/or temperature limit is reached
On and reset application and **On without resetting app.** (see also page 55).

You can have the calibration/adjustment results documented in an ISO/GLP-compliant printout; see page 131.

Factory Settings of the Parameters

Calibration/adjustment mode:
Selection mode

Calibration/adjustment sequence:
Calibrate, then auto adjust

isoCAL function: **On without resetting application**

Start automatic adjustment: **isoCAL**

Print GLP/GMP calibration/adjustment record: **Automatic if GLP is selected**

Preparation

- Select the balance function for “calibration/adjustment”: press **Setup**
- To select the **Balance/scale functions**: press the **>** soft key
- Select **Calibration/adjustment**: press the **>** soft key

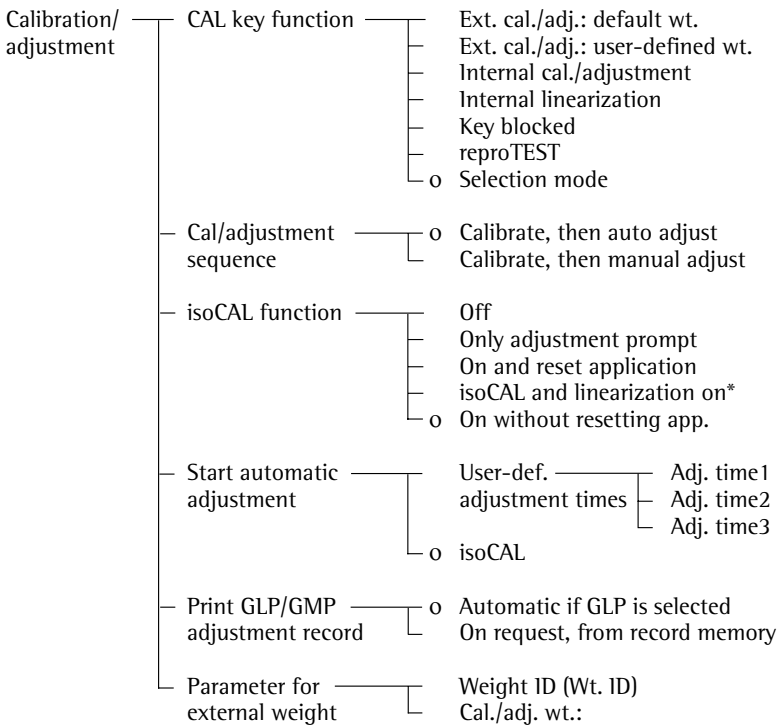

o = factory setting

* this deletes (resets) the application

- Save settings and exit Setup menu: press the **<<** soft key

Releasing Access to External Calibration

- Remove the cover plate from the back of the balance housing
- Move switch 1 in the direction of the arrow

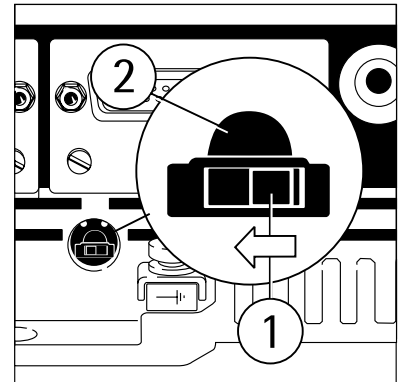

- > Switch left: external calibration accessible
- Switch right: external calibration blocked
- > Note: Do not move switch 2

Preparation

Example: Set the parameters for calibration and adjustment; e.g., with manual calibration/adjustment, isoCAL off

Step	Press key(s) (or follow instructions)	Display/Output
1. Switch on the balance, if not already on		Sartorius logo and self-test 
2. Select the Setup menu		
3. Select "Balance/scale functions"	> soft key	
4. Select "Calibration/adjustment"	> soft key	
5. Select CAL key function	> soft key	
		o = last setting selected
6. Select desired function and confirm (e.g., "Internal cal./adj.")	^ soft key, repeatedly, if necessary ↓ soft key	
7. Exit CAL key function	< soft key	
8. Select "Cal./adjustment sequence"	∨ soft key	



Selecting the Calibration/Adjustment Parameter

The setting **Selection mode** must be selected in the Setup menu (factory setting). After pressing the **Cal** soft key, you can choose from among the following settings by pressing the **Select** soft key:

- Internal calibration/adjustment:
Internal cal./adjustment
 - Internal linearization:
Internal lin.
 - Repeatability test
reproTEST
 - External calibration/adjustment with the preset calibration weight:
Ext. cal./adj.;
factory-def. wt.
 - External calibration/adjustment with a calibration weight determined by the user:
Ext. cal./adj.;
user-defined wt.
- Start the desired routine:
Press the **Start** soft key

In the selection mode: Perform external calibration followed by automatic adjustment with the factory-set weight

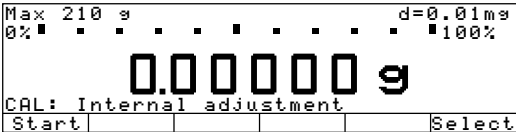
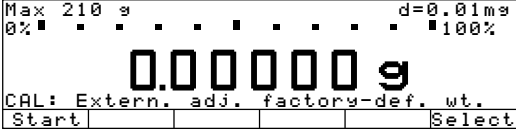
Configuration:
factory settings

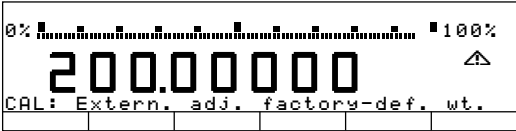
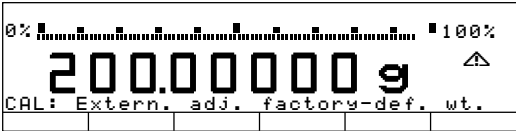
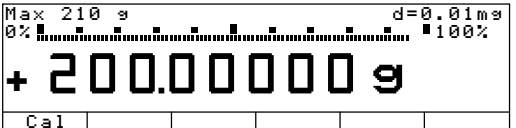
Step	Press key(s) (or follow instructions)	Display/Output
1. Select calibration	Cal soft key	
2. Select external calibration/adjustment with factory-defined weight	Select soft key 3 x	
3. Start external calibration/adjustment	Start soft key	
4. Place the weight on the balance (e.g., 200.00000 g) Minus sign -: Weight too low Plus sign + Weight too high no plus/minus sign: Weight o.k This is displayed after calibration, for approx. 10 seconds: (on verified balances, the difference between the displayed weight and the conventional mass value is displayed)	Place std. weight on balance	 
5. Unload the balance (ISO/GLP printout: see page 133)		

Internal Calibration/Adjustment

First set either **Internal cal./adjustment** or **Selection mode** (factory setting) in the Setup menu (Balance/scale functions: Calibration/adjustment: CAL key function).

Inside the balance housing are built-in motorized calibration/adjustment weights.

The internal calibration/adjustment sequence is as follows:

- Unload the balance
- Select the calibration function: press the **Cal** soft key and then the **Start** soft key
 - > The internal calibration weight is applied automatically
 - > The balance is calibrated
 - > If the setting **Calibrate, then auto adjust** (factory setting) is selected in the Setup menu, the balance is now automatically adjusted
 - > If the setting **Calibrate, then manual adjust** is selected in the Setup menu, the internal calibration routine is now ended without adjusting the balance (otherwise, see “Calibration and Adjustment Sequence,” on next page)
 - > The internal calibration weight is removed
 - > ISO/GLP printout: see page 133

Internal Linearization

In the Setup menu (Balance/scale functions: Calibration/adjustment: CAL key function), you need to have set **Internal linearization** or select this using the **Selection mode** (factory setting).

Inside the balance housing are built-in motorized calibration/adjustment weights for linearization.

The internal linearization sequence is as follows:

- Unload the balance
- Select the linearization function: press the **Cal** soft key, the **Select** soft key, and then the **Start** soft key
 - > The internal linearization weights are applied automatically.
 - > The balance is linearized
 - > The internal linearization weights are removed
 - > The balance is adjusted automatically following internal linearization
 - > ISO/GLP printout: see page 133

Calibration and Adjustment Sequence

In the Setup menu, you can configure the balance so that:

- calibration is always followed automatically by adjustment

Calibrate, then auto adjust (factory setting) or

- you have the choice of ending the sequence or starting adjustment after calibration **Calibrate, then manual adjust**

If no deviation is determined in calibration, or the deviation is within the tolerance limits dictated by the degree of accuracy you require, it is not necessary to adjust the balance. In this case, you can end the calibration/adjustment sequence after calibration. There are 2 soft keys active at this point:

- **Start** to start adjustment
- **End** to end the sequence

External Calibration/Adjustment with a User-Defined Calibration Weight

In the Set up menu (Balance/scale functions: Calibration/adjustment: CAL key function), you need to set **Ext. cal./adj.;** **user-defined wt.** or select this using the **Selection mode** (factory setting).

You can define a weight for adjustment. External adjustment must be performed with weights that are traceable to a national standard and that have error limits that are no greater than $1/3$ of the required tolerance of the display accuracy.

Sequence of external calibration (adjustment: see left column).
First select External adjustment:
User-def. wt.

The balance has a factory-set weight value (see "Specifications").

To reset a user-defined calibration weight to the original factory setting:

- Enter the factory-defined value manually (see "Specifications")

Define the Calibration Weight

Step	Press key(s) (or follow instructions)	Display/Output
1. Select Setup menu	Setup	<pre> SETUP Balance/scale functions Device parameters Application parameters Printout Device information << v >> </pre>
2. Select "Balance/scale functions"	> soft key	<pre> SETUP BAL.FUNC. Calibration/adjustment Adapt filter Application filter Stability range Taring << < v >> </pre>
3. Select "Calibration/adjustment"	> soft key	<pre> SETUP BAL.FUNC. CAL./ADJ. CAL/ISO/ST key function Cal/adjustment sequence isoCAL function Start automatic adjustment Print GLP/GMP adjustment record << < v >> </pre>
4. Select parameter for external weight	v soft key 5 x > soft key	<pre> BAL.FUNC. CAL./ADJ. PARAMETER Wt. ID (W ID): Cal./adj. wt.: 100.00000 g << < v >> </pre>
5. Select "Cal./adj. wt."	v soft key	<pre> BAL.FUNC. CAL./ADJ. PARAMETER Wt. ID (W ID): Cal./adj. wt.: 100.00000 g << < ^ >> </pre> <p>100.00000 = last setting selected</p>
6. Enter calibration weight (e.g., 200.00000 g) and save	(2) (0) (0) (.) (0) (0) (0) (0) (0)	<pre> BAL.FUNC. CAL./ADJ. PARAMETER Wt. ID (W ID): Cal./adj. wt.: 200.00000 g ESC ^ ↓ </pre>
7. Save the calibration weight	↓ soft key	<pre> BAL.FUNC. CAL./ADJ. PARAMETER Wt. ID (W ID): Cal./adj. wt.: 200.00000 g << < ^ >> </pre>
8. Exit the Setup menu	<< soft key	<pre> Max 210 g d=0.01mg 0% ■ ■ 100% 0.00000 g Cal </pre>

isoCAL: Automatic Calibration, Adjustment and Linearization

First set either **On and reset the application, isoCAL and linearization on** or **On without resetting the app.** (factory setting) in the "Setup: Balance/scale functions" menu.

The "isoCAL" display automatically begins flashing if the ambient temperature changes in relation to the temperature at the time of the last calibration/adjustment, or after a defined time interval has elapsed. The balance is telling you that it wants to adjust itself.

This automatic calibration and adjustment prompt is activated when:

- The change in temperature is greater than 1.5 Kelvin or the elapsed time interval is greater than 4 hours
- The balance Setup mode is not active
- No number or letter input is active
- The load has not been changed within the last 2 minutes
- The balance has not been operated within the last 2 minutes
- The load on the balance does not exceed 2% of the maximum capacity.
- When you turn on the balance after it has been disconnected from power (only on verified balance)

When these requirements are met, **C** is displayed in the line for measured values.

If the balance is not operated and the load is not changed, internal calibration and adjustment will start after 15 seconds have elapsed.

Automatic Calibration and Adjustment at Set Times *

- In the Setup menu, you can now enter up to three different times of day for automatic calibration/adjustment (see menu tree on page 50). When one of these times is reached, the balance displays the flashing calibration prompt ("isoCAL"). Calibration/adjustment is not performed if the balance is
- off (standby) or
 - in the Setup mode at the time set for calibration.

If the balance is being operated at the time set for automatic calibration/adjustment, the calibration/adjustment sequence will not be prompted or performed afterwards.

Automatic calibration/adjustment is prompted at set times when:

- The set time is reached
- The balance Setup mode is not active
- No alphanumeric input is active (e.g., equation for calculation)
- The load has not been changed within the last 2 minutes
- The balance has not been operated within the last 2 minutes
- The load on the balance does not exceed 2% of the maximum capacity

In the Setup menu, you can configure the balance so that after calibration and adjustment

- the application program is restarted **On and reset the application**
- isoCAL and linearization are activated and the application program must be restarted **isoCAL and linearization on**
- the application program remains at its previous status **On without resetting the app.**

Also in Setup, you can configure the balance so that it displays a calibration prompt, but does not perform the calibration/adjustment functions automatically: **Only adjustment prompt**

* = does not apply to verified balances

Calibration/Adjustment Printout

Data Block Printout

You can have the results of a calibration/adjustment procedure printed out. You can configure whether the printout is generated as soon as the procedure is completed, or whether a number of calibration/adjustment procedures (up to 50) are printed as a data block printout.

Data Block Printout of Calibration/Adjustment Data

With the following Setup menu configuration, you can store the data from up to 50 calibration/adjustment procedures and have them printed on request:

- isoCAL printout
On request, from record memory

When the memory contains 50 data records:

- additional records are output automatically

If at least one data block printout data record has been configured, the following soft keys are available after you press the **isoTST** soft key:

Info The number of records is displayed in the text line

PrtPro Print accumulated records

DelPro Delete accumulated records; records can only be deleted after a printout has been generated. If a password has been assigned in the Setup: Device parameters, you must enter either the configured password or the General Password before you can delete the records.

For internal calibration/adjustment, the initialization mode of the procedure is printed in the **Start** line.

```
-----  
13.03.2000      09:17  
      SARTORIUS  
Model          ME215S  
Ser. no.       60419914  
Ver. no.       01-41-02  
ID  
-----  
24.04.2000      12:03  
Start:         manual  
Diff. +        0.00001 g  
External calibration  
              completed  
  
25.04.2000      12:10  
Start:         isoCAL/temp  
Diff. +        0.00001 g  
Internal adjustment  
              completed  
Diff. +        0.00000 g  
  
25.04.2000      18:30  
Start:         Adj. time  
Diff. +        0.00001 g  
Internal adjustment  
              completed  
Diff. +        0.00000 g  
  
26.04.2000      9:37  
Start:         manual  
Diff. +        0.00001 g  
Internal adjustment  
              completed  
Diff. +        0.00000 g  
  
27.04.2000      11:53  
Start:         Ext.cal.  
W ID  
Nom + 2000.00000 g  
Diff. +        0.00001 g  
External adjustment  
              completed  
Diff. +        0.00000 g  
-----  
13.03.2000      09:17  
Name:  
-----
```

GLP header

List of Calibration/
Adjustment Procedures:
Example 1:
Internal calibration

Example 2:
isoCAL activated by difference
in temperature

Example 3:
isoCAL at defined time

Example 4:
Internal calibration/adjustment
activated manually

Example 5:
External calibration/adjustment

GLP footer

Repeatability Test (reproTEST)



Definition

Repeatability is the ability of the balance to display identical readouts when it is loaded several times with the same weight under constant ambient conditions. The standard deviation for a given number of measurements is used to quantify the repeatability.

Purpose

The “reproTEST” function automatically determines the repeatability (also called “reproducibility”) of results (based on 6 individual measurements). In this way, the balance determines one of the most important quantities in relation to the place of installation. The results are displayed with the balance’s accuracy.

Preparation

- Turn on the balance: press 
- > The Sartorius logo is displayed
- Select reproTEST in the Setup menu: press 
- Select “Balance/scale functions: Calibration/adjustment: CAL key function: use the $\triangleright \nabla$ soft keys
- Select either `reproTEST` or `Selection mode` (factory setting): see “Configuring the Balance”
- Exit the Setup menu: press the \ll soft key

Check the Repeatability of the Balance

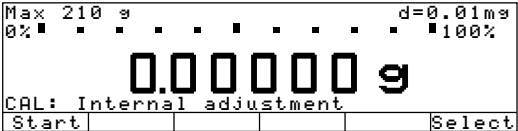
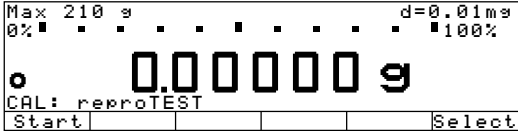
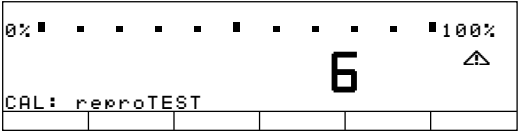
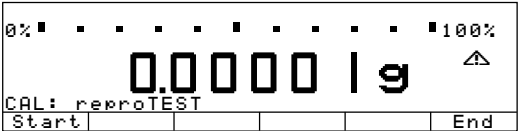
Step	Press key(s) (or follow instructions)	Display/Output
1. If <code>reproTEST</code> is set: and proceed with step 4. If <code>Selection mode</code> is set:	<code>Cal</code> soft key <code>Cal</code> soft key	
2. Select reproTEST	<code>Select</code> soft key	
3. Start reproTEST	<code>Start</code> soft key	
4. Number of the current measurement is displayed; in this example, the 6 th measurement will now be performed		
The standard deviation is displayed		
5. End reproTEST or restart reproTEST	<code>End</code> soft key <code>Start</code> soft key	

Restoring the Factory Settings

Each parameter has a factory setting. In the Setup menu, you can choose to have the following performed after confirming with **Yes**:

- Restore all factory settings in the Setup menu
(**F**a**c**t**o**r**y** **s**e**t**t**i**n**g**s)

Soft Key Functions

Sta**r**t Start application

Weighing Toggle to the basic weighing function

Auto-Start Application When the Power Goes On

In the Setup menu, you can select whether the last application active before you turn off the power starts automatically when the power is turned on again (Setup: Application parameters: Auto-start app. when power goes on: On)

Using Verified Balances as Legal Measuring Instruments in the EU*: You can select any application program on a verified balance. Non-metric weights are identified by the following symbols:

- Percent = %
- Piece count (counting) = pcs
- Calculated values = □, △

* including the Signatories of the Agreement on the European Economic Area

Toggle between Two Weight Units, U1 U2

Purpose

With this application, you can switch the display of a weight value back and forth between two weight units by pressing a soft key.

You can use this application in combination with any program chosen from Application 2 (checkweighing, time-controlled functions) and one from Application 3 (totalizing, formulation, statistics), as well as with the extra functions.

Features

- Toggling the displayed weight
- Setting the display accuracy
- Other features as for the basic weighing function

Factory Settings of the Parameters

ME215/235/254/414/614:

Weight unit 1: **Grams** /g

ME5, ME2:

Weight unit 1:

Milligrams /mg

Display accuracy 1: **All digits**

Weight unit 2: **Milligrams** /mg

Display accuracy 2: **All digits**

* including the Signatories of the Agreement on the European Economic Area

Preparation

Balances used as legal measuring instruments in the EU*: grams, carats and milligrams are the only weight units available

Standard balances: All weight units listed below:

Unit	Conversion factor	Display/Printout	Line for metrological data
Grams	1.0000000000	g	g
Kilograms #	0.0010000000	kg	kg
Carats	5.0000000000	ct	ct
Pounds	0.00220462260	lb	lb
Ounces	0.03527396200	oz	oz
Troy ounces	0.03215074700	ozt	ozt
Hong Kong tael	0.02671725000	tlh	tlh
Singapore tael	0.02645544638	tls	tls
Taiwanese tael	0.02666666000	tlt	tlt
Grains	15,43235835000	GN	GN
Pennyweights	0.64301493100	dwt	dwt
Milligrams	1000.0000000000	mg	mg
Parts per pound	1.12876677120	/lb	lb
Chinese tael	0.02645547175	tlc	tlc
Momme	0.26670000000	mom	M
Austrian carats	5.00000000000	K	K
Tola	0.08573333810	tol	tol
Baht	0.06578947437	bat	bat
Mesghal	0.21700000000	MS	MS

- Select the Toggle Weight Units application in the Setup menu: press **Setup**
- Select **Application parameters**: press the **v** soft key 2 x, then the **>** soft key once
- **Application 1 (basic settings)**: press the **>** soft key
- Select **Toggle wt. units**: (repeatedly) press the **^** or **v** soft key
- Confirm **Toggle wt. units**: press the **>** soft key

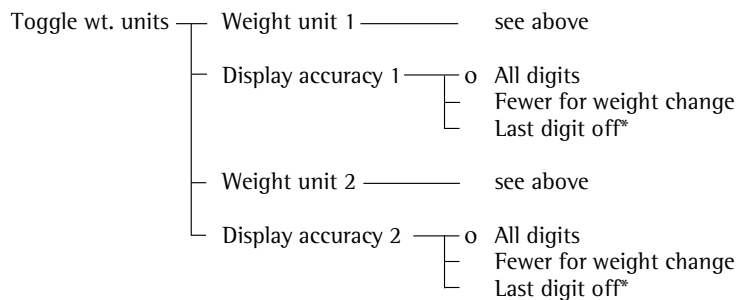

o = factory setting

* = not for verified balances used as legal measuring instruments

= not on ME5, SE2

see also "Application Parameters (Overview)" in the chapter entitled "Configuring the Balance"

- Save settings and exit the Setup menu: press the **<<** soft key

Additional Functions

In addition to the functions for:

- alphanumeric input,
- taring (not during alphanumeric input),
- printing (NUM print; S ID),

you can also access the following functions from this application: Calibration/Adjustment

- Press the **Cal** soft key
- > See “Calibration, Adjustment and Linearization” for further instructions

Toggling to the Next Application

- Press **CF**
- > See the section on the corresponding application program for further instructions

Setup (Setting Parameters)

- Press **Setup**
- > See “Configuring the Balance” for further instructions

Turning Off the Balance

- Press **Off**
- > The balance shuts off
- > The display goes blank, then standby or off is displayed with backlighting

Example

Toggle the Display from Grams [g] (1st Unit) to Carats [ct] (2nd Unit)

Settings (changes in the factory settings required for this example):

Setup: Application parameters: Application 1: Toggle wt. units: Weight unit 2: Carats/ct

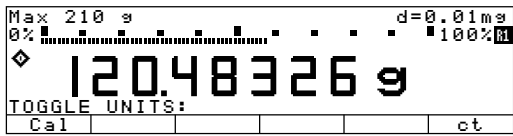
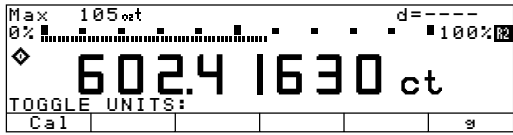
Step	Press key(s) (or follow instructions)	Display/Output
1. Toggle back to the basic unit (U1:Weight unit 1)	CF	 <p>The display shows: Max 210 g, d=0.01mg, 0% 100%, 120.48326 g, TOGGLE UNITS: Cal ct</p>
2. Change weight unit to carats [ct] (U2:Weight unit 2)	ct soft key	 <p>The display shows: Max 105ct, d=---, 0% 100%, 602.41630 ct, TOGGLE UNITS: Cal g</p>
3. Change weight unit to grams [g]	g soft key	

Counting

Purpose

With this application, you can determine the number of pieces of approximately equal weight.

You can use this application in combination with a program chosen from Application 2 (checkweighing, time-controlled functions) and one from Application 3 (totalizing, formulation, statistics), as well as with the extra functions.

Features

- Optional balance configuration in Setup for automatically initializing this application and loading the most recent reference sample quantity "nRef" and average piece weight "wRef" when you switch on the balance (this is the automatic setting when the balance is initialized; Setup menu: Application parameters: Auto-start app. when power goes on: On)
- Reference sample quantity "nRef" entered manually
- Average piece weight "wRef" entered manually
- Storage of the current weight value for the preset reference sample quantity "nRef," to be loaded when the Counting program is initialized
- Setting the accuracy when the reference sample weight "wRef" is stored for calculating a piece count
- Automatic output of the quantity and sample weight via the data interface port after initialization or reference sample updating while running the Counting program (Printout: Application-defined printout: Auto print upon initialization: All values)
- Toggling between piece count and weight value by pressing the **COUNT.** or **WEIGH.** soft key
- Toggling between counting and additional applications using the  key (for example, checkweighing)

Factory Settings of the Parameters

Accuracy when calculating piece weight:
Display accuracy

Reference sample updating:
Automatic

Soft Key Functions

nRef Store value input as reference sample quantity

wRef Store input value as reference sample weight

Update Reference updating criteria met; reference updating can be performed to optimize the accuracy

COUNT. Toggle to the Counting application

WEIGH. Toggle to the Weighing mode

Start Store current weight value for preselected piece count

Preparation

To calculate a piece count, the average weight of one piece must be known.

This average piece weight can be entered into the Counting program in one of three ways:

- Enter the average piece weight using the numeric keys and store it;
- The last reference sample quantity entered is loaded and displayed when you turn on the balance. Place the same number of parts on the balance and initialize the Counting program;
- When the automatic initialization parameter (see previous page), is on (Setup: > Printout: Application-defined output: Autoprint upon initialization: All values; see page 34), the balance goes into the "counting" mode when you turn it on and loads the last average piece weight and corresponding reference sample quantity that were entered or calculated.

Reference Sample Updating

You can have the average piece weight updated during counting (with the piece count displayed) if "AWP update" is set to "manual" or "automatic" in the Setup menu.



Manual updating can only be performed when the **Update** soft key is displayed.

Reference sample updating must be completed before using an application program from Application 3.

The **Update** soft key is displayed when:

- the balance has stabilized (stability symbol displayed)
- the current piece count is not more or less than double the original piece count
- the current piece count is more than 100
- the internally calculated piece count (e.g., 17.24) differs from the nearest whole number (in this case: 17) by less than ± 0.3

Reference updating can be repeated several times with an approximately doubled piece count.

- To perform reference updating: press the **Update** soft key
- Turn on the balance: press 
- > The Sartorius logo is displayed
- Select the Counting application in the Setup menu: press 
- Select the **Application parameters**: press the \vee key 2x, then the \rightarrow soft key once
- Select **Application 1 (basic settings)**: press the \rightarrow soft key
- Select **Counting**: repeatedly press the \wedge or \vee soft key
- Confirm **Counting**: press the \rightarrow soft key

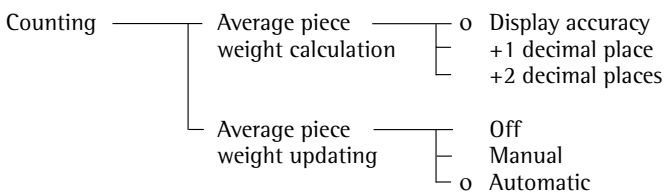

○ = factory setting

see also the "Application Parameters (Overview)" in the chapter entitled "Configuring the Balance"

- Save settings and exit the Setup menu: press the \ll soft key

Additional Functions

In addition to the functions for:

- alphanumeric input,
- taring (not during alphanumeric input),
- printing,

you can also access the following functions from this application:

Calibration/Adjustment

- Press the **Cal** soft key
- > See "Calibration/Adjustment" for further instructions

Toggling to the Next Application

- Press 
- > See the section on the corresponding application program for further instructions

Setup (Setting Parameters)

- Press 
- > See "Configuring the Balance" for further instructions

Turning Off the Balance

- Press 
- > The balance shuts off
- > The display goes blank, then standby or off is displayed with backlighting

Example

Determining an Unknown Piece Count; Weighing-In the Preset Reference Sample Quantity

Settings (changes in the factory settings required for this example):

Setup: Application parameters: Application 1: Counting: Average piece weight updating: Manual

Setup: Application-defined output: Auto print upon initialization: All values

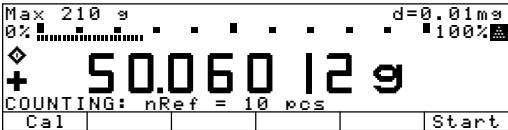
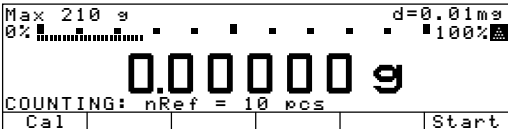
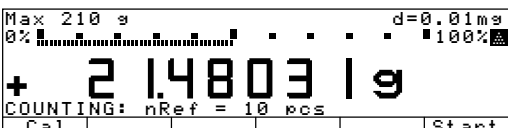
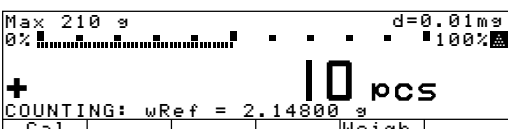
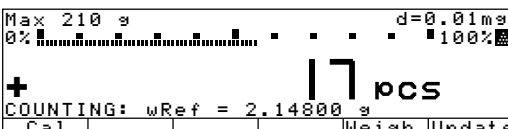
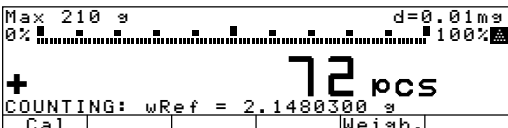
Step	Press key(s) (or follow instructions)	Display/Output
1. Delete previous values if necessary	CF	
2. Prepare a container for the parts to be counted	Place the empty container on the balance	 <p>Max 210 g d=0.01mg 0% 100% + 50.06012 g COUNTING: nRef = 10 pcs Cal Start</p>
3. Tare the balance	Tare	 <p>Max 210 g d=0.01mg 0% 100% 0.00000 g COUNTING: nRef = 10 pcs Cal Start</p>
4. Place the reference sample quantity on the balance (example: nRef = 10 pcs)	Place the displayed number of parts in the container	 <p>Max 210 g d=0.01mg 0% 100% + 2.148031 g COUNTING: nRef = 10 pcs Cal Start</p>
5. Determine the average piece weight (number of decimal places displayed depends on the balance model) (If you do not need a printout, select this setting in the Setup menu)	Start soft key	 <p>Max 210 g d=0.01mg 0% 100% + 10 pcs COUNTING: wRef = 2.14800 g Cal Weigh.</p> <pre> nRef + 10 pcs wRef +2.1480300 g </pre>
6. If necessary, increase the number of parts and perform reference sample updating (example: 7 additional parts)	Place additional parts in the container Update soft key 7 additional parts)	 <p>Max 210 g d=0.01mg 0% 100% + 17 pcs COUNTING: wRef = 2.14800 g Cal Weigh.Update</p> <pre> nRef + 17 pcs wRef +2.1480300 g </pre>
7. Weigh uncounted parts	Place parts to be counted in the container	 <p>Max 210 g d=0.01mg 0% 100% + 72 pcs COUNTING: wRef = 2.1480300 g Cal Weigh.</p>
8. If desired, print total piece count (here: 72 pcs)	Print	<pre> Qnt + 72 pcs </pre>

Weighing in Percent %

Purpose

This application allows you to obtain weight readouts in percent that are in proportion to a reference weight. Alternatively, you can have the value displayed as a difference in percent between the weight on the balance and the reference weight, or as a special ratio1 or ratio2.

You can use this application in combination with any program chosen from Application 2 (checkweighing, time-controlled functions) and one from Application 3 (totalizing, formulation, statistics) as well as with the extra functions.

Features

- Reference percentage "pRef" loaded from long-term memory when you turn on the balance
- Automatic initialization of this application and loading the most recent reference percentage "pRef" entered with reference weight "Wxx%" when you turn on the balance (Setup: Application parameters: Auto-start app. when power goes on: On)
- Value displayed as:
 - Residual quantity (portion)
 - Difference (deviation)
 - Ratio1
 - Ratio2depending on the selected Setup menu code
- Reference percentage "pRef" entered manually
- Store the current weight as the reference percentage weight "Wxx%" for initializing the weighing-in-percent application program
- Reference weight "Wxx%" entered manually
- Parameter for "Weight storage accuracy" (rounding-off factor) for storing the reference weight "W100%" in percentage calculation can be configured
- Configuration of decimal places displayed with a percentage
- If selected in the Setup menu, automatic output of the reference weight "Wxx%" and reference percentage in the text line and via the data interface port after initialization of the weighing-in-percent program (Setup: Printout: Application-defined output: Auto print upon initialization: All values)
- Toggle the display between percentage and weight readout by pressing the **Weigh.** or **Perc.** soft key
- Toggle between the weighing-in-percent program and other applications (e.g., checkweighing) by pressing 

Factory Settings of the Parameters

Storage parameter:

Display accuracy

Digits displayed with percentage:

2 digits

Display calculated value: **Residue**

Soft Key Functions

pRef Store value input as reference percentage

Wxx% Store input value as reference sample weight

Perc. Toggle to the weighing-in-percent application

Restar Start next weighing operation

Weigh Toggle to the weighing application

Start Store current weight value for preselected percentage

Preparation

To calculate a value in percent, the reference percentage must be known.

This value can be entered into the weighing-in-percent program in one of three ways:

- The last reference percentage entered is loaded and displayed when you turn on the balance. Place the corresponding weight on the weighing platform and initialize the weighing-in-percent program;
- With automatic initialization switched on (see previous page), the balance goes into the “weighing in percent” mode when you turn on the power and loads the last reference percentage entered as well as the corresponding reference weight (Setup: Printout: Application-defined output: Auto print upon initialization: All values);
- Enter the reference weight using the numeric keys and store it (M x x % soft key).

● Turn on the balance: press (I/O)

> The Sartorius logo is displayed

● Select the Weighing in Percent application (“Percent weigh”) in the Setup menu: press (Setup)

● Select **Application parameters**: press the v soft key 2 x, then the > soft key once

● Select **Application 1 (basic settings)**: press the > soft key

● Select **Percent weigh.**: repeatedly press the ^ or v soft key

● Confirm **Percent weigh.**: press the > soft key

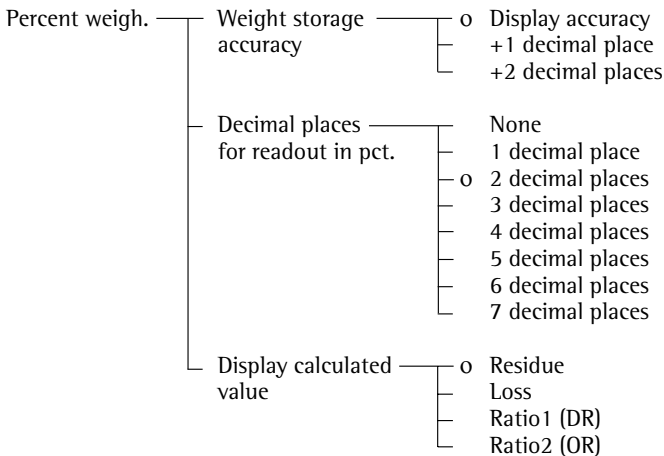

o = factory setting

see also the “Application Parameters (Overview)” in the chapter entitled “Configuring the Balance”

● Save settings and exit the Setup menu: press the << soft key

Equations

The following equations are used for the corresponding calculations:

Residue (weighing in percent) = Current weight / 100% weight x 100%

Loss (percent-DIFF:) = (Current weight – 100% weight) / 100% weight x 100%

Ratio1 (percent-Ratio 1:) = (100% weight – current weight) / current weight x 100%

Ratio2 (percent Ratio 2:) = 100% weight / current weight x 100%

Additional Functions

In addition to the functions for:

- alphanumeric input,
- taring (not during alphanumeric input),
- printing,

you can also access the following functions from this application:

Calibration/Adjustment
● Press the Cal soft key

> See “Calibration/Adjustment” for further instructions

● Press (T) Toggling to the Next Application

> See the section on the corresponding application program for further instructions

● Press (Setup) Setup (Setting Parameters)

> See “Configuring the Balance” for further instructions

● Press (I/O) Turning Off the Balance

> The balance shuts off

> The display goes blank, then OFF or Standby is displayed with backlighting





Examples

Weighing in Percent with Reference Weight Taken from Weight on Balance

Settings (changes in the factory settings required for this example):

Setup: Application parameters: Application 1: Percent weigh.

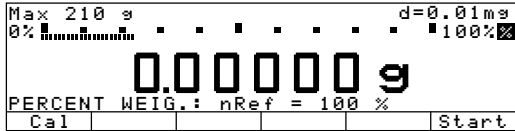
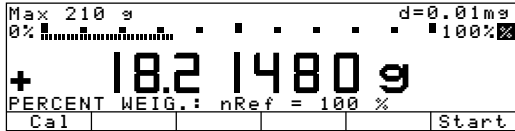
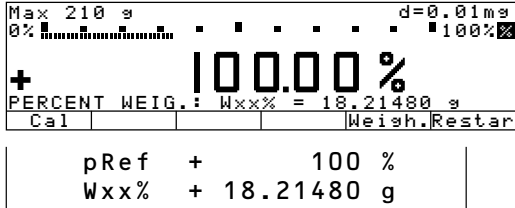
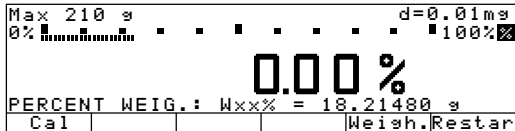
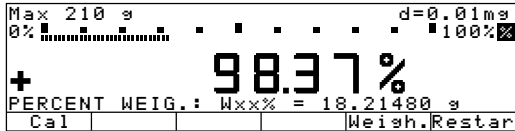
Setup: Printout: Application-defined output: Auto print upon initialization: All values

Step	Press key(s) (or follow instructions)	Display/Output									
1. Delete previous values, if necessary											
2. Prepare a container for the parts	Place the empty container on the balance	 <p>Max 210 g d=0.01mg 0% 100% + 50.06018 g PERCENT WEIG.: pRef = 100 % Cal Start</p>									
3. Tare the balance		 <p>Max 210 g d=0.01mg 0% 100% 0.00000 g PERCENT WEIG.: nRef = 100 % Cal Start</p>									
4. Place the reference weight on the balance (example: 18.21480 g equals 100%)	Place weight equal to reference weight in the container	 <p>Max 210 g d=0.01mg 0% 100% + 18.21480 g PERCENT WEIG.: nRef = 100 % Cal Start</p>									
5. Initialize the balance	Start soft key	 <p>Max 210 g d=0.01mg 0% 100% + 100.00 % PERCENT WEIG.: Wxx% = 18.21480 g Cal Weigh.Restar</p> <table border="1" style="margin-left: auto; margin-right: auto;"> <tr> <td>pRef</td> <td>+</td> <td>100 %</td> </tr> <tr> <td>Wxx%</td> <td>+</td> <td>18.21480 g</td> </tr> </table>	pRef	+	100 %	Wxx%	+	18.21480 g			
pRef	+	100 %									
Wxx%	+	18.21480 g									
6. Unload the balance	Remove reference sample from the container	 <p>Max 210 g d=0.01mg 0% 100% 0.00 % PERCENT WEIG.: Wxx% = 18.21480 g Cal Weigh.Restar</p>									
7. Determine the percentage of an unknown weight	Place sample to be measured in the container	 <p>Max 210 g d=0.01mg 0% 100% + 98.37 % PERCENT WEIG.: Wxx% = 18.21480 g Cal Weigh.Restar</p>									
8. If desired, print percentage (in this case: 98.37%)		<table border="1" style="margin-left: auto; margin-right: auto;"> <tr> <td>pRef</td> <td>+</td> <td>100 %</td> </tr> <tr> <td>Wxx%</td> <td>+</td> <td>18.21480 g</td> </tr> <tr> <td>Prc</td> <td>+</td> <td>98.37 %</td> </tr> </table>	pRef	+	100 %	Wxx%	+	18.21480 g	Prc	+	98.37 %
pRef	+	100 %									
Wxx%	+	18.21480 g									
Prc	+	98.37 %									

Calculation $\frac{\text{g}}{\text{m}^2}$

Purpose

With this application you can calculate a weight value using an algebraic equation. This can be used, for example, to determine the weight per unit area or "gsm" weight (grams per square meter) of paper.

You can use this application in combination with any program chosen from Application 2 (checkweighing, time-controlled functions) and one from Application 3 (totalizing, formulation, statistics) as well as with the extra functions.

Features

- You can store an equation and configure the Setup menu to initialize this program automatically with the stored equation
- The \square symbol is displayed to indicate a calculated value; the equation used is displayed in the text line
- If no equation was entered, the weight value is displayed
- Toggle between the weight readout, equation input and display of the calculated result by pressing the corresponding soft keys (or press CF to toggle between weight and calculated value)
- There are four operators (+, -, *, /) and one factor (weight value) available when you enter an equation
- Max. equation length: 28 characters
- Pressing CF will delete either the equation or the last character entered, depending on the configuration in the Setup menu (Setup: Device parameters: Keys: CF function for inputs: Delete last character)
- The calculated result is displayed with the number of decimal places configured in the Setup menu. Not all decimal places are displayed if the result is longer than the display allows. If there are more digits before the decimal point than the display can show, an error message is displayed
- The equation is stored in non-volatile memory

Factory Settings of the Parameters

Decimal places in calculated result:
2 decimal places

Soft Key Functions

- | | |
|---------------|---|
| Equat. | Toggle to equation |
| + | Enter an addition operator in the equation |
| - | Enter a subtraction operator in the equation |
| * | Enter a multiplication operator in the equation |
| / | Enter a division operator in the equation |
| Start | Start calculation |
| Weigh | Toggle to the weighing mode |
| Weight | Enter a weight operand in the equation |



Printout for Calculation

The calculation result is printed.

Res + 693.88 \square

Res: Result of calculation with equation

Preparation

- Turn on the balance: press 
- > The Sartorius logo is displayed
- Select the Calculation application program in the Setup menu: press 
- Select the **Application parameters**: press the ∇ soft key 2 x, then the \rightarrow soft key once
- Select **Application 1 (basic settings)**: press the \rightarrow soft key
- Select **Calculation**: press the \uparrow or ∇ soft key, repeatedly, if necessary
- Confirm **Calculation**: press the \rightarrow soft key

Calculation	Decimal places in calculated result	None
		1 decimal place
		o 2 decimal places
		3 decimal places
		4 decimal places
		5 decimal places
		6 decimal places
		7 decimal places

o = factory setting

see also the "Application Parameters (Overview)" in the chapter entitled "Configuring the Balance"

- Save settings and exit the Setup menu: press the $\leftarrow \leftarrow$ soft key

Additional Functions

In addition to the functions for:

- alphanumeric input,
- taring (not during alphanumeric input),
- printing,

you can also access the following functions from this application:

Calibration/Adjustment

- Press the **Cal** soft key

> See "Calibration/Adjustment" for further instructions

Toggle to the Next Application

- Press 

> See the section on the corresponding application program for further instructions

Setup (Setting Parameters)

- Press 

> See "Configuring the Balance" for further instructions

Turning Off the Balance

- Press 

> The balance shuts off









> The display goes blank, then OFF or Standby is displayed with backlighting

Example

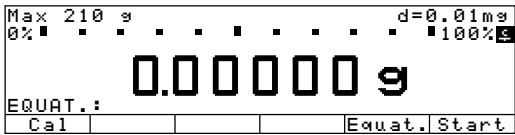
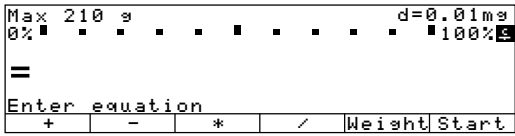
Calculate the weight per unit area (grammage or gsm weight) of paper: determine the gsm of a sheet of A4 paper with the dimensions $0.210 \text{ m} \times 0.297 \text{ m} = 0.06237 \text{ m}^2$. The gsm weight is a product of the division of the weight by the surface area.

Settings (changes in the factory settings required for this example):

Setup: Application parameters: Application 1: Calculation

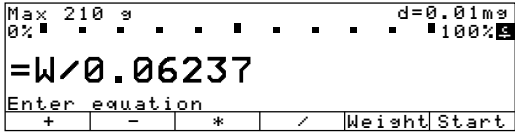
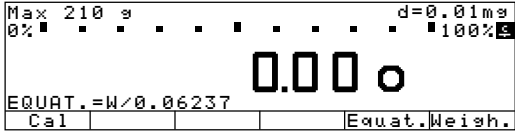
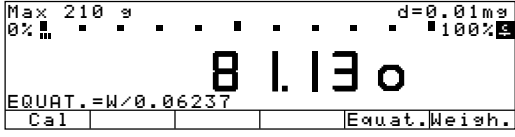
Step	Press key(s) (or follow instructions)	Display/Output
1. Turn on the balance and configure the settings as indicated above		
2. Delete previous values, if necessary		
3. Tare the balance		
4. Select equation input	Equat. soft key	
5. Enter weight value Enter division sign Enter the area of a sheet of A4 paper	Weight soft key / soft key      	
6. Turn on the calculated result display	Start soft key	
7. Determine the gsm weight	Place A4 sheet on the balance	

Density Determination

Purpose

With this application you can determine the density and volume of solid, pasty, liquid or powdered samples.

You can use this application in combination with any program chosen from Application 2 (e.g., checkweighing, timer functions) and one from Application 3 (totalizing, formulation, statistics) as well as with the extra functions.

Features

- Choose from 2 methods for determining density of solids:

- Buoyancy, or

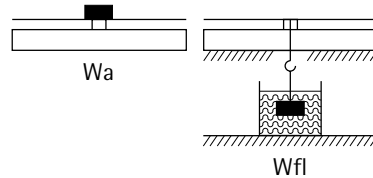

- displacement.

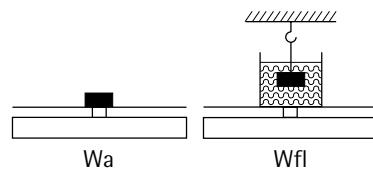

- Density determination of powdered or pasty samples using the pycnometer method

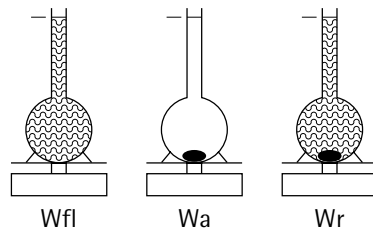

- Density determination of liquids using the liquid density method

- Choice of liquids for buoyancy:

- Water
- Ethanol
- Other liquids (user-definable)

- Reference values can be entered using the numeric keys

- Weight of sample in air (W_a)
- Weight of sample in liquid, or weight of reference liquid when using the pycnometer (W_{fl})
- Weight of sample and reference liquid when using the pycnometer (W_r)

- Long-term storage of parameters:

- Temperature
- Air buoyancy correction
- Air density
- Density of reference liquid
- Expansion coefficient
- Plummet volume

Factory Settings of the Parameters

Method: **Buoyancy**

Liquid causing buoyancy: **Water**

No. of decimals for display of vol. density: **2 decimals**

Printout: **None**

Soft Key Functions

Wa Store weight of sample in air

Wfl With liquid density, buoyancy and displacement methods:
- Store weight of sample in liquid

With pycnometer method:

- Store weight of reference liquid

Wr With pycnometer method:
Store weight of sample and liquid

Start Start a new measurement routine

Param. Toggle to parameter input mode (depending on method selected)

Densit Display the density (the parameters set remain effective for the next measurement)

Weigh Display the weight (the parameters set remain effective for the next measurement)

Vol. Display the volume (the parameters set remain effective for the next measurement)

Equations Used to Determine Density

Buoyancy:
$$\text{Rho} = (\text{Wa} \cdot (\text{Rhofl} - \text{LA})) / ((\text{Wa} - \text{Wfl}) \cdot \text{Corr}) + \text{LA}$$

For the buoyancy method, a factor of 0.99983 (factory setting) is used to allow for the buoyancy caused by the bars of the sample holder of the YDK 01 (LP) Density Determination Kit. This factor is yielded by allowing for this equation:

$$\text{buoyancy of bars/wires} = 2 \cdot d^2 / D^2 (\text{Wa} - \text{Wfl})$$

The equation considers the following variables: the number of bars or wires, the bar/wire diameter of the sample holder, and the inner diameter of the vessel used.

The correction factor 0.99983 is yielded by $1 - 2 \cdot d^2 / D^2$

where: 2 = number of wires/bars
 d = bar diameter (0.7 mm) for YDK01
 D = inner diameter of the vessel (76 mm) for YDK01

If you are using different vessels or other density kits, press the **PARAM** soft key to enter any necessary changes to this calculation factor.

To determine the density of a solid according to the buoyancy method with our YDK 01 (LP) Density Determination Kit, make sure to use the beaker with a 76 mm diameter.

Displacement:
$$\text{Rho} = (\text{Wa} \cdot (\text{Rhofl} - \text{LA})) / (\text{Wfl} \cdot \text{Corr}) + \text{LA}$$

For the displacement method, a factor of 1.00000 (factory setting) is used to allow for the buoyancy caused by a wire suspended in the liquid.

If you are using different vessels or other density kits, press the **PARAM** soft key to enter any necessary changes in this calculation factor.

The equation considers the following variables: the number of wires or bars, the wire/bar diameter of the sample holder, and the inner diameter of the vessel used.

This factor is yielded by: $\text{Corr} = 1 - \chi \cdot d^2 / D^2$



where: χ = number of wires
 d = wire diameter
 D = inner diameter of the vessel

Rhofl = density of the liquid causing buoyancy
Wa = weight of sample in air
Wfl = weight of the sample in liquid/buoyancy of sample
Corr = correction for buoyancy produced by the immersed wires or bars of the sample holder:
- = 0.99983 for the buoyancy method
- = 1 for the displacement method
LA = correction for air buoyancy = 0.0012 g/ccm

Pycnometer:
$$\text{Rho} = (\text{Wa} \cdot (\text{Rhofl} - \text{LA})) / (\text{Wfl} + \text{Wa} - \text{Wr}) + \text{LA}$$

where: Rhofl = density of the reference liquid
Wa = weight of the sample
Wfl = weight of the reference liquid
Wr = weight of sample + the reference liquid
LA = correction for air buoyancy = 0.0012 g/ccm

Preparation

- Turn on the balance: press 
- > The Sartorius logo is displayed; the self-test is performed
- Select the Density application in the Setup menu: press 
- Select the **Application parameters**: press the ∇ soft key 2 x, then the \rightarrow soft key once
- Select **Application 1 (basic settings)**: press the \rightarrow soft key
- Select **Density**: press the Δ or ∇ soft key, repeatedly, if necessary
- Confirm **Density**: press the \rightarrow soft key

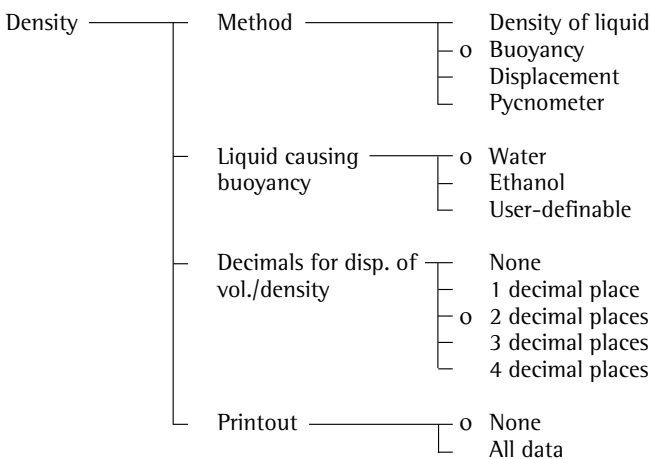

o = factory setting

see also the "Application Parameters (Overview)" in the chapter entitled "Configuring the Balance"

- Save settings and exit the Setup menu: press the $\leftarrow \leftarrow$ soft key

Additional Functions

- In addition to the functions for:
- alphanumeric input,
 - taring (not during alphanumeric input),
 - printing,

you can also access the following functions from this application:

Calibration/Adjustment

- Press the **CAL** soft key

> See "Calibration/Adjustment" for further instructions

Toggle to the Next Application

- Press 

> See the section on the corresponding application program for further instructions

Setup (Setting Parameters)

- Press 

> See "Configuring the Balance" for further instructions

Turning Off the Balance

- Press 

> The balance shuts off

> The display goes blank, then OFF or Standby is displayed with backlighting



Example

Buoyancy: Determine the Density of Samples of a Solid Using the Buoyancy Method. Reference Liquid: Water

Settings (changes in the factory settings required for this example):

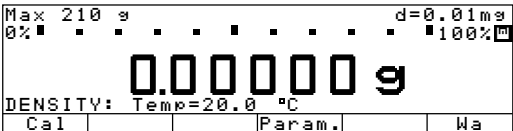
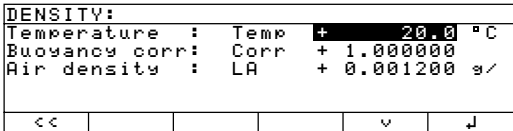
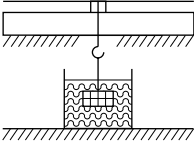
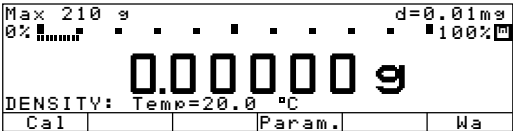
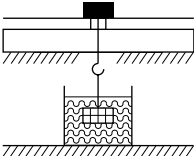
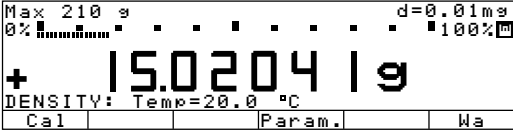
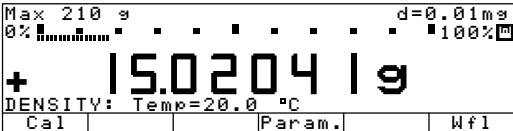
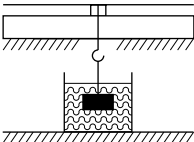
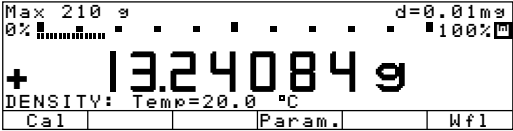
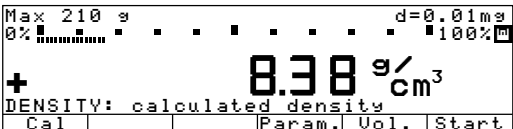
Setup: Application parameters: Application 1: Density

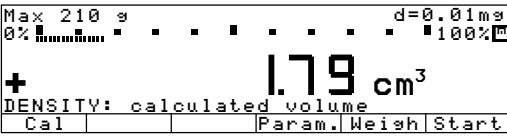
Step	Press key(s) (or follow instructions)	Display/Output
1. Delete previously stored values if necessary	CF	
2. Change parameters, if necessary	Param. soft key	
3. Position the sample holder (immerse in water)		
4. Tare the balance	Tare	
5. Determine the weight of the sample in air: place sample on the weighing pan		
6. Store weight value	Wa soft key	
7. Determine the weight of the sample in liquid: place sample in the sample holder		
8. Store weight value in liquid Density of sample is displayed	Wf1 soft key	

Step	Press key(s) (or follow instructions)	Display/Output
9. Display volume of sample	V o l . soft key	
10. Display weight	W e i g h soft key	
11. Repeat procedure with next sample, if desired	S t a r t soft key	

Differential Weighing ↗

Purpose

This application enables you to compare samples before and after a given treatment (such as drying or ashing) and determine the difference in weight.

There are different procedures available for this application:

- Collect all data (tare, initial weight, and backweighing result) for each sample individually (menu setting "Weighing sequence: Individual weighing")
- Save the tare weights and initial weights for all samples first, then perform backweighing (menu setting "Combined weighing")
- Save the tare weights for all samples first, then determine the initial weight of each sample and, finally, perform backweighing (serial weighing)

Features

- 4 different sequences for measuring the tare weights, initial sample weights and the backweights (backweighing result):
 - Individual weighing
 - Consecutive individual weighing
 - Combined weighing
 - Serial weighing
- Choice of weighing sequence by selecting this parameter in the Setup menu or by pressing the **W.S.EQ** soft key (if the "Weighing sequence key" option is set)
- Perform up to 99 backweighing routines on a single sample
- Differential weighing with or without tare weighing (not necessary for measuring coatings or lamination layers)
- Define the number of decimal places displayed for calculated results
- Define whether autosaving weight values is dependent on the stability parameter
- Define whether the minimum load for autosave is dependent on the display
- List function, with
 - Display page for lots:
Lists all lots (up to 100 max.) with the number of samples in each lot and the processing status (tare weight, initial weight, backweighed residue ("backweight"))
View, create, rename or delete lots generated
Enter or change a factor for calculation of results
 - Display page for samples:
Lists all samples (up to 999 max.) with processing status
View, delete, omit, or include samples
 - Display page for measured values:
Shows date, time, ID and values measured
 - Display page for results:
Values calculated for a sample (backweight, loss, ratio1, ratio2)

- Special display page for statistics lets you define whether lot statistics are dependent on backweight, loss, or ratio values
- Press a soft key to view the desired display page (lots, samples, values or results)
- To view lot, sample or measured value data, enter the ID and then press the corresponding soft key (**Lot/Sample/Values**)
- Define whether printer output is dependent on the processing status of the sample
- Printout can contain individual values, backweighed values and statistics
- User-definable printout format
- The configurations for the weighing sequence and results are saved separately for each lot

Differential Weighing: Defining the Weighing Sequence

You can choose from among four sequences for measuring tare weights, initial sample weights and backweighed residue ("backweight") during differential weighing:

1. Individual Weighing

Tare weight, initial weight and backweight are measured in that order.

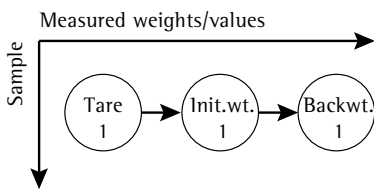

2. Consecutive Individual Weighing

Several individual weighing routines (see above) are performed in series.

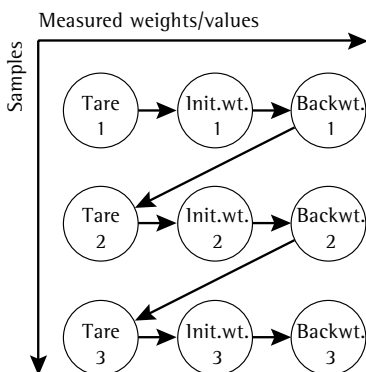

3. Combined Weighing

The tare and initial weight, in that order, of each sample is measured first, then the backweight of each sample is measured.

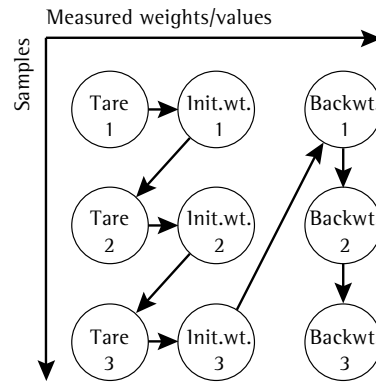

4. Serial Weighing

First the tare weight for each sample is measured, then the initial weight of each sample is measured in the same order that their tare weights were measured, and then all backweights are measured.

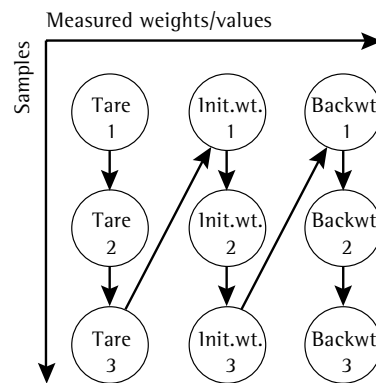

You can define the weighing sequence in the Setup menu or by pressing the **Wg. seq** (if the "Weighing sequence key" option is activated).

Factory Settings of the Parameters

Weighing sequence:
Group weighing

Tare weighing: **Yes**

Result with decimal point:
2 decimal places

Autosave values: **No**

Minimum load for autosave:
10 digits

Save statistics: **No**

Generate printout:
Automatic after backweighing

Include sample ID in the text line: **No**

Wg. seq. key: **Yes**

Clear sample after individual weight, result + unload: **No**

Last residual weight saved as the initial weight: **No**

Printout for Differential Weighing



Generating Printouts

Automatically

The configured backweighing printout is generated automatically after backweighing, if one of the following settings is selected Setup: Application 1: Differential weighing: Generate printout:

```
Automatic after
backweighing
Auto after init.weigh
+ backweigh
Auto after tare-,
init- +backweigh.
```

Generating Printouts Manually

The individual printout is generated when the  key is pressed while there is a tare, initial or backweight on the balance, or when  is pressed to toggle applications.

You can generate the configured printout manually after backweighing if you press the  key while the display page for the results is shown.

To generate the statistics printout, press the  key

- when the display page for statistics is shown,
- when the samples with a desired number of backweighing operations is selected (for example, statistics on all samples with 2 backweighing operations).



The following printout is generated:

Backweighing Printout (Example)

```
-----
16.11.1999  14:55:12
Lot          CH12345
Sample      14
ID          CX88
T1      + 23.45821 g
N1      +125.57234 g
R  (3) +103.68442 g
R        +   82.57 %
D        - 21.88792 g
D        -   17.43 %
Fact     +   1.10345
D-Res    -    24.15 o
Ratio1+   21.11 %
Ratio2+  121.11 %
-----
```

```
Dotted line
Date/time
Lot ID
Sample number
Sample ID
Tare weighing (with PT1 selected)
Initial weight
Backweight (residue as weight)
Residue in percent
Loss as a weight
Loss in percent
Calculation factor
Calculated loss
Ratio 1
Ratio 2
Dotted line
```

Preparation

- Turn on the balance: press 
- > The Sartorius logo is displayed; a self-test is performed
- Select the Differential Weighing application in the Setup menu: press 
- Select the **Application parameters**: press the ∇ soft key 2 x, then the \rightarrow soft key once
- Select **Application 1 (basic settings)**: press the \rightarrow soft key
- Select **Differential weighing**: press the \wedge or ∇ soft key, repeatedly, if necessary
- Confirm **Differential weighing**: press the \rightarrow soft key

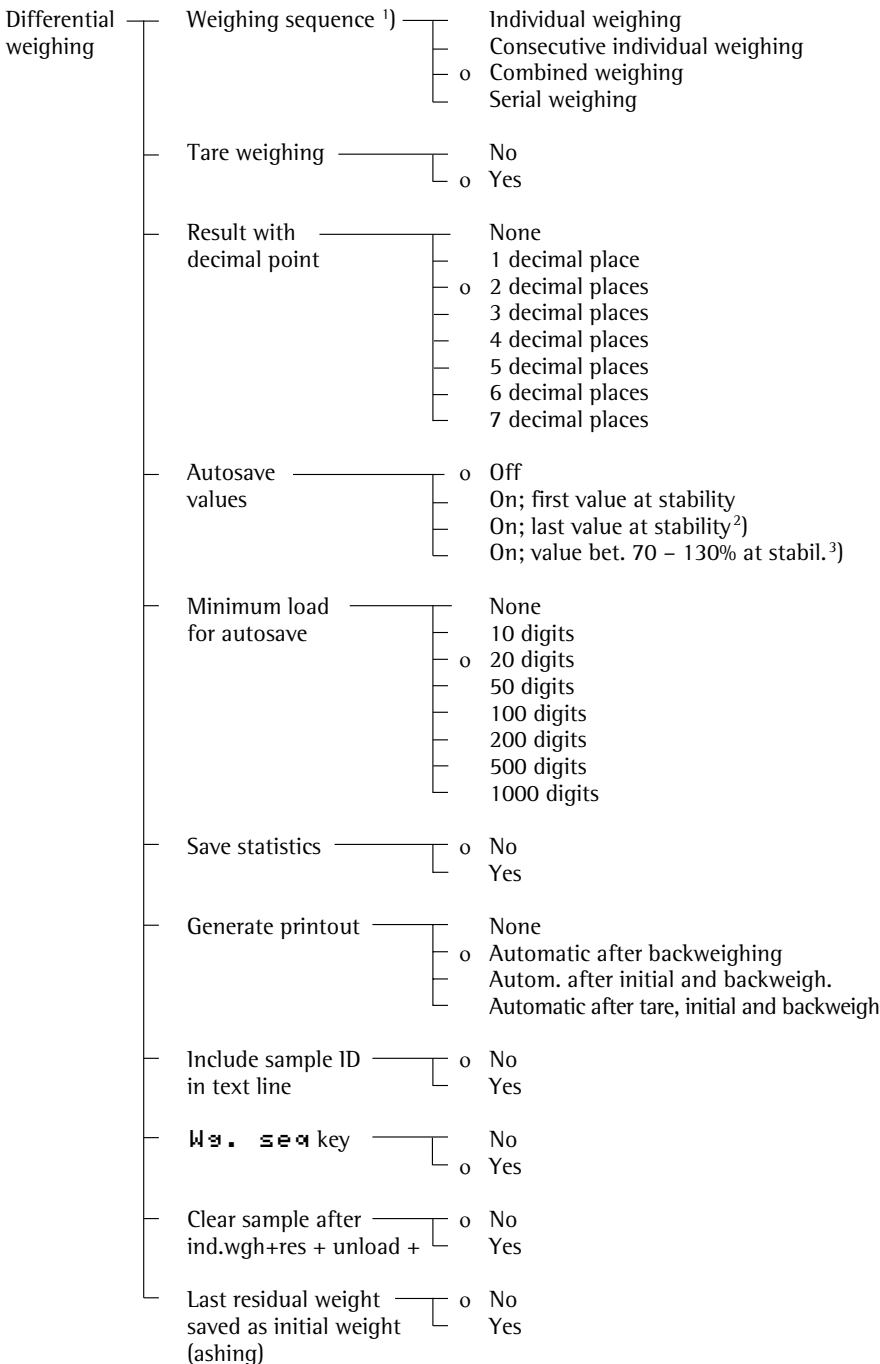

o = factory setting

¹⁾ Setting can only be changed when the application is first run and when the **Wg. zero** key option is set to “No”

²⁾ The last value with the stability symbol is saved only during initial sample weighing. Tare and back-weights are saved as the “first value at stability.” This menu option enables you to perform filling functions during initial weighing.

³⁾ To autosave a value between 70 and 130% of the initialization value, the balance must be unloaded to below 30% or loaded to above 170% of this initialization value.

Equations

- Backweight in %: $\text{backweight} / \text{initial weight} \cdot 100\%$
- Loss in weight: $\text{backweight} - \text{initial weight}$
- Loss in %: $(\text{backweight} - \text{initial weight}) / \text{initial weight} \cdot 100\%$
- Calculated loss: $(\text{backweight} - \text{initial weight}) \cdot \text{factor}$
- Ratio 1 in %: $(\text{initial weight} - \text{backweight}) / \text{backweight} \cdot 100\%$
- Ratio 2 in %: $\text{initial weight} / \text{backweight} \cdot 100\%$

Function of the Key

Weighing sequence	Status	Press  key	Value deleted	Subsequent status
Individual weighing	Tare weighing	-	-	-
	Initial weighing	1 x	Tare	Tare weighing
	Backweighing	1 x	Initial weight	Initial weighing
		2 x	Tare	Tare weighing
	Results displayed	1 x	Backweight	Backweighing
Consecutive individual weighing	As for individual weighing			
Combined weighing	Tare weighing	1 x	Previous init. weight	Initial weighing
		2 x	Previous tare value	Tare weighing
	Initial weighing	1 x	Tare	Tare weighing
	Backweighing	1 x	Previous backweight	Backweighing
	Results displayed	1 x	Last backweight	Backweighing
Serial weighing	Tare weighing	1 x	Previous tare value	Previous tare weighing
	Initial weighing	1 x	Previous init. weight	Previous initial weighing
	Backweighing	1 x	Previous backweight	Previous backweighing
	Results displayed	1 x	Last backweight	Backweighing

Soft Key Functions

Create	Create a new lot	Values	Select/view the display page for values
Lot	Select/view the display page for lots	Sample	View the display page for samples
Ini.wt.	Save initial weight	Spl#	Select/create sample data record
>Ini.w	Go to initial weighing function	Backw.	Save backweight value
Result	View display page for results	>Backw	Go to backweighing function
>Resul	Go to display page for results	Omit	Omit/include sample
M-ini	Input initial weight value	Stat.	View display page for statistics
M-back	Input backweighed residue	Tare	Save tare value
M-tare	Input tare value	>Tare	Go to tare weighing function
Delete	Delete lot/sample	Wt.seq	Select weighing sequence

Direct Selection of Lot/Sample/Value

- When the measured values are displayed, you can enter numbers and letters to:
- change the lot and sample directly (displayed in the text line)
 - directly access the display pages for samples and values

- Enter lot/sample/value ID

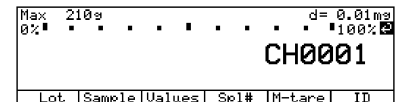

(in this example, "CH0001", designates a certain lot)

- Press the corresponding soft key
- > **Lot** soft key:
The lot corresponding to the ID entered is displayed (if the lot is not found, the display page for lots is shown)
- > **Sample** soft key:
The display page is shown for samples in the active lot that contains the sample number entered
- > **Values** soft key:
The values for the sample entered are shown
- > **Spl#** soft key:
Change samples without the list function

Toggle between Differential Weighing and Basic Weighing:

Press 

Direct Selection of the Weighing Sequence

You can change the weighing sequence (individual weighing, combined weighing, etc.) directly during measurement by pressing the **Wt.seq** key, if this function has been activated in the Setup menu [Application parameters: Application 1: Differential weighing: Weighing sequence key: Yes]

List Function for Differential Weighing

The list function has 4 display pages: one each for lots, samples, values and results.

Display Page for Lots

LOTS:	792	Smpl.avail.
1	1	Sample T
122	1	Sample T,N
BB05	20	Samples T,N,R1
CH0001	10	Samples T,N
CH01234	2	Samples T,N,R1
<<	Delete/Create	^ v Sample

The display page for lots shows all of the lots that have already been created, as well as the number of samples in each lot and the processing status of the selected sample (tare, initial and backweight). On this display page you can create, rename, delete and print lots. You can also define a factor for calculation of loss; for instance, to have weight per unit area calculated (such as grams per square meter). You can also enter a lot ID alphanumerically to access a lot directly.

Display Page for Samples

SMPL: avail.792	Lot: CH0001
Sample 1:	T,N,R(1) CX87
Sample 2:	T,N,R(1) CX88
Sample 3:	T,N
Sample 4:	T,N
Sample 5:	T,N
<<	Delete < ^ v Values

This display page shows the samples contained in a selected lot, as well as the processing status of the samples (tare, initial and backweight) and the sample IDs. You can also enter a sample ID alphanumerically to access a sample directly.

Display Page for Values

VALUES: Lot: CH0001	Smpl:2
Date,time:	16.11.1998 15:11:17
Name:	ID CX88
Tare:	T1 + 24.72654 g
Net initial wt:	N1 + 14.45432 g
Backweigh'd res:	R (1)+ 93.55678 g
<<	Result < ^ v

This display page shows the date and time of sampling, as well as the sample ID and the values measured, for a selected sample.

Display Page for Results

RESULT: Lot: CH0001	Smpl:2
Residue:	R + 20.74321 g
Residue:	R + 80.48 %
Loss:	D - 5.03565 g
Loss:	D - 19.52 %
Ratio1:	DR + 24.25 %
<<	Values < ^ v ↓

This display page shows the calculated values for a selected sample. These include backweighed residue, loss, loss calculated using a factor, and the ratio values. The \odot symbol indicates the value that is selected for display immediately following a backweighing procedure. To change this setting, use the \vee and \wedge soft keys to move the highlight bar to the desired value, and press \downarrow to confirm.

Display Page for Statistics

STATISTICS: Lot:CH6789	
Statistics on: R (1)	5 Spls
Statistics on: R (2)	3 Spls
Statistics on: R (*)	8 Spls
<<	^ v ↓

This page shows the characteristic data for a lot (date; time; statistics on, for example, the backweighed residue; number of samples) as well as the calculated values (mean value, standard deviation).

To select a set of statistics from a lot with different numbers of backweighing procedures:

Press the \downarrow soft key to display the selected set of statistics:

STATISTICS: Lot:CH6789	
Date,time:	04.02.1999 14:31:30
Statistics on: R (1)	>Residue<
No.of values:	n 2
Mean value:	Mean + 93.28 %
Std. deviation:	s 0.01 %
<<	

Selecting Display Pages in the List Function for Differential Weighing

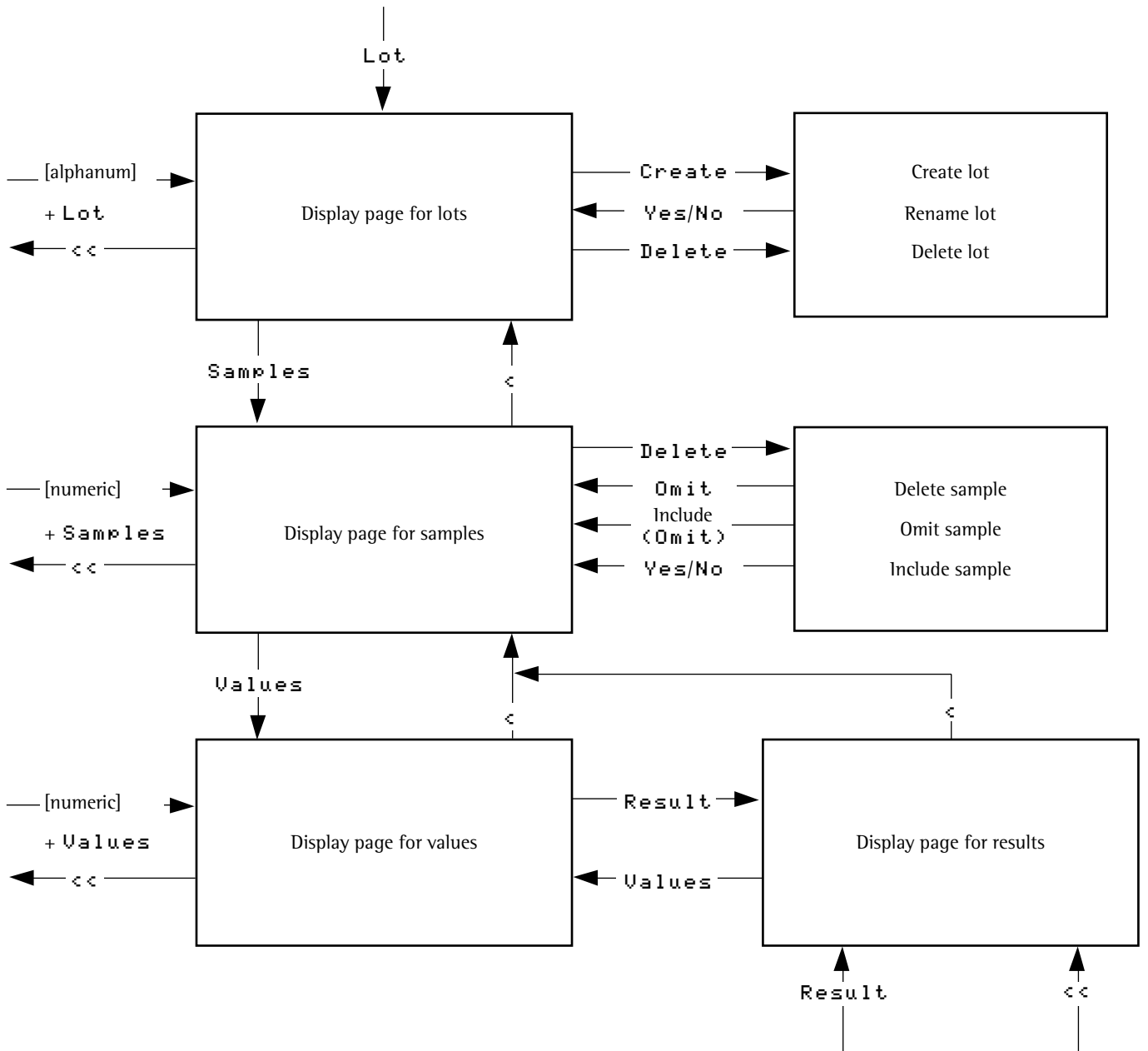

View and Print Display Pages

You can use the manual mode to print display pages (for lots, samples, values and results).

To view and print a display page for values:

- Show the display page for lots: press the **Lot** soft key
- Show the display page for samples: press the **Sample** soft key
- Show the display page for values: press the **Values** soft key
- Print the display page for values: press 

PRINT:	Lot: CH0001	Smpl:1
Current sample		
All samples (5)		
<<	<	v
		↓

- Select amount of data to be included on the printout: press the **v** or **^** soft key
- Confirm print command: press the **↓** soft key

The display pages for lots and samples can be printed when they are shown on the balance display.

View the Display Page for Results:

- Show the display page for lots: press the **Lot** soft key
- Show the display page for samples: press the **Sample** soft key
- Show the display page for values: press the **Values** soft key
- Show the display page for results: press the **Result** soft key
- Print the display page for results: see instructions for printing the display page for values

You can manually print the display page for statistics when it is shown on the balance

To view the display page for statistics:

- Select statistics: press the **Stat.** soft key
- For samples each with a different number of backweights: Select the kind of statistics: press the **v** or **^** soft key
- Confirm selection: press the **↓** soft key

Deleting or Omitting a Lot or Sample

Lots can be deleted; samples can be deleted or omitted.

You can choose between

- deleting the current lot and
- deleting all lots.

You can choose whether

- the active sample is deleted entirely, or
- only the values from the active sample are deleted, or
- all samples are deleted completely, or
- only the values from all samples are deleted, or
- a sample is omitted

Deleting a Lot/Sample

- Activate the display page for lots/samples
- Select the desired lot/sample
- Select the "Delete" function: Press the **Delete** key
- Define the lot(s)/sample(s) to be deleted and confirm
- Select "Yes" to complete the delete function or "No" to cancel it

SAMPLE: confirm deletion	
Complete current sample	
Only values for current sample	
All complete samples (3)	
Only values for all samples (3)	
	No Yes

Example: Deleting all samples completely (in this case, 3 samples)

Omit or Include Sample

- Activate the display page for samples
- Select the desired (or omitted) sample
- Delete: Press the **Delete** key
- Omit: Press the **Omit** key

SMPL: avail. 991	Lot: MILK123
Sample 1: T.N.R(3)	CX87
Sample 2: T.N.R(1)	CX88
Sample 3: T.N.R(1)	(omitted)
<< Delete < ^	Values

Example: Sample 3 has been omitted

Additional Functions

In addition to the functions for:

- alphanumeric input,
- taring (not during alphanumeric input), and
- printing,

you can also access the following functions from this application:

Calibration/Adjustment

- Press the **Cal** soft key
- > See the section entitled "Calibration/Adjustment" for further instructions

Setup (Parameter Settings)

- Press the  key
- > See the chapter entitled "Configuring the Balance" for further instructions

Turning Off the Balance

- Press the  key
- > The balance shuts off
- > The display goes blank, then OFF or Standby is displayed with backlighting

Example









Differential weighing: Consecutive individual weighing; select lot, determine the difference in weight between initial weights and backweights of two samples; generate and printout statistics; do not generate any individual and backweighing printouts

Settings (changes in the factory settings required for this example):

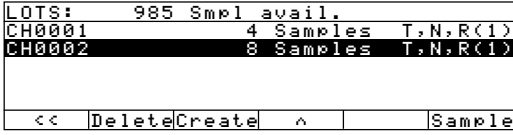



Setup: Application parameters: Application 1: Differential weighing: Weighing sequence: Consecutive individual weighing

Setup: Application parameters: Application 1: Differential weighing: Save statistics: Yes

Setup: Application parameters: Application 1: Differential weighing: Generate printout: No

Step	Press key(s) (or follow instructions)	Display/Output
1. Turn on the balance and select the settings listed above		
2. Start differential weighing (if necessary, select consecutive individual weighing)	Start soft key Wt.seq soft key	
3. Create or select lot - select: continue with step 7. - create: see step 4.	Lot soft key v or ^ soft key	
4. Select "Lot name"	Create soft key	
5. Enter lot name	 ABCDEF soft key(s) C soft key GHIJKL soft key(s) H soft key 	
6. Confirm lot name input	↓ soft key	
7. Activate weight readout	<< soft key	

Step	Press key(s) (or follow instructions)	Display/Output
8. Measure 1st tare weight on balance/scale	Place 1st empty container	<p>Max 210 g d=0.01mg 0% 100% + 72.02512 g CONS.IND.W: CH1234 #1 avail. U++ Cal Lot Wg.seq Tare</p>
9. Save tare value	Tare soft key	<p>Max 210 g d=0.01mg 0% 100% 0.00000 g NET1 CONS.IND.W: CH1234 #1 T W++ Cal Lot Wg.seq Ini.wt</p>
10. Unload the balance	Remove the empty container	<p>Max 210 g d=0.01mg 0% 100% 0.00000 g CONS.IND.W: CH1234 #1 T W++ Cal Lot Wg.seq Ini.wt</p>
11. Measure the initial weight (in this case: 24.51 g)	Fill the 1st container Place filled container on balance	<p>Max 210 g d=0.01mg 0% 100% + 24.51213 g NET1 CONS.IND.W: CH1234 #1 T W++ Cal Lot Wg.seq Ini.wt</p>
12. Save initial weight value	Ini.wt soft key Remove the filled container	<p>Max 210 g d=0.01mg 0% 100% 0.00000 g NET1 CONS.IND.W: CH1234 #1 T,N W++ Cal Lot Wg.seq Backw.</p>
13. Treat sample in 1st container (for example, by drying)		
14. Measure backweight	Place 1st container on balance	<p>Max 210 g d=0.01mg 0% 100% + 19.43005 g NET1 CONS.IND.W: CH1234 #1 T,N W++ Cal Lot Wg.seq Backw.</p>
15. Save backweight (the value to be displayed is defined on the display page for results; in this case: backweighed residue in %)	Backw. soft key	<p>Max 210 g d=0.01mg 0% 100% + 79.27% NET1 CONS.IND.W: CH1234 #1 >Residue< W++ Cal Stat. Lot Wg.seq >Tare Result</p>
16. Unload the balance	Remove the 1st container	<p>Max 210 g d=0.01mg 0% 100% 0.00000 g CONS.IND.W: CH1234 #2 avail. U++ Cal Stat. Lot Wg.seq Tare</p>
17. Measure the second tare weight	Place 2nd empty container on balance	<p>Max 210 g d=0.01mg 0% 100% + 72.19117 g CONS.IND.W: CH1234 #2 avail U++ Cal Stat. Lot Wg.seq Tare</p>

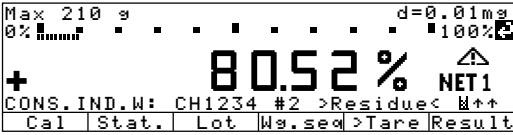
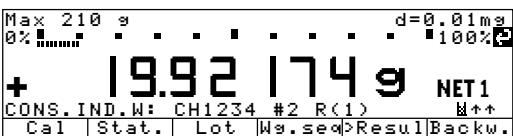
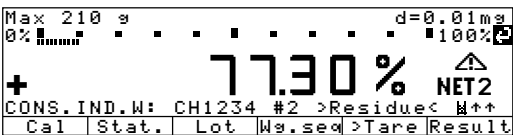
Step	Press key(s) (or follow instructions)	Display/Output
18. Save tare weight	Tare soft key	 <p>Max 210 g d=0.01mg 0% 100% 0.000000 g NET1 CONS. IND. W: CH1234 #2 T Cal Stat. Lot Ws.seq Tare</p>
19. Unload the balance	Remove the empty container	 <p>Max 210 g d=0.01mg 0% 100% 0.000000 g CONS. IND. W: CH1234 #2 T Cal Stat. Lot Ws.seq Ini.wt</p>
20. Measure the initial weight (in this case: 25.77 g)	Fill the 2nd container Place filled container on balance	 <p>Max 210 g d=0.01mg 0% 100% + 25.77201 g NET1 CONS. IND. W: CH1234 #2 T Cal Stat. Lot Ws.seq Ini.wt</p>
21. Save initial sample weight	Ini.wt soft key Remove the filled container	 <p>Max 210 g d=0.01mg 0% 100% 0.000000 g CONS. IND. W: CH1234 #2 T,N Cal Stat. Lot Ws.seq Backw.</p>
22. Treat sample in 2nd container (for example, by drying)		
23. Measure backweight	Place 2nd container on balance	 <p>Max 210 g d=0.01mg 0% 100% + 20.75123 g NET1 CONS. IND. W: CH1234 #2 T,N Cal Stat. Lot Ws.seq Backw.</p>
24. Save backweight	Backw. soft key	 <p>Max 210 g d=0.01mg 0% 100% + 80.52% NET1 CONS. IND. W: CH1234 #2 >Residue< Cal Stat. Lot Ws.seq >Tare Result</p>
25. Unload the balance Treat sample in 2nd container again (for example, by drying)	Remove 2nd container	
26. Start second backweighing of Sample 2	Place 2nd container on the balance again; press 2 , then Sol# soft key	 <p>Max 210 g d=0.01mg 0% 100% + 19.92174 g NET1 CONS. IND. W: CH1234 #2 R(1) Cal Stat. Lot Ws.seq >Result Backw.</p>
27. Save backweight	Backw. soft key	 <p>Max 210 g d=0.01mg 0% 100% + 77.30% NET2 CONS. IND. W: CH1234 #2 >Residue< Cal Stat. Lot Ws.seq >Tare Result</p>

Step	Press key(s) (or follow instructions)	Display/Output
28. Activate statistics display	Stat. soft key	<pre> STATISTICS: Lot:CH1234 Statistics on: R (1) 2 Sp1s Statistics on: R (2) 1 Sp1s Statistics on: R (*) 3 Sp1s << ^ v ↓ </pre>
29. Select type of statistics and confirm (in this case: statistics on R (*))	v ^ soft keys ↓ soft key	<pre> STATISTICS: Lot:CH1234 Date,time: 17.11.1998 15:44:56 Statistics on: R (*) >Residue< No.of values: n 2 Mean values: Mean + 78.29 % Std. deviation: s 1.40 % << < v </pre>
30. Generate statistics printout (Number and type of data items as configured)	Ⓞ	<pre> 17.01.2000 15:44:56 Lot CH1234 R (*) >Residue< n 2 Avg. + 78.29 % s 1.40 % </pre>
31. Unload the balance	Remove 2nd container	

Air Buoyancy Correction

Purpose

This application enables you to correct weighing errors that occur due to air buoyancy when you work with weights of various densities.

You can use this application in combination with a program chosen from Application 2 (checkweighing, time-controlled functions) and one from Application 3 (totalizing, statistics).

Air buoyancy correction cannot be combined with the formulation and 2nd tare memory applications.

The air density value is required for calculation of the air buoyancy correction factor. Because not every location has an air density of 1.2 kg/m³, the density of a particular location can be determined using the air density determination routine.

Features

Buoyancy correction:

- Automatic initialization of this application and loading the density of a weighed object stored in the non-volatile memory, **RhOW** and the air density **RhOA** last saved; display of **RhOW** in the line for text.
- Automatic start of air buoyancy correction and display of the  symbol for calculated values, if selected in the Setup menu (Setup: Auto-start application when power goes on: Yes)
- Input of the density of a sample or an object using the numeric keys and by pressing the **RhOW** soft key. This activates air buoyancy correction, if not yet activated.
- Input range for the density of a sample: 0.1 g/cm³ – 22.5 g/cm³.
- Storage of density values (**RhOW** and **RhOA**) in the non-volatile memory.
- Deactivation of air buoyancy correction by toggling to the “Weighing” mode (weighing without air buoyancy correction)

Air Density Determination:

- To determine the air density, use the special weight set, YSS45, which is available as an accessory. This weight set consists of one steel and one aluminum weight and is available with the “Weight Specifications” certificate. The densities of the steel (8.0) and aluminum references (2.7) are preset values and cannot be changed.
- Determine the air density by
 - entering the density using the numeric keys
 - entering the specifications for steel/aluminum and weighing the steel and aluminum weights (accessory: YSS45)
- If you enter an air density using the numeric keys, the reference values (density and weight) for steel and aluminum are deleted from the display page “AIR D. PARAMETERS.”
- After the air density has been determined and saved by pressing the **Start** soft key, the reference values are printed out
- Preset value for air density: 1.2 kg/m³
- Range for entering air density values: 1.0 kg/m³ – 1.4 kg/m³.
- You can activate or deactivate air density determination in the Setup menu, thus blocking access to this program routine.
- The air density is generally determined in grams as the weight unit.
- If air density determination is deactivated, the air density **RhOA** will be displayed for 2 seconds in the text line when you press the **RhOA** soft key.
- After the air density has been determined, you can save the value, but this is not required
- You can block storage of the specifications (references) in the Setup menu. (Setup: Application parameters: Application 1: Air buoyancy correction: Change steel/aluminum references)
- The density values on the display page for reference values are standard, inalterable values

Factory Settings of the Parameters

Air density determination: $\square f f$

Change steel/aluminum references: $\square f f$

Soft Key Functions

- Diff.** Display the difference between the value measured and the specification for steel/aluminum
- Result** Toggle to the display page for results
- Fact.** Display the correction factor K in the text line (see "Equations for Air Buoyancy Correction" on this page)
- Corr.** Start air buoyancy correction with numeric input of the density of a sample
- Net** Display the current value measured
- Param.** Toggle to the display of the current parameters for air buoyancy correction (air density, specifications for steel, aluminum, etc.)
- Ref.** Toggle to the display and, if necessary, input the air density references (specifications and density for steel and aluminum)
- RhoW** Input the density of a sample using the numeric keys (in the weighing mode)
- RhoA** Activate air density determination or display **RhoA** for 2 seconds in the text line if the parameter "Air density determination Off" is set
- Start** Start air buoyancy correction and air density determination using the density saved for a specific sample
- Sto** Store (save) the steel/aluminum reference values
- Weigh** Toggle to the weighing mode without correcting the air buoyancy

Air Buoyancy Correction

Diagram for Air Buoyancy Correction

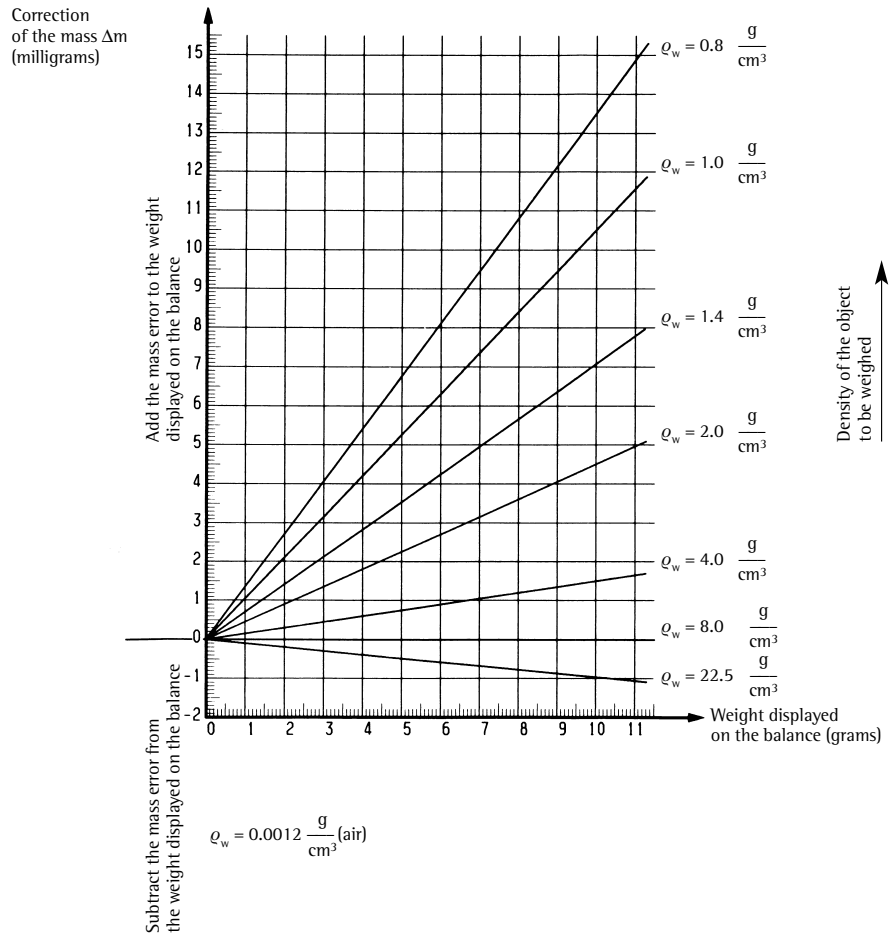

Equations for Air Buoyancy Correction

To determine the mass of a sample, its weight is multiplied by the following factor K:

$$K = (1 - \rho_{oA} / \rho_{oST}) / (1 - \rho_{oA} / \rho_{oW})$$



where:

$$\rho_{oA} = \text{air density [kg/m}^3\text{]}$$

$$\rho_{oST} = \text{density of steel (8,000 kg/m}^3\text{)}$$

$$\rho_{oW} = \text{density of the sample [kg/m}^3\text{]}$$

Preparation

- Turn on the balance: press 
- > The Sartorius logo is displayed; a self-test is performed
- Configure the Air Buoyancy Correction application in the Setup menu: press 
- Select **Application parameters**: press the ∇ soft key 2 x, then the \rightarrow soft key once
- Select **Application 1 (basic settings)**: press the \rightarrow soft key
- Select **Air buoyancy correction**: press the \wedge or ∇ soft key, repeatedly, if necessary
- Confirm **Air buoyancy correction**: press the \rightarrow soft key

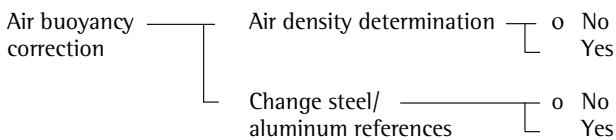

0 = factory setting

see also "Application Parameters (Overview)" in "Configuring the Balance"

- Save settings and exit the Setup menu: press the $\leftarrow \leftarrow$ soft key

Additional Functions

In addition to the functions for:

- alphanumeric input,
- taring (not during alphanumeric input),
- printing,

you can also access the following functions from this application:

Calibration/Adjustment

- Press the **Cal** soft key
- > See "Calibration/Adjustment" for further instructions

Toggling to the Next Application

- Press 
- > See the section on the corresponding application program for further instructions

Setup (Setting Parameters)

- Press 
- > See "Configuring the Balance" for further instructions

Turning Off the Balance







- Press 
- > The balance shuts off
- > The display goes blank

Example

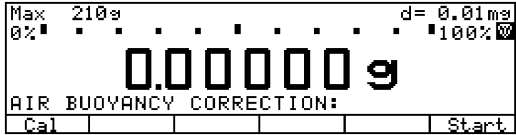
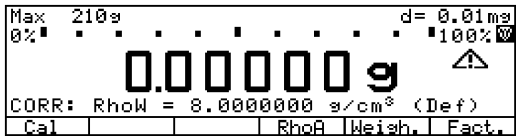
To determine the correct weight of a sample, enter the density of this sample. In this example, use the air density saved in the balance.

Settings (changes in the factory settings required for this example):

Setup: Application parameters: Application 1: Air buoyancy correction: Air buoyancy determination: On

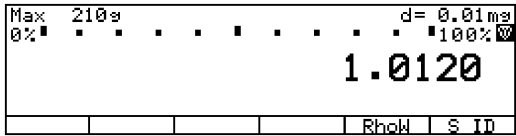
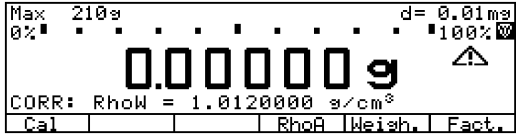
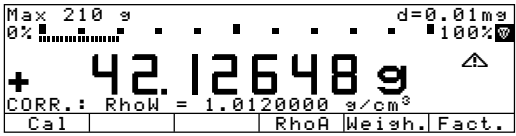
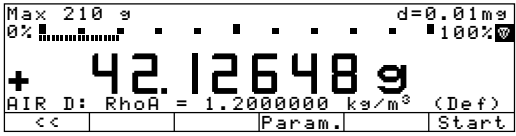
Step	Press key(s) (or follow instructions)	Display/Output
1. Turn on the balance and configure as indicated above		
2. Start air buoyancy correction	Start soft key	
3. Enter the density of your sample (in this example: 1.0120 g/cm ³)	     	
4. Save the density of the sample as Rho _w ; this simultaneously activates air buoyancy correction	RhoW soft key	
5. Place the sample on the balance (for example, 42.12648 g)	Load balance	
6. Display the saved air density, if desired	RhoA soft key	
7. Exit readout of air density	<< soft key	

Air Density Determination

Equations for Air Density Determination

The balance uses the equation below to calculate the air density for steel and aluminum based on the reference weights supplied:

$$\text{Rho}_A = \frac{m_A \cdot W_{ST} - m_{ST} \cdot W_{AL}}{\frac{m_A \cdot W_{ST}}{\text{Rho}_{AL}} - \frac{m_{ST} \cdot W_{AL}}{\text{Rho}_{ST}}}$$

where:

$$\begin{aligned} \text{Rho}_A &= \text{air density [kg/m}^3\text{]} \\ \text{Rho}_{AL} &= \text{density of aluminum [kg/m}^3\text{]} & \text{Rho}_{ST} &= \text{density of steel [kg/m}^3\text{]} \\ m_A &= \text{mass of aluminum} & m_{ST} &= \text{mass of steel} \\ W_{AL} &= \text{weight value of aluminum} & W_{ST} &= \text{weight value of steel} \end{aligned}$$

The mass of aluminum is calculated according to the following equation:

$$m_{AL} = M_{AL} \cdot (1 - 1.2 / 8000) / (1 - 1.2 / \text{Rho}_{AL})$$

where:

$$\begin{aligned} m_{AL} &= \text{mass of aluminum (specification)} \\ M_{AL} &= \text{conventional mass value of aluminum} \\ \text{Rho}_{AL} &= \text{density of aluminum [kg/m}^3\text{]} \end{aligned}$$

The mass of steel is calculated according to the following equation:

$$m_{ST} = M_{ST} \cdot (1 - 1.2 / 8000) / (1 - 1.2 / \text{Rho}_{ST})$$

where:

$$\begin{aligned} m_{ST} &= \text{mass of steel (specification)} \\ M_{ST} &= \text{conventional mass value of steel} \\ \text{Rho}_{ST} &= \text{density of steel [kg/m}^3\text{]} \end{aligned}$$

You can obtain the air density value in one of two ways:











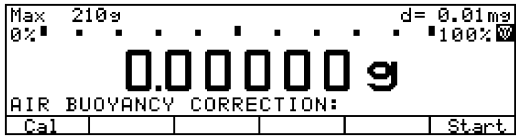
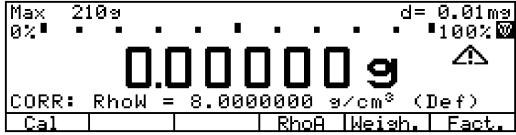
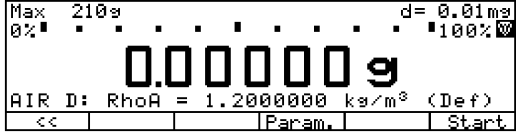
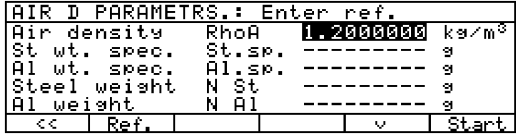
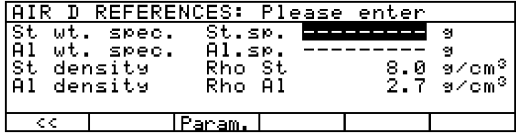







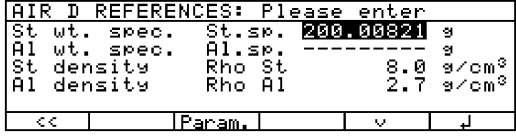
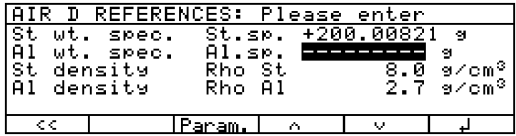

1. Numeric Entry of the Air Density
 - Turn on the balance and select the “Application parameters” as described for Air Buoyancy Correction
 - Start application for “Air buoyancy correction”: press **Start**
 - Start “Air density determination”: press the **RhoA** soft key
 - Use the numeric keys to enter the air density (1.0 – 1.4 kg/m³): **1** **.** **2** ... **0**
 - Save value for air density: press the **RhoA** soft key
 - Exit the application for determining the air density: press the **<<** soft key
2. Weighing and Saving the Reference Weights for Steel and Aluminum
 - See the example on the following pages

Example

Determination of the Air Density by Weighing, Using the Reference Weights Supplied for Steel and Aluminum

Settings (changes in the factory settings required for this example):

Setup: Application parameters: Application 1: Air buoyancy correction: Air buoyancy determination: Yes
Air buoyancy correction: Change steel/aluminum references: Yes

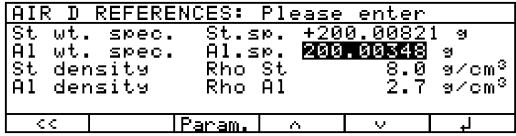
Step	Press key(s) (or follow instructions)	Display/Output
1. Turn on the balance if it is not already on		
2. Start air buoyancy correction	Start soft key	
3. Toggle to the mode for air density determination to enter the specifications for steel and aluminum	RhoA soft key	
4. Toggle to the display of the air density parameters	Param. soft key	
5. Toggle to the display of the air density references	Ref. soft key	
6. Enter the specification of the steel reference supplied (in this case, 200.00821 g/cm³)	        	
7. Confirm entry	↵ soft key	
8. Enter the specification of the aluminum reference supplied (in this case, 200.00348 g/cm³)	        	

Step	Press key(s) (or follow instructions)	Display/Output
9. Confirm values entered	↓ soft key	<pre> AIR D REFERENCES: Please enter St wt. spec. St.sp. +200.00821 g Al wt. spec. Al.sp. +200.00348 g St density Rho St 8.0 g/cm³ Al density Rho Al 2.7 g/cm³ << Param. ^ v ↓ </pre>
10. Exit display page for parameters	Softkey <<	<pre> Max 210g d=0.01mg 0% 100% 0.000000 g AIR D: RhoA = 1.2000000 kg/m³ (Def) << Param. Start </pre>
11. Start measurement of reference weights	Start soft key	<pre> Max 210g d=0.01mg 0% 100% 0.000000 g AIR D: St.ref 200.00821 g :Load ++ << Param. Diff. </pre>
12. Place steel ref. weight on the balance	Load balance	<pre> Max 210 g d=0.01mg 0% 100% + 200.02142 g AIR D: St.ref :Save ++ << Param. Diff. Store </pre>
13. Save steel reference weight	Store soft key	<pre> Max 210 g d=0.01mg 0% 100% + 200.02142 g AIR D: St.ref :Remove ++ << Param. Diff. </pre>
14. Remove steel reference weight	Unload balance	<pre> Max 210 g d=0.01mg 0% 100% 0.000000 g AIR D: Al.ref 200.00348 g :Load ++ << Param. Diff. </pre>
15. Place aluminum reference weight on the balance	Load balance	<pre> Max 210 g d=0.01mg 0% 100% + 200.01082 g AIR D: Al.ref :Save ++ << Param. Diff. Store </pre>
16. Save aluminum reference weight	Store soft key	<pre> Max 210 g d=0.01mg 0% 100% + 200.01082 g AIR D: Al.ref :Remove ++ << Param. Diff. </pre>
17. Remove aluminum reference weight (the calculated air density is displayed; in this example, 1.3195259)	Unload the balance	<pre> Max 210 g d=0.01mg 0% 100% 0.000000 g AIR D: RhoA = 1.3195259 kg/m³ << Param. Start </pre>
18. Exit air density determination	<< soft key	

Diameter Determination

Purpose

This application program enables you to determine the diameter of round wires and metallic filaments. This program is used, for example, to determine the diameter of filaments for light bulbs.

You can use density determination in combination with a program chosen from Application 2 (checkweighing, time-controlled functions) and Application 3 (totalizing, formulation, statistics).

Features

- Input and changing of individual data after pressing **Param.** soft key
- Identifier 1 **Text1** (20 characters max.)
- Identifier 2 **Text2** (20 characters max.)
- Density of the sample, **RhoWt** (0.01 to 50.0 g/cm³; Factory setting = 8.0 g/cm³)
- Length of the sample in millimeters (range = 0.1 to 99999 mm)
- Number of decimal places for the diameter result (0–7; factory setting = 3)
- Input of the density and length of the sample directly using the numeric keys

When this program is active, the following information is displayed in the text line:

- Data record name (if you have selected the “Product data memory” function)
- Density of the sample **RhoWt**
- Length in millimeters **mm**
- The calculated diameter result is indicated by the “mm” ID
- Automatic initialization of this application when the power is turned on and loading of the stored data record, provided that all data were entered, and automatic power-on initialization, provided this has been selected in the Setup menu (Setup: Application parameters: Auto-start application when power goes on: Yes)
The start page is skipped and the diameter determination program is then immediately activated.
- Extra function “Product data memory”: up to 300 data records can be saved for the diameter determination program (for additional functions, please see page 116)
- Press **CF** to end diameter determination

Soft Key Functions

- Start.** Starts diameter determination
- Param.** Begins input of diameter and length
- RhoWt.** Saves the density of the sample
- l (mm)** Saves the length of the sample
- Weigh.** Display the weight
- Dia.** Displays the calculated diameter result

Preparation

- Turn on the balance: press **1/0**
- > The Sartorius logo is displayed
- Configure the “Density determination” program in the Setup menu: press **Setup**
- Select the **Application parameters:** press the **v** soft key 2 times, then the **>** soft key
- Select the **Application parameters(basic settings):** press **>** soft key
- Select **Diameter determination:** press the **^** or **v** soft key, repeatedly, if necessary
- Confirm **Diameter determination:** press the **>** soft key
- Save settings and exit the Setup menu: press the **<<** soft key

Additional Functions

In addition to the functions for:

- alphanumeric input
- taring (not during alphanumeric input)
- printing,

you can also access the following functions from this application:

Calibration/Adjustment

- Press the **CAL** soft key
- > See “Calibration/Adjustment” for further instructions

Toggle to the Next Application

- Press **01**
- > See the section on the corresponding application program for further instructions

Setup (Setting Parameters)

- Press **Setup**
- > See “Configuring the Balance” for further instructions

Turning Off the Balance

- Press **1/0**
- > The balance shuts off

Example



Determining the diameter of metal wires and filaments (such as a filament used in a light bulb)

Settings (changes in the factory settings required for this example):

Setup: Application parameters: Application 1: Diameter determination

Setup: Application parameters: Extra functions (F5): Product data memory

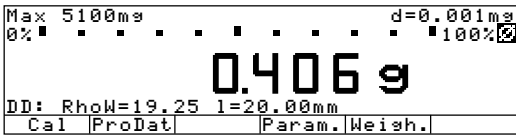
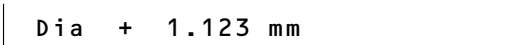
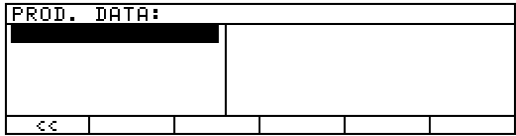
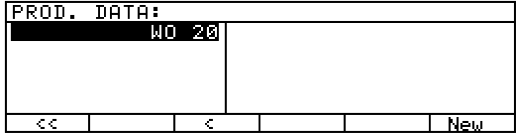
Step	Press key(s) (or follow instructions)	Display/Output
1. Turn on the balance, if not on	ON	
2. Toggle to the parameter display	Param. soft key	
3. Enter name for COMPANY (in this example, Sartorius)	ABC ... See also page 44	
4. Confirm input	ABC , ↓ soft key	
5. Enter density of filament (in this example, tungsten)	↓ soft key, 1 9 . 2 5 , ↓ soft key	
6. Enter filament length in millimeters, then exit parameter settings	2 0 , ↓ soft key, << soft key	
7. Start diameter determination	Start soft key	
<p>The printout mode can be switched off in the Setup menu (Setup: Printout: Application-defined output: Auto print upon initialization: Off)</p>		

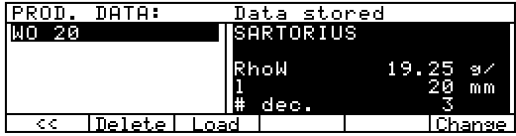
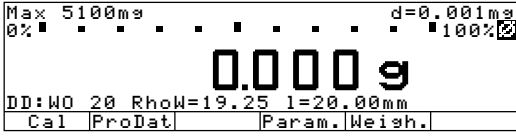
Step	Press key(s) (or follow instructions)	Display/Output
8. Place tungsten filament on pan, Close draft shield	Load balance, ↻	
9. Print weight (If necessary, weigh several times and print)	Ⓜ	
10. Toggle to display of product data (any available data records are now displayed)	ProDat soft key	
11. Enter name for a new data record (in this example W 20)	ABC ... See also page 117	
12. Save current parameters of diameter determination as a data record	New soft key	
13. Confirm storage of parameters	Save soft key	
14. Exit product data; start diameter determination	<< soft key, Start soft key	

Time-Controlled Functions

Purpose

With this application, you can configure the balance to perform certain functions (such as automatic printout of values, store value in totalization memory) at a given time or after a set interval.

You can use this application in combination with any program chosen from Application 1 (such as counting, weighing in percent) and one from Application 3 (such as totalizing, formulation) as well as with the extra functions.

Features

- Time-controlled activation of balance functions:
 - one time only, at a given time (**Settings=** is displayed in the text line)
 - repeatedly, at given intervals (**Interval=** is displayed in the text line before the function is started, and **Repeat =** is displayed after the function has been started)
- Functions that can be time-controlled include:
 - Acoustic signal (beep)
 - Lock in readout
 - Automatic printout of values
 - Store values for totalizing, formulation or statistics
- Print time in addition to weight value
- Store value depending on the stability parameter
- Tare the balance after printout of weight values
- Press the corresponding soft key to cancel time-controlled functions

Factory Settings of the Parameters

Function after time interval:
Automatic printout of values

Automatic function restart: **On**

Storage mode:
Without stability

Print then tare: **On**

Soft Key Functions

Stop Stop the application

Quit Confirm performed function (e.g., "Lock in readout" or "Beep")

Interv Store input interval for time-controlled functions

Set. Store input time for one-time performance of function



Printout for Time-Controlled Functions

If the "Automatic printout of values" parameter is set, the time and weight (or other value) are printed out.

```
Time :    10:15:00
N      +150.00000 g
```

Time: Time that the values were stored
N: Net weight

Preparation

- Turn on the balance: press 
- > The Sartorius logo is displayed
- Select the Time-Controlled Functions application in the Setup menu: press 
- Select the **Application parameters**: press the ∇ key 2 x, then the \rightarrow soft key
- Select **Application 2 (control functions)**: press the ∇ soft key, then the \rightarrow soft key
- Select **Time-controlled functions**: press the \wedge or ∇ soft key
- Confirm **Time-controlled functions**: press the \rightarrow soft key

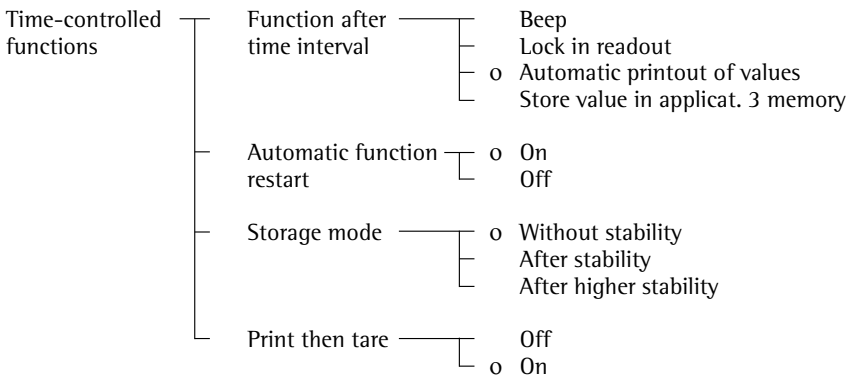

o = factory setting

see also the “Application Parameters (Overview)” in the chapter entitled “Configuring the Balance”

- Save settings and exit the Setup menu: press the $\leftarrow \leftarrow$ soft key

Print Net Values without Printout of Time

Select the Setup menu:

Setup: Printout: Application-defined output: Auto print upon initialization: Off

Additional Functions

In addition to the functions for:

- alphanumeric input,
- taring (not during alphanumeric input),
- printing,

you can also access the following functions from this application:

Calibration/Adjustment

- Press the **Cal** soft key
- > See “Calibration/Adjustment” for further instructions

Toggle to Another Application

- Press 
- > See the section on the corresponding application program for further instructions

Setup (Setting Parameters)

- Press 
- > See “Configuring the Balance” for further instructions

Turning Off the Balance

- Press 
- > The balance shuts off
- > The display goes blank, then OFF or Standby is displayed with backlighting

Example







Document the evaporated amount of a sample with defined surface, temperature and air pressure at preset intervals of 1 minute, 30 seconds.

Settings (changes in the factory settings required for this example):

Setup: Application parameters: Application 2: Time-controlled functions

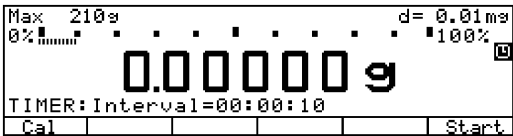
Setup: Balance/scale functions: Taring: Without stability

Setup: Printout: Application-defined output: Stability parameter: Without stability

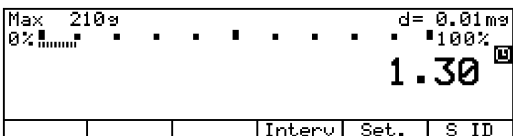
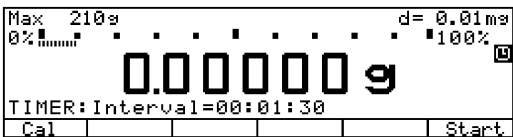
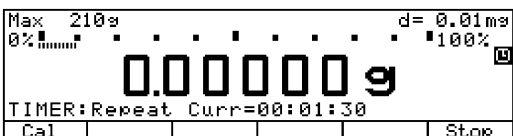
Step	Press key(s) (or follow instructions)	Display/Output
1. Turn on the balance and configure the settings as indicated above		
2. Delete stored values, if necessary		
3. Place container with sample on the balance and tare		
4. Enter time interval: 1 minute, 30 seconds	   	
5. Store time interval	Interv soft key	
6. Begin documentation (Time remaining until the next printout is displayed in the text line)	Start soft key	
Printout of evaporated amount every 1½ minutes		<pre> Time: 15:19:50 N - 0.37158 g Time: 15:21:20 N - 0.33215 g Time: 15:22:50 N - 0.30187 g Time: 15:24:20 N - 0.40518 g </pre>
7. Stop the documentation procedure	Stop soft key	

Purpose

With this application, you can have weight values and calculated values totalized and statistically evaluated.

The values determined for the evaluation are:

- average (mean value)
- standard deviation
- variation coefficient
- sum of all values
- lowest value (minimum)
- highest value (maximum)
- difference between the minimum and the maximum

You can use the statistics application in combination with any program chosen from Application 1 (such as counting, weighing in percent) and one from Application 2 (checkweighing, time-controlled functions) as well as with the extra functions.

Features

- Storage of weight values and calculated values
 - Simultaneous storage of net and calculated values
 - Optional configuration in the Setup menu for loading weight values and calculated values either from Application 1 (such as counting, weighing in percent) or from Application 2 (checkweighing, time-controlled functions)
 - Totalizing memory for up to 65,535 values
 - Simultaneous display in the text line of the transaction counter and, e.g., the current total
 - Optional configuration in the Setup menu for having the balance tare automatically after a value has been stored in the totalizing memory
 - Manual input of the number of individual weighing operations and confirmation using the **nDef** soft key (target no. of operations nDef). Result printed and memory cleared after printout of nDef
 - Optional configuration in the Setup menu to add the current weight, with display accuracy, to the current total by pressing the **M+** soft key and generate a printout of the result
 - Optional configuration in the Setup menu for stability-dependent storage of the measured value: Balance/scale functions, Stability range
 - Optional automatic storage of measured values
- Storage of measured value is indicated by **↔**;
- ↕** indicates that you can place a load on the balance
- Minimum load threshold for automatic storage

- Press the **M-** soft key to delete the last value added to the totalizing memory. The transaction counter value is reduced by one and a printout is generated
- Press the **MR**: soft key for information about number of transactions and the current total. By configuring the Setup menu, you can define whether the information is displayed and printed, or only printed, and whether the information comprises an intermediate or final evaluation
- In the Info window you can use the **↕**, **↓ (□)** soft keys to choose which value will be displayed in the text line during weighing
- Printout of the final result depending on the Application 1 or Application 2 parameters. Configure the Setup menu to define which values are included on the printout (printout of individual components)
- Press **MR** for a printout of an intermediate evaluation after each addition or a final evaluation
- A final evaluation is printed when the statistics routine is ended by pressing **CF**, if no final evaluation was generated by pressing **MR**
- Optional configuration in the Setup menu to clear the statistics memory and reset the transaction counter by pressing **CF** or after an evaluation is printed out
- Totalization data and transaction counter data are stored in the non-volatile memory
- Continue totalization after turning the balance off and back on

Factory Settings of the Parameters

Automatic storage: **Off**

Minimum load for automatic storage:

10 digits

Source of data for auto storage:

Application 1

Evaluated values: **Net**

Evaluation mode, MR key function:

**Intermediate
evaluation, print**

M+/M- function, then tare: **Off**

Printout of individual components: **Yes**

Stability range: **2 digits**

Printout: Application-defined output: Print

on request then tare: **Off**

Soft Key Functions

M+ Add weight values or application values to the total in the totalizing memory. The component or transaction counter value increases by one each time you press this key.

M- Delete the last value added to memory. The transaction counter value decreases by 1. You cannot delete previous values by repeatedly pressing this key.

MR Print or display an intermediate or final evaluation

nDef Store the input number of components

Printout of Statistics

The transaction or component counter is printed in front of each measured value (weight). When an intermediate or final evaluation is printed out, all results up to this point are included.

n		5	
Total	+151.67321	g	
Avg.	+	33.0	pcs
s	+	3.2	pcs
srel	+	9.70	%
Total	+	165	pcs
Min	+	29	pcs
Max	+	37	pcs
Diff	+	8	pcs

n: Transaction counter

Total: Sum of all values

Mean: Average

s: Standard deviation

srel: Variation coefficient

Total: Sum of all values

Min: Minimum

Max: Maximum

Diff: Difference between minimum and maximum

Preparation

- Turn on the balance: press I/O
- > The Sartorius logo is displayed
- Select the Statistics application in the Setup menu: press Setup
- Select **Application parameters**: press the \vee soft key 2 x, then the \rightarrow soft key once
- Select **Application 3 (data records)**: press the \vee soft key 2 x, then the \rightarrow soft key once
- Select **Statistics**: press the \wedge or the \vee soft key
- Select **Statistics**: press the \rightarrow soft key

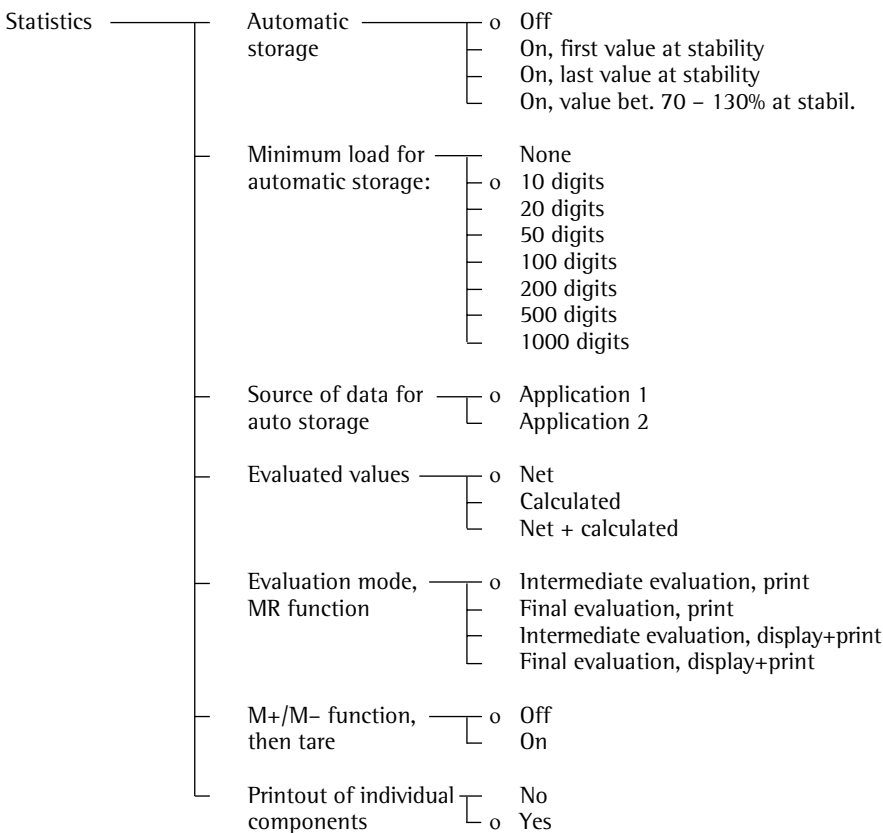

○ = factory setting

see also the “Application Parameters (Overview)” in the chapter entitled “Configuring the Balance”

- Save settings and exit the Setup menu: press the $\leftarrow \leftarrow$ soft key

Additional Functions

In addition to the functions for:

- alphanumeric input,
- taring (not during alphanumeric input),
- printing,

you can also access the following functions from this application:

Calibration/Adjustment

- Press the Cal soft key

> See “Calibration/Adjustment” for further instructions

toggling to Another Application

- Press Q1

> See the section on the corresponding application program for further instructions

Setup (Setting Parameters)

- Press Setup

> See “Configuring the Balance” for further instructions

Turning Off the Balance

- Press I/O

> The balance shuts off

> The display goes blank, then OFF or Standby is displayed with backlighting

Example: Animal Weighing with Statistics (Averaging)

Let's suppose that you need to determine each weight of 7 very small animals and statistically evaluate and print them.

Settings (changes in the factory settings required for this example):

Setup: Application parameters: Application 1: Animal weighing: Printout: No

Setup: Application parameters: Application 3: Statistics: Automatic storage: On, first value at stability

Setup: Application parameters: Application 3: Statistics: Minimum load for automatic storage: 100 digits

Setup: Application parameters: Application 3: Statistics: Evaluated values: Calculated

Setup: Application parameters: Application 3: Statistics: Evaluation mode, MR function: Intermediate eval., display+print

Setup: Application parameters: Extra function(F4): Man. store in app. 3 memory (M+)

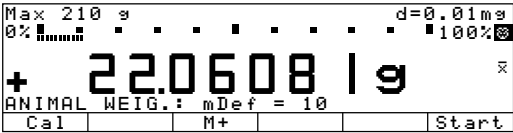
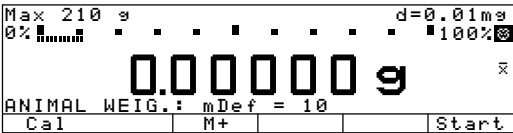
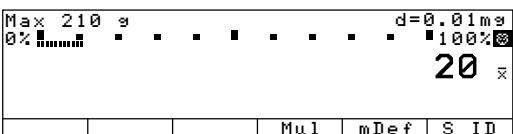
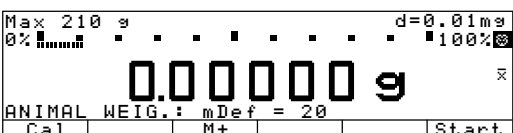
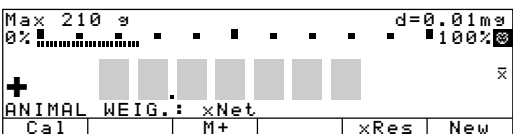
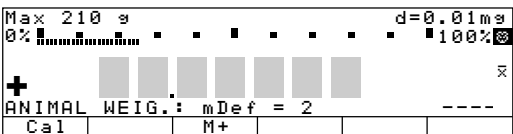
Step	Press key(s) (or follow instructions)	Display/Output
1. Prepare a container	Place empty container on the balance	 <p>Max 210 g d=0.01mg 0% 100% + 22.06081g ANIMAL WEIG.: mDef = 10 Cal M+ Start</p>
2. Tare the balance	Tare	 <p>Max 210 g d=0.01mg 0% 100% 0.00000g ANIMAL WEIG.: mDef = 10 Cal M+ Start</p>
3. Enter number of subweighing operations for averaging	2 0	 <p>Max 210 g d=0.01mg 0% 100% 20 Mul mDef S ID</p>
4. Save number	mDef soft key	 <p>Max 210 g d=0.01mg 0% 100% 0.00000g ANIMAL WEIG.: mDef = 20 Cal M+ Start</p>
5. Weigh 1st animal	Place 1st animal in container	<p>Weight fluctuates because of animal activity</p>  <p>Max 210 g d=0.01mg 0% 100% + [fluctuating bars] ANIMAL WEIG.: xNet Cal M+ xRes New</p>
6. Start automatic animal weighing	Start soft key	 <p>Max 210 g d=0.01mg 0% 100% + [fluctuating bars] ANIMAL WEIG.: mDef = 2 Cal M+ Start</p>

Step	Press key(s) (or follow instructions)	Display/Output
------	---------------------------------------	----------------

The balance delays starting the subweighing operation until three successive subweights lie within the range defined for an "active" animal

When this criterion is met, the subweighing series begins

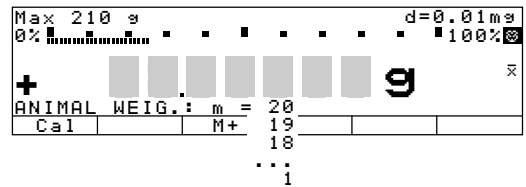

After 20 subweighing operations (n: consecutive number of subweighing x-Net: arithmetic mean, net value)

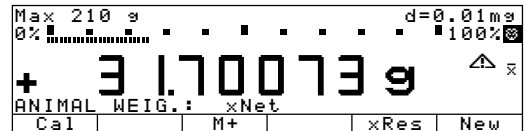

7. Save result and activate automatic storage by pressing the key (at this point, the result has not yet been automatically saved*)

M+ soft key

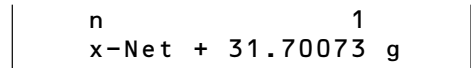

8. Unload the balance from container

Remove animal

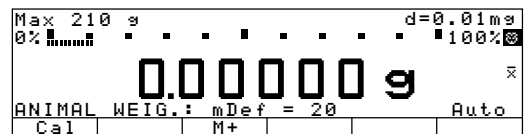

9. Weigh all 7 animals individually place the animals one after the other in the container

Individually place the

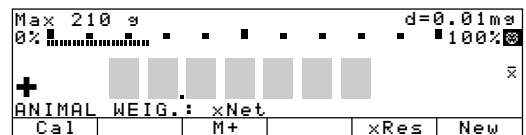

The next subweighing starts automatically; each result is automatically saved in the statistics

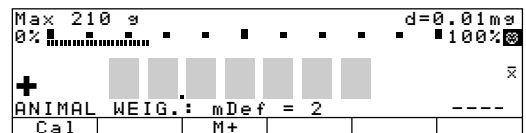

10. Display and print evaluation

MR soft key

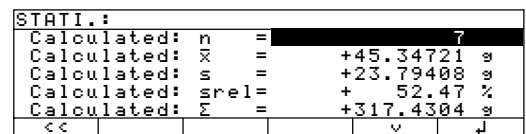

* When the statistics memory has been cleared, you need to press the M+ soft key to store the first weight manually. All further weights of the statistics series will then be stored automatically.

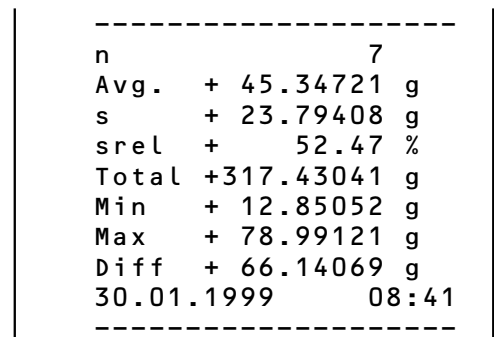

Extra Functions

Second Tare Memory (Preset Tare)

Purpose

With this function, you can store the weight currently on the balance as a tare weight, or use the numeric keys to enter a number for a preset tare weight.

You can use this function in combination with a program from Application 1 (such as counting, weighing in percent), one from Application 2 (checkweighing, time-controlled functions) and one from Application 3 (totalizing, formulation, statistics) as well as with the other extra functions.

Features

- Store a weight on the balance in the second tare memory (without numeric input)
- Store a numeric value in the second tare memory (input using the numeric keys)
- Identify a net value as **Net 1** when there is a value stored in the second tare memory
- You can assign this function to the fourth or fifth soft key (from the right); i.e., F4 or F5
The soft key designation for this function is: **PT1 / T1**
- The container-tare function can be activated in the Setup menu. Any load subsequently placed on the scale that is more than 70% of the tare weight is automatically recognized as a container and the scale is tared automatically.
- Automatic printout when a value is stored or input (see “Configuring the Balance”)
- Press **CF** to delete the (preset) tare value

Factory Settings

Container tare weight: **No**

Automatic printout: **Off**

Soft Key Functions

PT1 / T1 Store weight as tare value

PT1 Store numeric input as tare value

Printout of the Data in the 2nd Tare Memory

The printout shows either

- Net value **N1**,
- Tare weight **T1**, or
- Manually entered tare value **PT1**

N1	63.48253 g
T1	138.73234 g
PT1	150.00000 g

N1: Net weight (value) when a weight is stored in the tare memory

T1: Tare weight

PT1: Preset tare value entered using the numeric keys

Preparation

- Turn on the balance: press **ON**
- > The Sartorius logo is displayed; a self-test is performed
- Select Extra function (F4) or Extra function (F5) in the Setup menu: press **Setup**
- Select **Application parameters**: press the **v** soft key 2 x, then the **>** soft key once
- Select **Extra function (F4) or Extra function (F5)**: press the **v** soft key 3 x, then press the **>** soft key once
- Select **2nd tare memory**
- Confirm **2nd tare memory**

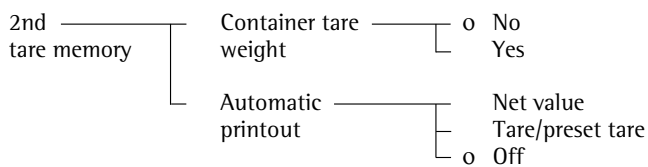

o = factory setting

see also “Application Parameters (Overview)” in the chapter entitled “Configuring the Balance”

- Save settings and exit the Setup menu: press the **<<** soft key

Second Tare Memory in Legal Metrology







- Press the **CF** soft key to enter information about the tare value using the number keys.
- The PT1 tare value is printed out with the net value.

Example

Determine the Contents of Bottles: Bottle weight = 100 g.

Settings (changes in the factory settings required for this example):

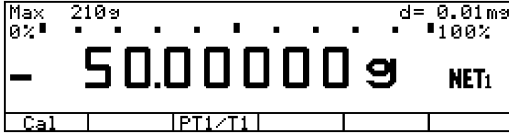
Setup: Application parameters: Extra function (F4): 2nd tare memory: Automatic printout: Tare/preset tare

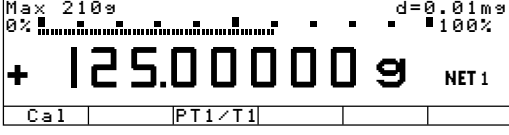
Step	Press key(s) (or follow instructions)	Display/Output
1. If necessary: turn on the balance and enter the settings given above		
2. Enter bottle weight (example: 50 g)	 	
3. Store tare value	PT 1 soft key	 
4. Determine net weight of bottles (in this case: net contents = 125 g)	Place filled bottles on the balance	

Individual Identification Codes (ID)

Purpose

With this function, you can assign IDs to values for documentation and printouts.

You can use this function in combination with any program from Application 1 (such as counting, weighing in percent), one from Application 2 (check-weighing, time-controlled functions) and one from Application 3 (totalizing, formulation, statistics) as well as with the other extra functions.

Features

- Store up to 4 IDs; these can be stored, changed or deleted individually.
- Each ID consists of a name and a value; both can be defined by the user.
- ID designations are configured as follows: Setup: Printout: Identification codes
- Each ID code can have up to 20 characters; when you enter the value later, however, no more than 15 characters of this ID are displayed.
- The ID values are entered while the application program is active; press the **ID** soft key to toggle to the ID input mode.

- Each ID value can have up to 20 characters.
- Access 1 of the 4 IDs directly using the numeric keys. The other three can only be accessed by pressing the **ID** soft key to toggle to the ID input mode.
- You can assign this function to the fourth or fifth soft key (from the right); i.e., F4 or F5.
- You can configure when the ID will be included on the printout (see "Preparation" on the next page).
- You can configure the position of IDs on the individual or total printout.
- The ID code is printed flush left; the value flush right. If the name and value together are too long for one line, the data is printed on two lines.
- Optional configuration in the Setup menu to delete a single character when entering an identification code by pressing **CF**. Setup: Device parameters: Keys: CF function for input: Delete last character
- Press the **Delete** soft key to delete an ID

Factory Settings of the ID Names

ID1: **ID1**
ID2: **ID2**
ID3: **ID3**
ID4: **ID4**

Factory Settings for ID Codes

No values set

Factory Settings of the Parameters

Printout:

Ea**c**h **t**i**m**e **t**h**e** **p**r**i**n**t** **k**e**y** **i**s **p**r**e**s**s**e**d**

Soft Key Functions

ID Toggle to "Identification codes" menu

Delete Delete input of selected ID

Printout of ID Codes

Up to 4 (stored) identification codes are printed out.

ID1	Lot no. 1234
ID2	Daimler/Chrysler
ID3	Screws M4x6
ID4	Jack Smith

ID1: Identification 1 (ID 1)
ID2: Identification 2 (ID 2)
ID3: Identification 3 (ID 3)
ID4: Identification 4 (ID 4)

Preparation

- Turn on the balance: press I/O
- > The Sartorius logo is displayed
- Select Extra function (F4) or Extra function (F5) in the Setup menu: press Setup
- Select **Application parameters**: press the \downarrow soft key 2 x, then the \rightarrow soft key once
- Select **Extra function(F4) or Extra function(F5)**: press the \downarrow soft key 3 x (or 4 x), then the \rightarrow soft key once
- Select **Identification codes**
- Confirm **Identification codes**

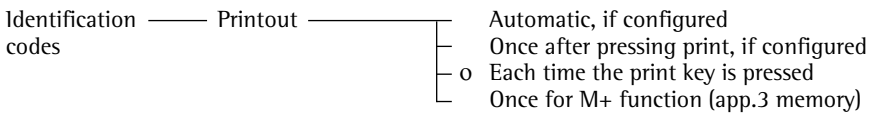

o = factory setting

see also “Application Parameters (Overview)” in the chapter entitled “Configuring the Balance”

- Save settings for the printout: press the \leftarrow soft key 4 x
- Enter ID name: Select “Printout”: press the \downarrow soft key, then the \rightarrow soft key
- Select “Identification #”: press the \downarrow soft key 5 x, then the \rightarrow soft key once
- Select **ID 1**
- Enter name for **ID 1** and confirm: use the numeric keys for numbers and/or the soft keys to enter letters
- Enter names for **ID 2**, **ID 3** and **ID 4**, if desired
- Save settings and exit the Setup menu: press the $\leftarrow \leftarrow$ soft key





Example

See next page

Example

Include company address and sample lot number on the printout. Each ID line begins with the name. Print this ID for each net value.

Settings (changes in the factory settings required for this example):
 Setup: Application parameters: Extra function (F4): Identification codes
 Setup: Input: ID1: Company
 Setup: Input: ID2: Location
 Setup: Input: ID3: Street
 Setup: Input: ID4: Lot

Step	Press key(s) (or follow instructions)	Display/Output																					
1. If necessary, turn on the balance																							
2. Select "Extra Function (F4)" in the Setup menu	 ↵ soft key 2 x, then → soft key once ↵ soft key 3 x, then → soft key once	<table border="1"> <tr><td>SETUP</td><td>APPLICATION</td><td>EXT.FCT.F4</td></tr> <tr><td>oOff</td><td></td><td></td></tr> <tr><td>2nd tare memory</td><td></td><td></td></tr> <tr><td>Identification codes</td><td></td><td></td></tr> <tr><td>Man. store in app.3 memory (M+)</td><td></td><td></td></tr> <tr><td>Product data memory</td><td></td><td></td></tr> <tr><td><<</td><td><</td><td>∨</td></tr> </table>	SETUP	APPLICATION	EXT.FCT.F4	oOff			2nd tare memory			Identification codes			Man. store in app.3 memory (M+)			Product data memory			<<	<	∨
SETUP	APPLICATION	EXT.FCT.F4																					
oOff																							
2nd tare memory																							
Identification codes																							
Man. store in app.3 memory (M+)																							
Product data memory																							
<<	<	∨																					
3. Select "Identification codes"	↵ or ^ soft key; repeatedly, if necessary	<table border="1"> <tr><td>SETUP</td><td>APPLICATION</td><td>EXT.FCT.F4</td></tr> <tr><td>oOff</td><td></td><td></td></tr> <tr><td>2nd tare memory</td><td></td><td></td></tr> <tr><td>Identification codes</td><td></td><td></td></tr> <tr><td>Man. store in app.3 memory (M+)</td><td></td><td></td></tr> <tr><td>Product data memory</td><td></td><td></td></tr> <tr><td><<</td><td><</td><td>^</td></tr> </table>	SETUP	APPLICATION	EXT.FCT.F4	oOff			2nd tare memory			Identification codes			Man. store in app.3 memory (M+)			Product data memory			<<	<	^
SETUP	APPLICATION	EXT.FCT.F4																					
oOff																							
2nd tare memory																							
Identification codes																							
Man. store in app.3 memory (M+)																							
Product data memory																							
<<	<	^																					
4. Confirm "Identification codes" and exit this menu item	→ soft key; then < soft key 3 x	<table border="1"> <tr><td>APPLICATION</td><td>EXT.FCT.F4</td><td>IDENTIFIER</td></tr> <tr><td>Printout</td><td></td><td></td></tr> <tr><td><<</td><td><</td><td>></td></tr> </table>	APPLICATION	EXT.FCT.F4	IDENTIFIER	Printout			<<	<	>												
APPLICATION	EXT.FCT.F4	IDENTIFIER																					
Printout																							
<<	<	>																					
5. Select ID1 (Printout: Identifier)	↵ or → soft key ↵ soft key 5 x, then → soft key, then ↵ soft key	<table border="1"> <tr><td>SETUP</td><td>PRINTOUT</td><td>IDENTIFIER</td></tr> <tr><td>Lot (L ID):</td><td></td><td></td></tr> <tr><td>ID1:</td><td></td><td>ID1</td></tr> <tr><td>ID2:</td><td></td><td>ID2</td></tr> <tr><td>ID3:</td><td></td><td>ID3</td></tr> <tr><td>ID4:</td><td></td><td>ID4</td></tr> <tr><td><<</td><td><</td><td>^</td></tr> </table>	SETUP	PRINTOUT	IDENTIFIER	Lot (L ID):			ID1:		ID1	ID2:		ID2	ID3:		ID3	ID4:		ID4	<<	<	^
SETUP	PRINTOUT	IDENTIFIER																					
Lot (L ID):																							
ID1:		ID1																					
ID2:		ID2																					
ID3:		ID3																					
ID4:		ID4																					
<<	<	^																					
6. Enter name for ID 1 (in this case: COMPANY and confirm)	 ... see also page 44  , ↓ soft key	<table border="1"> <tr><td>SETUP</td><td>PRINTOUT</td><td>IDENTIFIER</td></tr> <tr><td>Lot (L ID):</td><td></td><td></td></tr> <tr><td>ID1:</td><td></td><td>COMPANW</td></tr> <tr><td>ID2:</td><td></td><td>ID2</td></tr> <tr><td>ID3:</td><td></td><td>ID3</td></tr> <tr><td>ID4:</td><td></td><td>ID4</td></tr> <tr><td>ABCDEFGHIJKL</td><td>MNOPQR</td><td>STUVWX YZ/--? :##"& </td></tr> </table>	SETUP	PRINTOUT	IDENTIFIER	Lot (L ID):			ID1:		COMPANW	ID2:		ID2	ID3:		ID3	ID4:		ID4	ABCDEFGHIJKL	MNOPQR	STUVWX YZ/--? :##"&
SETUP	PRINTOUT	IDENTIFIER																					
Lot (L ID):																							
ID1:		COMPANW																					
ID2:		ID2																					
ID3:		ID3																					
ID4:		ID4																					
ABCDEFGHIJKL	MNOPQR	STUVWX YZ/--? :##"&																					

Step	Press key(s) (or follow instructions)	Display/Output
7. Repeat steps 7 and 8 for: ID2: LOCATION ID3: STREET ID4: LOT		<pre> SETUP PRINTOUT IDENTIFIER Lot (L ID): ID1: COMPANY ID2: LOCATION ID3: STREET ID4: LOT << < ^ v ↓ </pre>
8. Save settings, exit the Setup menu and select input mode for IDs	<< soft key ID soft key	<pre> ID: COMPANY LOCATION STREET LOT << Delete v ↓ </pre>
9. Enter name of company (such as Sartorius)	(ABC) ... see also page 44	<pre> ID: COMPANY LOCATION STREET LOT ABCDEF GHIJKL MNOPQR STUVWX YZ/=-? :;#*"%& SARTORIUS </pre>
10. Confirm input	(ABC) , ↓ soft key	<pre> ID: COMPANY LOCATION STREET LOT SARTORIUS << Delete ^ v ↓ </pre>
11. Repeat steps 10 and 11 for LOCATION: GOETTINGEN STREET: WEENDER LANDSTRASSE LOT: 15		<pre> ID: COMPANY LOCATION STREET LOT SARTORIUS GOETTINGEN WEENDER LANDSTRASSE 15 << Delete ^ v ↓ </pre>
12. Place the first sample on the balance (ex.: weight of 110.53214 g)	Place load on balance	<pre> Max 210 g d=0.01mg 0% ██████████ 100% + 110.53214 g Cal ID </pre>
13. Print weight (if desired, perform further weighing operations and print results)	(P)	<pre> COMPANY SARTORIUS LOCATION GOETTINGEN STREET WEENDER LANDSTRASSE LOT 15 N +110.53214 g </pre>
14. When weighing is completed, delete each ID individually or switch off this function in the Setup menu	ID soft key Delete soft key 4 times	<pre> ID: COMPANY LOCATION STREET LOT SARTORIUS GOETTINGEN WEENDER LANDSTRASSE 15 << Delete v ↓ </pre>

Saving Values Manually in M+

Purpose

This extra function enables you to load weight values and calculated results directly from Application 1 (such as counting, weighing in percent) or Application 2 (checkweighing, time-controlled functions) into Application 3 (totalizing, formulation, statistics).



Features

- You can assign this function to the fourth or fifth soft key (from the right); i.e, F4 or F5; the soft key label for this function is **M+**
- An Application 3 program (totalizing, formulation, statistics) must be running so you can display and print the result

Factory Settings of the Parameters

No user-definable parameters

Preparation

- Turn on the balance: press 
 - > The Sartorius logo is displayed
 - Select Extra function (F4) or Extra function (F5) in the Setup menu: press 
 - Select **Application parameters**: press the ∇ soft key 2 x, then the \triangleright soft key
 - Select **Extra function (F4) or Extra function (F5)**: press the ∇ soft key 3 x (or 4 x), then the \triangleright soft key once
 - Select **Man. store in app.3 memory (M+)**
 - Confirm **Man. store in app.3 memory (M+)**
- See also “Application Parameters (Overview)” in the chapter entitled “Configuring the Balance”
- Save settings and exit the Setup menu: press the \ll soft key

Changing the Resolution

Purpose

To change the resolution of the weighing result. This enables quicker weighing at a lower resolution.

Features

- Weights can be displayed with a reduced resolution.
- Once this function is selected, the display will appear as usual, e.g., » ... d=0.01 mg« will be shown. To toggle to the 4-digit range: press the **d*10** key. In the metrological line of the display, the readout will toggle accordingly to » ... d=0.1 mg«. Afterwards, the soft key should be labeled with **d/10**.
- In general, the balance is tared each time the number of decimal digits displayed is changed. This ensures that the unit is precisely tared in accordance with the regulations governing legal metrology each time the readout is toggled.
- This function can be assigned to either the fourth or fifth soft key from the right (F4 or F5). The soft keys are labeled as follows:
 - during normal resolution:
d*10
 - during reduced resolution:
d/10
- The display cannot be zeroed if any object is loaded on the weighing pan. In this case, the error message **ERR. 08. <> zero range** will appear.

Factory settings of the parameters

No parameters can be set.

Preparation

- Turn on the balance: press **ON**
- > The Sartorius logo is displayed
- Select Extra function (F4) or Extra function (F5) in the Setup menu: press **Setup**
- Select **Application parameters**: press the **∨** soft key twice, then **➤** soft key once
- To select **Extra function (F4)** or **Extra function (F5)**: press the **∨** soft key repeatedly, then **➤** soft key once
- Select **Change Resolution**
- Confirm the **Change Resolution** function.





See also: "Application Parameters (Overview)" in the chapter entitled "Configuring the Balance"
- Store the settings and exit the setup menu: press the **<<** soft key.

Example

Quick determination of the weights of a few consecutive samples with reduced resolution.

Presettings (different from the factory settings):

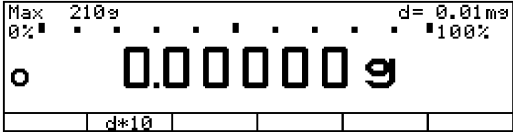
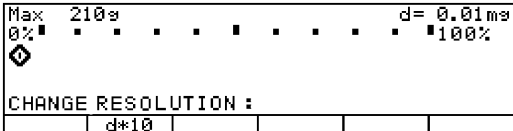
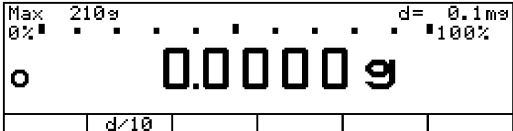
Setup: Application parameters: Additional function (F5): Change resolution

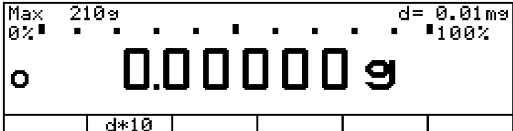
Step	Press key(s) (or follow instructions)	Display/Output
1. Switch on the balance if necessary and enter the presettings as shown above		
2. Unload and tare the balance		
3. Reduce the resolution (here: 0.1 mg) Readout while resolution is being changed:	d*10 soft key	
Afterwards, the reduced resolution is displayed		
3. Reduce the resolution (here: 0.1 mg)	d*10 soft key	
4. Weigh the example (Example) and weigh other samples as necessary	Place the sample on the weighing pan	
5. Change the resolution back to normal: Unload the balance if necessary and tare		
6. Change the resolution (here: 0.01 mg)	d/10 soft key	

Product Data Memory

Purpose

With this function, you can enter, store and load data records for initialization of applications, including user-defined data.

You can use this function in combination with a program from Application 1 (such as counting, weighing in percent), one from Application 2 (checkweighing, time-controlled functions) and an extra function from Application 3 (identification codes, 2nd tare memory).

Features

- Store up to 300 data records
- Data records can be created, stored or deleted individually
- Press the **ProDat** soft key to display data records
- Define a name for each data record of up to 15 alphanumeric characters; the desired location is displayed in the product data memory
- Assign this function to soft key F4 or F5 to load product ID data without activating the “ID” function

- Optional configuration in the Setup menu to delete a single character when entering a data record name by pressing **CF**. Device settings: Keys: CF function for input: Delete last character.
- Data records are displayed in alphabetical order.
- Initialization data set for an application (such as wRef, nRef) is saved when you select the Store option. With several applications and extra functions active, you can select the desired parameters before saving the data to define initialization data.
- Use the numeric keypad to search for and display individual data records
- You can assign this function to the fourth or fifth soft key (from the right), i.e. F4 or F5
- Error messages are displayed in the text line in plain English – or your choice of a different language.

- Press the **Delete** soft key to delete a data record

Battery-Backed Data Memory:
When the balance is disconnected from AC power, balance-generated data remains stored for approx. three months. In the standby mode, the data memory uses the power supply.

Preparation

- Turn on the balance: press **ON**
 - > The Sartorius logo is displayed
 - Select Extra function (F4) or Extra function (F5) in the Setup menu: press **Setup**
 - Select **Application parameters**: press the **v** soft key 2 x, then the **>** soft key once
 - Select **Extra function (F4) or Extra function (F5)**: press the **v** soft key 3 x (or 4 x), then the **>** soft key
 - Select **Product data memory**
 - Confirm **Product data memory**
- See also “Application Parameters (Overview)” in the chapter entitled “Configuring the Balance”
- Save settings and exit the Setup menu: press the **<<** soft key

Factory Settings

No user-definable parameters.

Soft Key Functions

ProDat Toggle to data record display

Delete Delete selected data record

Load Overwrite the initialization data with the selected data record

Change Change the data in the stored data record

New Create a new data record (after entering a data record name) and selecting an application, if desired).

Store Store the initialization data of the current application under the selected data record name. If data already exist for this data record, a prompt asks whether these data should be overwritten.

No Answer “No” to cancel the initiated delete or overwrite operation





Yes Answer “Yes” to perform the delete or overwrite operation

Example

Create a new product base data record for initializing the checkweighing program, including: target value, minimum, maximum

Settings (changes in the factory settings required for this example):

Setup: Application parameters: Extra function (F4): Product data memory
 Setup: Application parameters: Application 2: Checkweighing

Step	Press key(s) (or follow instructions)	Display/Output
1. If necessary, turn on the balance; then enter the settings given above		
2. In the Checkweighing application, toggle to the input mode for target, minimum and maximum values	Param. soft key	<pre> CHECKWEIGH: 0.00000 g Target: Setp= + 0.00000 g Minimum: Min = + 0.00000 g Maximum: Max = + 0.00000 g << v </pre>
3. Enter target: 170 g; minimum: 165 g; maximum: 180 g	see the Example for Checkweighing, steps 5 through 9	<pre> CHECKWEIGH: +170.00000 g Target: Setp= +170.00000 g Minimum: Min = +165.00000 g Maximum: Max = +180.00000 g << ^ </pre>
4. Toggle to display of product data (existing data records are displayed; in this example, 3 data records have been stored)	ProDat soft key	<pre> PROD. DATA: PERCENT WGH PERCENT WGH40 Wxx% 68.75432 g CALCULATION8 pRef 100 % COUNTING13 << Delete Load v Change </pre>
5. Enter a name for the new data record (here: CHW01)	 ABCDEF soft key, C soft key GHIJKL soft key, H soft key STUVWX soft key, W soft key  	<pre> PROD. DATA: CHW01 << < New </pre>
6. Store current Checkweigh parameters as a data record	New soft key	<pre> PROD. DATA: NEW: KW01 CHECKWEIGH Setp= +170.00000 g Min = +165.00000 g Max = +180.00000 g Lim- = 3 % Lim+ = 6 % << < Store </pre>
7. Confirm storage function	Store soft key	<pre> PROD. DATA: Data stored CHW01 Setp= +170.00000 g PERCENT WGH40 Min = +165.00000 g CALCULATION8 Max = +180.00000 g COUNTING13 Lim- = 3 % Lim+ = 6 % << Delete Load v Change </pre>
8. Exit product data display	<<< soft key	<pre> Max 210 g + 169.48765 g CHCKW.: n = 1 Setp= +170.00000 g Cal ProDatParam. Net Show </pre>

SQmin Function

Purpose

To display the allowable minimum sample quantity "SQmin" in accordance with the United States Pharmacopeia (USP). According to USP guidelines, the uncertainty of measurement may not exceed 0.1 % of the sample quantity when substances are weighed with the highest degree of accuracy for volume determination. This additional function ensures that weight results lie within defined tolerance limits corresponding to the requirements of your quality assurance system.

Features







- The service technician will determine the required minimum sample quantity based on your quality assurance requirements at the location where the balance is set up. Afterwards, he will store this value in the balance. This setting cannot be changed by the user. Once he has finished programming the balance, the service technician will prepare a "Test in Accordance with the USP" certificate, on which he will record the measurements and the minimum sample quantity for the balance. If you use the SQmin function, you can be sure that the weight results will correspond to the specifications on the certificate and, therefore, USP guidelines.
- Displaying the minimum sample quantity:
The value is shown in the next line for 4 seconds after the "SQmin" soft key is pressed
or
the value is constantly displayed in place of the bar graph.
- This function can be assigned to either the fourth or fifth soft key from the right (F4 or F5). The soft key should then be labeled with **SQmin**.
- If the minimum sample quantity has not been reached:
The **SQmin** soft key will flash inversely. Weights will be marked with an asterisk "*" in the printout.
- Header of GLP-complicant records: The minimum sample quantity entered for "SQmin" can be printed out in addition.

Factory-set parameters

Display: **Text display**

Print in GLP header: **Off**

Preparation

- Turn on the balance: press 
- > The Sartorius logo is displayed
- Select Extra function (F4) or Extra function (F5) in the Setup menu: press 
- Select **Application parameters**: press the  soft key twice, then press the  soft key once
- Select **Extra function (F4) or Extra function (F5)**: press the  soft key repeatedly, then press the  soft key
- Select **SQmin**.
- Confirm **SQmin**.

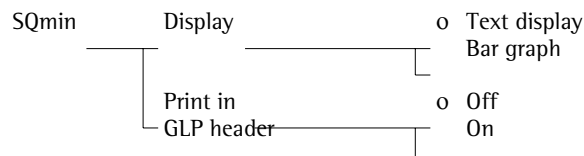

o = Factory setting

See also "Application Parameters (Overview)" in the chapter entitled "Configuring the Balance"







- Store the settings and exit the Setup menu: press the  soft key.

Example

Determining the weights of samples while monitoring the minimum sample quantity (here: SQmin: 30 mg)

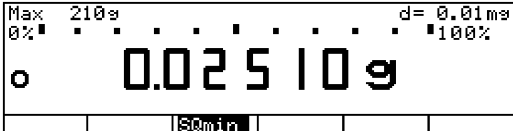
Presettings (different from the factory settings):

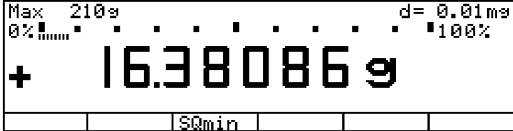
Setup: Application parameters: Additional function (F4): SQmin

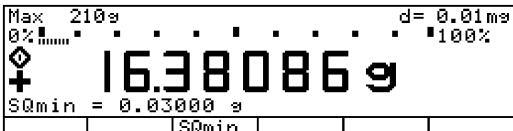
Step	Press key(s) (or follow instructions)	Display/Output
1. Switch on the balance if necessary and enter the presettings as shown above		
2. Place the container into which the sample will be filled onto the weighing pan and tare the balance		
3. Weigh a sample (here: the minimum sample quantity has not been reached)	Place the sample on the weighing pan	
4. Print out the weight		*N + 0.02510 g
5. Weigh another sample (here: the minimum sample quantity has been exceeded)	Place the sample on the weighing pan	
6. Print out the weight		N + 16.38086 g
7. Display the minimum sample quantity for 4 seconds	SQmin soft key	
8. If necessary, weigh further samples		

DKD Uncertainty of Measurement

Purpose

Display of the dynamic uncertainty of measurement in conformance with the specifications listed on the DKD Calibration Certificate.

Features

After Technical Service has prepared the balance:

- A service technician performs on-site DKD calibration of your balance to determine its uncertainty of measurement. On the DKD Calibration Certificate, the measurements and the uncertainty for the initial sample weight are recorded. Then the service technician enters this data in the balance.
- Display of the factor and the exponent entered; activation by accessing the Setup menu: Device information: DKD uncertainty of measurement
- Display of the uncertainty of measurement, for example:
 Absolute uncertainty of measurement:
 $U = 0.000292 \text{ g}$
 Relative uncertainty of measurement:
 $U^* = 0.00029 \text{ ‰}$
 Process accuracy:
 $PA = 0.00087 \text{ ‰}$
- Display of up to 2 DKD uncertainty of measurement values:
 The first two calculated values that are activated by selecting "Display" in the Setup menu are shown.
- This function can be assigned to a key identified by the fourth or fifth soft key (from the right, F4 or F5).
 The soft key is identified by U/PA
- Resolution
 The absolute uncertainty of measurement is displayed with a 10 times higher resolution.
 The absolute uncertainty of measurement and the process accuracy are displayed with up to 5 decimal places (2 significant decimal places).
- Printout of the addend and the factor of the uncertainty of measurement when the power is turned on:
 In the Setup menu, select "Auto print upon initialization: All values."
- Display ----- (for U^* and PG) for:
 - Calculated net values (e.g., counting, weighing in percent, etc.)
 - Values greater than 100%
 - Net value equal to "zero"

Preparation

- Turn on the balance: press ON
- > The Sartorius logo is displayed
- In the Setup menu, select "Extra functions (F4)" or "Extra functions (F5)":
 press Setup
- Select the **Application parameters**: press the V soft key 2 times, then the > soft key
- Select **Extra function (F4)** or **Extra function (F5)**:
 press the V soft key repeatedly, then press the > soft key
- Select **DKD uncertainty of measurement**
- Confirm **DKD uncertainty of measurement**

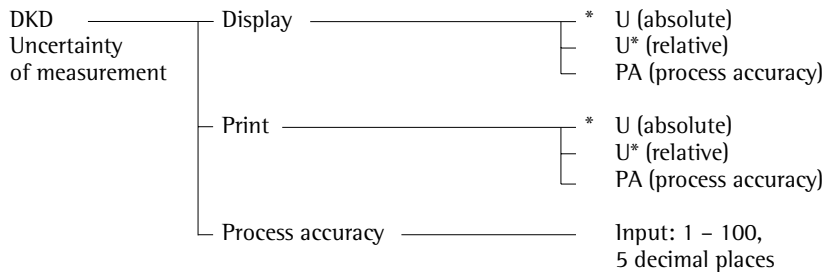

* = An asterisk (*) indicates an activated menu item. You can select up to 3 items.
 * = factory setting

See also "Application Parameters (Overview)" in the chapter entitled "Configuring the Balance"

- Save settings and exit the Setup menu: press the << soft key

Example





Perform a weighing procedure with the “DKD uncertainty of measurement” application

Settings:

Setup: Application parameters: Extra function (F4): DKD uncertainty of measurement: Display: PA (process accuracy)

Setup: Application parameters: Extra function (F4): DKD uncertainty of measurement: Print: PA (process accuracy)

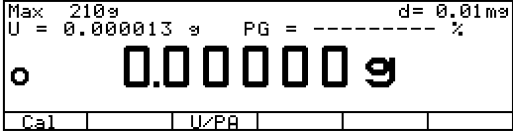
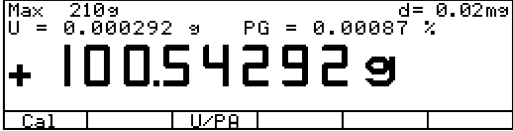
Setup: Application parameters: Extra function (F4): DKD uncertainty of measurement: Display: Input: 3.00000 (factory setting)

Step	Press key(s) (or follow instructions)	Display/Output						
1. Turn on the balance, if not on, and configure the settings as indicated above								
2. Place a container for a sample on the balance and tare								
3. Measure weight of sample	Add sample to container							
4. Print weight		<table border="1" data-bbox="1018 1072 1414 1162"> <tr> <td>U</td> <td>0.000292 g</td> </tr> <tr> <td>PA</td> <td>0.00087 %</td> </tr> <tr> <td>N</td> <td>+100.54292 g</td> </tr> </table>	U	0.000292 g	PA	0.00087 %	N	+100.54292 g
U	0.000292 g							
PA	0.00087 %							
N	+100.54292 g							
5. Weigh next sample (if any)								

Combining Applications

The following table summarizes the possibilities for combination of the application programs described here. Each line stands for one combination. The weighing function is generally available, and does not have to be combined with a calculating function.

Application 1 (basic settings)	Application 2 (checking and control functions)	Application 3 (data records and documenting functions)
Counting	-	Totalizing
Counting	-	Formulation
Counting	-	Statistics
Weighing in percent	-	Totalizing
Weighing in percent	-	Formulation
Weighing in percent	-	Statistics
Animal weighing	-	Totalizing
Animal weighing	-	Statistics
Recalculation	-	Totalizing
Recalculation	-	Statistics
Calculation	-	Totalizing
Calculation	-	Formulation
Calculation	-	Statistics
Density determination	-	Statistics
Density determination	Time-controlled functions	Statistics
Differential weighing	-	-
Air buoyancy correction	-	Totalizing
Air buoyancy correction	-	Statistics
Diameter determination	-	Totalizing
Diameter determination	-	Formulation
Diameter determination	-	Statistics
-	Checkweighing	Totalizing
-	Checkweighing	Formulation
-	Checkweighing	Statistics
Counting	Checkweighing	Totalizing
Counting	Checkweighing	Formulation
Counting	Checkweighing	Statistics
Weighing in percent	Checkweighing	Totalizing
Weighing in percent	Checkweighing	Formulation
Weighing in percent	Checkweighing	Statistics
Recalculation	Checkweighing	Totalizing
Recalculation	Checkweighing	Statistics
Calculation	Checkweighing	Totalizing
Calculation	Checkweighing	Formulation
Calculation	Checkweighing	Statistics
Air buoyancy correction	Checkweighing	Totalizing
Air buoyancy correction	Checkweighing	Statistics
Diameter determination	-	Totalizing
Diameter determination	-	Formulation
Diameter determination	-	Statistics
-	Time-controlled functions	Totalizing
-	Time-controlled functions	Formulation
-	Time-controlled functions	Statistics
Counting	Time-controlled functions	Totalizing
Counting	Time-controlled functions	Formulation
Counting	Time-controlled functions	Statistics
Weighing in percent	Time-controlled functions	Totalizing
Weighing in percent	Time-controlled functions	Formulation
Weighing in percent	Time-controlled functions	Statistics
Animal weighing	Time-controlled functions	Totalizing
Animal weighing	Time-controlled functions	Statistics
Recalculation	Time-controlled functions	Totalizing
Recalculation	Time-controlled functions	Statistics
Calculation	Time-controlled functions	Totalizing
Calculation	Time-controlled functions	Formulation
Calculation	Time-controlled functions	Statistics
Air buoyancy correction	Time-controlled functions	Totalizing
Air buoyancy correction	Time-controlled functions	Statistics
Diameter determination	-	Totalizing
Diameter determination	-	Formulation
Diameter determination	-	Statistics

Practical Combination of Several Applications

Example: Density determination with statistical evaluation

Density determination of a solid sample using the displacement method with water and statistical evaluation of 10 measurements

- Settings (changes in the factory settings required for this example):
 Setup: Application parameters: Application 1 (basic settings): Density: Method: Displacement
 Setup: Application parameters: Application 1 (basic settings): Density: Decimal places for disp. of vol.: 2 decimal places
 Setup: Application parameters: Application 2 (control functions): Off
 Setup: Application parameters: Application 3 (data record): Statistics: Evaluated values: Calculated
 Setup: Application parameters: Extra function (F4): Man. store in app.3 memory (M+)

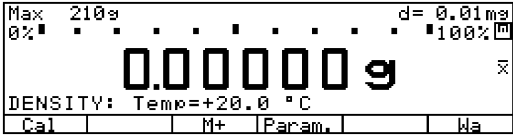
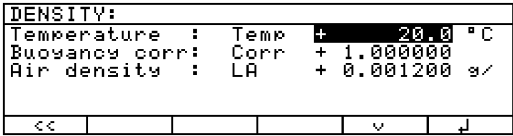
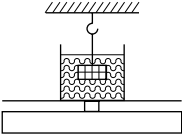
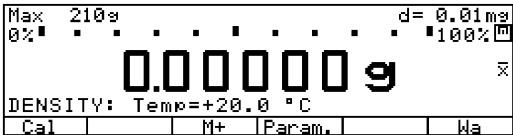
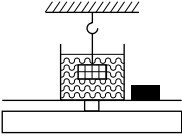
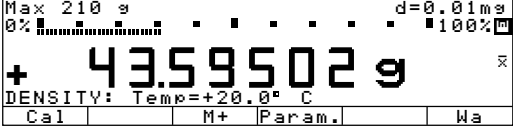
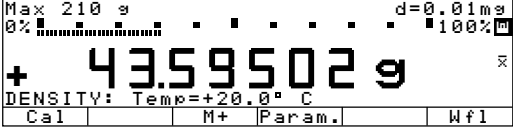
Step	Press key(s) (or follow instructions)	Display/Output
1. Delete previously stored values, if necessary	CF	 <p>Max 210g d=0.01mg 0% 100% 0.00000g DENSITY: Temp=+20.0 °C Cal M+ Param. Wa</p>
2. Change the parameters to the ones listed above, if not already set and save	Param. soft key << soft key	 <p>DENSITY: Temperature : Temp + 20.0 °C Buoyancy corr: Corr + 1.000000 Air density : LA + 0.001200 g/l << v ↓</p>
3. Position the sample holder (immerse in water)		
4. Tare the balance	Tare	 <p>Max 210g d=0.01mg 0% 100% 0.00000g DENSITY: Temp=+20.0 °C Cal M+ Param. Wa</p>
5. Determine the weight of the sample in air: place sample on the weighing pan		 <p>Max 210g d=0.01mg 0% 100% + 43.59502g DENSITY: Temp=+20.0 °C Cal M+ Param. Wa</p>
6. Store weight value	Wa soft key	 <p>Max 210g d=0.01mg 0% 100% + 43.59502g DENSITY: Temp=+20.0 °C Cal M+ Param. Wf1</p>

Step	Press key(s) (or follow instructions)	Display/Output
7. Determine the weight of the sample in liquid: place sample in the sample holder		
8. Store weight in liquid; the density of the sample is displayed (toggle if nec., density/volume/weight)	W f 1 soft key	
9. Save density in the statistics memory; the sample number and density are displayed for 2 seconds	M+ soft key	
The sample number and density are automatically printed		<pre>n 1 Rho + 1.28 g</pre>
10. Determine the density of the additional samples, and store these values in the statistics memory as described in steps 5 through 9 (in this case, 10 samples)		<pre>n 10 Rho + 1.29 g/</pre>
11. Generate statistics printout Toggle to the "Statistics" application Print statistics	, MR soft key, 	<pre>----- n 10 Avg. + 1.28 g/ s + 0.02 g/ srel + 1.78 % Total + 12.82 g/ Min + 1.27 g/ Max + 1.30 g/ Diff + 0.03 g/ 11.01.2000 15:44 -----</pre>

Data Output Functions

There are 3 options for data output:

- Output to the display and control unit
- Output to a printer (generate a printout)
- Output to a peripheral device (e.g., computer) via the interface port

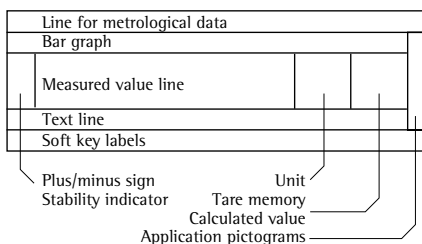

Output to the Display and Control Unit

The display is divided into 9 sections. Information about the balance, the application being used and the sample weighed is output in the following sections:

- Line for metrological data
- Bar graph
- Plus/minus sign, stability symbol display
- Line for measured values (weights)
- Weight unit display
- Data in tare memory; calculated value
- Application symbol display
- Text line
- Soft key labels

Line for Metrological Data (on balances verified for legal metrology)

This line shows:

- Maximum weighing capacity (such as 210 g)
- Minimum weighing capacity; the weight must not go below this limit in Germany (such as 1 g)
- Verification scale interval; irrelevant if the balance is not used in legal metrology (such as 0.1 mg)
- Readability/actual scale interval: indicates the balance's display increment in digits (such as 0.01 mg)

Bar Graph (overview display)

In the bar graph, weighing results are displayed either

- as a percentage of the maximum balance capacity, or
- in relation to a target value, with tolerance limits indicated.

You can turn off (blank) the bar graph display (Setup: Device parameters: Display: Digit size: 13 mm + text display or 13 mm)

Plus/Minus Sign, Stability Symbol

This section shows:

- "Busy" symbol
- Plus or minus sign
- Zero symbol (indicating the scale has been zeroed)

125.03
 35
 =W* 18.3*0.9

- Line for Measured Values
 This line shows:
- The current weight value
 - Calculated values (such as piece counts)
 - User input (such as a lot number or equation)

g
 PCS

- Weight Unit Display
 This section shows:
- The current weight unit (such as kg)
 - Designation of other values (such as “pcs” for piece count)

▲
 NET1 NET2

- Tare Memory, Calculated Value
 This section shows:
- Indication that a value is calculated (not valid in legal metrology)
 - Indication that the tare memory contains application data

U1 ▲ % ⊗ ⊕

- Application Symbols
 This column shows:
- Symbol for Application 1 (toggling between weight units, counting, weighing in percent, animal weighing, calculation, etc.)

% ⊕

- Symbol for Application 2 (checkweighing, time-controlled functions)

Σ ⊕ ⊗

- Symbol for Application 3 (totalizing, formulation, statistics)

⊗

- Symbol for current print job

⊕

- Symbol for ISO/GLP printout

COUNTING: nRef = 10 pcs
 Ref. wt. too light

- Text Line
 This line contains:
- Explanatory text about the application program (for example, about “Counting”)
 - Explanation of error codes

Cal PT1/T1 S-ID M+
 << < ^ v > ↓

- Soft Key Labels
 This line shows
- Texts (abbreviations) to indicate the function assigned to each key
 - Symbol for selecting and confirming parameter settings (see also “Operating Design”)

Balance Information

In the Setup menu, you can select **Setup: Info: Device information** for a display of balance information. The display includes:

- Software version number
- Balance version number
- Draft shield version number
- Balance model
- Balance serial number
- Date: next maintenance
- Service phone
- Minimum sample quantity SQmin

SETUP	INFO	Device
Version no:		01-41-05
Wsh.svs. ver. #:		00-21-09
Draft sh. ver. #:		05-01-03
Model:		ME215S
Serial no:		91205355
<<	<	v

Interfaces

Purpose

The ME/SE series balances have two interfaces that allow weights and other measured values, calculated values and parameter settings to be output to a printer, PC or checkweighing display, etc. Control commands (for foot switch functions) and alphanumeric inputs (such as those from an online bar code scanner) can also be input in the balance via the two interfaces.

Features

- ME/SE series balances have two serial interface ports:
 - Serial printer port (PRINTER – Serial Out)
 - Serial communications port (PERIPHERALS – Serial I/O)
- The serial printer port has a permanently installed 25-contact D-Sub female connector (RS-232)
- The following printers can be connected to this printer port:
 - YDP02
 - YDP03
 - YDP01IS
 - YDP01IS Label
 - YDP02IS
 - YDP02IS Label
 - Universal
 - YDP04IS
 - YDP04IS Label

△ You may need to use an external power supply to operate peripheral devices.

- In addition, the following equipment can be connected to the printer port:
 - Remote display
 - Hand switch
 - Foot switch
 - External checkweighing display
 - Bar code scanner*
 - Keyboard*

* using the YCC01-0024M01 adapter (see “Accessories”)
- The serial communications port has a 25-contact D-Sub female connector as a standard feature. This connector can be exchanged for either of the two female connectors below:
 - 12-contact round connector (RS-485 for xBPI; RS-232 for SBI, xBPI)
 - 9-contact D-Sub connector for direct connection of a PC
- Both the 12-contact and the 9-contact female interface connectors are additionally equipped with a 5-pin male connector to directly interface an external bar code scanner or a keyboard.
- The serial communications port can be used in the following modes:
 - SBI
 - xBPI (BPI)
- The following equipment can be connected to this serial communications port:
 - Printer not verifiable for legal metrology in the EU
 - PC
 - Remote display
 - Hand switch
 - Foot switch
 - External checkweighing display
 - T-connector
 - Bar code scanner*
 - Keyboard*

* if the 25-contact D-Sub female connector is installed, you will need to use the YCC01-0024M01 adapter (see “Accessories”)

- Printouts generated from the application programs or by the configurable print function can be output to the serial printer port or to the serial communications port or to both.
- If you have selected the automatic print mode, data will be output to the serial communications port; printouts generated by the application programs will then only be output to the serial printer port.
- In the xBPI mode, the serial communications port can operate independently of the serial printer port (this means you can transfer data from the balance to a PC and use this PC to control your balance while generating printouts via the serial printer port).
- In the SBI mode, you can use ESC commands from your PC to control the balance via the serial communications port.

For printing an individual value on request, either by pressing the print key  or by sending an ESC P print command, the particular menu setting determines which data port will be selected for data output.

Factory Settings of the Parameters

Device parameters: Interfaces:
Serial communication: **SBI**

Serial printer: **YDP03**

Printout: Output to interface ports: serial
communicaton (PERIPHERALS):
Application-defined output

Printout: Output to interface ports:
Serial printer (PRINTER):
**Application-
defined output**

Preparation

Configuring the Interfaces

- Turn on the balance: press 

> The Sartorius logo is displayed; a self-test is performed

- Configure the interfaces : press 

● Select **Device parameters**: press the \vee soft key, then the \triangleright

● Select **Interfaces**: press the \vee soft key 5 x, then the \triangleright soft key once

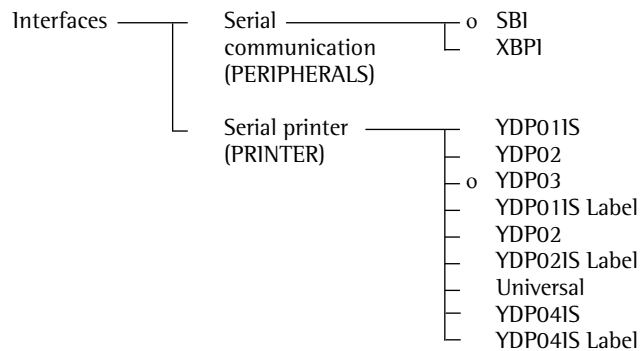

o = factory setting

see also the “Application Parameters (Overview)” in the chapter entitled
“Configuring the Balance”

- Save settings and exit the Setup menu: press the \ll soft key

Configuring a Printout

- Turn on the balance: press **Setup**
- Select **Printout**: press the **v** soft key 3 x, then the **>** soft key once

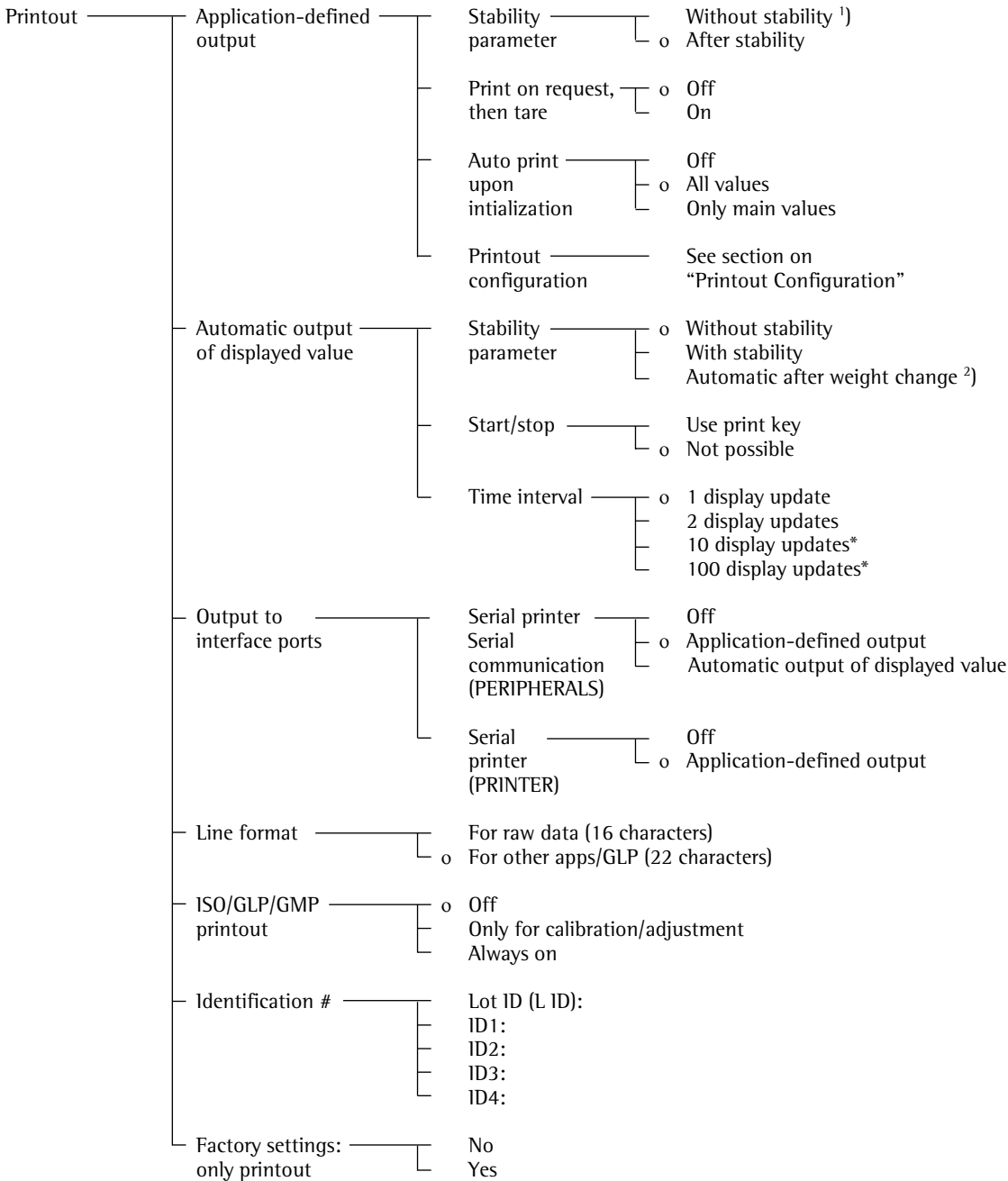

o = factory setting

* = not applicable to verified balances

¹⁾ = Information on use in legal metrology: Only permitted for control purposes; printouts are not allowed

²⁾ = auto print when load change is > 10d and stability is reached; no printout until residual difference in load value is < 5d

Printouts

Purpose

This function enables you to print out weights, other measured values and IDs. You can format the printout to meet different requirements.

Features

Line format: you can configure a data ID code with up to 6 characters at the beginning of each of the values to be printed

Weight ID:

You can configure an extra line for identification of each weighed or calculated value using the code **S I D**

Print application parameters:

You can generate a printout of the values configured for initialization of an application before printing the measured results

ISO/GLP-compliant printout:

You can print out parameters relating to the weighing conditions

Print animal weights:

Application-defined, automatic printout of animal weights or of animal weights plus calculated weights after averaging

Optimizing interfaces:

- Use the highest possible baud rate
- Turn off interfaces that are not in use
- Optimize the amount of data to be transferred

Output to the Interface Ports

Print Mode	Trigger	Operating mode: PERIPHERALS	
PERIPHERALS		SBI	xBPI
	ESC P (PERIPHERALS)		not possible
Application	PRINT key on balance	Prints individual printout or configured printout according to menu setting on	
(Indiv.) Printout:	PRINT key on printer, or ESC P (PRINTER)	PRINTER, PERIPHERALS or both	Prints individual printout or configured printout on PRINTER, if "on" selected in menu
	Application		
Autoprint:	ESC P (PERIPHERALS)	Turns autoprint function on/off, if autoprint can be stopped;	not possible
	PRINT key on balance	otherwise, prints individual or configured printout on PRINTER	Turns autoprint function on/off, if autoprint can be stopped; otherwise, prints individual or configured printout on PRINTER
		Cyclical output to PERIPHERALS	
	PRINT key on printer, or ESC P (PRINTER)	Prints individual or configured printout on PRINTER	Prints individual or configured printout on PRINTER
	Application		

Printer Interface

Type of interface:	Serial interface port
Operating mode:	Full duplex
Standard:	RS-232
Interface connector:	D-Sub female connector, 25-contact
Transmission rates*:	150; 300; 600; 1200; 2400; 4800; 9600 or 19,200 baud
Parity*:	Space, uneven, even
Character transmission*:	Start bit, 7/8-bit ASCII; parity, 1 or 2 stop bits
Handshake:	For 2-wire interface: software (XON/XOFF); for 4-wire interface: hardware (CTS/DTR)
Compatible devices:	YDP02, YDP03, YDP011S, YDP021S, YDP011S Label, YDP021S Label printers; universal printers, YDP041S, YDP041S Label
Manual print mode	Without stability, after stability
Auto print mode	Only application-defined output
Data output format of the balance:	16 characters, 22 characters

* depends on the operating mode (see page 125)

Configuring Printout Formats

For a number of application programs, you need to set initialization values. All values upon initialization or only the main values can be automatically printed as soon as you have configured this in the Setup menu: **Auto print upon initialization**

Weights and calculated values can be printed as numeric values either with a preceding data ID code (numeric value with 22 characters) or without one (numeric value only 16 characters). See also the section on **Line format** in the chapter entitled "Data Output Functions".

You can generate an ISO/GLP print-out always or only for calibration/adjustment or turn off this option. See also page 133.

Generating an ISO/GLP Printout

In the Setup menu, you have a choice of three settings:

- No ISO/GLP printout generated (**Off**)
- ISO/GLP printout generated only for calibration/adjustment (**Only for calibration/adjustment**)
- Every printout is an ISO/GLP-compliant report (**Always on**)

Auto print checkweighing results: automatic printout of a weight when it lies within the preset limits at stability

Auto print with time-controlled functions: automatic printout of weights after a preset time has elapsed or at a defined time

Printout of intermediate or final evaluation from the application 3 memory (totalizing, formulation and statistics); generate by pressing the **MR** soft key

Generating Printouts Acceptable for Legal Metrology:

You can configure the Setup menu of the balance to generate data records that are acceptable for legal metrology on a Sartorius printer:

- YDP02
- YDP03
- YDP011S
- YDP011S Label
- YDP021S
- YDP021S Label
- YDP041S
- YDP041S Label

(E) (Print) Key

Pressing this key causes the current value shown on the display to be printed out (weight with unit, calculated value, alphanumeric readout)

Setting:
Printout: Application-defined output or Automatic output of displayed value

Examples

+153.00000 g
+ 58.56234 oz t
+ 253 pcs
+ 88.23 %
+ 105.78 o

Weight in grams
Weight in Troy ounces
Piece count
Percentage
Calculated value

Line Format

The current value displayed can be printed with a data ID code of up to 6 characters at the beginning of the line. You can use this data ID code, to designate a weight readout as a net weight (N) or a calculated value as a piece count (QNT)

Setting:
Setup: Printout: Line format: For other apps./GLP (22 characters)

ID ABC123DEF456GH
L ID ABC123DEF456GH
W ID ABC123DEF456GH
N +153.00000 g
Qnt + 253 pcs
Prc + 88.23 %

Identification number*
Lot number (weighing series)*
Weight set number*
Net value
Quantity
Percentage

* = only for ISO/GLP-compliant records/printouts

Sample ID

You can have each weighed or calculated value that you print preceded by a line of text containing numbers and/or letters. You can either print this ID immediately as alphanumeric input (press (E)) or store it as the sample ID (S ID soft key) to be included on the next printout, if the "For other apps./ GLP (22 characters)" setting is configured.

S ID ABC123DEF456GH
ABC123DEF456GHI789JK
NUM 12345678

Sample ID
(with less than 14 characters)
Sample ID
(with up to 20 characters)
Numeric key output when (E) pressed

Print Application Parameters

You can generate a printout of one or more of the values configured for initialization of an application as soon as you initialize the balance. This can include such values as nRef, wRef, pRef, etc.

Setting:
Setup: Printout: Application-defined output: Auto print upon initialization

nRef 10 pcs
wRef 1.23456 g
pRef 80 %
Wxx% 120.00000 g
mDef 10
Mul 0.00347
EQUAT. =W*18.3*0.9
Setp +100.00035 g
Min + 98.10540 g
Max +102.00630 g

Counting: Reference sample quantity
Counting: Average piece weight
Weighing in percent:
Reference percentage
Weighing in percent: Reference weight
Animal weighing: Number of subweighing operations for averaging
Animal weighing: Multiplication factor
Calculation: Equation for calculation
Checkweighing: Target weight
Checkweighing: Lower limit
Checkweighing: Upper limit

Auto Print

You can have the weight readout printed automatically¹. This printout can be generated after a certain number of display updates²; you can also configure whether or not the auto-print function is dependent on the stability parameter³. The display update frequency depends on both the model of the balance and the current operating status.

Setting:
¹ Setup: Printout: Automatic output of displayed value
² Setup: Printout: Automatic output of displayed value: Time-dependent auto print
³ Setup: Printout: Automatic output of displayed value: Stability parameter

N +153.00000 g
S ID 12345678901234
Stat
Stat L
Stat H

Net weight
Sample ID
Display blank
Display underload
Display overload

ISO/GLP Printout

You can have the parameters pertaining to weighing conditions printed before (GLP header) and after (GLP footer) the values from the weighing series.

These parameters include:

GLP header:

- Date
- Time at the beginning of a weighing series
- Balance manufacturer
- Balance model
- Model serial number
- Software version
- ID number

GLP footer:

- Date
- Time at the end of the weighing series
- Field for operator signature

Operating the Balance with an ISO/GLP-compliant Logging Device (Printer)

ISO/GLP-compliant documentation requires a computer with special software. Contact Sartorius for a detailed description.

Setting:

Setup: Printout: ISO/GLP printout:
Always on

The record is output to a Sartorius YDP03-OCE Data Printer or a computer.

End GLP printout:

- Press **CF**

End GLP printout while application is active:

This requires the following settings:
Setup: Device settings: Keys:
CF function in application:
Clear only selected applications

- Press **CF**

> Text line: CF selected: clear application

- Press the **GLP** soft key

```
-----  
17.01.2000      16:12  
      SARTORIUS  
Model          ME215S  
Ser. no.       91205355  
Ver. no.       01-41-05
```

```
ID      12345678901234  
-----  
L ID    12345678901234  
nRef    10 pcs  
wRef    1.35274 g  
Qnt    + 235 pcs  
Qnt    + 4721 pcs  
S ID    12345678901234  
Qnt    + 567 pcs  
-----
```

```
17.01.2000      16:13  
Name:
```

```
-----
```

```
-----  
17.01.2000      16:24  
      SARTORIUS  
Mod.          ME215S  
Ser. no.       91205355  
Ver. no.       01-41-05
```

```
ID  
-----  
L ID  
Internal calibration  
Start:        manual  
Diff. + 0.06365 g  
Internal adjustment  
              completed  
Diff. + 0.00000 g  
-----
```

```
17.01.2000      16:25  
Name:
```

```
-----
```

Dotted line
Date/time
Balance manufacturer
Balance model
Balance serial number
Software version
(display and control unit)
Balance ID no.
Dotted line
Weighing series no. (lot)
Application initialization value
Application initialization value
Counting result
Counting result
ID for counting result
Counting result
Dotted line
Date/time
Field for operator signature
Blank line
Dotted line

Record of Internal
Calibration/Adjustment:
Dotted line
Date/time
Balance manufacturer
Balance model
Balance serial number
Software version
(display and control unit)
Balance ID no.
Dotted line
Weighing series no. (lot)
Calibration (lot) adjustment mode
Start mode for calibration/adjustment
Difference after calibration/adjustment
Confirmation of completed
calibration/adjustment routine
Difference between current and target values after calibration
Dotted line
Date/time
Field for operator signature
Blank line
Dotted line

Serial Communications Port

Purpose

The ME/SE balance has a serial communications port (labeled "PERIPHERALS") to which you can connect a computer, a remote display or an external checkweighing display.

You can use an on-line computer to change, start and/or monitor the functions of the balance and the application programs.

The communications port also provides data output port lines for the over/under checkweighing program. This port can also be used to connect a hand or foot switch.

Features

Type of interface:	Serial port
Operating mode:	Full duplex
Standard:	RS-232 (RS-485 optional)
Interface connector:	D-SUB female connector, 25-contact Optional: round female connector, 12-contact Optional: D-SUB female connector, 9-contact (Each of the optional connectors comes with a DIN 5-contact female connector)
Transmission rates:	150; 300; 600; 1200; 2400; 4800; 9600 and 19,200 baud
Parity:	Odd, even, none
Character transmission:	Start bit, 7/8-bit ASCII, parity, 1 or 2 stop bits
Handshake:	For 2-wire interface: software (XON/XOFF); for 4-wire interface: hardware (CTS/DTR)
Communication mode:	SBI, xBPI*
Network address**:	1, 2, ..., 31, 32
Manual print mode	Without stability, after stability
Automatic print mode	Without stability, at stability, when weight changes
Data output format of the balance:	16 characters, 22 characters

* xBPI communication mode always with 9600 baud, 8-bit ASCII, uneven parity, 1 stop bit

** Network address is only for the xBPI communication mode

Factory Settings of the Parameters:

Transmission rates:	1,200 baud
Parity:	Uneven
Stop bits:	1 stop bit
Handshake:	Hardware, 1 character after CTS
Communication mode:	SBI
Network address:	0
Manual printing:	After stability
Automatic printing:	Without stability
Stop automatic printing:	Not possible
Automatic printout, time-dependent:	After 1 display update
Print on request then tare:	Off
Application initialization values:	Off
Line format:	For other apps./GLP (22 characters)

Preparation

- For the pin assignment charts, see the description starting on page 139.

⚠ Warning When Using Pre-wired RS-232 Connecting Cables

RS-232 cables purchased from other manufacturers often have incorrect pin assignments for use with Sartorius balances. Be sure to check the pin assignment against the chart before connecting the cable, and disconnect any lines marked "Internally Connected" (e.g., pin 6). Failure to do so may damage or even completely ruin your balance and/or peripheral device.

Output Format (Line Format)

You can output the values displayed in the line for measured values and the weight unit with or without a data ID code

Example: Without data ID code
+ 253 pcs

Example: With data ID code
Qnt + 253 pcs

Configure this parameter in the Setup menu (Setup: Printout: Line format).

The output with a data ID code has 16 characters; without a data ID code, 22 characters.

Output Format With 16 Characters
 Display segments that are not activated are output as spaces. Characters without a decimal point are output without a decimal point.

The following characters can be output, depending on the characters displayed on the balance:

Normal Operation

Position	1	2	3	4	5	6	7	8	9	10	11	12	13	14	15	16
	+	D	D	D	D	D	D	D	D	D	*	U	U	U	CR	LF
or	-	*	*	*		
or	*	*	*	*	*	*	*	*	*	*	*					

*: Space
 D: Digit or letter
 U: Unit symbol
 CR: Carriage return
 LF: Line feed

Special Codes

Position	1	2	3	4	5	6	7	8	9	10	11	12	13	14	15	16
	*	*	*	*	*	*	-	-	*	*	*	*	*	*	CR	LF
or	*	*	*	*	*	*	A	*	*	*	*	*	*	*	CR	LF
or	*	*	*	*	*	*	A	B	*	*	*	*	*	*	CR	LF

and only upon request with ESC w0 (no print command):

	*	*	*	*	*	*	S	*	X	X	X	Y	Y	Y	CR	LF
or	*	*	*	*	*	*	I	*	X	X	X	*	*	*	CR	LF

*: Space
 AB = - -: Final readout mode A = C: Cal/adjustment
 A = H: Overload S: Draft shield status
 AB = H H: Overload in checkweighing I: Ionizer
 A = L: Underload Y,Y,Y = Draft shield doors
 AB = L L: Underload in checkweighing
 XXX = Decimal value calculated from individual status bits:

Decimal value	Binary value	Control information
1	Bit0 = 0:	No error/ionizer off
	Bit0 = 1:	Draft shield error/ionizer on
2	Bit1 = 0:	Draft shield motor off
	Bit1 = 1:	Draft shield doors in motion
8	Bit3 = 0:	Learning function off
	Bit3 = 1:	Learning function on
16	Bit4 = 0:	At least one draft shield door open
	Bit4 = 1:	All draft shield doors closed
64	Bit6 = 0:	Motorized draft shield operation
	Bit6 = 1:	Manual draft shield operation

Example for ME215/235/254/414/614:

R, M, L = COO: right door closed, middle and left doors open
 R, M, L = OCC: right door open, middle and left doors closed

Example for ME5, SE2:

W 008210

Angle of aperture:
 The draft has turned itself by 210°.

Control information:
 0 → Bit 6 – Motorized draft shield operation
 + 0 → Bit 4 – Draft shield open
 + 8 → Bit 3 – Learning function on
 + 0 → Bit 1 – Draft shield motor off
 + 0 → Bit 0 – No error
 = 08

Example: output weight of + 111.25507 mg

Position	1	2	3	4	5	6	7	8	9	10	11	12	13	14	15	16
	+	1	1	1	.	2	5	5	0	7	*	m	g	*	CR	LF

- Position 1: Plus + or minus sign – or space
- Position 2: Space or weight value digit
- Positions 3–10: Weight with decimal point; leading zeros are output as spaces
- Position 11: Space
- Positions 12–14: Characters for unit of measure or space
- Position 15: Carriage return
- Position 16: Line feed

Data Output Format with 22 Characters

When data with an ID code is output, the ID code consisting of 6 characters precedes the data with the 16-character format. These 6 characters identify the subsequent value.

1	2	3	4	5	6	7	8	9	10	11	12	13	14	15	16	17	18	19	20	21	22
I	I	I	I	I	I	+	D	D	D	D	D	D	D	D	D	*	U	U	U	CR	LF
	*	*	*	*	*	-	*	*	*		
						*	*	*	*	*	*	*	*	*	*	*					

- I: ID code character¹⁾
- *: Space
- D: Digit or letter
- U: Unit symbol¹⁾ see “Toggle between Weight Units”
- CR: Carriage return
- LF: Line feed

¹⁾ depends on balance type; e.g., not all units and characters are available on balances verified for use in legal metrology

Special Codes

1	2	3	4	5	6	7	8	9	10	11	12	13	14	15	16	17	18	19	20	21	22	
S	t	a	t	*	*	*	*	*	*	*	*	-	-	*	*	*	*	*	*	*	CR	LF
												H	H									
												L	L									
												C										

- *: Space
- : Final readout mode (unstable weight)
- H: Overload
- H H: Overload in checkweighing
- L: Underload
- L L: Underload in checkweighing
- C: Calibration/adjustment
- Draft shield and ionizer status; similar to data output format with 16 characters

Error Codes

1	2	3	4	5	6	7	8	9	10	11	12	13	14	15	16	17	18	19	20	21	22	
S	t	a	t	*	*	*	*	*	E	r	r	*	#	#	#	*	*	*	*	*	CR	LF

- *: Space
- ###: Error code number

ID code characters¹⁾

Stat	Status
ID	Identification (identifier)
L ID	Weighing series no. (lot)
W ID	Weight set number
Nom	Exact calibration weight (value)
S ID	Sample ID
NUM	Numeric input
T1	Application tare memory 1
N	Net weight (T1 = 0)
N1	Net weight (T1 0)
Qnt	Piece count
Prc	Percent
nRef	Reference sample quantity
pRef	Reference percentage
wRef	Reference piece weight
Wxx%	Reference percentage weight
mDef	Target value for animal weighing
Mul	Calculated result in animal weighing
x-Net	Result in animal weighing
x-Res	Calculated result in animal weighing
Res	Result using equation (calculation)
Setp	Target value for checkweighing
Min	Lower limit for checkweighing
Max	Upper limit for checkweighing
Time	Time that a value was stored
Compxx	Component no. xx in formulation
Tot.cp	Total weight in formulation
n	Transaction counter
Total	Sum of all values
Avg.	Average in statistics
s	Standard deviation
srel	Variation coefficient
Diff	Difference between maximum and minimum

Data Input Format

You can connect a computer to your balance to send commands via the balance interface port to control balance functions and applications.

The commands sent are control commands and may have different formats; e.g., control commands can have up to 26 characters. Each character must be transmitted according to the settings configured in the Setup menu for data transmission.





Format for Control Commands

Format 1:	Esc	!	CR	LF								
Format 2:	Esc	!	#	_	CR	LF						
Format 3:	Esc	!	#	&t	(max. 20 &t)	&t	_	CR	LF			
Format 4:	Esc	!	#	&t	(max. 20 &t)	&t	_	CR	LF			
Format 5:	Esc	!	#	#	#	_	CR LF	Exc	!	#	_CR	LF

Format 1 (e.g., ESC K)

!	Meaning
l	Weighing mode 1
L	Weighing mode 2
M	Weighing mode 3
N	Weighing mode 4
O	Block keys
P	Print
Q	Beep (acoustic signal)
R	Unblock keys
S	Restart
T	Tare and zero
Z	Internal calibration/adjustment

Format 2 (e.g., ESC f3_)

!#	Meaning
f3	Zero
f4	Tare (without zeroing)
f5	Left draft shield key (closes and opens as "learned" or standard)
f6	Right draft shield key (closes and opens as "learned" or standard)
f9	 function key
kF1	Soft key 1 * Function depends on setting in application
kF6	Soft key 6* program
kF7	 function key
kF8	 function key
m0	Ionizer status
m1	Ionizer on
m2	Ionizer off
s3	 function key
x0	Perform internal calibration
x1	Print balance model
x2	Print serial no. of weighing platform
x3	Software version of weighing platform
x4	Software version of display &t control unit
x5	Print (GLP) balance ID no.
x6	Print weight set "inventory" no.
x7	Print weighing series no.

Control Commands for the Draft Shield on Models ME215/235/254/414/614:

w0	Draft shield status
w1	Left draft shield door open
w2	Close all draft shield doors
w3	Open top draft shield door
w4	Open right-hand draft shield door
w5	Open left &t top draft shield doors
w6	Open left and right draft shield doors
w7	Open right-hand and top draft shield doors
w8	Open all draft shield doors

Esc: Escape
 !: Command character
 #: Number
 &t: Number or letter
 _: Underline (ASCII: 95)
 CR: Carriage return (optional)
 LF: Line feed (optional)
 max: depends on command character; i.e., parameter: once the max. length is reached, input received is truncated, rather than discarded as with keyboard input

Control Commands for the Draft Shield on the ME5 and SE2:

w0	Draft shield status
w1	Open draft shield 100° towards the left (stored position is deleted)
w2	Close draft shield
w3	Open draft shield up to position saved
w4	Open draft shield 100° towards the right (stored position is deleted)

Format 3
 (not allowed in the Setup menu
 For example: ESC z5 1234567_)

!#	Meaning
z5	Input (GLP) balance ID no.
z6	Input weight set "inventory" no.
z7	Print weighing series no.

Format 4

!	Meaning
t	Text input in display

Format 5

(only for ME5, SE2: for example:
 ESC t120 _ f5_)
 ESC txxx _ CR LF ESC f5 _ CR LF:
 Save left-opening position xxx in degrees
 ESC txxx _ CR LF ESC f6 _ CR LF:
 Save right-opening position xxx in degrees

* counted from right to left

Synchronization

During data communication between the balance and an on-line device (computer), messages consisting of ASCII characters are transmitted via the interface. For error-free data communication, the parameters for baud rate, parity, handshake mode and character format must be the same for both units.

You can set these parameters in the Setup menu so that they match those of the on-line device. You can also define parameters in the balance to make data output dependent on various conditions. The conditions that can be configured are described under each of the application program descriptions.

If you do not plug a peripheral device into the balance interface port, this will not generate an error message.

Handshake

The balance interface (Sartorius Balance Interface = SBI) has transmit and receive buffers. You can define the handshake parameter in the Setup menu:

- Hardware handshake (CTS/DTR)
- Software handshake (XON, XOFF)

Hardware Handshake

With a 4-wire interface, 1 more character can be transmitted after CTS (Clear to Send).

Software Handshake

The software handshake is controlled via XON and XOFF. When a device is switched on, XON must be transmitted to enable any connected device to communicate.

When the software handshake is configured in the Setup menu, the hardware handshake becomes active after the software handshake.

The data transmission sequence is as follows:

Balance

--- byte --->

Computer

(transmitting

--- byte --->

(receiving

device)

--- byte --->

device)

--- byte --->

<--- XOFF ---

--- byte --->

--- byte --->

...

(Pause)

...

<--- XON ---

--- byte --->

--- byte --->

--- byte --->

--- byte --->

Transmitting Device:

Once XOFF has been received, it prevents further transmission of characters. When XON is received, it re-enables the transmitting device to send data.

Receiving Device:

XOFF is transmitted after the 26th character has been stored. To prevent too many control commands from being received at one time, XON is not transmitted until the buffer is almost empty.

Activating Data Output

You can define the data output parameter so that output is activated either when a print command is received or automatically and synchronously with the balance display or at defined intervals (see application program descriptions and auto print setting).

Data Output by Print Command

The print command can be transmitted by pressing  or by a software command (Esc P).

Automatic Data Output

In the "auto print" operating mode, data is output to the interface port without an extra print command. You can choose to have data output automatically at defined print intervals with or without the stability parameter. Whichever parameter you select, the data will be output as the readouts appear on the balance display. The display update frequency depends on both the model of the balance and the current operating status.

If you select the auto print setting, data will be transmitted immediately the moment you turn on the balance. In the Setup menu, you can configure whether this automatic output can be stopped and started by pressing .

Pin Assignment Charts

Female Interface Connector:

25-position D-Submini, DB25S, with screw lock hardware for cable gland

Male Connector Used (please use connectors with the same specifications):

25-pin D-Submini, DB25S, with integrated shielded cable clamp assembly (Amp type 826 985-1C) and fastening screws (Amp type 164 868-1)

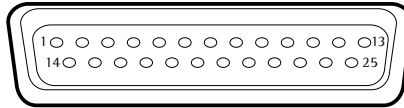

Pin Assignment Chart, 25-contact Female Connector, RS-232:

Pin 1:	Signal Ground
Pin 2:	Data Output (TxD)
Pin 3:	Data Input (RxD)
Pin 4:	Signal Ground
Pin 5:	Clear to Send (CTS)
Pin 6:	Internally Connected
Pin 7:	Internal Ground (GND)
Pin 8:	Internal Ground (GND)
Pin 9:	Reset _ In
Pin 10:	- 12 V Output
Pin 11:	+ 12 V Output
Pin 12:	Reset _ Out ²⁾
Pin 13:	+ 5 V Output
Pin 14:	Internal Ground (GND)
Pin 15:	
Pin 16:	
Pin 17:	
Pin 18:	
Pin 19:	
Pin 20:	Data Terminal Ready (DTR)
Pin 21:	Supply Voltage Ground (GND)
Pin 22:	Not Connected
Pin 23:	Not Connected
Pin 24:	Supply Voltage Input + 15 ... 25 V
Pin 25:	+5 V Output

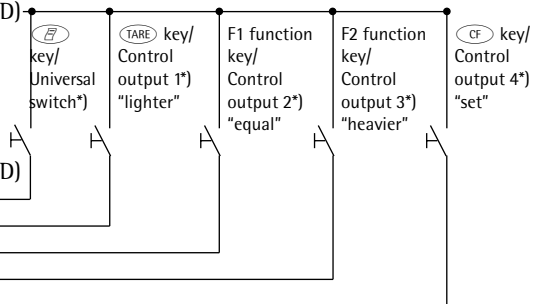

*) = See "Additional Functions" for information on changing pin assignments
 1) = Hardware restart
 2) = Restart peripheral device

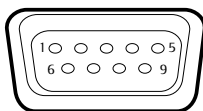

Pin Assignment Chart, 9-contact Female Connector, RS-232 (Optional):

Pin 1:	Not Connected
Pin 2:	Data Output (TxD)
Pin 3:	Data Input (RxD)
Pin 4:	Clear to Send (CTS)
Pin 5:	Signal GND
Pin 6:	Not Connected
Pin 7:	Not Connected
Pin 8:	Data Terminal Ready (DTR)
Pin 9:	Not Connected

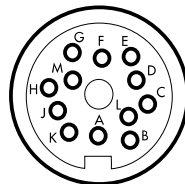

Pin Assignment Chart, 12-contact Round Female Connector, RS-485 (Optional):

Pin A:	F2 Function Key / Control Output 3 "Heavier"
Pin B:	RS-485: RxD - TxD - N; RS-232: TxD
Pin C:	RS-485: RxD - TxD - P; RS-232: RxD
Pin D:	RS-485: Not Connected; RS-232: DTR
Pin E:	Signal GND
Pin F:	+ 5 V
Pin G:	Left Draft Shield Key / Control Output 1 "Lighter"
Pin H:	RS-485: Not Connected; RS-232: CTS
Pin J:	Cal Function Key / Control Output 2 "Equal"
Pin K:	Key / Universal Switch
Pin L:	Key / Control Output 4 "Set"
Pin M:	+12 V Output

Connecting a Bar Code Scanner or an Extra Keyboard

You can connect a bar code scanner or an extra keyboard using the following female connectors:

- 25-contact D-Submini female connector (using an adapter)
- 12-contact round female connector (using an adapter)
- 5-contact direct DIN female connector

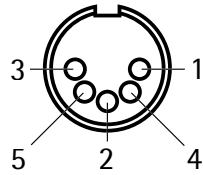

Pin Assignment for the 5-Contact DIN Female Connector:

- Pin1: Keyboard Clock
- Pin2: Keyboard Data
- Pin3: Not Connected
- Pin4: Signal GND
- Pin5: +5 V

△ The YRB02FC bar code scanner requires an external power source if you have connected a printer and a second display to the balance. The PC keyboard also requires an external source of power.

Cabling Diagram

Diagram for interfacing a computer or different peripheral device to the balance using the RS-232/V24 standard and cables up to 15 m (~50 ft.) long

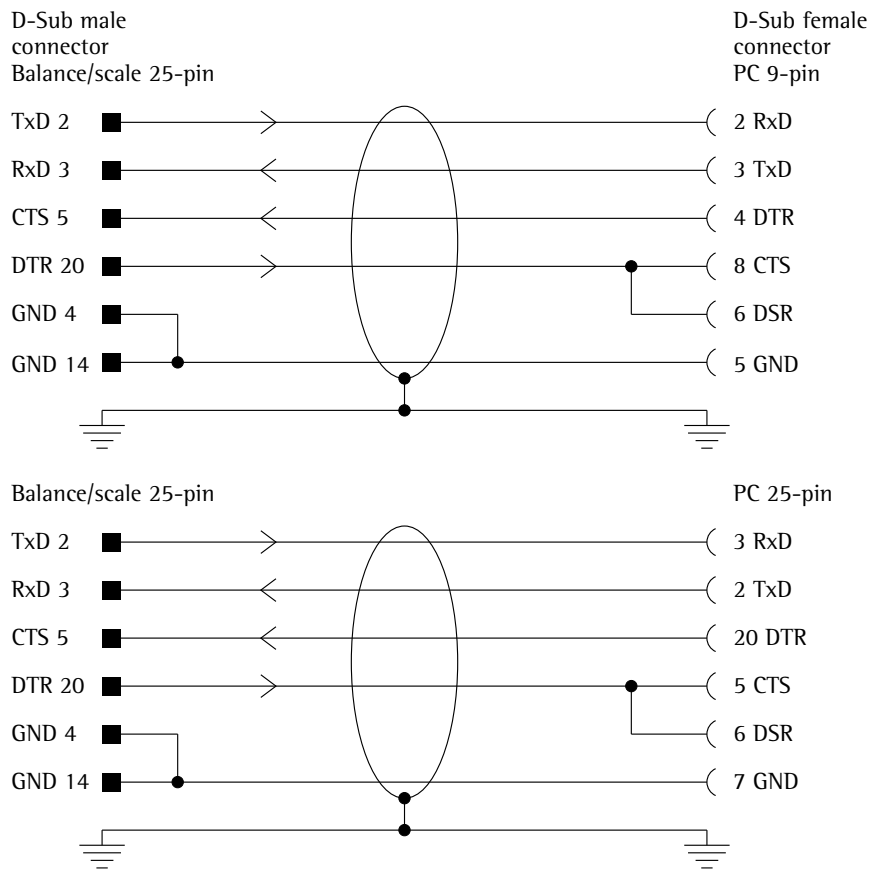

No other pins may be assigned in the balance.



Type of cable: AWG 24 specification

Error Codes and Messages

Error codes are displayed in the main display or text line for 2 seconds. The program then returns automatically to the previous status.

Error Code/Message Displayed	Cause	Solution
No segments appear on the display	No AC power is available The AC adapter is not plugged in Automatic shutoff configured in Setup	Check the AC power supply Plug in the AC adapter Press  to switch on the balance or select "automatic shutoff – off" in the Setup menu
H	The load exceeds the balance capacity	Unload the balance
L or Err 54	The weighing pan is not in place	Place the weighing pan on the balance
Err 01 > Display range	Data output not compatible with output format	Change the configuration in
Err 02 Cal. n. possible	Calibration/adjustment condition not met, e.g., – The balance was not tared – The balance is loaded	Calibrate only when zero is displayed Press  to tare Unload the balance
Err 03 Cal./adj. interrupt	Calibration/adjustment could not be completed within a certain time	Allow the balance to warm up again and repeat the adjustment process
Err 06 Int. wt. defective	Built-in calibration weight is defective	Contact your local Sartorius Service Center
Err 07 Function blocked	Function not allowed in balances verified for use in legal metrology	Contact your local Sartorius Service Center for information on having the settings changed
Err 08* <>zero range	The load on the balance is too heavy to zero the readout	Check whether "tare/zero with power on" is set If you are using the extra function to change the resolution, unload the balance
Err 09* < 0 not allowed	Taring is not possible when the gross weight is \leq zero	Zero the balance
Err 10 Tare fct. blocked	Tare key and 2nd tare memory are blocked when there is data in the tare memory for the formulation application Differential weighing: The tare key is blocked when a tare weight is stored for a specific sample	Press  to clear the formulation application; the tare key and 2nd tare memory are then accessible Differential weighing: Unload the balance or change to a different sample
Err 11 Tare2 blocked	Tare memory not allowed – Cannot load the sample tare weight – Total weight in the tare memory exceeds the capacity of the balance – Tare value exceeds the fine range of the verified balance	Check the tare value entered
Err 12 Tare2 > Max.	Tare memory greater than weighing capacity or range limits	Unload balance or use a different sample amount
Err 17 Adj.-wt. > Max.	Internal adjustment is not possible because preload is too heavy	Reduce the preload or change the configuration
Err 30 Print fct. blocked	Interface port for printer output is blocked	Contact your local Sartorius Service Center
Err 31 Print fct. blocked	Interface handshake interrupted (XOFF, CTS)	Transmit XON, then CTS

* = occurs only when the SBI interface (ESC f3_/f4_) is used

Error Code/Message Displayed	Cause	Solution
Ref.wt. too light	Error in storing reference weight (with the counting or weighing-in-percent application)	Weight too light or there is no sample on the balance
Cannot update	Reference updating not possible (with the counting application)	See "Counting" in "Operating the Balance" for reference updating criteria
Not a number xxxxx Too low xxxxx Too high	Input wrong (with any application program), e.g., alphabetic input not allowed	Follow the instructions for the application programs
Too many char.	Input text too long	Allowable text lengths, incl. decimal point: – S ID, NUM, L ID, ID: max. 20 characters – W ID: max. 14 characters
Wrong line format	Configured printout, printout memory and 16-character format selected	Select the 22-character format
Limits unequal for unit	Unit entered for tolerance limits in checkweighing different from the application used	Adjust tolerance limits
Equation too long	Equation exceeds 28 characters in formulation	Limit equation to 28 characters
Cancel, enter ref. parameters	No reference parameters entered for air density determination	Enter missing reference parameters
Function active	Function is being performed	–
Fewer than 999 samples can be saved in up to 100 lots	Product memory is full	Delete some of the data in the product memory
Err 10x	Key is stuck Key pressed when switching on the balance: 	Release key or contact your local Sartorius Service Center
"Checkerboard" pattern displayed continuously	Setup key was pressed when turning on the balance, or is stuck	
Err 320	Operating program memory defective	Contact your local Sartorius Service Center
Err 340	Operating parameter (EEPROM) is wrong RAM lost data Factory settings deleted	Turn the balance off, then back on again. If this error remains displayed, please contact your local Sartorius Service Center
Err 341	Battery needs to be recharged	Leave the balance power on for at least 10 hours
No WP	Weighing cell is defective	Contact your local Sartorius Service Center
blocked	Function blocked	None
The special code  remains displayed	None of the keys has been pressed since the balance was turned on	Press a key
The weight readout changes constantly	Unstable ambient conditions Too much vibration, or the balance is exposed to a draft A foreign object is caught between the pan and the balance housing	Set up the balance in another area Change Setup configurations to adapt the balance to the ambient conditions Remove the foreign object
The weight readout is obviously wrong	The balance has not been calibrated/adjusted The balance was not tared before weighing The balance is not level	Calibrate/adjust the balance Tare before weighing Level the balance

If any other errors occur, contact your local Sartorius Service Center!

Error Messages Displayed during Differential Weighing	Cause	Solution/Remarks
SAMPLE: Confirm delete/omit	"SAMPLE: delete/omit" prompt on display page for samples	Select Yes to delete Select Omit to omit
SAMPLE: Include	"SAMPLE: include" prompt on display page for samples	Select Omit to include a sample already omitted
Cannot store	File manager: – Not possible to save data – No available memory	Delete lot(s)
Cannot load	File manager: – Not possible to load data – Memory capacity limit reached	Delete lot(s)
Only 30 backweighs possible	An attempt was made to save a 31st backweighing operation	None
LOT: already exists	Lot already exists on the display page for LOTS	Choose a different lot ID
No sample	The Sample key was pressed when the display page for lots was shown, but there are no samples in the lot selected	Save sample first
Out of range	On the display page for LOTS or SAMPLES , an alphanumeric lot or sample ID was input and not found	Enter the correct lot or sample ID
Not enough memory space or 999 samples maximum	An attempt was made to save more than 999 samples using the numeric keys and the #S#1 key	Use less memory or delete one or more lots
Sample omitted	An attempt was made to save data from an omitted sample	None
Value too small to accept	An attempt was made to save a tare, initial or backweight that is less than one display digit	Place the particular weight on the balance
No choice available	Factor was selected while attempting to activate the display page for results No 2 nd resolution available	Selection not possible Contact your local Sartorius Service Center
CF not possible	Only one sample or certain portions of a sample can be deleted by pressing the CF key. This message indicates that further delete functions are not possible.	Samples can be deleted one at a time on the display page for samples
Calculated statistics	Message output when statistics are being calculated. This process can take several seconds if there are many samples.	Goes out automatically
No statistics available	No valid backweights available in this lot	Goes out automatically
No net initial wts. available	In serial and combined weighing, no initial weights found	Measure initial weights

Care and Maintenance

Service

Regular servicing by a Sartorius technician will extend the service life of your balance and ensure its continued weighing accuracy. Sartorius can offer you service contracts, with your choice of regular maintenance intervals ranging from 1 month to 2 years.

The frequency of maintenance intervals depends on the operating conditions and your tolerance requirements.

Repairs

Repair work must be performed by trained service technicians. Any attempt by untrained persons to perform repairs may lead to hazards for the user.

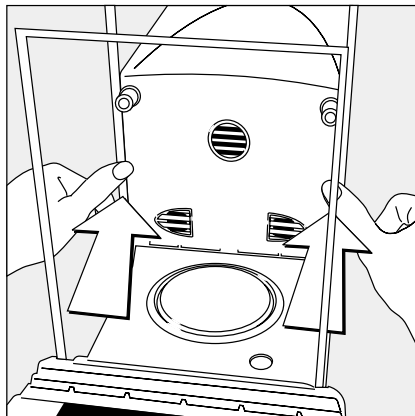

Cleaning the Weighing Chamber on ME215/235/254/414/614

- Slide the draft shield doors back as far as they will go

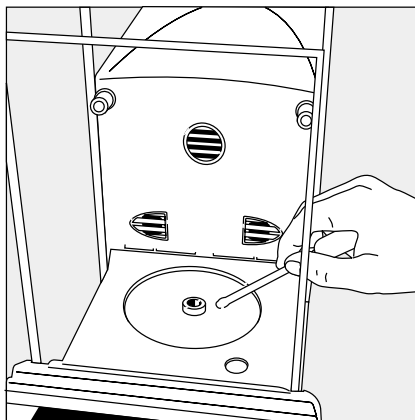

- Carefully remove spilled powder from the weighing chamber using a small car vacuum cleaner with a mini-hose attached
- To remove liquid spills, use blotting paper

⚠ Warning!

Particles drawn in by the fan can build up inside the balance housing. If you are using this balance in the chemical industry, be sure to handle or treat defective parts of the balance or those to be cleaned according to your country's current rules and regulations.

Cleaning

- ⚠ Make sure that no dust or liquid enters the balance housing

- ⚠ Do not use any aggressive cleaning agents (solvents or similar agents)

- Unplug the AC adapter from the wall outlet (mains supply)
- If you have a data cable connected to the interface, unplug it from the balance
- Carefully remove any sample residue/spilled powder using a brush or a hand-held vacuum cleaner
- Clean the balance using a piece of cloth which has been wet with a mild detergent
- Use a commercially available glass cleaning agent to clean the draft shield doors
- After cleaning, wipe down the balance with a soft, dry cloth

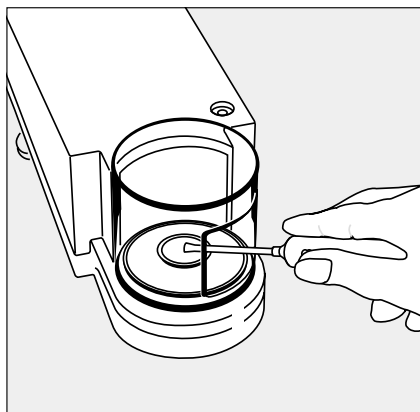

Cleaning the Weighing Chamber on ME5 | SE2

- Use a small hand-held car vacuum cleaner with a mini-hose attached to carefully remove spilled powder beneath the shield disk
- Use blotting paper to remove spilled liquid

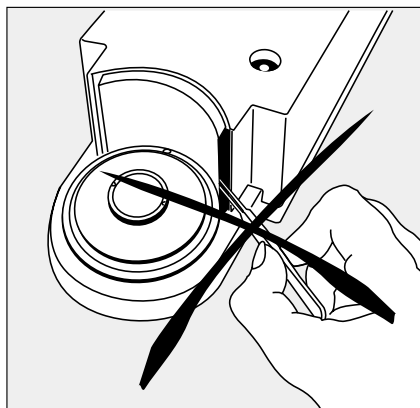

- ⚠ Do not use forceps or similar utensils behind the platen of the draft shield.

Important note: the weighing system is hermetically separated from the area of the draft shield platen that prevents spillage or other impurities from entering the system.

Safety Inspection

If there is any indication that safe operation of the balance with the AC adapter is no longer warranted:

- Turn off the power and disconnect the power cord from an electrical outlet (mains supply) immediately
- > Lock the AC adapter and power cord in a secure place to ensure that the equipment cannot be used during this time

Safe operation of the balance with the AC adapter is no longer ensured when:

- there is visible damage to the AC adapter or power cord
- the AC adapter no longer functions properly
- the AC adapter has been stored for a relatively long period under unfavorable conditions

In any of these cases, notify your nearest Sartorius Service Center or the International Technical Support Unit based in Goettingen, Germany.

Maintenance and repair work may only be performed by service technicians who are authorized by Sartorius and who

- have access to the required maintenance manuals
- have attended the relevant service training courses

We recommend that the balance together with the AC adapter be inspected by a qualified Sartorius service technician according to the following checklist:

- Leakage current <0.05 mA measured by a properly calibrated multimeter
- Insulation resistance >7 megaohms measured with a constant voltage of at least 500 V at a 500 kohm load

The duration and number of measurements should be determined by a qualified Sartorius service technician according to the particular ambient and operational conditions for the AC adapter. Such inspection should be performed at least once a year.

To ensure safe shipment, your balance has been packaged to the extent necessary using environmentally friendly materials. After successful installation of the balance, you should return this packaging for recycling because it is a valuable source of secondary raw material.

For information on recycling, including recycling old weighing equipment, contact your communal or municipal waste disposal center or local recycling depot.

Specifications

Standard Models

Model		ME235S	ME215S	ME235P	ME215P
Readability	mg	0.01	0.01	0.01/0.02/0.05	0.01/0.02/0.05
Weighing capacity	g	60/230	60/210	60/110/230	60/110/210
Tare range (subtractive)	g	-230	-210	-230	-210
Repeatability	≤±mg	0.015/0.025	0.015/0.025	0.015/0.04/ 0.04	0.015/0.04/ 0.04
Linearity	≤±mg	0.1	0.1	0.15	0.15
Off-center loading error at one-half max. cap. (positions acc. to OIML R76)	mg	0.15	-	0.2	-
Sensitivity drift within +10 to +30 °C (50 to 86 °F)	≤±/K	1·10 ⁻⁶	1·10 ⁻⁶	1·10 ⁻⁶	1·10 ⁻⁶
Response time (average)	s	≤ 8	≤ 8	≤ 8	≤ 8
External calibration weight (of at least accuracy class...)	g	200 (E2)	200 (E2)	200 (E2)	200 (E2)
Allowable ambient operating temperature		+5 to +40 °C (41 to 104 °F)			
Operating temperature range		+10 to +30 °C (50 to 86 °F)			
Adaptation to ambient conditions		By selection of 1 of 4 optimized filter levels			
Display update rate (depends on filter level)		0.2 – 0.4			
Pan size	mm	∅ 90			
Balance dimensions (W x D x H)	mm	252 x 533 x 292			
Weighing chamber height	mm	239			
Net weight, approx.	kg	11.1			
Dust and water protection rating of the balance housing according to EN 60529		IP32			
Power connection		Using wide-range AC adapter for voltage ratings of 100 V to 240 V			
Nominal frequency		50 – 60 Hz			
Power consumption		max. 35 VA			
Hours of operation with fully charged YRB05Z external battery pack, approx.		10 h			
DC nominal supply voltage		10.5 to 25 Vdc			
Selectable weight units		Grams, kilograms, carats, pounds, ounces, Troy ounces, Hong Kong taels, Singapore taels, Taiwanese taels, grains, pennyweights, milligrams, parts per pound, Chinese taels, momme, Austrian carats, tola, baht, mesghal			
Selectable application programs		Toggle weight units, counting, weighing in percent, animal weighing, recalculation, calculation, density determination, differential weighing, air buoyancy correction, air density determination, checkweighing, time-controlled functions, totalizing, formulation, statistics, 2nd tare memory, identification codes, product data memory			

Specifications

Standard Models

Model		ME614S	ME414S	ME254S
Readability	mg	0.1	0.1	0.1
Weighing capacity	g	610	410	250
Tare range (subtractive)	g	-610	-410	-250
Repeatability	≤±mg	0.1	0.1	0.07
Linearity	≤±mg	0.4	0.3	0.15
Off-center loading error at one-half max. cap. (positions acc. to OIML R76)	mg	0.6	0.4	0.3
Sensitivity drift within +10 to +30 °C (50 to 86 °F)	≤±/K	1·10 ⁻⁶		
Response time (average)	s	≤ 3	≤ 2.5	≤ 2.5
External calibration weight (of at least accuracy class...)	g	500 (E2)	2× 200 (E2)	200 (E2)
Allowable ambient operating temperature		+5 ... +40 °C		
Operating temperature range		+10 ... +30 °C		
Adaptation to ambient conditions		By selection of 1 of 4 optimized filter levels		
Display update rate (depends on filter level)		0.2 – 0.4		
Pan size	mm	Ø 90		
Balance dimensions (W × D × H)	mm	252 × 533 × 292		
Weighing chamber height	mm	239		
Net weight, approx.	kg	11.1		
Dust and water protection rating of the balance housing according to EN 60529		IP32		
Power connection		Using wide-range AC adapter for voltage ratings of 100 V to 240 V		
Nominal frequency		50 – 60 Hz		
Power consumption		max. 35 VA		
DC nominal supply voltage		10.5 to 25 Vdc		
Hours of operation with fully charged YRB05Z external battery pack, approx.		10 h		
Selectable weight units		Grams, kilograms, carats, pounds, ounces, Troy ounces, Hong Kong taels, Singapore taels, Taiwanese taels, grains, pennyweights, milligrams, parts per pound, Chinese taels, momme, Austrian carats, tola, baht, mesghal		
Selectable application programs		Toggle weight units, counting, weighing in percent, animal weighing, recalculation, calculation, density determination, differential weighing, air buoyancy correction, air density determination, checkweighing, time-controlled functions, totalizing, formulation, statistics, 2nd tare memory, identification codes, product data memory		

Specifications

Standard Models

Model		ME5	SE2	ME5-F	SE2-F
Readability	µg	1	0.1	1	0.1
Weighing capacity	g	5.1	2.1	5.1	2.1
Tare range (subtractive)	g	5.1	2.1	5.1	2.1
Repeatability	≤±µg	1	0.25	1 ¹⁾	0.25 ²⁾
Linearity	≤±µg	4	0.9	4 ¹⁾	0.9 ²⁾
Sensitivity drift within +10 to +30 °C (50 to 86 °F)	≤±/K	1 · 10 ⁻⁶	1 · 10 ⁻⁶	1 · 10 ⁻⁶	1 · 10 ⁻⁶
Response time (average)	s	≤ 10	≤ 10	≤ 10 ¹⁾	≤ 10 ²⁾
External calibration weight (of at least accuracy class...)	g	5 (E2)	2 (E2)	5 (E2)	2 (E2)
Allowable ambient operating temperature		+5 ... +40 °C			
Operating temperature range		+10 ... +30 °C			
Adaptation to ambient conditions		By selection of 1 of 4 optimized filter levels			
Display update rate (depends on filter level)		0.1 – 0.4	0.2 – 0.4	0.1 – 0.4	0.2 – 0.4
Pan size	mm	Ø 30	Ø 20	Ø 50	Ø 50
Balance dimensions (W × D × H)					
– Weigh cell	mm	122 × 316 × 122			
– Display and control unit		254 × 320 × 106			
Weighing chamber height					
– Weigh cell	kg	3.3	3.3	4.3	4.3
– Display and control unit		3.5	3.5	3.5	3.5
Dust and water protection rating of the balance housing according to EN 60529		IP32			
Power connection (AC adapter)		Using wide-range AC adapter for voltage ratings of 100 V to 240 V			
Nominal frequency		50 – 60 Hz			
Power consumption		max. 23 VA			
Power consumption, weigh cell and display and control unit only		approx. 7 W (typical)			
Hours of operation with fully charged YRB05Z external battery pack, approx.		10 h			
DC nominal supply voltage		10.5 to 25 Vdc			
Selectable weight units		Grams, kilograms, carats, pounds, ounces, Troy ounces, Hong Kong taels, Singapore taels, Taiwanese taels, grains, pennyweights, milligrams, parts per pound, Chinese taels, momme, Austrian carats, tola, baht, mesghal			
Selectable application programs		Toggle weight units, counting, weighing in percent, animal weighing, recalculation, calculation, density determination, differential weighing, air buoyancy correction, air density determination, checkweighing, time-controlled functions, totalizing, formulation, statistics, 2nd tare memory, identification codes, product data memory			

¹⁾ with standard weighing pan: Ø 30 mm

²⁾ with standard weighing pan: Ø 20 mm

Specifications

Verified Models with EC Type Approval

Model		ME235S-OCE	ME215S-OCE	ME235P-OCE	ME215P-OCE
Type		BE BK	BE BK	BE BK	BE BK
Accuracy class*		I	I	I	I
Scale interval d*	mg	0.01	0.01	0.01/0.02/0.05	0.01/0.02/0.05
Max. weighing capacity*	g	230	210	60/110/230	60/110/210
Verification scale interval e*	mg	1	1	1	1
Min. capacity*	mg	1	1	1	1
Tare range (subtractive)		≤100% of the max. weighing capacity			
Application range*	g	0.001-230	0.001-210	0.001-230	0.001-210
Response time (average)	s	≤ 8	≤ 8	≤ 8	≤ 8
Allowable operating temperature range		273 ... 313 K (0 ... +40°C, 32°F ... 104°F) with "isoCAL" function			
Adaptation to ambient conditions		By selection of 1 of 4 optimized filter levels			
Display update rate (depends on filter level)		0.2 – 0.4			
Pan size	mm	Ø 90			
Balance dimensions (W × D × H)	mm	252 × 533 × 292			
Weighing chamber height	mm	239			
Net weight, approx.	kg	11.1			
Dust and water protection rating of the balance housing according to EN 60529		IP32			
Power connection		Using wide-range AC adapter for voltage ratings of 100 V to 240 V			
Nominal frequency		50 – 60 Hz			
Power consumption		max. 35 VA			
Hours of operation with fully charged YRB05Z external battery pack, approx.		10 h			
DC nominal supply voltage		10.5 to 25 Vdc			
Selectable weight units		Grams, carats and milligrams			
Selectable application programs		Toggle weight units, counting, weighing in percent, animal weighing, recalculation, calculation, density determination, differential weighing, air buoyancy correction, air density determination, checkweighing, time-controlled functions, totalizing, formulation, statistics, 2nd tare memory, identification codes, product data memory			

* = according to Council Directive 90/384/EEC on non-automatic weighing instruments used within the European Economic Area

Specifications

Verified Models with EC Type Approval

Model	ME614S-OCE	ME414S-OCE	ME254S-OCE
Type	BE BK	BE BK	BE BK
Accuracy class*	I	I	I
Scale interval d*	μg 0.1	0.1	0.1
Max. weighing capacity*	g 610	410	250
Verification scale interval e*	mg 1	1	1
Min. capacity*	mg 10	10	10
Tare range (subtractive)	$\leq 100\%$ of the max. weighing capacity		
Application range*	mg 0.01-610	0.01-410	0.01-250
Response time (average)	s ≤ 2.5	≤ 2.5	≤ 2.5
Allowable operating temperature range	283 ... 303 K (+10 ... +30°C)	273 ... 313 K (0 ... +40°C) with "isoCAL" function	
Adaptation to ambient conditions	By selection of 1 of 4 optimized filter levels		
Display update rate (depends on filter level)	0.2 - 0.4		
Pan size	mm $\varnothing 90$		
Balance dimensions (W x D x H)	mm 252 x 533 x 292		
Weighing chamber height	mm 239		
Net weight, approx.	kg 11.1		
Dust and water protection rating of the balance housing according to EN 60529	IP32		
Power connection	Using wide-range AC adapter for voltage ratings of 100 V to 240 V		
Nominal frequency	50 - 60 Hz		
Power consumption	max. 35 VA		
Hours of operation with fully charged YRB05Z external battery pack, approx.	10 h		
Selectable weight units	Grams, carats and milligrams		
DC nominal supply voltage	10.5 to 25 Vdc		
Selectable application programs	Toggle weight units, counting, weighing in percent, animal weighing, recalculation, calculation, density determination, differential weighing, air buoyancy correction, air density determination, checkweighing, time-controlled functions, totalizing, formulation, statistics, 2nd tare memory, identification codes, product data memory		

* = according to Council Directive 90/384/EEC on non-automatic weighing instruments used within the European Economic Area

Specifications

Verified Models with EC Type Approval

Model		ME5-OCE	SE2-OCE
Type		KC BN 100	KC BN 100
Accuracy class*		Ⓡ	Ⓡ
Scale interval d*	µg	1	0.1
Max. weighing capacity*	g	5.1	2.1
Verification scale interval e*	mg	1	1
Min. capacity*	mg	0.1	0.01
Tare range (subtractive)		≤100% of the max. weighing capacity	
Application range*	mg	0.1-5100	0.01-2100
Response time (average)	s	≤10	
Allowable operating temperature range		273 ... 313 K (0 ... +40°C, 32°F ... 104°F) with "isoCAL" function	
Adaptation to ambient conditions		By selection of 1 of 4 optimized filter levels	
Display update rate (depends on filter level)		0.2 – 0.4	
Pan size	mm	∅ 30	∅ 20
Balance dimensions (W × D × H)			
– Weigh cell	mm	122 × 316 × 122	
– Display and control unit		254 × 320 × 106	
Weighing chamber height			
– Weigh cell	kg	3.3	
– Display and control unit		3.5	
Net weight, approx.	kg	11.1	
Dust and water protection rating of the balance housing according to EN 60529		IP32	
Power connection		Using wide-range AC adapter for voltage ratings of 100 V to 240 V	
Nominal frequency		50 – 60 Hz	
Power consumption (AC adapter)		max. 23 VA	
Power consumption, weigh cell and display and control unit only		approx. 7 W (typical)	
Hours of operation with fully charged YRB05Z external battery pack, approx.		10 h	
DC nominal supply voltage		10.5 to 25 Vdc	
Selectable weight units		Grams, carats and milligrams	
Selectable application programs		Toggle weight units, counting, weighing in percent, animal weighing, recalculation, calculation, density determination, differential weighing, air buoyancy correction, air density determination, checkweighing, time-controlled functions, totalizing, formulation, statistics, 2nd tare memory, identification codes, product data memory	

* = according to Council Directive 90/384/EEC on non-automatic weighing instruments used within the European Economic Area

Accessories (Options)

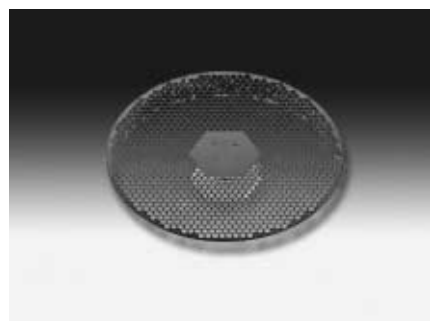

Product	Order No.
Glass plate support for conditioning samples inside the weighing chamber, for ME models (0.01 mg and 0.1 mg readability)	YGS01ME
Data printer verified for use in legal metrology; with date, time, statistics and transaction counter functions	YDP03-OCE
Paper rolls for YDP03-OCE; 5 units, each with 50 m	6906937
Ink ribbon cassette for YDP03-OCE	6906918
External rechargeable battery pack with battery level indicator	
• for SE2 and all ME models	YRB05Z
• for LA models	YRB06Z
SartoConnect data transfer software; with RS-232 standard cable (1.5 m); for direct input of weighing data into an application program (e.g., such as Excel)	YSC01L
Weight set for determination of the air density	
• for ME5	YSS35-00
• for ME235S, ME235P, ME414S, ME254S and ME614S	YSS45-00
Density determination kit for all ME models (0.01 mg and 0.1 mg readability)	YDK01
Pipette calibration set for all ME models (0.01 mg and 0.1 mg readability); hardware and software	YCP03-1
Pipette calibration software	YCP03-2
Foot switch 3 functions for all ME models and SE2	YPE01RC
Hand switch incl. T-connector	YHS02
T-connector for connecting two peripheral devices to the balance	YTC01
Balance table for precise, reliable weighing operations	YWT01
Stone table with damping device	YWT03
Wall console	YWT04
Remote display LCD; height of digits: 13 mm; reflective	YRD02Z
Carrying case for all ME models (0.01 mg and 0.1 mg readability)	YDB01ME
Antistatic weighing pan	
• for ME5	YWP01MC
• for all ME models (0.01 mg and 0.1 mg readability)	YWP01ME
Ionizing blower , 220 V for electrostatically charged samples 110 V	YIB01-ODR YIB01-OUR
Stat pen unit to neutralize static electricity on samples (100V to 230V, 50/60Hz)	YSTP01
Cable for connecting the weighing cell to a separate display and control unit (length, 2.70 m) , for all LA models	YCC01-19M3
Bar code scanner for SE2 and ME models (YCC01-0024M01 required)	YBR02FC
Cable for connecting the LA balance to the bar code scanner	YCC01-0024M01
Standard Operating Procedure	YSL01E
Cable for connecting the weighing cell to a separate display and control unit (length 2.70 m), for all ME models (0.01 mg and 0.1 mg readability)	YCC01-MED27
Data interface	
• PC-compatible (9-pin com port) incl. 5-pin connector for bar code scanner	YD001ME
• RS485 (12-pin com port, round) incl. 5-pin connector for bar code scanner	YD002ME
RS-232 Interface cable for connecting the balance to a PC with a 25-pin com port; length approx. 1.5 m	7357312
RS-232 Interface cable for connecting the balance to a PC with a 9-pin com port; length approx. 1.5 m	7357314
Weighing bowls and trays	
• Stainless steel, 20 g	6003
• Glass, 20 g	6015
• Stainless steel, 300 ml, with pouring spout	6407
Weighing scoops (pure aluminum)	
• 2.7 x 4 x 12 mm, approx. 4.5 mg (250 per box)	6565
• 6.5 x 7 x 25 mm, approx. 52 mg (200 per box)	6566

Dimensions (Scale Drawings)

ME215/235/254/414/614:

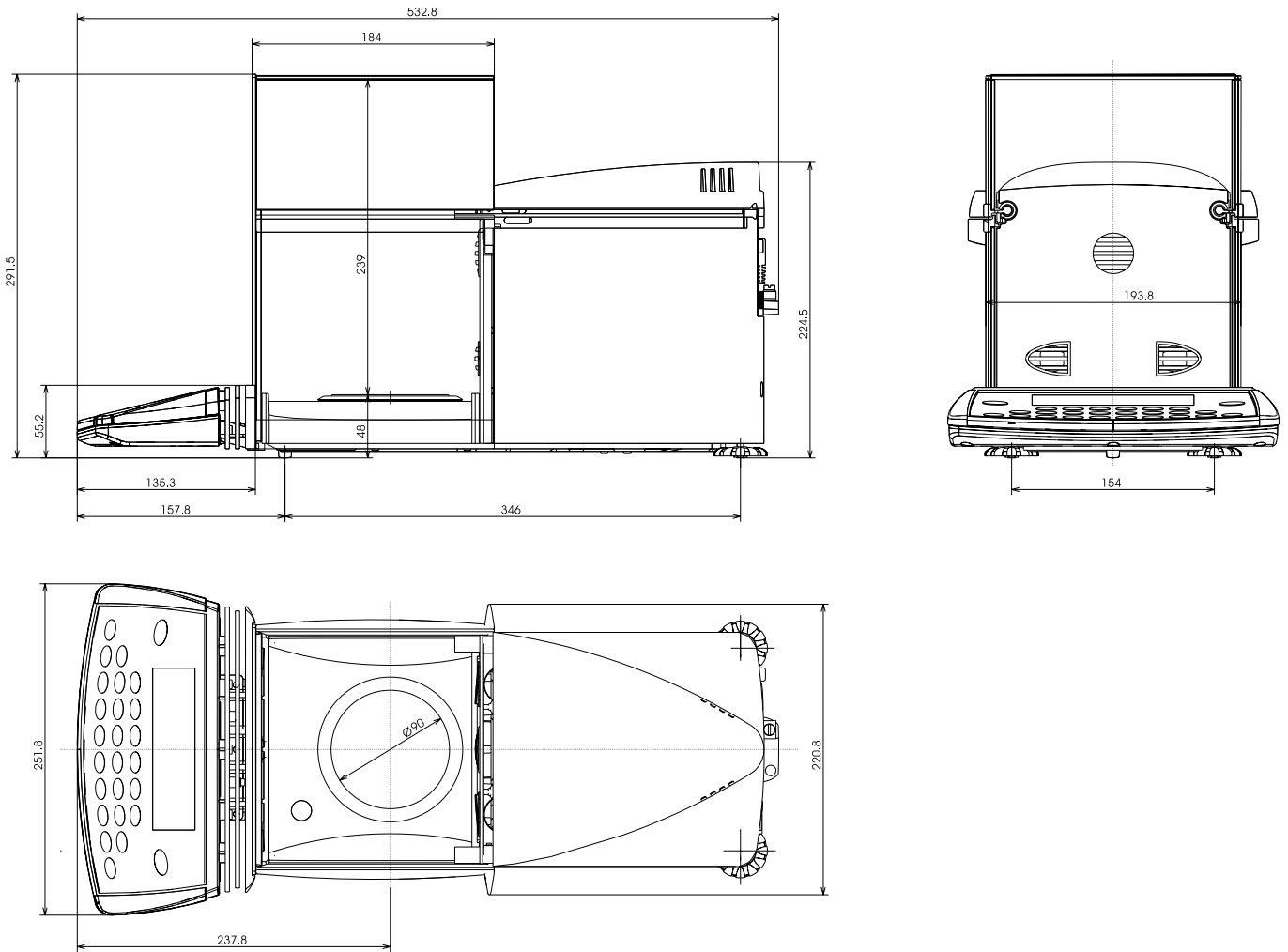

All dimensions given in millimeters.

Dimensions (Scale Drawings)

ME5, SE2:

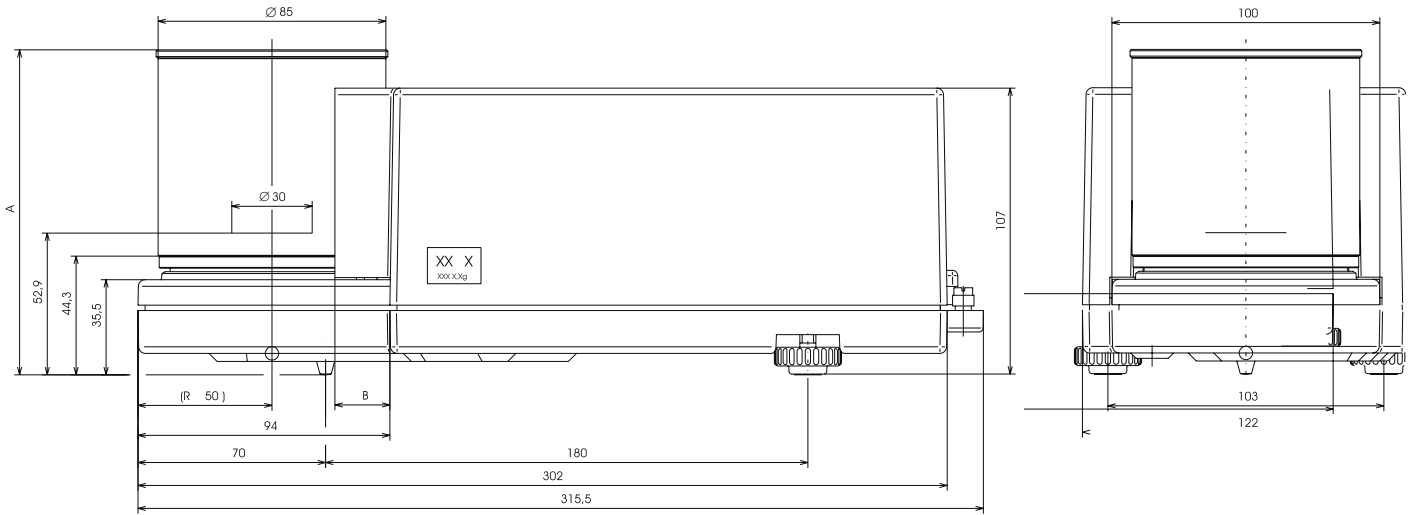

Model	A	B
ME5 / ME5-OCE	121.3	20.5
SE2 / SE2-OCE	121.3	20.5
ME5-F	88.3	----
SE2-F	----	88.3

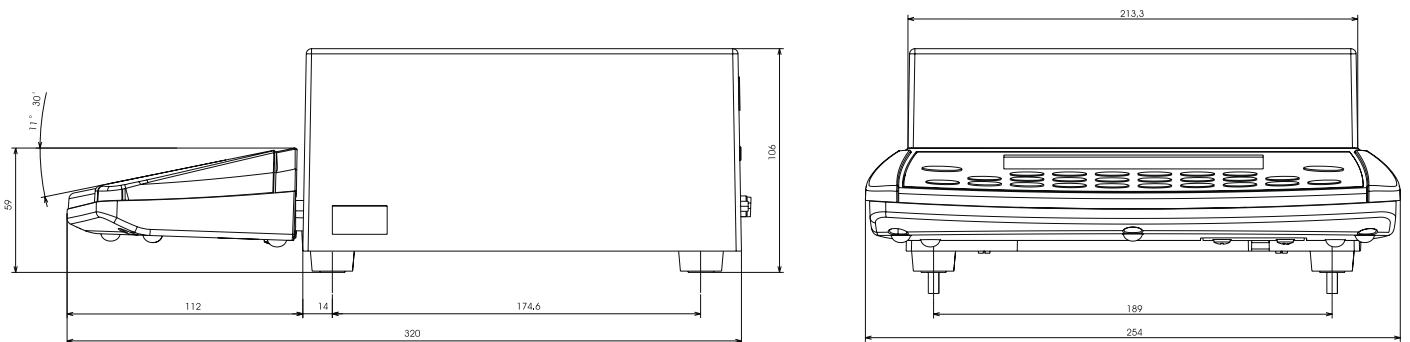

All dimensions given in millimeters.

Declarations of Conformity

Weighing Instruments for Use in Legal Metrology: Council Directive 90/384/EEC

"Non-automatic weighing instruments"

This Directive regulates the determination of mass in legal metrology.

For the respective Declaration of Type Conformity for weighing instruments that have been verified by Sartorius for use as legal measuring instruments and that have an EC Type-Approval Certificate, see the page after next.

This Directive also regulates the performance of the EC verification by the manufacturer, provided that an EC Type-Approval Certificate has been issued and the manufacturer has been accredited by an officer of a Notified Body registered at the Commission of the European Community for performing such verification.

Sartorius complies with EC Directive No. 90/384/EEC for non-automatic weighing instruments, which has been in effect since January 1, 1993, within the Single European Market, as well as the accreditation of the Quality Management System of Sartorius AG by Lower Saxony's Regional Administrative Department of Legal Metrology (Niedersächsisches Landesverwaltungsamt – Eichwesen) from February 15, 1993.

For additional information on the **CE** mark on Sartorius equipment, see Sartorius Publication No. W--0052-e93081.

"EC Verification" – A Service Offered by Sartorius

Our service technicians authorized to perform the verification* of your weighing instruments that are acceptable for legal metrological verification can inspect and verify the metrological specifications at the place of installation within the Member States of the European Union and the Signatories of the Agreement on the European Economic Area.

Subsequent Verifications within the European Countries

The validity of the verification will become void in accordance with the national regulations of the country in which the weighing instrument is used. For information on verification and legal regulations currently applicable in your country, and to obtain the names of the persons to contact, please contact your local Sartorius office, dealer or service center.

For more information on the verification of weighing instruments for use in legal metrology, contact the Sartorius Service Center.

* = in accordance with the accreditation certificate received by Sartorius AG



Declaration of Conformity to Council Directives 89/336/EEC and 73/23/EEC

The electronic precision weighing instrument of the series
ME/SE....-...

meets the requirements of the test standards listed below, in conjunction
with the associated power supplies, auxiliary peripheral devices and
installation equipment listed in Annex A2 (see Annex A1 for a technical
description and variants).

1. Electromagnetic Compatibility

1.1 Source for 89/336/EEC: EC Official Journal, No. 2002/C62/02

EN 61326-1 Electrical equipment for measurement, control and
laboratory use- EMC requirements
Part 1: General requirements

Limitation of emissions: Residential areas, Class B

Defined immunity to interference: Industrial areas, continuous unmonitored operation.

2. Safety of Electrical Equipment

2.1 Source for 73/23/EEC: EC Official Journal, No. 2001/C106/03

EN 61010 Safety requirements for electrical equipment for
measurement, control and laboratory use
Part 1: General requirements

EN 60950 Safety of information technology equipment

Sartorius AG
37070 Goettingen, Germany
2003

W. Obermann
(Senior Vice President, R&D
Electronic Engineering
Mechatronics Division)

Dr. K. Klein
(Senior Vice President, R&D
Mechanical Engineering
Mechatronics Division)

CE Declaration of Type Conformity to Directive No. 90/384/EEC

This declaration is valid for non-automatic electromechanical weighing instruments for use in legal metrology. These weighing instruments accepted for legal metrological verification have an EC Type-Approval Certificate. The model(s) concerned is(are) listed below along with the respective type, accuracy class, and number of the EC Type-Approval Certificate:

Model	Type	Accuracy Class	EC Type Approval No.	In Conjunction with Test Certificate	
				Type	Certificate No.
ME.....-0CE	iso-TEST	Ⓛ	D97-09-018	BE BK	D09-00.31
ME.....-0CE	iso-TEST	Ⓛ	D97-09-018	KC BN	D09-00.31
SE.....-0CE	iso-TEST	Ⓛ	D97-09-018	KC BN	D09-00.31

SARTORIUS AG declares that its weighing instrument types comply with the requirements of the Council Directive on non-automatic weighing instruments, no. 90/384/EEC of 20 June 1990; the associated European Standard "Metrological aspects of non-automatic weighing instruments," No. EN 45501; the amended, currently valid versions of the national laws and decrees concerning legal metrology and verification in the Member States of the European Union, the EU, and the Signatories of the Agreement on the European Economic Area, which have adopted this Council Directive into their national laws; and with the requirements stipulated on the Type-Approval Certificate for verification. This Declaration of Type Conformity is valid only if the ID label on the weighing instrument has the CE mark of conformity and the green metrology

sticker with the stamped letter "M" (the two-digit number in large print stands for the year in which the mark has been affixed):



If these marks are not on the ID label, this Declaration of Type Conformity is not valid. Validity can be obtained, for example, by submitting the weighing instrument for final action to be taken by an authorized representative of SARTORIUS AG. The period of validity of this Declaration of Type Conformity shall expire upon any tampering with, repair or modification of this weighing instrument or, in some Member States, on the date of expiration. The operator of this weighing instrument shall be responsible for obtaining an authorized renewal of the verification, such as subsequent or periodic verification, of the weighing instrument for use as a legal measuring instrument.

Sartorius AG
37070 Goettingen, Germany
Signed in Göttingen, 30.06.2003

Dr. G. Maaz
(President of the Mechatronics Division)

J. Rehwald
(Head of the Production Department
Mechatronics / Weighing Technology Division)

Physikalisch-Technische Bundesanstalt

Braunschweig und Berlin

PTB



EG-Bauartzulassung

EC type-approval certificate

Zulassungsinhaber: Sartorius AG
Issued to: Weender Landstraße 94-108
37075 Göttingen
Bundesrepublik Deutschland

Rechtsbezug: § 13 des Gesetzes über das Meß- und Eichwesen (*verification act*)
In accordance with: vom/dated 23. März 1992 (BGBl. I S. 711) in Verbindung mit Richtlinie
(*in connection with council directive*) 90/384/EWG, geändert durch (*amended by*) 93/68/EWG

Bauart: Nichtselbsttätige elektromechanische Waage
In respect of: *Nonautomatic electromechanical weighing instrument*
Typ/type: iso-TEST
Genauigkeitsklasse/class (I), (II), (III), (III) Max 0,05 kg ... 300 t
Option: Mehrteilungswaage, Mehrbereichswaage
Multi-interval instrument, multiple range instrument

Zulassungsnummer: **D97-09-018 4. Revision**
Approval number:

Gültig bis: 2007-06-26
Valid until:

Anzahl der Seiten: 13
Number of pages:

Geschäftszeichen: 1.14 – 02000518
Reference No.:

Benannte Stelle: 0102
Notified Body:

Im Auftrag
By order

Link



Braunschweig, 2002-03-26

Siegel
Seal

Physikalisch-Technische Bundesanstalt

Braunschweig und Berlin

**Prüfschein***Test certificate*

Ausgestellt für:

*Issued to:*Sartorius AG
Weender Landstraße 94 - 108
37075 Göttingen
Bundesrepublik Deutschland

Prüfgrundlage:

*In accordance with:*EN 45501 (1992), Nr. 8.1,
OIML R 76-1 (1992)

Gegenstand:

*Object:*Lastaufnehmer mit Wägezelle und Auswerteelektronik mit digitalem
Ausgang als Modul einer elektromechanischen Waage zum
Anschluss an geeignete Anzeige und Bedienterminals*Load receptor with load cell and electronic device with digital output as module of
an electromechanical weighing instrument for connection to suitable display- and
operator-terminals*

Typ / type: BE BK, KC BN

Kennnummer:

Serial number:

Prüfscheinnummer:

*Test certificate number:***D09-00.31 1. Revision / Revision 1**

Datum der Prüfung:

Date of Test:

Anzahl der Seiten:

Number of pages:

8

Geschäftszeichen:

Reference No.:

1.14 – 03000657

Benannte Stelle:

Notified Body:

0102

Im Auftrag

By order

Link



Braunschweig, 2003-06-23

Siegel

Seal

Plates and Markings

Type iso-TEST + BE BK

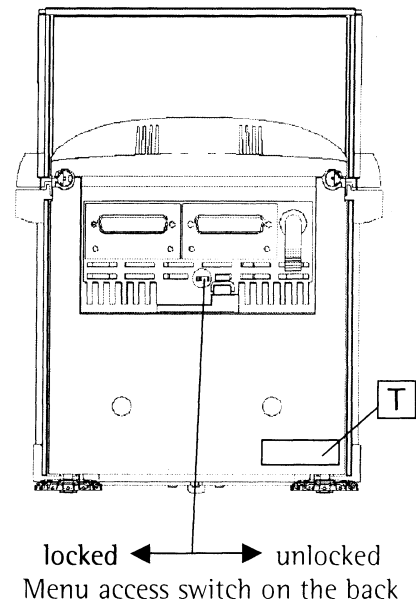
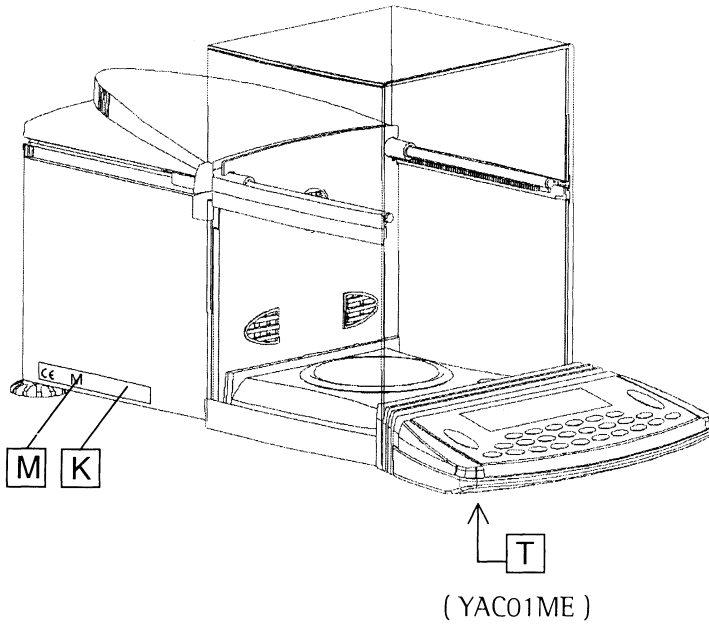

- K** Descriptive plate with CE marking
- M** Mark for EC verification (green metrology sticker)
- T** Plate with model designation

Example of descriptive plate on a weighing instrument already verified **K**
(weighing module+terminal)

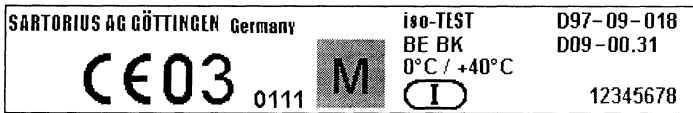

Examples of plates with model designation **T**

of the weighing module and of the indicating and operator terminal



Type iso-TEST + KC BN

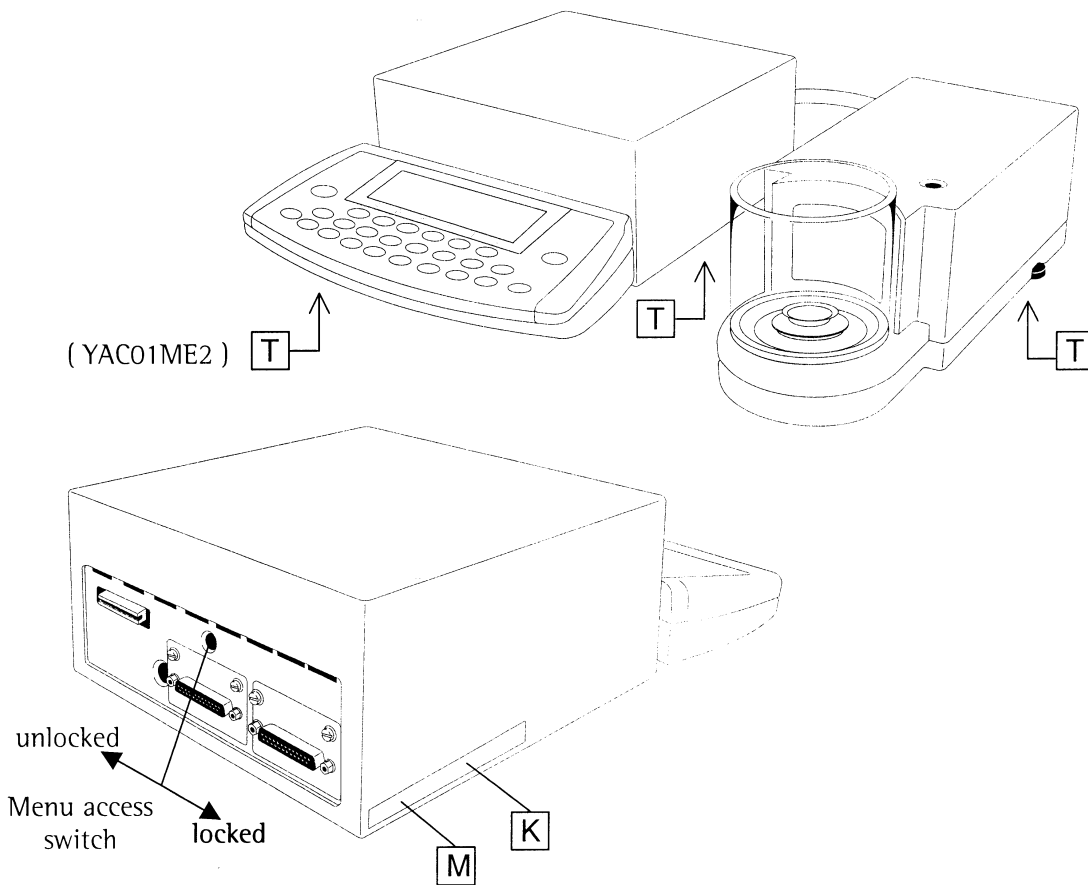

- K** Descriptive plate with CE marking
- M** Mark for EC verification (green metrology sticker)
- T** Plate with model designation

Example of descriptive plate on a weighing instrument already verified **K**
(weighing module+terminal)

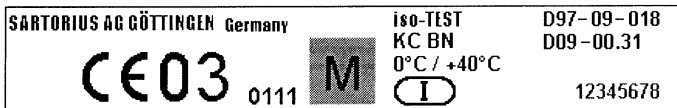

Examples of plates with model designation **T**

of the weighing module and of the indicating and operator terminal



PPME020703e

Type: iso-TEST + KC BN
EC type-approval certificate D97-09-018 and test certificate D09-00.31

Index

	Page		Page		Page
Accessories (options)	152	Data block printout of calibration/		Parameter settings	20
Acoustic signal	48	adjustment data	58	Password	23
Adapt filter (to ambient conditions)	21	Data input format	138	Password, entering or changing	23
Adjustment	49	Data output format	136	Pin assignment charts	139
Adjustment, automatic	57	Data output functions	125	Plates and markings	160
Adjustment, external	55	Date, entering the	19	Power-on mode	48
Adjustment, internal	54	Density determination	72	Printer interface, printer port	130
Air buoyancy correction	89	Density determination		Printout configuration	38
Air density determination	89, 93	with statistical evaluation	123	Printout, selecting the function	36
Analytical weighing	41	Device information	40	Product data memory	116
Animal weighing with statistics		Device parameters, setting the	23		
(averaging)	105	DKD Uncertainty of Measurement	120	Recycling	145
Antitheft locking device	16	Diameter determination	96	Reference sample updating	64
Application filter	21	Differential weighing	77	Repairs	144
Application parameters	28	Display accuracy	29, 61	Repeatability test (reproTEST)	59
Application parameters (overview)	29	Display and control unit,			
Application programs	60	remote operation	12	Safety inspection	145
Application symbols	126	Display	47	Safety precautions	15
Auto print	130	Display contrast	27	Sample ID	45
Auto zero	21	Draft shield, opening and		Saving values manually in M+	113
Automatic data output	138	closing	45	Second tare memory (preset tare)	107
Automatic shutoff, of the balance	48			Selecting the calibration/adjustment	
Auto-start app. when power		Entering the general password	Appendix	parameters	53
goes on	60	Equipment supplied	11	Serial communication	
		Error codes and messages	141	(PERIPHERALS)	24, 136
Balance, setting up the	12	External universal remote switch	27, 47	Serial communications port	134
Balance functions, setting the	20	Extra functions	48, 107	Serial printer (PRINTER)	26, 127
Bar code scanner	47, 138			Service	144
Bar graph	47	Factory setting(s) (menu)	21	Setup	17
Basic weighing function	41	Factory settings, restore	40	Software handshake	138
Below-balance weighing	42			Specifications	146
				SQmin function	118
€ mark	155	General password	Appendix	Stability range	21
Cabling diagram	140	General views of the balance	5	Static electricity eliminator	47
Calculation	69	Getting started	11	Statistics	102
Calibration	49			Storage and shipping conditions	11
Calibration, external	55	Handshake	139	Synchronization	138
Calibration, internal	54				
Calibration/adjustment printout		Individual identification codes	109	Tare/zero at power-on	22
(data block printout)	58	Installation instructions	12	Taring	21
Care and maintenance	144	Intended use	2	Technical advice on applications	2
CF function	27, 48	Interfaces	47, 127	Time, entering the	19
Cleaning	145	Ionizer	47	Time-controlled functions	99
Combining applications	122	ISO/GLP printout	134	Toggle between two weight units	61
Configuring the balance	17	isoCAL	57		
Connecting the balance				Unpacking the balance	11
to AC power	14	Keys	48	User ID	25
Contents	3	Keys, block key functions	27, 48		
Control ports (menu)	27	Keys, description, labeled	5		
Counting	63			Warmup time	15
		Language, setting the	17	Warning and safety instructions	4
		Leveling the balance	16	Warranty	11
		Line for metrological data	125	Weighing in percent	66
		Line format	35, 129	Weight ID	50
		Linearization	49, 54		
		Magnetic or magnetizable samples	41		
		Operating design	7		
		Operating the balance	41		
		Options	152		

Entering the General Password

Enter/Change Password

- Select the Setup menu:
Press the **Setup** key
- > **SETUP** is displayed
- Select the parameter:
Press the **↓** and **→** soft keys
- > The password prompt is displayed:

SETUP	PASSW. CHECK				
Enter password: ██████████					
<<	<				

- Enter the General Password (see below)
- Confirm the password:
Press the **↓** soft key
- > Parameters are displayed

- Select password setting:
Press the **↓** or **↑** soft keys repeatedly and **→**, until
- > **Password:** is displayed, together with the current password setting
- Define a new password:
Enter letters/numbers for the new password
- To delete the current password:
Press the **⊙** key and store
- To confirm your entry:
Press the **↓** soft key
- Exit the Setup menu:
Press the **<<** soft key
- > Restart your application

General Password:
40414243

Sartorius AG
Weender Landstrasse 94–108
37075 Goettingen, Germany

Phone +49.551.308.0
Fax +49.551.308.3289
www.sartorius.com

Copyright by Sartorius AG,
Goettingen, Germany.
All rights reserved. No part
of this publication may
be reprinted or translated in
any form or by any means
without the prior written
permission of Sartorius AG.
The status of the information,
specifications and illustrations
in this manual is indicated
by the date given below.
Sartorius AG reserves the
right to make changes to the
technology, features,
specifications and design of the
equipment without notice.

Status:
March 2005, Sartorius AG,
Goettingen, Germany