

# PC-1000/Laser 1000 User Manual



## Panoramic Corporation Dental Panoramic/Cephalometric X-ray Machine



Panoramic Corporation  
4321 goshen road, fort wayne, in 46818  
800.654.2027 260.489.2291 fax 260.489.5683  
www.pancorp.com

PMC6000 Rev D

© Copyright 2007 Panoramic Corporation

# Table of Contents

Table of Contents .....	2
Introduction .....	3-4
Purpose .....	3
Statement of Compatibility .....	3
Warning of Voltage Regulators .....	4
X-Ray Shielding Requirements .....	4
PC-1000 Components .....	5
PC-1000 Pre-Patient Setup .....	6-8
PC-1000 Patient Positioning .....	9-14
Prepare The Patient .....	9-10
Position The Patient .....	11-12
Set The kVp .....	12
Recheck Patient Positioning .....	12
Take The Exposure .....	13
Release The Patient .....	13
Reset The Machine .....	13-14
Process The Film .....	14
PC-1000 TMJ Pre-Patient Setup .....	15-17
PC-1000 TMJ Patient Positioning .....	18-25
Prepare The Patient .....	18-19
Position The Patient .....	20-21
Set The kVp .....	21
Recheck Patient Positioning .....	21
Take The Exposure .....	22-24
Release The Patient .....	25
Process The Film .....	25
Notes .....	26
Laser 1000 Components .....	27
Laser 1000 Pre-Patient Setup .....	28-32
Laser 1000 Patient Positioning .....	33-36
Cephalometric To Panoramic Setup .....	37-38
Panoramic Radiography .....	Appendix A
Darkroom Procedures .....	Appendix B
Manual Processing	
Automatic Processing	
Darkroom Light Leak Test	
Loading The Panoramic Cassette	
Loading The Cephalometric Cassette	
Maintenance Schedule .....	Appendix C
PC-1000/Laser 1000 Labeling .....	Appendix D
PC-1000/Laser 1000 Specifications .....	Appendix E
PC-1000/Laser 1000 Space Requirements .....	Appendix F



# Introduction

## **Purpose**

Panoramic Corporation provides this printed manual as a guide for the operation of the PC-1000 dental panoramic X-ray machine and the PC-1000/Laser 1000 dental panoramic/cephalometric dental X-ray machine.

The PC-1000 will enable the user to take panoramic X-ray images. The PC-1000/Laser 1000 will enable the user to take panoramic X-ray images, as well as cephalometric X-ray images. A laser alignment device is incorporated into the PC-1000/Laser 1000.

The information contained in this manual is not all inclusive and Panoramic Corporation should be contacted for assistance and clarification when necessary.

It is imperative that this equipment be installed, serviced, and used by personnel familiar with the precautions required to prevent excessive exposure to both primary and secondary radiation. This equipment features protective designs for limiting both the primary and secondary radiation produced by the X-ray beam. However, design features cannot prevent carelessness, negligence, or lack of knowledge.

Only personnel authorized by Panoramic Corporation are qualified to install and service this equipment. Any attempt to install or service this equipment by anyone not so authorized will void the warranty and may create hazardous exposure to X-radiation.

---

## **Statement of Compatibility**

**January 1, 1988**

Please address any comments/questions concerning this statement of compatibility to:

Panoramic Corporation • 4321 Goshen Road • Fort Wayne, IN 46818 USA • Attn: Director of Engineering

The only components compatible with the PC-1000 are those supplied with the machine.

Regardless of possible statements made by other manufacturers, no one is authorized or certified to make additions or deletions to this machine. Only the combination of components delivered with the machine is certified compatible by the manufacturer. As compatible accessories become available, Panoramic Corporation will certify them as compatible and make them available to the user.

## **Statement of Compatibility Addendum**

**October 1, 1988**

The Laser 1000 Cephalometric Attachment is certified by Panoramic Corporation to be compatible with the PC-1000 dental X-ray machine, provided installation is performed by an authorized representative utilizing specific installation instructions furnished by Panoramic Corporation.

## **Statement of Compatibility Addendum**

**October 1, 1995**

Laser 1000 Cephalometric Attachments manufactured after October 1, 1995 are compatible only with PC-1000 X-ray machines manufactured after October 1, 1995.



Panoramic Corporation

4321 goshen road, fort wayne, in 46818  
800.654.2027 260.489.2291 fax 260.489.5683  
www.pancorp.com

© Copyright 2007 Panoramic Corporation

3

# Introduction

## **Voltage Regulator Warning**

Do not plug this machine into **ANY** voltage regulating device. Contact Panoramic Corporation with any questions regarding this.

---

## **X-ray Shielding Requirements**

The requirements for panoramic and cephalometric shielding for building, operator, and patient, depend on state and local regulations. Contact your state Department of Health for compliance information.

Compliance could involve a blueprint review, facility check, wall construction, film badge implementation, remote switch installation, and/or a lead apron. It is beyond the scope of this manual to advise on these regulations.



# PC-1000 Components

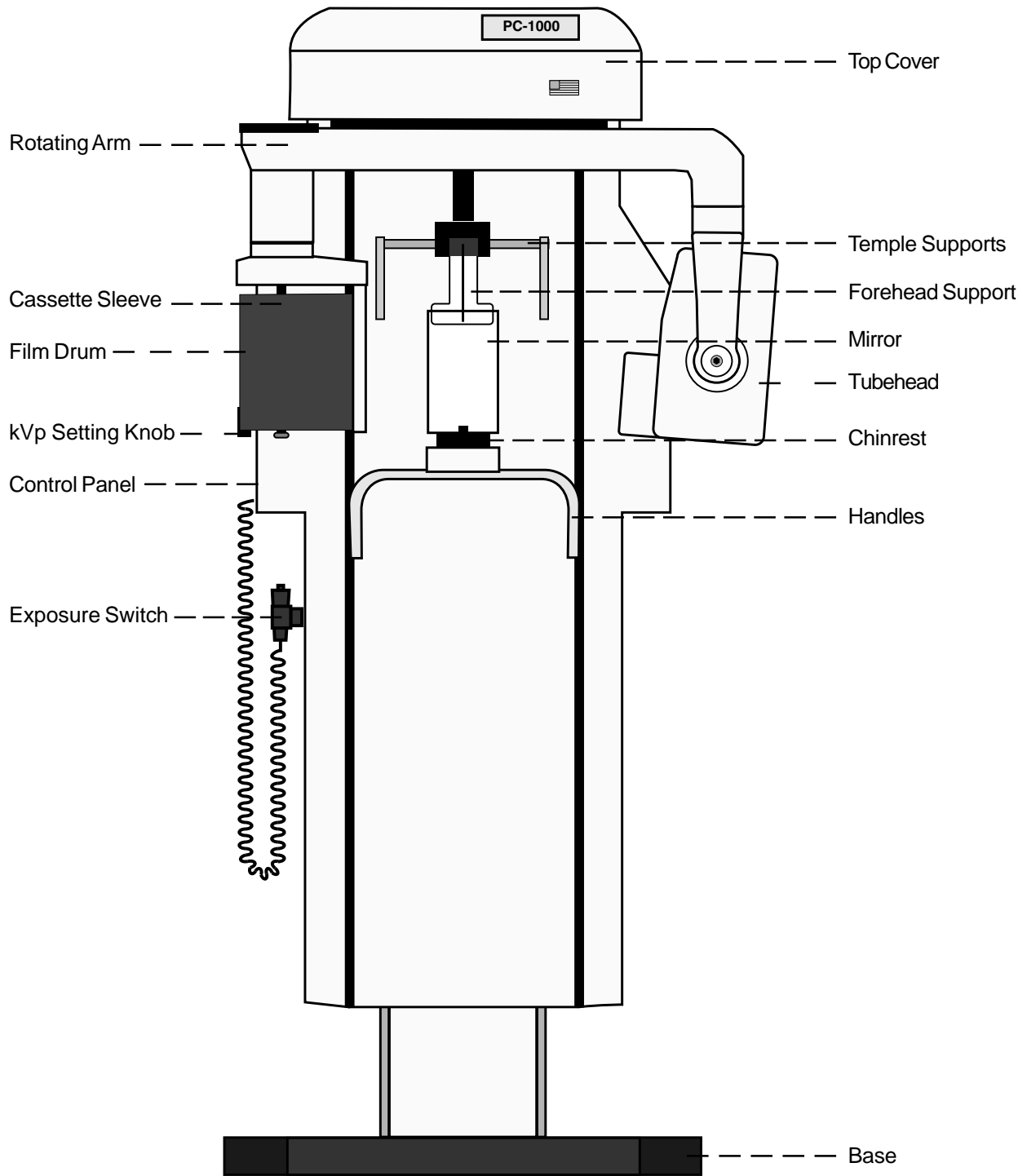

# PC-1000 Pre-Patient Setup

1. In a lighttight darkroom, load a panoramic film in the cassette sleeve between the intensifying screens.
2. Power the PC-1000 on by depressing the POWER switch on the control panel.



3. Rotate the function switch on the control panel to either PANORAMIC L or PANORAMIC R. PANORAMIC L will cause the film drum to start on the patient's left side, PANORAMIC R will cause the film drum to start on the patient's right side. The PC-1000 will automatically rotate the film drum to the proper side, if the function switch is changed.



4. If the film drum is not in its "home" position (patient's left side on PANORAMIC L, patient's right side on PANORAMIC R), momentarily depress the RESET switch on the control panel. The PC-1000 will rotate the film drum to the proper side.



5. Loosen the knob on the rear of the film drum.
6. Load a film cassette sleeve on the film drum:
  - a. Place the loaded cassette sleeve on the film drum with the lower edge of the cassette sleeve resting on the lower lip of the film drum.
  - b. Attach the vertical velcro at the end of the cassette sleeve to the mating velcro on the end of the film drum. Ensure the cassette sleeve is flat against the film drum.



# PC-1000 Pre-Patient Setup

- c. Attach the velcro tab of the cassette sleeve to the mating velcro on the center post of the film drum.

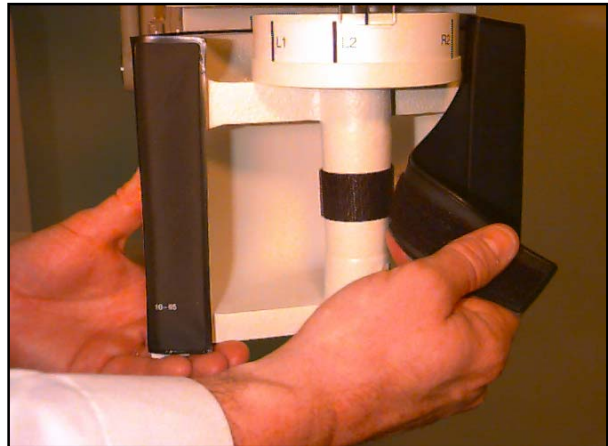

- d. The FUNCTION switch on the control panel will determine on which side (patient's) the film drum will reset and start. Align the pointer on the rear of the film drum to the appropriate mark. If the FUNCTION switch is set to PANORAMIC L, align the pointer to L1. If the FUNCTION switch is set to PANORAMIC R, align the pointer to R1.
- e. Tighten the film drum knob on the rear of the film drum.



**Note:** The film drum will rotate with increased friction after the film drum knob is tightened. Manual rotation, while the knob is tight, should be avoided to prevent abnormal wear.

7. Using the knob at the rear of the forehead support, adjust the forehead support toward the mirror to allow room for positioning the patient.



# PC-1000 Pre-Patient Setup

- Slide the temple supports apart to allow room for positioning the patient's head.

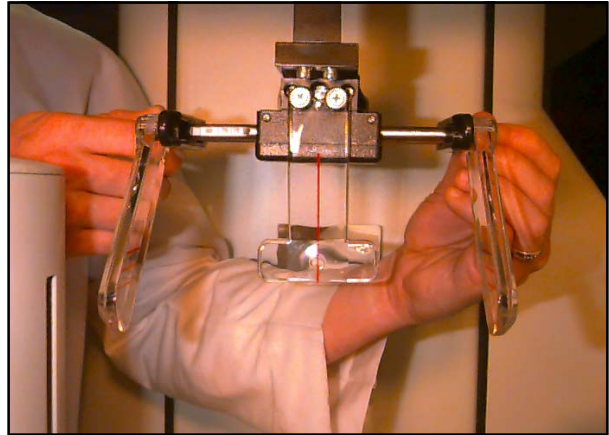

- Using the UP/DOWN switch on the chinrest arm, adjust the chinrest arm until it is slightly higher than the patient's chin.

This will ensure that the patient stands up as straight as possible.



- If a stool is to be used, place the stool so that the seat is centered under the chinrest.

This will help ensure that the patient's neck is straight.

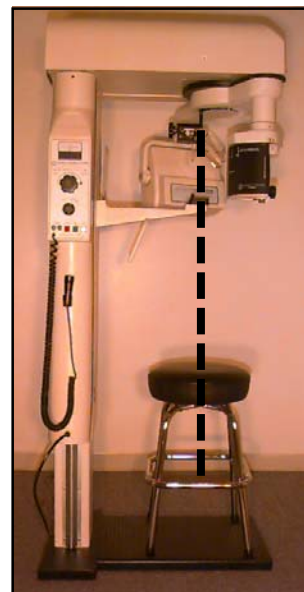



# PC-1000 Patient Positioning

## Prepare The Patient

1. Ask the patient to remove any metal objects, such as glasses, earrings, removable dentures, hearing aids, hair pins, neck chains, bib chains, and collar zippers from their head and neck area.

These objects can prevent X-rays from reaching the film, causing poor diagnostic-quality images.



2. If a lead apron is used, and a panoramic poncho is not available, place the lead apron on the patient's back. Ensure that it does not cover the back of the neck.

As the tubehead rotates around the patient, the X-rays pass through the head at a slight upward angle. This allows the X-ray beam to pass through the skull more efficiently by avoiding the denser area of the patient's skull.



3. Guide the patient into the PC-1000. Use the UP/DOWN switch on the chinrest arm to adjust the chinrest arm until it is slightly higher than the patient's chin.

This will ensure that the patient is standing up as straight as possible.



Panoramic Corporation

4321 goshen road, fort wayne, in 46818  
800.654.2027 260.489.2291 fax 260.489.5683  
www.pancorp.com

© Copyright 2007 Panoramic Corporation

# PC-1000 Patient Positioning

4. Have the patient hold on to the handles and move his/her feet under the chinrest.

This will help ensure that the patient's neck is straight.

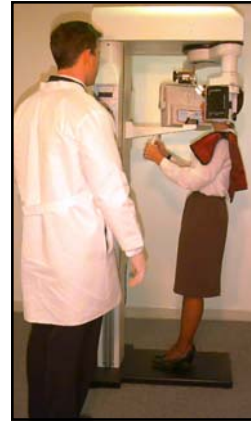

5. Place the appropriate chinrest on the permanent, black chinrest on the chinrest arm:
  - a. Small child - removable, black plastic chinrest

May be needed to allow the child's forehead to reach the forehead support.



- b. Adolescent and adult - no additional chinrest

Majority of patients require no additional chinrest.



- c. Edentulous - removable, clear plastic chinrest

Aids in centering and consistently positioning the patient.



# PC-1000 Patient Positioning

6. If the patient is not edentulous, insert a disposable bite-guide in the permanent, black chinrest. Have the patient bite on the disposable bite-guide. Ensure that the bite-guide is centered between the central incisors.

For edentulous patients, have the patient bite on a 1 1/2" cotton roll to keep the maxilla and mandible separated.



## Position The Patient

1. Place your hand at the base of the patient's skull and apply pressure vertically to stretch the neck while slowly lowering the machine until the patient's Frankfort Plane is horizontal (parallel to the red guidelines on the temple supports).

The Frankfort Plane is the imaginary line from the middle of the ear opening to the bottom of the eye orbit. A level Frankfort Plane will ensure that the upper and lower anterior teeth are in one vertical plane and will help stretch the patient's neck enough to allow X-rays to pass between the vertebrae.

2. Using the knob on the rear of the forehead support, adjust the forehead support until it touches the patient's forehead.

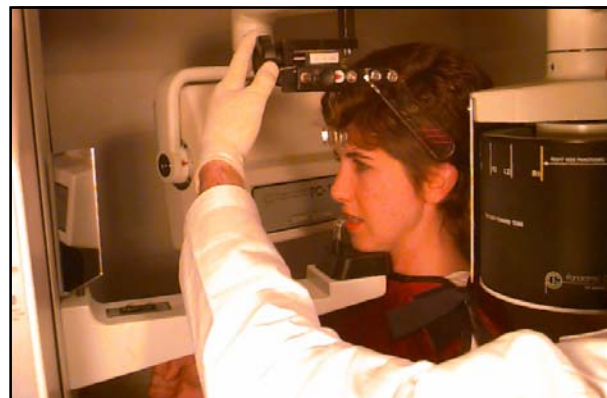
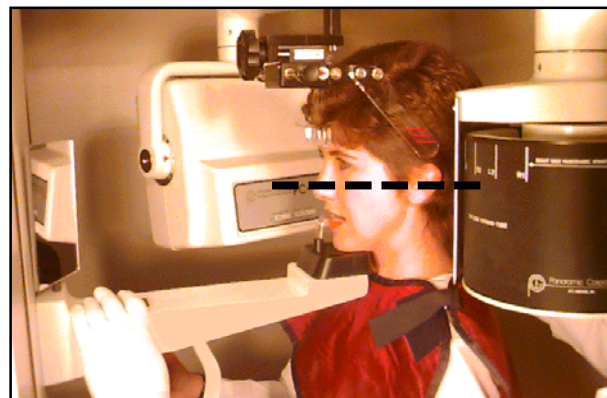

3. Center the patient's head using the red line on the forehead support. Turn the mirror to see the patient to verify centering.



# PC-1000 Patient Positioning

4. Gently slide the temple supports against the patient's head. These will help keep the patient centered and measure the width of the skull to determine the amount of kVp required to penetrate the skull.



## Set The kVp

1. Note which number the arrow points to on the kVp scale decal on the outside of the temple support rod.

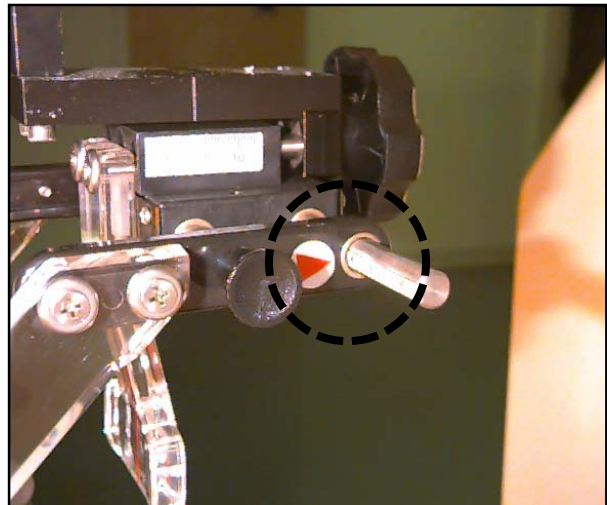

2. Using the kVp setting knob on the control panel, set the kVp meter to the number from the kVp scale decal on the temple support rod (previous step). This sets the penetrating power of the X-rays.



## Re-check Patient Positioning

1. Ensure that the:
  - a. patient's chin is firmly seated on the chinrest
  - b. patient's head is centered
  - c. patient's Frankfort Plane is horizontal
  - d. patient's neck is stretched
  - e. patient's forehead is resting on the forehead support
  - f. temple supports are against the patient's head
  - g. kVp meter is set to the number on the temple support rod



# PC-1000 Patient Positioning

## Take The Exposure

1. Instruct the patient to close his/her lips around the disposable bite-guide, swallow, place his/her tongue on the roof of his/her mouth, and remain still during the exposure.

This will help equalize tissue densities and help prevent unwanted artifacts and blurring.

2. Depress and hold the exposure switch. The arm will begin to rotate around the patient after a second. After 12 seconds, the exposure will automatically terminate.

To prematurely terminate an exposure, release the exposure switch at anytime during the exposure.

## Release The Patient

1. Slide the temple supports away from the patient's head to release the patient.
2. Instruct the patient to step out of the machine.

## Reset The Machine

1. Discard the disposable bite-guide.

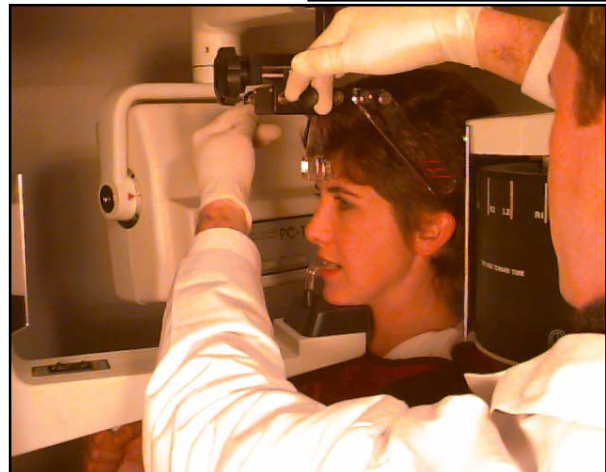

# PC-1000 Patient Positioning

2. Depress the RESET switch on the control panel to reposition the film drum to its "home" position.



## Process The Film

1. Loosen the film drum knob on the rear of the film drum and remove the cassette sleeve from the film drum.

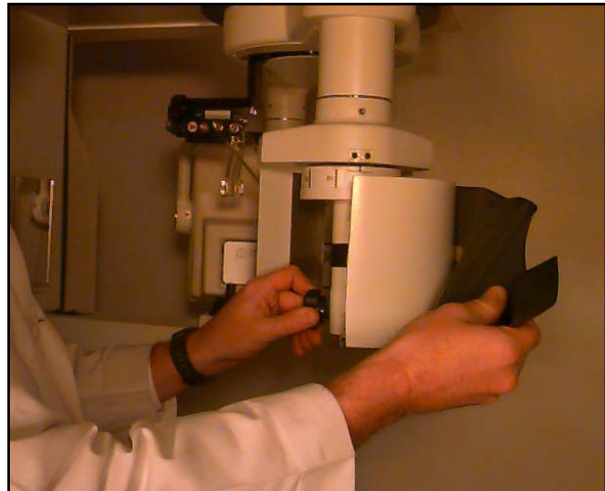

2. Under lighttight darkroom conditions, process the film.



# PC-1000 TMJ Pre-Patient Setup

A TMJ series is simply four two-second panoramic images exposed on one film. The TMJ film will show the patient's right closed, right open, left open, and left closed temporomandibular joints.

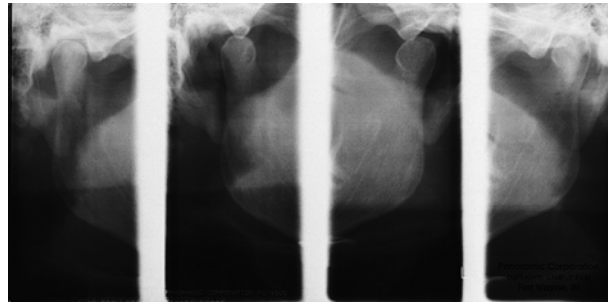

Right Closed (R1)      Right Open (R2)      Left Open (L2)      Left Closed (L1)

1. In a lighttight darkroom, load a panoramic film in the cassette sleeve between the intensifying screens.
2. Power the PC-1000 on by depressing the POWER switch on the control panel.



3. Rotate the FUNCTION switch on the control panel to TMJ L. The PC-1000 will automatically rotate the film drum to the patient's left side, if the function switch is changed.



4. If the film drum is not in its "home" position (left side), momentarily depress the RESET switch on the control panel. The PC-1000 will rotate the film drum to the patient's left side.



# PC-1000 TMJ Pre-Patient Setup

5. Loosen the knob on the rear of the film drum.
6. Load a film cassette sleeve on the film drum:
  - a. Place the loaded cassette sleeve on the film drum with the lower edge of the cassette sleeve resting on the lower lip of the film drum.
  - b. Attach the vertical velcro at the end of the cassette sleeve to the mating velcro on the end of the film drum. Ensure the cassette sleeve is flat against the film drum.

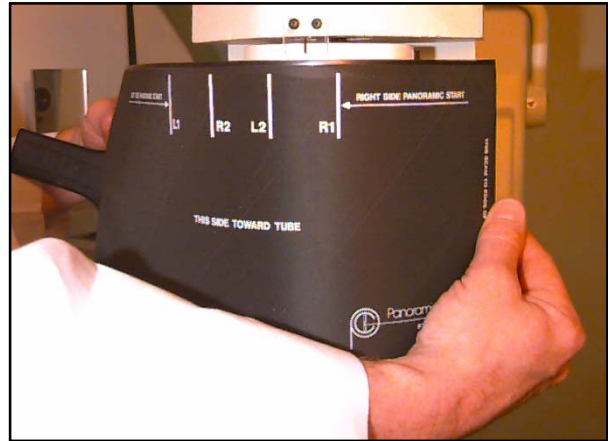

- c. Attach the velcro tab of the cassette sleeve to the mating velcro on the center post of the film drum.

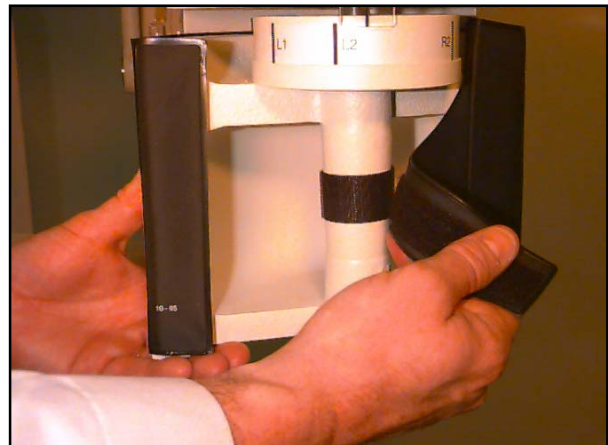

- d. Align the pointer on the rear of the film drum to L1.
  - e. Tighten the film drum knob on the rear of the film drum.

**Note:** The film drum will rotate with increased friction after the film drum knob is tightened. Manual rotation, while the knob is tight, should be avoided to prevent abnormal wear





# PC-1000 TMJ Pre-Patient Setup

- Using the knob at the rear of the forehead support, adjust the forehead support toward the mirror to allow room for positioning the patient.

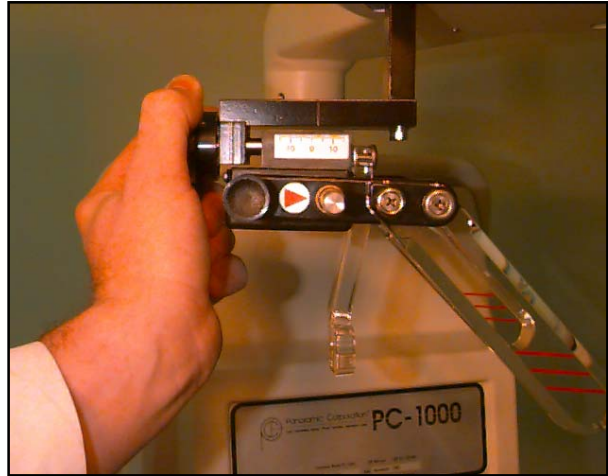

- Slide the temple supports apart to allow room for positioning the patient's head.

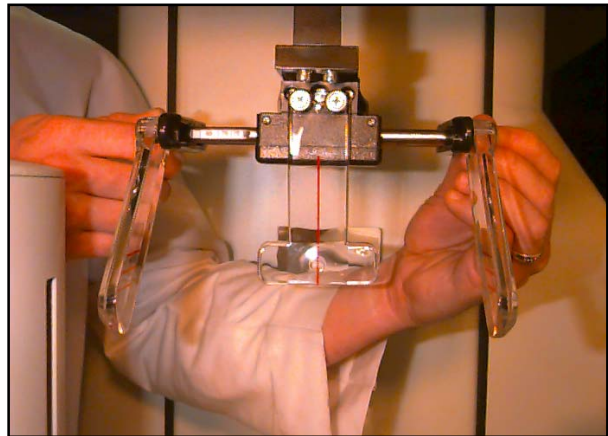

- Using the UP/DOWN switch on the chinrest arm, adjust the chinrest arm until it is slightly higher than the patient's chin.

This will ensure that the patient stands up as straight as possible.

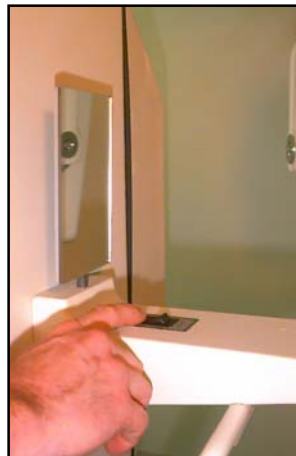

- If a stool is to be used, place the stool so that the seat is centered under the chinrest.

This will help ensure that the patient's neck is straight.

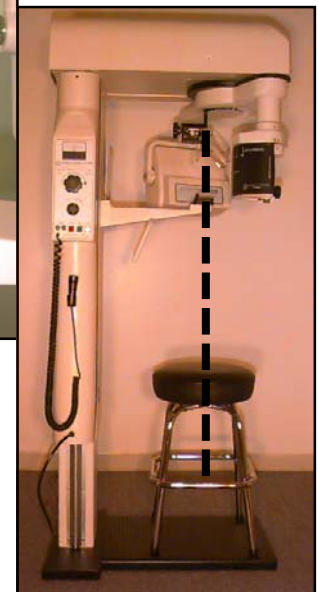

# PC-1000 TMJ Patient Positioning

## Prepare The Patient

1. Ask the patient to remove any metal objects, such as glasses, earrings, removable dentures, hearing aids, hair pins, neck chains, bib chains, and collar zippers from their head and neck area.

These objects can prevent X-rays from reaching the film, causing poor diagnostic-quality images.



2. If a lead apron is used, and a panoramic poncho is not available, place the lead apron on the patient's back. Ensure that it does not cover the back of the neck.

As the tubehead rotates around the patient, the X-rays pass through the head at a slight upward angle. This allows the X-ray beam to pass through the skull more efficiently by avoiding the denser area of the patient's skull.



3. Guide the patient into the PC-1000. Use the UP/DOWN switch on the chinrest arm to adjust the chinrest arm until it is slightly higher than the patient's chin.

This will ensure that the patient is standing up as straight as possible.



# PC-1000 TMJ Patient Positioning

4. Have the patient hold on to the handles and move his/her feet under the chinrest.

This will help ensure that the patient's neck is straight.

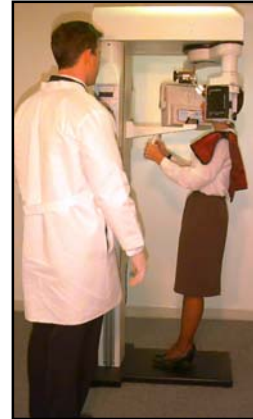

5. Place the appropriate chinrest on the permanent, black chinrest on the chinrest arm:
  - a. Small child - removable, clear plastic chinrest

Aids in centering and consistently positioning the patient.



- b. Adult - removable, clear plastic chinrest

Aids in centering and consistently positioning the patient.



- c. Edentulous - removable, clear plastic chinrest

Aids in centering and consistently positioning the patient.



# PC-1000 TMJ Patient Positioning

## Position The Patient

1. Place your hand at the base of the patient's skull and apply pressure vertically to stretch the neck while slowly lowering the machine until the patient's Frankfort Plane is horizontal (parallel to the red guidelines on the temple supports).

The Frankfort Plane is the imaginary line from the middle of the ear opening to the bottom of the eye orbit. A level Frankfort Plane will help ensure that the temporomandibular joints are consistently vertical.



2. Using the knob on the rear of the forehead support, adjust the forehead support until it touches the patient's forehead.

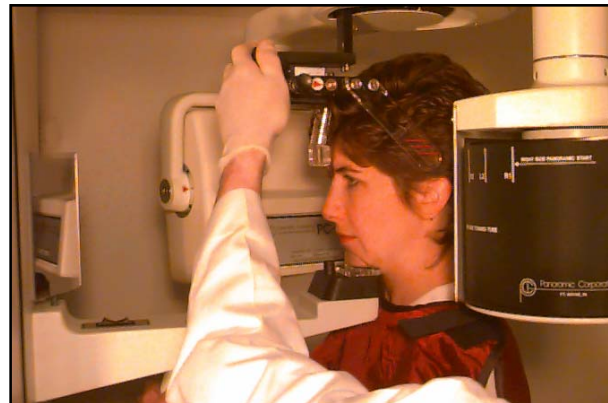

3. Center the patient's head using the red line on the forehead support. Turn the mirror to see the patient to verify centering.



# PC-1000 TMJ Patient Positioning

4. Gently slide the temple supports against the patient's head.

These will help keep the patient centered and measure the width of the skull to determine the amount of kVp required to penetrate the skull.



## Set The kVp

1. Note which number the arrow points to on the kVp scale decal on the outside of the temple support rod.

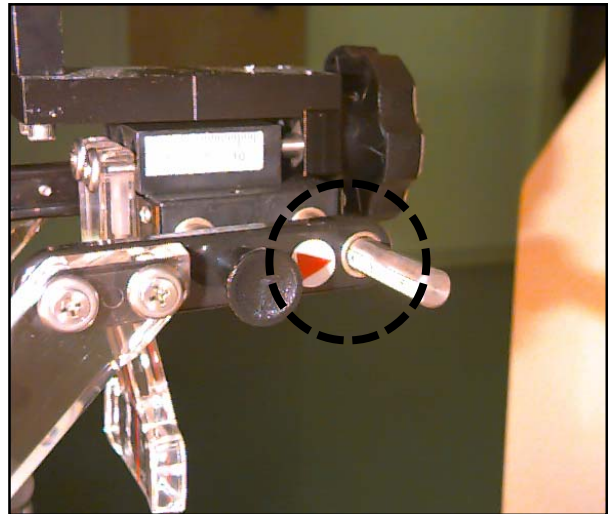

2. Using the kVp setting knob on the control panel, set the kVp meter to the number from the kVp scale decal on the temple support rod (previous step).

This sets the penetrating power of the X-rays.



## Re-check Patient Positioning

1. Ensure that the:
  - a. patient's chin is firmly seated on the chinrest
  - b. patient's head is centered
  - c. patient's Frankfort Plane is horizontal
  - d. patient's neck is stretched
  - e. patient's forehead is resting on the forehead support
  - f. temple supports are against the patient's head
  - g. kVp meter is set to the number on the temple support rod



# PC-1000 TMJ Patient Positioning

## Take The Exposure

1. Instruct the patient to close his/her lips, swallow, place his/her tongue on the roof of his/her mouth, and remain still during the four exposures.

This will help equalize tissue densities and help prevent unwanted artifacts and blurring.

2. Depress and hold the exposure switch.

The arm will begin to rotate around the patient after a second. After about 2 seconds, the exposure will automatically terminate. When the exposure switch is released, the film drum will reset to its "home" position on the patient's left side.

3. Loosen the knob on the rear of the film drum.
4. Align the pointer on the rear of the film drum to L2 and tighten the film drum knob.

5. Instruct the patient to open his/her mouth.

This will place the temporomandibular joints in their open positions. (A surgical bite block may be used to help the patient keep his/her mouth open).

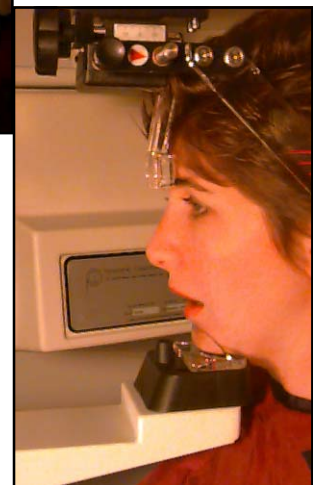
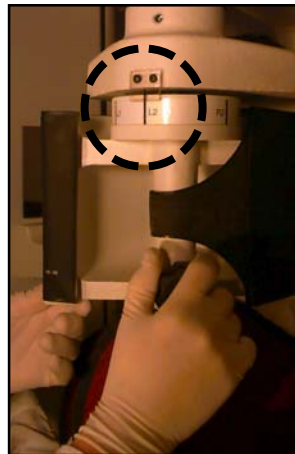

# PC-1000 TMJ Patient Positioning

6. Depress and hold the exposure switch.

The arm will begin to rotate around the patient after a second. After about 2 seconds, the exposure will automatically terminate. When the exposure switch is released, the film drum will reset to its "home" position on the patient's left side.



7. Rotate the function switch on the control panel to TMJ R.

The PC-1000 will automatically rotate the film drum to the patient's right side.



8. Align the pointer on the rear of the film drum to R2 and tighten the film drum knob.

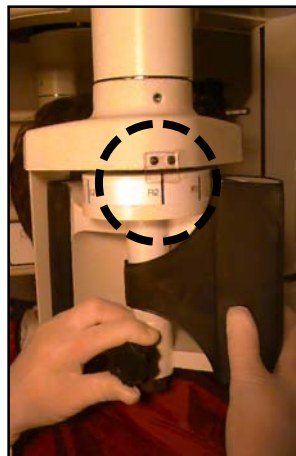

9. Instruct the patient to remain still with his/her mouth open.

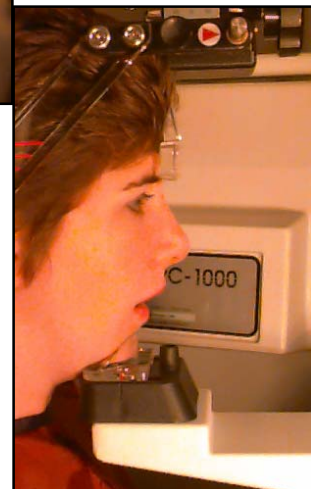

# PC-1000 TMJ Patient Positioning

10. Depress and hold the exposure switch.

The arm will begin to rotate around the patient after a second. After about 2 seconds, the exposure will automatically terminate. When the exposure switch is released, the film drum will reset to its "home" position on the patient's right side.



11. Allow the patient to close his/her mouth.



12. Align the pointer on the rear of the film drum to R1 and tighten the film drum knob.

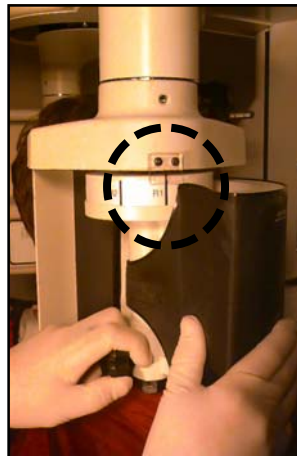

13. Depress and hold the exposure switch.

The arm will begin to rotate around the patient after a second. After about 2 seconds, the exposure will automatically terminate. When the exposure switch is released, the film drum will reset to its "home" position on the patient's right side.





# PC-1000 TMJ Patient Positioning

## Release The Patient

1. Slide the temple supports away from the patient's head to release the patient.
2. Instruct the patient to step out of the machine.



## Process The Film

1. Loosen the film drum knob on the rear of the film drum and remove the cassette sleeve from the film drum.



2. Under lighttight darkroom conditions, process the film.

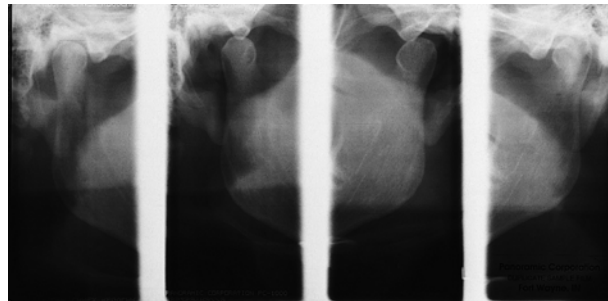

Panoramic Corporation

4321 goshen road, fort wayne, in 46818  
800.654.2027 260.489.2291 fax 260.489.5683  
www.pancorp.com

© Copyright 2007 Panoramic Corporation

25

# Notes



# PC-1000/Laser 1000 Components

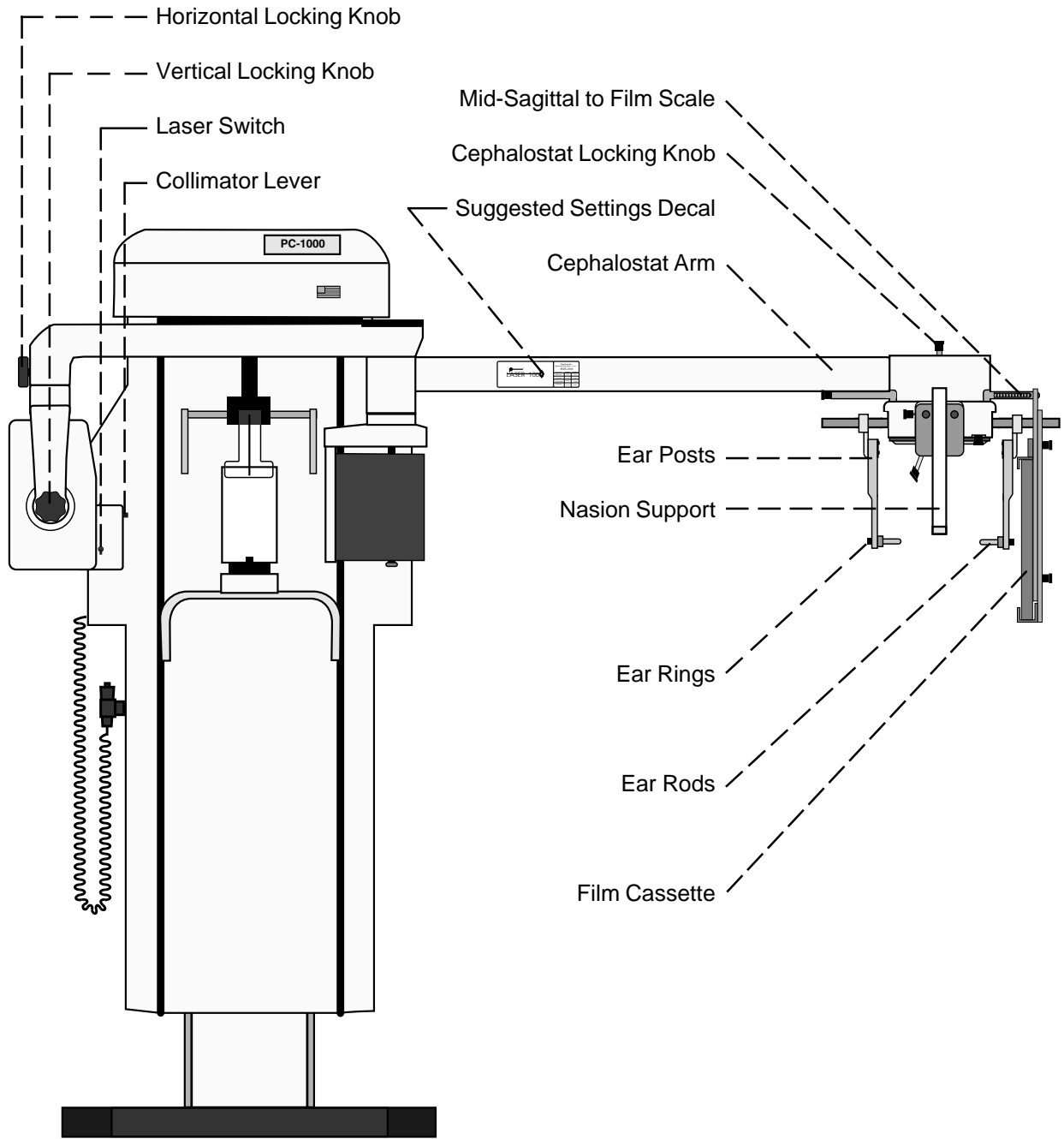

# Laser 1000 Pre-Patient Setup



## CAUTION

- Do not look into the laser beam when operating. Laser light can cause permanent eye damage.
- Safe operating instructions must be observed to prevent an optical hazard to the patient and/or operator.

1. In a lighttight darkroom, load a cephalometric film in the film cassette between the intensifying screens.
2. Power the PC-1000/Laser 1000 on by depressing the POWER switch on the control panel.



3. Rotate the FUNCTION switch on the control panel to one of the CEPHALOMETRIC SECONDS settings.



This will set the duration of the X-ray exposure.

Suggested settings can be found on a decal on the cephalometric arm.

CEPHALOMETRIC EXPOSURE TIME & KVP CHART			
Patient Size	KVP	Seconds	Latent (min)
Child	75	0.5	0.8
Adult	80	0.8	1.0
Average Adult	85	0.8	1.2
Large Adult	90	1.0	1.5

If the tubehead is not in its "home" position (on the opposite side of the cephalometric arm), the PC-1000/Laser 1000 will rotate the tubehead to the proper side.



# Laser 1000 Pre-Patient Setup

- Loosen both of the locking knobs on the rear of the cassette holder at the end of the cephalometric arm.



- Align the top edge of the sliding portion of the cassette holder to the appropriate mark on the decal on the rear of the fixed portion of cassette holder. Use the upper mark, LATERAL, if the film cassette will be oriented horizontally for lateral views.

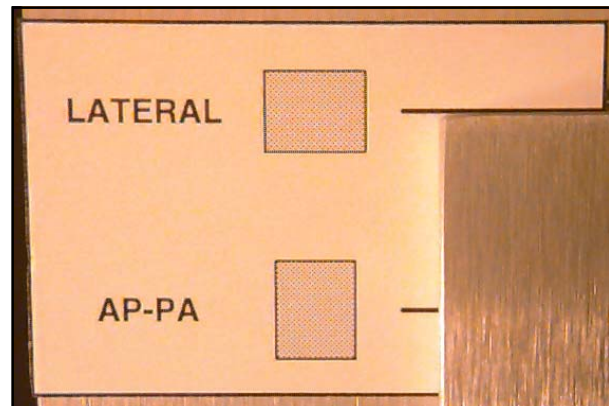

Use the lower mark, AP-PA, if the film cassette will be oriented vertically for all other views.

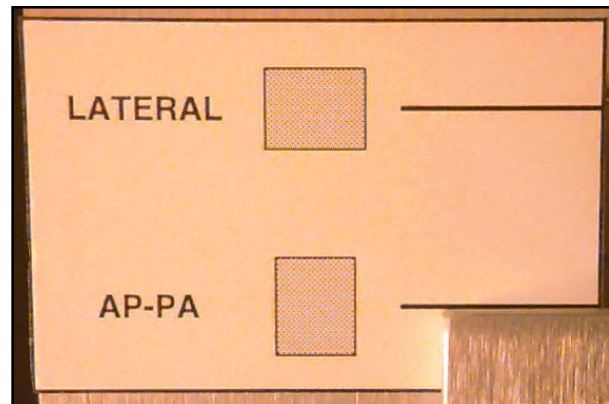

- Tighten the lower knob.

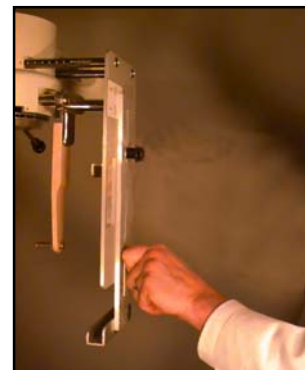

# Laser 1000 Pre-Patient Setup

- Place the film cassette into the cassette holder and center it horizontally. Tighten the upper knob.



- Remove the locking pin from the top of the cephalometric head positioner and use the ear posts' metal supports only, to temporarily rotate the head positioner to a 45° position to allow the laser alignment beam to strike the film cassette target.

**Note:** *Never use the wooden ear posts to rotate the head positioner or misalignment can result.*

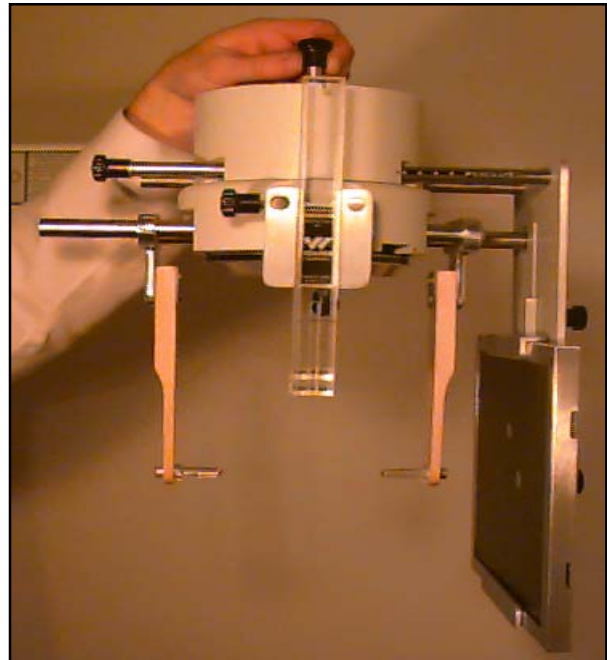

- Slide the lever in the collimator assembly on the front of the tubehead to select the appropriate collimator based on the orientation of the film cassette. Select the LATERAL position for a cassette oriented horizontally. Select the AP-PA position for a cassette oriented vertically.

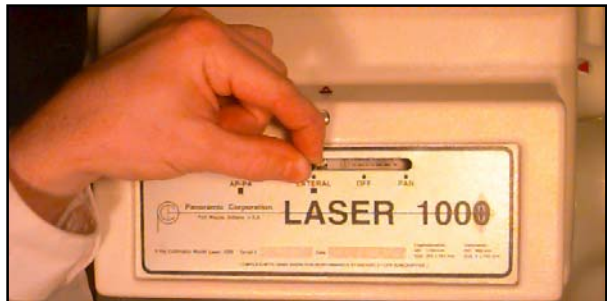

- NOTE:** *If the collimator is NOT firmly seated in its locking notch:*
- the alignment laser will not fire*
  - when the exposure switch is depressed, the machine will beep rapidly, but no radiation will be emitted*

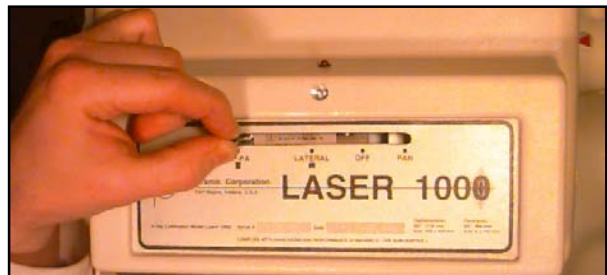

# Laser 1000 Pre-Patient Setup

- Loosen the two locking knobs on the tubehead assembly and turn the tubehead towards the cephalometric film cassette.

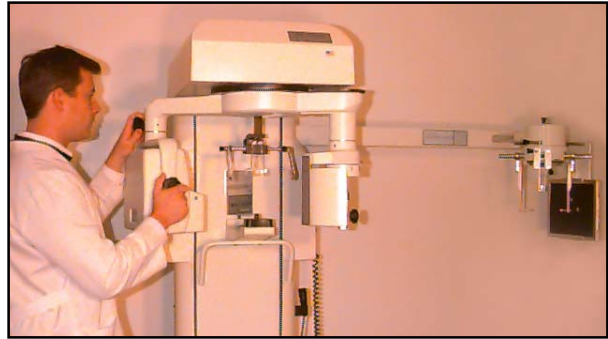

- Depress the momentary toggle switch on the right side of the tubehead to activate the laser.

**CAUTION:** *Do not look into the laser beam because laser light can cause permanent eye damage.*



- Move the tubehead until the laser alignment beam strikes the upright face target on the film cassette.

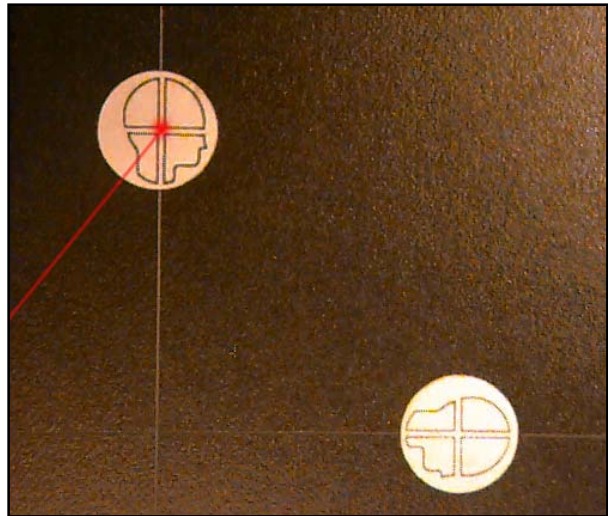

- Tighten both horizontal and vertical tubehead locking knobs.
- Activate the laser again to verify proper alignment.

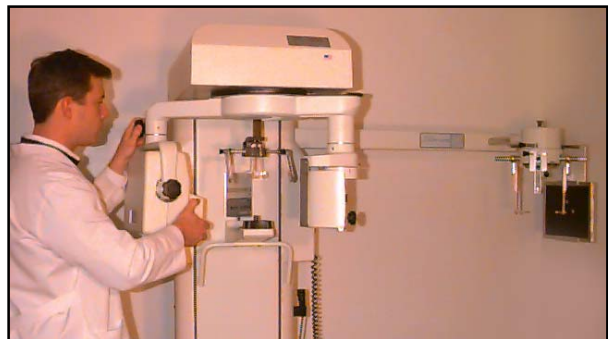

# Laser 1000 Pre-Patient Setup

14. Remove the locking pin in the top of the cephalostat head positioner. Without using the wooden ear posts, rotate the head positioner into its proper position for the appropriate view:

lateral,

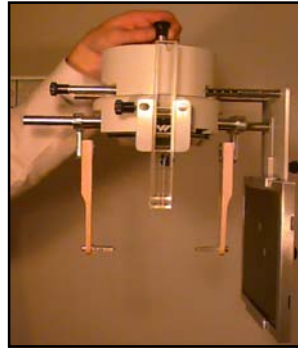

anterior to posterior,



posterior to anterior,



or any 45° increment.

15. Reinstall the locking pin in the top of the head positioner. Ensure that it is fully seated by gently rotating the head positioner back and forth.

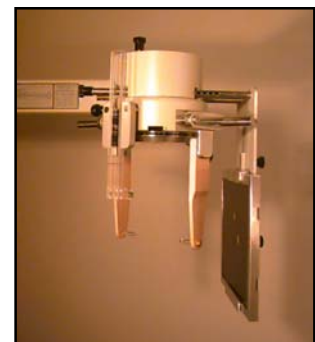



# Laser 1000 Patient Positioning

1. Verify the setting of the CEPHALOMETRIC SECONDS on the function switch on the control panel.

Suggested settings can be found on a decal on the cephalometric arm.



2. Using the kVp setting knob on the control panel, adjust the kVp to the appropriate setting.

Suggested settings can be found on a decal on the cephalometric arm. This sets the penetrating power of the X-rays.



3. Open the ear posts on the cephalostat head positioner as far as possible by using the lever on the rear of the head positioner.

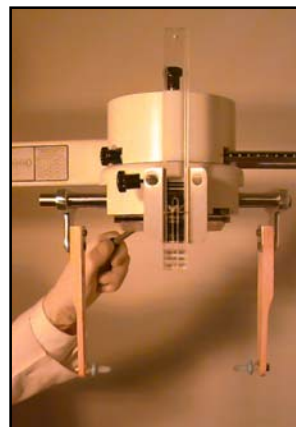

# Laser 1000 Patient Positioning

- Using the UP/DOWN switch on the chinrest arm, adjust the height of the ear posts to approximately the height of the patient's ear canals.



- Have the patient stand directly under the head positioner looking away from the cephalometric arm. Use the UP/DOWN switch on the chinrest arm until the ear rods can be guided gently into the patient's ear canals with the lever on the rear of the head positioner. Have the patient attempt to turn his/her head back and forth slightly and continue to guide the ear rods until there is minimal head movement.

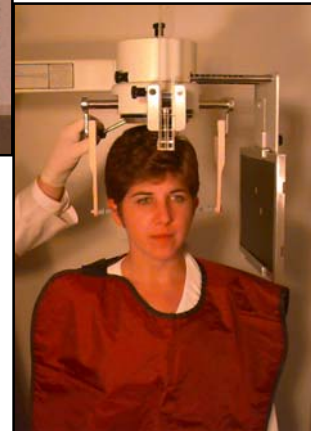

- Adjust the patient's head so that the Frankfort Plane is horizontal (level with the floor).

The Frankfort Plane is the imaginary line from the middle of the ear opening to the bottom of the eye orbit.

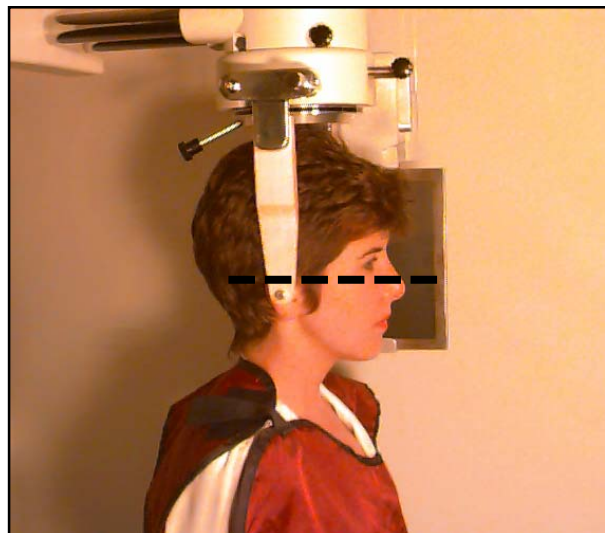

- Lower and tighten the nasion support over the bridge of the patient's nose to help the patient retain this position.



# Laser 1000 Patient Positioning

- Slide the cephalometric film holder and cassette towards the patient's head as close as possible.

The less distance between the film and the patient results in less magnification.



For reproducibility, record the number at the red dot on the midsagittal to film scale.



- If a recording of magnification is desired, place the correctional scale in its slot in the nasion support.

The scale markings will appear on the film after processing to allow for magnification ratios to be determined.



- Have the patient close his/her mouth and lips in normal occlusion and remain still.

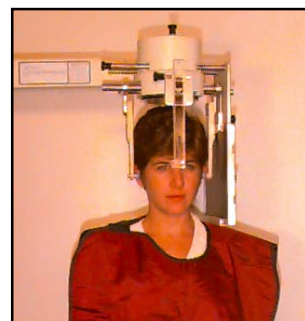

# Laser 1000 Patient Positioning

11. Depress the exposure button until the machine automatically terminates the exposure.



12. Open the ear posts by using the lever on the rear of the cephalostat head positioner or their metal supports to allow the patient to exit the machine.

**Note:** *Do not pull or push the wooden ear posts directly or misalignment can result.*



13. Remove the cephalometric film cassette from the cassette holder.



14. Under lighttight darkroom conditions, process the film.

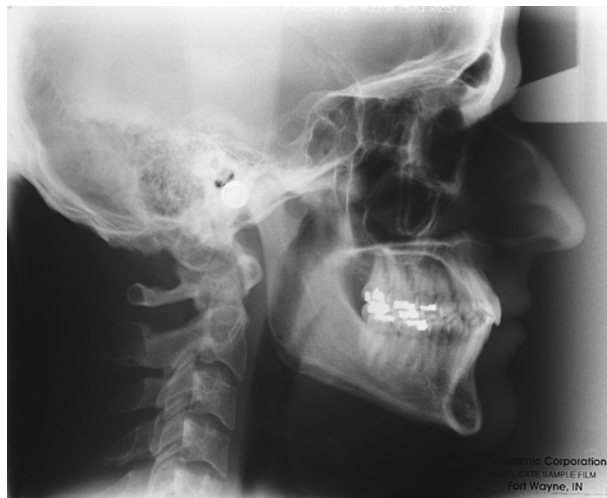

# Cephalometric to Panoramic Setup



## CAUTION

- Do not look into the laser beam when operating. Laser light can cause permanent eye damage.
- Safe operating instructions must be observed to prevent an optical hazard to the patient and/or operator.

1. Rotate the function switch on the control panel to PANORAMIC L or PANORAMIC R. PANORAMIC L will cause the film drum to start on the patient's left side, PANORAMIC R will cause the film drum to start on the patient's right side. The PC-1000 will automatically rotate the film drum to the proper side.



2. Slide the lever in the collimator assembly on the front of the tubehead to select the PANORAMIC position.

**NOTE:** If the collimator is NOT firmly seated in its locking notch:

- a. the alignment laser will not fire
- b. when the exposure switch is depressed, the machine will beep rapidly, but no radiation will be emitted

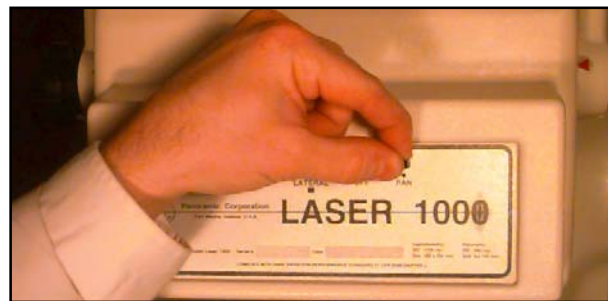

3. Loosen the two locking knobs on the tubehead assembly and turn the tubehead towards the panoramic film drum.



# Cephalometric to Panoramic Setup

4. Depress the momentary toggle switch on the right side of the tubehead to activate the laser.

**CAUTION:** Do not look into the laser beam because laser light can cause permanent eye damage.



5. Move the tubehead until the laser alignment beam strikes the cross-hair target on the film mask in front of the film drum.

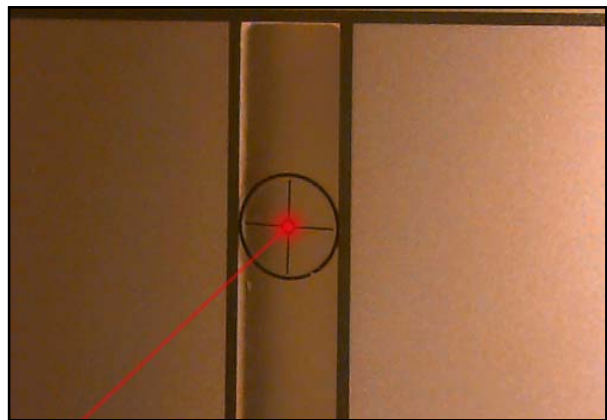

6. Tighten both horizontal and vertical tubehead locking knobs.



7. Activate the laser again to verify proper alignment.



# Panoramic Radiography

Panoramic Radiography has been in use for over 30 years. In panoramic radiography, the X-ray source and film rotate around the patient's head at the same speed. Simultaneously, the film rotates about its own axis.

X-rays are emitted from the tubehead in a very narrow vertical band, pass through the patient's head (where some are absorbed), and strike the film cassette sleeve. Intensifying screens are used inside the film cassette sleeve. The intensifying screens glow whenever X-rays strike them, the more X-rays striking the screen, the brighter the glow. Film, which is sensitive to light, is placed between the intensifying screens. The more light that is exposed to the film, the darker the film is. Since the patient is between the X-ray source and the film, the amount of X-rays that reach the film will vary depending on the density of the patient's anatomy. Dense matter, such as bone, will absorb more of the X-rays than less dense matter, such as tissue. Less X-rays reach the film when striking the teeth, causing them to appear on the film as lighter areas. More X-rays reach the film when striking tissue, causing it to appear on the film as darker areas.

In order to pass as many X-rays through the patient's head as possible, the tubehead is tilted at a slight upward angle to:

1. move the dense portion of the skull out of the path of the X-rays
2. cause the upper and lower anterior root tips to be aligned vertically
3. stretch the vertebrae in the neck to allow the X-rays to pass more efficiently through the vertebrae to expose the anterior teeth

As the tubehead and film rotate around the patient, the film is gradually exposed by a narrow vertical band. It is imperative that the film is aligned to start at the correct position and that nothing stops the film drum or tubehead from moving while the exposure is being taken.

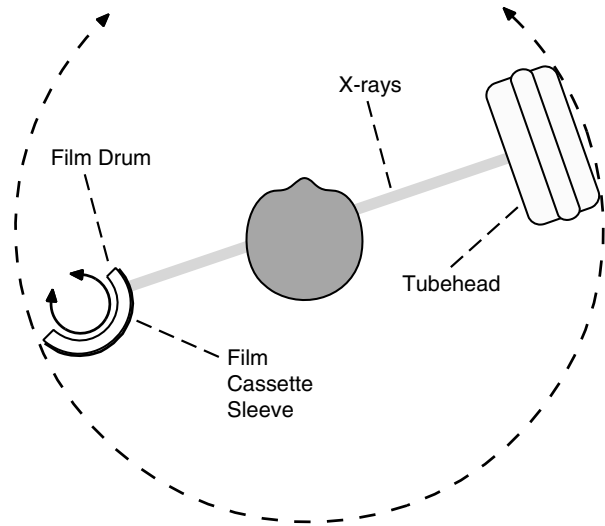

Panoramic Corporation

4321 goshen road, fort wayne, in 46818  
800.654.2027 260.489.2291 fax 260.489.5683  
www.pancorp.com

© Copyright 2007 Panoramic Corporation

Appendix  
A

# Darkroom Procedures

The darkroom must be lighttight. Extraoral (panoramic/cephalometric) film is more sensitive than intraoral (bite-wings) film to light, and processing time and temperature.

## Manual Processing

- Lighttight darkroom
- Developer and fixer solutions
- Safelight (GBX-2 filter or equivalent, 15 W bulb or less and at least 4' from film)
- Dip tanks
- Film Hanger
- Timer
- Water supply and drain
- Thermometer

1. Prepare developer and fixer solutions according to the solution's directions.
2. Verify developer temperature.
3. Under safelight conditions, remove the exposed film from the cassette sleeve and attach it to a film hanger.
4. Set the timer based on the developer temperature and the processing chart.
5. Immerse the film quickly into the developer and agitate it vigorously for only 5 seconds to dislodge any air bubbles.
6. When the timer sounds, remove the film from the developer and immediately rinse it with water for 30 seconds while agitating it. Do not allow the excess developer to drain back into the developer tank.
7. Immerse the film into the fixer and agitate it for 5 seconds every 30 seconds. Allow the excess fixer to drain back into the fixer tank.
8. Immerse the film in the water wash tank and rinse it thoroughly.
9. Dry the film at room temperature or in a drying cabinet.

## Automatic Processing

A thermometer should be present to periodically verify the temperature. It is imperative that the processor's maintenance schedule is followed thoroughly.

Manual Processing					Automatic Processing	
Film Type	Developer Temperature	Time	Rinse	Fixer		Wash
T-MAT (for use with Lanex screens)	68° F 72° F 76° F 80° F	20.0° C 22.0° C 24.5° C 26.5° C	8 min 7 min 5 min 4 min	30 sec F 15.5° C to 85° F 29.5° C	2-4 min 60° F 15.5° C to 85° F 29.5° C	5 min 60° F 15.5° C to 85° F 29.5° C
					82° F 28.0° C 5.5 min 83° F 28.5° C 4.5 min 85° F 29.5° C 4 min	

**Note:** Extraoral film requires more frequent solution replenishment than intraoral film. One ounce of chemicals are typically required for replenishment for every 75 intraoral, 3 panoramic, or 2 cephalometric films.





# Darkroom Procedures

## Darkroom Light Leak Test

Extraoral film is more sensitive to light than intraoral film. The purpose of the intensifying screens inside of the cassette sleeve is to convert the X-ray energy into light, thus exposing the film. While the light sensitivity of the film allows a very small amount of radiation to expose the film, it also can pose a problem if the darkroom is not completely lighttight. Small light leaks can cause fogging of the film while handling and processing the film in the darkroom.

The following test should be performed in the darkroom under safelight conditions to ensure it is lighttight:

1. Remove one sheet of extraoral film from the box.
2. Lay it on the counter in the darkroom under normal darkroom conditions.
3. Place a couple of coins, a pair of scissors, or any other opaque object on top of the film.
4. Wait for two minutes.
5. Process the film as usual.

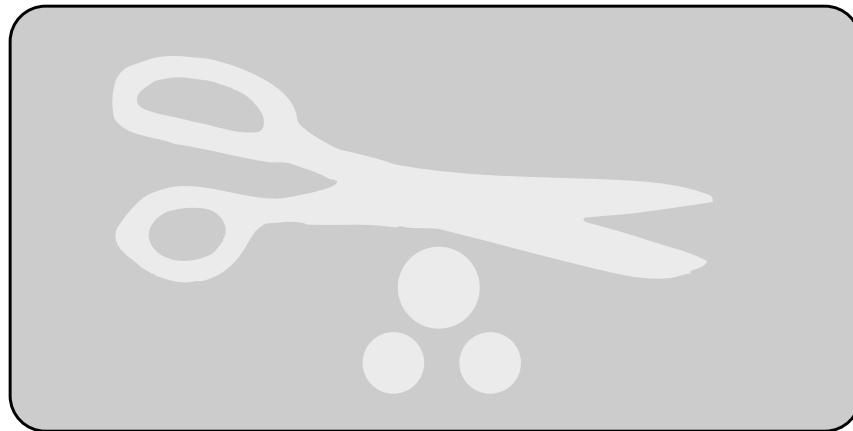

The processed film should be clear. None of the objects should be visible on the film.

If any of the objects can be seen on the processed film, there is a light leak or other light source in the darkroom. The light leak fogs the test film, everywhere except where the opaque objects are blocking the light. To find the light leak, turn all of the lights off in the darkroom and inspect the darkroom for cracks around the door and ceiling tiles. Indicator lights on equipment, such as stereos, and improper safelights can also cause fogging. Turn off all unnecessary equipment and the safelight and try this test again.



Panoramic Corporation

4321 goshen road, fort wayne, in 46818  
800.654.2027 260.489.2291 fax 260.489.5683  
www.pancorp.com

© Copyright 2007 Panoramic Corporation

Appendix  
**B**

# Darkroom Procedures

It is recommended that the panoramic and cephalometric cassettes be loaded with film just prior to use. Do not leave a film loaded in the cassettes for an extended period of time. This will prevent background radiation from prematurely exposing the film. The film should be stored in a cool and dark place.

## Loading The Panoramic Cassette

In a lighttight darkroom, open the flexible, panoramic cassette sleeve and slowly remove the intensifying screens. Open the screens on the counter and place a sheet of panoramic film on top of one of the screens. Close the screens and slowly slide them back into the cassette sleeve. Ensure that the hinged end of the screens is placed into the cassette sleeve first and the "TUBESIDE" decal is facing the same direction as the writing on the outside of the cassette sleeve. Ensure that all excess air is expelled from the cassette sleeve.

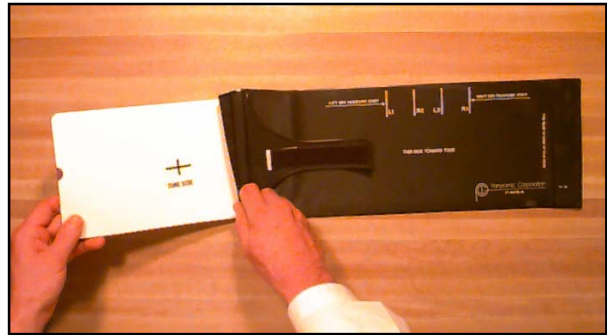

## Loading The Cephalometric Cassette

In a lighttight darkroom, unlock and open the rigid, cephalometric cassette. Place a sheet of cephalometric film on top of one of the screens. Close and lock the cassette.



**Note:** Remove and discard the protective sheet from between new intensifying screens before their first use.

# Maintenance Schedule

Panoramic Corporation strongly recommends a preventive maintenance be performed on your equipment at least every two years. All service requests must be submitted through Panoramic Corporation's Service Department by calling our toll-free number at (800) 654-2027.

Panoramic has an extensive network of independent installation and service organizations throughout the U.S. and Canada to install and service our products. The Independent Representatives have been specifically trained by our organization in the service and installation of Panoramic products. We strongly recommend that you use one of our Independent Representatives to service Panoramic products. To the extent you use third parties other than Independent Representatives to service Panoramic products, we cannot accept responsibility or liability for any work performed by those third parties and any resulting damages or liability attributable thereto. In no event shall Panoramic be liable to you or any other third party for any direct, indirect, punitive, incidental, consequential or special damages or lost profits arising from, relating to or connected with, the installation of or repair of a Panoramic product by someone other than an Independent Representative.

Always refer to your state and local regulations to determine how often to perform a preventive maintenance on your equipment as the regulations may supersede manufacturers' recommendation.

Owners of Panoramic Corporation X-Ray machines must call Panoramic Corporation Service Department for all reasons listed below but not limited to:

- Preventive maintenance at least every two years
- Physical relocation of machine
- Changing the power source to a different power source from original installation
- Questions/Help related to compliance with your state, and local regulations regarding radiological equipment
- Corrective Maintenance
- Physical damage that may affect radiation safety
- Interrupted movement, unusual noises, leaks, etc.

To schedule a preventive maintenance on your equipment contact the Service Department by dialing our toll-free number at (800) 654-2027.



Panoramic Corporation

4321 goshen road, fort wayne, in 46818  
800.654.2027 260.489.2291 fax 260.489.5683  
www.pancorp.com

© Copyright 2007 Panoramic Corporation

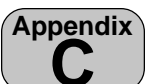

# PC-1000 Labeling

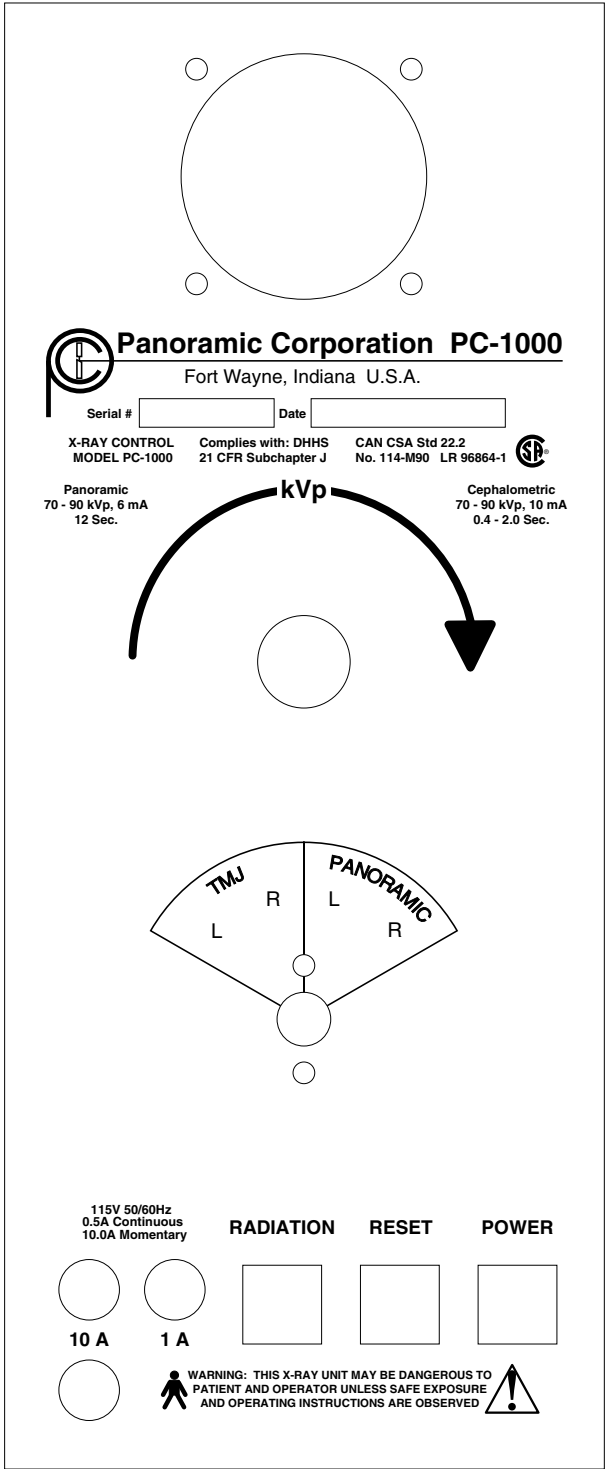

Control Panel



# Laser 1000 Labeling

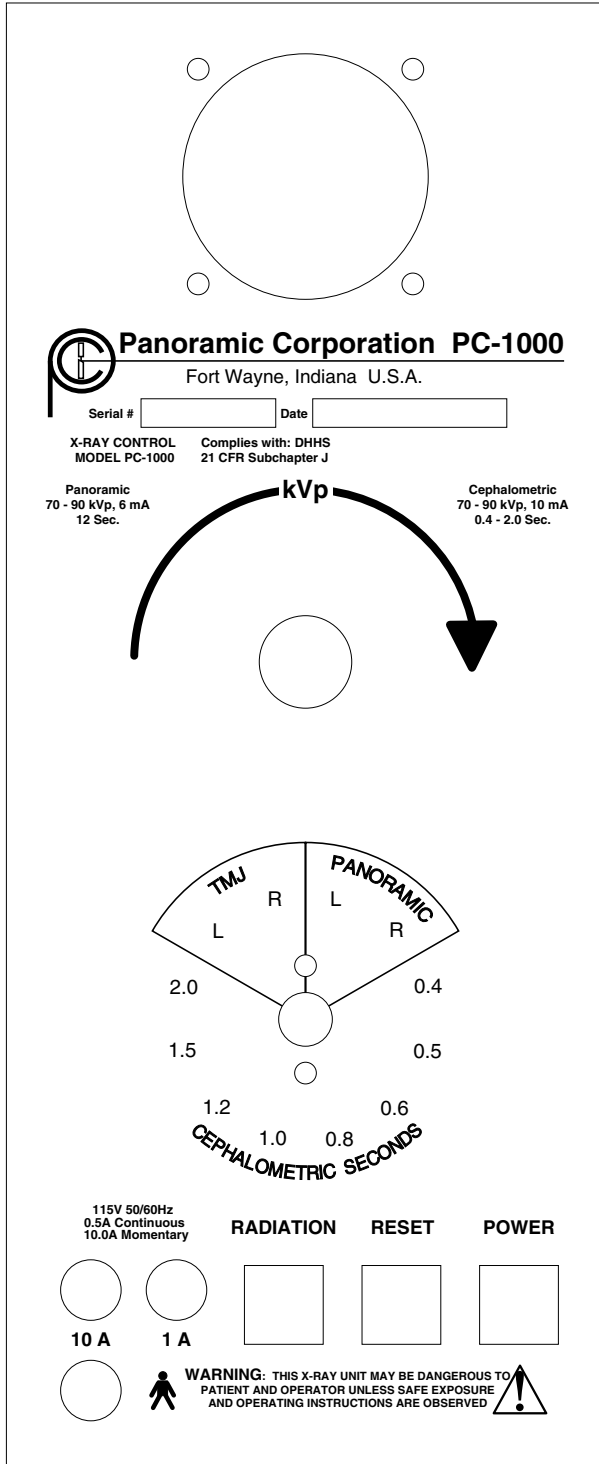

Control Panel

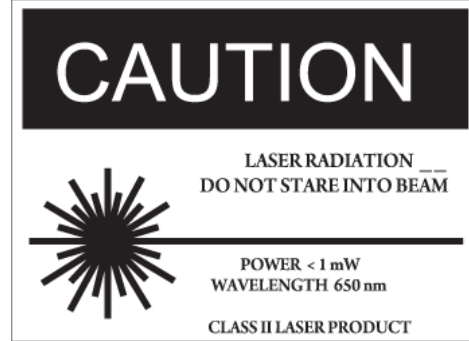

Rear Tubehead Cover

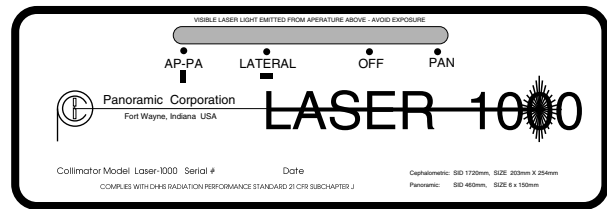

Front Tubehead Cover

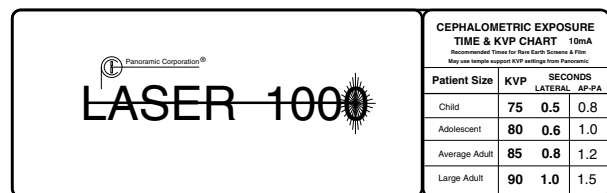

Cephalometric Arm



# PC-1000/Laser 1000 Specifications

**Power Requirements** The PC-1000 and PC-1000/Laser 1000 requires line voltage from 105 to 125 VAC, no load at 5% or better line regulation and draws 12 A under worst case conditions. The total power required is 1.5 kVa.

**Generator Type** Single-phase, half-wave, self-rectified, center-grounded.

**Duty Cycle** At 90 kVp/6 mA - One 12 second exposure every 5 minutes to a maximum of 30 exposures.

<b>Tubehead Assembly</b>	X-ray Tube	Brand X-Ray or Superior or K-Alpha
	Rated Tube Potential Peak	100 kVp
	Leakage Technique Factors	90 kVp/6 mA
	Inherent Filtration	1 mm
	Added Aluminum Filtration	1.8 mm
	Total Filtration	2.8 mm
	Peak Tube Potential at which Aluminum Equivalent was Obtained	90 kVp/6 mA

<b>X-ray Tube</b>	Manufacturer Type	Brand X-Ray or Superior or K-Alpha BX-4P0.5 or SXR-100-R-5P or KAX-90-10-P
	Focal Spot	.5 mm x .5 mm
	Maximum Peak Voltage	100 kVp
	Anode Heat Dissipation Rate	250 Watts      1 Watt=1.4 H.U./sec.
	Anode Heat Storage Capacity	35 kJ              1 kJ=1400 H.U.

<b>Statement of Deviation</b>	Peak Tube Potential	± 12% over range of rated line voltage
	Tube Current	± 10% over line voltage
	Exposure Time	± 10% over line voltage

<b>Measurement Techniques</b>	Exposure Time	Measured with Engineered Systems & Design Model XR201MS pulse counter.
	Tube Current	Measured directly with a DC mA meter having a basic accuracy of no less than ± 3%.
	Peak Tube Potential	Measured using a computerized kVp measurement system. System accuracy is ± 3% exclusive of waveform, inherent filtration, and reproducibility.
	Maximum Line Current	Machine set at 90 kVp/6 mA

**Screen/Film Type** Kodak Lanex Regular with Kodak T-MAT G (green/400 speed) or equivalent



# Laser 1000 Specifications

## Cephalometric Attachment

<b>Film Size</b>	8" x 10"
<b>Source to Image Distance (SID)</b>	1624 mm - 1724 mm (63" - 68")
<b>Exposure Times</b>	0.4, 0.5, 0.6, 0.8, 1.0, 1.2, 1.5, 2.0 seconds
<b>Tube Voltage</b>	70 - 90 kVp $\pm$ 12%
<b>Tube Current</b>	10 mA $\pm$ 10%

---

## Laser

<b>Class</b>	II
<b>Type</b>	Laser Diode, Toshiba TOLD9442M
<b>Wavelength</b>	650 nm
<b>Average Operating Current</b>	34 mA
<b>Average Operating Voltage</b>	0.75 VDC
<b>Maximum Average Radiant Power</b>	0.2 mW
<b>Maximum Peak Radiant Power</b>	< 1 mW
<b>Beam Divergence</b>	0.9 mRadian
<b>Beam Diameter</b>	1.8 mm
<b>Emission Duration</b>	Operator-controlled by a momentary switch





# PC-1000 Space Requirements

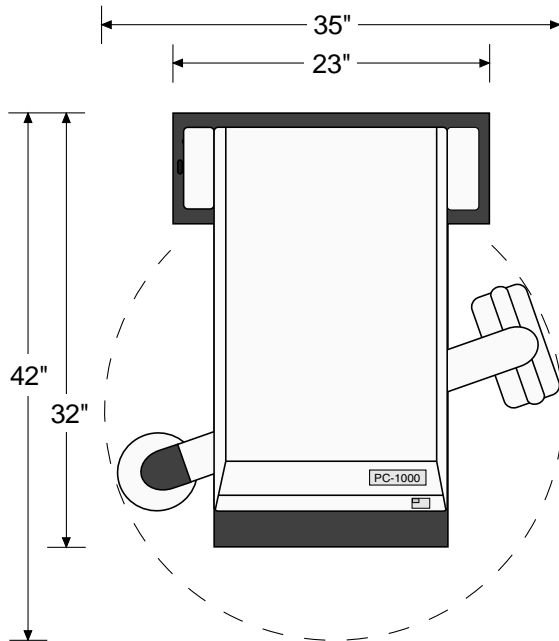

Physical Dimensions  
35" W x 42" D x 91" H

Minimum Working Space  
48" W x 48" D x 91" H

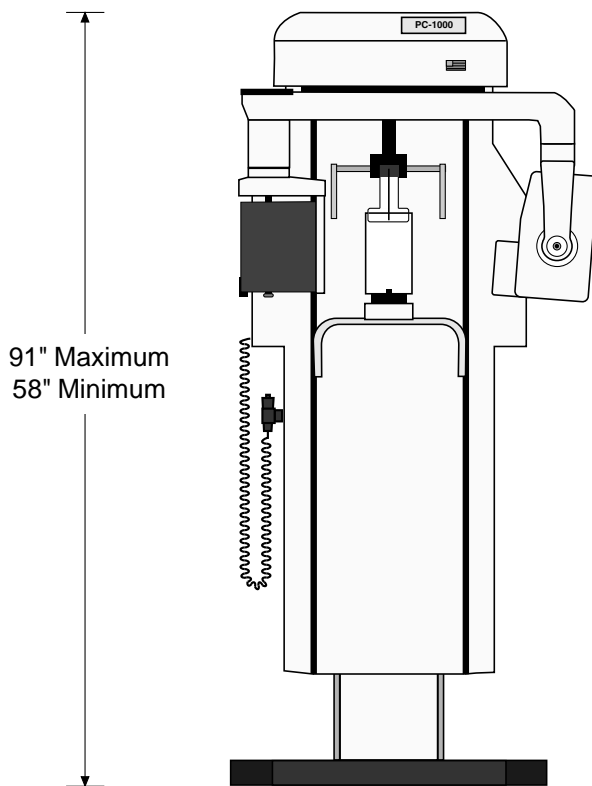

The PC-1000 weighs approximately 485 pounds and is freestanding, requiring no extra support in the wall or floor.

The factory configuration is shipped with the control panel mounted on the patient's left side, unless specified by the customer prior to shipping. The control panel can be easily relocated to the right side at the time of installation.

**Note:** The FDA requires that the technique factors (kVp meter) be viewable during the exposure.



Panoramic Corporation

4321 goshen road, fort wayne, in 46818  
800.654.2027 260.489.2291 fax 260.489.5683  
www.pancorp.com

© Copyright 2007 Panoramic Corporation

Appendix  
**F**

# PC-1000/Laser 1000 Space Requirements

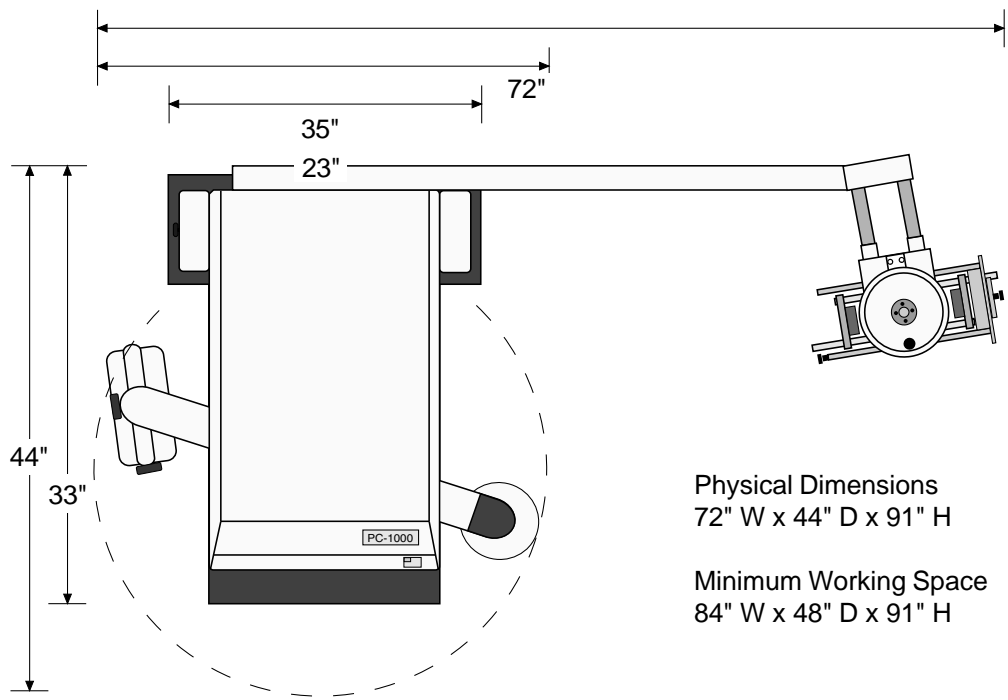

Physical Dimensions  
72" W x 44" D x 91" H

Minimum Working Space  
84" W x 48" D x 91" H

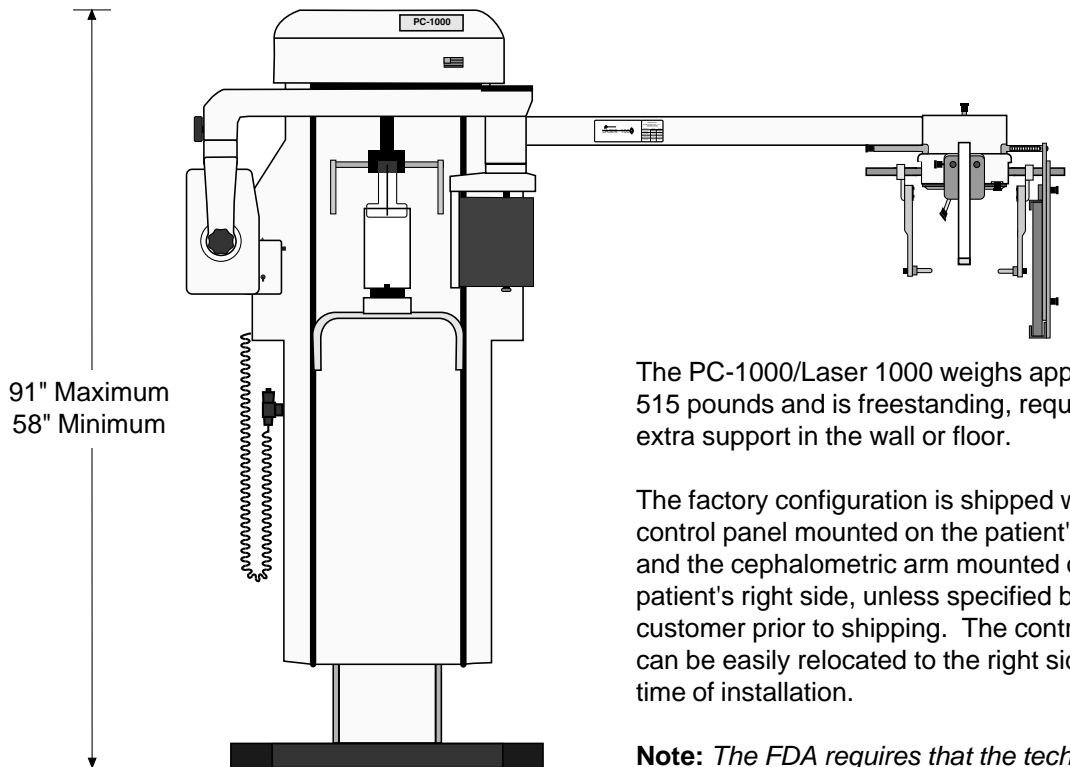

The PC-1000/Laser 1000 weighs approximately 515 pounds and is freestanding, requiring no extra support in the wall or floor.

The factory configuration is shipped with the control panel mounted on the patient's left side and the cephalometric arm mounted on the patient's right side, unless specified by the customer prior to shipping. The control panel can be easily relocated to the right side at the time of installation.

**Note:** The FDA requires that the technique factors (kVp meter) be viewable during the exposure.