



# SANLI

LSP 430 P7R(LSPR42)

**GB** PETROL LAWN MOWER

**FR** TONDEUSE THERMIQUE TRACTÉE



**PLEASE KEEP THIS MANUAL IN A SAFE PLACE**

---

## DOMESTIC OFFICE OR LOCAL DEALERS

United Kingdom

Company :Sanli UK Ltd

Web site : [www.sanli.co.uk](http://www.sanli.co.uk)

Address :Unit 200, Milton Park Estate, Abingdon, Oxfordshire OX14 4TB

E-mail : [info@sanli.co.uk](mailto:info@sanli.co.uk)

Tel: +44(0)1235 861640

France

Company :Sanli France Sas

Web site : [www.sanli.fr](http://www.sanli.fr)

Address: 10,rue Gutenberg, 67610 LA WANTZENAU

E-mail : [mail@sanli.fr](mailto:mail@sanli.fr)

Tel: +33(0)388 19 08 23

Australia

Company :Sanli Australia Development P/L

Web site : [www.sanli.com.au](http://www.sanli.com.au)

Address :9 Gatwood Close, Padstow NSW 2211

E-mail : [support@sanli.com.au](mailto:support@sanli.com.au)

Tel: 1800 466 068

# Contents

What you get with your Sanli roller mower.....	4
Mower features.....	5
Tips on mower safety .....	6-7
Before you begin .....	8-9
Cutting height adjustment.....	10
Starting the engine .....	11
Basic maintenance made easy .....	12-14
Technical specifications .....	14
Fast trouble shooting.....	15
Warranty conditions.....	16
EC Declaration of Conformity.....	17
Note.....	18
Warranty registration card.....	19-20

Sanli products are monitored and enhanced on an on-going basis to comply with changing technical standards and requirements. As a result, Sanli reserves the right to alter design and specifications at any time without prior notice.

## Congratulations on choosing a Sanli mower.

Thank you for purchasing a Sanli 4-stroke lawnmower. We're sure that you'll enjoy many years of trouble-free performance, plus you have the reassurance of an industry-leading 2-year domestic warranty as outlined on page 15.

Inside this guide you will find out all you need to know to correctly operate your new Sanli mower. To ensure that you use your new mower responsibly and get the best results possible, please read all of the safety and operating instructions carefully before using your lawnmower.

## What you get with your Sanli mower.

Name	QTY	Name	QTY
Petrol engine lawnmower	1	Clamp bolt	1
Rear grass catcher	1	Cable tie	2
Spark plug socket (21)	1	Quick release handle	2
Socket (13)	1	Multi-function wrench	1
Spanner lever	1	cover type nut (M8)	4
Quick start hook	1		



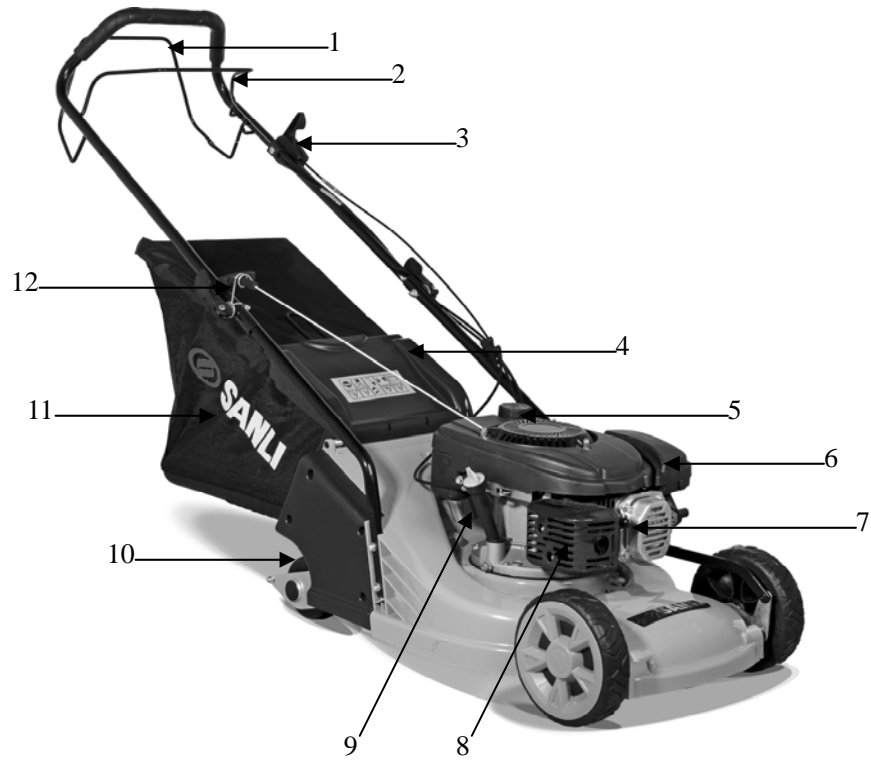

## Mower features

1	Drive lever	7	Spark plug
2	Operator presence control lever	8	Exhaust
3	Throttle control	9	Oil filler and dipstick
4	Rear deflector	10	Roller
5	Fuel tank	11	Grass collection bag
6	Air filter	12	Starter rope

# Tips on mower safety.

**WARNING!** The information contained within this safety section is extremely important. Personal injury to the user and to others may result if this section is not read and acted upon at all times.

1. Before starting your mower inspect it carefully to ensure that there are no loose parts and that it is in good working order.
2. Be sure of your footing. Always walk, never run, when operating the lawnmower.
3. Clear the area to be mowed of any stones, sticks, wire and debris before beginning, and always ensure that you mow a safe distance away (over 14 metres) from adults, children and animals.
4. Keep hands, feet and clothing away from the mower's moving parts, and always wear appropriate footwear (avoid sandals or open shoes).
5. Never put your hands or feet underneath the chassis of the lawnmower while the engine is running.
6. Be aware that the machine's exhaust area and other parts of the lawnmower get very hot during, and right after use.
7. Turn off the engine and disconnect the spark plug cap before cleaning, transporting, or making adjustments, and never leave the mower unattended.
8. Mow across the face of slopes, not up & down, and avoid mowing on very steep slopes. We recommend you avoid mowing when it is raining, or after nightfall.
9. Do not operate the machine by pulling it towards you as you risk pulling it on to your feet. Instead, always push and walk behind your lawnmower.
10. Do not fill the tank, or start the lawnmower indoors, or in a poorly ventilated area, as exhaust gases contain poisonous substances and petrol fumes are flammable and dangerous.
11. Always use unleaded petrol not more than 3 months old. Fill the tank using a funnel, but never completely. Clean up any overflow or splashes before starting.

12. To inspect the underside of your mower, only tilt the lawnmower to your right when standing behind it (this is the side where the exhaust is near the ground) otherwise oil may leak into inappropriate areas of the engine. Never tilt the lawnmower when the engine is running.
13. Turn off the engine before emptying the grass-catcher, and before clearing any grass caught in the rear flap where the catcher fits.
14. Do not alter engine governing settings or over-rev the engine, as excessive speed is dangerous and can reduce engine life.
15. Never open the fuel filler cap, or fill the tank, if the engine is still hot after use. And please ensure that you securely tighten the petrol cap after filling.
16. Do not transport the mower in a vehicle if there is any petrol in the tank.
17. Store fuel and oil in a cool well-ventilated place, away from direct sunlight and not near gas cylinders or hot water heater systems.
18. Do not smoke when filling the fuel tank, using the machine, or when petrol is in the immediate area. And never use or store the mower near a naked flame.
19. Sanli recommends that you wear a safety helmet, ear protectors, safety goggles and safety boots when using a lawnmower.
20. All servicing and repair work under warranty must be carried out by an Authorised Sanli Dealer, otherwise the 2-year warranty may be void.

# Before you begin.

**WARNING!** The following procedures must be carried out before you start the engine of your lawnmower.

## 1. Fill oil sump with oil.

The mower is NOT supplied with oil in the engine, you have to add 600ml oil before starting the engine for the first time.

Firstly, remove the warning label from under the dipstick, then remove the dipstick and slowly pour 600ml oil into the engine via the oil filler. Replace the dipstick and tighten.

Before you use the mower each time, check the oil level and if necessary top up with SAE30 engine oil. To check the oil level, just unscrew the yellow dipstick, wipe with a rag and replace into the oil filler, but do not screw it back in place, and remove again. The oil level must be between the min and max marks on the dipstick.





## 2. Fill fuel tank with unleaded petrol.

Petrol is highly flammable so extreme caution must be taken when handling it. Always store petrol in approved containers and you must ensure that you use fresh petrol that is less than three months old. Do not mix oil with petrol.

To put petrol in the fuel tank, firstly remove the warning label from under the petrol cap. It's best to fill the tank using a clean funnel, but never fill it completely. Instead, leave at least 13mm from the bottom of the filler neck to allow for expansion. Ensure that you securely tighten the petrol cap after filling.



## 3. Attach the grass catcher.

The grass catcher attaches easily by lifting the mower's rear flap and inserting it.

Just lift the rear flap with one hand and then gently slide the catcher into position (as shown in photo on right).



## Cutting height adjustment.

**WARNING!** Turn mower off before adjusting cutting height lever.

Your lawnmower's height adjustment is positioned on the rear left side. There is a single 6-position lever that adjusts the front wheels and rear roller at the same time.

The lower the level, the shorter the cut. For very thick or moist grass, you should select a higher setting than usual to avoid clogging and stalling the lawnmower under the extra cutting load.



## Starting the engine.

**WARNING!** Keep hands, feet, and clothing well away from moving parts, the exhaust, and the engine cowling. Refer to 'Tips on mower safety' on pages 6 and 7 for more information.

1. Make sure that your mower is on a safe, flat area (a paved area or path is ideal – avoid thick wet grass and gravel surfaces) to make starting safe.
2. Move the throttle control lever located on the handle to the '1/2' position.
3. Slide the 'Red' petrol tap lever to the left 'On' position.
4. Firmly hold the top handle with one hand, and then with your other hand pull the cord slowly until you feel resistance. Then pull vigorously.
5. When the engine has been running for at least 15 seconds (more time on cold days) adjust the throttle control lever to the '2' position.
6. To re-start a hot engine, move the throttle control lever to the '2' position and then refer to 'Point 4' above.
7. To turn off your mower, slide the throttle control lever down to the 'Stop' position. After it has stopped, slide the 'Red' petrol tap lever to the right 'Off' position.

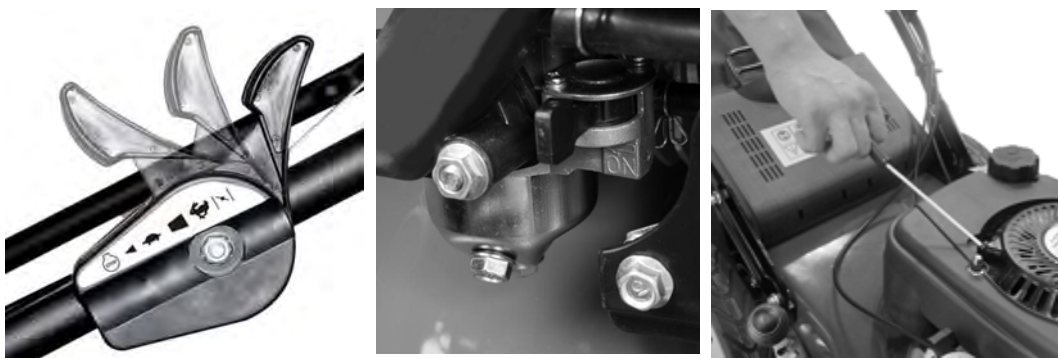

# Basic maintenance made easy.

**WARNING!** If your mower is not serviced correctly, you could reduce your mower's ability to operate and void warranty.

## 1. Spark plug.

Firstly, wait until the engine has cooled before disconnecting the spark plug cover and then removing the spark plug with the box spanner supplied. If it is dirty, you can clean the plug with a wire brush.

For best results we advise you to replace the spark plug after 100 hours of use. The replacement spark plug is NGK BPR 6ES. When refitting the spark plug do not over-tighten. If adjusting yourself, note the spark plug gap must be set to 0.75mm.

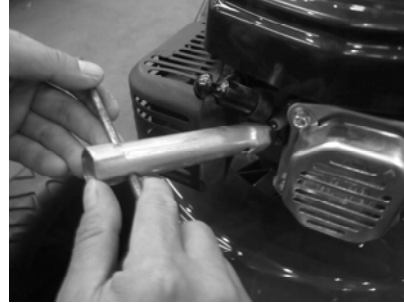

## 2. Air filter.

Ensure the engine is cool, unscrew the top air filter nut, lift up the cover and remove the air filter element. Put the cover back on the housing immediately to prevent any objects falling into the air intake.

Either carefully brush off any excess dirt particles, or replace the air filter with a new one. To protect your warranty, only use a genuine Sanli air filter. We recommend that you replace the air filter after every 12 months of regular usage. When the air filter has been cleaned or replaced, screw-in the cover, taking care not to over-tighten.

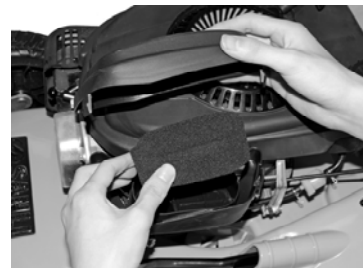

### 3. Oil changing.

Sanli recommends that you change your oil at least once a year. Also check your oil level before mowing every time to ensure that engine is being fully protected. Sanli mowers run on SAE30 engine oil.

### 4. Using and storing petrol.

After three months, unleaded petrol begins to break down and may make your lawnmower difficult to start. If during the colder months you have not mowed in a while, you should drain the remaining fuel and replace with fresh unleaded.

Remove the fuel cap, then release the spring clip on the black hose leading into the fuel filter and then disconnect the hose ensuring you squeeze it together firmly. Then release your grip on the hose to allow the fuel to drain out into an appropriate container.

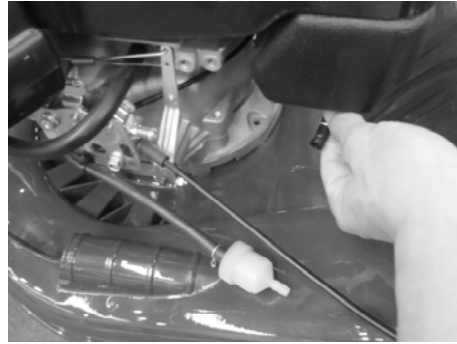

### 5. Cleaning ABS deck often.

As the ABS material can be marked by petrol, please clean the deck immediately whenever you find petrol on the deck or before storing.

## 6. Blades and cutting system.

Extreme care should be taken with blades. Ensure the mower is off and the spark plug lead disconnected from the spark plug, to prevent accidental ignition.

Remove the catcher set the cutting height lever to the highest level, and then hold up the rear flap in order to inspect your blades. Check every few months to make sure they are not damaged, loose, or overly worn. If loose, tighten, but not over-tighten, the nuts and bolts.

If you are planning to change the blades yourself, use thick work gloves and take extreme care at all times. A full range of parts is available from your Authorised Sanli Dealer.



## Technical specifications.

Model	LSP 430 P7R-1
Engine	Sanli 400 OHV, single cylinder, 4 stroke, air cooled
Displacement	135 cc
rated power	1.8 kW
Tank capacity	1.0 L
Engine oil capacity	0.6 L
Spark plug	NGK BPR 6ES
Rated speed	3100 rpm
Cutting width	430 mm
Adjustable cutting heights	6
Cutting height	21-77 mm
Grass collection capacity	55 litres
Noise level	96 dB (A)
Weight (including catcher)	35 kg
Chassis	ABS

# Fast trouble shooting

Often, a depleted, loose, or dirty spark plug is responsible for a mower not being able to start, but there can be a number of other reasons. Refer below to the list of potential problems you may encounter, along with suggested remedies. For servicing and all warranty work, contact your local Authorised Sanli Dealer.

Problem	Likely cause	Suggested remedy
	Throttle lever not set properly	Set to 'Cold Start' for cold or a little lower when warm
Engine does not start.	Out, or almost out, of fuel Spark plug depleted Spark plug dirty Spark plug not connected Flooded engine Old petrol in the tank Water in the fuel tank	Fill tank with unleaded petrol Replace with a suitable new spark plug Clean or replace with a new spark plug Press firmly on the terminal cover Turn fuel 'off' then zip until it starts, then turn 'on' Drain stale fuel and replace with new unleaded Contact an authorised Sanli dealer
Engine stops often	Blocked fuel supply Fuel cap is not venting Wrong type of fuel	Ensure the fuel line is not pinched or blocked You may need to slightly loosen the fuel cap Drain petrol tank and fill with new unleaded
Engine loses power	Dirty air cleaner filter Incorrect height adjustment Blocked fuel cap vent holes	Clean or replace with a new Sanli air-filter Raise the mower's cutting height lever Ensure the 3 holes in the fuel tank cap are clear
Mower vibrates too much	Loose cutting blade Bent or broken disc/blades Excessive grass/dirt build-up  Disc or blades worn/damaged	Check and tighten bolts and nuts Replace disc or blades Clean and ensure underside clear of build up  Replace disc or blades
Poor cutting catching	Catcher not fitted correctly Incorrect cutting height set Blocked grass catcher vents	Reattach carefully and also check for damage Adjust the cutting height Clear and clean the vents Reinsert carefully and also check for damage

# Warranty conditions

For full warranty conditions please contact the domestic office as listed on page 1 or local dealer where you purchased the machine from.

Please note that your warranty is affected by terms and conditions. Read on to fully understand what is covered by the warranty and what is not covered. Those items not covered by the warranty are the responsibility of the owner and any repairs will be at the owner's expense.

The warranty does not affect your statutory rights or remedies as outlined in applicable consumer legislation.

Sanli provides an express warranty for this product for a period of 2 years from your original purchase date with the exception of commercial-use which is for a period of 90 days. The warranty is not transferable and is only applicable to the original purchaser that can provide original proof of purchase.

Defective parts will be replaced or repaired by an Authorised Sanli Dealer without charge for labour or materials, subject to conditions. Repairs or adjustments required by failure to follow the manufacturer's instructions are chargeable to the owner.

This express warranty does not cover;

- Intentional or unintentional misuse, abuse or breakages
- Normal wear and tear
- Oiled air cleaner or starting difficulty caused by mower incorrectly tipped on its side
- Consumable items (including oil, blades and spark plugs)
- Defects or faults caused by an act or omission after leaving manufacture
- Incorrect, contaminated or poor quality fuel (older than 3 months) or oil
- Incorrect maintenance or storage of the product
- Water damage or environmental conditions
- Failure to observe safety requirements
- Any loss or damage arising from faulty parts or workmanship

The warranty will become void if any unauthorised person dismantles, repairs, or modifies the product.



## EC DECLARATION OF CONFORMITY

Fujian Jinjiang Sanli Engine Co., Ltd.

Declares that the following equipment manufactured by Fujian Jinjiang Sanli Engine Co.,Ltd conforms to the following Directive(s):2006/42/EC,2004/108/EC and 2000/14/EC of the European Parliament and of the council on the approximation of the laws of the Member States relating to the noise emission in the environment by equipment for use outdoors.

Equipment Category – Lawn Mower

Product Name/Model:Lawn Mower/ LSP 430 P7R,LSPR42

Type/Serial No.: N/A

Cutting Width: 43 cm

Net installed power:4 HP

The technical documentation is kept by:

Name:Mr.Liu Qingguo

Company: Fujian Jinjiang Sanli Engine Co., Ltd

Address: Wuli Industrial Park, Jinjiang, Fujian, 362263,P.R.China

The conformity assessment procedure followed was in accordance with annex VI of the Directive 2000/14/EC,and the Directive 2005/88/EC.

Notified Body:

TÜV SÜD Product Service GmbH- Ridlerstrasse 65-80339 MÜNchen (Germany)

TÜV SÜD Product Service GmbH- Westendstrasse 65-80686 MÜNchen (Germany)

Measured Sound Power Level: 92dB(A)

Guaranteed Sound Power Level: 96dB(A)

A copy of this certificate has been submitted to the European Commission and to EU Member State UK.

Place of Declaration: Wuli Industrial Park, Jinjiang, Fujian, 362263,P.R.China

Date: 28/11/2011

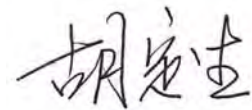

Signed by: Mr.Hu Dingsheng

Position in Company : General Engineer

Name and address of manufacturer or Authorised representative:

Fujian Jinjiang Sanli Engine Co.,Ltd.

Wuli Industrial Park, Jinjiang, Fujian, 362263,P.R.China





**SANLI** |

LSP 430 P7R(LSPR42)

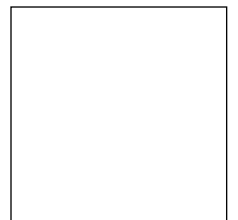
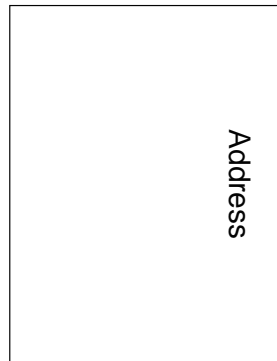
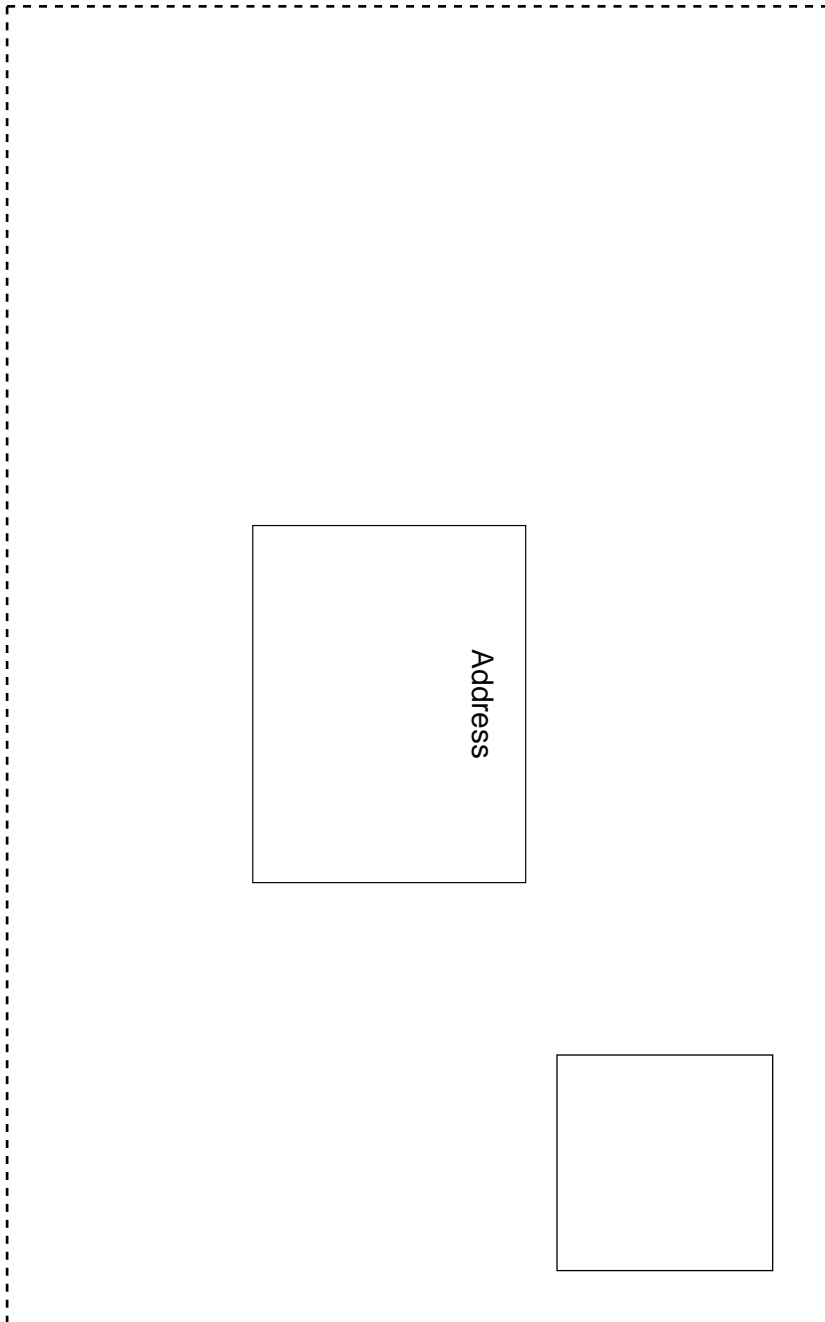

# WARRANTY CARD

## REGISTER YOUR MACHINE TO VALIDATE YOUR WARRANTY.

To validate your warranty, register your equipment with SANLI after its purchase by returning the warranty card provided at the back of the user's manual or on the website [www.sanli.co.uk/register](http://www.sanli.co.uk/register), [www.sanli.fr](http://www.sanli.fr), [www.sanli.com.au](http://www.sanli.com.au)

### Reference

**LSP 430 P7R(LSPR42)**

Serial Number  
S/N



• Guarantee •

### KEEP THIS PART Reference

**LSP 430 P7R(LSPR42)**

Purchase date

**Sanli UK Ltd**  
Unit 200 Milton Park Estate  
Abingdon Oxfordshire OX14 4TB  
[www.sanli.co.uk](http://www.sanli.co.uk)

**SANLI FRANCE SAS**  
Service garantie 10,Rue  
Gutenberg 67610 LAWANTZENAU  
[www.sanli.fr](http://www.sanli.fr)

**Sanli Australia Development P/L**  
9 Gatwood Close, Padstow  
NSW 2211  
[www.sanli.com.au](http://www.sanli.com.au)

Serial Number  
S/N

#### By signing, the user certifies that:

- the instructions were provided and he/she has read the instructions regarding use, safety and maintenance;
- he/she has been provided with instructions to use the machine safely and correctly by the seller;
- he/she is aware of the conditions governing the guarantee contract and accepts them without reservation or restriction.

USER

Surname

First name

Address

Town

Postcode

Country

Tel

Mobile

Email

Customer No:

Imprint / Company Name

Address

Town

Postcode

DISTRIBUTOR

Check this box if you do not want to receive any commercial or technical information from SANLI.

Purchase date

Signature