

Operation



Visit our website;  
<http://Magnum.Graco.com>

# Airless Sprayers

## 309225W

*- For portable spray applications of architectural paints and coatings -  
(Specifications, page 2.)*

**US Patent 6,752,067**  
**European Patent 1 208 287**  
**Korean Patent 10-0668583**

--	--	--	--	--	--	--	--

Use water based or mineral spirit-type material only. Do not use materials having flash points lower than 70°F (21°C). For more information about your material request MSDS from distributor or retailer.



**IMPORTANT SAFETY INSTRUCTIONS.**  
Read all warnings and instructions in this manual. Save these instructions. See page 2 for model and series information including dispense rate, recommended hose length, guns, and maximum working pressure.

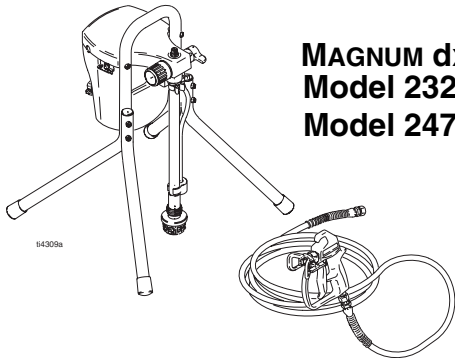

**MAGNUM dx**  
**Model 232735**  
**Model 247328**

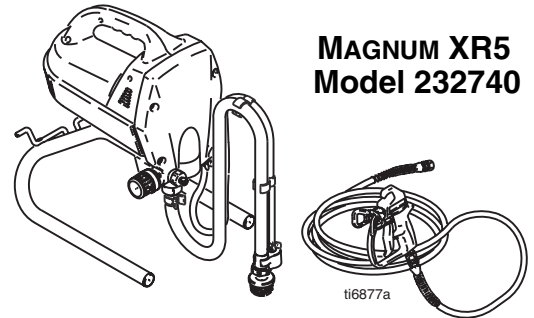

**MAGNUM XR5**  
**Model 232740**

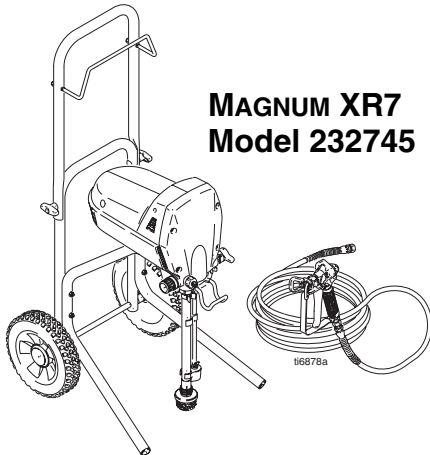

**MAGNUM XR7**  
**Model 232745**

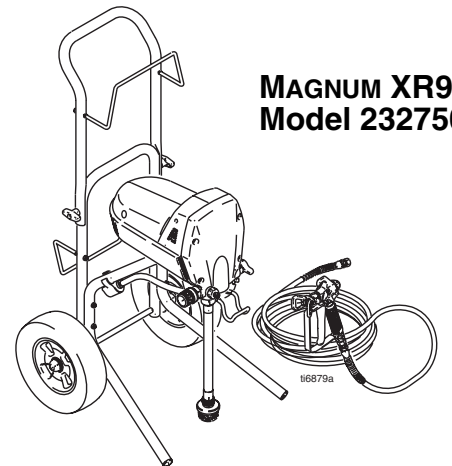

**MAGNUM XR9**  
**Model 232750**

PROVEN QUALITY. LEADING TECHNOLOGY.

Graco Inc. P.O. Box 1441 Minneapolis, MN 55440-1441  
Copyright 2004, Graco Inc. is registered to I.S. EN ISO 9001



## Models





Model Name, Model No.	Series	Dispense Rate gpm (lpm)	Hose Length and Diameter	Gun Model	Maximum Working Pressure		
					PSI	MPa	bar
<b>Magnum dx 232735</b>	C	0.24 gpm (0.91 lpm)	3/16 in. x 25 ft (4.8 mm x 8 m)	SG1™- EF	2800	19	193
<b>Magnum dx 247328</b>	–	0.24 gpm (0.91 lpm)	3/16 in. x 25 ft (4.8 mm x 8 m)	SG1™- EF	2800	19	193
<b>Magnum XR5 232740</b>	E	0.27 gpm (1.02 lpm)	1/4 in. x 25 ft (6.3 mm x 8 m)	SG1™ - EF	3000	21	207
<b>Magnum XR7 232745</b>	D	0.31 gpm (1.17 lpm)	1/4 in. X 50 ft (6.3 mm x 15 m)	SG2™	3000	21	207
<b>Magnum XR9 232750</b>	D	0.38 gpm (1.44 lpm)	1/4 in. X 50 ft (6.3 mm x 15 m)	SG3™	3000	21	207

## Specifications





This equipment is not intended for use with flammable or combustible materials used in places such as cabinet shops or other “factory”, or fixed locations. If you intend to use this equipment in this type of application, you must comply with NFPA 33 and OSHA requirements for the use of flammable and combustible materials.

## Warnings

The following are general warnings related to the setup, use, grounding, maintenance and repair of this equipment. Additional, more specific warnings may be found throughout the body of this manual where applicable. Symbols appearing in the body of the manual refer to these general warnings. When these symbols appear throughout the manual, refer back to these pages for a description of the specific hazard.

 <b>WARNING</b>	
	<p><b>FIRE AND EXPLOSION HAZARD</b></p> <p>Flammable fumes, such as solvent and paint fumes, in work area can ignite or explode. To help prevent fire and explosion:</p> <ul style="list-style-type: none"> <li>• Use equipment only in well ventilated area.</li> <li>• Eliminate all ignition sources; such as pilot lights, cigarettes, portable electric lamps, and plastic drop cloths (potential static arc).</li> <li>• Sprayer generates sparks. When flammable liquid is used in or near the sprayer or for flushing or cleaning, keep sprayer at least 20 feet (6 m) away from explosive vapors.</li> <li>• Keep work area free of debris, including solvent, rags and gasoline.</li> <li>• Do not plug or unplug power cords or turn lights on or off when flammable fumes are present.</li> <li>• Ground equipment and conductive objects in work area. Read <b>Grounding</b> instructions.</li> <li>• If there is static sparking or you feel a shock, <b>stop operation immediately</b>. Do not use equipment until you identify and correct the problem.</li> <li>• Keep a fire extinguisher in the work area.</li> </ul>
	<p><b>ELECTRIC SHOCK HAZARD</b></p> <p>Improper grounding, setup, or usage of the system can cause electric shock.</p> <ul style="list-style-type: none"> <li>• Turn off and disconnect power cord before servicing equipment.</li> <li>• Use only grounded electrical outlets.</li> <li>• Use only 3-wire extension cords.</li> <li>• Ensure ground prongs are intact on sprayer and extension cords.</li> <li>• Do not expose to rain. Store indoors.</li> </ul>
	<p><b>SKIN INJECTION HAZARD</b></p> <p>High-pressure fluid from gun, hose leaks, or ruptured components will pierce skin. This may look like just a cut, but it is a serious injury that can result in amputation. <b>Get immediate surgical treatment.</b></p> <ul style="list-style-type: none"> <li>• Do not point gun at anyone or at any part of the body.</li> <li>• Do not put your hand over the spray tip.</li> <li>• Do not stop or deflect leaks with your hand, body, glove, or rag.</li> <li>• Engage trigger lock when not spraying.</li> <li>• Follow <b>Pressure Relief Procedure</b> in this manual, when you stop spraying and before cleaning, checking, or servicing equipment.</li> </ul>

**⚠ WARNING**

	<p><b>EQUIPMENT MISUSE HAZARD</b></p> <p>Misuse can cause death or serious injury.</p> <ul style="list-style-type: none"> <li>• Do not exceed the maximum working pressure or temperature rating of the lowest rated system component. Read <b>Technical Data</b> in all equipment manuals.</li> <li>• Use fluids and solvents that are compatible with equipment wetted parts. Read <b>Technical Data</b> in all equipment manuals. Read fluid and solvent manufacturer's warnings. For complete information about your material, request MSDS from distributor or retailer.</li> <li>• Check equipment daily. Repair or replace worn or damaged parts immediately with genuine Graco replacement parts only.</li> <li>• Do not alter or modify equipment.</li> <li>• Use equipment only for its intended purpose. Call your Graco distributor for information.</li> <li>• Route hoses and cables away from traffic areas, sharp edges, moving parts, and hot surfaces.</li> <li>• Do not kink or overbend hoses or use hoses to pull equipment.</li> <li>• Comply with all applicable safety regulations.</li> <li>• Keep children and animals away from work area.</li> <li>• Do not operate the unity when fatigued or under the influence of drugs or alcohol.</li> </ul>
	<p><b>PRESSURIZED ALUMINUM PARTS HAZARD</b></p> <p>Do not use 1,1,1-trichloroethane, methylene chloride, other halogenated hydrocarbon solvents or fluids containing such solvents in pressurized aluminum equipment. Such use can cause serious chemical reaction and equipment rupture, and result in death, serious injury, and property damage.</p>
	<p><b>TOXIC FLUID OR FUMES HAZARD</b></p> <p>Toxic fluids or fumes can cause serious injury or death if splashed in the eyes or on skin, inhaled, or swallowed.</p> <ul style="list-style-type: none"> <li>• Read MSDS's to know the specific hazards of the fluids you are using.</li> <li>• Store hazardous fluid in approved containers, and dispose of it according to applicable guidelines.</li> </ul>
	<p><b>PERSONAL PROTECTIVE EQUIPMENT</b></p> <p>You must wear appropriate protective equipment when operating, servicing, or when in the operating area of the equipment to help protect you from serious injury, including eye injury, inhalation of toxic fumes, burns, and hearing loss. This equipment includes but is not limited to:</p> <ul style="list-style-type: none"> <li>• Protective eye wear</li> <li>• Clothing and respirator as recommended by the fluid and solvent manufacturer</li> <li>• Gloves</li> <li>• Hearing protection</li> </ul>

# Installation

## Grounding and Electric Requirements



Sprayer must be grounded. Grounding reduces the risk of static and electric shock by providing an escape wire for electrical current due to static build up or in the event of a short circuit.

The 120 Vac sprayers require a 120 Vac, 60 Hz, 15A circuit with a grounding receptacle. The 230 Vac Model 247328 requires

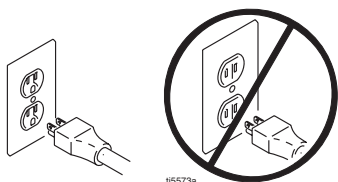

230 Vac, 50 Hz, 10A with a grounding receptacle, Never use an outlet that is not grounded or an adapter.

Do not use the sprayer if the electrical cord has a damaged ground prong.

Only use an extension cord with an undamaged 3-prong plug. Recommended extension cords for use with this sprayer:



- 25 ft (7.6 m) 18 AWG (1.0 mm<sup>2</sup>)
- 50 ft (15.2 m) 16 AWG (1.0 mm<sup>2</sup>)
- 100 ft (30.5 m) 14 AWG (1.5 mm<sup>2</sup>)
- 150 ft (45.7 m) 12 AWG (2.5 mm<sup>2</sup>)

**Spray gun:** ground through connection to a properly grounded fluid hose and pump.



Smaller gauge or longer extension cords may reduce sprayer performance.

**Fluid supply container:** follow local code.

**Solvent pails used when flushing:** follow local code. Use only conductive metal pails, placed on a grounded surface such as concrete. Do not place the pail on a nonconductive surface, such as paper or cardboard, which interrupts grounding continuity.

**Grounding the metal pail:** connect a ground wire to the pail by clamping one end to pail and other end to ground such as a water pipe.

**Maintaining grounding continuity when flushing or relieving pressure:** hold metal part of the spray gun firmly to the side of a grounded metal pail, then trigger the gun.

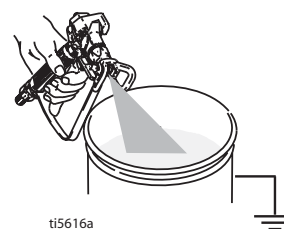

## Thermal Overload

Motor has a thermal overload switch to shut itself down if overheated.

To reduce risk of injury from motor starting unexpectedly when it cools, always turn power switch OFF if motor shuts down.									

## Component Identification

A	Electric motor (inside enclosures)	Provides mechanical power to pump.
B	Power switch	Turns ON and OFF electric motor power (I is ON 0 is OFF).
C	Pressure control knob	Increases (clockwise) and decreases (counter-clockwise) fluid pressure in pump, hose, and spray gun.
D	Pump fluid outlet fitting	Threaded connection for paint hose.
E	InstaClean™ fluid filter (XR models only)	<ul style="list-style-type: none"> <li>Filters fluid coming out of pump to reduce tip plugging and improve finish.</li> <li>Self cleans only during pressure relief.</li> </ul>
F	Power-Piston™ pump (behind Easy Access door) (XR models only)	Pumps and pressurizes fluid and delivers it to paint hose. Easy Access door permits quick removal of outlet valve.
G	Suction tube	Draws fluid from paint pail into pump.
H	Prime tube (with diffuser)	Drains fluid in system during priming and pressure relief.
J	Spray- Prime/Drain valve control	<ul style="list-style-type: none"> <li>In SPRAY position (pointing forward) directs pressurized fluid to paint hose.</li> <li>In PRIME/DRAIN position (pointing down) directs fluid to drain tube.</li> <li>Automatically relieves system pressure in overpressure situations.</li> </ul>
K	Fluid inlet connection/ inlet valve	Suction tube connection to pump and inlet valve.
L	Inlet screen	Prevents debris from entering pump.
M	Paint hose	Transports high-pressure fluid from pump to spray gun.
N	Cord wrap bracket	Stows electrical cord (XR5 model only).
P	Airless spray gun	Dispenses pumped fluid.
Q	Tip guard	Reduces risk of fluid injection injury.
R	Reversible spray tip	<ul style="list-style-type: none"> <li>Atomizes fluid being sprayed, forms spray pattern and controls fluid flow according to hole size.</li> <li>Reverse unclogs plugged tips without disassembly.</li> </ul>
S	Trigger safety lever	Prevents accidental triggering of spray gun.
T	Gun fluid inlet fitting	Threaded connection for paint hose.
U	Smooth Glide™ swivel (SG3 only)	Allows spray gun to swivel without twisting paint hose.
V	Gun fluid filter (in handle)	Filters fluid entering spray gun to reduce tip clogs.
W	Hose/cord wrap bracket	Stows paint hose and electrical cord (XR7 and XR9 models only).
X	Pail hanger	For transporting pail by its handle (XR7 and XR9 models only).
Y	Power Flush attachment (included)	Connects garden hose to suction tube for power flushing water-base fluids.

# Sprayers

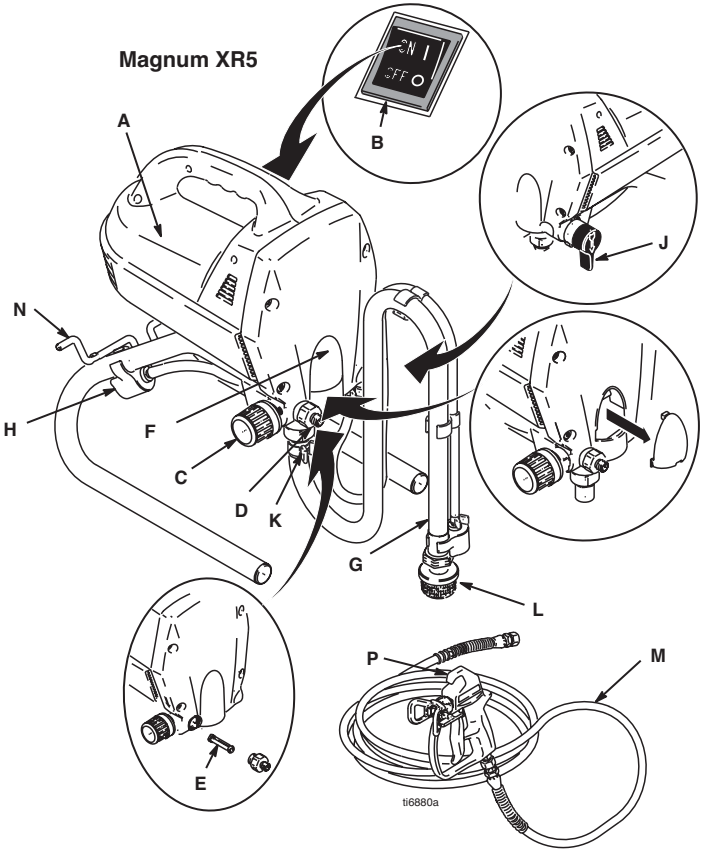
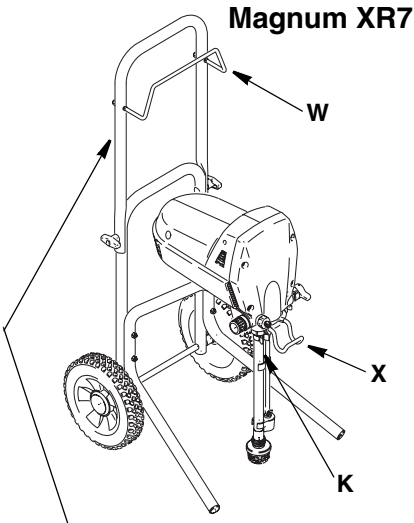

Connect cart handle on XR7 and XR9 as follows:

1. Position handle on frame and align bolt holes in frame.
2. Run bolts through holes with heads pointing toward each other and hand tighten wingnuts.

NOTE: For space-saving configuration, loose, (but do not remove) wingnuts. Fold handle forward over sprayer shroud.

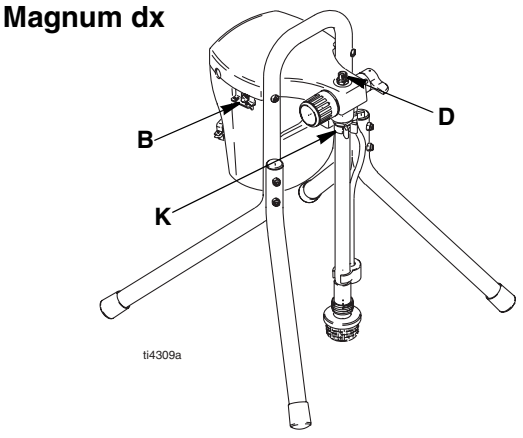
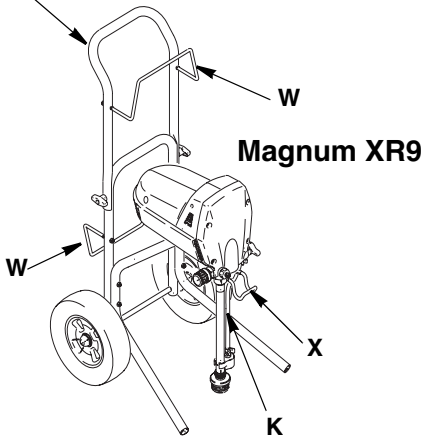

# Spray Guns

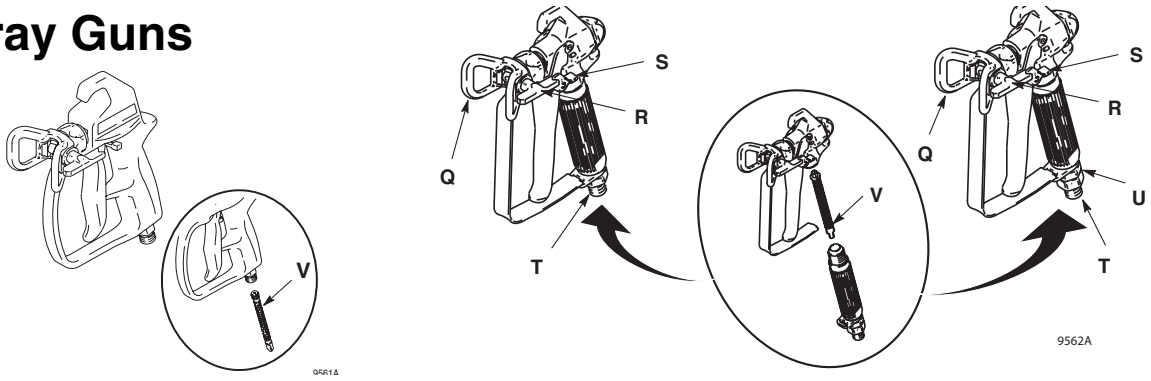

# Operation

## Pressure Relief Procedure

Follow **Pressure Relief Procedure** when you stop spraying and before cleaning, checking, servicing, or transporting equipment. Read **Injection Warning**, page 3.



1. Turn power switch (B) OFF and unplug power cord.

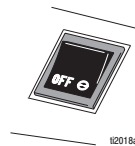

2. Turn Spray-Prime/Drain valve (J) to PRIME to relieve pressure.



3. Hold a metal part of the gun firmly to a grounded metal pail. Trigger the gun to relieve pressure.

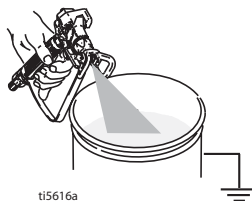

4. Engage trigger lock. See Trigger Lock, page 8.

 Leave Spray-Prime/Drain valve in the PRIME position until you are ready to spray again.

If you suspect the spray tip or hose is clogged or that pressure has not been fully relieved after following the steps above, **VERY SLOWLY** loosen tip guard retaining nut or hose end coupling to relieve pressure gradually, then loosen completely. Clear hose or tip obstruction. Read Unclogging Spray Tip, page 12.

## Trigger Lock

Always engage the trigger lock when you stop spraying to prevent the gun from being triggered accidentally by hand or if dropped or bumped.

Trigger Locked Position

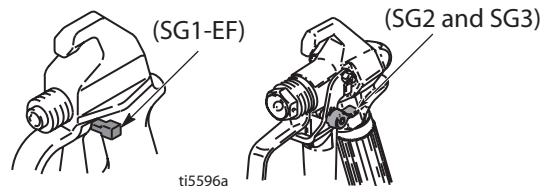

## Pressure Control Knob Settings

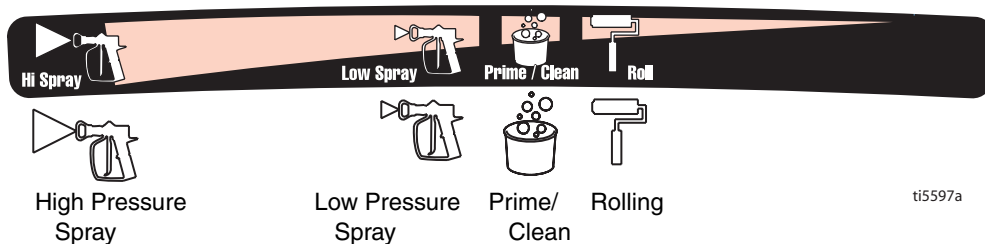

 To select function, align arrow on sprayer within range of function symbol on pressure control knob.



# Setup

1. Unscrew tip and guard assembly from gun.

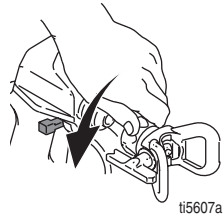

2. Uncoil hose and connect one end to gun.

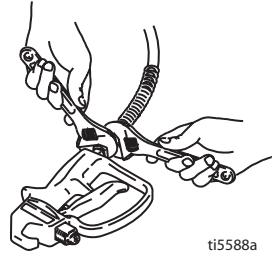

3. Connect other end of hose to sprayer.

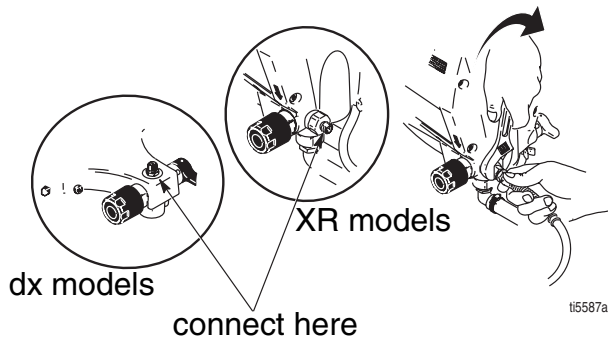

 If hose is already connected, make sure connections are tight.

4. Turn OFF power switch.



5. Turn Pressure Control Knob all the way left (counter-clockwise) to minimum pressure.

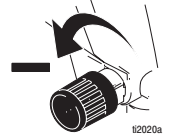

# Priming

## Oil- or Water-based Materials

 To spray **lacquers**, purchase **Lacquer Conversion Kit 248202**, and follow Priming procedure for oil-based materials.

To spray **water-based** materials **after spraying oil-based** materials, flush the system thoroughly with water first. The water flowing out of prime tube should be clear and solvent-free **before** you begin spraying the water-based material.

To spray **oil-based** materials **after spraying water-based** materials, flush the system thoroughly with mineral spirits or a compatible oil-based flushing solvent first. The solvent flowing out of the prime tube should not contain any water.



- When spraying with solvents, ground gun. Read Grounding and Electric Requirements, Maintaining grounding continuity, page 5.
- To avoid fluid splashing back on your skin or into your eyes, always aim gun at inside wall of pail.

1. Turn Spray-Prime/Drain valve to PRIME.



2. Separate prime tube (smaller) from suction tube (larger).

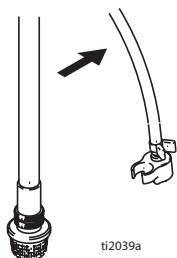

3. Place prime tube in waste pail.



4. If spraying oil-based materials, submerge suction tube in mineral spirits or compatible oil-based cleaning solvent.

If spraying water-based materials, submerge suction tube in water.

5. Plug sprayer in to grounded outlet.

6. Point gun into waste pail.

7. Turn power switch ON.



8. Increase pressure, by turning Pressure Control knob clockwise, until pump starts.

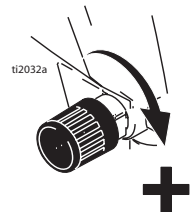

9. Allow fluid to flow out of prime tube, into waste pail for 30 to 60 seconds.

10. Turn power switch OFF.

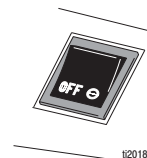

11. Submerge suction tube in paint.

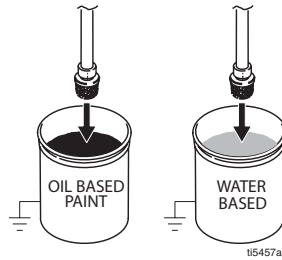

12. Turn power switch ON.



13. When paint starts to come out of prime tube, aim gun toward waste pail, pull and hold gun trigger and turn Spray-Prime/Drain valve to SPRAY.



 Motor stopping indicates pump and hose are primed with paint.

14. When paint comes out of gun, release trigger.

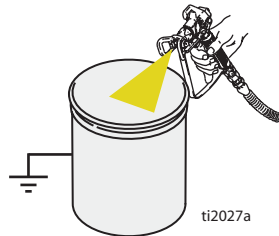

15. Clip drain tube to suction tube.

 If the pump does not prime after 30 seconds, Read Pump Check Valves, page 11.

## Pump Check Valves

Storing pump in water, adequate flushing, or ingested debris can cause either of the pump's two check valves to malfunction. Try to loosen the check balls loose by tapping the inlet valve with a small wrench. The sprayer should be on and running.

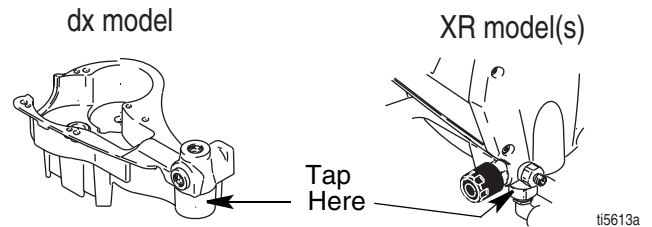

### CAUTION

Excessive shock will fracture or cause other damage to the pump.

 To determine if the inlet valve ball is sticking, unscrew inlet valve from pump and check it. MAGNUM XR7 and XR9 sprayers allow for inlet valve removal without removing suction tube.

If sprayer continues to cycle (motor and pump run) after you release gun trigger, the pump valves may be obstructed or worn. If they are worn, valve repair kits are available. Consult a Graco/MAGNUM authorized service center.

# Installing Tip and Base



1. Engage trigger lock.

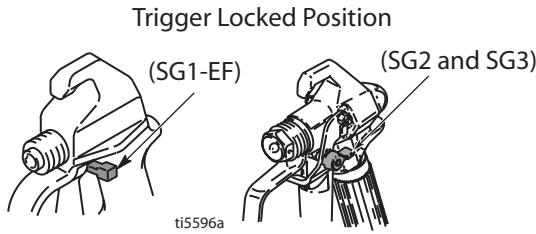

2. Verify tip and guard parts are assembled in order shown.

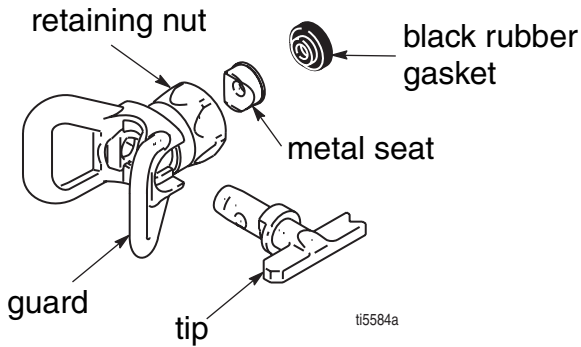

Use tip to align seat in guard.

Tip must be pushed all the way into guard

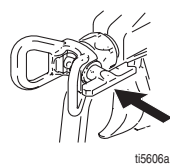
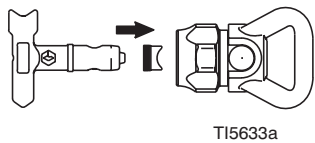

3. Screw tip and guard assembly on gun. Tighten retaining nut.

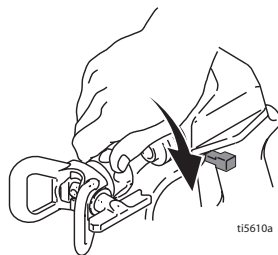

# Unclogging Spray Tip



To avoid fluid splashback:

- Never pull gun trigger when arrow-shaped handle is between SPRAY and UNCLOG positions.
- Tip must be pushed all the way into guard.

1. To UNCLOG tip obstruction, point arrow-shaped handle backward to UNCLOG position.

2. Aim gun at piece of scrap or cardboard.

3. Pull trigger to clear clog.

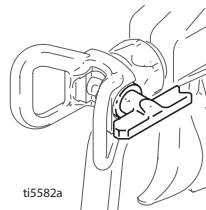

SPRAY position  
(pull trigger to paint)

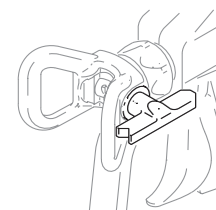

UNCLOG position  
(pull trigger to clear clogged tip)

Point the arrow-shaped handle on the spray tip attachment forward to SPRAY and backward to UNCLOG obstructions.

# Tip Selection

## Selecting Tip Hole Size

Tips come in a variety of hole sizes for spraying a range of fluids. Your sprayer includes an 0.015 in (0.38 mm) tip for use in most spraying applications. Use the following table to determine the range of recommended tip hole sizes for each fluid type. If you need a tip other than the one supplied, see the **Reversible Tip Selection Chart** on page 14.

### HINTS:

- As you spray, the tip wears and enlarges. Starting with a tip hole size smaller than the maximum will allow you to spray within the rated flow capacity of the sprayer.
- Maximum tip hole sizes supported by the sprayer:
  - dx: 0.015 in. (0.38 mm)
  - XR5: 0.015 in. (0.38 mm)
  - XR7: 0.017 in. (0.43 mm)
  - XR9: 0.019 in. (0.48 mm)

Tip Hole Size (expressed as diameter, based on area of elliptical orifice)	Coatings					
	<i>Stains</i>	<i>Enamels</i>	<i>Oil-base primers and paints</i>	<i>Interior latex paints</i>	<i>Exterior latex paints</i>	<i>Acrylics</i>
0.011 in. (0.28 mm)	✓					
0.013 in. (0.33 mm)	✓	✓	✓	✓		
0.015 in. (0.38 mm)		✓	✓	✓	✓	
0.017 in. (0.43 mm)			✓	✓	✓	✓
0.019 in. (0.48 mm)					✓	✓

## Reversible Tip Selection Chart

Tip Part No.	Fan Width 12 in. (305 mm) from surface	Hole Size
221311	6 - 8 in. (152 - 203 mm)	0.011 in. (0.28 mm)
221411	8 - 10 in. (203 - 254 mm)	0.011 in. (0.28 mm)
221313	6 - 8 in. (152 - 203 mm)	0.013 in. (0.33 mm)
221413	8 - 10 in. (203 - 254 mm)	0.013 in. (0.33 mm)
221415	8 - 10 in. (203 - 254 mm)	0.015 in. (0.38 mm)
221515	10 - 12 in. (254 - 305mm)	0.015 in. (0.38 mm)
221417	8 - 10 in. (203 - 254 mm)	0.017 in. (0.43 mm)
221517	10 - 12 in. (254 - 305 mm)	0.017 in. (0.43 mm)
221519	10 - 12 in. (254 - 305 mm)	0.019 in. (0.48 mm)
221619	12 - 14 in. (305 - 356 mm)	0.019 in. (0.48 mm)

**Example:** For an 8 to 10 in. (203 to 254 mm) fan width and 0.013 (0.33 mm) hole size, order Part No. 221413.

## Choosing the Correct Tip for the Job

Consider coating and surface to be sprayed. Make sure you use best tip hole size for that coating and best fan width for that surface.

### Tip Hole Size

Tip hole size controls flow rate - the amount of paint that comes out of the gun.

### HINTS:

- Use larger tip hole sizes with thicker coatings and smaller tip hole sizes with thinner coatings.
- Maximum tip hole sizes supported by sprayer:
  - dx: 0.015 in. (0.38 mm)
  - XR5: 0.015 in. (0.38 mm)
  - XR7: 0.017 in. (0.43 mm)
  - XR9: 0.019 in. (0.48 mm)
- Tips wear with use and need periodic replacement.

### Fan Width

Fan width is the size of the spray pattern, which determines the area covered with each stroke. Narrower fans deliver a thicker coat, and wider fans deliver a thinner coat.

### HINTS:

- Select a fan width best suited to the surface being sprayed.
- Wider fans allow provide better coverage on broad, open surfaces.
- Narrower fans provide better control on small, confined surfaces.

## Understanding Tip Number

The last three digits of tip number (i.e.: 221413) contain information about hole size and fan width on surface when gun is held 12 in. (30.5 cm) from surface being sprayed.

First digit when doubled = approximate fan width.

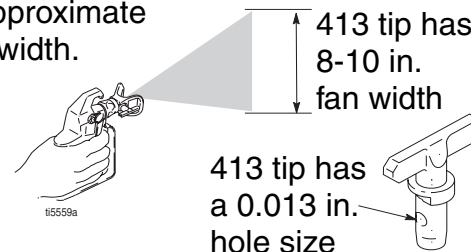

Last two digits = tip hole size in thousands of an inch.

# Spraying Techniques

This sprayer is set up for most airless spraying applications. Details on tip selection, tip wear, coat thickness, etc. are provided on page 13.



Motor only runs when gun is triggered.  
Sprayer is designed to stop pumping when gun trigger is released.

## Preventing Excessive Tip Wear

- Spray should be atomized (evenly distributed, no gaps at edges). Start at low pressure setting, increase pressure a little at a time until you see a good spray pattern, without tails.
- Spray at lowest pressure that atomizes paint.
- If maximum sprayer pressure is not enough for a good spray pattern, tip is too worn. See Reversible Spray Tip Selection Chart, page 14.

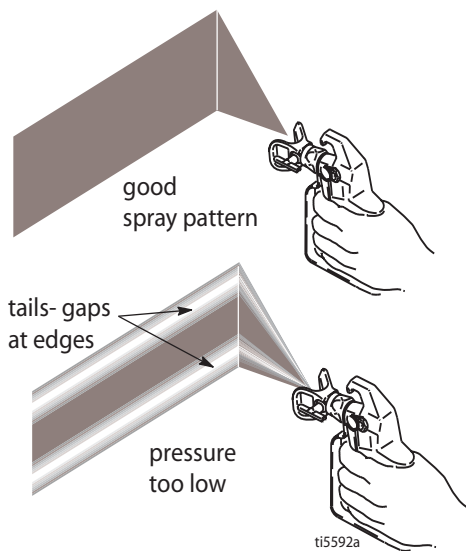

If tails persist when spraying at the highest pressure, a larger tip is needed or the material may need to be thinned.

## Adjusting Pressure

Align arrow on sprayer with function symbol on Pressure Control knob, page 11.

- Turning knob to right (clockwise) increases pressure at gun.
- Turning it left (counter-clockwise) decreases pressure.

## Getting Started With Basic Techniques

Practice spraying on a piece of scrap or cardboard before you begin spraying.

- Hold gun 12 in. (30 cm) from surface and aim straight at surface. Tilting gun to direct spray angle causes an uneven finish.

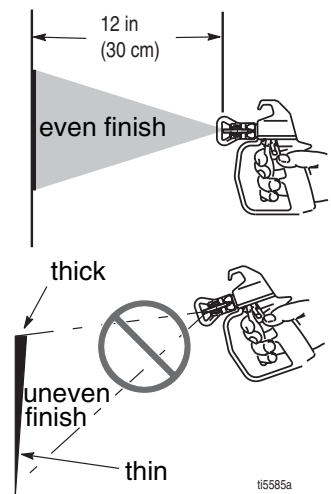

- Flex wrist to keep gun pointed straight. Fanning gun to direct spray at angle causes uneven finish.

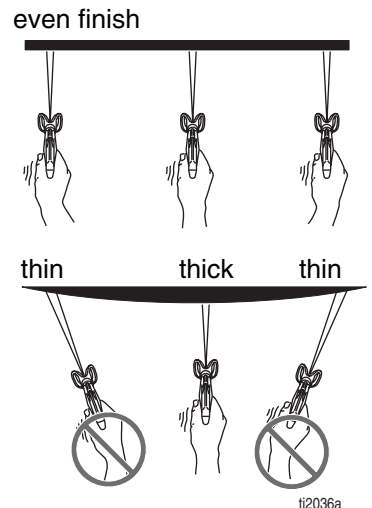

## Triggering Gun

Pull trigger after starting stroke. Release trigger before end of stroke. Gun must be moving when trigger is pulled and released.

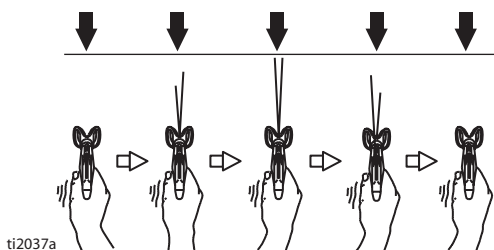

## Aiming Gun

Aim tip of gun at bottom edge of previous stroke, overlapping each stroke by half.

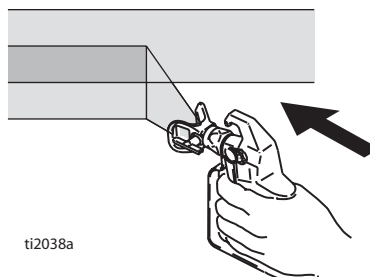

## Shutdown and Cleaning

 If spraying **lacquers**, purchase **Lacquer Conversion Kit 248202**. Follow Shutdown and Cleaning procedures for oil-based materials.

## Pail Flushing

-  For short term shutdown periods (up to 2 days) refer to Short Term Storage, page 20.
- For flushing after spraying oil-based coatings, use compatible oil-based flushing fluid or mineral spirits. Read Priming, Oil- or Water-based Materials, page 10.
- For flushing after spraying water-based coatings, use water. Read Priming, Oil- or Water-based Materials, page 10 or Power Flush, page 17.



1. Turn power switch OFF. Lift suction tube and prime tube from paint pail. Let them drain into paint for a while.

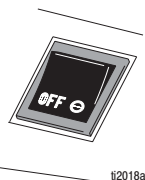

2. Place suction tube in pail filled with flushing fluid and place prime tube in waste pail.

3. Turn Spray-Prime/Drain Valve to PRIME.



4. Turn Pressure Control knob to the left (counter-clockwise) to minimum pressure.

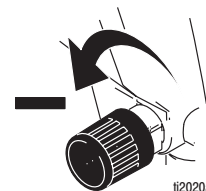

5. Trigger gun into waste pail to relieve pressure in hose.

6. Remove tip and guard assembly from gun and place in flushing fluid.

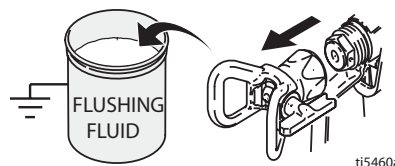



- Turn power switch ON.



- Slowly align arrow on sprayer with Pail symbol on Pressure Control knob until pump starts.

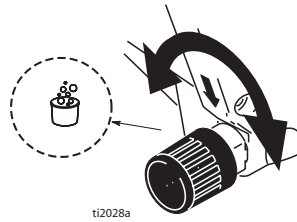

- Flush until approximately 1/3 of the flushing fluid is emptied from the pail.

- Turn power switch OFF. Turn Spray-Prime/Drain valve to SPRAY.



- To preserve paint in hose, trigger gun into paint pail to expel the remaining paint.

- Turn power switch ON. Continue to trigger gun until you see flushing fluid starting to come out of gun nozzle. Release trigger.

- Move gun to waste pail and trigger it to flush pump, hose and gun into waste pail. Continue until remaining flushing fluid is gone from flushing fluid pail.

- Fill unit with Pump Armor™ storage fluid. Read Long Term Storage, page 20.

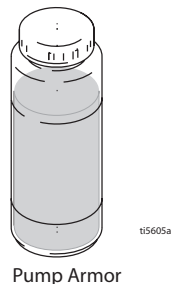

## Power Flush

Power flushing is a faster method of flushing. It can only be used after spraying water-based coatings.



- Turn power switch OFF. Lift suction tube and prime tube from paint pail. Let them drain into paint for a while.

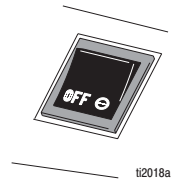

- Place suction and prime tube in waste pail.

- Turn Spray-Prime/Drain Valve to PRIME.



- Turn Pressure Control knob to the left (counter-clockwise) to minimum pressure.

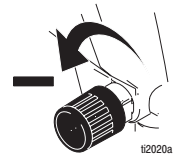

- Trigger gun into waste pail to relieve pressure in hose.

- Remove tip and guard assembly from gun and place in flushing fluid.

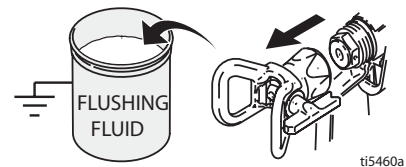

- Screw power flush attachment to garden hose. Open valve.

- Turn on water. Rinse paint off suction tube, prime tube and inlet screen.

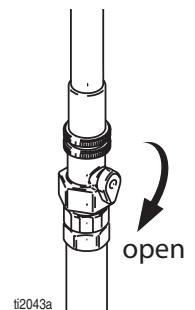

## Shutdown and Cleaning

9. Turn lever to close power flush attachment.

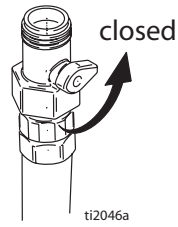

10. Unscrew inlet screen from suction tube. Place inlet screen in waste pail.

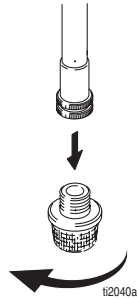

11. Connect garden hose to suction tube with Power Flush attachment. Leave prime tube in waste pail.



12. Turn Spray-Prime/Drain valve to SPRAY.



13. Align arrow on sprayer with pail symbol on Pressure Control knob until pump starts.

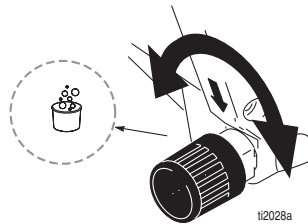

14. Open lever on Power Flush attachment.

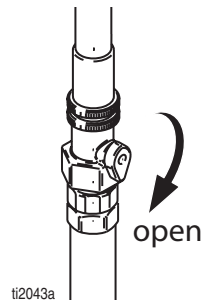

 Step 15 is for returning paint in hose back to paint pail. One 50-ft (15-m) hose holds approximately 1-quart (1-liter) of paint.

- 15.
- Pull and hold gun trigger. Point gun into paint pail.
  - Turn power switch ON to begin pumping paint in hose back into paint pail.
  - When water comes out of gun, continue to trigger gun, aiming gun into waste pail.

16. Continue triggering gun into waste pail for 1-2 minutes, until relatively clear water comes out of gun.

17. Turn Spray-Prime/Drain valve to PRIME.



18. Circulate water through sprayer, into waste pail, for 20 seconds.

19. Turn power switch OFF.

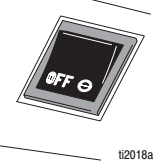

20. Close Power Flush attachment. Turn off garden hose.

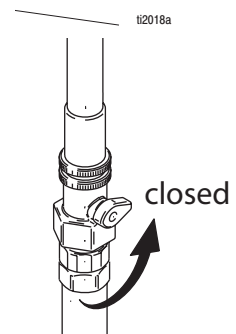

21. Unscrew Power Flush attachment from suction tube.

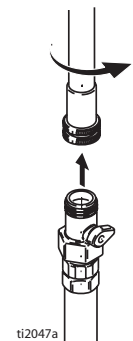

# Cleaning InstaClean™ Fluid Filter (XR models only)

The InstaClean Fluid Filter prevents particles from entering paint hose. After each use, remove and clean it to insure peak performance.



1. Turn power switch OFF.

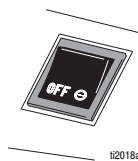

2. Disconnect airless spray hose from sprayer and remove InstaClean Fluid Filter.

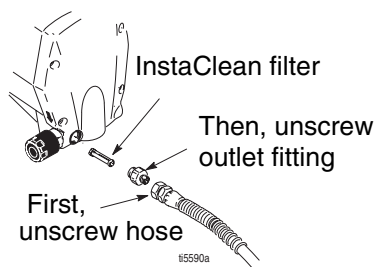

3. Check InstaClean Fluid Filter for debris. If needed, clean filter with water and a soft brush.
4. Install InstaClean Fluid Filter.

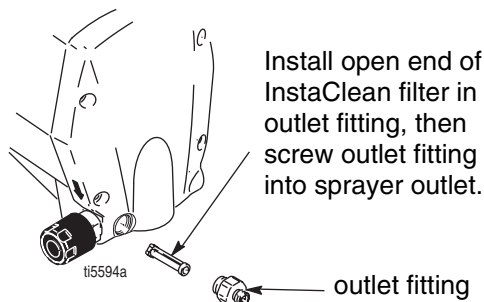

5. Tighten outlet fitting and reconnect hose to sprayer.

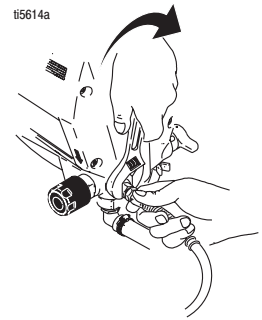

## Gun Fluid Filter

Clean gun fluid filter with compatible solvent and a brush every time you flush the system. Replace gun filter when damaged.

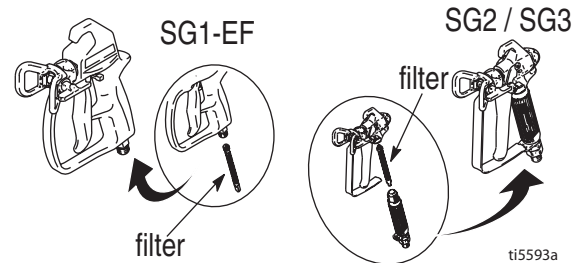

# Storage

## Short Term Storage (up to 2 days)



1. Place suction and drain tube in paint can.

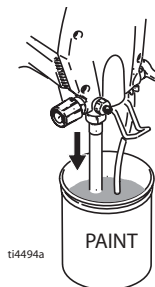

2. Cover can and hoses tightly with plastic wrap.

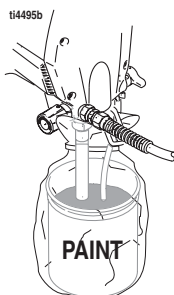

3.
  - a. Engage trigger lock.

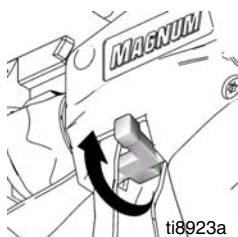

- b. Leave gun attached to hose.

- c. Remove tip and guard and clean with water or flushing solvent. A soft brush can be used to loosen and remove dried on material if needed.



- d. Wipe paint off outside of gun using a soft cloth moistened with water or flushing solvent.

4. Leave gun attached to hose and submerge gun in pail of water.

## Long Term Storage (more than 2 days)



- Always circulate Pump Armor storage fluid through system after cleaning. Water left in sprayer will corrode and ruin pump.

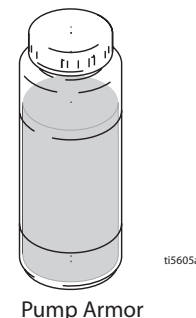

1. Place suction tube in Pump Armor storage fluid bottle and prime tube in waste pail.

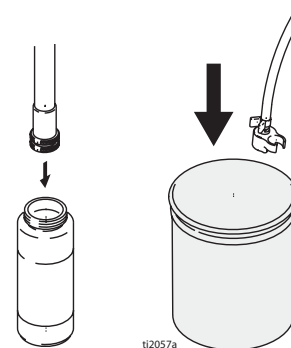

2. Turn Spray-Prime/Drain valve to PRIME.



3. Turn Pressure Control knob all the way left (counter-clockwise) to minimum pressure.

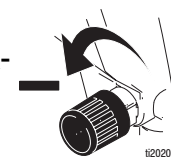

4. Turn power switch ON.



- Turn pressure control knob clockwise until the pump turns on.

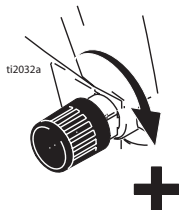

- When storage fluid comes out of prime tube (5-10 seconds) turn power switch OFF.

- Turn Spray-Prime/Drain valve to SPRAY to keep storage fluid in sprayer during storage.

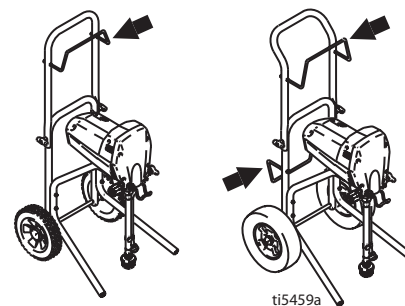

- Secure a plastic bag around suction tube to catch any drips.

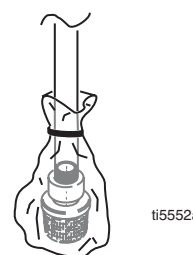

## Stowing Sprayer

### CAUTION

- Before storing sprayer make sure all water is drained out of sprayer and hoses.
- Do not allow water to freeze in sprayer or hose.
- Do not store sprayer under pressure.

- Screw inlet screen onto suction tube.

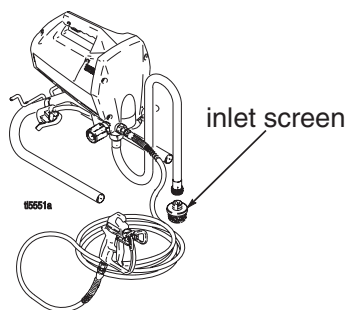

- Coil hose. Leave it connected to sprayer.

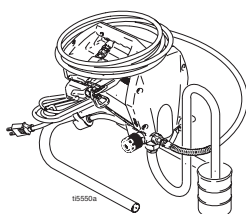

- Wrap power cord around cord wrap (XR7 and XR9 models).

# Troubleshooting



Check everything in this Troubleshooting Table before you bring the sprayer to a Graco/Magnum authorized service center. Refer to **Component Identification**, page 6 for reference letters used in table.

Problem	Cause	Solution
Power switch is on and sprayer is plugged in, but motor does not run, and pump does not cycle.	Pressure is set at zero pressure.	Turn Pressure Control Knob (C) clockwise to increase pressure setting.
	Motor or control is damaged.	Take sprayer to Graco/magnum authorized service center.
	Electric outlet is not providing power.	<ul style="list-style-type: none"> <li>• Try a different outlet or plug in something that you know is working to test outlet.</li> <li>• Reset building circuit breaker or replace fuse.</li> </ul>
	Extension cord is damaged.	Replace extension cord. Read Grounding and Electric Requirements, page 5.
	Sprayer electric cord is damaged.	Check for broken insulation or wires. Replace electric cord if damaged.
Power switch is on and sprayer is plugged in, but motor does not run, and pump does not cycle.	Paint is frozen or hardened in pump.	Unplug sprayer from outlet. If frozen do NOT try to start sprayer until it is completely thawed or you may damage the motor, control board and/or drivetrain.  Make sure power switch is OFF. Place sprayer in a warm area for several hours. Then plug in and turn ON. Slowly increase pressure setting to see if motor will start.  If paint is hardened in sprayer, pump packings, valves, drivetrain or pressure switch may need to be replaced. Take sprayer to Graco/magnum authorized service center.

Problem	Cause	Solution
Pump does not prime.	Spray-Prime/Drain Valve (J) is in SPRAY position.	Turn Spray-Prime/Drain Valve to PRIME/DRAIN position (pointing down).
	Inlet screen (L) is clogged or suction tube (G) is not immersed.	Clean debris off inlet screen and make sure suction tube is at bottom of paint pail.
	Inlet valve check ball is stuck.	Remove suction tube and place a pencil into the inlet section to dislodge the ball, allowing pump to prime properly. OR Power Flush sprayer, page 17.
Pump does not prime.	Outlet valve check ball is stuck.	<p>dx Sprayer: Remove hose from sprayer. Unscrew outlet valve to remove assembly with a screwdriver. Screw the valve back on the pump.</p> <p>XR Sprayers: Use a screw driver to open the Easy-Access™ door. Unscrew outlet valve with a 3/4 in. wrench. Remove and clean assembly.</p>
	Suction tube is leaking.	Tighten suction tube connection (K). Inspect for cracks or vacuum leaks.
	Spray-Prime/Drain Valve is plugged.	Clean/replace drain tube as necessary. Take sprayer to Graco/magnum authorized service center if valve is plugged.
Spray gun stopped spraying.	Spray tip is clogged.	Unclog spray tip, page 12.
Pump cycles but does not build up pressure.	Pump is not primed.	Prime pump.
Pump cycles but does not build up pressure.	Inlet screen (L) is clogged or suction tube (G) is not immersed.	Clean debris off inlet screen and make sure suction tube is at bottom of paint pail.
	Paint pail is empty.	Refill paint pail. Reprime sprayer.
Pump cycles but does not build up pressure.	Suction tube is leaking.	Tighten suction tube connection (K). Inspect for cracks or vacuum leaks. If cracked or damaged, replace suction tube.
	Pump check valves are dirty or damaged. (Usually only one valve).	Clean or replace check valves. Read <b>Pump Check Valves</b> , page 11.
	Spray-Prime/Drain Valve (J) is worn or obstructed with debris.	Take sprayer to Graco/magnum authorized service center.
	Pump check ball is stuck.	Read <b>Pump does not prime</b> section in Troubleshooting, page 23

## Troubleshooting

Problem	Cause	Solution
Pump cycles, but paint only dribbles or spurts when spray gun is triggered.	Pressure is set too low.	Slowly turn Pressure Control Knob (C) clockwise to increase pressure setting and verify if sprayer pressure increases.
	Spray tip is clogged.	Unclog spray tip, page 12.
	InstaClean fluid filter is clogged (XR models only).	Clean or replace InstaClean fluid filter (E).
	Spray gun fluid filter is clogged.	Clean or replace gun fluid filter (V).
	Spray tip is too large or worn.	Replace tip.
Spray pattern is inconsistent or is leaving stripes.	Pressure is set too low.	Turn Pressure Control Knob (C) clockwise, to increase pressure.
	Spray tip is worn beyond capability of sprayer.	Replace spray tip.
Pressure is set at maximum but cannot achieve a good spray pattern.	Spray tip is too large for sprayer.	Select smaller spray tip.
Pressure is set at maximum but cannot achieve a good spray pattern.	Spray tip is worn beyond capability of sprayer.	Replace spray tip.
	Extension cord is too long or not heavy enough gauge.	Replace extension cord. <b>Grounding and Electrical Requirements</b> , page 5.
Pressure is set at maximum but cannot achieve a good spray pattern.	Spray gun fluid filter is clogged.	Clean or replace spray gun fluid filter.
	InstaClean fluid filter is clogged (XR models only).	Clean or replace InstaClean fluid filter.
	Inlet screen is clogged.	Clean debris off inlet screen.
	Pump valves are worn.	Check for worn pump valves. <ul style="list-style-type: none"> <li>a. Prime sprayer with paint</li> <li>b. Trigger gun momentarily. When trigger is released, pump should cycle momentarily and stop. IF pump continues to cycle, pump valves may be worn. Read Pump Check Valves, page 11.</li> </ul>
When paint is sprayed, it runs down the wall or sags.	Coat is going on too thick.	Move gun faster.
		Choose a tip with smaller hole size.
		Choose tip with wider fan.
		Make sure gun is far enough from surface.
When paint is sprayed, coat is not covering.	Coat is going on too thin.	Move gun slower.
		Choose tip with larger hole size.
		Choose tip with narrower fan.
When paint is sprayed, coat is not covering.	Coat is going on too thin.	Make sure gun is close enough to surface.



Problem	Cause	Solution
<p>Motor is hot and runs intermittently. This is NOT a thermal overload condition. Motor automatically shuts off due to excessive heat. Damage can occur if cause is not corrected. <b>Thermal Overload</b>, page 5.</p>	Vent holes in enclosure are plugged or sprayer is covered.	Keep vent holes clear of obstructions and overspray and keep sprayer open to air.
	Extension cord is too long or not a heavy enough gauge.	Replace extension cord. Read <b>Grounding and Electrical Requirements</b> , page 5.
	Unregulated electrical generator being used has excessive voltage.	Use electrical generator with a proper voltage regulator. Sprayer requires 120VAC, 60 Hz, 1500-Watt generator.
	Sprayer was operated at high pressure with very small tip which causes frequent motor starts and excessive heat build up.	Decrease pressure setting or increase tip size.
<p>Building circuit breaker opens after sprayer operates for 5 to 10 minutes.</p>	Too many appliances are plugged in on same circuit.	Free up circuit (unplug things), or use a less busy circuit.
	Sprayer electrical cord is damaged.	Check broken insulation or wires. Replace electrical cord if damaged.
	Extension cord is damaged or too long or not a heavy enough gauge.	<ul style="list-style-type: none"> <li>• Plug in something that you know is working to test extension cord.</li> <li>• Replace extension cord.</li> </ul>
<p>Fan pattern varies dramatically while spraying.</p> <p>OR</p> <p>Sprayer does not turn on promptly when resuming spraying.</p>	Pressure control switch is worn and causing excessive pressure variation.	Take sprayer to Graco/magnum authorized service center.
Cannot trigger spray gun.	Spray gun trigger safety is locked.	Rotate trigger safety lever to unlock SAFETY, page 8.
Spray comes out of spray gun in two thick streams.	Reversible spray tip is in UNCLOG position.	Rotate arrow-shaped handle on spray tip so it points forward in SPRAY position.
Paint is coming out of pressure control switch.	Pressure control switch is worn.	Take sprayer to Graco/magnum authorized service center.
Spray-Prime/Drain valve actuates automatically relieving pressure through drain tube.	System is over pressurizing.	Take sprayer to Graco/magnum authorized service center.
Paint leaks down outside of pump.	Pump packings are worn.	Replace pump packings.

# Maintenance and Service

## CAUTION

**Protect the internal drive parts of this sprayer from water.** Openings in shroud allow cooling of mechanical parts and electronics inside. If water gets into these openings, the sprayer could malfunction or be permanently damaged.

## Caring for Sprayer

Keep sprayer and all accessories clean and in good working order.

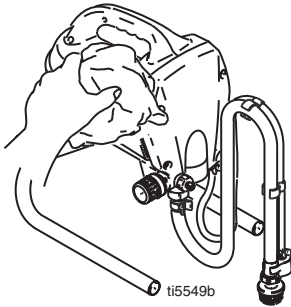

To avoid overheating motor, keep vent holes in shroud clear for air flow.

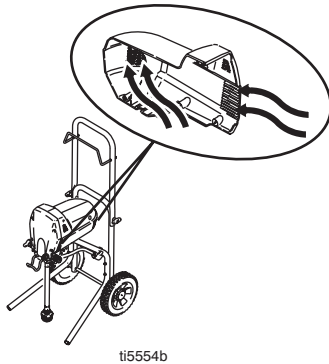

Do not cover sprayer while spraying.

## Paint Hoses

Check hose for damage every time you spray. Do not attempt to repair hose if hose jacket or fittings are damaged. Do not use hoses shorter than 25 ft (7.6 m). Wrench tighten, using two wrenches.

## Tips

- Always clean tips with compatible solvent and brush after spraying.

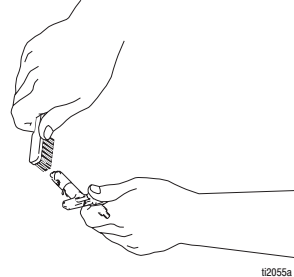

- Tips may require replacement after 15 gallons (57 liters) or they may last through 60 gallons (227 liters) depending on abrasiveness of paint.
- Do not spray with worn tip.

## Pump Packings

When pump packings wear, paint will begin to leak down outside of pump. Replace pump packings at first sign of leaking or additional damage could occur. Get a pump repair kit and install according to instruction on kit packaging. Consult a Graco/MAGNUM authorized service center.

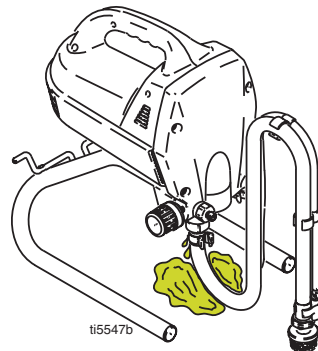

# Technical Data

	MAGNUM dx	MAGNUM XR5	MAGNUM XR7	MAGNUM XR9
Working pressure range	0-2800 psi (0-19 MPa, 0 -193 bar)	0-3000 psi (0-21 MPa, 0-207 bar)	0-3000 psi (0-21 MPa, 0-207 bar)	0-3000 psi (0-21 MPa, 0-207 bar)
Electric motor	All 120 Vac: 6.5A Model 247238: 3.5A (open frame, universal)	5.8A (open frame, permanent magnet DC)		9.4A (open frame, permanent magnet DC)
Operating horsepower	3/8	5/8	3/4	7/8
Maximum delivery (with tip)	0.24 gpm (0.91 lpm)	0.27 gpm (1.02 lpm)	0.31 gpm (1.17 lpm)	0.38 gpm (1.44 lpm)
Paint hose	3/16 in. x 25 ft (4.8 mm x 8 m)	1/4 in. x 25 ft (6.3 mm x 8 m)	1/4 in. x 50 ft (6.3 mm x 15 m)	1/4 in. x 50 ft (6.3 mm x 15 m)
Maximum tip hole size	0.015 in. (0.38 mm)	0.015 in. (0.38 mm)	0.017 in. (0.43 mm)	0.019 in. (0.48 mm)
Weight, sprayer only	15 lb (7 kg)	21 lb (10 kg)	31 lb (14 kg)	35 lb (16 kg)
Weight, sprayer, hose & gun	18 lb (8 kg)	24 lb (11 kg)	36 lb (17 kg)	40 lb (18 kg)
Dimensions: Length	17.5 in. (44.5 cm)	13.75 in. (34.9 cm)	19.5 in. (49.5 cm)	19.5 in. (49.5 cm)
Width	18 in. (46 cm)	11 in. (27.9 cm)	17.25 in. (43.8 cm)	19 in. (48.3 cm)
Height	21 in. (53 in.)	19 in. (48.3 cm)	40.75 in. (103.5 cm) <i>Height with folded handle: 26 in. (66 cm)</i>	40 in. (101.6 cm)* <i>Height with folded handle: 26 in. (66 cm)</i>
Power cord	16 AWG, 3-wire, 6 ft (1.8 m)			16 AWG, 3-wire, 10 ft (3.05 m)
Fluid inlet fitting	3/4 in. internal thread (standard garden hose thread)			
Fluid outlet fitting	1/4 NPSM external thread			
Inlet screen (on suction tube)	<b>Early models</b> - 14 mesh (1300 micron) <b>Later models</b> - 35 mesh (450 micron)			
Wetted parts, pump & hose	stainless steel, brass, ultra-high molecular weight polyethylene (UHMWPE), carbide, nylon, aluminum, PVC, polypropylene, fluoroelastomer	stainless steel, brass, leather, ultra-high molecular weight polyethylene (UHMWPE), carbide, nylon, aluminum, PVC, polypropylene, fluoroelastomer		
Wetted parts, gun	SG1-EF: plated steel, nylon, aluminum, tungsten carbide, stainless steel, brass, fluoroelastomer		SG2/SG3: aluminum, brass, carbide, nylon, plated steel, stainless steel, UHMWPE, zinc	
Generator requirement	1500 Watt minimum			
Electrical power requirement	All except Model 247328: 120 Vac, 60 Hz, 15A, 1 phase Model 247328: 230 Vac, 50 Hz, 10A, 1 phase			
Storage temperature range ♦❖	-30° to 160°F (-35° to 71°C)			
Operating temperature range ✓	40° to 115°F (4° to 46°C)			

- ♦ When pump is stored with non-freezing fluid. Pump damage will occur if water or latex paint freezes in pump.
- ❖ Damage to plastic parts may result if impact occurs in low temperature conditions.
- ✓ Changes in paint viscosity at very low or very high temperatures can affect sprayer performance.

## Graco Standard Warranty

Graco warrants all equipment referenced in this document which is manufactured by Graco and bearing its name to be free from defects in material and workmanship on the date of sale to the original purchaser for use. With the exception of any special, extended, or limited warranty published by Graco, Graco will, for a period of twelve months from the date of sale, repair or replace any part of the equipment determined by Graco to be defective. This warranty applies only when the equipment is installed, operated and maintained in accordance with Graco's written recommendations.

This warranty does not cover, and Graco shall not be liable for general wear and tear, or any malfunction, damage or wear caused by faulty installation, misapplication, abrasion, corrosion, inadequate or improper maintenance, negligence, accident, tampering, or substitution of non-Graco component parts. Nor shall Graco be liable for malfunction, damage or wear caused by the incompatibility of Graco equipment with structures, accessories, equipment or materials not supplied by Graco, or the improper design, manufacture, installation, operation or maintenance of structures, accessories, equipment or materials not supplied by Graco.

This warranty is conditioned upon the prepaid return of the equipment claimed to be defective to an authorized Graco distributor for verification of the claimed defect. If the claimed defect is verified, Graco will repair or replace free of charge any defective parts. The equipment will be returned to the original purchaser transportation prepaid. If inspection of the equipment does not disclose any defect in material or workmanship, repairs will be made at a reasonable charge, which charges may include the costs of parts, labor, and transportation.

**THIS WARRANTY IS EXCLUSIVE, AND IS IN LIEU OF ANY OTHER WARRANTIES, EXPRESS OR IMPLIED, INCLUDING BUT NOT LIMITED TO WARRANTY OF MERCHANTABILITY OR WARRANTY OF FITNESS FOR A PARTICULAR PURPOSE.**

Graco's sole obligation and buyer's sole remedy for any breach of warranty shall be as set forth above. The buyer agrees that no other remedy (including, but not limited to, incidental or consequential damages for lost profits, lost sales, injury to person or property, or any other incidental or consequential loss) shall be available. Any action for breach of warranty must be brought within two (2) years of the date of sale.

**GRACO MAKES NO WARRANTY, AND DISCLAIMS ALL IMPLIED WARRANTIES OF MERCHANTABILITY AND FITNESS FOR A PARTICULAR PURPOSE, IN CONNECTION WITH ACCESSORIES, EQUIPMENT, MATERIALS OR COMPONENTS SOLD BUT NOT MANUFACTURED BY GRACO.** These items sold, but not manufactured by Graco (such as electric motors, switches, hose, etc.), are subject to the warranty, if any, of their manufacturer. Graco will provide purchaser with reasonable assistance in making any claim for breach of these warranties.

In no event will Graco be liable for indirect, incidental, special or consequential damages resulting from Graco supplying equipment hereunder, or the furnishing, performance, or use of any products or other goods sold hereto, whether due to a breach of contract, breach of warranty, the negligence of Graco, or otherwise.

### **FOR GRACO CANADA CUSTOMERS**

The Parties acknowledge that they have required that the present document, as well as all documents, notices and legal proceedings entered into, given or instituted pursuant hereto or relating directly or indirectly hereto, be drawn up in English. Les parties reconnaissent avoir convenu que la rédaction du présente document sera en Anglais, ainsi que tous documents, avis et procédures judiciaires exécutés, donnés ou intentés, à la suite de ou en rapport, directement ou indirectement, avec les procédures concernées.

**TO PLACE AN ORDER** or to identify the nearest Graco/MAGNUM distributor, contact us at  
1-888-541-9788

*All written and visual data contained in this document reflects the latest product information available at the time of publication.  
Graco reserves the right to make changes at any time without notice.*

GN 309225 MM 309225  
*This manual contains English*

**Graco Headquarters:** Minneapolis  
**International Offices:** Belgium, China, Japan, Korea  
**GRACO INC. P.O. BOX 1441 MINNEAPOLIS, MN 55440-1441**  
www.graco.com  
1/2001, Rev. 7/2007