

V481

Hardware User's Manual

Second Edition, April 2008

www.moxa.com/product

MOXA®

© 2008 Moxa Inc., all rights reserved.
Reproduction without permission is prohibited.

V481

Hardware User's Manual

The Moxa software described in this manual is furnished under a license agreement and may be used only in accordance with the terms of that agreement.

Copyright Notice

Copyright © 2008 Moxa Inc.
All rights reserved.
Reproduction without permission is prohibited.

Trademarks

MOXA is a registered trademark of Moxa Inc.
All other trademarks or registered marks in this manual belong to their respective manufacturers.

Disclaimer

Information in this document is subject to change without notice and does not represent a commitment on the part of Moxa.

Moxa provides this document “as is,” without warranty of any kind, either expressed or implied, including, but not limited to, its particular purpose. Moxa reserves the right to make improvements and/or changes to this manual, or to the products and/or the programs described in this manual, at any time.

Information provided in this manual is intended to be accurate and reliable. However, Moxa assumes no responsibility for its use, or for any infringements on the rights of third parties that may result from its use. This product might include unintentional technical or typographical errors. Changes are periodically made to the information herein to correct such errors, and these changes are incorporated into new editions of the publication.

Technical Support Contact Information

www.moxa.com/support

Moxa Americas:

Toll-free: 1-888-669-2872
Tel: +1-714-528-6777
Fax: +1-714-528-6778

Moxa Europe:

Tel: +49-89-3 70 03 99-0
Fax: +49-89-3 70 03 99-99

Moxa Asia-Pacific:

Tel: +886-2-8919-1230
Fax: +886-2-8919-1231

Moxa China (Beijing office):

Tel: +86-10-6872-3959/60/61
Fax: +86-10-6872-3958

Table of Contents

Chapter 1	Introduction	1-1
	Overview.....	1-2
	Package Checklist	1-2
	Product Features	1-3
	Product Hardware Specifications.....	1-3
	Hardware Block Diagram	1-5
Chapter 2	Hardware Introduction.....	2-1
	Appearance	2-2
	Dimensions (unit = mm)	2-3
	LED Indicators.....	2-3
	Power On/Off Button.....	2-4
	Reset Button.....	2-4
	Real Time Clock	2-4
	Placement Options	2-4
	Wall or Cabinet.....	2-4
	DIN-Rail Mounting	2-5
Chapter 3	Hardware Connection Description	3-1
	Wiring Requirements	3-2
	Connecting the Power.....	3-2
	Grounding the Unit.....	3-3
	Connecting to a Display.....	3-3
	Connecting to a Keyboard and Mouse.....	3-4
	Connecting Data Transmission Cables	3-4
	Connecting to the Network.....	3-4
	Connecting to a Serial Device	3-5
	Installing a Memory Module	3-6
	Inserting a CompactFlash Card.....	3-7
	USB Hosts	3-8
	Audio Interface	3-8
Chapter 4	BIOS Setup	4-1
	Entering the BIOS Setup Utility	4-2
	Modifying the BIOS Main Settings	4-3
	Basic Configuration	4-3
	System Security	4-3
	Modifying the BIOS Advanced Settings.....	4-4
	Hard Disk Boot Priority.....	4-4
	Advanced BIOS Settings	4-5
	Advanced Chipset Settings.....	4-6
	PnP/PCI Configurations.....	4-8
	Frequency/Voltage Control	4-9
	Configuring Peripherals	4-10
	OnChip IDE Device.....	4-10
	Onboard Device.....	4-11
	Onboard I/O Chip Setup	4-12
	Power Management	4-13
	Soft-Off by PWR-BTTN	4-13

Wake-Up by PCI card.....	4-13
Resume by Alarm	4-13
HW Monitor.....	4-14
CPU Warning Temperature	4-14
Load Defaults.....	4-15
Load System Default Settings	4-15
Load CMOS From BIOS.....	4-15
Save CMOS To BIOS.....	4-15
Exiting the BIOS Setup.....	4-15

Chapter 5 Upgrading the BIOS5-1

The V481 is an industrial, ready-to-run embedded computer that supports VGA and audio. The computer comes with dual LAN ports, 8 serial ports, 2 CompactFlash slots, and 2 USB ports, and is based on the Intel x86 processor. With its VGA interface, the V481 is especially well suited for industrial applications, such as SCADA, factory automation, and other applications that require an onsite HMI or visual monitoring capability.

The V481's 8 built-in, software-selectable RS-232/422/485 serial ports makes it an ideal solution for connecting to different devices. The dual LAN ports offer a reliable solution for network redundancy by providing continuous operation for data communication and management. In addition, the second CompactFlash socket makes it easier to add storage space, and the USB ports can connect to a wide range of devices, making the V481 a reliable embedded computer for industrial applications that require VGA and HMI features.

The V481 comes pre-installed with the Windows CE 5.0 or Windows XP Embedded operating system, providing programmers with a friendly environment for developing application software. V481 programmers have an added advantage in that Moxa provides good software support to reduce the cost and time required for software development.

In this chapter, we cover the following topics:

- Overview**
- Package Checklist**
- Product Features**
- Product Hardware Specifications**
- Hardware Block Diagram**

Overview

The V481 Series of x86 ready-to-run embedded computers is designed around the Intel Celeron M 1 GHz processor. In addition to the usual computer peripherals, the V481 integrates one 10/100 LAN port, one Gigabit LAN port and 8 RS-232/422/485 serial ports, making the V481 into an ideal industrial embedded computer for handling industrial communication applications that need to connect to a monitor or HMI onsite.

The on-board CompactFlash and DDR SDRAM provide ample storage capacity, and the second CompactFlash socket allows users to install additional memory.

The Windows-based operating system comes pre-installed and ready-to-run, providing a Windows-like environment for easy software development. Software written for desktop PCs can be easily ported to the V481 using a common compiler, which means that programmers do not need to spend a lot of time modifying existing software code. In addition, the operating system, device drivers, and user-developed software can all be stored in the pre-installed CompactFlash memory Card.

Package Checklist

The V481 Series includes the following models:

V481-CE

x86 Ready-to-Run Embedded Computer with VGA, Dual LANs, 8 serial ports, CompactFlash, USB, Audio, WinCE 5.0

V481-T-CE

x86 Ready-to-Run Embedded Computer with VGA, Dual LANs, 8 serial ports, CompactFlash, USB, Audio, WinCE 5.0, Wide Temperature

V481-XPE

x86 Ready-to-Run Embedded Computer with VGA, Dual LANs, 8 serial ports, CompactFlash, USB, Audio, WinXPe

V481-T-XPE

x86 Ready-to-Run Embedded Computer with VGA, Dual LANs, 8 serial ports, CompactFlash, USB, Audio, WinXPe, Wide Temperature

Each model is shipped with the following items:

- 1 V481
- Quick Installation Guide
- Document and Software CD
- Din-rail Mounting Kit
- 100 cm RJ45-to-RJ45 cross-over Ethernet cable
- 20 cm Y-type cable for connecting a keyboard and mouse (CBL-MiniDIN6P/6Px2-20)
- Terminal block to power jack converter (includes terminal block)
- Product Warranty Statement

Optional Accessories

- Switching Power Adaptor:
60W, 24 VDC output, 100 to 240 VAC input (Order No.: 1117224250210), power cord must be ordered separately
- Power Cords:
Power cord with Australia Plug (Order No.: 9199000000500)
Power Cord with UK Plug (Order No.: 9199000000600)
Power Cord with Euro Plug (Order No.: 9199000000700)
Power Cord with US Straight Plug (Order No.: 9199000000800)

NOTE: *Please notify your sales representative if any of the above items are missing or damaged.*

Product Features

The V481 embedded computers have the following features:

- Intel Celeron M 1GHz CPU, 400 MHz FSB
- IDE hard disk support (for product produced after 1st June)
- Built-in DDR SDRAM, and industrial CompactFlash
- 8 software-selectable RS-232/422/485 serial ports
- Serial port speed from 50 bps to 921.6 Kbps; supports ANY BAUDRATE
- 10/100 and 10/100/1000 Mbps LANs for network redundancy
- Second CompactFlash socket for storage expansion
- Two USB 2.0 hosts support system bootup
- LED indicators for system power and storage
- Designed to withstand 5G continuous vibration and 50G shocks
- Ready-to-Run WinCE 5.0 or WinXPe platform
- DIN-rail and wall-mount installation
- Fanless design for increased ruggedness
- Wide temperature model available

Product Hardware Specifications

System

CPU:	Intel ULV Celeron 1GHz processor without L2 Cache
System Chipset:	Intel 852GM GMCH + ICH4 chipset
FSB:	400 MHz
BIOS:	4 Mbit Flash BIOS; supports Plug & Play
System Memory:	200-pin SO-DIMM socket x 1 with built-in 256 MB DDR for WinCE 5.0 model; 512 MB for WinXPe model; supports DDR200/266 up to 1 GB
Supported OS:	Windows CE 5.0, Windows XP Embedded

Display

Graphics Controller:	Integrated graphics with built-in Intel 852GM GMCH, built-in Intel extreme Graphics 2 technology
Display Memory:	Dynamic video memory, sharing up to 32 MB of system memory
Display Interface:	CRT Interface for VGA output

Storage

Built-in: Onboard Industrial CompactFlash to store OS, 256 MB for WinCE 5.0 model, 1 GB for WinXPe model

Expansion: Second CompactFlash socket for storage expansion, and IDE hard disk supported (optional).

Note: HD supported with product produced after 1st June

Network Communication

LAN1: Auto-sensing 10/100 Mbps Ethernet, using integrated MAC and Intel 82562GZ Transceiver, RJ45 connector

LAN2: Auto-sensing 10/100/1000 Mbps Gigabit Ethernet, using Realtek RTL8110SC Controller, RJ45 connector

Protection: 1.5 KV magnetic isolation protection

Serial Communication

Serial Port: RS-232/422/485 x 8, software-selectable, DB9
 RS-232 signals: TxD, RxD, DTR, DSR, RTS, CTS, DCD, GND
 RS-422 signals: TxD+, TxD-, RxD+, RxD-, GND
 4-wire RS-485 signals: TxD+, TxD-, RxD+, RxD-, GND
 2-wire RS-485 signals: Data+, Data-, GND

Protection: 15 KV ESD protection for all signals

Data bits: 5, 6, 7, 8

Stop bit(s): 1, 1.5, 2

Parity: None, Even, Odd, Space, Mark

Flow Control: RTS/CTS, XON/XOFF, RS-485 ADDC™

Speed: 50 bps to 921.6 Kbps; supports ANY BUAD RATE

Other Peripherals

USB: USB 2.0 compliant Host x 2, type A connector

Audio: AC97 audio, supports line-in and speaker-out interface

KB/MS: 1 PS/2 interface, support standard PS/2 keyboard and PS/2 mouse with Y-type cable

Watchdog Timer: Support 1 to 255 level time interval system reset, software programmable

RTC: Yes, lithium battery backup

LEDs

System: Power x 1, Storage x 1

LAN1: 10M/100M (on connector), Tx/Link (on connector)

LAN2: 10M/100M/1000M (on connector), Tx/Link (on connector)

Buttons

Power Button: Power on/off x 1

Resent Button: Reset button for system warm reboot x 1

Power Requirements

Power Input: 9 to 36 VDC

Power Consumption: 25W, 650 mA @ 36 VDC, 2750 mA @ 9 VDC

Mechanical

Dimensions (with casing, W x D x H): 230 x 140 x 70 mm (without wall mount ears and Din-rail Kit)

Construction Material: Aluminum

Mounting: Wall-mount, DIN-rail

Environment

Operating Temperature: -10 to 60°C (14 to 140°F), 5 to 95% RH (with CF installed)
 0 to 40°C (35 to 104°F), 5 to 95% RH (with HD installed)
 -35 to 75°C (-31 to 167°F), 5 to 95% RH (for -T model)

Storage Temperature: -20 to 80°C (-4 to 176°F), 5 to 95% RH
 -40 to 85°C (-40 to 185°F), 5 to 95% RH (for -T model)

Anti-Vibration: 5G @ IEC-68-2-6, sine wave, 5-500 Hz, 1 Oct./min, 1hr/axis
 (with CompactFlash card)
 1G @ IEC-68-2-6, sine wave, 5-500 Hz, 1 Oct./min, 1hr/axis
 (with Hard Disk)

Anti-Shock: 50G @ IEC-68-2-27, half sine wave, 30 ms
 (with CompactFlash card)
 20G @ IEC-68-2-27, half sine wave, 30 ms
 (with Hard Disk)

Regulatory Approvals

EMC: FCC: Part 15 Subpart B, CISPR22 Class A
 CE: EN61000-6-4, EN61000-6-2, EN61000-3-3, EN61000-3-2

Safety: LVD: EN60950-1
 UL/cUL: UL60950-1, CSA C22.2 No. 60950-1-03

Directives: RoHS, CROHS, WEEE

Warranty: 5 years

Hardware Block Diagram

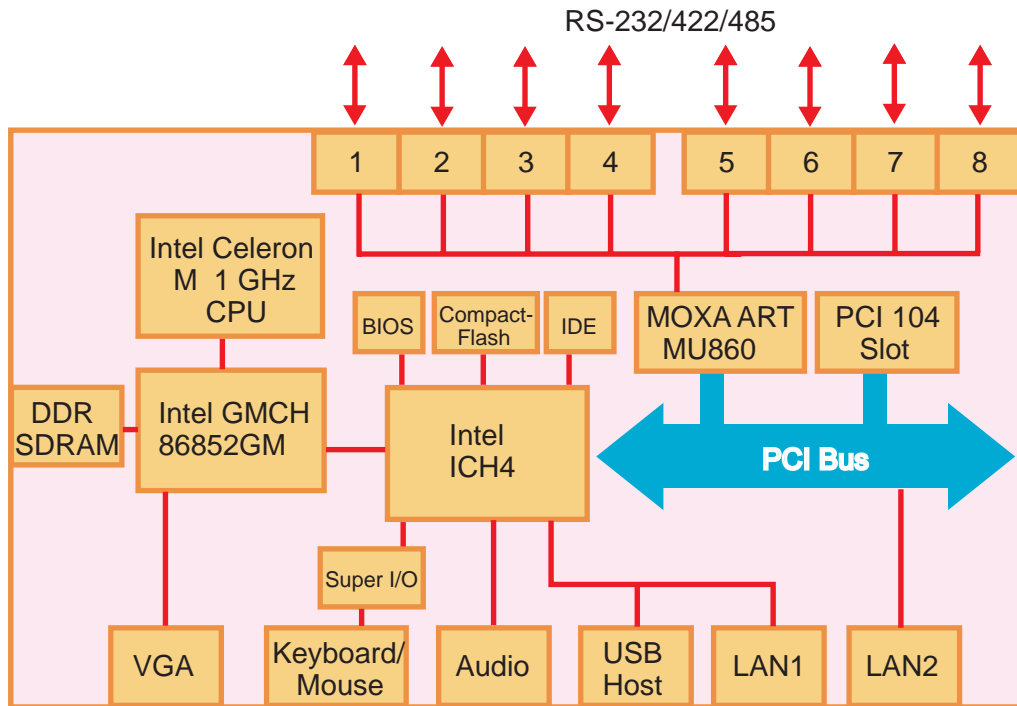

2

Hardware Introduction

The V481 embedded computers are compact and rugged, making them suitable for industrial applications. The LED indicators allow users to monitor performance and identify trouble spots quickly, and the multiple ports can be used to connect a variety of devices. The V481 comes with a reliable and stable hardware platform that lets you devote the bulk of your time to application development. In this chapter, we provide basic information about the embedded computer hardware and its various components.

In this chapter, we cover the following topics:

- ❑ **Appearance**
- ❑ **Dimensions**
- ❑ **LED Indicators**
- ❑ **Power On/Off Button**
- ❑ **Reset Button**
- ❑ **Real Time Clock**
- ❑ **Placement Options**
 - Wall or Cabinet
 - DIN-Rail Mounting

Appearance

Rear View

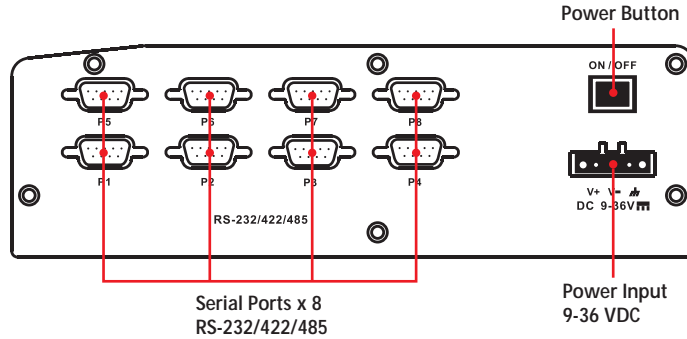

Top View

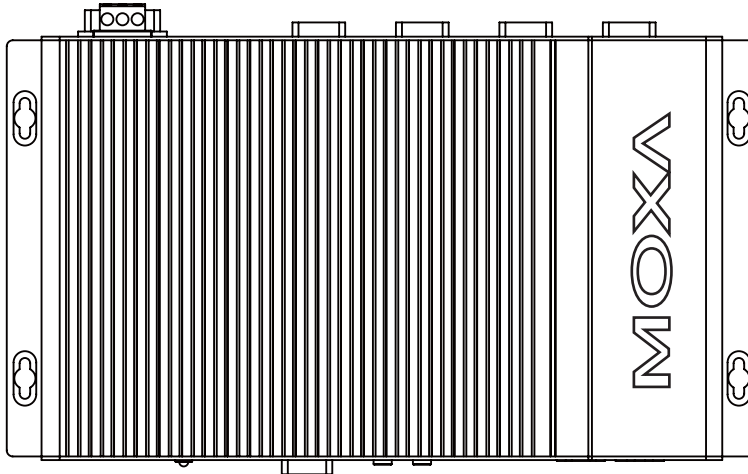

Front View

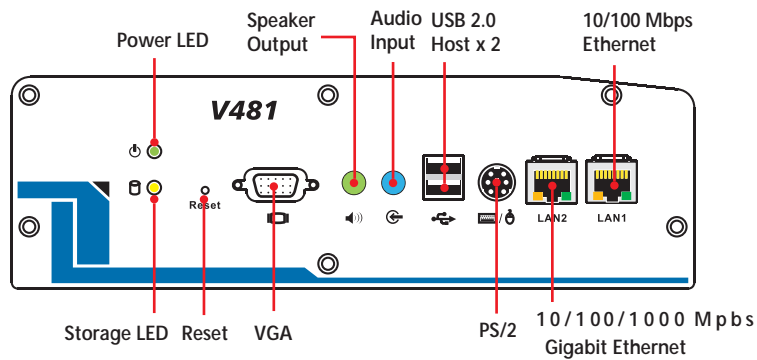

Dimensions (unit = mm)

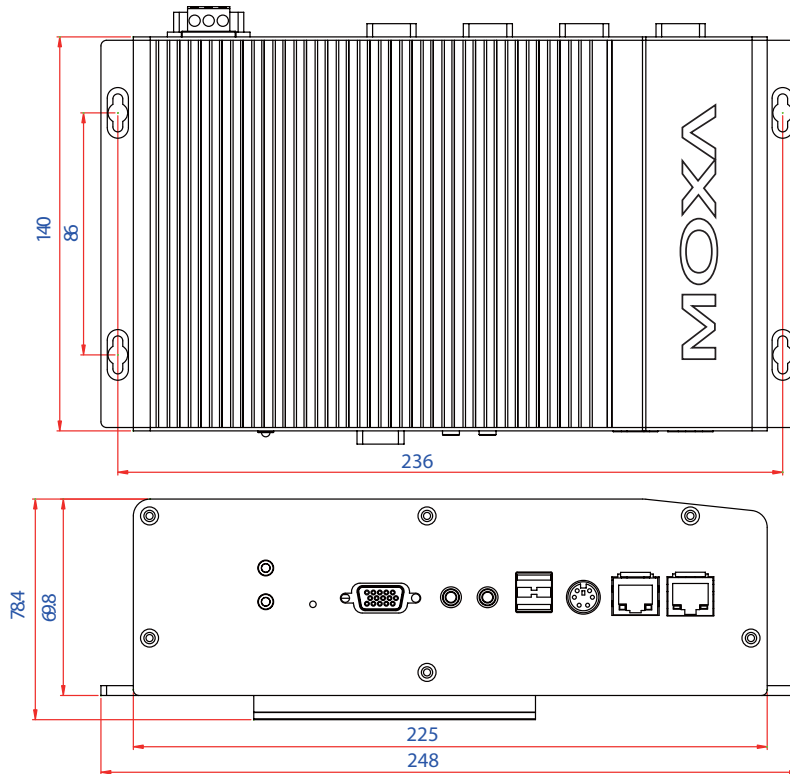

LED Indicators

There are 6 LED indicators located on the front panel of the V481.

LED Name	LED Color	LED Function	
Power	Green	Power is on	
	Off	No power is being received, or power error exists	
Storage	Yellow	Data is being written to or read from the storage unit.	
	Off	Storage unit is idle	
LAN1, LAN2	Link LED	Yellow	Tx/Link
		Off	Disconnected or short circuit exists
	Mode LED	Orange (LAN2 Only)	1000 Mbps Ethernet Mode (Gigabit Ethernet)
		Green	100 Mbps Ethernet Mode
		Off	10 Mbps Ethernet Mode

Power On/Off Button

The power on/off button is located above the power input terminal block. The button supports the ATX power on/off function. By default, the button is set for “instant off.” You may also configure the button for “delay 4 seconds” to guard against shutting down the power unintentionally. In this case, you must press the power button continuously for at least 4 seconds to shut off the power. For detailed configuration instructions, please see “Chapter 4: BIOS Setup” towards the end of this manual.

Reset Button

Pressing the **Reset** button initiates a hardware warm reboot. The button plays the same role as a desktop PC's reset button. After pressing the reset button, the system will reboot automatically.

During normal use, you should **NOT** use the **Reset** Button. You should only use this button if the software is not working properly. To protect the integrity of data being transmitted or processed, you should always reset the system from the operating system with the software reboot function.

Real Time Clock

The embedded computer's real-time clock is powered by a lithium battery. We strongly recommend that you do **NOT** replace the lithium battery on your own. If the battery needs to be changed, please contact the Moxa RMA service team.



ATTENTION

There is a risk of explosion if the wrong type of battery is used. To avoid this potential danger, always be sure to use the correct type of battery. Contact the Moxa RMA service team when you need to replace the battery.

Placement Options

Wall or Cabinet

The V481 has wall-mount ears for attaching the V481 to a wall or the inside of a cabinet. Use screws to attach the V481 to a wall or cabinet, as illustrated in the following figure.

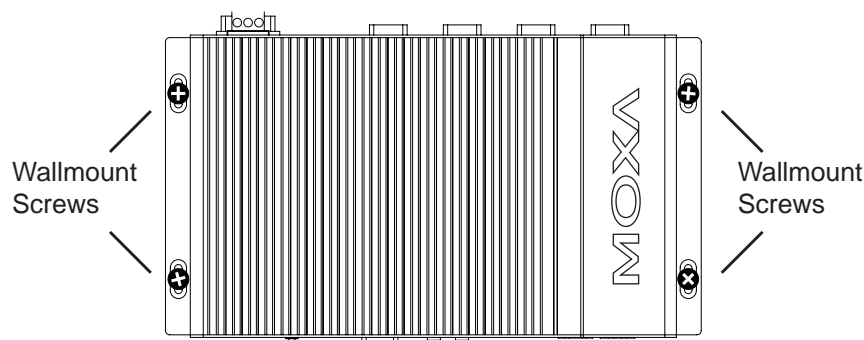

DIN-Rail Mounting

An aluminum DIN-Rail Mounting Kit is included with the V481. If you need to reattach the DIN-Rail kit to the V481, make sure the stiff metal spring is situated towards the top, as shown in the following figures.

STEP 1: Insert the top of the DIN-Rail into the slot just below the stiff metal spring.

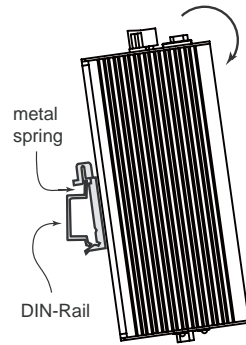

STEP 2: The DIN-Rail attachment unit will snap into place as shown below.

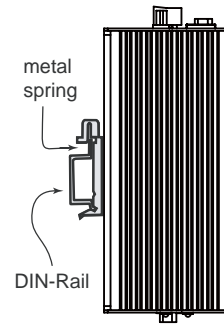

To remove the V481 from the DIN-Rail, simply reverse Steps 1 and 2.

Hardware Connection Description

The V481 embedded computers are equipped with multiple connection types: VGA, Ethernet, multiple serial interfaces, and PS2 connectors are built into the V481. The V481 also has a CompactFlash socket for storage expansion, USB ports for additional device and storage options, and an audio interface. The ready-to-run Windows Embedded operating system gives you the freedom to develop custom applications for any type of industrial automation application. In this chapter, we describe how to connect the embedded computer to the network and to various devices.

In this chapter, we cover the following topics:

- ❑ **Wiring Requirements**
 - Connecting the Power
 - Grounding the Unit
- ❑ **Connecting to a Display**
- ❑ **Connecting to a Keyboard and Mouse**
- ❑ **Connecting Data Transmission Cables**
 - Connecting to the Network
 - Connecting to a Serial Device
- ❑ **Installing a Memory Module**
- ❑ **Inserting a CompactFlash Card**
- ❑ **USB Hosts**
- ❑ **Audio Interface**

Wiring Requirements

In this section, we describe how to connect serial devices to the embedded computer.

You should heed the following common safety precautions before proceeding with the installation of any electronic device:

- Use separate paths to route wiring for power and devices. If power wiring and device wiring paths must cross, make sure the wires are perpendicular at the intersection point.

NOTE: Do not run signal or communication wiring and power wiring in the same wire conduit. To avoid interference, wires with different signal characteristics should be routed separately.

- Use the type of signal transmitted through a wire to determine which wires should be kept separate. The rule of thumb is that wiring that shares similar electrical characteristics can be bundled together.
- Keep input wiring and output wiring separate.
- It is advisable to label the wiring to all devices in the system.



ATTENTION

Safety First!

Be sure to disconnect the power cord before installation and/or wiring.

Electrical Current Caution!

Calculate the maximum possible current in each power wire and common wire. Observe all electrical codes dictating the maximum current allowable for each wire size.

If the current goes above the maximum rating, the wiring could overheat, causing serious damage to your equipment.

Temperature Caution!

Be careful when handling the unit. When the unit is plugged in, the internal components generate heat, and consequently the outer casing may feel hot to the touch.

Connecting the Power

Connect the “live-wire” end of the 9-36 VDC power adaptor to the embedded computer’s terminal block. When the power is properly supplied, the “Power” LED will glow a solid green color.



ATTENTION

The power for this product is intended to be supplied by a Listed Power Supply Unit, and rated to deliver 9 to 36 VDC at a minimum of 4A for 9 VDC, 1A for 36 VDC.

Grounding the Unit

Grounding and wire routing help limit the effects of noise due to electromagnetic interference (EMI). Before connecting devices, run a ground wire from the ground screw to the grounding surface.



ATTENTION

This product should be mounted to a well-grounded mounting surface such as a metal panel.

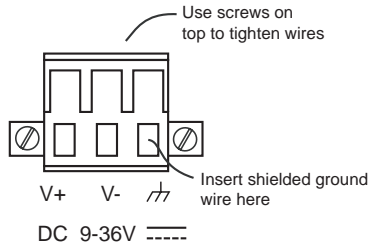

SG: The *Shielded Ground* (sometimes called Protected Ground) contact is the right most contact of the 3-pin power terminal block connector, as viewed from the angle shown here. Connect the SG wire to an appropriate grounded metal surface.

Connecting to a Display

The V481 comes with a D-Sub 15-pin female connector to connect a VGA CRT monitor. To ensure that the monitor image remains clear, be sure to tighten the monitor cable after connecting it to the V481. The pin assignments of the VGA connector are shown below.

DB15 Female Connector	Pin No.	Signal Definition
	1	Red
	2	Green
	3	Blue
	4	---
	5	GND
	6	GND
	7	GND
	8	GND
	9	---
	10	GND
	11	---
	12	---
	13	H-Sync
	14	V-Sync
	15	---

Connecting to a Keyboard and Mouse

The V481 has a PS/2 connector for connecting a PS/2 keyboard or PS/2 mouse. This 6-pin mini-DIN connector has the following pin assignments, which depend on the version of the product.

PS/2 Pin Assignments for V481 version 1.0

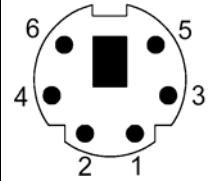
PS/2 Connector	Pin No.	Signal Definition
	1	PS/2 Keyboard Data
	2	PS/2 Mouse Clock
	3	GND
	4	VCC
	5	PS/2 Keyboard Clock
	6	PS/2 Mouse Data

PS/2 Pin Assignments for V481 versions 1.1 and later

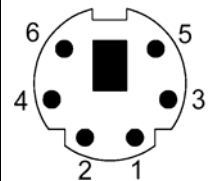
PS/2 Connector	Pin No.	Signal Definition
	1	PS/2 Keyboard Data
	2	PS/2 Mouse Data
	3	GND
	4	VCC
	5	PS/2 Keyboard Clock
	6	PS/2 Mouse Clock

Use the Y-type cable to convert the mini-DIN connector into two 6-pin mini-DIN connectors to connect both a PS/2 keyboard and PS/2 mouse at the same time.

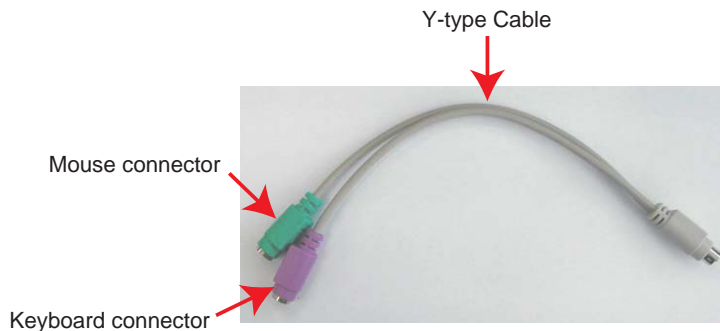

Connecting Data Transmission Cables

In this section, we describe how to connect to the network and to serial devices.

Connecting to the Network

Plug your network cable into the embedded computer's Ethernet port, and plug the other end of the network cable into your Ethernet network port. When the cable is properly connected, the LEDs on the embedded computer's Ethernet port will glow to indicate a proper connection.

The 10/100 Mbps and 10/100/1000 Mbps Ethernet LAN ports use 8-pin RJ45 connectors. The following diagram shows the pinouts for these ports.

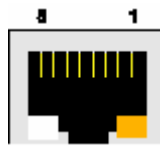

The LED indicator in the lower right corner glows a solid orange color when the cable is properly connected to a 1000 Mbps (Gigabit) Ethernet network (applies only to LAN2).

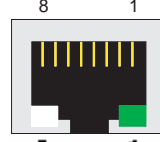

The LED indicator in the lower right corner glows a solid green color when the cable is properly connected to a 100 Mbps Ethernet network.



The LED indicator in the lower right corner will not glow when the cable is properly connected to a 10 Mbps Ethernet network.



The LED indicator in the lower left corner glows a solid yellow color when the cable is properly connected. The LED will flash on and off when Ethernet packets are being transmitted or received.

Pin	Signal
1	ETx+
2	ETx-
3	ERx+
4	---
5	---
6	ERx-
7	---
8	---

Connecting to a Serial Device

Use serial cables to connect your serial devices to the embedded computer's serial ports. Serial ports P1 to P8 use male DB9 connectors and can be configured for RS-232, RS-422, or RS-485 communication by software. The pin assignments are shown in the following table:

DB9 Male Port

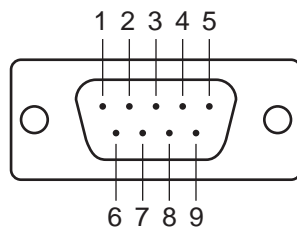

RS-232/422/485 Pinouts

Pin	RS-232	RS-422	RS-485 (4-wire)	RS-485 (2-wire)
1	DCD	TxDA(-)	TxDA(-)	---
2	RxD	TxDB(+)	TxDB(+)	---
3	TxD	RxDB(+)	RxDB(+)	DataB(+)
4	DTR	RxDA(-)	RxDA(-)	DataA(-)
5	GND	GND	GND	GND
6	DSR	---	---	---
7	RTS	---	---	---
8	CTS	---	---	---

Installing a Memory Module

The V481 has one 200-pin SO-DIMM socket for installing the DDR SDRAM memory module. One 256 MB DDR SDRAM Module is already installed. To install an additional DDR SDRAM memory module (from 128 MB to 1 GB), follow these instructions:

1. Disconnect the V481 from the power source.
2. Unscrew the V481's bottom cover.



3. Grab hold of the main screw and lift to remove the V481's bottom cover.



4. Plug a DDR SDRAM module into the 200-pin SO-DIMM socket; be sure to situate the module correctly.



5. Replace V481's bottom cover.

Inserting a CompactFlash Card

The V481 comes with a industrial CompactFlash card pre-installed for storing the Windows Embedded operating system. A second CompactFlash socket is located inside the V481 to make it easy for users to add more memory. The additional slot allows users to add memory by inserting a CompactFlash memory card, without risking damage to the operating system.

To insert a CompactFlash card, please follow these instructions.

1. Disconnect the V481 from the power source.
2. Unscrew the V481's bottom cover.



3. Grab hold of the main screw and lift to remove the V481's bottom cover. You will see that the socket is attached to the bottom cover.



4. Plug a CompactFlash card into the socket; be sure to situate the module correctly.

2nd CompactFlash socket

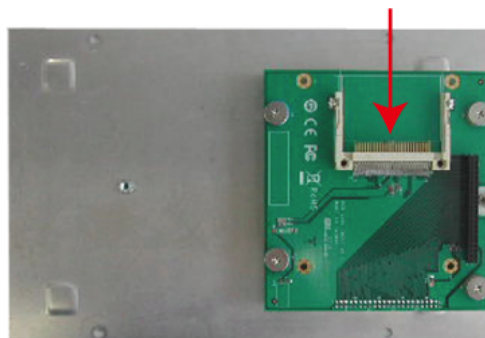

5. Replace V481's bottom cover.

USB Hosts

The V481 has two USB 2.0 ports. Both ports are UHCI, Rev. 2.0 compliant and support Plug & Play and hot swapping. The ports can be used to connect USB devices, such as a keyboard, mouse, USB flash disk, and USB CD-ROM. In addition, both USB ports support system boot up, which can be activated by modifying the BIOS settings. The next chapter describes the configuration process in detail.

Audio Interface

The V481 has an audio interface that follows the AC97 standard and supports speaker output and audio line input.

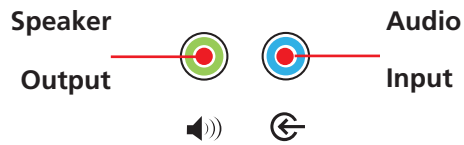

In this chapter, we explain how to configure the V481's BIOS settings. The built-in BIOS setup program allows users to configure basic settings for the entire computer system. All of the configurations are stored in the CMOS RAM, which is connected a battery back-up. This means that the configuration settings will be stored in the CMOS RAM even if the computer is powered down.

In this chapter, we cover the following topics:

- ❑ **Entering the BIOS Setup Utility**
- ❑ **Modifying the BIOS Main Settings**
 - Basic Configuration
 - System Security
- ❑ **Modifying the BIOS Advanced Settings**
 - Hard Disk Boot Priority
 - Advanced BIOS Settings
 - Advanced Chipset Settings
 - PnP/PCI Configurations
 - Frequency/Voltage Control
- ❑ **Configuring Peripherals**
 - OnChip IDE Device
 - Onboard Device
 - Onboard I/O Chip Setup
- ❑ **Power Management**
 - Soft-Off by PWR-BTTN
 - Wake-Up by PCI card
 - Resume by Alarm
- ❑ **HW Monitor**
 - CPU Warning Temperature
- ❑ **Load Defaults**
 - Load System Default Settings
 - Load CMOS From BIOS
 - Save CMOS To BIOS
- ❑ **Exiting the BIOS Setup**

Entering the BIOS Setup Utility

To enter the BIOS setup utility, please press the **Del** key after booting up the system. The main BIOS Setup Utility screen will appear, as shown below.

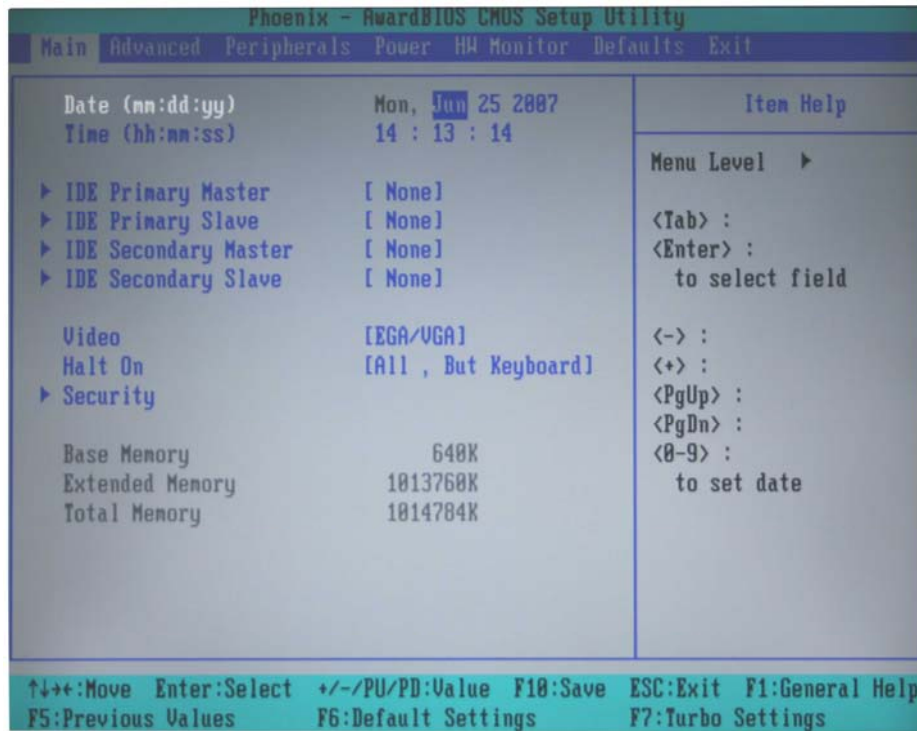

A basic description of each function key is listed at the bottom of the screen. Refer to these descriptions to learn how to scroll about the screen, how to select by pressing “Enter” and how to use the other hot keys listed below.

- F1: General Help
- F5: Previous Value
- F6: Default Settings
- F7: Turbo Settings
- F10: Save
- ESC: Exit

In the next section, we introduce the details of the BIOS configuration.

Modifying the BIOS Main Settings

Basic Configuration

After entering the BIOS Setup Utility, or after choosing the “Main” option, the BIOS main menu will be displayed. Use this menu to check the basic system information, such as the memory and IDE hard drive. In addition, you can take care of basic system configuration, such as setting the date, time, hard drive settings, display type, and system security settings.

System Security

To set up system security, select the “Security” option under “Main” to bring up the following screen.

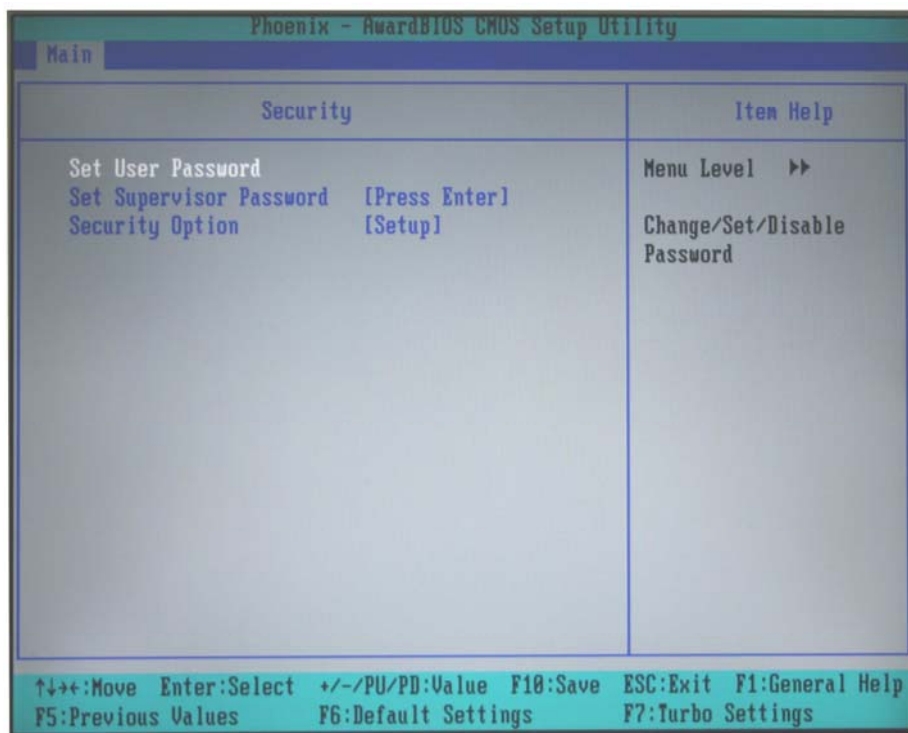

The menu includes three options: “Set User Password,” “Set Supervisor Password,” and “Security Option.” A “User Password” can be used to enter the BIOS setup menu, but not to change settings. A “Supervisor Password” can be used to modify the BIOS settings.

When you select the change password option, the following message will appear on the screen: “Type the password, up to eight characters in length, and press <Enter>.” The password that you type will replace the password stored in the CMOS memory. You will be required to confirm the new password. Just re-type the password and then press <Enter>. You may also press <Esc> to abort the selection and not enter a password.

To clear an existing password, just press <Enter> when you are prompted to enter the password. A message will show up confirming that the password will be disabled. Once the password is disabled, the system will boot and you can enter the “BIOS Setup Menu” without entering a password.

Once a password has been set, you will be prompted to enter the password each time you enter Setup. This prevents unauthorized persons from changing any part of your system configuration. In addition, when a password setting is enabled, you can set up the BIOS to request a password each time the system is booted up. This prevents the unauthorized use of your computer. The "Security Option" setting determines when a password prompt is required. If the "Security Option" is set to "System," the password must be entered both at boot up and when entering the BIOS Setup Menu. If the password is set for "Setup," the password prompt only occurs when you enter the "BIOS Setup Menu."

Modifying the BIOS Advanced Settings

The "Advanced Features" screen will appear when you choose "Advanced" from the main menu.

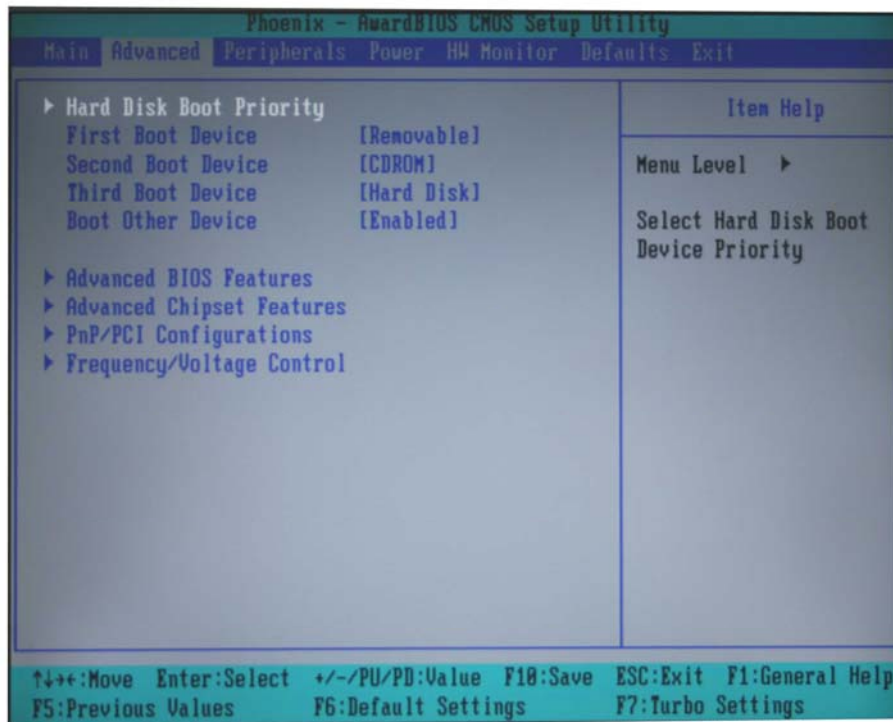

Hard Disk Boot Priority

First / Second / Third Boot Device

This option allows users to select or change the device boot priority. You may set 3 levels of priority to determine the boot up sequence for different bootable devices, such as a hard drive, CD-ROM, and removable devices. Select the order in which devices will be searched in order to find a boot device. The available options are "Removable (default for first boot device)," "Hard Disk (default for third boot device)," "CDROM (default for second boot device)," and "Disabled."

Boot Other Device

This setting allows the system to try to boot from other devices if the system fails to boot from the 1st, 2nd, or 3rd boot devices. The options are "Enabled (default)" and "Disabled."

Advanced BIOS Settings

When you select the “Advanced BIOS Features” option under the “Advanced” menu, the “Advanced” configuration menu will appear.

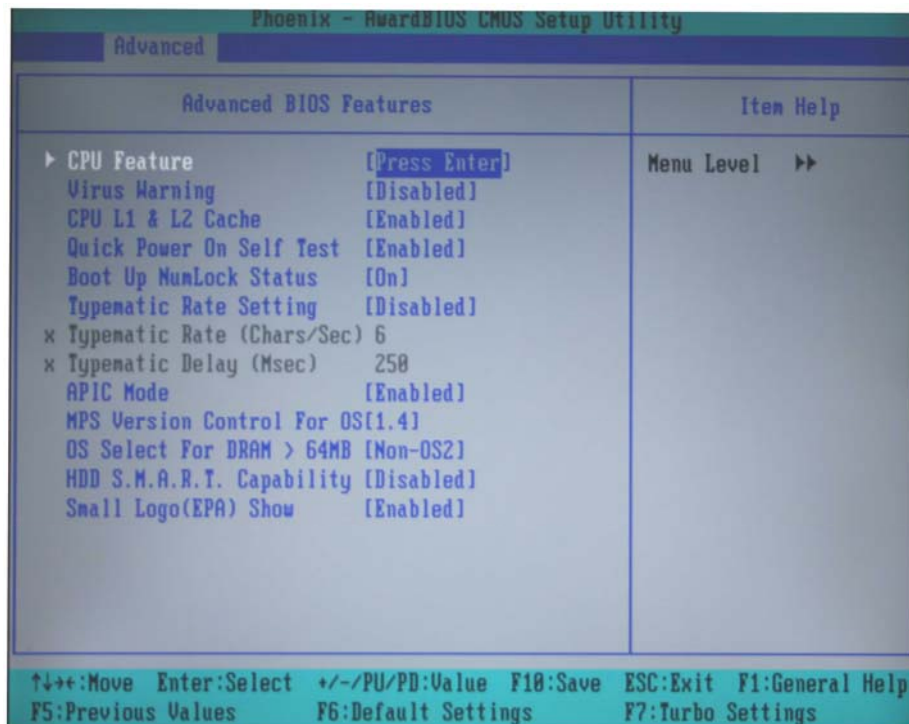

CPU Feature

“Press Enter” to configure “CPU Feature” settings.

Virus Warning

The “Virus Warning” setting will protect the IDE Hard Disk boot sector. If an attempt is made to write data into the boot sector, the BIOS will display a warning message on the screen, and the BEEP warning function will be enabled.

CPU L1 & L2 Cache

If the CPU has a cache, then activating the cache will improve performance. The cache can be activated or deactivated from within the BIOS. For CPU's that do not have a cache, activating the cache from the BIOS will have no influence on performance.

Quick Power On Self Test

This setting allows the system to skip certain tests while the system boots up. Disable this feature to speed up the boot up process.

Boot Up NumLock Status

This setting determines the status of “NumLock” after the system powers up. When set to “On” the “Numpad keys” act as number keys. When set to “Off” the “Numpad keys” will act as arrow keys.

Typematic Rate Setting

Enable the “Typematic Rate Setting” to adjust “Typematic Rate” and “Typematic Delay.” These settings determine the repeat rate when depressing any key. Disable this feature to keep the factory default values of 6 for “Typematic Rate” and 250 for “Typematic Delay.”

APIC Mode

Use the “MPS version control for OS” drop-down box to configure this option. There are two options: 1.1 and 1.4. The default value is 1.4.

- 1.1: The old version; support 8 additional IRQs in the Windows NT environment.
- 1.4: The newest version; supports Windows 2000 and Windows XP.

OS Select For DRAM > 64MB

This is a special setting for OS2 systems. Only select “OS2” if you are running an OS/2 system with more than 64 MB of RAM. For other operating systems, select the “Non-OS2” option.

HDD S.M.A.R.T. Capability

“S.M.A.R.T.” means “Self Monitoring Analysis and Reporting Technology.” It is designed to predict the possible failure of storage drives.

Small LOGO (EPA) Show

When this option is enabled, the small EPA LOGO will appear.

Advanced Chipset Settings

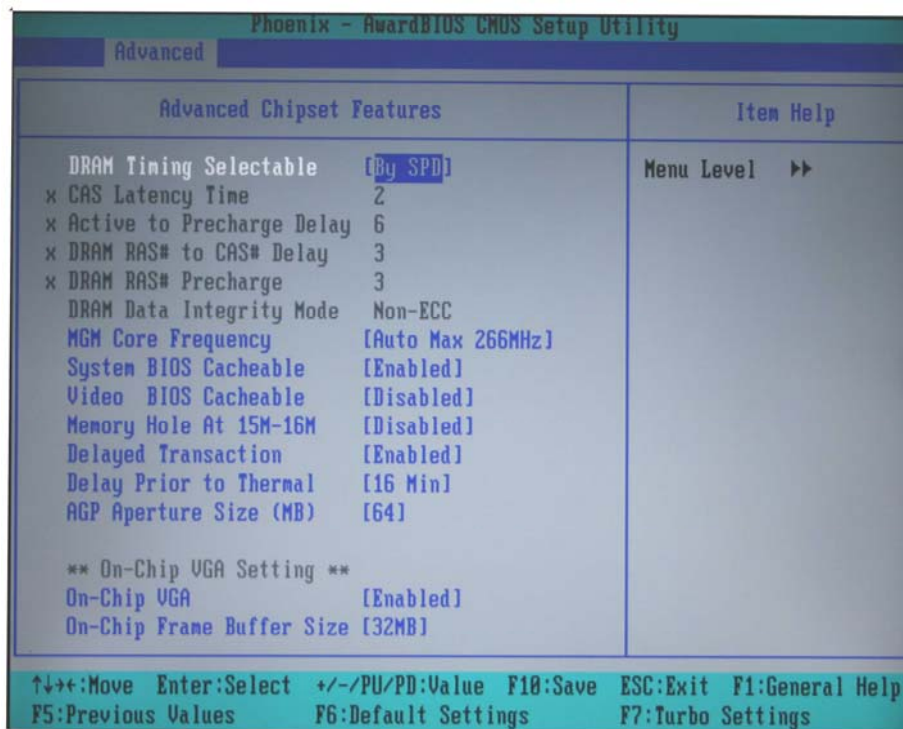

DRAM Timing Selectable

It allows user to configure the DRAM clock / timing. To choose "By SPD" if the memory module support "SPD" (Serial Presence Data), or choose "Manual" to do the advanced configuration described below. The default is "By SPD".

CAS Latency Time

It is used to decided CAS Latency when installing the synchronous DRAM. The number of clock cycles of CAS latency depends on the DRAM timing. Usually it is not suggested to change / reset this field from the default value due to the system stability.

Active to Precharge Delay

It allows to select DRAM Active to Precharge Delay by selecting 7, 6 or 5.

DRAM RAS# to CAS# Delay

The delay time between the CAS and RAS strobe signals will determine if the DRAM is written to, read from, or refreshed. The delay time value can be set to "2" or "3."

DRAM RAS# Precharge

The ROW address strobe (RAS) must be precharged before the DRAM is refreshed. An incorrect setting will cause the data to be incomplete. The DRAM RAS# precharge time can be set to "2" or "3."

DRAM Data Integrity Mode

Choose "Non-ECC" while installing the "unbuffered / non-ECC" memory module to configure the system to auto detect the Non-ECC DRAM mode. User's will only be allowed to select the "Non-ECC" or "With-ECC" modes while installing the "unbuffered / with-ECC" memory module. The system default is "Non-ECC."

MGM Core Frequency

Use this setting to configure the frequency of the DRAM memory. The default setting is "Auto Max 266MHz."

System BIOS Cacheable

When enabled, the BIOS ROM addresses F0000H-FFFFFFH are cached and the cache controller is enabled to access the system. The default value is "Enabled." Use the Enabled option to speed up system performance.

Video BIOS Cacheable

Enabling this feature will allow the caching of the video BIOS and may improve performance. A system error could occur if another program writes to this memory cache area. The default value is "Disabled."

Memory Hole at 15M-16M

When this feature is enabled, the system will reserve a system memory area for the ISA adapter ROM, and this memory area will not be open for caching. The system default is "Disabled."

Delayed Transaction

The chipset has an embedded 32-bit posted write buffer to support delay transaction cycles. The default setting of "Enabled" supports compliance with PCI specification version 2.1.

Delay Prior to Thermal

Select the delay time before thermal activation due to high temperatures. Users may select "4 Min," "8 Min," "16 Min," or "32 Min." The default value is "16 Min."

AGP Aperture Size (MB)

"AGP" stands for "Accelerated Graphics Port" This feature allows the determination of the aperture size. The aperture is a portion of the PCI memory address range dedicated to address space for graphics memory. Host cycles that hit the aperture range are forwarded to the AGP without any translation. The options are 4, 8, 16, 32, 64, 128, and 256. The default value is 64.

On-Chip VGA

This system chipset supports the integrated graphics controller. The default setting is "Enabled."

On-Chip Frame Buffer Size

This setting determines the frame buffer size for the VGA function, and will share the system memory. The default setting is 32 MB. The value can be changed to 1 MB, 4 MB, 8 MB, or 16 MB.

PnP/PCI Configurations

This option is used to configure the PCI parameters. You will see the following figure after selecting this option.

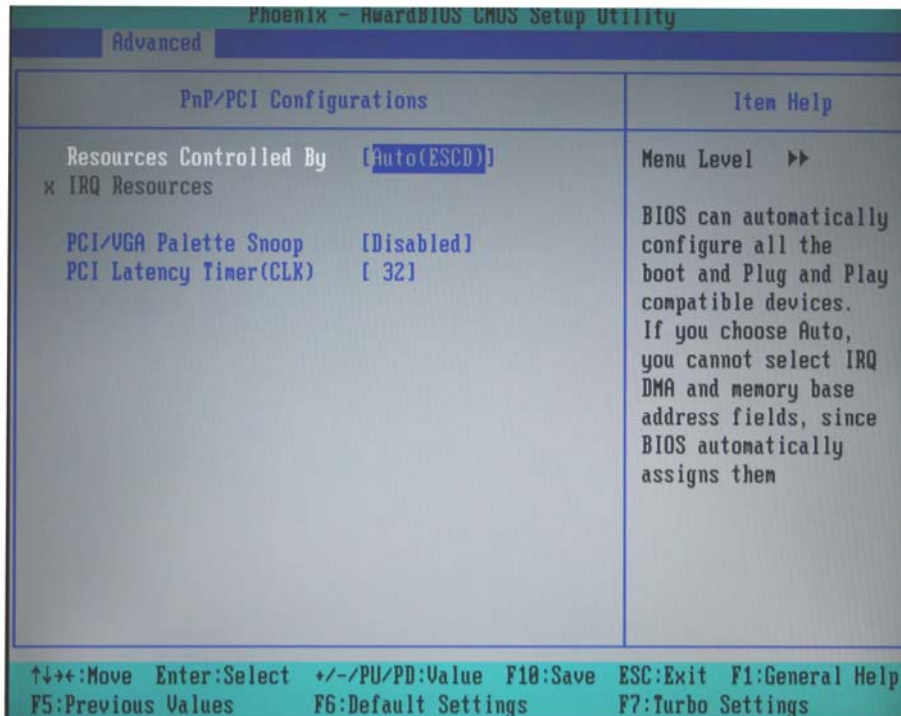

Resources Controlled By

When the default setting of “Auto (ESCD)” is selected, the system BIOS will automatically assign the IRQ, DMA, and base address resources for all compatible PnP / PCI devices when the system boots up. If the automatic assignments cause conflicts between different devices, then change the setting to “Manual,” and assign the IRQ, DMA, and memory base address manually.

IRQ Resources

Set “Resources Controlled By” to “Manual” to assign IRQ resources manually. IRQ settings of 3, 4, 5, 7, 9, 10, 11, 12, 14, or 15 can be used for PCI devices. When configuring this setting, be careful to avoid IRQ conflicts.

PCI / VGA Palette Snoop

Some graphics controllers that are not VGA compatible take the output from a VGA controller and map it to their display as a way to provide boot information and VGA compatibility. For an integrated graphics controller chipset, the default is “Disabled.”

PCI Latency Timer (CLK)

Configure PCI Latency Time to optimize the PCI speed. The range of possible values is “0-255” with a default value of “32.”

Frequency/Voltage Control

Configure the “Spread Spectrum” setting on this page. Select “Enabled” to reduce the EMI (Electromagnetic Interference). The default is “Enabled”:

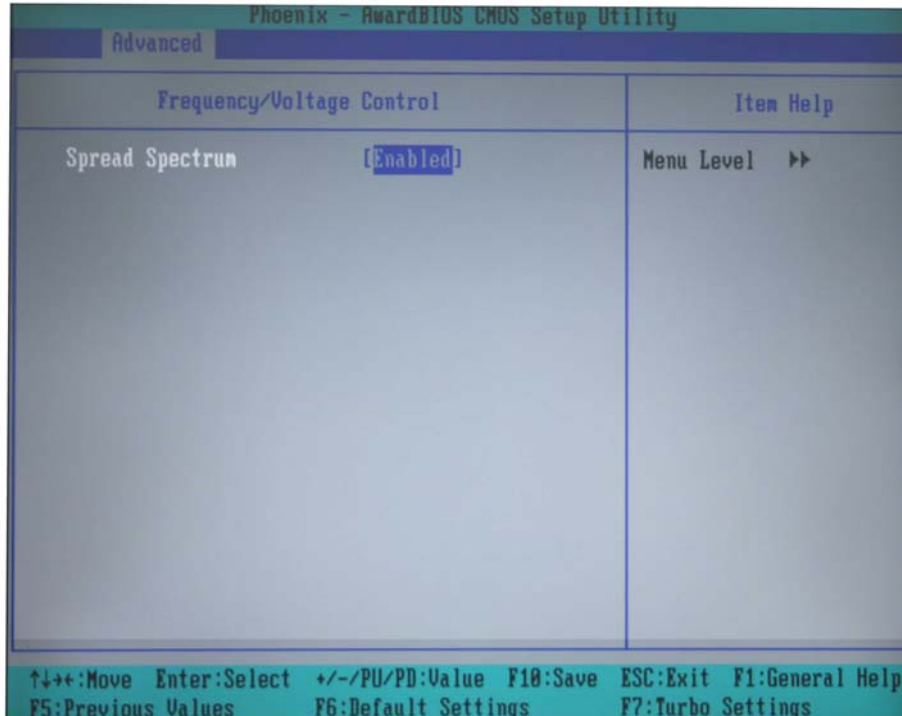

Configuring Peripherals

You may adjust the relevant settings of integrated peripherals after selecting the "Peripherals" option from the BIOS main menu. Select from the following options: "OnChip IDE Device," "Onboard Device," and "Onboard I/O Chip Setup."

OnChip IDE Device

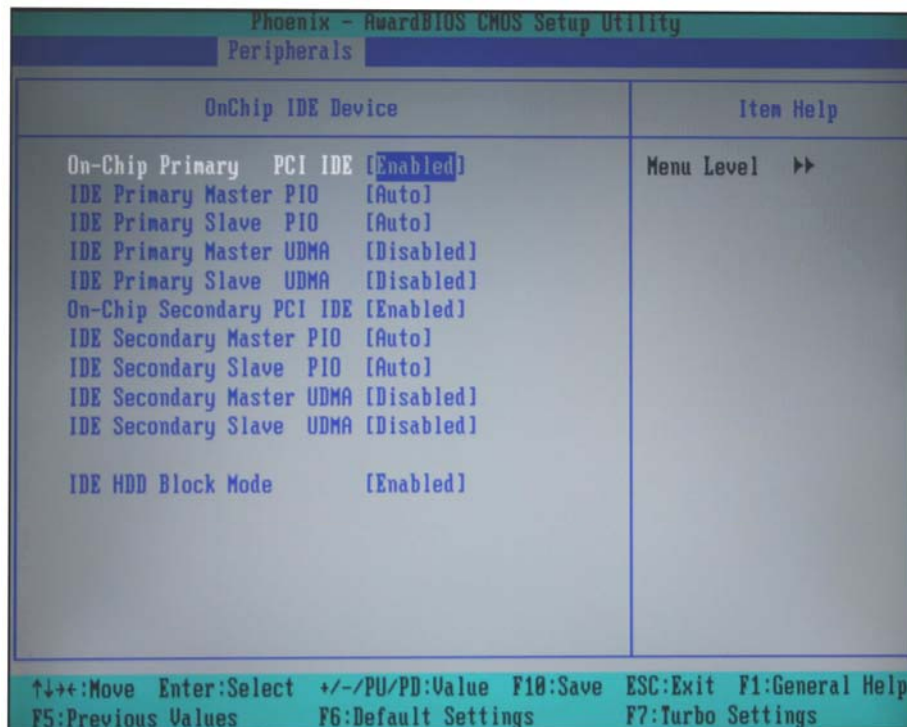

On-Chip Primary/Secondary PCI IDE

The system has 2 PCI IDE interfaces: Primary IDE and Secondary IDE. Select "Enabled" to activate the first and / or second IDE interface. Select "Disabled" to deactivate it. The default setting is "Enabled."

IDE Primary/Secondary Master/Slave PIO

Each IDE interface can connect to 2 IDE devices, with one device called "master," and the other device called "slave." The IDE PIO (Programmed Input / Output) lets you set a PIO mode (0-4) for each of the IDE devices that the onboard IDE interface supports. Modes 0 to 4 will increase performance incrementally. The Auto mode will allow the system to determine the best mode for each IDE device automatically. This is the default setting.

IDE Primary/Secondary Master/Slave UDMA

This system supports Ultra DMA 100 functionality, and the operating environment requires a DMA driver if you are using Windows 95 OSR2 or a third party IDE bus master device. If both the IDE device and system software support Ultra DMA 100, select "Auto" to enable the BIOS support. The default setting is "Auto."

IDE HDD Block Mode

IDE HDD Block mode is used for block transferring, multiple commands, and multiple sector read/write. When this option is enabled, the IDE device will support block mode and the system will automatically optimize block number size to read and write per sector. The default setting is "Enabled."

Onboard Device

The "Peripherals" menu is shown below. The various parameters are described below the figure.

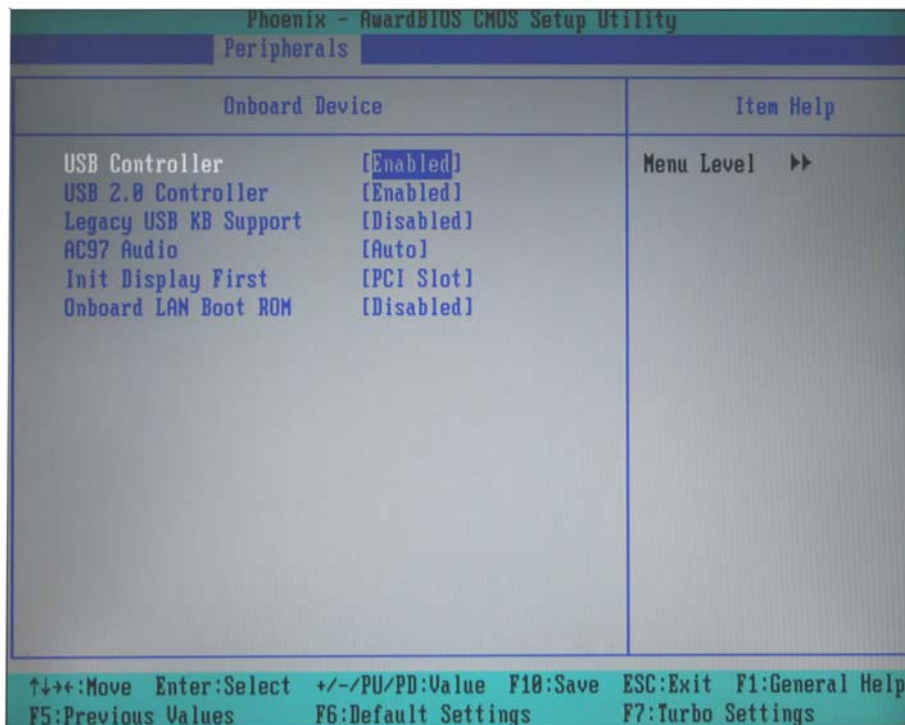

USB Controller

Use this option to enable the USB port. The default is "Enabled."

USB 2.0 Controller

Enable this option to detect USB 2.0 compliant devices. You will need to disable this feature if you install a USB 1.1 device. The default setting is "Enabled."

Legacy USB KB Support

This option is only useful for DOS systems. Enable it if you want to use a USB keyboard under a DOS environment. The default setting is "Disabled."

AC97 Audio

Set this option to "Auto" to enable the onboard AC'97 audio. The default setting is "Auto."

Init Display First

This option applies only to systems that support multiple video cards. Since the V481 only supports one video card, you do not need to configure this setting.

Onboard LAN Boot ROM

Select the "Enabled" option to invoke the onboard Boot ROM over the LAN interface.

Onboard I/O Chip Setup

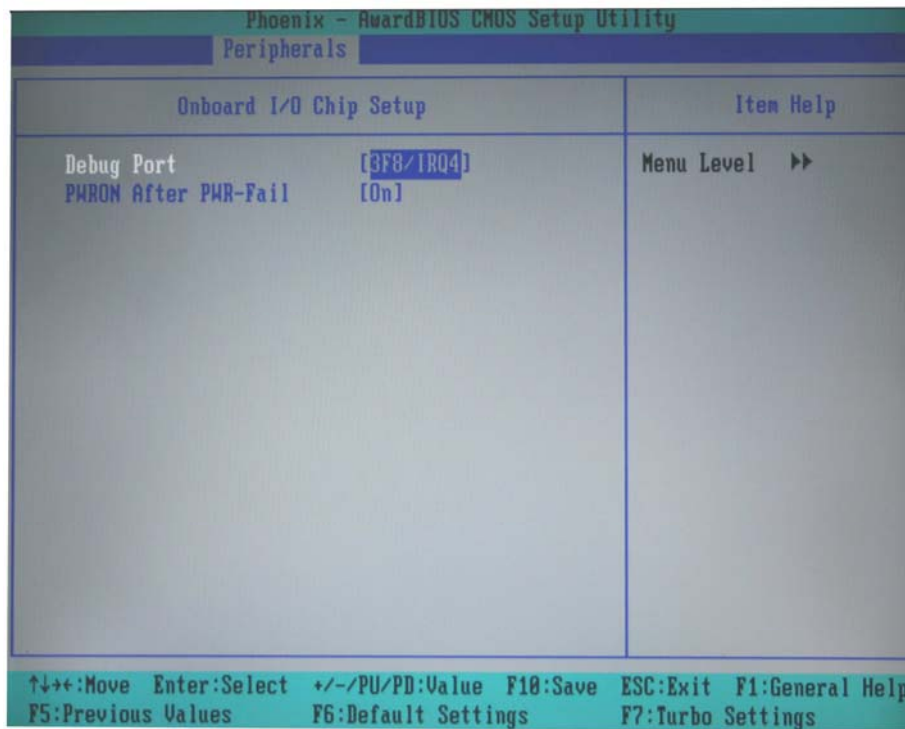

Debug Port

Select an address and corresponding interrupt for this debug port. This port is only for engineers who are debugging programs. The default setting is "3F8/IRQ4."

PWRON After PWR-Fail

Setting this parameter to "On" will cause the system to boot up immediately after power is restored after a power failure, regardless of whether the system status is on or off. If set to "Former-Sts," the system will be restored to the status that existed before the power failure. The default setting is "On."

Power Management

The power management settings are configured on the “Power” page, as shown in the figure shown below. Use the settings on this page to configure your system to use energy management features and power on/off options.

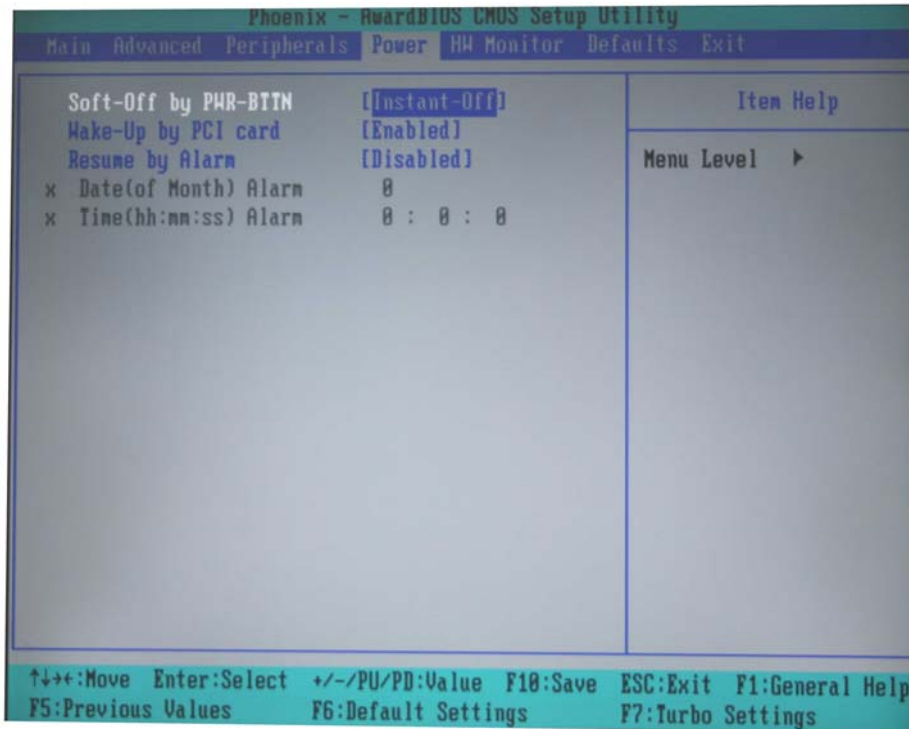

Soft-Off by PWR-BTTN

Select the “Instant-Off” option if you would like the system to power down immediately after pushing the power button. Select the “Delay 4 Sec” option so that you must push the power button continuously for at least 4 seconds before the system powers down. The default setting is “Instant-Off.”

Wake-Up by PCI card

Enable this feature to wake up the system with an onboard LAN signal from a remote host. The default setting is “Enabled.”

Resume by Alarm

When this parameter is set to “Enabled,” you can set the date and time at which the RTC (real-time clock) alarm will awaken the system from suspend mode. The system default is “Disabled.”

Date (of Month) Alarm

Set the “month” for the “Resume by Alarm” function.

Time (hh: mm: ss) Alarm

Set the hour, minute, and second for the “Resume by Alarm” function.

HW Monitor

The “HW Monitor” page is shown as below. Refer to this page to view the system hardware status, and effect changes in real-time.

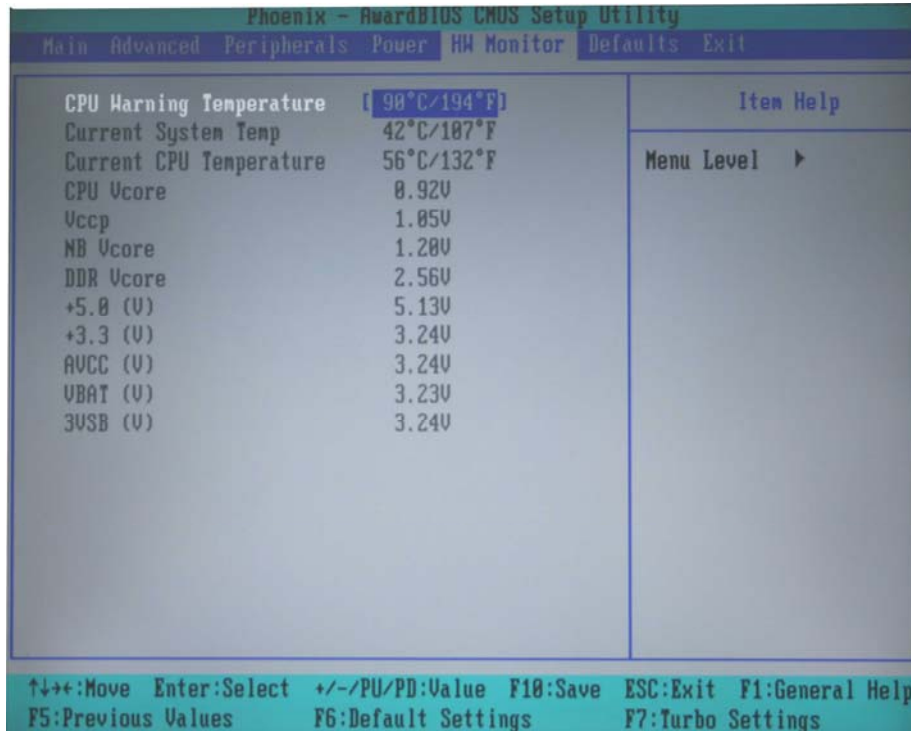

Phoenix - AwardBIOS CMOS Setup Utility		
Main Advanced Peripherals Power HW Monitor Defaults Exit		
CPU Warning Temperature	[90°C/194°F]	Item Help
Current System Temp	42°C/107°F	
Current CPU Temperature	56°C/132°F	Menu Level ▶
CPU Vcore	0.92V	
Vccp	1.05V	
NB Vcore	1.20V	
DDR Vcore	2.56V	
+5.0 (V)	5.13V	
+3.3 (V)	3.24V	
AVCC (V)	3.24V	
VBAT (V)	3.23V	
3USB (V)	3.24V	

↑↓:Move Enter:Select +/-/PU/PD:Value F10:Save ESC:Exit F1:General Help
F5:Previous Values F6:Default Settings F7:Turbo Settings

CPU Warning Temperature

To prevent the system from reaching an overheated state, configure the CPU warning temperature. A typical value is between 90 and 100°C.

Load Defaults

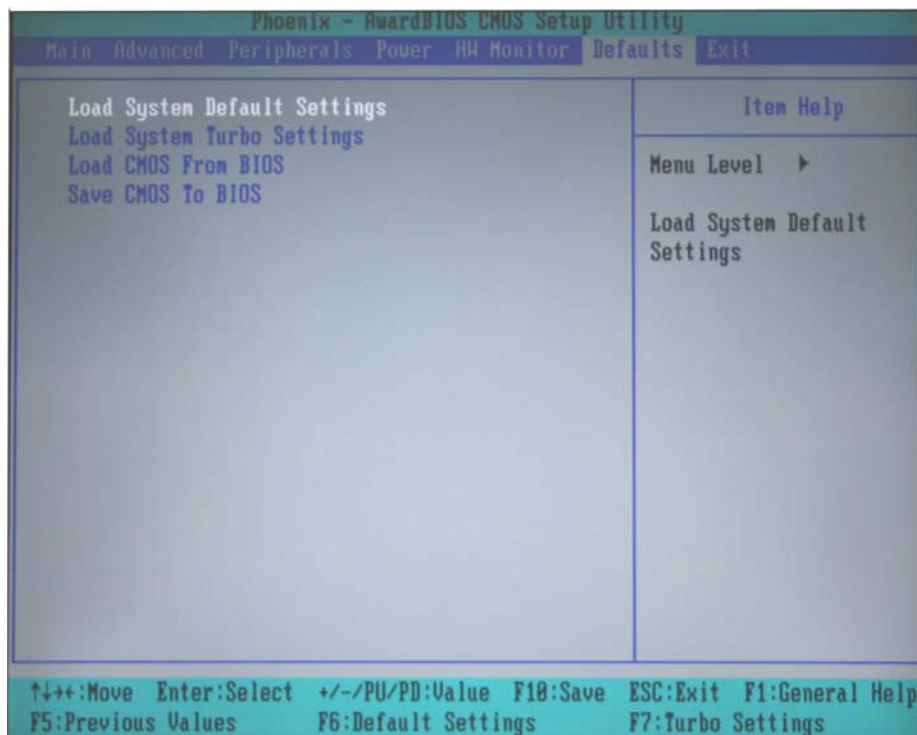

Load System Default Settings

Use this option to load system factory default settings instead of the current BIOS settings. This option is useful for when the system is unstable. Users do not need to remember what settings were active before the system fails.

Load CMOS From BIOS

Use this option to load defaults from the flash ROM.

Save CMOS To BIOS

Use this option is to save CMOS defaults to the flash ROM.

Exiting the BIOS Setup

To exit the BIOS setup utility, choose " Exit." Pressing <ESC> will achieve the same result.

Upgrading the BIOS

In this chapter, we describe how to upgrade the bios.

NOTE: The **HP USB Disk Storage Format Tool** can be downloaded from HP's website. To find the tool, link to www.hp.com and use the website's search tool with keyword "HP USB Disk Storage Format Tool" to search and download the tool.

1. Create a bootable USB disk:
 - a. Copy **kernel.sys** and **commond.com** to a specified directory.
 - b. Start the HP USB Disk Storage Format Tool.
 - c. Select the USB device that you want to use as a bootable disk in the Device drop down box.
 - d. Select **FAT** in the File system drop down box.
 - e. Type the disk name in the Volume label field.
 - f. Check the option "Create a DOS startup disk" under format options.
 - g. Specify the directory for the "include" system files.
 - h. Click "start" to format the USB disk.
 - i. Copy the "ce5boot" directory to the USB disk.

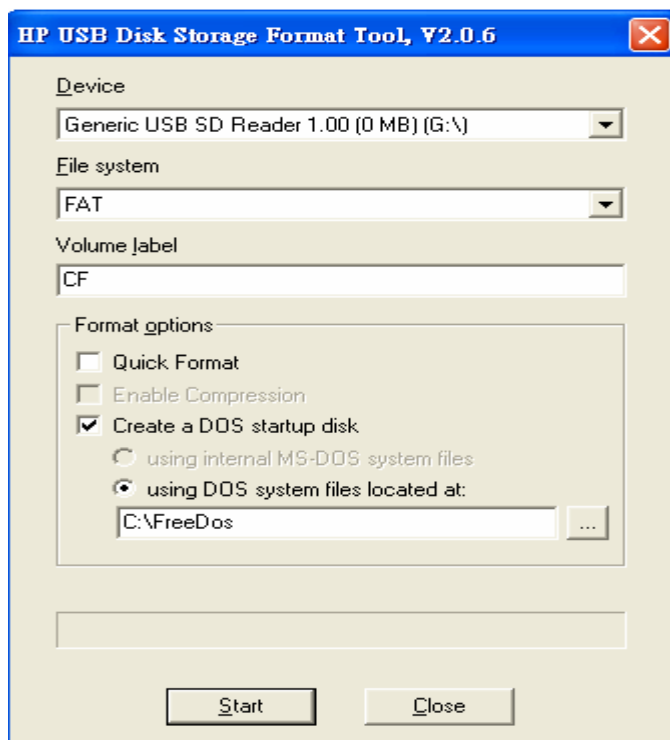

2. Bios setup for the series.
 - a. Double click to extract the bios update tool file. In Windows, the file will have the form xxx.ZIP.
 - b. The self-extractable file extracts 3 files, including xxx.BIN, awdflash.exe, moxaud.bat, which should be saved to the USB disk
 - c. Insert the USB disk.
 - d. Power on the computer and then press “DEL” to enter the bios setup menu.
 - e. Select “Advanced → Hard Disk Boot Priority” and then press “Enter.”
 - f. From the setup menu, use “↑” or “↓” to select the USB device
 - g. Press “+” to move an item up to the first priority, and press “ESC” to exit the setup menu.
 - h. Make sure the first boot device is “Hard Disk.” If not, press “Enter” to change it.
 - i. Select “Exit → Save & Exit Setup” and press “Enter.”
 - j. choose “Y” to save to CMOS and then exit.

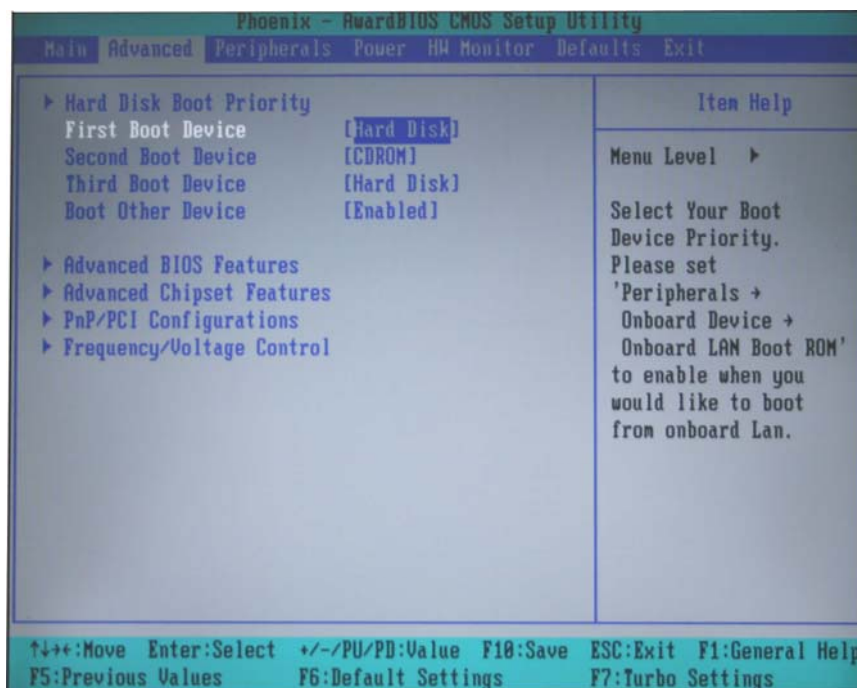

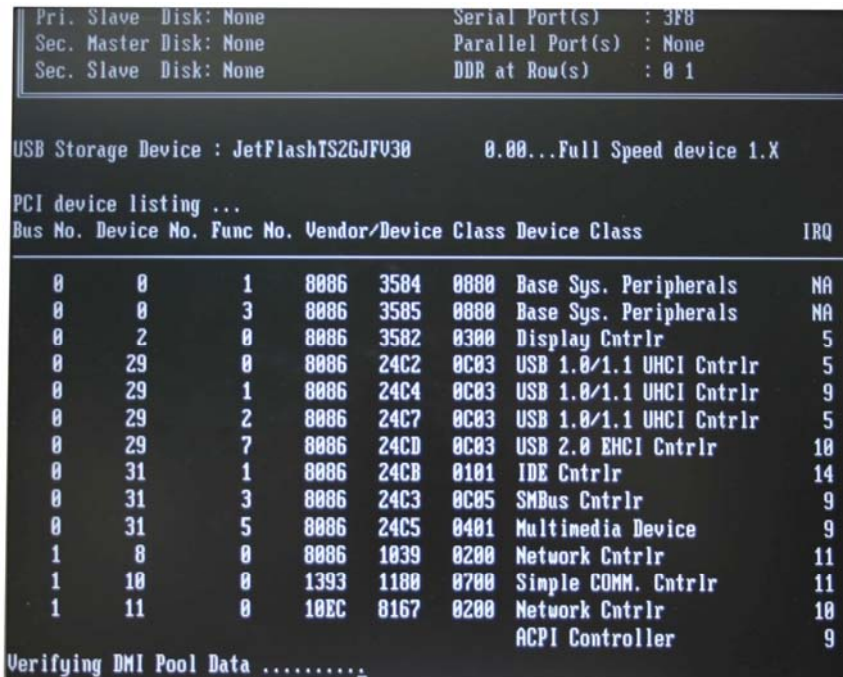
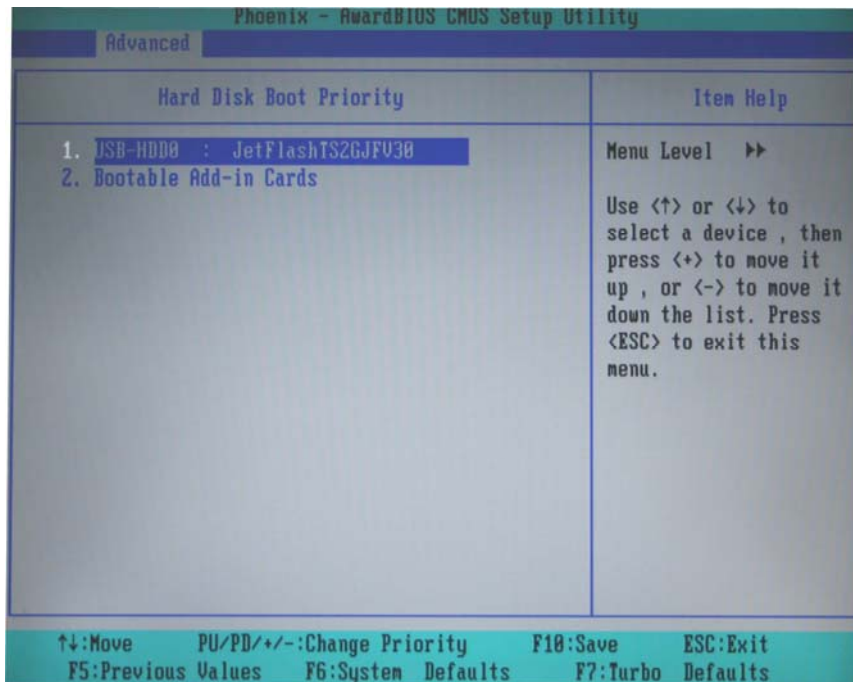

3. Run awdflash.exe to update the bios
 - a. Boot from the USB disk in pure DOS mode.
 - b. Run "awdflash /?" to see the help menu (P.1).
 - c. run "awdflash xxxxxxxx.bin" from the command line to update the bios.
 - d. Press the "F1" key to reset the system after the bios update is completed (P.2).
 - e. Press the "DEL" key to enter the bios setup menu after resetting (P.3).
 - f. Select "Defaults → Load System Default Settings" and then choose "Y" after pressing "Enter" (P.4).
 - g. Select "Exit → Save & Exit Setup" and then press "Enter" to choose "Y" to save to CMOS and exit (P.5).

```

AWDFLASH v8.60L (03/02) (C)Phoenix Technologies Ltd. 2004 All Rights Reserved

Usage:  AWDFLASH [FileName1] [FileName2] [/<sw>[/<sw>...]]
        FileName1 : New BIOS Name For Flash Programming
        FileName2 : BIOS File For Backing-up the Original BIOS
<Switches>  ? : Show Help Messages
py: Program Flash Memory          pn: No Flash Programming
sy: Backup Original BIOS To Disk File  sn: No Original BIOS Backup
Sb: Skip BootBlock programming      Wb: Always Programming BootBlock
cd: Clear DMI Data After Programming  cc: Clear CMOS Data After Programming
cp: Clear PnP(ESCD) Data After Programming
LD: Destroy CMOS Checksum And No System Halt For First Reboot
    After Programming              Tiny: Occupy lesser memory
QI: Qualify flash part number with source file
E: Return to DOS After Programming    R: RESET System After Programming
F: Use Flash Routines in Original BIOS For Flash Programming
cks: Show update Binfile checksum  cksXXXX: Compare Binfile CheckSum with XXXX

NUMAC:XXXXXXXXXXXXXXXXX          NUGUID:XXXXXXXXXXXXXXXXX
        Support nForce Input MAC,GUID Function,with "/wb" to update MAC and GUID.

Example: AWDFLASH 6A69R000.bin /py/sn/numac:XXXXXXXXXXXXXXXXX/wb
C:\>

```

