

Process Signals Source

1 Introduction

This process signals source (the calibrator in the following) is a handheld, battery-operated instrument that sources electrical and physical parameters.

Features:

✓ Source DC voltage, DC current, resistance, simulate Transmitter, TC, RTD, frequency, pulse and switch.

Others features:

✓ Big LCD can display the TC/RTD measurement value and mV/Ω corresponding simultaneously; mA and mA% simultaneously.

✓ TC source terminals and built-in lead connector of same temperature (RJ compensation with auto-reference joint point)

✓ Manual step source and auto -step and sweeping –step source

✓ Room temperature monitoring under any operation

2 Contact Us

To purchase parts, obtain operation help or address of the vendor or service center nearest to you, please call us or visit our web (see the bottom page of the Manual).

3 Standard Accessories

Make sure that the package contains all the accessories listed below. And if you find they are damaged or any of them is missing, please contact the vendor from which you purchased the product as soon as possible. Refer to the replacing part list in 15.3 in the Manual if you want to order the replacing parts.

- ✓ One set of Industrial testing Lead (CL727220)
- ✓ A set of Testing Lead (Tp727110)
- ✓ A set of Alligator clip (CC807130)
- ✓ A quick reference guide
- ✓ A User's Manual
- ✓ One Fuse 50mA/250V
- ✓ One Fuse 63mA/250V

4 Safety Information



For the correct and safe use of the instrument, be sure to follow the cautionary notes stated in this manual whenever handling the instrument. The Company shall not be held liable for any damage resulting from use of the instrument in a manner other than prescribed in the cautionary notes.

A **⚠Warning** identifies conditions and actions that pose hazards to the user; a **Caution** identifies conditions and actions that may damage the meter or the equipment under test.

Refer to Table 1 for the explanation of the international electric symbols adopted by the calibrator or the user's

manual.

Table 1 Explanations of International Electrical Symbols

	EARTH GROUND		WARNING INFORMATION
---	--------------	---	------------------------

 Warning

To avoid possible electric shock or personal injury:

- ✓ Do not apply more than the rated voltage, as marked on the calibrator, between terminals or between any terminal and earth ground;
- ✓ Follow all equipment safety procedures;
- ✓ Do not connect the probe of the testing lead with any live power when the other end has been inserted into the current jack;
- ✓ Do not use the meter if it is damaged. Before using the meter, inspect the case. Look for cracks or missing plastic. Pay particular attention to the insulation surrounding the connectors;
- ✓ Make sure the battery door is closed and latched before operating the meter;
- ✓ Remove test leads from the meter before opening the battery door;
- ✓ Inspect the test leads for damaged insulation or exposed metal. Check test lead continuity. Replace damaged test leads before using the meter;
- ✓ When using the probes, keep fingers behind the finger guards on the probes;
- ✓ Connect the common test lead before connecting the live test lead. When disconnecting test leads, disconnect the live test lead first.
- ✓ Do not use the meter if it operates abnormally. Protection may be impaired. When in doubt, have the

meter inspect.

- ✓ Do not operate this instrument in areas where inflammable or explosive gases or vapor exists. It is extremely hazardous to use the instrument under such environments;
- ✓ Do not operate the meter around explosive gas, vapor, or dust;
- ✓ Use only type 4 AAA batteries, properly installed in the meter case, to power the meter;
- ✓ Do disconnect the testing lead before shifting to different source functions;
- ✓ When servicing the meter, use only specified replacement parts.
- ✓ To avoid false reading, which could lead to possible electric shock or personal injury, replace the batteries as soon as the low battery indicator () appears.

Caution

To avoid possible damage to meter or to equipment under test:

- ✓ Use the proper jacks, functions, and ranges for the mA source operation.

5 Familiar With the Calibrator

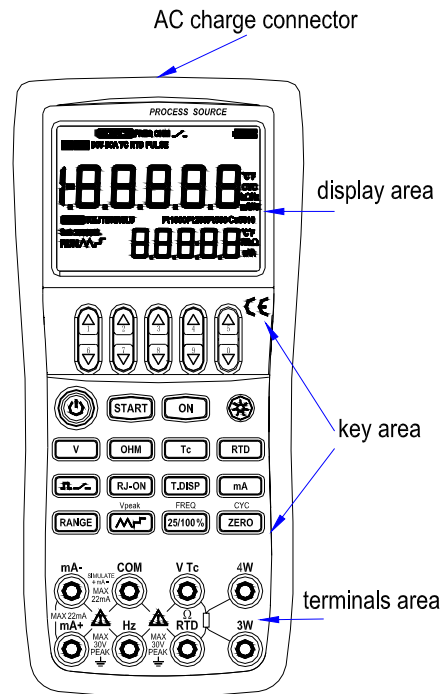

Figure 1 Entire Graph

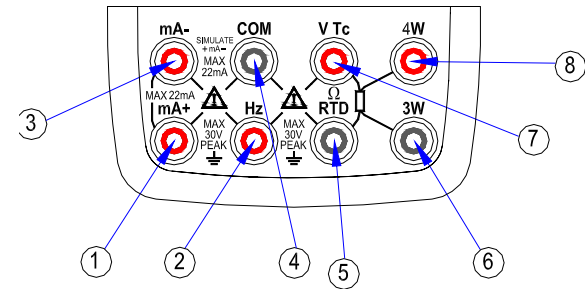

Figure 2 Source Terminals

5.1 Source Terminals

Figure 2 shows the source terminals of the calibrator. Table 2 explains their use.

Table 2 Source Terminals

Terminal	Function
①	Source Signals: (+) DcmA
②	Source Signals: (+) FREQ、PULSE、SWITCH
③	Source Signals: (-) DcmA
④	All the common (return) (-) terminals of source function
⑤	Source Signals: (-) OHM、RTD
⑥	Source Signals: 3W Terminal
⑦	Source Signals: (+) OHM、RTD、DCV、TC
⑧	Source Signals: 4W Terminal

5.2 Keys

Figure 3 shows keys of the calibrator. Table 3 explains their use.

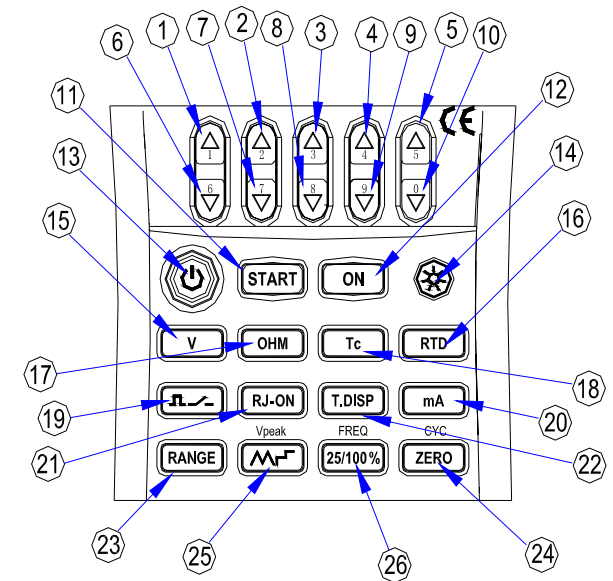



Figure 3 keys

Table 3 Functions of the keys

No.	Name	Function
1~5	Source value set key	Increment of source set point
6~10	Source value set key	Decrement of source set point
11	Source START key	Source auto-pulse number, turn on mA auto-stepping or sweeping function.
12	Source ON key	Turn on or off source function
13	Power key	Turn on or off the power
14	Backlight key	Turn on or off the backlight
15	Source V key	Select DC-voltage source function
16	Source RTD key	Select RTD source function
17	Source OHM key	Select resistance source function
18	Source TC Key	Select TC source function
19	Source  Key	Select pulse number, frequency or switch source function
20	Source mA Key	Select mA source function
21	RJ-ON Key	In TC source function, turn on or off the RJ compensation function.
22	T.DISP key	In TC/RTD source function, press the key , convert the room temperature and the mV/Ω value ; In mA source function, press the key , convert the mA%

		value and room temperature; In others source function, press the key, convert the room temperature or display is close.
23	Source RANGE Key	Select source range
24	Zero Key	Set the source value to default. In pulse source function, set the pulse number.
26	 Key	In DCmA source function ,select the auto-wave mode. In frequency , pulse or switch source function , set the source amplitude.
27	25/100% Key	In mA source function, select 25% or 100% manual step output mode. In pulse number, frequency or switch source, set the frequency value.

5.3 Display Screen

Figure 4 shows a typical display screen.

- a: Source
- b: Source Frequency
- c: Source Resistance
- d: Source Switch
- e: Battery level indicator
- f: Source function on

- g: Source function off
- h: Source DC voltage
- i: Source DC current
- j: Source TC
- k: Source RTD
- l: Source Pulse
- m: Set -point for source
- n: Unit of set -point for source
- o: Reference Junction Compensation On
- p: Types of TC source
- q: Types of RTD source
- r: DCmA 25%or 100% manual step source
- s: DCmA auto-stepping or sweeping source
- t: Source assistance districts
- u: Source unit of assistance district
- v: Source number of pulses / stort DCmA auto-stepping or sweeping source function

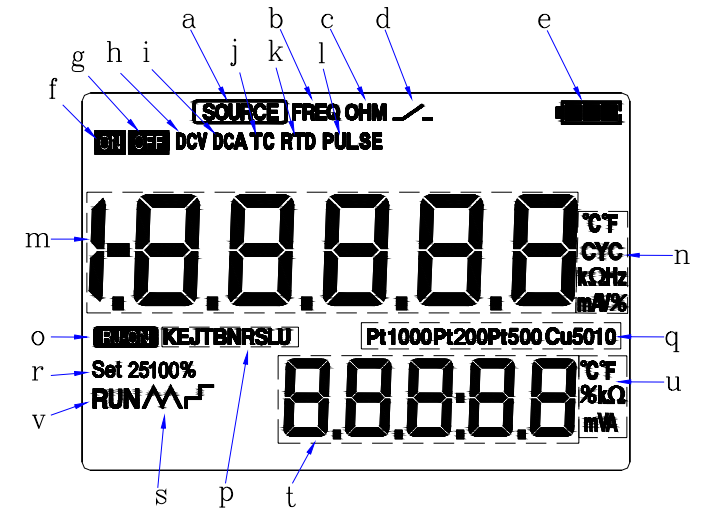

Figure 4 typical LCD display

6 Before starting source

Operating Precautions

Precautions for Safe Use of the Instrument

- ✓ When using the instrument for the first time, be sure to read the instructions given in Section Four

“Precautions for Safe Use of the Instrument.”

- ✓ Do not open the instrument’s case.
Contact the vendor from which you purchased the instrument, for a service of inspecting or adjusting the internal assembly.
- ✓ In case of failure
Should the instrument begin to emit smoke, give off an unusual odor, or show any other anomaly, immediately turn off the POWER key. If you are using an Charger, disconnect the plug from the wall outlet. Also cut off power to the object under test that is connected to the input terminals. Then, contact the vendor from which you purchased the instrument.
- ✓ Charger
Use an Charger dedicated to the instrument. Avoid placing any load on the Charger, or prevent any heat-emitting object from coming into contact with the adapter.

General Handling Precautions

- ✓ Before carrying around the instrument turn off power to the object under test, and then the POWER key of the instrument. If you are using an Charger, disconnect the power cord from the wall outlet. Finally, detach all lead cables from the instrument. Use a dedicated carry case when transporting the instrument.
- ✓ Do not bring any electrified object close to the input terminals, since the internal circuit may be destroyed.
- ✓ Do not apply any volatile chemical to the instrument’s case or operation panel. Do not leave the instrument in contact with any product made of rubber or vinyl for a prolonged period. Be careful not to let a soldering iron or any other heat-emitting object come into contact with the operation panel, as the panel is made of thermoplastic resin.

- ✍ Before cleaning the instrument's case or operation panel disconnect the power cord plug from the wall outlet if you are using an Charger. Use a soft, clean cloth soaked in water and tightly squeezed to gently wipe the outer surfaces of the instrument. Ingress of water into the instrument can result in malfunction.
- ✍ If you are using an Charger with the instrument and will not use the instrument for a prolonged period, disconnect the power cord plug from the wall outlet.
- ✍ For handling precautions regarding the batteries, see "Installing or Replacing the Batteries".
- ✍ Never use the instrument with the cover of the battery holder opened.

Environmental Requirements

Use the instrument in locations that meet the following environmental requirements:

- ✍ Ambient temperature and humidity

Ambient temperature range: 0 to 50°C

Ambient humidity range: 20 to 80% RH. Use the instrument under non-condensing condition.

- ✍ Flat and level locations

Do not use the instrument in locations that are

- ✍ Exposed to direct sunlight or close to any heat source.
- ✍ Exposed to frequent mechanical vibration.
- ✍ Close to any noise source, such as high-voltage equipment or motive power sources.
- ✍ Close to any source of intensive electric or electromagnetic fields.
- ✍ Exposed to large amounts of greasy fumes, hot steam, dust or corrosive gases.
- ✍ Exposed to unstable or a risk of explosion due to the presence of flammable gases.

Note:

- ✓ Use the instrument under the following environmental conditions if precise source or measurement is your requirement:

Ambient temperature range: $23 \pm 5^{\circ}$ C;

Ambient humidity range: 20 to 80% RH(non-condensing)

- ✓ When using the instrument within a temperature range of 0 to 18° C or 28 to 50° C, add a value based on the temperature coefficient shown in Chapter 18“Specifications” to the given accuracy rating.
- ✓ When using the instrument at an ambient humidity of 30% or lower, prevent electrostatic charges from being produced, by using an antistatic mat or any other alternative means.
- ✓ Condensation may occur if you relocate the instrument from places with low temperature and humidity to places with high temperature and humidity, or if the instrument experiences any sudden temperature change. In that case, leave the instrument under the given ambient temperature for at least one hour to ensure that the instrument is free from condensation, before using the instrument.

Installing or Replacing the Batteries

Warning

To avoid electrical shock, always remove the source lead cables from the object under test, as well as from the instrument itself.

Caution

- ✓ To avoid the risk of fluid leakage or battery explosion, install batteries with their positive and negative electrodes correctly positioned.
- ✓ Do not short-circuit the batteries.
- ✓ Do not disassemble or heat the batteries or throw them into fire.

✓ When replacing batteries, replace all of the four batteries at the same time with new ones from the same manufacturer.

✓ If the instrument will not be used for a prolonged period, remove the batteries from the instrument.

Step 1: Remove the lead cables and charger and turn off the calibrator before you begin installing batteries.

Step 2: Remove the battery holder cover by sliding it in one-quarter counterclockwise direction and turn off the calibrator.

Step 3: Install four alkaline batteries of same type in the battery holder with their positive and negative electrodes positioned correctly as indicated on the holder.

Step 4: After replacement, reattach the battery holder cover.

Indication of Battery Level

The battery replacement indicator shows the battery level in five steps according to the measured voltage of the batteries.

Full battery: 

The battery level is below 50% full: 

The battery level is below 25% full: 

Low battery: 

The dictation flashes in sequence when getting charged.

Note that the battery replacement indicator is driven by directly measuring the battery voltage when the calibrator is in actual operation. Consequently, the indicator may read differently depending on the battery load condition if the batteries are too low. If the calibrator will be used under a wide variety of conditions, it is advisable that the battery replacement indicator be verified under heavy loads.

Connecting the Charger

Warning

- ✓ Make sure the voltage of the AC power source matches the rated supply voltage of the Charger, before connecting the Charger to the AC power source.
- ✓ Do not use any Charger other than the dedicated Charger from the Company.
- ✓ Do not charge non Ni-Cd, Ni-MH batteries or wasted batteries.

Step 1: Make sure the calibrator is turned off.

Step 2: Insert the plug of the optional Charger into the Charger connection jack.

Note

- ✓ Turn off the calibrator before connecting or disconnecting the Charger from AC power, plugging in/out the Charger connection jack.
- ✓ Plug out the Charger from the Charger connection jack of the calibrator when discharging.
- ✓ Do not charge the calibrator without any battery in.

Turning On the Power

Pressing the Power key once when the power is off turns on the calibrator.

Pressing the Power key for 2 seconds turns off the calibrator.

Turning On/Off the Backlight

The LCD can be backlight. Pressing the key turns on the backlight, while pressing the key once again turns it off. This feature makes it easier for you to view the LCD when operating the calibrator in dark places or when carrying out source or measurement. Battery life shortens when the calibrator is operated on batteries.

Note

The backlight automatically turns off after 10 seconds. Press the key once more to relight it. The time could be reset in the factory default parts, see Chapter 8 “Factory Default”.

7 Source

From the calibrator, you can source a DC voltage, DC current, simulate transmitter, resistance, thermocouple, RTD, frequency, pulse signal or contact output.

⚠Warning

To avoid electrical shock, do not apply more than the rated voltage, as marked on the calibrator, between terminals or between any terminal and earth ground. Always use the calibrator in locations with a voltage to ground below 30 Vp-p.

Caution

- ⚡ Do not apply any voltage to the output terminals for ranges other than 4-20mA simulating transmitter output, Otherwise, the internal circuitry may be damaged.

- The instrument has been calibrated without taking into account a voltage drop due to the resistance component of the lead cables for source. Care must be taken therefore when drawing a load current since the voltage drop due to the resistance component (approximately 0.1Ω on a round-trip basis) of the lead cables serves as an error.

7.1 Connecting Cables to Terminals

For DC voltage, thermocouple (Figure 5)

Step 1: Connect the black lead cable for source to the COM output terminal and the red lead cable to the “VTc” output terminal.

Step 2: Connect the other ends of the cables to the input of equipment under test while making sure the polarities are correct.

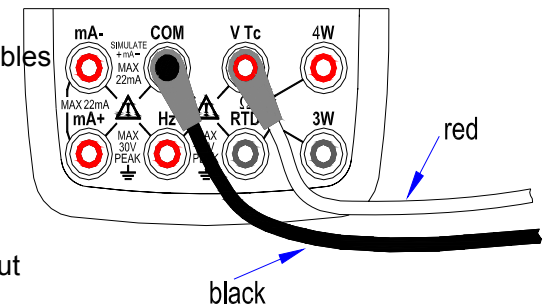

Figure 5 Sourcing DC voltage, TC

For DC current (Figure 6)

Step 1: Connect the black lead cable for source to the “mA-” output terminal and the red lead cable to the “mA+” output terminal.

Step 2: Connect the other ends of the cables to the input of equipment under test while making sure the polarities are correct.

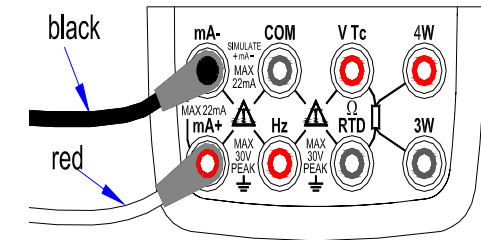

Figure 6 Sourcing DC Current

For resistance and RTD signal (Figure 7)

Step 1: Connect black lead cables for source to the “ΩRTD” terminal and the red lead cable to the “VTc” terminal.

Step 2: Connect the other ends of the cables to the input of equipment under test while making sure the polarities are correct.

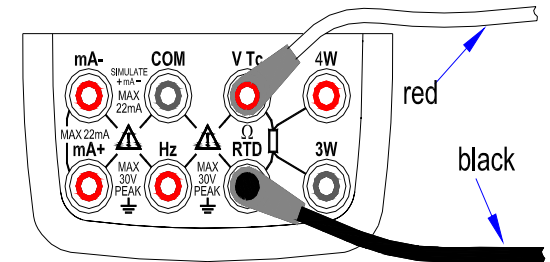

Figure 7 Sourcing Resistances and RTD

For Frequency, Pulse and Switch (Figure 8)

Step 1: Connect the black lead cable for source to the COM output terminal and the red lead cable to the “Hz” output terminal.

Step 2: Connect the other ends of the cables to the input of equipment under test while making sure the polarities are correct.

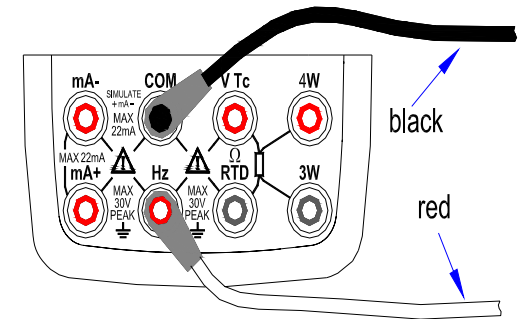

Figure 8 Sourcing Frequency, Pulse and Switch

7.2 Sourcing DC Voltage

Step 1: Using the (V) key to select DC voltage source function, select the desired range from 100mV, 1000mV, and 10V by pressing the (RANG) key. The default value and unit of the selected source function and range shall be displayed in the main districts part of the LCD.

Step 2: Set the output value digit by digit using (▲) / (▼) keys.

Each pair of (▲) / (▼) keys corresponds to each digit of the LCD reading. Each press of the (▲) / (▼) key increases or decreases the digit. Increasing the digit from 9 or decreasing it from 0 causes the digit to overflow or underflow, allowing you to set the output value without interruption. Holding down the (▲) / (▼) key continuously changes the digit in question. And the value won't change if it is increased or decreased to the Maxim or Minimum value. Pressing the (ZERO) key initializes the output set point to the default value (0).

Step 3: Pressing the (ON) key causes the indicator on the LCD to change from "OFF" to "ON". The calibrator sources the preset DC voltage between the output terminals.

Step 4: To turn off the output, press the (ON) key once again. The "OFF" appears on the LCD and no signals sourced between the terminals.

7.3 Sourcing DC Current

Step 1: Using the (mA) key to select the desired source function 0-22mA .The default value and unit of the selected source function shall be displayed in the main districts part of the LCD.

Step 2: Set the output value digit by digit using (▲) / (▼) keys.

Each pair of (▲) / (▼) keys corresponds to each digit of the LCD reading. Each press of the (▲) / (▼) key increases or decreases the digit. Increasing the digit from 9 or decreasing it from 0 causes the digit to overflow or underflow, allowing you to set the output value without interruption. Holding down the (▲) / (▼)

key continuously changes the digit in question. And the value won't change if it is increased or decreased to the Maxim or Minimum value. Pressing the (**ZERO**) key initializes the output set point to the default value (0).

Step 3: Pressing the (**ON**) key causes the indicator on the LCD to change from "OFF" to "ON". The calibrator sources the preset DC current between the output terminals.

Step 4: To turn off the output, press the (**ON**) key once again. The "OFF" appears on the LCD and no signals sourced between the terminals.

7.3.1 Manual Set 25%, 100% 4–20 mA Function

You can set the source value in 4 mA or 16mA increments or decrements within 4–20 mA current.

Step 1: In DC current function, press the (**25%100%**) key to display "25%SET" on the lower part of the screen, and press once again to display "100%SET". The default source value will be showed simultaneously.

Step 2: Using each pair of (**▲**) / (**▼**) output setting keys, set the signal in a step-by-step manner. In 25% set point condition, you can set the signal in 4 mA increments or decrements in the order 4-8-12-16-20 by each press of the key. In 100% set point condition, you can set the signal in 16 mA increments or decrements in the order 4-20 by each press of the key. Pressing the (**ZERO**) key initializes the signal set point to the default value 4mA.

Step 3: Pressing the (**ON**) key causes the indicator on the LCD to change from "OFF" to "ON". The calibrator sources the preset 4–20 mA current signal between the output terminals.

Step 4: To turn off the output, press the (**ON**) key once again. The "OFF" appears on the LCD and no signals sourced between the terminals.

7.3.2 Auto-stepping and auto-sweeping 4-20mA function

You can set a 4–20 mA range within which to source out current in 4 -20mA increments or decrements in auto

–stepping mode or in auto-sweeping mode. It requires 80 seconds to finish a 4-20mA cycle for auto-sweeping mode and 20 seconds for auto-stepping mode.

Step 1: In DC current function, press (Mrr)key to display auto-stepping mode signal “ rr ” on the lower part of the screen, and press once again to display auto-sweeping mode signal “ M ”.The default source value will be showed simultaneously.

Step 2: Pressing the (**ON**) key causes the indicator on the LCD to change from “**OFF**” to “**ON**”. The calibrator sources the default 4 mA current signal between the output terminals.

Step 3: Pressing the (**START**) key starts the auto-stepping and auto-sweeping mode. The “RUN “ mark shall be displayed in the lower part of the LCD.

Step 4: Pressing the (**START**) key once more stops the auto-stepping and auto-sweeping mode. The “RUN “ mark disappears. The terminals source the value displayed on the screen.

Step 5:Pressing the (**ON**) key stops sourcing and “**OFF**” mark displayed on the screen. No signals sourced between the terminals.

Tips:

- ✓ Press the (**START**)key again to continue the auto-stepping and auto-sweeping mode after stopping them, and “RUN” mark displays on the lower part of the screen.
- ✓ Using the (**START**) key to start mA auto-stepping and auto-sweeping mode is only available when the source function is in **ON** state.

7.3.3 mA% display

In mA source function, the preset value displays on main districts of the LCD, and mA% displays on assistance

districts of the LCD, converts the preset source value into mA% mode in the following way.

$$\text{mA \%} = \frac{100(\text{current output value mA-4mA})}{16 \text{ mA}} \%$$

Tips:

Press the **(T.DISP)** key, assistance districts converts the room temperature.

7.3.4 4-20 mA simulate transmitter source

Connect the calibrator and the loop power as listed in Figure 9, and operate in steps shown in sourcing DC current.

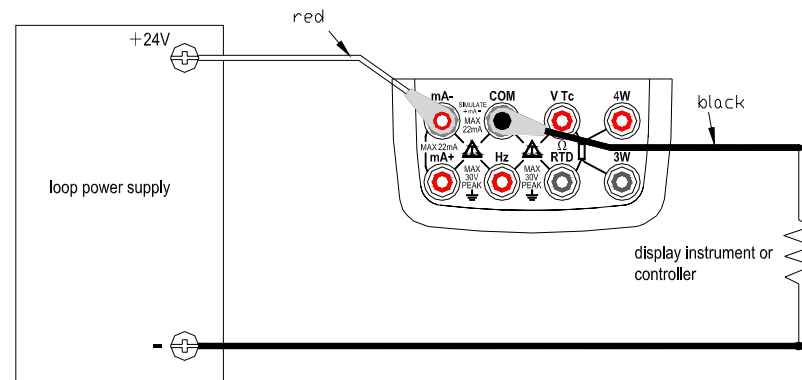

Figure 9 4-20 mA simulate transmitter source

7.4 Sourcing Resistance

Firstly, the calibrator sources a resistance signal by receiving the resistance-measuring current I supplied

from the device being calibrated (such as a resistance meter) and then delivering the voltage V proportional to the preset resistance R between the output terminals, and thus producing the equivalent resistance $R = V/I$. Consequently, the calibrator sources the signal correctly only for such devices that employ this method of measurement.

- ✓ The allowable range of the resistance measuring current I that the calibrator receives from a resistance measuring device under calibration is rated as 0.1 mA to 3 mA. To ensure accuracy, the resistance measuring current I from the device under calibration shall be strictly confined within the range. For further details, see Chapter 14, "Specification".
- ✓ Any resistance signal being sourced does not include the resistance component of the lead cables for source. The whole resistance, when measured at the ends of the lead cables for source, is given by adding the resistance of the lead cables (approximately 0.1Ω on a round-trip basis) to the sourced resistance signal. For source of precise resistance signals, use three-wire or four-wire connection. (See figure 10)
- ✓ If capacitance between the terminals of a device under calibration is greater than $0.1\mu\text{F}$, the calibrator may fail to source correct resistance signals.

Step 1: Using the (**OHM**) key, select Ohm function. Using the (**RANGE**) key, select the desired range. The selected function and the default range source value and unit shall be shown in the main districts part of the LCD.

Step 2 : Set the output value digit by digit using each pair of (**▲**) / (**▼**) keys.

Each pair of (▲) / (▼) keys corresponds to each digit of the LCD reading. Each press of the (▲) / (▼) key increases or decreases the digit.

Increasing the digit from

9 or decreasing it from 0 causes the digit to overflow or underflow, allowing you to set the output value without interruption. Holding down the (▲) / (▼) key continuously changes the digit in question. And the value won't change if it is increased or decreased to the Maxim or Minimum value.

Pressing the (ZERO) key initializes the output set point to the default value(0).

Step 3: Pressing the (ON) key causes the SOURCE indicator on the LCD to change from "OFF" to "ON". The calibrator sources the preset resistance value between the output terminals.

Step 4: To turn off the output, press the (ON) key once again. The "OFF" appears on the LCD and no signals sourced between the terminals.

The connection method based on three-wire and four-wire are listed in Figure 10:

7.5 Simulate Sourcing TC

The calibrator is designed with an internal temperature sensor. To calibrate a device with built-in reference junction temperature compensation by sourcing a thermoelectromotive force with the calibrator without using non-external 0C reference junction compensation means, use the RJ sensor function. Select simulate TC source function, in which RJ sensor goes on work automatically. The "RJ-ON" mark displays on the middle part of the screen.

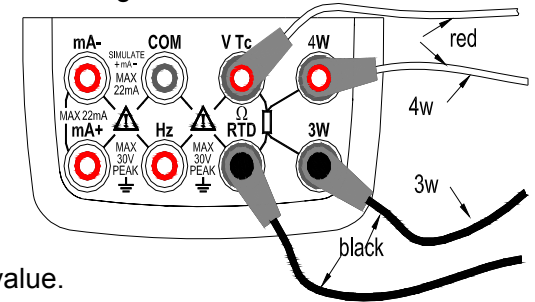

Figure 10 connection method based on three-wire and four-wire

Step 1: Using the (Tc) key, select simulate TC source function. Using the (RANGE) key, select the desired range from K, E, J, T, B, N, R, S, L, U. The selected function and the default range source value and unit shall be shown in the main districts part of the LCD.

Step 2 :Set the output value digit by digit using each pair of (▲) / (▼) keys.

Each press of the (▲) / (▼) key increases or decreases the digit. Increasing the digit from 9 or decreasing it from 0 causes the digit to overflow or underflow, allowing you to set the output value without interruption.

Holding down the (▲) / (▼) key continuously changes the digit in question. And the value won't change if it is increased or decreased to the Maxim or Minimum value. Pressing the (ZERO) key initializes the output set point to the default value(the default value of a typical B type is 600°C).

Step 3: Pressing the (ON) key causes the SOURCE indicator on the LCD to change from "OFF" to "ON" . A thermoelectromotive force based on the temperature detected by the RJ sensor develops between the output terminals.

Step 4: To turn off the output, press the (ON) key once again. The "OFF" appears on the LCD and no signals sourced between the terminals.

Note:

If you don't need the reference junction compensation, press the (RJ-ON) key to shut off. The calibrator source a value with using external 0°C reference junction compensation means, and the "RJ-ON" mark vanishes.

Press the (RJ-ON) key once more to start the reference junction compensation and the "RJ-ON" mark displays on the middle of the screen.

Tips:

✓ The temperature unit is defaulted as °C.To convert into °F,see Chapter 8 "Factory Default" .

7.5.1 Temperature Monitor Function

The calibrator offers a temperature monitor function, which is convenient for the user to observe the voltage value sourced between the output terminals in TC source function.

In TC source function, LCD shows the voltage value sourced between the output terminals, (varies responding to the changes of the reference junction compensation). Pressing the (**T.DISP**) key once more, LCD shows the present room temperature value in assistance districts part of the LCD.

7.6 Simulate Sourcing RTD

- ✓ Firstly, the calibrator sources a resistance signal by receiving the resistance-measuring current I supplied from the device being calibrated (such as a resistance meter) and then delivering the voltage V proportional to the preset resistance R between the output terminals, and thus producing the equivalent resistance $R = V/I$. Consequently, the calibrator sources the signal correctly only for such devices that employ this method of measurement.
- ✓ The allowable range of the resistance measuring current I that the calibrator receives from a resistance measuring device under calibration is rated as 0.1 to 3mA at PT100,Cu10,Cu50, 0.05 to 0.3mA at PT200,PT500,PT1000. To ensure accuracy, the resistance measuring current I from the device under calibration shall be strictly confined within the range. For further details, see Chapter 24, "Specification".
- ✓ Any resistance signal being sourced does not include the resistance component of the lead cables for source. The whole resistance, when measured at the ends of the lead cables for source, is given by adding the resistance of the lead cables (approximately 0.1 Ω on a round-trip basis) to the sourced resistance signal. For source of precise resistance signals, use three-wire or four-wire connection.

Step 1: Using the (**RTD**) key, select RTD function. Using the (**RANGE**) key, select a desired RTD range from

PT100, PT200, PT500, PT1000, Cu10, Cu50. The selected function and the default range source value and unit shall be shown in the main districts part of the LCD. Types of RTD shall be shown in the middle part of the LCD.

Step 2 :Set the output value digit by digit using each pair of (▲) / (▼) keys.

Each press of the (▲) / (▼) key increases or decreases the digit. Increasing the digit from 9 or decreasing it from 0 causes the digit to overflow or underflow, allowing you to set the output value without interruption.

Holding down the (▲) / (▼) key continuously changes the digit in question. And the value won't change if it is increased or decreased to the Maxim or Minimum value. Pressing the (ZERO) key initializes the output set point to the default value(0).

Step 3: Pressing the (ON) key causes the SOURCE indicator on the LCD to change from "OFF" to "ON" . The calibrator sources the preset resistance value between the output terminals.

Step 4: To turn off the output, press the (ON) key once again. The "OFF" appears on the LCD and no signals sourced between the terminals.

7.6.1 Temperature Monitor Function

The calibrator offers a temperature monitor function, which is convenient for the user to observe the resistance value sourced between the output terminals.

In RTD source function, LCD shows the resistance value sourced between the output terminals. Pressing the (T.DISP) key once more, LCD shows the present room temperature value in assistance districts part of its.

7.7 Sourcing Frequency

The calibrator can source a constant pulse signal responding to the preset frequency and amplitude.

Step 1: Using the (F) key, select frequency source function. The LCD shows the default frequency value10

Hz.

Step 2: Using the (**RANG**) key, select a desired frequency range from 100Hz, 1KHz,10kHz,100KHz. The selected function and the default range source value and unit shall be shown in the LCD.

Step 3: Set the output value digit by digit using each pair of (▲) / (▼) output setting keys.

Each pair of (▲) / (▼) keys corresponds to each digit of the LCD reading. Each press of the (▲) / (▼) key increases or decreases the digit. Increasing the digit from 9 or decreasing it from 0 causes the digit to overflow or underflow, allowing you to set the output value without interruption. Holding down the (▲) / (▼) key continuously changes the digit. And the value won't change if it is increased or decreased to the Maxim or Minimum value.

Step 4: Pressing the (**Vpeak**) key once switches to amplitude setting mode. The LCD provides a reading of 1V.

Step 5: Set the output value digit by digit using each pair of (▲) / (▼) output setting keys.

Each pair of (▲) / (▼) keys corresponds to each digit of the LCD reading. Each press of the (▲) / (▼) key increases or decreases the digit. Increasing the digit from 9 or decreasing it from 0 causes the digit to overflow or underflow, allowing you to set the output value without interruption. Holding down the (▲) / (▼) key continuously changes the digit . And the value won't change if it is increased or decreased to the Maxim or Minimum value.

Step 6: To re-enter into the frequency set mode, press the (**FREQ**) key to set the frequency.

Step 7: Pressing the (**ON**) key causes the SOURCE indicator on the LCD to change from "OFF" to "ON". The calibrator sources constant pulse signals responding to the preset frequency and amplitude between the output terminals.

Step 8: To turn off the output, press the (**ON**) key once again. The "OFF" appears on the LCD and no signals

sourced between the terminals.

Tips:

- ✓ The frequency range could only be changed by pressing (**RANGE**) key in the frequency set mode.
- ✓ The frequency value and range could be changed when the frequency source function is both in "ON" or "OFF" state.

7.8 Sourcing Number of Pulses

The calibrator can source a preset number of pulse signal responding to the preset frequency and amplitude.

Step 1: Using the (**PL**) key, select pulse source function. The LCD shows the default value 10 Hz.

Step 2: Using the (**RANGE**) key, select a desired frequency range from 100Hz, 1KHz, 10kHz. The selected function and the default range source value and unit shall be shown in the LCD.

Step 3: Set the output value digit by digit using each pair of (**▲**) / (**▼**) output setting keys.

Each pair of (**▲**) / (**▼**) keys corresponds to each digit of the LCD reading. Each press of the (**▲**) / (**▼**) key increases or decreases the digit. Increasing the digit from 9 or decreasing it from 0 causes the digit to overflow or underflow, allowing you to set the output value without interruption. Holding down the (**▲**) / (**▼**) key continuously changes the digit . And the value won't change if it is increased or decreased to the Maximum or Minimum value.

Step 4: Pressing the (**Vpeak**) key once switches to amplitude setting mode. The LCD provides a reading of 1V.

Step 5: Set the output value digit by digit using each pair of (**▲**) / (**▼**) output setting keys.

Each pair of (**▲**) / (**▼**) keys corresponds to each digit of the LCD reading. Each press of the (**▲**) / (**▼**) key increases or decreases the digit. Increasing the digit from 9 or decreasing it from 0 causes the digit to overflow or underflow, allowing you to set the output value without interruption. Holding down the (**▲**) / (**▼**)

key continuously changes the digit. And the value won't change if it is increased or decreased to the Maxim or Minimum value.

Step 6: Pressing the (**CYC**) key ,enter into the pulse number set mode, and the LCD shows the default number of 1 CYC.

Step 7: Set the output value digit by digit using each pair of (▲) / (▼) output setting keys. Each pair of (▲) / (▼) keys corresponds to each digit of the LCD reading. Each press of the (▲) / (▼) key increases or decreases the digit. Increasing the digit from 9 or decreasing it from 0 causes the digit to overflow or underflow, allowing you to set the output value without interruption. Holding down the (▲) / (▼) key continuously changes the digit. And the value won't change if it is increased or decreased to the Maxim or Minimum value.

Step 8: To re-enter into the frequency set mode, press the (**FREQ**) key to set the frequency.

Step 9: Pressing the (**ON**) key causes the SOURCE indicator on the LCD to change from "OFF" to "ON", and the calibrator sources low level between the output terminals.

Step 10: Pressing the (**START**) key the calibrator sources the set number of pulse responding to the preset frequency and amplitude, LCD shows the symbol "RUN".

Step 11: When source is complete, the calibrator automatically turns off the output and ceases operation. The "RUN" symbol disappears from the LCD.

Step 12: To turn off the output, press the (**ON**) key once again. The "OFF" appears on the LCD and no signals sourced between the terminals.

Tips:



✓ The frequency range of the pulse could only be changed by pressing (**RANGE**) key in the frequency set

mode.

- ✓ When the “RUN” symbol vanishes from the LCD, you can change the frequency ,amplitude and number of pulse both when the source function is in “**ON**” or “**OFF**”.
- ✓ In the pulse sourcing process, pressing the (**START**) key causes to stop the output, and the “RUN” mark vanishes from the LCD. Press the (**START**) key once more to restart the sourcing function.

7.9 Sourcing Switch

You can turn on or off the output terminals by using the contact output function. An FET is used as the contact-switching device.

Step 1: Using the () key, select the contact output source function. The LCD shows the default value 10Hz, and the “” symbol.

Step 2: Using the (**RANGE**) key, select the desired frequency from 100Hz, 1KHz, 10 KHz, and 100KHz. The LCD shows the default value and unit.

Step 3: Set the output value digit by digit using each pair of (**▲**) / (**▼**) output setting keys. Each pair of (**▲**) / (**▼**) keys corresponds to each digit of the LCD reading. Each press of the (**▲**) / (**▼**) key increases or decreases the digit. Increasing the digit from 9 or decreasing it from 0 causes the digit to overflow or underflow, allowing you to set the output value without interruption. Holding down the (**▲**) / (**▼**) key continuously changes the digit . And the value won't change if it is increased or decreased to the Maxim or Minimum value.

Step 4: Pressing the (**ON**) key causes the **SOURCE** indicator on the LCD to change from “**OFF**” to “**ON**” and the calibrator sources contact signals responding to the present frequency.

Step 5: To turn off the output, press the (**ON**) key once again. The “OFF” appears on the LCD and no signals sourced between the terminals.

Tips:

- ✓ You cannot set the amplitude and pulse number in switch output function.
- ✓ The contact output is polarity. Generally, connect the positive polarity with the H jack of the calibrator and the negative polarity with the L jack.
- ✓ Note the maxim allowable current of the contact output is 50mA.

7.10 Zero-off function

In any range of DC voltage, DC current, ohm, TC and RTD functions, pressing the (**ZERO**) key selects clearing off function, which initializes the preset source value for the convenience of user to reset source value.

In frequency, pulse, contact output functions, the (**ZERO**) key is unavailable.

8 Factory Default

You can reset the factory default of the calibrator.

When turning on the calibrator, pressing the (**RANGE**) key immediately to enter the default set.

8.1 Setting Auto -power off time

Step 1: Pressing the (**START**) key, LCD displays “AP.OFF” symbol on the upper part, indicating automatic power- off setting mode.

Step 2: Set the time within 0-60 minute range by using the second pair of (▲) / (▼) counting from right to left. Each press of the (▲) / (▼) key causes 10 -minute increments or 10- minute decrement with constant setting. Constant press of the key causes increments or decrement of the value in sequence. The value won't change

when reaching the maximum or minimum value. The time unit is minute.

Step 3: Pressing the (ON) key, LCD displays “SAVE” symbol on the upper part for 1s.

Tips:

Zero default value (0) represents no automatic power-off function.

8.2 Setting Backlight time

Step 1: Pressing the (START) key, LCD displays “BL.OFF” symbol on the upper part, indicating backlight time setting mode.

Step 2: Set the time by using the pair of (▲) / (▼) . And the unit is second.

Each pair of (▲) / (▼) keys corresponds to each digit of the LCD reading. Each press of the (▲) / (▼) key increases or decreases the digit. Increasing the digit from 9 or decreasing it from 0 causes the digit to overflow or underflow, allowing you to set the output value without interruption. Holding down the (▲) / (▼) key continuously changes the digit . And the value won't change if it is increased or decreased to the Maxim or Minimum value. The setting range is confined within 0-3600 seconds.

Step 3: Pressing the (ON) key, LCD displays “SAVE” symbol on the upper part for 1sec.

Tips:

When the default value is 0, the backlight won't be off automatically if turned on except that you turn it off manually.

8.3 Setting temperature unit

Step 1: Pressing the (START) key, LCD displays “TEM.U” symbol on the upper part, indicating temperature unit setting mode.

Step 2: Shifting between the °C and °F by using the right pair of (▲) / (▼) .

Step 3: Pressing the (ON) key, LCD displays “SAVE” symbol on the upper part for 1s.

8.4 Factory default

Step 1: Pressing the (START) key, LCD displays “FACRY” symbol on the upper part, indicating factory default.

Step 2: Pressing the (ON) key, LCD displays “SAVE” symbol on the upper part for 1s. All settings are defaulted as below:

AP.OFF: 10min.

BL.OFF: 10sec.

TMP.U: °C.

Tips:

Any change of setting to the above-mentioned function, press the (ON) key to save the value. Any press of the (ON) key saves the nearest setting value.

9 Adjusting Source Functions

Environmental Requirements

Ambient temperature: 23 ±2°C

Relative humidity: 35% to 75% RH

Warm-up:

- ✓ Before using, warm up the calibrator for the period of time specified.
- ✓ Set the meter into the standard environment for 24 hours, and then turn on the power. Change the set into non-automatic power-off state and warm it up for one hour.

Power Supply: new alkaline size (AAA) battery type 7 is the best choice for adjustment.

Source Adjustment Operation:

Table 4 Adjustment Points of Source Functions

Range	Adjustment Point *					Remarks
	0	A	F	-0	-F	
DCV_100mV	0	/	100mV	/	/	
DCV_1000mV	0	0	1000mV	/	/	
DCV_10V	0	/	10V	/	/	
DCmA_20mA	0	/	20mA	/	/	
OHM_400Ω/1mA	0Ω	/	400Ω	-0Ω	-400Ω	I=±1mA
OHM_400Ω/0.1mA	0Ω	/	400Ω	-0Ω	-400Ω	I=±0.1mA
OHM_4KΩ/0.1mA	0Ω	/	4KΩ	-0Ω	-4KΩ	I=±0.1mA
OHM_40KΩ/0.01mA	0Ω	/	40KΩ	-0Ω	-40KΩ	I=±0.01mA

* Adjusting the displayed value same with the reading of the digit meter when the present calibrator is stabilized.

- ✓ You can calibrate a desired function and range separately.
- ✓ You must calibrate all the calibrating points of the selected range together.
- ✓ When adjusting resistance source, the exciting current is (+) for adjustment point "0" and "F", and is (-) for adjustment point "-0" and "-F".

Turn on the meter; press the **(START)** key while simultaneously holding down the **(ON)** key enters the source calibration state. LCD shows "CAL-0" symbol on the assistance districts part, the present calibrating point on the main districts part and the high 5 digits of the responding value and its unit. The digit in the right on the

assistance districts part is the lowest digit of the value.

Tips:

If the battery level is below 25% full, the adjustment operation can't be operated. And the LCD shows "ERR" in the lower part.

9.1 Adjusting Voltage Source

Step 1: Using the key (V) , select DC voltage function.

Connect the lead cables for measurement to the standard digital meter as shown in Figure 11.

Step 2: Pressing the (RANGE) key selects the right range.

Step 3: The LCD shows "CA-0" or (CA-F) symbol on the assistance districts part and the calibrator is ready for the zero-point or F-point adjustment of source functions. The LCD shows the highest five digits and its unit in the main districts part and the lowest digit of the calibrated sourced value in the right of the assistance districts part respectively.

Step 4: Read the calibrator output on the calibration standard. Then, using the pair of (▲) / (▼) keys, adjust the reading so that it matches the measured CAL adjustment setpoint. In the CAL mode, the right pair of (▲) / (▼) keys are used to increase or decrease the least-significant digit, (the digit in the right of the LCD assistance districts part).

Step 5: Press the (25/100%) key to save the CAL adjustment reading.

Step 6: Pressing the (ZERO) key shifts to the next setpoint.

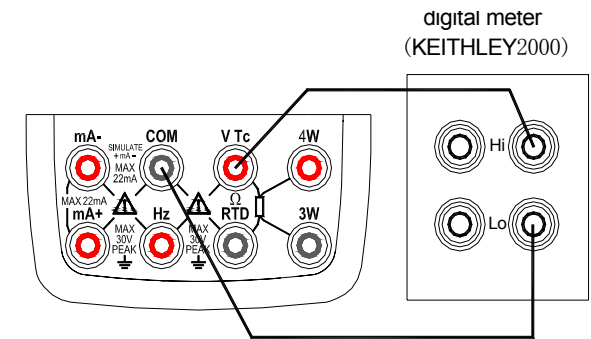

Figure 11 Adjusting voltage source

Step 7: By repeating steps 3 to 6, you can adjust all the adjustment point assigned to that range.

Step 8: By repeating steps 2 to 7, you can adjust all ranges of the DC voltage source function.

Note:

- ✓ Adjustment to the 100mV range calibrates the TC temperature measurement range at the same time.
- ✓ Make sure the previous adjusting point has been saved before shifting to another one.

9.2 Adjusting Current Source

Step 1: Using the key (mA), select DC current function.

Connect the lead cables for measurement to the standard digital meter as shown in Figure 12.

Step 2: The LCD shows “CA-0” (or “CA-F”) symbol on the assistance districts part and the calibrator is ready for the zero-point or F-point adjustment of source functions. The LCD shows the highest five digits and its unit in the main districts part and the lowest digit of the calibrated sourced value in the assistance districts part respectively.

Step 3: Read the calibrator output on the calibration standard. Then, using the pair of (▲) / (▼) keys, adjust the reading so that it matches the measured CAL adjustment setpoint. In the CAL mode, the right pair of (▲) / (▼) keys are used to increase or decrease the least-significant digit, (the digit in the right of the LCD assistance districts part).

Step 4: Pressing the (25/100%) key to save the CAL adjustment reading.

Step 5: Pressing the (ZERO) key shifts to the next setpoint.

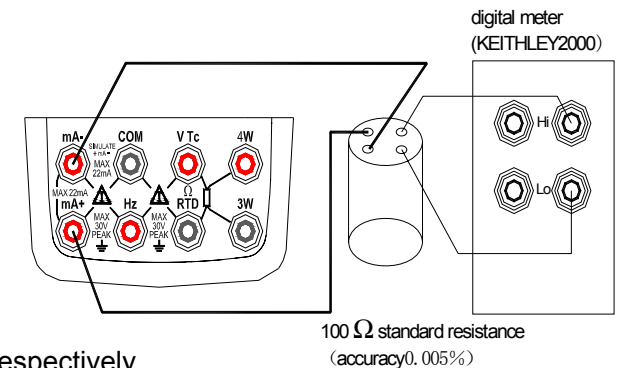

Figure 12 Adjusting current source

Step 6: By repeating steps 2 to 5, you can adjust all the adjustment point assigned to that range.

Note:

Make sure the previous adjusting point has been saved before shifting to another one.

9.3 Adjusting Resistance Source

Step 1: Using the key (**OHM**), select resistance function. Connect the lead cables for measurement to the standard digital meter as shown in Figure13.

Step 2: Pressing the (**RANGE**) key selects the right range.

Step 3: The LCD shows “0” or “F” symbol on the assistance districts part and the calibrator is ready for the zero-point or F-point adjustment of source functions. The LCD shows the highest five digits and its unit in the main districts part and the lowest digit of the calibrated sourced value in the right of the assistance districts part respectively.

Step 4: Read the calibrator output on the calibration standard. Then, using the pair of (**▲**) / (**▼**) keys, adjust the reading so that it matches the measured CAL adjustment setpoint. In the CAL mode, the right pair of (**▲**) / (**▼**) keys are used to increase or decrease the least-significant digit, (the digit in the right of the LCD assistance districts part).

Step 5: Press the (**25/100%**) key to save the CAL adjustment reading .

Step 6: Pressing the (**ZERO**) key shifts to the next setpoint.

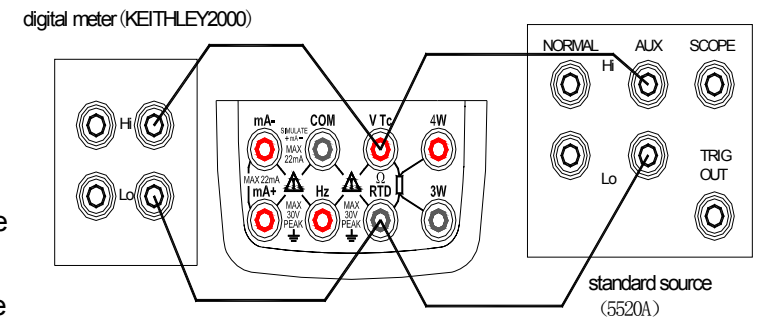

Figure 13 Adjusting resistance source

Step 7: By repeating steps 3 to 6, you can adjust all the adjustment point assigned to that range.

Step 8: By repeating steps 2 to 7, you can adjust all ranges of the DC voltage source function.

Note:

- ✓ In ohm calibration function, you can differentiate the negative exciting calibration from the left “-” mark on the lower part. The value of the exciting current is indicated by the digit on the top right corner.(unit :mA)
- ✓ Make sure to preserve the calibrating value before changing the calibrating point or range. Otherwise, the previous reading won't be saved if the point or range is changed.
- ✓ Calibration of the ohm 400 Ω and ohm 4K Ω means calibrating all ranges of the RTD.
- ✓ In 400 Ω range resistance calibration:

1) Adjusting of inner variance

Make sure the applied voltage between the H and L terminals is within ± 20 uV, when setting 0.00 Ω resistance. If the voltage exceeds the range, the calibrator needs internal adjustment, then contact the vendor from whom you purchased the calibrator.

2) Noting exciting current of sourcing resistance

Calibration of the 400 Ω resistance range requires 2 exciting currents of 0.1mA and 1mA from external devices, of which the range is calibrated respectively.

10 Replacing Batteries or fuse:

⚠Warning

To avoid possible electric shock, remove the test leads from the calibrator before open the battery door. And make sure the battery door is tightly closed before turning on the calibrator.

Caution

- ✓ To avoid possible leakage of the liquid and explosion of the battery, make sure to place the battery with right polarity.
- ✓ Do not operate the battery in short-circuit.
- ✓ Do not disassemble or heating the battery or throw them into the fire
- ✓ When replacing, use only four same specified ones.
- ✓ Take out the battery if you don't operate the meter for a long time.

Step 1: Remove the test leads and Charger before replacing batteries or fuse, and turn off the meter.

Step 2: Remove the protector as shown in Figure14.

With a standard blade hand screwdriver, turn each battery door screw a quarter counterclockwise to remove the battery door.

Step 3: Replace with four new AAA alkaline batteries under the instructions shown on the battery door. Or replace the blown fuses with same type F1 (50mA/250V) or F2 (63mA/250V).

Step 4: Reinstall and tighten the battery door, put on the protector before using the meter.

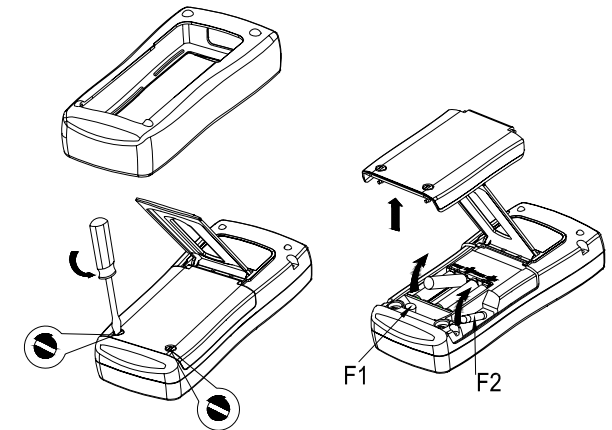

Figure 14 Replacing batteries and fuses

11 How to use the charger

⚠Warning

- ✓ The charger could be used only to specified product.
- ✓ Make sure the voltage of the AC power is same with the given voltage of the charger before connecting them.
- ✓ Do not shut circuit the output plug of the charger.
- ✓ Do not charge non-Ni-Cd, non-Ni-MH battery or wasted battery.

Step 1: Turn off the calibrator.

Step 2: Connect the plug into the charging jack of the terminal.

Step 3: Plug the charger into the AC power.

Note:

In normal charging function, the indicating light of the charger lights on.

When finished, the charging function stops automatically, and the indicating light becomes dark.

Blinking of the indicating light means the charger is not connected or no battery is inside.

Note:

Do not use the calibrator when it undergoes charging, otherwise, the charging will be prolonged.

12 Maintenance

12.1 cleaning the calibrator

⚠Warning

To avoid electrical shock or damaging the meter, serve the meter only by the replacement parts specified and never get water inside the case.

Caution

To avoid damaging the plastic lens and case, do not use solvents or abrasive cleansers. Clean the Calibrator with a soft cloth dampened with water or water and mild soap.

12.2 Calibration or Sending to the Service Center

Calibration, maintenance or repair work unmentioned in this manual should be undertaken by the experienced worker. If the meter operates abnormally, inspect the batteries first and replace them if necessary.

If you suspect that the meter has failed, review this manual to make sure you are operating it correctly. If the meter still fails to operate properly, pack it securely (in its original container if available) and forward it, postage paid, to the nearest Service Center. The company assumes NO responsibility for damage in transit.

The Company guarantees a rapid repair and maintenance and delivers the meter back as soon as possible. Please refer to the Warranty. If the warranty is due, you will be billed for the maintenance and repair work. If the calibrator is not within the Warranty range, you can contact the warranted service center for enquiring about the expenditure. Please refer to the Chapter "Contact Us" to find a warranted service center.

12.3 Replacement of Parts

All the types of parts are listed in Table 8, see Figure 15 as reference.

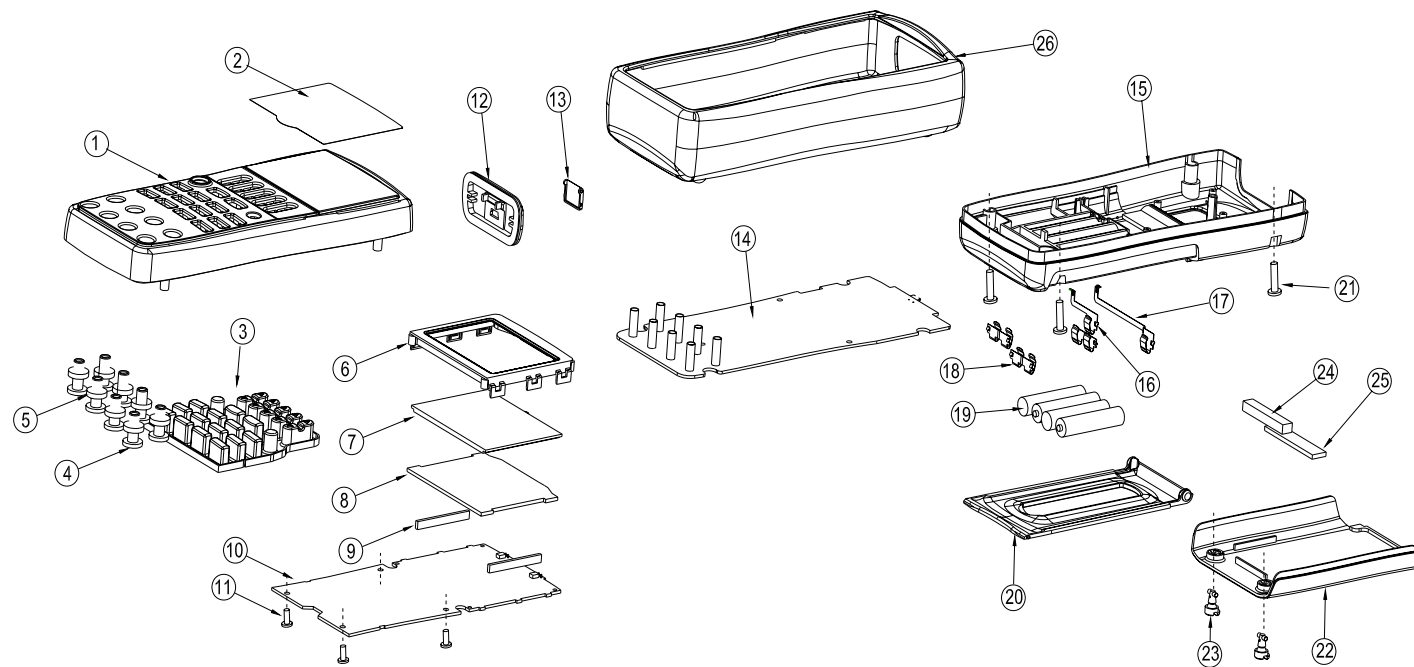

Figure 15 Replacing part

Table 5. Replacing parts

Item	Instruction	Quantity		Item	Instruction	Quantity
1	Top panel	1		16	Spring A	1
2	plastic lens	1		17	Spring B	1
3	Rubber Key	1		18	Spring C	3
4	Terminal Wrapper	8		19	AAA Alkaline battery	4
5	Terminal Gasket	8		20	Tilt-stand	1
6	LCD Frame	1		21	Screw M3*16	4
7	LCD	1		22	Battery Door	1
8	Backlight Panel	1		23	Plastic Screw	2
9	Conductive Rubber wire	2		24	Sponge: length×width×height =40×6×6	1
10	LCD Circuit Panel	1		25	Sponge: length×width×height =48×10×2.5	1
11	Screw M3*8	4		26	Outer Protector	1
12	Terminal Cover	1				
13	Cover Door	1				
14	Main Circuit Panel	1				
15	Bottom Panel	1				

13 Options

For more information about the options (see Figure 16) and its price, please contact the representative of the company.

Table 6 Options

No.	Name of the Options	Mode
1	CALCT Temperature Probe	A000019
2	TC Plug	R/S/K/E/J/ T/N/B/L/U
3	Test Hoop	TP907110
4	CA Battery Parcel	A000021
5	CA Charger	A000020

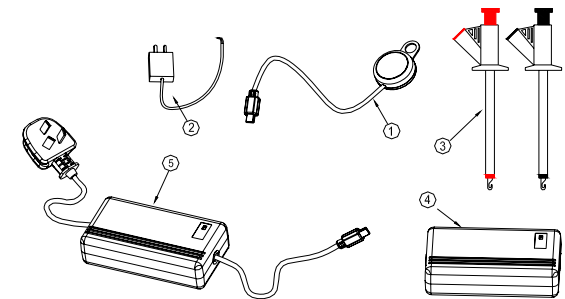

Figure 16 Options

14 Specifications

General Specifications for Source

These specifications assume:

A 1-year calibration cycle

An operating temperature of 18°C to 28°C (64.4°F ~82.4°F)

Relative humidity of 35% to 70% (non_condensing)

Accuracy is expressed as \pm (percentage of set value + percentage of range)

Function	Reference	Range	Resolution	Accuracy	Remark
DC voltage	100mV	-10.000mV ~ 110.000mV	1 μ V	0.02+0.01	Maximum output current: 0.5mA
	1000mV	-100mV ~ 1100mV	10 μ V	0.02+0.01	Maximum output current: 2mA
	10V	-1.0000V ~ 11.0000V	0.1mV	0.02+0.01	Maximum output current: 5mA
DC current	20mA	0.000mA ~ 22.000mA	1 μ A	0.02+0.02	External supply for simulate mA: 5V–28V Maximum load 1K Ω at 20mA
Resistance	400 Ω	0.00 Ω ~400.00 Ω	0.01 Ω	0.02+0.02	Excitation current: \pm 0.5–3 mA; if \pm 0.1–0.5, add 0.1 Ω ; Accuracy does not include lead resistance;
	4K Ω	0.0000 K Ω ~ 4.0000 K Ω	0.1 Ω	0.05+0.025	Excitation current: \pm 0.05 –0.3mA; Does not include lead resistance;

	40KΩ	0.000 KΩ ~ 40.000 KΩ	1Ω	0.1+0.1	Excitation current: ±0.01mA; Does not include lead resistance;
TC	R	0°C~1767°C	1°C	0~100°C : 1.5°C 100~1767°C: 1.2°C	By using ITS-90 temperature scale; The accuracy does not include the error of internal temperature compensation caused by a sensor;
	S	0°C~1767°C		0~100°C : 1.5°C 100~1767°C: 1.2°C	
	K	-200.0°C~1372.0°C	0.1°C	-200.0~-100.0 : 0.6°C -100.0~400.0°C: 0.5°C 400.0~1200.0°C: 0.7°C 1200.0~1372.0 :0.9°C	
	E	-200.0°C~1000.0°C		-200.0~-100.0 : 0.6°C -100.0~600.0°C:0.5°C 600.0~1000.0°C: 0.4°C	
	J	-200.0°C~1200.0°C		-200.0~-100.0 : 0.6°C -100.0~800.0°C:0.5°C 800.0~1200.0°C: 0.7°C	
	T	-250.0°C~400.0°C		-250.0~400.0°C: 0.6°C	
	N	-200.0°C~1300.0°C		-200.0~-100.0°C:1.0°C -100.0~900.0°C: 0.7°C 900.0~1300.0°C: 0.8°C	

	B	600°C~1820°C	1°C	600~800°C : 1.5°C 800~1820°C: 1.1°C	
	L	-200.0°C~900.0°C	0.1°C	-200.0~0.0°C : 0.7°C 0.0~900.0°C : 0.5°C	
	U	-200.0°C~600.0°C		-200.0~0.0°C: 0.7°C 0.0~600°C: 0.5°C	
RTD	Pt100-385	-200.0°C~800.0°C	0.1°C	-200.0~0.0°C : 0.3°C 0.0~400.0°C : 0.5°C 400.0~850.0°C : 0.8°C	By using temperature scale ITS-90 Excitation current: ±0.5~±3mA for Pt100, Cu10, Cu50; Add 0.5°C when excitation current is ±0.1~0.5mA. Excitation current: ±0.05mA ~ ±0.3mA for PT200, PT500, PT1000; Does not include lead resistance.
	Pt200-385	-200.0°C~630.0°C		-200.0~100.0°C: 0.8°C 100.0~300.0°C : 0.9°C 300.0~630.0°C : 1.0°C	
	Pt500-385	-200.0°C~630.0°C		-200.0~100.0°C: 0.4°C 100.0~300.0°C : 0.5°C 300.0~630.0°C : 0.7°C	
	Pt1000-385	-200.0°C~630.0°C		-200.0~100.0°C: 0.2°C 100.0~300.0°C : 0.5°C 300.0~630.0°C : 0.7°C	

	Cu10	-100.0°C~260.0°C		1.8°C	
	Cu50	-50.0°C~150.0°C		0.6°C	
FREQ	100Hz	1.00Hz ~ 110.00Hz	0.01Hz	±2 count	Output voltage: +1~+11 V _{p-p} (zero base waveform); Amplitude accuracy: ±(5%+0.5V); Maximum load: >100 KΩ; Duty Cycle: 50%.
	1KHz	0.100KHz ~ 1.100KHz	1Hz		
	10KHz	1.0KHz ~ 11.0KHz	0.1KHz		
	100KHz	10KHz~110KHz	2KHz	±5 count	
PULSE	100Hz	1~100000cycles	1cyc	±2 count	
	1KHz				
	10KHz				
SWITCH	100Hz	1.00Hz~110.00Hz	0.01Hz	±2 count	FET switch Maximum open/close voltage: +28 V Maximum open/close current:. 50mA
	1KHz	0.100KHz~1.100 KHz	1Hz		
	10KHz	1.0KHz~11.0kHz	0.1KHz		
	100KHz	10kHz~110kHz	2KHz	±5 count	

Other feature:

- ✓ Temperature Coefficient: 0.1 times the applicable accuracy specification per degree C for 5°C to 18°C and 28°C to 50°C.
- ✓ The range of the internal temperature compensation sensor is from 0°C to 50°C, compensation error $\leq \pm 0.5^\circ\text{C}$.
- ✓ Maximum voltage between any output terminal and earth: 30Vpk
- ✓ Maximum output current: Approximately 25mA
- ✓ The accuracy of the temperature probe: $\pm 0.2^\circ\text{C}$, the range of the measured temperature is from -20°C - 100°C .

15 Points for Attention to Use of Operation Instruction

- ✓ The present operation instruction is subject to change without notice.
- ✓ The content of the operation instruction is regarded as correct. Whenever any user finds its mistakes, omission, etc, he or she is requested to contact the manufacturer.
- ✓ The present manufacturer is not liable for any accident and hazard arising from any misoperation.
- ✓ The functions described in this operation instruction should not be used as grounds to apply this product to a particular purpose.