

# **PLUM RAM**

## **User Manual**

<b>WELCOME</b> .....	ERROR! BOOKMARK NOT DEFINED.
<b>IMPORTANT SAFETY PRECAUTIONS</b> .....	<b>1</b>
<b>GETTING STARTED</b> .....	<b>3</b>
BATTERY USE.....	3
<i>Installing the battery</i> .....	3
<i>Charge the battery</i> .....	4
SIM CARD INFORMATION .....	4
<i>Installing the SIM card</i> .....	5
<i>Access codes</i> .....	5
INSERT MEMORY CARD.....	6
EARPHONE .....	6
<b>STANDBY MODE</b> .....	<b>6</b>
PHONE LAYOUT .....	7
ENTER TEXT .....	9
<b>CALL FUNCTIONS</b> .....	<b>9</b>
MAKE A CALL .....	9
<i>To make an international call</i> .....	9
<i>To Make a call from the phonebook</i> .....	9
CALL WAITING .....	10
CALL OPTIONS .....	10
<b>MAIN MENU</b> .....	<b>10</b>
OVERVIEW OF MENU FUNCTIONS.....	10
<b>CALL CENTER</b> .....	<b>11</b>
MISSED CALLS .....	11
DIALED CALLS .....	11

RECEIVED CALLS.....	11
DELETE CALL LOGS .....	11
CALL SETTINGS .....	11
<i>SIM 1/2 call setting</i> .....	11
ADVANCED SETTINGS .....	12
<i>Auto redial</i> .....	12
<i>Call time reminder</i> .....	12
<i>connect notice</i> .....	12P
<i>Answer mode</i> .....	12
<b>PHONEBOOK.....</b>	<b>12</b>
ADD NEW CONTACT .....	12
SEARCH.....	13
PHONE SETTINGS .....	13
<b>FILE MANAGER .....</b>	<b>14</b>
<b>ORGANIZER .....</b>	<b>14</b>
SKYBUDDY.....	14
SOKOBAN .....	14
CALENDAR .....	14
ALARM.....	15
WORLD CLOCK.....	15
CALCULATOR .....	15
EBOOK READER.....	15
<b>MESSAGES .....</b>	<b>16</b>
TEXT MESSAGE.....	16
MULTIMEDIA MESSAGE.....	16
<i>Inbox</i> .....	16
<i>Drafts</i> .....	16
<i>Outbox</i> .....	16

<i>Sent messages</i> .....	16
BROADCAST MESSAGE.....	16
<i>Template</i> .....	16
<i>Message settings</i> .....	16
<b>MULTIMEDIA</b> .....	<b>17</b>
CAMERA.....	20
IMAGA VIEWER.....	17
VIDEO RECORDER .....	17
VIDEO PLAYER .....	17
AUDIO PLAYER.....	18
SOUND RECORDER.....	18
FM RADIO .....	19
<b>SERVICES</b> .....	<b>19</b>
SIM TOOL KIT .....	20
INTERNET .....	20
<i>Homepage</i> .....	20
<i>Bookmarks</i> .....	20
<i>Input address</i> .....	20
<i>Recent pages</i> .....	20
SETTING .....	20
DATA ACCOUNT .....	20
<b><u>CAMERA</u></b> .....	<b><u>20</u></b>
<b>SETTINGS</b> .....	<b>21</b>
DUAL SIM SETTING .....	21
USER PROFILE .....	21
PHONE SETTINGS.....	21
NETWORK SETUP.....	22
SECURITY SETTINGS .....	22

<i>SIM Security Setup</i> .....	22
<i>Phone security</i> .....	23
<i>Phone lock</i> .....	23
<i>Change Password</i> .....	23
<i>Auto Keypad Lock</i> .....	23
<i>Privacy protectz</i> .....	23
CONNECTIVITY.....	23
<i>Bluetooth</i> .....	23
<i>Data account</i> .....	24
<i>Restore factory settings</i> .....	24
<b>TROUBLESHOOTING</b> .....	<b>24</b>

## Important safety precautions

- ◆ In a thunderstorm, do not use the phone while charging, or use the phone outdoors, to avoid being struck by lightning or other damage.
- ◆ Do not leave the battery in hot places, it may cause fire or explosion.
- ◆ Do not store or carry flammable liquids, gases, or explosive materials in the same compartment as the phone, its parts, or accessories.
- ◆ Remember to follow any special regulations in force in the area you are in, and always switch off your phone whenever it is forbidden to use it, or when it may cause interference or danger.
- ◆ Do not put the phone in or on heating devices, such as a microwave oven, stove, or radiator. The phone may explode when overheated.
- ◆ Do not attempt to open the phone's casing. Non-expert handling of the phone may cause damages to your phone. If the phone or any of its accessories are not working properly, take them to your nearest qualified service center. The personnel there will assist you, and if necessary, arrange for the phone to be repaired.
- ◆ Use only accessories and charging devices approved by the phone manufacture! Otherwise you risk serious damage to health and property. The battery could explode, for instance.
- ◆ Do not short-circuit the battery. Accidental short-circuiting can occur when a metallic object like a coin, clip or pen causes a direct connection between the + and – terminals of the battery (metal strips on the battery). For example, do not carry a spare battery in a pocket or bag where the battery may contact metal objects. Short-circuiting the terminals may damage the battery or the object causing the short-circuiting.
- ◆ The battery can be charged and discharged hundreds of times, but it will gradually wear out. When the operation time is noticeably shorter than normal, it is time to buy a new battery. Do not continue to use the broken USB data cable or battery charger.
- ◆ If you use any other personal medical devices, consult the manufacturer of your device to determine if it is adequately shielded from external RF energy. Your physician may be able to assist you in obtaining this information. Switch off your phone in health care facilities when regulations posted in these areas instruct you to do so.
- ◆ Do not use mobile phones when driving. When driving a car, driving is your first responsibility. When using your wireless phone while driving, follow local regulations in the country or region you are in.

- ◆ Keep the phone and all its parts and accessories out of the reach of small children and pets. They accidentally damage these things or choke on small parts.
- ◆ Do not clean the phone while charging the phone. You may be electric-shocked if you use the phone while charging the phone with the USB data cable or the battery charger. Make sure to disconnect the USB data cable or the charger before using the phone.
- ◆ Do not use harsh chemicals, cleaning solvents, or strong detergents to clean the phone. Wipe it with a soft cloth slightly dampened in a mild soap-and-water solution.
- ◆ Dispose of worn out batteries and phone in accordance with local provisions!

# Getting started

You need to insert the SIM card and charge the battery before using the phone.

## Battery use

To extend the battery life of your device:

1. Use the standard wall charger to charge the battery for the first time.
2. During the first 3-5 charge cycles, charge the battery until the battery indicator on the display stops scrolling.
3. Avoid partial charging. Also, wait for the battery to discharge completely before charging it again.
4. Charge the battery using the USB cable only if the recommended wall charger isn't readily available.

## Installing the battery

1. Loosen the screw, hold the back cover and gently slide in upward direction to open.

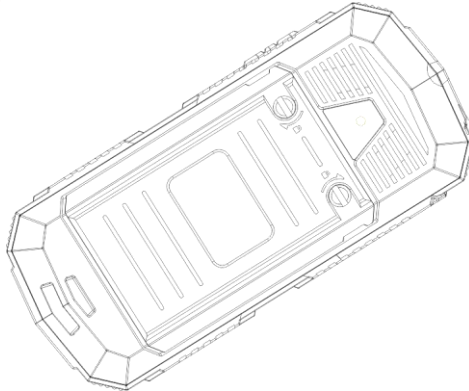

2. If the battery is in the compartment, lift and pull it out in the direction of the arrow (shown below).



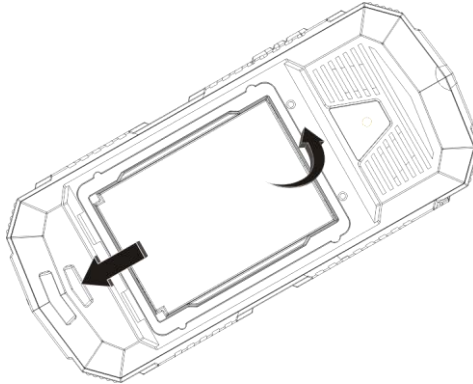

3. Replace the battery. Align the contacts of the battery with the corresponding connectors in the battery compartment.

### **Charge the battery**

To charge the device battery:

1. Take the USB cable from the device packaging, and attach it to power adapter. Now connect the power adapter into a standard AC wall outlet.
2. Connect the micro USB connector on the cable into its designated port on the device (left side). The battery level indicator on the device screen will start scrolling horizontally to indicate that the battery is being charged.
3. When the battery is fully charged, the battery level indicator on the device screen will stop scrolling horizontally. Once charging is complete, disconnect the charger from the device, and then from the wall outlet.

**NOTE:** Exercise extreme caution while connecting the charger to the device. The connectors on the charger and on the phone may get damaged if too much force is applied while connecting them. If the battery is completely discharged, it may take a while before the on-screen charging indicator starts scrolling.

### **SIM card information**

When you subscribe to a cellular network, you receive a plug-in SIM (Subscriber Identity Module) card loaded with your subscription details, such as your PIN, and available optional services.

Be careful to handle, insert or remove the SIM card since the SIM card

and the contacts inside can easily be damaged by scratching or bending.

### **Installing the SIM card**

Insert the SIM cards into their respective slots. Make sure that the contact area on the cards is facing the connectors on the device (as shown below).

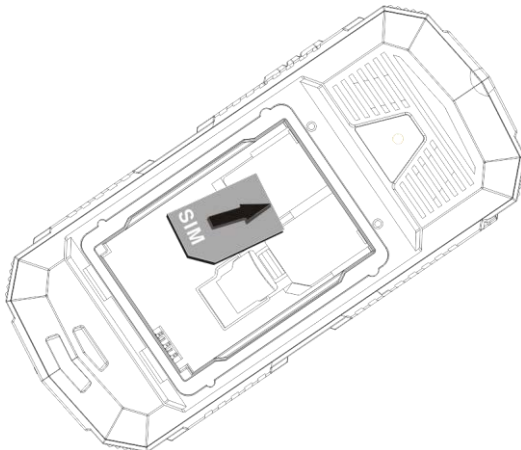

### **Access codes**

There are access codes for your SIM card. These codes help you to protect the phone against unauthorized use.

When requested for any of the code explained below, key-in the appropriate code (displayed as asterisks) and press the OK key.

- **PIN**

The Personal Identification Number or PIN (4-8digits) protects your SIM card against unauthorized use. The PIN comes with the SIM card; see the SIM card instruction provided with your card.

If you enter an incorrect PIN three times in succession, the code will be disabled and cannot be used until you re-enable it by entering the PUK.

- **PUK**

The 8-digit PUK (Personal Unblocking Key) is required to change a disabled PIN. The PUK may be supplied with the SIM card. If not, or in case you have lost it, please contact your service provider.

To re-enable your PIN, proceed as follows.

1. Key-in the PUK and press the OK key.
2. Enter a new PIN of your choice and press the OK key.
3. When the Confirm New PIN message is displayed, key-in the

same code again and press the OK key.

If you enter an incorrect PUK ten times in succession, the SIM card becomes invalid. Please contact your service provider for a new card.

## Insert memory card

Insert memory card. Take compatible T-Flash card, and place it into its slot. (shown below).

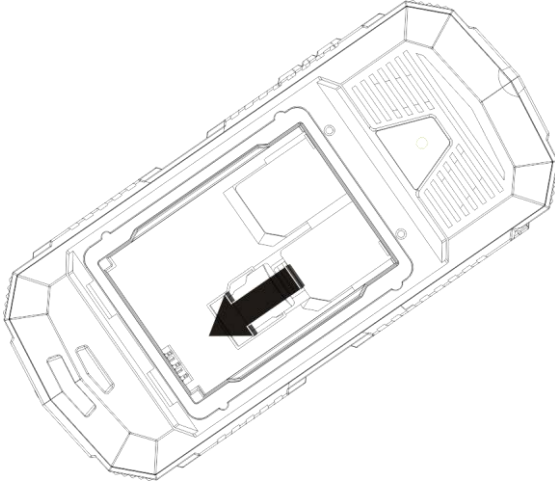











## Earphone

Connect the earphone connector on the cable into its designated port on the device (left side).

## Standby mode

In the main display, you may see several icons displayed on your status bar. The meaning for each icon is explained below:

	Vertical bars indicate the signal strength of the GSM network signal. Five bars indicate that your current position has the best reception.
	Dual SIM are Activated.
	Indicates new text message.
	Indicates that the SIM 1 call divert is activated.

	Indicates that the alert type of your phone is set as ring.
	Indicates that the alert type of your phone is set as mute.
	Indicates your phone is locked.
	Indicates that the alert type of your phone is set as headset.
	Indicates the alarm clock is set.
	Indicates the battery charge level.
	Indicates you are using Bluetooth.

## Phone layout

Size: 122 x 53x 20 mm



No.	Key note	Functional Description
1	Left soft key (LSK)	Press to perform the function currently displayed in the lower left corner of the screen. Long press to activate the flashlight

2	Right soft key (RSK)	Press to perform the function currently displayed in the lower right corner of the screen.
3	Message keys	Quick access to inbox.
4	Camera	Quick access to camera
5	Send key	Press to make a call. Hold to redial the last number called.
6	End key	To hand up on a call during a call or power on/off.
7	Navigation keys	In the standby mode, quick access to (Up key) Music Player (Left key) User profiles (Right key) Add new contact (Down key) Alarm Move the cursor to select the menu you want.
8	OK key	Confirm key
9	Numeric keypad	Input numbers or characters
10	receiver	receiver
11/12	USB port	USB port
	Earphone jack	Earphone jack
13	LED	Flashlight
14/15	Volume key	Press to adjust the volume of your phone.
16	Camera	camera
17	loudspeaker	loudspeaker
18	mic	mic

## Enter text

### ABC, Zi, Number, and Symbol modes

You can enter text in some features such as Messages, Phonebook, or Calendar, using ABC mode, Zi mode, Number mode, and Symbol mode. You can enter text by pressing the alphanumeric keys on the phone.

### Text Input Options:

While you are in text editing mode, you will be in several modes.

When you see [Option] and [Clear] in the soft key, press the soft key (left) for option: you can save the entry or change the Text Input Method. To erase a character, press the soft key (right) next to the character you want to erase.

### You can define the default Input Method of your phone and change input methods.

To define your preferred input method, go to **Phone Setup** sub menu in **Settings** menu. Then select **Preferred Input Method**. Once you set the preferred input method, next time you edit in text input mode, the setting will be applied until you change to another.

If you want to change the text input method temporarily, in the text input mode, press [Option] soft key, and select "Input Method" from the option.

- the input methods will swap when you press the [#].
- Press the [\*] key to select Symbols.
- Press [0] to insert a space.

## Call functions

### Make a call

This gives you information about the calling service supported in your phone.

In standby mode, key in the number, including the area code, and press **send** key. Your phone will dial out based on your default dial setting.

### To make an international call

- For international calls, long press [\*] for the international prefix (character +).
- Key in the country code, area code and the phone number.
- Press **send** key to call.

### To Make a call from the phonebook

- In the standby mode, press right soft key (RSK) to enter Phonebook.

Scroll to the desired contact name or type the name in the input box, and then press send key to make the call.

- You can also press Menu and choose Phonebook submenu. Use navigation keys to select Search option. You can directly select a name from the phonebook list or enter the name in the quick search field. Then press **send** key to make the call.

## Call waiting

You can answer another incoming call while you have a call in progress.

During a call, press left soft key (LSK) to enter the **Option** menu to hold the current call and switch to the new incoming call. You can swap back anytime by pressing left soft key (LSK) again and select **Swap**.

## call options

A call can be connected to any single caller by pressing **Options**. When you press **Options** during an active call, you would have following functions as listed in below:

- **Hold single call:** put a call on hold
- **End single call:** end a call.
- **New Call:** make a new call during an active call.
- **Phonebook:** shortcut to **Phonebook** menu.
- **Messages:** shortcut to **Messages** menu to write text message.
- **Sound Recorder:** to record your conversation during an active phone call.
- **Mute:** set On/ Off to mute the call during the conversation.
- **DTMF:** set On / Off for DTMF (Dual Tone Multi-Frequency) tone dialing system.

## Main menu

To access Menu mode, press [**Menu**] in Idle mode.

Some menus are operator, network and subscription dependent.

## Overview of menu functions

Basic menu	Call center Phonebook
------------	--------------------------

	File manager Organizer Messages Multimedia Services Voice call Settings
--	---

## Call center

To access this menu, press [**Menu**] in Idle mode and select Call History

### Missed calls

In **Call Record** menu, choose **Missed Calls**, and press **OK** to view the records. This menu displays the most recent received calls that you did not answer.

### Dialed calls

This menu displays the most recent calls you have dialed.

### Received calls

This menu displays the most recent calls you have received.

### Delete call logs

This function can delete your call records all of the records

In. Also can part delete: Missed calls, Dialed calls, Received calls

## Call settings

### SIM 1/2 call setting

This option enables you to set the general call settings of the phone.

The options are: **SIM1/2 call settings**

Enable you to set the call settings for SIM1 and SIM2. The options are:

- Call waiting: You can activate this function or deactivate it, and also view the current settings via query.



- **Call divert:** You can set to forward the incoming call in different conditions and enable to Activate/Deactivate call diversion and check the Query status.
- **Call barring:** In order to activate this service, it requires the services provided by the network service provider. When you change barring password, you need to input the old password.

## **Advanced settings**

### **Auto redial**

You can touch to redial the number automatically when a call is not connected.

### **Call time reminder**

After setting this function to 'on', it will offer a warning tone towards the single or periodic setting as your own during the call process, so you will be reminded of the call time at periodic intervals during a call.

### **connect notice**

Open this function, the phone will have a voice on tips

### **Answer mode**

set answer mode, Any key and Headset mode to be automatic answer . Press middle key to set On or Off.

## **Phonebook**

You can store phone numbers on your SIM card and in your phone's memory. The SIM card and phone's memory are physically separate, but they are used as a single entity called Phonebook. To access this menu, press **[Menu]** in Idle mode and select **Phonebook** or press RSK key to enter **Phonebook** .

### **Add New Contact**

Use this menu to add a new contact to Phonebook, SIM1, SIM2 and phone private phonebook.

## Search

Search names and numbers saved in the **Phonebook**.

Select the one you wish to call, and press Send Key to make a call.

In the search mode, you might press # key to change the input method.

You can finish the following operations with the find number:

**View:** view the detailed information of the selected number.

**Send text message:** send SMS to the selected number.

**Send multimedia message:** send MMS to the number.

**Call:** call the number you select.

**Edit:** edit the selected number.

**Delete:** delete the number from phone or SIM card.

**Copy:** copy the number from the SIM1card to phone, or copy from SIM1 card to SIM2 card.

**Caller groups :** Edit the group name, select ring tone, which can discriminate the caller group.

## Phone Settings

Set the phonebook parameter.

**Preferred storage:** set the preferred storage media: SIM1/2, Phone.

**Speed dial :**If you assign the number to one of the speed dialing keys (from 2 to 9 ) saved in the phonebook list, you can call the phone number by long pressing the key in the standby mode.

**Extra numbers:** You can set the SIM card 1 or 2 of the SIM card fixed dial-up, need to carriers network support

**Memory status:** show the used storage and total storage of SIM card and phone.

**Copy contacts:** it can allows copying the entries of SIM1/2 card or phone each other.

**Move contacts:** Allows you move all contacts information to different storage location.

**Delete all contacts:** You can delete all phonebook data in SIM1, SIM2 or Phone.

## File manager

In this menu, you can manage images, audio, music, photos, and other contents you have downloaded. Two menus will be displayed: Phone, Memory. Scroll to **Phone** and press **Options**, the options include: **Open** and **Format**. Scroll to **Memory card** and press **Options**, the options include: **Open**, **Memory Status** and **Format**.

## Organizer

### Skybuddy

In skybuddy face talk, skype, twitter, facebook and MSN, yahoo and practical function. This function need to opened GPRS networks and insert the memory card to cell phones, the first time use need to download the application to the phone.

### Sokoban

Sokoban game is a classic game, it has 108 that roadblock, you can in the game experience

### Calendar

This feature allows you to keep track of your schedule and event saved in the calendar. You can also switch on the alarm with the task for reminding.

Your phone provides the following selections for your option:

**View:** To view the note stored in a specified date.

**View all:** To view all notes stored in a specified date.

**Add event:** To add a new event in a specified date.

**Delete event:** To delete a specific task, multiple tasks or all tasks.

**Jump To Date:** To jump to a specific date.

**Go to today:** Jump to today

## Alarm

This function allows you to set the alarm to ring at the time specified. The alarm clock works even when the phone is switched off.

In the menu, choose Alarm Clock and press **OK**.

Press **Edit** to set alarm time.

**Repeat:** select the ring mode: Once, Everyday, Days.

**Snooze:** set continuous alarm time.

**Alert type:** select the alert type.

## World clock

You can select a world city via the navigation left and right keys. When the cross points out a certain city, it will show the local date and time.

Also, you may press **Options** to turn on/off **Daylight Saving Time** for a foreign region.

## calculator

The calculator applies simple calculate function such as addition, subtraction, multiplication and division.

## Ebook reader

You can read any file in TXT format saved in the memory card. Just copy the file in the folder of [eBook] in the memory card under the directory [File management], and run the ebook feature. If the file is not in the folder, just "open the electronic book" through the options of the file, and the file will be moved to the folder automatically.

# Messages

Use the Messaging menu to send and receive short messages and multimedia messages. You can also use a voice-mail, and cell broadcast message features. To access this menu, press **[Menu]** in Idle mode and select **Messages**. Message functions are available depending on network services that your service provider supports.

## Text Message

Use this menu to create and send a message.

## Multimedia message

Use this menu to create and send a multimedia message.

Multimedia Message Service (MMS) delivers messages containing a combination of text, image, and audio,.

**Note:** • The maximum size allowed for a message can differ, depending on your service provider.

## Inbox

This folder stores all of the messages you have received

## Drafts

This folder stores messages you have saved to send at a later time.

## Outbox

You can view the messages that the phone has failed to send.

## Sent messages

This folder contains the storage is has been sent information

## Broadcast Message

This network service allows you to receive the broadcast messages on various topics such as weather, traffic, local district code, local hospitals, taxis or pharmacy in your area.

For more information about broadcast message topics, please contact your service provider.

**Note:** This service may not be available on all networks. For more information about the available subjects, please contact your network service provider.

## Template

Use this menu to make and use templates of frequently used messages.

## Message settings

The information set includes SMS, MMS, service information se

# Multimedia

## Imaga viewer

All images can be reviewed from the phone or memory card. You may choose to view your images in **List Style** or **Matrix Style**.

Your phone provides the following selections for your option:

- **View:** Allows you to view the pictures saved in **Photo Album**.
- **Image information:** View photo detailed information
- **Browse style:** Allows you to select between **List Style** or **Matrix Style** when you browse pictures.
- **Send:** Allows you to forward a photo image via MMS or Bluetooth
- **Use as:** can use as wallpaper
- **Rename:** Allows you to rename the file.
- **Delete:** Allows you to delete the pictures in the **Photo Album**.
- **Sort by:** Allows you to view the related information about the selected image.

## Video recorder

In Multimedia menu, select Video Recorder and press OK. You can press ok key to start recording and press RSK to stop recording. On the preview mode, you can press **Options**. you can adjust the settings.

**Camcorder settings:** Night mode, Banding.

**Restore default:** Restore default settings.

## Video player

Play videos stored on the micro T-Flash card or the phone memory. The supported video formats are 3GP and MP4. Press **Options** to perform additional functions.

## Audio player

You may enter the music player via main menu or use the side quick key for quick access. Another way to access the music player is through the navigation left key. You may listen to the music, speech, or even listen to an English lesson in MP3 and AAC format. You may also download the music content via USB or other connection. Music tracks must be saved in **My Music** folder in **File Manager** in order to be automatically detected and added into the default play list. You may listen to the music through the headset or loudspeaker. The user-friendly interface is specially designed to enable users to control, play, pause, and stop the music player as you wish.

If you are a first-time user, your music player will automatically detect and add all the music tracks into the default play list.

Into the music list interface can choose according to the left key play, check the detailed information, update the list and set music player

**Settings:** Allows you to turn on auto refresh play list. In the **Music Player** menu, choose **Settings**. The setting options include:

### Player Settings:

**List auto gen.:** You can choose to refresh play list automatically or not.

**Repeat:** You can choose to repeat all songs, one songs or turn off this function.

**Shuffle:** This function is to mix the music tracks with different order.

**Background Play:** This function allows the phone to play the music continuously if you go back to the idled mode.

## Sound recorder

With this menu, you can record sound in AMR, WAV and AWB format and use it as ring tone, message tone, caller ring tone, alarm tone.

Your phone provides the following selections for your option:

- **Play:** Allows you to play the sound record.
- **Append:** Allows you to record in the same file.
- **Rename:** Allows you to rename a file.

- **Delete:** Allows you to delete the file saved in the **Voice Recorder**.
- **Use As:** Allows you to set the sound record file as ring tone, caller ring tone,
- **Send:** Allows you to forward the file to user profile or share with friends via MMS.and Bluetooth devices.
- **Settings:** Allows you to choose your preferred storage and audio quality.

## FM radio

To listen to the FM radio on your phone connects the compatible headset connector on the left side of the phone. Note that the quality of the radio broadcast depends on the radio station's coverage in that particular area.

- **Set Frequency:** If you know the frequency of the radio channel you would like to listen to (between 87.5 and 108.0 MHz),
- **Channel list :** This menu shows you the existing channels
- **Manual input:** Manual input your channels
- **Auto Search:** If you want to search radio channel, press Yes when Preset list confirm message show up. The search stops when channels has been found and show channel in Channel list.
- **Settings:** FM radio setting options:

**Background play:** Turn on/off Background play function.

**On:** allow radio continuing playing when exit FM radio

**Off:** when user exits FM radio, radio will stop.

**Loudspeaker:** Open the function FM radio broadcast by speaker

**Note:** Before use FM radio, please insert the headset first.

## Services

Service describe in the following are supported by your service provider.



Service describe in the following are supported by your service provider. If you cannot connect either one of those services, you might contact with your service provider for further information.

## **SIM Tool Kit**

In addition to the functions available in the phone, your service provider may offer additional applications such as weather or stock market information via the SIM card. This function is only supported when SIM card inserted.

## **Internet**

The Wireless Application Protocol (WAP) on your phone allows you to access the wireless web. Using the web browser, you can access up-to-date information and a wide variety of media content.

**Note:** To activate wap service, you need to contact your service provider.

To access this menu, press [Menu] and select **Services** then **Internet**.

## **Homepage**

Once connected, the homepage is displayed. The content depends on the service provider. To exit the browser, press end key.

## **Bookmarks**

You can use this menu to save URL addresses to quick access a web site.

## **Input address**

You can edit URL addresses to access a web site.

## **Recent pages**

You can view the recent pages you have visited.

## **Setting**

In the Settings menu, you can set the WAP default page, data account, the browser option and Internet parameters Settings

## **Data account**

Default data accounts based on major operators at the time this phone is manufactured are provided.

## **Camera**

To take a picture, press **Options** in the preview mode, you can adjust the setting.

Switch to video recorder: By camera switching to video

**Photos:** Into photo album

**Camera settings:** Set anti-flicker and delay timer

**Image settings:** Set Image size/Image quality.

**White balance:** Auto/Daylight/Fluorescent/Incandescent

**Scene mode:** Auto/Night

**Effect settings:** Normal/Grayscale/Sepia/Sepia green/Sepia blue/Color invert

**Storage:** Allows you to select the storage for saving images.

**Restore default:** This menu allows you to restore to the camera's default settings.

## Settings

The Settings menu provides you with various setting options to customize the phone to your preferences and needs. You can also reset the settings to their default values.

### Dual SIM Setting

Your phone support dual SIM mode which allows you to switch from one to the other as required. Dual-SIM operation allows the use of two services without the need to carry two phones at the same time.

Your phone provides 3 different SIM settings, including: Dual SIM Open, Only SIM1 Open, Only SIM2 Open.

### User profile

The available profiles are General, Silent, Meeting, Outdoor. You can also set the tone, volume, alert, ring, and so forth with **Options**, **Customize** option, so that whenever you receive an incoming call or a new message, you can customize the use of your phone to different types of call environments.

### Phone settings

You have following options listed under phone settings:

**Time and data:** Let you set time zone, time and date, time and date format and so forth on the phone.

**Schedule power on/off:** Let you set a particular time on the phone when the phone should power on/off itself.

**Language:** This phone allows you to set a language for the display in this phone.

**Preferred input methods:** This enables you to touch the text input method.

**Display :**Under Display you can set a host of different characteristics of the Wallpaper, Set up open shutoff standby interface time date to show.

**Dedicated Key:** This function allows you to re-assign the quick-access-feature default setting in 4-way navigation keys.

**Flight Mode:** Switch into flight mode while being on board, screening off partial function of telecom , normal mode or decide on when boot up .

**Misc settings:** You can set a host of different characteristics of LCD backlight and time.

## **Network setup**

### **Network Selection**

The Network Selection feature enables you to select automatically or manually the network used when roaming outside of your home network.

**Note:** You can select a network other than your home network only if it has a valid roaming agreement with your home network.

## **Security Settings**

Use this menu to protect the phone against unauthorized use by managing the several access codes of your phone and SIM card. There are six types of security setting categories, and you can optimize security mode by choosing sub menus in “Security Settings” in “Settings” menu. These security settings will help you to keep privacy and to prevent other people from using the phone without your permission.

### **SIM Security Setup**

This function allows you to activate password to protect your phone against unauthorized use.

Your phone provides the following selections for your option:

**PIN Lock:** This function allows you to lock the phone with a specific SIM card. The feature is designed to prevent the use of your SIM cards by means of another person's phone if your SIM cards lost. You can switch on or off to activate the PIN Lock function.

## **Phone security**

### **Phone lock**

You can switch on or off to activate the phone lock function to protect your phone. If you switch Phone Lock on, you need to enter the password to set the request on. The default password is "1122".

### **Change Password**

Allows you to change the phone lock password.

### **Auto Keypad Lock**

This allows you to lock the phone's keypad to prevent accidental key pressed. In **Auto Keypad Lock** submenu, select the time that after the last key press will be disabled, and press **OK**.

### **Privacy protectz**

Can set up open the phone book, information, call records privacy protection function, after open, access to relevant function need password. The password for 1122

## **Connectivity**

### **Bluetooth**

The Bluetooth connection can be used to listen to stereo music, send images, Video, texts and vCards.

**Power On/Off:** Turn on/off the Bluetooth feature.

**Visibility:** Set your bluetooth device is visible

**My device:** show BT device list. If the list is null, press OK key to search the new device. Select one device, press middle key to access:

**Search Audio Device:** Search the devices that are available.

**My name :** You can view the device name

**Active Device:** Activate the selected device.

**Settings:** Allows you to set the following Options : Audio path, Storage and device address.

**Note:** The received file saved in the Received folder.

### **Data account**

According to need to link the network service choose corresponding data account, and can edit, add, delete, change the default setting the account

### **Restore factory settings**

This feature would reset the phone to the same settings as those configured at the factory. In this case, it does not delete the downloaded objects and phonebook records.

You will need to input password to restore factory settings. The initial password is 1122.

## **Troubleshooting**

If problems occur when using the phone, try to find a solution here first.

Problems	Reasons and Solutions
Can't switch on	Press and hold end key until image appears on the display. Check the battery contacts. Remove and insert battery and switch your phone on again. Check the battery charge level.
Can't connect to network	Move into an area of better coverage. Beyond the network cover area. Contact your service provider if your SIM card is invalid.

<p>The audio quality of the call is poor</p>	<p>Press navigator key to increase the volume when you are in a call.</p> <p>Check the signal strength indicator on the display.</p> <p>The line is busy and can not be connected to network; you can not make a call.</p>
<p>Standby time too short</p>	<p>When failing to connect to network, the phone will keep searching base station that consumes much battery and reduces standby time. Move to an area with stronger signal strength or switch your phone off temporarily.</p> <p>Replace the battery.</p>
<p>SIM card error</p>	<p>Make sure that the chips in SIM card are not damaged; use the clean cloth to scratch it.</p> <p>Make sure that SIM card is inserted correctly.</p> <p>SIM card invalid. Contact your service provider.</p>
<p>Can not dial calls</p>	<p>Make sure that the number you dialed is available and the dial key has been pressed.</p> <p>Make sure that there is enough money to make a call.</p> <p>Make sure that SIM card is valid.</p>
<p>Can not receive calls</p>	<p>Make sure that your phone has connected to network (Check if the network is too busy or invalid).</p> <p>Make sure that there is enough money to receive the call.</p> <p>Make sure that SIM card is valid.</p> <p>Check call divert settings and incoming call barring settings.</p>
<p>The battery won't charge</p>	<p>Make sure that the battery is inserted correctly. Securely connect the charger to the phone.</p>

Can not set some functions	The operation is wrong. The network providers do not support the function, or you don't apply the function.
----------------------------	--