

SmartModem 56

THE ADVANCED MODEM FOR MISSION-CRITICAL SECURE COMMUNICATIONS

- ▶ Advanced, corporate-grade security, including DES encryption
- ▶ Flash-upgradeable, high-performance technology
- ▶ Synchronous and asynchronous communications
- ▶ PSTN, 2 & 4 leased-line capability
- ▶ Extensive command set for maximum host compatibility



User Guide

Contents

Introduction	6
Quick Start Guide	7
Step 1 - What you will find in the box	7
Step 2 - Connecting the Cables	8
Step 3 - Installing your Drivers	9
Windows XP	9
Windows ME	9
Windows NT4.0	9
Windows 2000	10
Windows 98	10
Step 4 - Using your Modem	11
Modem LED Display	12
The Option Switches	14
Leased Line Operations	15
RS-232 Signals	18
Abbreviated Command List	21
User Guide	29
The AT Commands	29
Selecting Speeds	36
Flow Control	40
Configuring the Modem	42
Error Correction	43
Security & Encryption	48
Encryption	55
Synchronous Modes	63
Dumb Mode Operation	67
V.25bis Operations	73
Distinctive Ring	81
Caller ID	82
Call Logging	84
Commands	85
+++ Escape Sequence	85
**** Remote Access Sequence	86
AT? Interactive Command Help	88
A/ Repeat Last Command	89
ATA Answer	90
ATBn Select Communications Standard	91
ATD Dial	93
Dial Modifiers	94
ATE Echo	99
ATH Hang Up	100
ATI Identity	101
ATL Speaker Volume Control	102
ATM Monitor	103
ATO Return to On-line State	104
ATQ Quiet (Suppress Response Codes)	106
ATR Set Terminal Speed	107
ATSn? Display S Register Value	109
ATSn= Set S Register Value	110
ATV Verbal Response Codes	111

ATW Connection Speed Information	112
ATX Extended Response Codes	113
ATZn Restore Configuration Profile	115
AT&B Character Length	116
AT&C Controlling Data Carrier Detect	117
AT&D Controlling Data Terminal Ready	118
AT&F Reinitialise Modem	119
AT&F Restore Factory Defaults	120
AT&G Guard Tone	121
AT&H Clock Control	122
AT&K Flow Control	123
AT&L Leased Line	125
AT&M Synchronous/Asynchronous Mode	126
AT&N Abort Connection	128
AT&R RTS/CTS Control	129
AT&S Controlling DSR	130
AT&Vn View Active Configuration Profile	131
AT&Wn Write Configuration Parameters	132
AT&X Transmit Clock	133
AT&Yn Select Stored Profile on Power Up	134
AT&Z Stored Phone Number	135
AT#A Universal Remote Access	136
AT#B 1200bps Originate Mode	138
AT#C V.25 Calling Tones	139
AT#CID Caller ID	140
AT#D V.25bis Direct Calling	142
AT#E Encryption	143
AT#H Display Help	144
AT#I V.22bis Leased Line	145
AT#J V.42 Capability Checking	146
AT#K MNP 10 mode	147
AT#M Command Mode Selection	148
AT#N V.25bis Character Encoding	149
AT#O Buffer Overflow	150
AT#Q V.25bis Terminal Speed	151
AT#R Enable Remote Control	152
AT#S Security Menu	153
AT#U V.25bis Character Set	154
AT#V Verifier	155
AT%B AutoAnswer Setting	156
AT%C Compression Control	157
AT%D Set Disconnect Delay	158
AT%E Auto EQM Retrain	159
AT%F DTR/DSR override	160
AT%H MNP 10 Negotiation Speed	161
AT%K CTS During Dial and Handshake	162
AT%L Display Line Signal Level	163
AT%Ln Transmit Level (Data Mode)	164
AT%M Mode LED Indication	165
AT%N Non-Standard Terminal Speeds	166
AT%P CONNECT Message Timing	167
AT%Q Line Signal Quality	168
AT%R CTS Override	169

AT%S DSR Override	170
AT%T DCD Override	171
AT%U V.42 Response Codes	172
AT%W Welcome Message	173
ATA MNP Block Size	174
AT\bN Generate Break	175
AT\J Auto-Reliable Fallback	176
AT\K Break Control	177
AT\N Asynchronous Operating Mode	179
AT\Q Extended Flow Control	181
AT\S Display Active Configuration	182
AT\Tn Inactivity Timer (Data Mode)	183
AT\V Error Correction Response Codes	184
AT\X XON/XOFF Pass Through	185
AT*K Select Primary DES KEY from Stored Keys	186
AT*R V.13 Remote RTS Signalling	187
AT*S Change Current User Password	188
AT*T Auto Call Redial	189
AT*V Maximum V.42bis Dictionary Size	190
AT*W Welcome Message Text	191
AT*Y Escape Seq. Detection in Sync.	192
AT+ICF Character Framing and Parity Select	193
AT+MS Select Modulation	194
AT+MS=? Reporting Supports Options	198
AT-Q MNP10 Fallback to V.22bis	199
AT-DATE Time & Date	200
AT-LOG Call Log	201
AT+E V.32 compromise Equaliser	202
V.25BIS - CIC Connect Incoming Call	203
V.25BIS - CRN Dial	204
V.25BIS - CRS Dial Stored Number	206
V.25BIS - DIC Disregard Incoming Call	207
V.25BIS - PRN Stored Phone Number	208
V.25BIS - RST Reset	209
S Registers	210
ATS0 Rings Before Answer	212
ATS1 Ring Count	213
ATS2 Escape Sequence Character	214
ATS3 Carriage Return Character	215
ATS4 Line Feed Character	216
ATS5 Backspace Character	217
ATS6 Dial Tone Wait Time	218
ATS7 Wait for Carrier	219
ATS8 Pause Dial Modifier Delay	220
ATS9 Carrier Detect Response Time	221
ATS10 Lost Carrier/Hang Up Delay	222
ATS11 DTMF Tone Timing	223
ATS12 Escape Sequence Guard Time	224
ATS16 Test in Progress (read only)	225
ATS18 Test Timer	226
ATS25 DTR Loss Detection	227
ATS26 RTS/CTS Delay	228
ATS27 Delay Before Dial	229

ATS29 Hook Flash Duration	230
ATS30 Inactivity Timer	231
ATS33 EQM Threshold Value	233
ATS38 Disconnect Delay	234
ATS42 Modem Disconnect Reason	235
ATS43 Break Sequence Length	236
ATS45 V.22bis EQM Threshold Value	237
ATS57 DTR High Detection	238
ATS62 V.42 Detection Timer	239
ATS66 Remote Access Guard Time	240
ATS67 Remote Access Character	241
ATS69 Command Line Time-out	242
ATS71 Ignore Incoming Call	243
ATS74 Disconnect Reason for Prev. Call	244
ATS80 Flow Control High Water Mark	245
ATS81 Flow Control Low Water Mark	246
ATS82 Failsafe Flow Control Overrun	247
ATS95 Extended Response Codes	248
ATS96 Help Page Width	249
ATS97 Help Page Length	250
ATS105 Voice 'Dead Man' Timer	251
ATS122 AutoRateChange	252
ATS123 AutoRateChange	253
ATS124 Duration EQM	254
Modem Response Codes	255
Glossary	257
Specifications	278
Registering your NetComm Product	279
Product Warranty	280
Legal & Regulatory Information	281

Introduction

Welcome to the SmartModem56 User Guide, a comprehensive guide to the efficient use of your modem. Together with the Quick Start Guide section, also supplied with your modem, this reference manual provides all the information needed to make maximum use of your equipment and software. The SmartModem56 User Guide is divided into the following sections:

Quick Start Guide

- ❑ A complete step-by-step description of how to get started using your SM5695 Modem, including more advanced topics - such as Modem LED Display, Option Switches, Leased Line Operations, RS-232 Signals and an Abbreviated Command List.

User Guide

The AT Commands

- ❑ Introduces you to the AT Commands and how to use them.

Error Correction

- ❑ Examines and explains the error correction features, including V.42bis data compression, of your equipment.

Security

- ❑ Examines and explains the data security and encryption features of your equipment.

Synchronous Modes

- ❑ Full details on how to use your modem for synchronous operations.

Dumb Mode

- ❑ Provides product specified information on Dumb Mode operation.

V.25bis Operations

- ❑ Describes how your modem implements V.25bis and how it interacts with AT commands.

Distinctive Ring

- ❑ Explains how to use Distinctive Ring and its associated commands.

Caller Id

- ❑ Explains how to use Caller Id and its associated commands.

Commands

- ❑ Provides a complete description of all commands available in your modem.

S Registers

- ❑ Introduces you to S Registers and how to use them.
- ❑ Contains a description of the available S Registers.

Response Codes

- ❑ This section provides information on the response codes supported by your modem.

Glossary of Communications Terms

- ❑ Provides descriptions of modem, facsimile and other communications terms.

Quick Start Guide

Step 1 - What you will find in the box

Everything you need to get started comes straight out of the box:

- SmartModem56 (SM5695).
 - a telephone cable to connect your modem to the telephone line.
 - a power supply for your modem.
 - a CD ROM† containing modem software and documentation.
 - a serial cable to connect your modem to your computer.
- † If you don't have a CD ROM drive, contact NetComm on (02) 9424 2070 to obtain 3.5" floppy disks at an additional charge.

Step 2 - Connecting the Cables

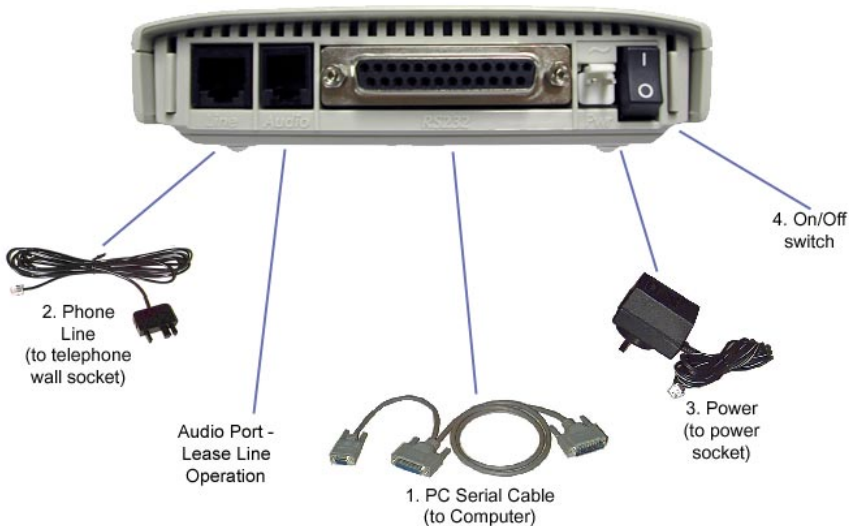

Turn your computer off.

1. Plug the data cable's male end (pins showing) into the socket at the back of your Modem and then plug the female end (no pins showing) of the same cable into the COM port at the back of your computer.

Your computer's COM port could be 9 pins or 25 pins. Use the appropriate connector on the cable supplied to connect your modem to your Serial port.

2. Plug the telephone cable into the socket marked LINE at the back of your Modem and the other end of the cable into your telephone wall socket.

Your modem is supplied with an AUDIO Port to allow 4-wire leased line operation. Refer to the section on Leased Line Operations for details on this feature.

3. Plug the power cable pin into the POWER socket at the back of your Modem and plug the power supply into a suitable power point.
4. Turn your Modem on and check that some of the Modem lights illuminate.

Restart your computer. Now you need to install your Modem's Driver. Which operating system is your computer running? Read the next section for driver installation instructions.

Step 3 - Installing your Drivers

Your modem comes with a Netcomm CD ROM which includes software and manuals for your SM5695 Modem.

Windows XP

1. Please insert the NetComm CD supplied and, when the "Found New Hardware Wizard" recognises the new Modem, select "Install from a list or specific location. [Advanced]", and then click "Next"
2. Select "Search for the best driver in these locations" and choose "Include this location in the search:". Type in "D:\" (where D:\ is the letter of your CD ROM drive) and click "Next".
3. The Wizard will search for the correct driver. The drivers that Windows XP uses are not digitally signed by Microsoft. Click "Continue Anyway".
4. Windows XP will now copy the required files.
5. Once all files have been copied, click "Finish", and the installation is complete.

Windows ME

1. Please insert the NetComm CD supplied and, when the "Found New Hardware Wizard" recognises the new Modem, select "Specify the location of the driver [Advanced]" and click "Next" to search for the driver.
2. Select "Search for the best driver in these locations" and choose "Specify a location".
Type in "D:\" (where D:\ is the letter of your CD ROM drive) and click "Next" to continue.
3. Click "Next" to start the installation.
4. Click "Finish" to complete the installation.

Windows NT4.0

1. Please insert the NetComm CD supplied and go to Start>My Computer>Control Panel, then double-click on "Modems" icon to install a new modem.
2. Select "Don't detect my modem; I will select it from a list" and then click "Next" to continue.
3. Click "Have Disk..." to install from the installation disk.
4. Type in "D:\" (where D:\ is the letter of your CD ROM drive) and click "Next" to continue.
5. Select "NetComm SM5695 SmartModem" from the list of Models and click "Next" to continue.
6. Select "Selected ports" choose the appropriate COM port. Click "Next" to start installing the selected modem.
7. Click "Finish" to complete the installation.

Windows 2000

1. Windows will detect the modem automatically. Please insert the NetComm CD supplied and click "Next".
2. Select "Search for a suitable driver for my device [recommended]", and then click "Next".
3. Select "Specify a location" and click "Next".
4. Enter the driver location "D:\\" where D:\ is the letter of your CD ROM drive and click on "OK".
5. Windows will find the correct driver for your modem. Click "Next" to continue.
6. When the "Digital Signature Not Found" screen appears, click "Yes" to continue.
7. Click "Finish" to complete the installation.

Windows 98

1. Please insert the driver CD supplied and, when the "Found New Hardware Wizard" recognises the new Modem, click Next to search for the driver.
2. Select the "Search for the best driver your device. [Recommended]" and click "Next" to continue.
3. Select the "Specify a location" option and type "D:\\" where D:\ is the letter of your CD ROM drive. Click "Next" to start the search for your driver.
4. Click "Next" to start the installation.
5. Click "Finish" to complete the installation.

Step 4 - Using your Modem

Your SM5695 Modem has a number of advanced features. For your convenience, the following section contains information on:

- Modem LED Display,
- Option Switches,
- Leased Line Operation,
- Abbreviated Command List, and
- Specifications.

For more information on your SM5695 Modem and a detailed command list, please refer to the User Guide included on the CD ROM in Adobe Acrobat format. If you do not already have Adobe Acrobat Reader software installed on your computer, a copy is provided on the CD ROM.

To install your Adobe Acrobat Reader software:

1. Go to the “Start” button in the right-bottom corner of the screen. Select “Run”.
2. Click on “Browse...” and go to “D:\Software\Acrobat\Win32\Acrobat Reader 5.00 English.exe” where D:\ is the letter of your CD-ROM drive.

Note: You will need to select the Linux, Win16 or Win32 directory depending on the Operating System you are using. For example, if your operating system Windows 95/98/2000/NT/ME/XP you will use the “Win32” version. If you are using Windows for Workgroups or Windows 3.X you will need to use the “Win16” version.

3. Click “OK” and the software installation screen will appear. Follow the screen instructions to install the software. A copy of the Adobe Acrobat User Guide is available in “D:\Manuals\Acrobat” where D:\ is the letter of your CD-ROM drive.

Modem LED Display

Transmit Data (TXD)

LED will flash when the modem is sending data.

Receive Data (RXD)

LED will flash when the modem is transferring data from the remote to the local computer.

Off-Hook

LED will glow when the modem is on-line; ie. dialling or answering

Carrier Detect

LED will glow when the modem detects a valid carrier signal from a remote modem.

Auto-Answer

LED will glow to indicate auto-answering operation. If the SmartModem is performing a test, the LED will flash until the test is completed or cancelled.

Terminal Ready

LED indicates the 'Data Terminal Ready' (DTR) signal is asserted.

Mode One, Two, Three and Four

For more information about Mode one to four LEDs, please turn to the next page.



Front Panel Mode LEDs

Line Modulation	One	Two	Three	Four
V.90 29333	⦿F	⦿F	○	●
V.90 30667	⦿F	⦿F	○	●
V.90 32000	○	●	●	○
V.90 33333	⦿F	⦿F	○	●
V.90 34667	○	○	●	○
V.90 36000	○	○	●	○
V.90 37333	●	●	○	○
V.90 38666	○	●	○	○
V.90 40000	○	●	○	○
V.90 41533	●	○	○	○
V.90 42667	○	○	○	○
V.90 44000	○	○	○	○
V.90 45332	⦿F	●	●	○
V.90 46667	⦿F	○	●	○
V.90 48000	⦿F	○	●	○
V.90 49333	⦿F	●	○	○
V.90 50667	⦿F	○	○	○
V.90 52000	⦿F	○	○	○
V.90 53333	⦿F	⦿F	●	○
V.90 54667	⦿F	⦿F	○	○
V.90 56000	⦿F	⦿F	○	○
33600 bps	⦿F	⦿F	○	●
31200 bps	⦿F	⦿F	●	●
28800 bps	⦿F	○	○	●
26400 bps	⦿F	○	●	●
24000 bps	⦿F	●	●	●
21600 bps	⦿M	○	○	●
19200 bps	⦿M	●	○	●
16800 bps	⦿M	○	●	●
14400 bps	●	●	●	●
12000 bps	●	●	○	●
9600 bps	○	●	○	●
7200 bps	○	●	●	●
4800 bps	●	○	○	●
2400 bps	⦿S	○	○	●
1200 bps	⦿S	○	●	●
1200/75 bps	⦿S	●	○	●
300 bps	⦿S	●	●	●

LED: ● = Off ○ = On

Flashing: ⦿S = Slow, ⦿M = Med, ⦿F = Fast

The Option Switches

The Option switches allow you to control the operation of your modem in Dumb mode, as well as providing additional features in Smart mode.



Note: Front panel Option switches 1 and 2 always take precedence over software setting of behaviour of DTR and DSR. When AT%F is set to 1 (when AT%F is set to 0, behaviour of DTR and DSR is controlled by AT commands if applicable).

Switches 1 and 2 are used to select AT command mode or V.25bis command mode, or control the state of the DTR and DSR signals.

Description	AT%F	Switch 1	Switch 2
AT command mode	%F0	Up	Up
V.25bis asynchronous	%F0	Up	Down
V.25bis synchronous (HDLC framing)	%F0	Down	Up
V.25bis sync (BSC character framing)	%F0	Down	Down
DTR controlled by computer	%F1	Up	n/a
DTR assumed to be asserted (raised)	%F1	Down	n/a
DSR acts normally	%F1	n/a	Up
DSR mimics DTR	%F1	n/a	Down

Switches 3 - 6 allow you to set up Dumb mode operation, as well as manually selecting loopback tests in Smart mode.

Description	AT#F	Switch	Switch
Smart mode	n/a	4 - Up	n/a
Dumb mode	n/a	4 - Down	n/a
Loopback Test Pattern Off	#F1	3 - Up	4 - Up
Loopback Test Pattern On	#F1	3 - Down	4 - Up
Analog Loopback Off	#F1	5 - Up	4 - Up
Analog Loopback On	#F1	5 - Down	4 - Up
Remote Digital Loopback Off	#F1	6 - Up	4 - Up
Remote Digital Loopback On	#F1	6 - Down	4 - Up
Auto-answer enabled	n/a	3 - Up	4 - Down
Auto-answer disabled	n/a	3 - Down	4 - Down
Asynchronous operation	n/a	5 - Up	4 - Down
Synchronous operation	n/a	5 - Down	4 - Down
Answer mode	n/a	6 - Up	4 - Down
Originate mode	n/a	6 - Down	4 - Down

+ n/a = not applicable

Leased Line Operations

A leased line, or private line, is a telephone line that permanently connects two or more locations. The leased line does not have any switching equipment associated with it.



Leased-line operation with the modem is selected with the &L command.

The &L command informs your modem that communications will occur over leased lines, with no answer tones being generated by the modem. If the modem detects a loss of the remote carrier signal while leased-line operation is selected, it will attempt to re-establish the connection rather than hang up.

If you select leased line operation with the &L1 command, you must issue the ATA command to answer a call, and the ATD command to initiate a call. If you use &L2 or &L3 to select Auto leased line operation, you do not need to issue the ATA or ATD commands; &L2 selects Originate mode automatically and &L3 selects Answer mode automatically or use the Talk/Data switch from the front panel. To dial or answer, raise DTR; to return to local command state, lower DTR.

You will require a special phone cable (available from your dealer) to connect your modem to a leased-line socket. The phone cable supplied with your modem is suitable for use with normal, dial-up, voice (PSTN) lines.



Before commencing leased-line communications, it is recommended that a non-auto-ranging B setting be specified.

If error correction is required, select a Reliable mode, not an Auto- Reliable mode. (See the W command.)

If auto-ranging and fallback are disabled in leased-line mode, your modem will only attempt to connect using the communications standard specified by the B command and the terminal speed.

Once a connection has been established, if your modem detects a loss of carrier it will continuously attempt to re-establish the connection.

Smart Leased- Line Mode

Leased-line operation is available in both asynchronous and synchronous mode¹.

Calling and Answering Using &L1

When operating in smart mode (&L1 set), the ATD and ATA commands are used to initiate and answer calls respectively.

Your modem will hang up and return to local command state if your computer transmits characters while the modem is attempting to establish or re-establish a connection (unless &N0 has been issued).

Auto Leased Line Operation (&L2 or &L3)

You can select Auto leased line operation with the &L2 or &L3 command. In Auto leased line operation you do not need to issue the ATA command to answer a call, or the ATD command to initiate a call. Issue the &L2 command to automatically select Originate mode, or the &L3 command to automatically select Answer mode.

In Auto leased line operation AT commands can only be entered while DTR is low. Irrespective of the &D setting, your modem will remain in idle mode when DTR is low, and will go on-line when DTR is high and the modem's TALK/DATA switch is set to DATA. If DTR is lowered (or the TALK/

DATA switch is set to TALK) when your modem is on-line, it will hang up and return to idle mode. If power is lost, your modem will enter on-line state when DTR is restored.

If your modem has a TALK/DATA switch, it must be set to DATA.

Hanging Up

There are five ways of hanging up your modem when leased-line mode is selected.

- If your modem is attempting to establish or re-establish a connection, sending characters to it will cause it to hang up (unless &N0 has been issued).
- If synchronous mode is selected, lowering the DTR signal will cause your modem to immediately hang up.
- If asynchronous mode is selected, issuing the ATH command will cause the modem to hang up.
- If asynchronous mode is selected (&L2 or &L3), lowering DTR will cause the modem to hang up.
- Switch the TALK/DATA switch to TALK.

XON/XOFF flow control should not be selected for leased-line connections. Your modem will prematurely hang up if your computer sends an XON/XOFF character while the modem is attempting to reestablish a connection.

Improving the Reliability of Leased-Line Connections If you are experiencing data errors over leased lines, issue the %L command to lower the transmit level of your modem. You may need to experiment with the levels, but start between %L15 and %L19.

The transmit level should be changed on both modems.

4 Wire Leased Line setup via audio port

To Setup 4 Wire LL via audio port:

1. Connect LL cable (Pins 1 and 4 for TX / 2 and 3 for RX) to the Audio ports on your SM5690's
2. Issue the following commands through HyperTerminal to activate Audio port:
 - AT&F (Reset)
 - AT-LINE=1 (Set audio port active)
3. Issue the following commands to activate LL mode:
 - a. For Auto Leased Line:
 - AT&L2 (Set auto LL mode) to be issued to Originate modem
 - AT&L3 (Set auto LL mode) to be issued to Answering modem
 - b. For Manual LL mode:
 - AT&L1 (Set LL mode) to be issued to both modems
 - ATA (Initiate manual answer) to be issued to answering modem
 - ATD (Initiate manual dial) to be issued to originate modem.

RJ11 Pin Assignments for Leased Line

Pin	Signal	Type
1	TX	
2	RX	
3	RX	+
4	TX	-

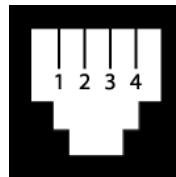

RS-232 Signals

This section describes each of the signals supported on the modem's RS-232 socket.

Pin assignments are only applicable to products with a 25-pin DB-25 connector. Refer to your Product Guide for information regarding the pin assignments for your product.

Transmit Data (TxD) - Pin 2

The computer transmits data to the modem via this pin.

Receive Data (RxD) - Pin 3

The computer receives data from the modem via this pin.

Request To Send (RTS) - Pin 4

This signal indicates to the modem whether the computer is ready to begin sending data to it. When RTS/CTS flow control is enabled, the RTS signal is used by the computer to pause the transmission of data from the modem to it. If RTS/CTS flow control is not selected, the RTS signal is ignored when the modem is in asynchronous mode or local command state.

Clear To Send (CTS) - Pin 5

This signal indicates to the computer the modem is ready to begin receiving data from it. When RTS/CTS flow control is enabled, the CTS signal is used by the modem to pause the transmission of data from the computer to it. If RTS/CTS flow control is not selected CTS will always be asserted when asynchronous operation is selected. With synchronous mode selected CTS will be lowered when the modem is on line until such time as DSR and DCD are asserted. CTS will always be asserted in local command state.

Data Set Ready (DSR) - Pin 6

This signal indicates to the computer that the modem is ready to begin communications.

In asynchronous mode, this signal will be asserted whenever the modem is switched on and is not performing a test. In synchronous mode, the DSR will only be asserted when the modem is off hook.

The &S command lets you control the state of the DSR signal.

Signal Ground (SG) - Pin 7

Ground for all signals on the RS-232 socket.

Data Carrier Detect (DCD) - Pin 8

This signal indicates the presence of a compatible carrier signal. In asynchronous mode, the modem may be configured to assert DCD at all times, ignoring the presence of an incoming carrier signal. The &C command allows control over the state of the DCD signal.

Transmit Clock (TxC) - Pin 15

This signal only affects the operation of the modem when synchronous mode is selected. This signal may be used to clock transmit data from the host computer.

The clock pulse may be derived from the computer connected to the modem (via the XCLK pin), the remote modem (via the receive carrier signal) or the modem's internal clock. The source of the transmit clock is determined by the &X command.

Receive Clock (RxC) - Pin 17

This signal only affects the operation of the modem when synchronous mode is selected. This signal is used by your computer to synchronise incoming data. The receive data clock is always derived from the receive carrier signal.

Data Terminal Ready (DTR) - Pin 20

This signal indicates to the modem whether the computer is ready to begin communications. When asynchronous mode is selected the &D command allows you to determine what the modem will do if the DTR signal is lowered while the mode is in on-line state. When synchronous mode 2 is selected, dialling and answering can be initiated by the DTR signal and the modem will hang up and return to local command state if the DTR signal is lowered. The &D command lets you control the DTR signal.

Ring Indicator (RI) - Pin 22

This signal will be asserted whenever an incoming call is detected.

External Clock (XCLK) - Pin 24

This signal is only used when a synchronous mode is asserted. The modem may be configured to use this signal for data transmission timing. The &X1 command allows external clocking to be used during synchronous connections.

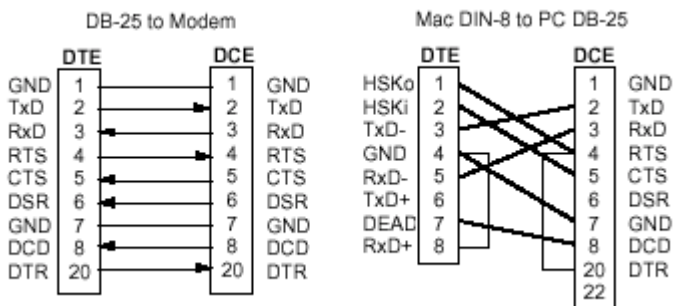

Null Modem Cable

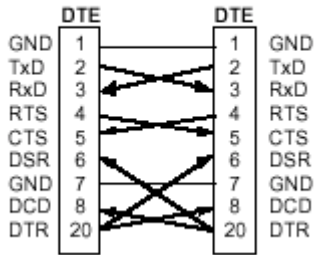

Description	ITU	PC IEA	PC PC	DB-9	MAC DB-25	MAC Mac	DIN-8	DB-9
Protective frame ground	101	AA	GND		1			
Transmit Data	103	BA	TxD	3	2		3	
Receive Data	104	BB	RxD	2	3		5	
Request to Send	105	CA	RTS	7	4		1	
Clear to Send	106	CB	CTS	8	5		2	
Data Set Ready	107	CC	DSR	6	6			
Reference signal ground	102	AB	GND	5	7		4	
Data Carrier Detect	109	CF	DCD	1	8		7	
Data Terminal Ready	108	CD	DTR	4	20	1		
Ring Indicator	125	CE	RI	9	22			

Standard RS-232 Examples

RJ11 Pin Assignments

Pin	Signal	Type
1	NC	
2	NC	
3	TIP	+
4	RING	-
5	NC	
6	NC	

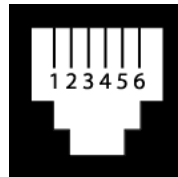

Abbreviated Command List

General Commands

+++	Escape Sequence	B45	V.90 at 34,667bps
+++	Return to local command state	B46	V.90 at 36,000bps
****	Remote Access Sequence	B47	V.90 at 37,333bps
?	Interactive Command Help	B48	V.90 at 38,667bps
A/	Repeat last command	B49	V.90 at 40,000bps
A	Answer an incoming call	B50	V.90 at 41,333bps
Bn	Select Communications Standard	B51	V.90 at 42,667bps
B0 ■	Auto-Connect	B52	V.90 at 44,000bps
B1	Auto-Connect	B53	V.90 at 43,333bps
B2	Auto-Connect	B54	V.90 at 46,667bps
B3	V.21 at 300bps	B55	V.90 at 48,000bps
B4	Bell 103 at 300bps	B56	V.90 at 49,333bps
B5	V.23 at 1200/75bps	B57	V.90 at 50,667bps
B6	V.22 at 1200bps	B58	V.90 at 52,000bps
B7	Bell 212A at 1200bps	B59	V.90 at 53,333bps
B8	V.22bis at 2400bps	B60	V.90 at 54,667bps
B9	Auto-Connect	B61	V.90 at 56,000bps
B10	V.32 at 4800bps	E0	Disable local command state echo
B11	V.32 at 7200bps	E1 ■	Enable local command state echo
B12	V.32 (Non-TCM) at 9600bps	H0	Hang up
B13	V.32 at 9600bps	H1	Go off-hook
B14	V.32bis at 12000bps	H2	Go off-hook after current connection terminates
B15	V.32bis at 14400bps	I0	Display numeric identity code
B16	V.34 at 14,400bps	I1	Return a checksum of modem's firmware
B17	V.34 at 16,800 bps	I3	Display model identifier
B18	V.34 at 19,200 bps	I4	Display code revision and creation date
B19	V.34 at 21,600 bps	I5	Display manufacturer identification
B20	V.34 at 24,000 bps	I9	Display complete product identification
B21	V.34 at 26,400 bps	I10	Display modem statistics
B22	V.34 at 28,800 bps	L0	Lowest speaker volume level
B23	31,200 bps	L1	Low speaker volume level
B24	33,600 bps	L2 ■	Medium speaker level
B25	(Reserved)	L3	Highest speaker volume level
B26	(Reserved)	M0	Speaker is always off
B27	V.34 at 2400bps	M1 ■	Speaker is on whenever the modem is dialling or answering a call. When a connection is established, the speaker is switched off
B28	V.34 at 4800bps	M2	Speaker is always on
B29	V.34 at 7200bps		
B30	V.34 at 9600bps		
B40	V.90 at 28,000bps		
B41	V.90 at 29,333bps		
B42	V.90 at 30,667bps		
B43	V.90 at 32,000bps		
B44	V.90 at 33,333bps		

M3	Speaker is off whenever the modem is dialling or once a connection is established	O29	Change line speed to 19,200 bps (V.32bis/V.34)
M4	Speaker is on whenever the modem is dialling or answering. The speaker will also be on during retrains or rate changes.	O30	Change line speed to 21,600 bps (V.32bis/V.34)
O0	Enter on-line state	O31	Change line speed to 24,000 bps (V.32bis/V.34)
O1	Enter on-line state & force equaliser retrain (2400bps & higher only)	O32	Change line speed to 26,400 bps (V.32bis/V.34)
O2	Retrain, not on-line (2400bps & higher speeds only)	O33	Change line speed to 28,800 bps (V.32bis/V.34)
O3	Change line speed to 4800 bps (V.32bis/V.34)	O34	Change line speed to 32,000 bps (V.32bis/V.34)
O4	Change line speed to 7200 bps (V.32bis/V.34)	O35	Change line speed to 33,600 bps (V.32bis/V.34)
O5	Change line speed to 9600 bps (V.32bis/V.34)	Q0	■ Send response codes to the screen
O6	Change line speed to 12,000 bps (V.32bis/V.34)	Q1	Do not send response codes to the screen
O7	Change line speed to 14,400 bps (V.32bis/V.34)	Q2	Modem does not return RINGING, CONNECT or NO CARRIER messages when in answer mode.
O8	Change line speed to 16,800 bps (V.34)	R0	■ Autobaud enabled
O9	Change line speed to 19,200 bps (V.34)	R1	1200 bps (locked terminal speed - no autobaud)
O10	Change line speed to 21,600 bps (V.34)	R2	2400 bps (locked terminal speed - no autobaud)
O11	Change line speed to 24,000 bps (V.34)	R4	4800 bps (locked terminal speed - no autobaud)
O12	Change line speed to 26,400 bps (V.34)	R7	7200 bps (locked terminal speed - no autobaud)
O13	Change line speed to 28,800 bps (V.34)	R9	9600 bps (locked terminal speed - no autobaud)
O14	Change line speed to 32,000 bps (V.34)	R12	12,000 bps (locked terminal speed - no autobaud)
O15	Change line speed to 33,600 bps (V.34)	R14	14,400 bps (locked terminal speed - no autobaud)
O23	Change line speed to 4800 bps (V.32bis/V.34)	R16	16,800 bps (locked terminal speed - no autobaud)
O24	Change line speed to 7200 bps (V.32bis/V.34)	R19	19,200 bps (locked terminal speed - no autobaud)
O25	Change line speed to 9600 bps (V.32bis/V.34)	R21	21,600 bps (locked terminal speed - no autobaud)
O66	Change line speed to 12,000 bps (V.32bis/V.34)	R24	24,000 bps (locked terminal speed - no autobaud)
O27	Change line speed to 14,400 bps (V.32bis/V.34)	R26	26,400 bps (locked terminal speed - no autobaud)
O28	Change line speed to 16,800 bps (V.32bis/V.34)	R28	28,800 bps (locked terminal speed - no autobaud)
		R38	38,400 bps (locked terminal speed - no autobaud)

R57	57,600 bps (locked terminal speed - no autobaud)	&B4	■ Use 10 or 11-bit format as detected by autobaud
R76	76,800 bps (locked terminal speed - no autobaud)	&C0	DCD signal is always asserted
R96	96,000 bps (locked terminal speed - no autobaud)	&C1	■ DCD signal responds to remote modem
R115	115,200 bps (locked terminal speed - no autobaud)	&C2	DCD signal always on, pulses low on disconnect
R230	230,400 bps (locked terminal speed - no autobaud)	&C3	DCD asserted during voice session
R460	460,800 bps (locked terminal speed - no autobaud)	&D0	The modem ignores the DTR signal and acts as if it is asserted (the modem assumes the computer is ready to communicate).
Sn?	Display S Register Value where n is the S Register	&D1	The modem will return to on line command state if DTR is lowered during a connection.
Sn=	Set S Register Value		
V0	Numeric response codes	&D2	■ The modem will hang up, return to local command state and disable autoanswer whilst DTR is low (is not asserted). To enable auto-answer, the DTR signal must be asserted. The computer must assert DTR before dialling or answering may commence.
V1	■ Verbal response codes		
W0	The CONNECT message reports the terminal speed		
W1	The CONNECT message reports the terminal speed		
W2	■ The CONNECT message reports the line speed		
X0	Display extended response codes (0-4) only	&D3	If DTR is lowered, the modem will hang up, return to local command state and initialise itself with the values stored in the &Y profile.
X1	Display extended response codes (0-5,10-12,30-40,60-62)		
X2	Display extended response codes (0-6,10-12,30-40,60-62)	&D4	The modem will hang up, return to local command state and go off-hook. It will remain off-hook whilst DTR is low.
X3	Display extended response codes (0-5,7,10-12,30-40,60-62)		
X4	Display extended response codes (0-7,10-12,30-40,60-62)	&F.	Total reinitialisation of modem
X5	■ Display extended response codes (0-7,10-13,30-40,60-62)	&F0	Restore Command and S Registers to Factory Defaults
X6	Display extended response codes (0-5, 7-8, 10-13, 30-40,60-62)	&F1	Select non-error correction factory defaults
Z0	Restore active configuration from stored profile 0	&F2	Select synchronous mode factory defaults
Z1	Restore active configuration from stored profile 1	&G0	■ Do not generate guard tones
Z2	Restore active configuration from stored profile 2	&G1	Generate guard tones of 550Hz
Z3	Restore active configuration from stored profile 3	&G2	Generate guard tones of 1800Hz
&B0	8 bit characters	&H0	■ Clock always present in synchronous mode
&B1	9 bit characters	&H1	Clock only appears after connection
&B2	10 bit characters	&K0	Flow control disabled
&B3	11 bit characters	&K3	■ RTS/CTS (hardware) flow control
		&K4	XON/XOFF (software) flow control
		&K5	Transparent XON/XOFF flow control

&K9	Failsafe flow control	&Y2	Select stored profile 2 on power up
&L0 ■	PSTN mode	&Y3	Select stored profile 3 on power up
&L1	Leased-line mode	&Z	Stored Phone Number
&L2	Auto leased line Originate mode	#A0	Prevent remote access
&L3	Auto leased line Answer mode	#A1	Allow remote access
&M0 ■	Asynchronous mode	#A2 ■	Allow remote access with security password
&M1	Synchronous mode with asynchronous dialling	#B0 ■	B0 = V.23 B2 = V.22
&M2	Synchronous mode with dialling invoked by the DTR signal	#B1	B0 = V.22 B2 = V.23
&M4	Asynchronous mode with dialling invoked by the DTR signal	#C0	V.25 calling tones disabled
&N0	Disable abort connection	#C1 ■	V.25 calling tones enabled
&N1 ■	Enable abort connection	#CID0	■ Caller ID disabled
&R0 ■	CTS follows RTS when the modem is on line.	#CID1	Caller ID enabled
&R1	CTS is always asserted.	#CID2	Caller ID enabled with response to host in hex format
&S0 ■	DSR signal will always be asserted	#CID3	Caller ID enabled with extended response
&S1	DSR signal asserted at the start of handshake	#D0 ■	Disable direct calling procedures
&S2	DSR signal asserted at end of handshake (before CONNECT message)	#D1	Enable direct calling procedures
&Vn	View Active Configuration Profile	#E0 ■	DES encryption disabled
&V0	View stored configuration profile 0	#E1	DES encryption enabled
&V1	View stored configuration profile 1	#E2	SuperSecure enabled (some models only)
&V2	View stored configuration profile 2	#E3	DES MultiKey
&V3	View stored configuration profile 3	#E4	DES AutoIV
&V8	View differences between active configuration and default settings of the S Registers	#H	Display Help
&Wn	Write Configuration Parameters	#I0 ■	V.22bis leased line normal
&W0	Save current configuration into profile 0	#I1	Use non-standard PSTN V.22bis over leased line
&W1	Save current configuration into profile 1	#J0	Assume V.42 capable
&W2	Save current configuration into profile 2	#J1 ■	Check V.42 compatibility
&W3	Save current configuration into profile 3	#K0	Disable MNP 10
&X0 ■	Synchronous clocks generated by Modem.	#K1 ■	Enable MNP 10
&X1	Clocks generated by computer - external clocking.	#K2	Enable MNP 10 with cellular options
&X2	Clocks generated by remote system - slave clocking.	#M0 ■	command operation
&Y0	Select stored profile 0 on power up	#M1	Asynchronous V.25bis
&Y1	Select stored profile 1 on power up	#M2	Synchronous V.25bis (HDLC framing)
		#M3	Synchronous V.25bis (Char. framing-BSC mode)
		#N0 ■	NRZ Character Encoding
		#N1	NRZI Character Encoding
		#O0 ■	Characters are ignored if the modem buffers overflow.
		#O1	Modem disconnects if the terminal buffer overflows.

#O2	Modem disconnects if the line buffer overflows.	%K1	CTS is lowered when an D command is issued and remains low until a connection is established
#O3	Modem disconnects if either buffer overflows.	%L	Display Line Signal Level 11-19 (13 default) -11dB-19dB transmit level
#Q	V.25bis Terminal Speed		
#Q0	Use last autobaud speed		
#R	Enable remote control mode	%M0 ■	Mode LEDs indicate the connection speed
#S	Display Security Menu		
#U	V.25bis Character Set	%M1	Mode LEDs indicate the line quality, V.42/MNP errors and flow control
#U0 ■	ASCII character set		
#U1	EBCDIC character set	%N0 ■	Standard Baud Rates
#V0	Command and S Register verifier off	%N1	Standard to 14400 then 20800, 31200, 41600 and 62400
#V1 ■	Command and S Register verifier on	%N2	Standard to 38400 then 51200
%B0 ■	S0=0 No AutoAnswer	%P0 ■	CONNECT message appears before DCD is asserted
%B2	S0=2 Modem answers after two rings	%P1	CONNECT message appears after to DCD is asserted
%C0	Compression disabled	%Q	Display line signal quality
%C1	MNP 5 compression enabled	%R0 ■	&R command determines the state of CTS
%C2	V.42bis data compression enabled		
%C3 ■	V.42bis data compression enabled with fallback to MNP 5	%R1	CTS always follows RTS (both in on-line state and local command state)
%D0 ■	No disconnect delay		
%E0	Auto EQM Retrain OFF	%R2	V.25bis mode: CTS on when ready to accept a command
%E1	Auto EQM Retrain ON		
%E2 ■	V34/V32 auto rate change	%S0 ■	DSR is not overridden
%F0	A & B switches control V.25bis function	%S1	DSR mimics the state of the DTR signal (only reset by &F.)
%F1 ■	Switch A forces DTR on, Switch B forces DSR high	%T0 ■	DCD always follows the state of the carrier from the remote modem
%H0 ■	Use the B setting for initial MNP 10 connection speed. The B setting is the maximum speed.	%T1	DCD is always high (only reset by &F.)
%H1	Initial connection speed is made at 1200 bps (V.22). The maximum speed is defined by the B setting.	%U0 ■	Standard error correction response codes
%H2	Initial connection made at 4800 bps (V.32). The maximum speed is limited by the B setting.	%U1	V.42 response codes sent when a V.42 error corrected connection is established
%H3	Initial connection made at 9600 bps (V.32). The maximum speed is limited by the B setting.	%U2	Append /LAP-M or/REL (2,4,10) or /MNP-5 or /V.42bis or /DES messages to the CONNECT message when established
%H9	Use the B setting for the initial connection speed, but do not upshift until the connection is established. (NetComm modems only).	%W0 ■	Welcome Message disabled
		%W1	Welcome Message enabled
%K0 ■	CTS operates normally	\A0	64 character MNP block size
		\A1	128 character MNP block size
		\A2	192 character MNP block size
		\A3 ■	256 character MNP block size

\Bn	Generate Break (default 3 - 0.3 seconds)	*K	Select Primary DES KEY from Stored Keys
\J0 ■	Fallback Constant Speed mode	*R0 ■	V.13 Remote RTS mode off
\J1	Fallback to Variable Speed mode	*R1	V.13 Remote RTS mode on
\K	Break Control	*S	Change Current User Password
\N	Asynchronous Operating Mode	*T0 ■	Disable auto call redial
\N0	Constant speed mode	*T1	Enable auto call redial
\N1	Variable speed mode	*V0 ■	Maximum 8,192 V.42bis dictionary entries
\N2	MNP Reliable mode	*V1	Maximum 2,048 V.42bis dictionary entries
\N3 ■	V.42/MNP auto-reliable mode	*W	Welcome Message Text
\N4	V.42 reliable mode	*Y0 ■	Escape Sequence Detection in Sync mode disabled
\N5	V.42 auto-reliable mode	*Y1	Escape Sequence Detection in Sync mode enabled
\N6	V.42/MNP reliable mode with fallback to MNP reliable mode, disconnect if MNP not supported by remote modem.	+ICF	Character Framing and Parity Select
\N7	MNP auto-reliable mode	+MS	Select Modulation
\Q0	Flow control disabled	<mod>	Mod Possible Rates (bps)
\Q1	XON/XOFF flow control	0	V.21 300
\Q2	CTS flow control #1	1	V.22 1200
\Q3	CTS/RTS flow control #1	2	V.22bis 2400 or 1200
\Q4	Modem XON/XOFF flow control	3	V.23 1200
\Q5	CTS flow control #2	9	V.32 9600 or 4800
\Q6	CTS/RTS flow control #2	10	V.32bis 14400, 12000, 9600, 7200, or 4800
\S	Display Active Configuration	11	V.34 33600, 31200, 28800, 26400, 24000, 21600, 19200, 16800, 14400, 12000, 9600, 7200, 4800, or 2400
\Tn	Inactivity Timer (Data Mode)	12 ■	V.90 56000, 54667, 53333, 52000, 50667, 49333, 48000, 46667, 44000, 42667, 41333, 40000, 38667, 37333, 36000, 34667, 33333, 32000, 30667, 29333, 28000
\T0 ■	Disable inactivity timer	64	Bell 103 300
\T35	Set inactivity timer to 35 minutes	69	Bell 212 1200
\V0 ■	Disable error correction response codes	-Q0	Disable MNP10 fallback to V.22bis or V.22
\V1	Enable error correction response codes	-Q1 ■	Enable MNP10 fallback to V.22bis or V.22 with MNP10
\V8	Enable error correction response codes plus details of the error correction and data compression negotiated with the remote modem is displayed immediately before the CONNECT message.	-DATE	Time & Date
\V9	Enable error correction response codes plus details of the error correction and data compression negotiated with the remote modem and diagnostic information displayed immediately before the CONNECT message.	-LOG	Call Log
\X0 ■	Remove received XON/XOFF characters from received data	:E0	Disable the V.32 compromise equaliser
\X1	Pass through received XON/XOFF characters		

:E1	■	Enable the V.32 compromise equaliser
CIC		Connect Incoming Call
CIC		Accept an incoming call after the DIC command has been issued
CRN		Dial
CRS		Dial Stored Number
DIC		Disregard Incoming Call
PRN		Stored Phone Number
RST		Reset the modem and restore the saved configuration profile

Distinctive Ring Commands

-SDR=n,x where n=0 to 7, default=0,
x=0 Disable Distinctive Ring response suffix;
x=1 Enable Distinctive Ring response suffix
(default)

Dial Modifiers

D		Dial
,		Pause
;		Return to local command state
R		Reverse mode
@		Wait for quiet answer
J		Initiate MNP 10 at 1200 bps
M		Initiate MNP 10 at 4800 bps
K		MNP 10 cellular option
L		Last number redial
F or ^		Disable calling tones
!		Hook flash
S=n		Dial stored phone number n
W		Wait for dial tone

S Registers

Reg	Function	Default	Range
0	Rings Before Answer	0	0-255
1	Ring Count	0	0-255
2	Escape Sequence Character	43 (the + character)	1-255
3	Carriage Return Character	13	0-127
4	Line Feed Character	10	0-127
5	Backspace Character	8	0-127
6	Dial Tone Wait Time	4	4-7
7	Wait for Carrier	30	1-60
8	Pause Dial Modifier Delay	4	1-7
9	Carrier Detect Response Time	6	1-255
10	Lost Carrier/Hang Up Delay	18	1-255
11	DTMF Tone Timing	95	70-254
12	Escape Sequence Guard Time	50	3-255
16	Test in Progress (read only)	0	0-8
18	Test Timer	0	0-255
25	DTR Loss Detection	5	0-255
26	RTS/CTS Delay	0	0-255
27	Delay Before Dial	0	0-255
29	Hook Flash Duration	50	10-100
30	Inactivity Timer	0	0-255
33	EQM Threshold Value	3	0-255
38	Disconnect Delay	0	0-255
42	Modem Disconnect Reason		
43	Break Sequence Length	15	1-255
45	V.22bis EQM Threshold Value	98	0-255
57	DTR High Detection	0	0-255
62	V.42 Detection Timer	75 (0.75 second)	0-255
66	Remote Access Guard Time	10	1-255
67	Remote Access Character	42 (the * character)	1-125
69	Command Line Time-out	60	0-255
71	Ignore Incoming Call	0	0-30
74	Disconnect Reason for Prev. Call		
80	Flow Control High Water Mark	15 (75% of the buffer)	1-19
81	Flow Control Low Water Mark		1-19
82	Failsafe Flow Control Overrun	60	1-255
95	Extended Response Codes		0-255
96	Help Page Width	80	1-255
97	Help Page Length	24	1-255
105	Voice 'Dead Man' Timer	30	
S30	'Dead Man' Timer (voice mode)		0-255
122	AutoRateChange	55	30-100
123	AutoRateChange	16	0-20
124	Duration EQM	30	1-255

User Guide

The AT Commands

The AT commands are a group of special commands recognised by your modem. These commands derive their name from the letters AT, which are used to prefix commands. Before continuing:

- Run your communications software and enter local mode (or terminal mode) at 38,400 bps. Refer to your communication software manual for details.

The Attention Code

An AT (sometimes known as the ATtention code) usually precedes all commands being sent to the modem. It is used to gain the modem's attention, informing it that you are about to send a command. For example:

- Type the command: AT19 <E>

Your modem's firmware identity message will appear on your computer screen. If you type I9 only, your modem will not respond. If you type AT19, your modem will report an ERROR.

You may enter the attention code in all upper case, or all lower case letters, such as: AT or at

Multiple Commands

You may place multiple modem commands after an AT provided the total number of characters does not exceed 80. For example, a valid command to display the modem's firmware identity twice is:

- Type in the command: AT19I9 <E>

An AT is not required in front of the second I9 command. You only need one attention code for each command line. To make this command more readable, you can add spaces between the two commands:

- Type in the command: AT I9 I9 <E>

The modem will execute the command as if the spaces are not there.

The Escape Sequence

When you issue commands to the modem all dialogue is occurring between your computer and the modem. This situation is known as local command state.

When you connect to a remote system, dialogue will be occurring between your computer and the remote system. This is known as on-line state. Because the modem assumes, after it enters on-line state, all the data you send it is to be sent on to the remote modem, it ignores any AT commands you give it while in on-line state.

To force the modem to return to local command state, enter an escape sequence. An escape sequence consists of a one second delay, three + characters typed rapidly and another one second delay. For example:

- Type: AT&T1 <E>

The modem will enter on-line state (this command actually causes the modem to enter test mode, but is equivalent to entering on-line state).

Now try to view the modem's firmware identity code:

- Type: ATI9 <E>

Your command will be ignored. This is because the modem assumes you are typing characters to be sent to a remote system.

Now enter an escape sequence. Do not type any characters for one second, type +++ rapidly and wait another full second. The modem will respond with an OK message to indicate it has returned to local command state. You will be able to view the modem's firmware identity.

Before continuing:

- Type: AT&T0 <E>

This command is used to halt the test.

The Repeat Command

The repeat command is used to re-execute the last command issued to the modem. Issue the ATI9 command and the modem's firmware identity code will be displayed on the screen.

- Type: A/

The identity code will appear again.

You don't have to enter AT before the repeat command. You also do not have to press the ENTER key. This is the only modem command which does not require you to enter AT before it, and one of the few commands which does not require you to press the ENTER key. The A/ command is intended primarily for re-dialling a telephone number that was previously engaged.

The Help Command

Your modem will display information about the AT commands it supports if you type a question mark (?) in your AT command.

For example:

- Type: AT? <E>

Your modem will display a list of all the commands it supports.

- Type: AT?DTR <E>

Your modem will display a summary of commands involving DTR.

- Type: AT?\N3%C2&D2 <E>

Your modem will display summaries of the \N, %C and &D commands.

Response Codes

Your modem is capable of telling you, with on screen messages, what it is doing. These messages are known response codes or result codes, and you will see them from time to time.

For example:

After a command is successfully executed, the response is: OK After a connection is established, the response is: CONNECT A complete list of Response Codes can be found in Appendix A.

Dialling

The AT commands may be used to initiate dialling with the modem. Your modem does not require a telephone handset to be connected to it in order to dial.

The D (Dial) command is used to initiate a telephone call. The most basic form of the D command is:

ATD number where the number is the telephone number you are dialling.

Having set your communications software for 38,400 bps operation:

- Type: ATD01234 <E>

Your modem will begin to dial.

☞ If your modem receives a character from your computer while dialling is being performed, it will immediately hang up, send a NO CARRIER response message to the computer and return to local command state. After a few seconds the message CONNECT will appear on the screen.

If a NO CARRIER message appears, then your modem has not been able to make a connection. Check your communications software is set for 38,400 bps operation and your modem is correctly connected to your computer and the telephone line. You may use the A/ command to redial.

To hang up the modem, enter an escape sequence (+++). The modem will respond with an OK message.

- Type: ATH <E>

The modem will hang up.

☞ Your computer must assert the DTR signal before dialling can start. Usually, this is done by your communications software. If the DTR signal is lowered at any stage of communications, after the &D2 command has been issued, the modem will hang up and return to local command state. Interpretation of the DTR signal may be changed with the &D command.

Dial Modifiers

Dial modifiers are characters that can be included in a phone number to make the modem perform special tasks while dialling. For example, not all modem users will be using a dedicated telephone line. Some users will have their modems connected to PABXs. To allow users of PABXs to operate their modems successfully, dial modifiers are supported on the modem.

Most PABXs require you to dial 0 or 9 (in order to obtain an outside line) and wait for a dial tone before dialling the actual phone number. Using dial modifiers, you can successfully dial the phone number 12345 through a PABX using the command:

```
ATD0,12345
```

The , (comma) dial modifier causes the modem to pause for a short time after dialling 0. This allows most PABXs sufficient time to obtain a line before dialling.

The factory default delay for the , modifier is two seconds. You may change the length of this delay if necessary. Its length is determined by the value in S Register 8.

Another method of making the modem wait for a dial tone is to include the W dial modifier. The W modifier causes the modem to examine the phone line to ensure a dial tone has been applied before dialling starts:

```
ATD0W12345
```

If the modem cannot detect a dial tone within the time specified by S Register 7, the modem will return to local command state and send a NO DIALTONE message to the computer (if either the X2, X4, or X5 commands have been issued).

Due to differences with some older telephone exchanges, dial tone detection may not be possible with your modem. Your modem will only recognise dial tones between 200 Hz and 600 Hz.

If your telephone line supports tone dialling then a useful dial modifier is the T modifier. Inserting a T modifier before the number you are dialling causes the modem to tone dial that number. For example:

```
ATDT12345
```

This will cause the modem to dial the phone number 12345.

These modifiers may be placed at any point in the number you are dialling and they may be intermingled in the same number. More information about dial modifiers can be found in the Command Descriptions chapter of this guide.

Hanging Up

The H command is used to hang up the modem. After you have finished communicating with another computer you must hang up your modem. Similarly, you must hang up the phone after calling another person. If you don't, no one will be able to call you and you may even be charged for the length of time the phone was off the hook.

To hang up your modem:

- Type: ATH <E>

The modem will return an OK response message.

Stored Number Dialling

Your modem has the ability to store phone numbers which may be dialled at a later time. This is similar to 'abbreviated dialling', which may be supported by your telephone.

To store a phone number use the &Z command. For example:

- Type: AT&Z1=012345 <E>

The phone number 012345 will be stored as phone number one. The S dial modifier is used to dial a phone number that has been stored in your modem:

- Type: ATDS=1 <E>

The modem will dial stored phone number one.

☞ ***Do not include an AT, D command, or S dial modifier in the stored phone number. If synchronous mode 2 is being used, the ; (semi-colon) dial modifier should not be included.***

Answering Calls

As well as dialling other modems, your modem can answer calls made to it by other modems.

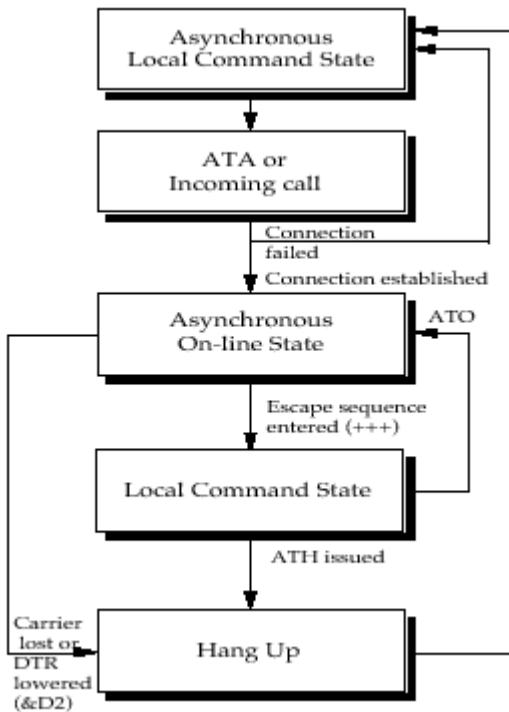

Your modem is pre-configured to automatically answer any incoming call, provided it is switched on, is in local command state, DTR is high and is not performing a test. If you receive a call on the phone line the modem is connected to, it will answer the call and attempt to connect to the calling modem.

S Register 0 contains the number of rings the modem will wait before answering a call. If a value of 4 is placed in S Register 0, the modem will answer an incoming call immediately after the fourth ring. If a 0 value is placed in S Register 0, the modem will not answer an incoming call.

The communications standard used by the modem in its attempt to connect with a calling modem is determined by the B command.

If the phone does ring, and verbal response codes are selected (ATV1), the modem will issue RING messages until the number of rings stored in S Register 0 is reached. The modem will then go on line, transmit an answer tone, and attempt to connect to the calling modem using the communications standard selected by the B command.

By default the modem is set to B0. B0 is the auto range setting. This should connect to virtually all communications standards and normally you do not have to alter this. As soon as a connection is established, the modem will send a CONNECT message to your computer and enter on-line state in answer mode.

Selecting Speeds

The following section describes how to select line and terminal speeds for your modem.

Terminal Speeds

Your modem has the ability to communicate with your computer at various speeds. The modem offers two speed modes: variable speed mode and constant speed mode.

Constant speed mode forces your modem to maintain the terminal speed that was selected when you dialled another modem, even if the connection speed made with the other modem does not match the terminal speed of your modem and computer.

For example, if your modem connected to another modem at 2400 bps and its terminal speed is 9600 bps, the modem will maintain its terminal speed at 9600 bps. Because of this, you must select flow control between the modem and your computer. To select constant speed mode:

- Type: `AT\N0 <E>`

For more details on constant speed mode and flow controls, see the Command Descriptions chapter for a discussion of the `\N`, `B` and `&K` commands. + Some computers cannot cope with receiving data at speeds above 19,200 bps. If you wish to run at high speeds, you should install a COM port that has a 16550 chip in place of your regular COM port. The 16550 chip allows your computer to accept data at very high speeds when used with suitable drivers and software.

Variable speed mode allows your modem to automatically adjust its terminal speed to match the line speed. For example, if your modem connects to another modem at 4800 bps and its terminal speed is 9600 bps, the modem will automatically change its terminal speed to 4800 bps (and, thus, you or your software would have to change the speed of your computer to 4800 bps).

If you have variable speed mode and `B0`, `B1`, `B2` or `B9` selected, the modem will attempt to connect at a speed to match the terminal speed.

At 300 bps, select `B0` or `B2` for V.21, or `B1` for Bell 103. At 1200 bps, select `B0` for V.23, `B1` for Bell 212A, or `B2` for V.22.

Variable speed mode may be selected by:

- Type: `AT\N1 <E>`

For more details about the variable speed mode, see the `\N` and `B` commands in the Command Descriptions chapter of this guide.

Setting Terminal Speeds

Your modem can sense the terminal speed of the computer and automatically change its terminal speed to match. This is known as ‘auto bauding’, and is done each time an AT command is issued to the modem.

Your modem can auto baud at 300 bps through 9600 bps, 14,400 bps, 19,200 bps, 38,400 bps, 57,600 bps and 115,200 bps.

The R command may also be used to disable autobauding and lock the terminal speed. Refer to the R command for available speeds.

Line Speeds

Connection speeds higher than 33600bps can only be obtained by calling an Internet Service Provider (ISP) or Central Site which supports the V90 protocol. The speeds at which you will be able to connect also depend on the quality of the telephone line used when making the connection.

The B command determines the speed at which your modem connects to another modem. The listed B commands are provided by your modem.

In most cases you should select B0, as this setting attempts to connect at any speed supported by the modem.

V.90 & V.34 Typical Settings

Here are some example settings that may be relevant to the way in which you wish to operate your modem.

Example 1 - Dialling or answering other modems at the highest speed.

B Command Setting: B0

Terminal Speed: 115,200 bps

Flow Control: On (&K3 for RTS/CTS flow control)

Use this arrangement when dialling online information services or bulletin boards. With these settings, your modem will attempt to connect at any speed from 56,000 bps to 1200 bps. These are the default settings of your modem.

If you wish your modem to answer incoming calls, use these settings. This will allow your modem to connect at any speed between 56,000 bps and 300 bps. If you are using a software program that controls the answering of your modem (as some bulletin board systems do) you may need to issue an ATSO=0 command to disable auto-answering, otherwise issue ATSO=2 to make the modem answer calls after two rings (the default setting).

Example 2 - Dialling other modems at 19,200 bps (V.34 or V.FC)

B Command Setting: B18
Terminal Speed: 57,600 bps
Flow Control: On (&K3 for RTS/CTS flow control)

You may use this arrangement when dialling online information services or bulletin boards. With these settings, your modem will attempt to connect at 19,200 bps, but may change the line speed if the quality of the telephone line does not support this speed.

Example 3 - Dialling information services at 1200 bps (or V.22)

B Command Setting: B6
Terminal Speed: 38400 bps
Flow Control: On (&K3 for RTS/CTS flow control)

Some information services do not provide connections higher than 1200 bps; these settings allow you to connect to such services. Problems may also occur if error correction is switched on; if the information service does not support V.42 or MNP, issue the \N0 command before dialling.

V.32bis Modem Typical Settings

Here are some example settings that may be relevant to the way in which you wish to operate your modem with V.32bis.

Example 1 - Dialling other modems at the highest possible V.32bis speed

B Command Setting: B0
Terminal Speed: 38,400 bps
Flow Control: On (&K3 for RTS/CTS flow control)

Use this arrangement when dialling online information services or bulletin boards. With these settings, your modem will attempt to connect at any speed from 14,400 bps to 1200 bps. These are the default settings of your modem.

Example 2 - Dialling other modems at 14,400 bps (or V.32bis)

B Command Setting: B15
Terminal Speed: 38,400 bps
Flow Control: On (&K3 for RTS/CTS flow control)

You may use this arrangement when dialling online information services or bulletin boards. With these settings, your modem will attempt to connect at any speed from 14,400 bps to 1200 bps. Because V.32bis operation is not suitable on poor-quality telephone lines, we recommend you use these settings with caution; if you have trouble connecting to another modem using V.32bis, revert to the settings shown in Example 1.

Example 3 - Answering incoming calls

B Command Setting: B9
Terminal Speed: 38,400 bps
Flow Control: On (&K3 for RTS/CTS flow control)

If you wish your modem to answer incoming calls, use these settings. This will allow your modem to connect at any speed between 14,400 bps and 300 bps. If you are using a software program that controls the answering of your modem (as some bulletin board systems do) you may need to issue an ATSO=0 command to disable auto-answering, otherwise issue ATSO=2 to make the modem answer calls after two rings (the default setting).

Flow Control

Your modem supports RTS/CTS, XON/XOFF and Transparent XON/OFF flow control. Flow control ensures that data is not lost between your computer and your modem. Flow control will be ignored when your modem is configured for variable speed mode (AT\N1) or is in local command state.

RTS/CTS Flow Control

RTS/CTS flow control takes place when the modem and computer manipulate the CTS (Clear To Send) and RTS (Request To Send) signals to stop and start data flow. This form of flow control is recommended if supported by your computer and communications software, as it does not interfere with file transfer protocols.

☞ ***In order for flow control to operate correctly between your computer and the modem, the appropriate form of flow control must be selected with your communications software. See your communications software manual for details. You must also have a modem cable that connects the RTS and CTS signals of your modem to your computer.***

RTS/CTS flow control is selected with the &K3 command.

XON/XOFF Flow Control

XON/XOFF flow control takes place when the modem and communications software transmit XON and XOFF characters to start and stop data flow. This form of flow control is only recommended when your computer or communications software does not support RTS/CTS flow control. The ASCII values of the XON/XOFF characters are 17 (DC1) and 19 (DC3) respectively.

XON/XOFF flow control is selected with the &K4 command.

☞ ***XON/XOFF flow control should not be used with the XModem, YModem or SEAlink file transfer protocols.***

Transparent XON/XOFF Flow Control

Transparent XON/XOFF flow control is identical to normal XON/XOFF flow control except the XON and XOFF characters which are part of the normal data stream are encoded to allow flow control with file transfer protocols such as XModem. The ASCII values of the XON and XOFF characters are 17 (DC1) and 19 (DC3) respectively.

Transparent XON/XOFF flow control is selected by issuing the &K5 command.

Failsafe Flow Control

Failsafe flow control is designed specifically for UNIX computers running the UUCP file transfer protocol. This form of flow control only affects data being transmitted from the computer to the modem.

When the modem's data buffer approaches maximum capacity, the modem will lower the CTS signal. If the computer does not pause the transmission of data within a few character durations of CTS going low, the modem will send an XOFF to the computer.

When the modem is ready to accept more data from the computer it will assess CTS. If an XOFF was sent to pause transmission, the modem will also send an XON character.

☛ ***Failsafe flow control only affects data being transmitted from the computer to the modem. Flow control is not supported for data being transmitted by the modem to the computer. Failsafe flow control is selected by issuing the &K9 command.***

The Inactivity Timer

Your modem supports an inactivity timer. When your modem is on line, if it does not communicate with either the remote modem or your computer for a specified length of time, it will hang up and return to local command state.

The ATVT command specifies the number of minutes the modem stays on line when no activity is occurring. The timer may be set from 1 to 255 minutes.

For example:

```
ATVT5
```

This allows the modem to be inactive in on-line state for five minutes before hanging up the default time is 0 minutes the timer is disabled. The inactivity timer is only available when MNP or constant speed mode is selected. It is ignored in variable speed mode.

The Command Timer

If you do not complete an AT command within 60 seconds (that is, type the command and press ENTER), the command will be discarded and an error message will appear. The length of time is controlled by S Register 69 and can be turned off by setting S Register 69 to 0.

Configuring the Modem

Your modem allows you to tailor its operating parameters to suit your own particular requirements.

The modem uses S Registers to alter the configuration profile. Each S Register contains a decimal value to represent a time delay, an ASCII character or the number of times the phone should ring before the modem answers it (the interpretation of each value differs with each S Register).

The modem allows you to save the contents of the S Registers and certain communication settings under a profile number (0-3) in non-volatile memory (&Wn). This means the entire configuration profile will be retained after you have switched your modem off.

The modem also has factory default settings stored internally, allowing you to change the communication settings and S Register values and then recall the configuration profile stored in your modem when you originally purchased it.

The factory defaults have been selected so most users will be able to make immediate use of their modem, without the need to change any S Register values.

You may restore your modem to its factory defaults at any time:

- Type: AT&F.

There is no need to press ENTER with this command.

Viewing the Current Configuration

The &V command allows you to view the current configuration of your modem. When you issue the &V command, your modem sends a list of the current AT command and S Register settings to your computer.

Error Correction

Error Correction Protocols

This section examines the error correction and data compression features of your modem. The modem offers both V.42 (LAP-M) and MNP® (Microcom Networking Protocol™) error correction protocols. These protocols allow data errors to be detected by the receiving modem, provide flow control between remote systems and improve the overall throughput of data transfers.

Your modem also supports V.42bis and MNP5 data compression. V.42bis is a high performance data compression enabling you to speed up, theoretically by four times, data throughput on some types of data. MNP5 allows you to speed up data throughput by up to two times on some types of data.

☛ ***Aust Modems: Before dialling into an AUSTPAC V.22 or V.22bis***

service, error correction must be disabled using the \N0 command.

Two types of error correction protocols are offered by your modem; V.42 (or LAP-M) and MNP.

☛ ***Error correction protocols are not available when a V.23 connection is established.***

V.42 is an international standard for error correction between modems. V.42 ensures any errors introduced into your data by telephone line noise is automatically corrected before it is received by your computer. Because V.42 is a ITU standard, it has become very popular in modems all over the world.

V.42 also supports a fallback mode to MNP, in order to remain compatible with modems introduced prior to V.42.

Before V.42 existed, MNP was the de-facto standard for modem error correction. MNP classes 2-4 are supported by your modem for error-correction (an additional class of MNP is supported for data compression). Because MNP is a far less complex error correction protocol than V.42, it out-performs V.42.

The section titled “Which Error Correction Do I Use?” provides more information about the performance and compatibility merits of V.42 and MNP.

The \N command is used to select the type of error correction used by your modem.

Data Compression

Two forms of data compression are supported by your modem; V.42bis and MNP 5. V.42bis is based on the Lempel-Ziv compression technique (similar to the techniques used by PC compression programs) and can work with both V.42 and MNP. V.42bis is very good at compressing data that has repetitions of sequences of characters. For example, in an English sentence there are usually repetitions of 'ions' or 'ings' or 'ere'; V.42bis works by creating a library of these repetitions and substituting small symbols for them. V.42bis is also able to switch off data compression if the type of data being sent is unsuitable for compression.

MNP 5 is MNP's stable-mate; it uses 'run length encoding' and a variation of the Huffman compression technique. It can double your data throughput on some types of data and MNP 5 works best when there are lots of characters repeated in sequence or a particular character repeated. For example, if you have a file which contained 50 zero characters in sequence MNP 5 will do a good job of compressing them (in some instances, better than V.42bis) – this is run length encoding. Or, if you had a text file where every second character was an 'i' and the other characters were random, MNP 5 would again outperform V.42bis (in this instance, Huffman coding provides superior compression). However, MNP 5 does not employ V.42bis' automatic switching techniques.

If the data you are sending is not suitable for compression (for example, an application file or a graphics file), it can actually take longer to send than if data compression was not being used.

For this reason, it is best to use V.42bis whenever possible. If the modem you connect to does not support V.42bis, it is best not to use MNP 5 unless you are only transferring plain text information. If possible, use one of the many popular data compression programs available for computers to compress applications, graphics and other non-text files.

The %C command is used to select the type of data correction used by your modem.

Reliable Mode

Reliable mode allows the modem to use error correction to connect to another modem. If the modem you attempt to connect to does not support a compatible method of error correction, your modem will hang up and return a NO CARRIER message.

Use \N6 to select V.42/MNP reliable mode, \N4 to select V.42-only reliable mode or \N2 to select MNP-only reliable mode.

Auto-Reliable Mode

Auto-reliable mode allows your modem to use V.42 or MNP if the remote modem also supports these. If the remote modem does not support a compatible type of error correction, your modem will fallback to either constant speed or variable speed mode.

☛ **The \J command determines whether your modem falls back to constant speed or variable speed mode.**

\N3 selects V.42/MNP auto-reliable mode and \N5 selects V.42-only autoreliable mode.

Your modem supports special CONNECT messages for connections made with either reliable or auto-reliable modes. When the AT\V1 command is issued and your modem connects in either reliable or auto-reliable mode, a response message will be sent to your computer.

When the AT\V0 command is issued (default), your modem will generate standard CONNECT messages for both normal and error-corrected connections. If the X0 command has been issued, the CONNECT/REL will be the only 'error correction' response code generated, regardless of the connection speed.

✦ ***Issue the %U1 command if you want your modem to issue CONNECT/ LAP-M response codes when a V.42 connection is established. The \V8 command will display details of the error correction and data compression negotiated with the remote modem. This information is displayed immediately before the CONNECT message.***

The \V9 command will display details of the error correction and data compression negotiated with the remote modem as well as diagnostic information. This information is displayed immediately before the CONNECT message.

Improving Performance with MNP 10

MNP 10 is neither an error correction or data compression technique. MNP 10 works in conjunction with error correction and data compression to improve the performance of your modem when operating with poor or varying quality telephone lines (as sometimes found with overseas or cellular telephone connections).

With MNP 10 operating, your modem can automatically resize the MNP packets, depending upon the line quality. When an MNP connection is established, data is transferred in small 'chunks' known as packets. When the line quality drops, MNP 10 reduces the size of packets being transferred in order to maintain data throughput. MNP 10 will increase the packet size to take advantage of improved line quality.

If the line quality becomes very good or very bad, MNP 10 can automatically step between line speeds. MNP 10 attempts to use the highest speed applicable to the quality of the telephone connection. If the telephone line quality drops while you are connected to another MNP 10 modem, thus introducing errors into your data, and the smallest packet size is being used, the modems will 'step-down' in speed until the error rate become acceptable.

Similarly, if the line quality improves and the modems are using the largest packet sizes, the modems will 'step-up' in speed until the best compromise of error rate and line speed is found.

MNP 10 will also make multiple attempts at establishing an error-corrected connection to another modem (more so than MNP 2-4). This gives you a better chance of making a connection when operating with poor line quality.

If the telephone line drops out, MNP 10 will attempt to reconnect up to the maximum time permitted by your country's telecommunications rules. Thus, if there is a short line drop-out, MNP 10 will provide minimal interruption whereas other modems will disconnect entirely.

MNP is the only type of error correction allowed with MNP 10 and is only available when connected to another modem that supports MNP 10. The #K command is used to select MNP 10.

Speed Changes

Although MNP 10 is able to cope with bad telephone connections, your modem must be able to first make a connection with another modem before it can make use of MNP 10. For this reason you may wish to use the AT%H1 command to force your modem to connect at 1200 bps and then 'upshift'. Most telephone lines will cope with V.32 or V.32bis connections, however connecting at 1200 bps will ensure you make a connection. You may also use the J dial modifier to force your modem to make the initial MNP 10 connection at 1200 bps.

When MNP 10 changes line speed (either up or down) there will be a slight interruption to your communications. For this reason you should always use flow control to ensure data is not lost when MNP 10 changes line speed.

If you wish to establish the connection prior to MNP 10 upshifting or downshifting, issue the %H9 command. This allows you to use the connection before MNP 10 attempts to change the connection speed.

Cellular Modem Users

If you are making modem calls with a cellular phone, issue the AT#K2 command. This tells MNP 10 to try even harder to maintain the connection if your cellular call momentarily drops out.

With such a choice, you may be wondering which combination you should be using. The table below shows the relative performance of each combination of error correction and data compression.

If you are connecting to various makes and models of modems, V.42/V.42bis auto-reliable mode is probably the best alternative (AT\N3%C2). V.42/ V.42bis auto-reliable mode will also connect to another modem that supports MNP with V.42bis data compression. For overseas or cellular connections, use MNP 10 if possible (AT\N3%C2#K1).

Increasing Data Throughput with Error Correction & Data Compression

Data throughput refers to the amount of data being transferred. Error correction and data compression allow you to increase data throughput in comparison to if error correction and data compression were not selected. To allow error correction and data compression to operate with the highest possible throughput, the terminal speed of your modem (the speed it communicates with your computer) must be higher than the line speed (the speed it communicates with the remote modem).

The best way to operate with error correction and data compression is to set your modem for a constant speed of 57,600 bps, 115,200 bps or higher (set the terminal speed of your computer to 57,600 bps, 115,200 bps or higher and issue the command AT+N3 to the modem) with flow control. RTS/CTS flow control is the preferred form of flow control. Your communications software must also be set to use the same type of flow control.

☞ ***Some computers cannot cope with receiving data at speeds above 19,200 bps. If you wish to run at high speeds, you should install a COM port that has a 16550 chip in place of your regular COM port. The 16550 chip allows your computer to accept data at very high speeds.***

Security & Encryption

Your modem has many sophisticated security features. Your modem limits caller access by means of user names and passwords. User names and passwords are stored in the modem's non-volatile memory. With each user name and password a modem command of up to 30 characters may be specified. This allows the implementation of callback to users.

Callback is where the modem rings a specified phone number. Even if an unauthorised caller manages to break the modem's security, that caller must be connected to the phone number specified in the remote modem's database. Also discussed in this section is the topic of DES (Data Encryption Standard) encryption, which allows you to encrypt data being passed to a remote modem.

The Security Menu

All additions and changes to your modem's user and password lists are performed through the Security Menu. This menu is displayed when you use the #S command.

- Type: AT#S <E>

A prompt will appear: Enter Security Password:

When you first receive your modem, all passwords will be set as a single Carriage Return (ENTER).

- Press the ENTER key

The Security Menu will be displayed:

```
SECURITY MENU
Q = Quit                      1 = List Users
2 = Add or Change Users      3 = Delete All Users
4 = View Access Record      5 = Reset Access Record
6 = Security Off            7 = Security On
8 = Change Security Password 9 = Encryption Controls
A = Stored Phone Numbers Displayed B = Supressed
C = Set Password Expiry Days E = Minimum Password Length
D = Download Security file to host U = Upload Security file from host
L = DES Params/Keys & Call-Log LOCK F = FREE Encryption and Dial Enable
K = OutDial Disable          M = Dial Stored Phone Numbers Only
N = Change Database Local/Remote O = Clear Statistics
P = SNMP Database Access En/Disable Z = Zero All Accounts
R = 64bit DES/40bit DES      T = Caller Exclude Unless Listed En/Dis

Access Security: OFF Security Database and Security Mode: FREE
Stored Phone Numbers: DISPLAYED OutDial: ENABLED
Caller ID DISABLED DES: 64bit
Enter Security Function : ...
```

Entering a Security Password

You may choose to have a dedicated security password, thus changing the password assigned for the first security user. To enter a new security password:

- Select Option 8 from the Security Menu <E>
You will be prompted to enter a new security password. Your modem is case insensitive. Up to 8 characters may be used, including spaces.
When you enter your password, each character will appear on the screen as a # character.
- Type in your new password <E>
You will be prompted to re-enter the new security password.
- Type in your new password again <E>
Your new password will be stored in your modem's non-volatile memory.

Adding and Changing Users

Your modem allows you to add new users and change existing users. Selecting option 2 on the Security Menu will result in a prompt: Enter Name:

To add a new user:

- Type in the name of the new user <E>
User names must not be longer than 30 characters. They are NOT case sensitive.

To change an existing user:

- Type in the name of the user you wish to change <E>
You will be prompted to enter a new name.
- Type in the new name <E>
- If the user is found you will be given the option to change the password, delete the user or zero their access counters.
If you are adding a new user or changing a user, you will be prompted for a new Password (maximum characters = 15).
You then will be prompted for 'Options' after the password has been entered.
You may key S or E or both, if you do not want either option key ENTER.
- S Specifies that the user is a supervisor and has full remote access rights to the remote modem.
- If you key **** you will be able to issue almost all AT commands on the remote modem and access the full security database if you have the global security password. (See remote access)
- E Your user password does not expire.
- This would be for automated systems that cannot respond to prompts to enter a new password when it expires The modem will now prompt you to enter a modem command. Modem commands consist of up to 30 characters and may include spaces. When you enter a new command, the previous command will be overwritten.

- ☞ **Do not include an Attention Code (AT) with your command. Your modem automatically places an AT at the start of this command when it is executed.**

If you do not want to specify a modem command or want to leave the current command as it is:

- Press ENTER

If you want to remove the existing command but do not wish to replace it with another command:

- Press the Spacebar <E>

See details on Callback Security later in this section for more information about using commands with your user names.

If you do not enter a command you will be given the option of entering a SuperSecure DES Key for the user. To use this feature refer to the 'SuperSecure Advanced Security Mode' or else press ENTER to go on to the next user.

Removing Users

Your modem allows you to remove individual users or all the users currently stored in your modem. To remove an individual user:

- Select option 2 from the Security Menu You will be prompted to enter a new user name.
- Type in the name of the user you wish to delete <E>

If the user is found, select the 'D' option to delete.

To delete all the users stored in your modem:

- Select option 3 from the Security Menu

You will be prompted to confirm that you wish to remove all user names, passwords and commands

- Press Y <E>

Listing Existing Users

To list all user names, and commands.

- Select option 1 from the Security Menu <E>

Your modem will list the user names.

Passwords are never displayed.

- ☞ **Your computer must be capable of displaying at least 80 characters per line for the user list to be displayed in its correct format.**

The Access Record

Selecting option 4 and option 5 from the Security Menu allows you to view and change the access records. Your modem keeps a tally of the number of successful (granted) and unsuccessful (denied) attempts to connect to your modem using each user name.

Your modem allows every caller three attempts to enter the correct user name and password. If the caller cannot correctly enter the password, a record is made by your modem that an unsuccessful attempt has been made to use that particular user name.

If the number of unsuccessful calls for any user name reaches 255, that user name will be locked and callers will no longer be able to use it, even if the correct password is used. You will not be able to use that particular user name until the access record for all users has been reset.

If, however, the caller does correctly enter the password, your modem records that a successful attempt was made to connect with that user name.

You should regularly check the number of successful and unsuccessful attempts to connect to your modem.

- Select option 4 to view the access record <E>

An unusually high number of unsuccessful attempts to connect with a particular user name may indicate someone is trying to violate your modem's security.

Over a period of many months one of the security users may legitimately accumulate 255 errors, in which case, your modem will automatically lock that user. If this occurs, select option 2, enter the user's name and select the Z option to clear his access record.

Each attempted access with an unknown name increments the 'Invalid Usernames Received' count at the top of the list.

Enabling Modem Security

Selecting option 6 or option 7 allows you to disable or enable your modem's security mode. With security mode enabled, whenever your modem answers an incoming call it will demand the caller enter a user name and password — the following message will appear on the caller's computer screen:

Enter Name:

If only one of the modems is configured to use error correction, there will be a slight delay between the time the modems connect and when the caller is asked to enter his user name.

When the caller enters his name all characters will be displayed as # characters.

The caller is allowed three attempts to correctly enter his name. Your modem is not case sensitive to user names. If the caller enters a valid user name, your modem will ask the caller to enter the password associated with that user name.

Enter Password:

If the caller enters his password correctly, your modem will send the message ACCESS GRANTED and the caller will have access to the computer connected to your modem.

If the caller cannot, within three attempts, enter the correct user name and password, your modem will send the message ACCESS DENIED and will hang up.

Quitting the Menu

The Quit Security Menu option allows you to return to local command state from the security menu.

- Press 0 <E>

Your modem will issue an OK message. You will be returned to local command state.

Callback Security

As mentioned earlier, your modem allows you to specify a modem command with every user name and password. This feature allows you to implement modem callback. Callback means that after a caller has successfully connected, your modem will hang up and then dial the caller.

Even if an unauthorised caller successfully connects to your modem, that caller will have to be using the phone line which your modem is going to call back. Three commands are required to implement callback. First, you must hang up your modem with a H command.

Before your modem can call the caller back, it must wait for the caller's modem to hang up and return to local command state. S Register 27 contains a value representing the number of seconds your modem will wait before commencing dialling. The default value for this register is 0 — your modem will begin to dial as soon as it receives a dial command.

It is necessary, therefore, to place another value in S Register 27 to allow the caller's modem sufficient time to hang up before your modem begins to dial. A 30-second delay should be sufficient time to allow most modems to hang up, so place an S27=30 in the command.

Using a 30-second delay means the telephone exchange, in most cases, will disconnect the call. This ensures unauthorised callers cannot 'fool' callback security by not hanging up after your modem hangs up.

Alternatively, contact your telephone company — some telephone companies offer an automatic disconnect facility, which assumes a caller cannot remain off-hook after the modem has hung up.

Place a D command and the caller's phone number in the command.

Assuming the caller's phone number is 1234567, you will now have a command which looks like this:

```
H S27=95 D1234567
```

After the user has been called back and has completed the call, your modem will hang up, automatically issue an ATZ command to restore all the stored settings and return to local command state. The ATZ command will effect some settings - to save your configuration, issue a &W after you initialize the modem.

☛ **UK Modems. Telephone exchanges in the UK may not hangup after 30 seconds. Consult the supplier of your telephone line for a possible solution.**

☞ ***If security is enabled, the answering modem will not assert DCD or DSR until a valid user name and password are received. If \Q5 is selected, CTS will not be asserted until a valid user name and password are received.***

Downloading the Security File

Selecting option 'D' from the security menu will enable a dump of the security database to your computer for storage or editing. You will be asked to type 'Y' to start the download.

The file format is:

"<user name>", "<password>", "<command>", nnn, mmm CR LF where nnn and mmm are the 3 digit Granted and Denied Access Counts and CR and LF are Carriage Return and Line Feed.

The last entry has only a CR LF

☞ ***The download will take place at the current terminal speed. No flow control is acknowledged. If your computer cannot accept the file at the current data rate exit security and autobaud to a lower speed.***

Example: "FRED", "NURK", "HS27=30DT3277502", 000, 000 is a valid entry.

☞ ***The Socket Rocket only supports a security user database of 100 users, so if this limit is exceeded you may have to:***

- Download the Security Database to diskette
- Using a text editor, delete all users except the desired users (up to 100)
- The last entry has only a CR LF
- Upload as per the following

Uploading the Security File

Selecting option 'U' from the security menu will enable a security file in the format described under the Download command to be uploaded into the modem. You will first be warned that your existing database will be overwritten and then told to start uploading the file.

When the upload is finished the modem will return to the security menu. The upload will take place at the current terminal speed. The modem can accept data at 115Kbps.

☞ ***If the data is not in the correct format, the file can be corrupted, so edit with care and always keep a copy of the unmodified download file.***

Integrating Caller ID into the Security Database

- Enter the Security Menu by typing AT#S.

You will then be presented with a request for a Password. If you have not specified a password then key ENTER, else type in the password. The Caller ID status is displayed at the bottom of the Security Menu. If Caller ID is enabled you have the choice of Excluding Callers who are unknown and Accepting Callers who are unknown by using the 'T' command. The T command toggles the option.

- To enter a phone number into the security database use the '2' command.

The modem will prompt for the name of the user you wish to identify.

Enter the name and then skip the Password and Options fields by pressing ENTER for each. The modem will ask for a Command or Phone Number. Simply enter the phone number you want to recognise at this point.

If you wish to identify a range of numbers with the same user name, as in the case of a business with a large number of phone numbers, you can use the * to match any digit in that position. For example:

9678 79** will map all numbers from 9678 7900 to 9678 7999.

You may have multiple entries with the same name but different numbers. You are then given a choice of barring this user by entering the 'D' option. If you press ENTER for this option, the user will always be answered as long as S0 is not 0 and DTR is on.

You will then be prompted for another name. When you are finished entering names. Key ENTER to return to the Security Menu.

You may display the users in the database by selecting the '1' command. Caller ID entries are distinguished from DIAL BACK security entries by the lack of valid AT commands in the Command field.

Encryption

Your modem supports Data Encryption Standard (DES) encryption. DES encryption allows you to encrypt data being passed to a remote modem. The remote modem must support Cipher Feedback (or CFB) DES encryption in order to decrypt the data sent from your modem.

The #E1 command is used to enable DES encryption.

The modem requires you to enter an encryption Key and an Initial Value.

These are two 16-character hexadecimal numbers. Both the Key and Initial Value are specified by the user, making the encrypted data virtually impossible to decrypt without access to the Key and Initial Value.

Both modems must have DES encryption and error correction selected and must use the same encryption Key and the same Initial Value.

☛ Only use a reliable error correction mode when using DES encryption. This will ensure you will only establish encrypted connections.

The modem can store up to 10 DES Key/IV pairs. Use AT*K to select the Key you wish to use. For example AT*K5 tells the modem to use the key and IV from register 5.

To enter the DES Key and Initial Value:

- Type: AT#S <E>
- Type: 9 <E>

You will be prompted with the following message:

Select DES Key register (0-9) (Key ENTER/or main menu):

You should select one of the 10 available registers to store the new Key.

The modem will respond:

Enter New DES Key:.....

Re-enter DES Key:.....

Enter new DES IV:.....

Re-enter DES IV:.....

- Enter the Key and Initial Value as a 16-character hexadecimal number <E>

You will be prompted to re-enter the Key and Initial Value, to verify the correct Key and Initial Value has been entered. You may then enter a new DES Key into another register or press ENTER to return to the main menu.

To enable DES encryption, issue the AT#E1 command. The next time your modem establishes a connection with another modem, it will encrypt outgoing data and attempt to decrypt incoming data.

☛ **For countries other than Australia, DES encryption is only available to end users who meet the security requirements of the Australian Department of Defence. Contact your modem supplier for details of making application for a DES equipped modem to be supplied to you.**

DES Multikey

DES Multikey allows the answering modem to establish which primary keys the originating modem is using and then automatically switch to that key.

- The originating modem uses AT*K to select the current Key and Initial Value. The modem encrypts the current Initial Value with the current Key and transmits it just before connection occurs.
- The answering modem then decrypts the 8 bytes received with each of its stored keys to see if any transform into the Initial Value for that key. If none match, the answering modem switches to that Key. MultiKey uses the Initial Value essentially as a password to allow the keys to be matched. Security is not compromised in any way since both the Key and the Initial Value are secret and no information can be extracted from the transmitted message.

Up to 10 keys can be specified via the AT#S Security Menu. A key of all zeros is ignored unless it is selected as the current key with the *K command. The factory default is AT*K0 with Key 0 having an all zero Key and Initial Value.

☛ **This should not be used as a live key, both Key and Initial Value should be set up before use.**

This mechanism can be used to allow gradual key changes throughout a network since it allows both old and new keys to be recognised until the key change is complete. It also allows some users temporary access with a limited time key or to control access by giving different user groups different keys.

SuperSecure Advanced Security Mode

SuperSecure mode allows you to :

- Have an individual password and an individual DES KEY.
- Automatically change the DES key in a random manner after each connection without the keys ever being knowable.
- Have a different password on the answering modem to the originating modem.
- Timed expiry of passwords.

With these new features, a link between two modems will be very secure. No other modem can dial either modem and connect because the third party will not know the keys of the other users, even if both passwords are known.

Entering a Key for Each User

- Enter AT#E2 to enable SuperSecure mode
- Select the security menu using AT#S
- Enter the security password to gain access to the security menu
- Set up the modem's primary DES KEY and Initial Value (IV) as per standard DES setup
- Select Option 2 to add new users
- Enter the username
- Enter the password to be used by your modem (not necessarily the same as the password on the modem you are going to dial)

☞ **Do not use a / character in any password, because this character is reserved.**

- When the modem prompts you for a command, do not enter a command because you will not be prompted for the DES KEYS
- Enter the 16 hex digit DES secondary KEY for the user, all 16 digits must be keyed
- Enter the 16 hex digit DES secondary Initial Value (IV) for the user, all 16 digits must be keyed
- Enter the 2 hex digit Key Encryptor (KE) for the user, both digits must be keyed

☞ **The Key, IV and KE can have any value but must be exactly the same on both answering and originating modems.**

☞ **For maximum security do not use keys or initial values that have easy to remember values.**

☞ **A KE of 00 turns off random key rotation.**

- Enter as many users as you wish whilst in this mode
- Press ENTER at the username prompt to return to the menu

☞ **You do not have to turn security on to use SuperSecure. The #E2 option forces it on always.**

- Enter 0 to exit the security menu

☞ **The remote modem must not only support SuperSecure but must also have a matching username/password and KEYS before access can be gained.**

Accessing a System Using SuperSecure

If both your modem and the remote modem have been correctly setup you can: q Dial the remote system.

- The modems will connect and enter security dialog mode using the modem's primary key.
- This key must be the same for both modems.
 - Enter your username
 - Press ENTER
 - Enter your user password stored in the remote modem then '/'
 - Enter your password stored in your modem
 - Press ENTER

☞ ***You may backspace to correct errors but you will not be able to see what is typed since all characters are echoed as #***

- Do not use the / character in any password
- If the password is the same on both modems then only one password needs to be entered

Connection

- You will then CONNECT if the username, both passwords, all of the KEYS, IVs and KEs match.
- The data will be correct and error free, but encrypted on the line using a KEY unknown to anyone.

Disconnection

- If the primary DES KEY mis matches you will not be able to read the "username" prompt.
- The modems will disconnect if:
 - The secondary key, IV or KE mismatches (you will also receive a message)
 - An error corrected link cannot be established
 - Wrong username and/or password is used. You will be given another two chances to enter them before the modem disconnects

Example:

ATDT 456 4321

RINGING

RINGING

Enter name: MarkStein

Enter password: Fudge/Vanilla

Access granted

- 'Fudge' is Mark Stein's password on the remote system
- 'Vanilla' is the password on the local modem

- 'Access granted' confirms that the passwords are correct
- Secondary keys mismatch if the secondary KEY, IV or KE are different

Enabling Rotating Secondary Keys

- If you enter a KE of 00 for the user, then the secondary key will remain the same for each connection.
- If the KE is not 00 then this value is used as a seed to create a random new secondary key for the user on each connection.
- After the initial connection is made with the KEY, IV and KE you have entered, these values will change on both modems to new values which are not accessible by any means.
- If an event occurs that corrupts the KEY, IV or KE on either modem, then both modems will have to be manually set back to a known starting point.

☛ ***To ensure random unknown keys, make two connections between the secure modems after they have been initialised.***

Symmetrical Operation

- Either modem can originate the call.
- Remote modem's password is first.
- Local modem's password is second.

Automatic Synchronisation

- The keys only change after a successful connection is achieved at both ends.
- If either modem drops out during the security handshake before the CONNECT message, the modems will automatically resynchronise on the next connection.

Password Expiry Option

You may specify the number of days you have before the password must be changed. By default this option is OFF, to enable it select the C option from the security menu. You will then be prompted for the number of days before a password expires (1-255 days). The access record (Option 4) displays the password age limit and the age of each user's password.

- When a password is within 5 days of expiry a message will be given before the connect message.
- After the password has expired, you will be informed and will not be allowed another connection until a new password is entered. The access record also notes if you have been informed of the expiry.
- Either the remote or the local password or both may expire.

☛ ***There is no real time clock inside the modem. When the modem is turned off the clock stops. Therefore the expiry timers actually time the number of days that the modem is turned on and not elapsed days.***

Entering a Password in the Remote Modem's Database

When connected in SuperSecure, you may change your password.

- Enter **** with a 1 second guard time on either side of the stars
- Enter your current password
- Enter your new password
- Verify your new password
- You will then be returned online

Entering a New Password in the Local Modem's Database

When connected in SuperSecure, to change your password:

- Enter in the escape sequence +++
- Enter in the *S command
- Enter your new password
- Verify your password
- ATO to return online

☞ ***If you are not online or in the current session of SuperSecure, you must identify yourself by entering your current username and password before being able to enter your new password.***

Minimum Password Length

You can specify the minimum password length accepted by the modem by the E option from the Security Menu. Its power-on default is 3 characters.

Uploading and Downloading the SuperSecure Database

- To ensure the integrity of your modem's security database the sensitive fields are encrypted with the modem's primary key. Your password and DES KEYS are scrambled but will be restored when uploaded into a modem with the same primary key.
- You may delete unwanted records and modify the unencrypted fields, but the encrypted fields must not be touched.
- If you wish to enter a new user, you may do so using the same format as the other records. The three digit control field at the start of each record should be set to the following values for a new user:

000	Not SuperSecure User, no DES keys specified (use for dialback)
001	DES keys specified
003	DES keys specified, Supervisor Status
005	DES keys specified, No password expiry
007	DES keys specified, No password expiry and Supervisor Status

❑ The record format is:

```
aaa, "<username>", "<encrypted password>", "<command>",  
"bbb,ccc,ddd,eee,fff,ggg", "<encrypted key>", "<encrypted> IV",  
"<encrypted KE>"CR,LF
```

- aaa is 3 digit control number
- bbb is 3 digit access granted count
- ccc is 3 digit access denied count
- ddd is 3 digit days since password change
- eee is 3 digit reserved
- fff is 3 digit reserved
- ggg is 3 digit reserved

☞ **The control number should not be touched on existing users.**

Security Database Lock Option

From the Security Menu you may elect to LOCK the security database with the 'L' option. When locked, the user cannot change the #E setting or clear the security database even with the &F. command or power-on reset with the Mode Switch depressed.

The only way to alter the database or #E selection is to enter the Security Menu with the security password and unlock the database with the 'F' (Free) command.

The current state: LOCKED or FREE is displayed below the Security Menu.

☞ **Shorting out the NOVRAM battery will erase the database but will result in the modem being only partially functional. Such modems need to be returned to the factory for re-configuration.**

Outdial Disable Option

If modems are to be used only for receiving calls option 'K' can be selected.

This does not allow the modem to dial out. If an attempt to do so, users will be informed that a SECURITY LOCKOUT is in place and the call will not be successful.

The outdial feature will be useful for system administrators who wish to control the use of modems within remote offices or restrict modems to being used for receiving calls only.

Dial Stored Phone Numbers Only Option

Option 'M' is similar to Option 'K' but restricts the modem to dialling only those numbers listed in the stored phone number fields as set with the &Z command.

The stored numbers must then be dialled using the ATDS=X command where X is the position of the stored number as set with the AT&Z command. New stored numbers cannot be added by the user once the dial restriction has been enabled.

General Notes on Data Security

- By using SuperSecure you now have
 - Ensured that the phone link between two modems is secure
 - Ensured that no other user can access either modem when #E2 is enabled
- The weak link in the system is now the cable between your modem and your computer.
 - It should be kept visible at all times to prevent wire tapping
 - The modem, computer and interconnecting cable should be physically secure to prevent access
- With specialised equipment, the data on the lines and the image on a screen can be read, due to wires and video screens radiating radio frequency signals which can be picked up over a distance. You may need advice on radio frequency screening if this concerns you.

Synchronous Modes

This section explains the use of your modem in synchronous modes. A dumb mode or manual mode allows some of the functions of your modem to be accessed via the front panel switches.

Some of the information in this section assumes you have read the Getting Started Section.

Your modem offers two synchronous modes, conforming to the Hayes modem synchronous modes 1 and 2. These modes allow synchronous communication over two-wire PSTN or leased lines when connected to asynchronous/ synchronous computers or dedicated synchronous terminals.

Synchronous Operation

Your modem supports two synchronous modes. Mode 1 allows operation with computers which support asynchronous and synchronous communication on a single RS-232 port. Mode 2 allows your modem to be operated with dedicated synchronous terminals.

Although your modem can only operate over a single two-wire connection, it will still perform full-duplex synchronous communication. Half-duplex operation could be simulated by controlling the state of the RTS and CTS signals.

Terminal Speeds

Your synchronous terminal or host should use the clock signals provided by the modem to synchronise transmit and receive data. The clock speed will represent the actual connection speed of the modem.

☛ ***When synchronous mode is selected, your modem cannot operate in constant speed mode or use the error correction or data compression facilities of the modem. Only variable speed mode is available in synchronous connections (this refers to the modem's terminal speed).***

Line Speeds

Your modem supports a number of synchronous line speeds.

When operating in synchronous mode, your modem should always be configured with a locked, non-auto-ranging B setting (this refers to modem line speed).

For V.34 or V.FC, the B setting only sets the maximum speed. The modem will automatically determine the highest usable speed for the line.

Synchronous Mode 1

Your modem is capable of dialling remote systems in asynchronous mode and then automatically switching to synchronous mode once connection has been made. If the connection is lost, your modem will hang up and return to asynchronous local command state.

The computer required to support synchronous communication with your modem must be capable of switching between synchronous and asynchronous modes with the same RS-232 port, as well as controlling the state of the DTR signal under software supervision.

Selecting Synchronous Mode 1

Synchronous mode 1 is selected with the &M1 command.

- Type: AT&M1 <E>

Your modem will enter synchronous mode whenever it successfully connects to a remote modem.

You should also:

- Type: AT&D2 <E>

This allows hang up via your computer's DTR signal.

☞ ***Your computer will not be able to hang up the modem if the DTR Option Switch is in the DOWN position (DTR will always be asserted). DTR must be lowered to make the modem hang up.***

To return to asynchronous operation:

- Type: AT&M0 <E>

Dialling

Your computer must be in asynchronous mode before dialling commences. To begin dialling use the D command. Response codes sent to the computer depend upon the settings of the X, V and Q commands. As soon as a connection can be established, your modem will assert CTS and enter synchronous on-line state. If connection cannot be made, your modem will hang up and return to asynchronous local command state.

Character echo and response codes should not be selected when synchronous communications are used. Use the E0 and Q1 commands to disable character echo and response codes.

As soon as your modem has completed dialling it will examine the state of the DTR signal. If DTR is asserted your modem will go on line in synchronous mode, otherwise the modem will hang up and return to asynchronous local command state.

☞ ***Data should only be transmitted once DCD, DTR and CTS have been asserted. Your computer should not assume that if CTS is asserted then it is safe to begin transmitting data — your modem will keep CTS asserted whenever it is in local command state.***

Hanging Up

Your modem will hang up and return to asynchronous mode if carrier is lost for longer than the period defined by S Register 10 or if DTR is lowered after the &D2 command has been issued.

Answering Calls

To automatically answer incoming calls, S Register 0 must be set to a non-zero value (as with asynchronous auto-answering). Once a call has been answered there is no means of returning to asynchronous mode apart from hanging up the modem. This will occur if the carrier is lost for a period in excess of the time defined by S Register 0 or if DTR is lowered after the &D2 command has been issued.

Synchronous Mode 2

Synchronous mode 2 is specifically designed for use with dedicated synchronous terminals. The phone number to be dialled is stored in the modem, the synchronous terminal causing the modem to dial by asserting the DTR signal.

When the terminal asserts the DTR signal (DTR makes an OFF-ON transition), your modem will dial stored phone number zero. The phone number may contain dial modifiers. See the Command Descriptions chapter of this guide for details on the &Z command.

Before connecting your modem to your synchronous terminal, the modem must first be configured using an asynchronous terminal or computer. The Sample Setups section of this manual details a common configuration for synchronous mode 2.

Selecting Synchronous Mode 2

Synchronous mode 2 is selected with the &M2 command.

- Type: AT&M2 <E>

Your modem will enter synchronous mode whenever it successfully connects to a remote modem.

You should also:

- Type: AT&D2 <E>

This allows you to dial and hang up.

To return to asynchronous mode:

- Type: AT&M0 <E>

Your modem will remain in asynchronous mode.

Dialling

Dialling will commence as soon as the DTR signal is asserted (an OFF-ON transition occurs). Your modem will not generate response codes when synchronous mode 2 is selected. All call progress is indicated by your modem's speaker (the M command controls the operation of your modem's speaker). As soon as your modem connects to a remote modem it will assert the DSR and DCD signals.

Hanging Up

Your modem will hang up and return to quiet asynchronous mode if the carrier is lost for longer than the period defined by S Register 10 or if DTR is lowered.

Answering Calls

Whenever your modem receives an incoming call it will assert the RI signal. The terminal may accept the call by asserting the DTR signal as soon as the number of rings defined by S Register 0 is reached. The terminal may refuse the call by keeping DTR low eight seconds after the number of rings in S Register 0 is reached.

Your modem will not dial the stored number in response to DTR being asserted between the time an incoming call is initially detected and the call being cleared.

Dumb Mode Operation

Your modem has two methods of operating with your computer. The commonly used method is “smart mode”, where the computer issues “AT” commands to the modem to make it dial and hang up. For computers which do not offer an asynchronous port or cannot communicate synchronously using V.25bis commands, dumb mode permits manual control of your modem.

Selecting Dumb Mode on Desktop Modems

To select Dumb mode:

- Place front panel Option switch 4 in the Down position

To select Smart mode:

- Place front panel Option switch 4 in the Up position

The Option Switches and Mode and Talk/Data buttons

Some modems also have rear panel Option switches — check the rear panel of your modem.

HINT To restore the factory settings of your modem, switch it on holding the Mode button in, until the modem “beeps” twice.

Setting Up your Modem

In most instances, your modem will need to be configured prior to entering Dumb mode. All configuration of your modem is performed using the AT commands.

For example, if you wish to have your modem dial a stored telephone number when the computer asserts (or “raises”) the DTR signal, you must first store the telephone number in the modem and select stored number dialling operation, using the AT commands.

Selecting Communications Speeds

If you are dialling in Dumb mode, the communication speed it uses is dependant upon the setting of the front panel Mode LEDs. To change the speed at which your modem connects after dialling:

- Place front panel Option switches 3 and 4 in the Down position (disable auto-answering, select Dumb mode)
- Press the Mode button (located next to the front panel Option switches) until the correct speed is indicated on the front panel Mode LEDs

☞ **Your modem cannot dial if auto-answer is enabled.**

Refer to the mode table at the beginning of the User Guide - it shows the meaning of each combination of the Mode LEDs.

To change the speed at which your modem connects after answering an incoming call:

- Place front panel Option switch 4 in the Up position (select Smart mode)
- *Connect your modem to a personal computer — refer to the modem Read Me First Guide for details*
- Run a communications program and enter “local mode” or “terminal mode”
- Type: ATBx&W <E>

where “x” is a valid setting of the B command. For example, ATB13&W selects V.32 (9600 bps) mode.

The B command is used to set the communications standard used by your modem.

Hints for Unix Computers and Multiplexers

Many Unix computers and multiplexers which offer synchronous communications ports cannot cope with the response messages generated by the modem. For this reason, you may wish to switch off response messages before you connect your modem to the Unix computer or multiplexer.

- Place front panel Option switch 4 in the Up position to select Smart mode
- Connect your modem to a personal computer, a Unix computer or a serial server — refer to the modem Read Me First Guide for details
- Run a communications program and enter “local mode” or “terminal mode”
- Type: ATE0Q1&N0&W <E>
- Exit the communications program

This command switches off response messages and character echo, causes the modem to ignore characters sent to it from the host while dialling or answering, and saves the changes in the modem.

Dialling in Dumb Mode

There are three ways of dialling in dumb mode:

- Use a telephone handset connected to the modem.
- Store a telephone number in the modem and then have the computer raise the DTR signal.
- Store a telephone number in the modem and then press the Talk/Data switch.

Dialling with a Telephone Handset

Manual dialling requires a telephone handset to be connected to the same phone line as your modem. Use a telephone cable with a double adaptor socket to connect your modem and telephone to the same phone line

- Set up your modem in “smart mode”, using the AT commands.
- Place front panel Option switch 4 in the Down position (select Dumb mode)
- Place front panel Option switch 6 in the Down position (select Originate mode)
- Place front panel Option switch 3 in the Down position (disable autoanswering)

☛ **Your modem cannot dial if auto-answer is enabled.**

- If necessary, use the Mode button to select the required communication speed

The connection speed of the modem is indicated by the Mode LEDs..

- Press the Talk/Data button to Talk (this button is located next to the front panel Option switches)
- Using the telephone handset, dial the number
- As soon as the other modem answers your call, press the Talk/Data button to Data

If the AT&D2 command has been issued prior to entering Dumb mode, your computer must raise the DTR signal before you press the Talk/Data button.

- Place the handset on-hook

The OH and CD LEDs glow when the modem connects.

To hang up:

- Press the Talk/Data button to Talk

Using the Talk /Data Button to Dial

You may commence dialling by pressing the Talk/Data button, located next to the front panel Option switches. By dialling in this manner, you do not need to use a telephone handset.

- Place front panel Option switch 4 in the Up position (select Smart mode)
- *Connect your modem to a personal computer — refer to the modem Read Me First Guide for details*
- Run a communications program and enter “local mode” or “terminal mode”
- Type: AT&Z0=phoneno <E>

Where “phoneno” is the telephone number you want your modem to dial. This command stores the number as stored telephone number zero.

☛ **If you are using your modem over leased lines, do not store a phone number.**

- Type: AT&D2&M4 <E>

or:

Type: AT&D2E0Q1&M2 <E>

Issue the &M4 command if you wish to use asynchronous communications; issue &M2 if you wish to use synchronous communications.

- Type: AT&W <E>

The modem set up is saved.

- Place front panel Option switch 4 in the Down position (select Dumb mode)
- Place front panel Option switch 6 in the Down position (select Originate mode)
- Place front panel Option switch 3 in the Down position (disable autoanswering)

☛ **Your modem cannot dial if auto-answer is enabled.**

- If necessary, use the Mode button to select the required communication speed
The connection speed of the modem is indicated by the Mode LEDs. Refer to the Modem LED display table; it shows the meaning of each combination of Mode LEDs.
- Raise the DTR signal on your computer. If your modem has a TR front panel LED, it glows when DTR is raised.
- Press the Talk/Data button to Data
The Talk/Data button must be changed from Talk to Data to cause the modem to dial.
Your modem dials stored telephone number zero. The OH and CD LEDs glow when the modem connects.

To hang up:

- Have your computer lower the DTR signal or press the Talk/Data switch to Talk

Using DTR to Dial

You may commence dialling by having your computer raise its DTR signal.

- Place front panel Option switch 4 in the Up position (select Smart mode)
- Connect your modem to a personal computer — refer to the modem Read Me First Guide for details • *Run a communications program and enter “local mode” or “terminal mode”*
- Type: AT&Z0=phoneno <E>
Where “phoneno” is the telephone number you want your modem to dial. This stores the number as stored telephone number zero.

☞ **If you are using your modem over leased lines, do not store a phone number.**

- Type: AT&D2&M4 <E>
or:
Type: AT&D2&M2 <E>
Issue the &M4 command if you wish to use asynchronous communications; issue &M2 if you wish to use synchronous communications.
- Type: AT&Wn <E>
The modem set up is saved to profile n=0-3
- Place front panel Option switch 4 in the Down position (select Dumb mode)
- Place front panel Option switch 6 in the Down position (select Originate mode)
- If necessary, use the Mode button to select the required communication speed
The connection speed of the modem is indicated by the Mode LEDs. Refer to the Modem LED Display table; it shows the meaning of each combination of Mode LEDs.
- Press the Talk/Data button to Data (this button is located next to the front panel Option switches)
- Raise the DTR signal on your computer
DTR must change from “low” to “high” to commence dialling. Your modem dials the stored telephone number zero. The OH and CD LEDs glow when the modem connects.

To hang up:

- Have your computer lower the DTR signal, or press the Talk/Data button to Talk

Answering Calls in Dumb Mode

Your modem is able to answer incoming calls, automatically or by manual intervention.

Automatic Answering

Your modem is able to auto-answer incoming calls in Dumb mode. You do not need a telephone handset to have your modem answer incoming calls.

- Place front panel Option switch 4 in the Up position (select Smart mode)
- Connect your modem to a personal computer
- Run a communications program and enter “local mode” or “terminal mode”
- Type: ATBx <E>

where “x” is a valid setting of the B command. The B command is used to set the communications standard used by your modem.

- Type: AT&D2&M0 <E>

or:

Type: AT&D2E0Q1&M1 <E>

Issue the &M0 command if you wish to use asynchronous communications; issue &M1 if you wish to use synchronous communications.

- Type: AT&W <E>

The modem set up is saved.

- Place front panel Option switch 4 in the Down position (select Dumb mode)
- Place front panel Option switch 6 in the Up position (select Answer mode)
- Place front panel Option switch 3 in the Up position (allow autoanswering of incoming calls)

If the &D2 command has been issued to the modem, DTR must be raised by your computer.

- Press the Talk/Data button (located next to the front panel Option switches) to Data

Your modem answers incoming calls after the number of rings specified in S Register 0.

Manual Answering

For reasons of data security, it may be desirable to verbally identify a caller before allowing connection to your computer. A telephone handset must be connected to the same telephone line as your modem to permit manual answering.

- Place front panel Option switch 4 in the Up position (select Smart mode)
- Connect your modem to a personal computer — refer to the modem Read Me First Guide for details
- Run a communications program and enter “local mode” or “terminal mode”

- Type: ATBx <E>
where “x” is a valid setting of the B command. The B command is used to set the communications standard used by your modem.
- Type: AT&D2&M0 <E>
or:
Type: AT&D2&M1 <E>
Issue the &M0 command if you wish to use asynchronous communications; issue &M1 if you wish to use synchronous communications.
- Type: AT&W <E>
The modem set up is saved.
- Place front panel Option switch 4 in the Down position (select Dumb mode)
- Place front panel Option switch 6 in the Up position (select Answer mode)
- Place front panel Option switch 3 in the Down position (stop autoanswering of incoming calls)
If the &D2 command has been issued to your modem, your computer must raise the DTR signal
- Press the Talk/Data button to Talk (this button is located next to the front panel Option switches)
- When the telephone handset rings, pick it up and establish the caller identity
The person calling you must perform a manual dial (that is, he/she must dial using a telephone handset).
- When you are ready to allow access to your computer, press the Talk/ Data button to Data
- Place the handset on-hook
At the same time, the caller must make his/her modem enter “data mode” and place his/her handset on-hook. (Refer to Dialling with a Telephone Handset section)
The OH and CD LEDs glow when the modems connect.

V.25bis Operations

V.25bis is a modem command set like the AT command set, which allows you to control your modem. However, V.25bis commands may be issued to the modem in asynchronous or synchronous mode (AT commands may only be issued when the modem is operating in asynchronous mode). This means V.25bis is suitable for mainframe and minicomputers which only support synchronous communications ports. The implementation of V.25bis supported by your modem is based upon the 1988 revision of the V.25bis specification, however not all aspects of the V.25bis specification have been implemented.

☞ **V.25bis operation is supported in both smart and dumb modes.**

Selecting V.25bis Operation

To select V.25bis mode, issue the appropriate #M command. Three V.25bis modes are supported by your modem:

- o Asynchronous V.25bis. The modem operates in asynchronous mode using V.25bis command rather than AT commands. Issue the AT#M1 command to select this mode.
- o Synchronous V.25bis with HDLC framing. The modem communicates and accepts V.25bis commands in synchronous mode with HDLC framing. Issue the AT#M2 command to select this mode.
- o Synchronous V.25bis/BSC mode. The modem communicates and accepts V.25bis commands in synchronous mode with character framing (BSC mode). Issue the AT#M3 command to select this mode.

The &W and Z commands must be issued after the #M command in order for V.25bis command mode to be selected. Alternately, issue the &W command after the #M command and switch the modem off and on or lower DTR (after an &D3 command has been issued).

☞ *When you reset the modem (for example, you issue the &F command or issue the RST command or switch the modem off and on), you must issue an ATZ command to select V.25bis command mode; your modem always resets and powers-up in AT command mode, regardless of the setting of the #M command.*

If your modem has Option switches to select V.25bis operation, the setting of the Option switches always take precedence over the #M command.

The %R2 option will be required for most V.25bis setups. This setting ensures that the CTS signal is only asserted when the modem is ready to accept a new command (in command mode).

Overridden Settings

Almost all AT commands and S Registers stored before entering V.25bis mode will have effect except for the following commands.

AT Command	V.25bis Operation
&D	Will act as if &D2 is selected
S0	Will act as if S0=1

These override settings are not stored in your modem's non-volatile memory; they are active only while V.25bis command mode is active. If you issue the &V command to view the modem's configuration the original settings will be displayed.

V.25bis Commands

Six V.25bis commands are supported by your modem:

Command	Description
CRN n	Dial phone number n
CRS x	Dial stored phone number x
PRN x:n	Save n as stored phone number x
DIC	Disregard an incoming call
CIC	Connect to an incoming call
RST	Restore factory default parameters

Data Formats

Not all data formats are supported when V.25bis operation is selected. Use only the types of parity shown in the following table:

Mode	Parity
Async V.25bis	Even parity
Sync BSC	Odd parity
Sync HDLC	Bit 7 always zero in the information field.

Commands issued with the wrong parity are ignored by your modem.

V.25bis Indications

V.25bis indications are similar to the response codes, sent when your modem is operating in AT command mode. Six V.25bis indications are supported by your modem:

Verbal	Meaning
VAL	Command accepted and executed
CNX	Connection established
INC	Incoming call detected
CFI AB	Call failure, abort
CFI ET	Call failure, engaged
INV	Invalid command

These are the only indications supported by your modem. When operating in asynchronous V.25bis mode, these indicators are suffixed with Carriage Return and Line Feed characters and V.25bis indicators will only be sent to your computer if DTR is raised. In certain configurations, a two letter suffix may be appended to the INV response.

Dialling

Your modem supports two methods of dialling in V.25bis mode; “addressed calling” (similar to using an ATD command) and “direct calling” (similar to DTR dialling with the &M4 command).

The CRN command is used to initiate a telephone call. The most basic form of the CRN command is:

CRN *number*

where the *number* is the telephone number you are dialling.

For example:

- Type: CRN 01234 <E>

Your modem will dial 01234

If a connection can be made to a remote modem a CNX indicator will be sent by the modem. If a CFI AB indicator appears, your modem has not been able to make a connection.

To hang up the modem, your computer or communications software must make DTR low.

Dial Modifiers

Dial modifiers are characters than can be included in a phone number to make the modem perform special tasks while dialling.

For example, not all modem users will be using a dedicated telephone line.

Some users will have their modems connected to PABXs. To allow users of PABXs to operate their modems successfully, dial modifiers are supported by your modem.

Most PABXs require you to dial 0 or 9 (in order to obtain an outside line) and wait for a dial tone before dialling the actual phone number.

Using dial modifiers, you can successfully dial the phone number 12345 through a PABX using the command:

- Type: CRN 0<12345

The < dial modifier causes the modem to pause for a short time after dialling 0. This allows most PABXs sufficient time to obtain a line before dialling.

The factory default delay for the < modifier is two seconds. You may change the length of this delay if necessary. Its length is determined by the value in S Register 8.

Another method of making the modem wait for a dial tone is to include the : (colon) dial modifier. The : modifier causes the modem to examine the phone line to ensure a dial tone has been applied before dialling starts. For example:

- Type: CRN 0:12345

If the modem cannot detect a dial tone within the time specified by S Register 7, the modem will return to local command state and send a CFI AB indicator to the computer.

☞ Due to differences with some older telephone exchanges, dial tone detection may not be possible with your modem. Your modem will only recognise dial tones between 200 Hz and 600 Hz.

More information about dial modifiers can be found in the Command Descriptions section of this guide.

Hanging Up

To hang up your modem when operating in V.25bis mode, lower DTR. Your modem will hang up whenever DTR goes low.

Stored Number Dialling

Your modem has the ability to store phone numbers for redialling at a later time. For example, to store a phone number use the PRN command:

- Type: PRN 1;012345 <E>
The phone number “012345” will be stored as phone number one.

To dial a phone number that has been stored in your modem:

- Type: CRS 1 <E>

The modem will dial stored phone number one.

Stored phone numbers are shared by V.25bis mode and AT Command mode. Thus, if you store a phone number while AT Command mode is active, you may dial that store phone number in V.25bis mode, or vice versa.

Direct Dialling

Direct dialling refers to your modem's ability to dial a stored phone number when the DTR signal of your computer is raised. This form of dialling is particularly suited to synchronous computers and is referred in other parts of this guide as 'DTR Dialling'.

☞ *The **&M** command (used to select various methods of DTR dialling in AT command mode) has no effect when the mode is operating in V.25bis command mode.*

To select direct dialling:

- Type: AT#D1 <E>

When DTR next goes from low to high, the modem will dial the stored phone number zero. Please note, some dial modifiers supported in V.25bis command mode are different to those supported in AT command mode and, thus, will be ignored by the modem if they are not appropriate for the selected command mode. Refer to the previous section, 'Stored Number Dialling', for more information about storing phone numbers in your modem; refer to the Command Descriptions section of this guide for more information about the dial modifiers supported in V.25bis mode.

☞ **Direct dialling is also supported in V.25bis dumb mode. If your modem supports dumb mode, refer to the *Dumb Mode Section*.**

Answering Calls

Your modem is pre-configured to automatically answer incoming calls. If you receive a call on the phone line the modem is connected to, it will answer the call and attempt to connect to the calling modem.

When V.25bis mode is selected, your modem will automatically answer incoming calls after one ring – the setting of S Register 0 is ignored when V.25bis mode is selected. The communications standard used by the modem in its attempt to connect with a calling modem is determined the B command.

If the phone does ring, the modem will issue an INC message to indicate an incoming call has been detected and will wait the number of seconds defined by S Register 71. S Register 71 allows you to ignore a call by issuing a DIC command before the number of seconds defined by S Register 71 is reached.

Thus, if S Register 71 is set to 10, you have 10 seconds after a call is detected to issue a DIC command; if you do not issue the DIC command within 10 seconds, your modem will attempt to connect to the calling modem.

☞ *If you issue the **DIC** command but then want to answer the call, issue the **CIC** command. The **CIC** command will cause your modem to answer a call after the **DIC** command has been issued.*

The modem will then go on line, transmit an answer tone, and attempt to connect to the calling modem using the communications standard selected by the B command.

As soon as a connection is established, the modem will send a CNX message to your computer and enter on-line state in answer mode.

Selecting Speeds

The following section describes how to select the terminal and line speed of the your modem when operating in V.25bis command mode.

Terminal Speeds

The #Q command is used to select the terminal speed in V.25bis command mode.

The AT#Q command determines whether to use a predefined terminal speed or the terminal speed when the last AT command was issued. Refer to the Command Descriptions section for details of the #Q command. Refer to the chapter titled 'Getting Started' for details of how the terminal speed is used by your modem.

By default, your modem will use the same speed as when the last AT command was issued.

Line Speeds

The line speed at which your modem operates is determined by the ATB command. The line speed must be selected before you select V.25bis mode.

By default B0 is selected. This will automatically select the highest common speed with the remote modem. See B command.

Refer to the chapter titled 'Getting Started' for details of how to set the line speed of your modem.

Modem Cable

In order to operate correctly, your modem cable must support the following signals:

DB25	Pin Signal
2	Transmit Data (TxD)
3	Receive Data (RxD)
4	Request to Send (RTS)
5	Clear to Send (CTS)
6	Data Set Ready (DSR)
7	Signal Ground
8	Data Carrier Detect (DCD)
15	Transmit Clock (TxC)†
17	Receive Clock (RxC)†
20	Data Terminal Ready (DTR)
22	Ring Indicator (RI)
24	External Clock (XCLK)†

† - Not required for asynchronous operation

Synchronous Character Encoding

Your modem supports both NRZ and NRZI character encoding when operating in synchronous mode. The #N command is used to select the character encoding technique suitable for use with the computer to which your modem is connected.

Refer to the chapter titled ‘Command Descriptions’ for details of the #N command.

Asynchronous Notes

The Backspace character may be used to edit V.25bis commands in asynchronous mode. No other editing characters are supported by the modem.

All control characters, other than Carriage Return and Backspace, are ignored by your modem.

Your modem will echo Carriage Return characters only, even if your computer issues Carriage Returns and Line Feeds at the end of a command.

BSC Notes

Commands must start with a STX and end with an ETX to be accepted by the modem.

Control characters that do not form part of the frame are treated as a normal characters. This usually results in the modem issuing an INV indication.

HDLC Notes

Commands must be correctly framed to be accepted by the modem. The address field must be FF, the control field must be 03 (hex) or 13 (hex) or a bad FCS field or an abort is received.

If a succession of V.25bis indications are to be sent to your computer, the poll bit (or final bit) will be set to zero for all but the last V.25bis indication, to signify that more V.25bis indications follow.

Control characters that do not form part of the frame are treated as a normal characters. This usually results in the modem issuing an INV indication.

Distinctive Ring

The modem is able to discriminate between three different types of rings. This is useful if you purchase the Telstra Duet service. With Telstra Duet, two phone numbers are shared for one telephone line. One is for voice and the second is for your modem. To enable the modem to answer only when your modem number is dialled, issue the command:

AT-SDR=4 S0=2 (This can be saved with AT&W). For most users, AT-SDR=4 will be suitable. Do not set Auto Answer for less than two rings when Distinctive Ring is enabled.

Distinctive Ring Commands

AT-SDR=n,x	where n=0 to 7, default=0, x=0 Disable Distinctive Ring response suffix; x=1 Enable Distinctive Ring response suffix (default)
AT-SDR=0	Any ring detected and reported as "RING"
AT-SDR=1,1	Single ring detected and reported as "RING1"
AT-SDR=1,0	Single ring detected and reported as "RING"
AT-SDR=2,1	Double ring detected and reported as "RING2"
AT-SDR=2,0	Double ring detected and reported as "RING"
AT-SDR=3,1	Single and double ring detected and reported as "RING1" or "RING2"
AT-SDR=3,0	Single and double ring detected and reported as "RING"
AT-SDR=4,1	Triple ring detected and reported as "RING3"
AT-SDR=4,0	Triple ring detected and reported as "RING"
AT-SDR=5,1	Single and triple ring detected and reported as "RING1" or "RING3"
AT-SDR=5,0	Single and triple ring detected and reported as "RING"
AT-SDR=6,1	Double and triple ring detected and reported as "RING2" or "RING3"
AT-SDR=6,0	Double and triple ring detected and reported as "RING"
AT-SDR=7	Any ring detected and reported as "RING1" or "RING2" or "RING3"

☛ **Use AT-SDR=4 for Telstra's Duet service.**

Caller ID

The SmartModem56 has enhanced Caller ID functions integrated with its security system. The user can set up the modem to display the number of all inbound calls and selectively answer or not answer the call depending on whether the caller is known. The modem can also be programmed to play a unique 'tune' if the caller is known.

Enabling the Caller ID Function

The user enables Caller ID by entering AT#CID1 (or AT#CID=1). It is off by default (AT#CID0).

When enabled a message will be inserted between the 1st and 2nd RING responses from the modem.

The message will be in the form:

DATE = mmdd	where mm is the month number (01 to 12) and dd is the day number (01-31)
TIME = hhmm	where hh is the hour number (00 to 23) and mm is the minute number (00-59)
NMBR = nnn...nnn	where nnn...nnn is the calling number. If the number is private the number is reported as 'P' if the network was unable to supply the number the number is reported as 'O'
NAME = ttt...ttt	where ttt...ttt is the name of the caller, if supplied by the network or if saved in the security database.

This format is compatible with standard Rockwell modem responses.

If the extended response option is selected (AT#CID3) the following messages are also available:

REASON NO NAME = <message>	where message is 'Out Of Area' or 'Private' is displayed if the network does not provide a name
QUAL = Long Distance	is displayed if the call is long distance
REDIRECT = <message>	where message can be 'Call Forward' or 'Call Forward: First Number Busy' or 'Call Forward: First Number Didn't Answer' if the call has been re-directed from another number.
LOOKUP NAME = ttt...ttt	where ttt...ttt is the name looked up by the modem in its security database.
CALLBACK NMBR = nnn nnn	where nnn...nnn is the phone number to use to ring the caller back (which may be different from the number he dialled in on)

These messages are only available if the Telecommunications Carrier inserts them.

A further option of AT#CID2 is available. This tells the modem to send the entire CALLER ID message back to the host computer in hex format to allow the host software to decode it.

The modem also supports the following commands:

AT#CID?	Which returns the current setting of the #CID command
AT#CID=?	Which returns the available settings of the #CID command (0,1,2,3)

Integrating Caller ID into the Security Database

Enter the Security Menu by typing AT#S.

You will then be presented with a request for a Password. If you have not specified a password then key ENTER, else type in the password.

The Caller ID status is displayed at the bottom of the Security Menu. If Caller ID is enabled you have the choice of Excluding Callers who are unknown and Accepting Callers who are unknown by using the 'T' command. The T command toggles the option.

To enter a phone number into the security database use the '2' command. The modem will prompt for the name of the user you wish to identify. Enter the name and then skip the Password and Options fields by pressing ENTER for each. The modem will ask for a Command or Phone Number. Simply enter the phone number you want to recognise at this point.

If you wish to identify a range of numbers with the same user name, as in the case of a business with a large number of phone numbers, you can use the * to match any digit in that position. For example: 9678 79** will map all numbers from 9678 7900 to 9678 7999.

You may have multiple entries with the same name but different numbers. You are then given a choice of barring this user by entering the 'D' option. If you press ENTER for this option, the user will always be answered as long as S0 is not 0 and DTR is on.

You will then be prompted for another name. When you are finished entering names. Key ENTER to return to the Security Menu.

You may display the users in the database by selecting the '1' command.

Caller ID entries are distinguished from DIAL BACK security entries by the lack of valid AT commands in the Command field.

Distinctive Ringing 'Tune' Option

You may enable a feature to identify a caller by playing a unique tune for each caller on each ring.

Enter #MUS1 to turn on this feature. The modem will assign a musical note to each letter in the user's name (@=A 440 A=A# B=B C=C D=C# E=D F=D# G=E H=F I=F# J=G K=G# L= A 880 ...etc).

The loudness of the tune is controlled by S register 76.

Call Logging

The SmartModem56 now includes a Call Logging Function. This function will automatically record the Date, Time, Phone Number and Name of any inbound call that has Caller ID information. In addition the modem will also log all outbound calls that are originated by the modem and record the phone number, connect speed, disconnect reason and call duration. The modem will also log information about anonymous inbound calls if the call makes a data or fax connection.

If the Time and Date have been set it will also record this. The Time and Date will be set by an inbound call with Caller ID information or by issuing the ATDATE command.

+ The modem does not have a non-volatile real time clock so the current time and date will be forgotten if the modem is turned off.

The Call Log can be displayed, most recent calls first by issuing AT-LOG. The Call Log can be deleted by issuing AT-LOG2 and then confirming the deletion by keying Y. AT&F and AT&F. do not delete the call log, it can only be explicitly deleted using AT-LOG2.

If you wish to secure the call log so that it cannot be deleted by unauthorised users, the AT-LOG2 command can be disabled from the security menu 'L' command (which also locks the encryption mode) and re-enabled using the 'F' command.

The modem has enough storage for approximately 400 calls.

☛ The current time and date is displayed at the end of the &V display if it has been set.

Call Log Format

The Call Log is displayed most recent call first. The information saved in the call log is:

DATE	in format mm/dd (month/day)
TIME	in format hh:mm (hour/minute)
NUMBER	for both inbound and outbound calls
NAME	the name of an inbound call is displayed if the name was provided in the Caller ID information or if the number was listed in the security database.
Duration	in format hh:mm:ss (hours:minutes:seconds) the total duration of the call.
S42	the code number for the disconnect reason. Maybe helpful for tracking down call that drop out mysteriously. Refer to manual or help text for information on the S42 codes.
SPEED	the connect line speed
ERROR CORRECTION	L for LAPM M for MNP - for no error correction

Commands

+++ Escape Sequence

When the modem is in on-line-state, issuing an escape sequence will force it to return it to on-line command state, without disconnecting.

Unlike other commands, you should not type AT before the escape sequence, nor type a carriage return after it. Instead, wait a full second before you type the escape sequence and then a full second after typing it. As soon as the modem returns to local command state, it will respond with the message: OK

This waiting period before and after the escape sequence is called the Escape Sequence Guard Time. This allows the modem to distinguish the escape sequence from the normal flow of information between modems.

You can change the character used for the escape sequence by changing the value of S Register 2.

You can change the length of the escape sequence guard time by changing the value of S Register 12.

Options

+++ Return to local command state

See Also

S Register 2 Escape Sequence Character

S Register 12 Escape Sequence Guard Time

**** Remote Access Sequence

When the modem is connected to a remote modem and is in on-line state, the remote modem may type this command to force the modem to enter Remote Access mode.

Remote Access mode simply means the remote modem will be able to issue AT commands to your modem, just as if you were typing them at your computer keyboard.

Remote Access mode may be switched on or off with the #A command. Remote Access mode is password protected by default.

To enter Remote Access mode, the operator of the remote modem should:

- Type: ****

The remote operator must wait one second before and after typing the Remote Access sequence. The AT command must not be typed in front of the Remote Access sequence, nor type a carriage return after it. You may change the character used in the Remote Access sequence by changing the value of S Register 67.

If the #A2 command has been issued to your modem, when it receives a request to enter Remote Access mode, it displays:

Enter Password:

on the computer screen of the remote operator. The remote operator must type your modem's security menu password and press ENTER. Each letter of the Remote Access password is displayed on the remote computer screen as # character.

If no password has been saved, remote access is denied.

If the password is successfully typed, the following prompt appear on the remote computer screen:

Remote Control Enabled

If the #A1 command has been issued, your modem does not ask for a password upon receiving the remote access sequence.

The remote operator may then type AT commands to the remote modem. The following commands are not allowed:

ATA, ATD, ATH, ATZ, AT&T

To exit Remote Access mode, the remote operator must:

- Type: ATO

Options

**** Request remote access

See Also

#A command Universal Remote Access
S Register 66 Remote Access Guard Time
S Register 67 Remote Access Character

AT? Interactive Command Help

Your modem will display information about the AT commands it supports if you type a question mark (?) in your AT command. You can view the modem help as 'pages' of information. This allows you to read the information at your own pace.

Press the Spacebar to view the next help page, Backspace or Delete to view the previous page, or ENTER to quit from the help pages.

You may also search for certain commands or words. S Registers 96 and 97 allow you to change the length and width of each help page to suit your communications software.

Options

- | | |
|--------------|---|
| AT? | Display a list of all the commands your modem supports (similar to the command summary in your Installation Guide). |
| AT?&T | Display a summary of the &T command. |
| AT?\N3%C2&D2 | Display summaries of the \N, %C and &D commands. |
| AT?MNP | Display all of the commands which affect MNP. |

See Also

- | | |
|---------------|--------------------|
| S Register 96 | Help Screen Length |
| S Register 97 | Help Screen Width |
| #H Command | Display Help |

A/ Repeat Last Command

This command orders the modem to re-execute the last command you entered. Unlike other commands, the Repeat Last Command should not be preceded by an AT, nor followed by a carriage return.

This command must be typed on one line by itself.

Options

A/ Repeat last command

ATA Answer

This command enables you to answer an incoming call manually. On receiving an incoming call, the modem will send a RING message code to your computer. When you see the ring message:

- Type: ATA <E>

Your modem will send an answer tone to the calling (originating) modem and wait to receive a carrier signal in return.

The B command selects which communication standards your modem will attempt to connect to.

If a connection cannot be established with the originating modem within the time specified in S Register 7, your modem will hang up and return a NO CARRIER message before returning to the local command state.

Options

ATA Answer an incoming call

See Also

B command	Select Communication Standard
S Register 0	Ring to Answer On
S Register 1	Current Ring Count
S Register 7	Wait Time for Carrier

ATBn Select Communications Standard

Your modem is capable of connecting to remote systems using a variety of communications standards. This command enables you to select the communications standards you want to use.

Command	Speed
B0 ■	Auto-Connect
B1	Auto-Connect
B2	Auto-Connect
B3	V.21 at 300bps
B4	Bell 103 at 300bps
B5	V.23 at 1200/75bps
B6	V.22 at 1200bps
B7	Bell 212A at 1200bps
B8	V.22bis at 2400bps
B9	Auto-Connect
B10	V.32 at 4800bps
B11	V.32 at 7200bps
B12	V.32 (Non-TCM) at 9600bps
B13	V.32 at 9600bps
B14	V.32bis at 12000bps
B15	V.32bis at 14400bps
B16	V.34 at 14,400bps
B17	V.34 at 16,800 bps
B18	V.34 at 19,200 bps
B19	V.34 at 21,600 bps
B20	V.34 at 24,000 bps
B21	V.34 at 26,400 bps
B22	V.34 at 28,800 bps
B23	31,200 bps
B24	33,600 bps
B25	(Reserved)
B26	(Reserved)
B27	V.34 at 2400bps
B28	V.34 at 4800bps
B29	V.34 at 7200bps
B30	V.34 at 9600bps
B31	V.34 at 12,000bps

B40	V.90 at 28,000bps
B41	V.90 at 29,333bps
B42	V.90 at 30,667bps
B43	V.90 at 32,000bps
B44	V.90 at 33,333bps
B45	V.90 at 34,667bps
B46	V.90 at 36,000bps
B47	V.90 at 37,333bps
B48	V.90 at 38,667bps
B49	V.90 at 40,000bps
B50	V.90 at 41,333bps
B51	V.90 at 42,667bps
B52	V.90 at 44,000bps
B53	V.90 at 43,333bps
B54	V.90 at 46,667bps
B55	V.90 at 48,000bps
B56	V.90 at 49,333bps
B57	V.90 at 50,667bps
B58	V.90 at 52,000bps
B59	V.90 at 53,333bps
B60	V.90 at 54,667bps
B61	V.90 at 56,000bps

Appending ! to the B command locks the modem to the specified speed e.g. ATB19! forces the modem to operate only at V.34 21,600bps

See Also

A Command	Answer
B Command	Select Communication Standard
D Command	Dial
+MS Command	

ATD Dial

This command allows you to dial a telephone number. The basic dialling command is:

ATD followed by the telephone number.

For example:

To dial the number (09) 111-1234

- Type: ATD091111234 <E>

You can use hyphens, spaces or parentheses. They will be ignored by the modem, but they will make it easier to read the command line.

For example:

ATD (09) 111-1234

☞ ***The D command must be the final command on a command line, unless you use the ; dial modifier.***

As well as digits, you may include the following characters when using tone dialling:

A B C D * #

Dial modifiers may be included in the dial command.

Example

ATD12345 Dial number 12345

See Also

S Register 6	Dial Tone Wait Time
S Register 8	Pause Dial Modifier Delay

Dial Modifiers

Dial modifiers enable you to change the characteristics of dialling.

(Definitions for all modifiers appear on the following pages.)

Modifier Meaning

,	pause
;	return to local command state
R	reverse mode
@	wait for quiet answer
J	initiate MNP 10 at 1200 bps
M	initiate MNP 10 at 4800 bps
K	MNP 10 cellular option
L	last number redial
F or ^	disable calling tones
!	hook flash
S=n	dial stored phone number n
W	wait for dial tone

, **Pause**

This modifier orders the modem to pause before dialling the rest of the phone number. This is useful when using a PABX and you need to dial a number to connect to an outside line.

For example: If you must dial 0 to connect to an outside line before dialling (09) 111-1234

- Type: ATD0,091111234 <E>

The length of the pause is determined by the value in S Register 8.

☞ UK Modems. If your PABX requires more than four seconds to obtain a line, add no more than one extra , to your dial command.

; **return to local command state**

This modifier orders the modem to return to local command state — without disconnecting — after it has dialled the number.

You may use this modifier to communicate with a mainframe computer using security callback. Your modem dials the number of the mainframe computer and then immediately returns to local command state. Another ATD command can then be used to generate the tones required for the callback identity number.

The ; used in conjunction with the M2 command, allows you to return to local command state with the speaker turned on, allowing you to monitor the progress of the call at the remote modem.

R reverse mode

This modifier enables you to switch to answer mode after dialling. When connecting to another modem, one modem must be in originate mode and the other in answer mode to establish a connection. When you use a dial command, your modem is normally in the originate mode.

The R dial modifier enables you to connect to originate only modems. This is also useful when you want to send information at 1200/75 bps (CCITT V.23 standard communications).

If you communicate with another computer in originate mode at 1200/75 bps, you will be sending data at 75 bps and receiving at 1200 bps. If you have a lot of information to send and not much to receive, it makes sense to switch to answer mode, so that you are sending at the faster rate.

For example:

To dial the number 999-9876 and switch to answer mode:

- Type: ATD9999876R <E>

@ wait for quiet answer

The @ modifier orders the modem to wait for one or more rings within the time specified by S

Register 7, followed by a period of five seconds of silence occurring some time before dialling the remaining numbers in a phone number.

The default value of S Register 7 is 30. Using this default, the modem will dial the first number, listen for a period of five seconds silence during the next 30 seconds and then, if the silence is detected, dial the next part of the number.

If five seconds of continuous silence is not detected, the modem will hang up and return a message: NO ANSWER If the phone number is engaged, the modem will return a message: BUSY This modifier is useful for remote access databases which require an identification code to be tone dialled before those databases generate an answer tone.

For example:

To tone dial a remote database on 999-1234, wait for a five-second silence and then tone dial an ID code of 1234:

- Type: ATDT9991234@1234 <E>

J initiate MNP 10 at 1200 bps

This modifier allows you to select MNP 10 and make the initial connection at 1200 bps (V.22). MNP 10 is able to automatically adjust the line speed to suit the quality of the phone line. Refer to the chapter titled 'Error Correction' for details of MNP 10.

For example:

To dial the number 999-9876 using MNP10:

- Type: ATDJ9999876 <E>M initiate MNP 10 at 4800 bps

This modifier allows you to select MNP 10 and make the initial connection at 4800 bps (V.32). MNP 10 is able to automatically adjust the line speed to suit the quality of the phone line.

For example:

- Type: ATDM9999876 <E>

K MNP 10 Cellular Option

The K dial modifier allows MNP 10 automatic power level adjustment for this call only. Normally MNP 10 power level adjustment is switched on and off with the)M command.

F or ^ disable calling tones

The F dial modifier (or the dial modifier ^) allows you to switch off calling tones for a data call.

L last number redial

This modifier allows the last number dialled to be re-dialled. The L can be used as a modifier

after a number prefix (but cannot have any number following). The last number dialled is saved in NVRAM. The last number dialled is displayed on the &V display.

For example:

- Type: ATD9999876 <E>

ATDL will dial 9999876

- Type: ATDT02L <E>

This will set tone mode, then dial 02 and then 9999876

! hook flash

The ! dial modifier issues a hook flash signal — the modem hangs up for a short period.

Hook flashes are commonly used with PABXs to transfer calls.

For example:

To dial 0, hook flash and then dial 12345:

- Type: ATD0!12345 <E>

☞ **UK Modems. Use of the hook flash is not allowed in the United Kingdom. SRegister 29 sets the duration of the hook flash.**

S=n dial stored phone number n

The modem allows you to store phone numbers in non-volatile memory. The S dial modifier enables you to dial these phone numbers. The n indicates which stored number you want to dial. To store numbers, use the &Z command. Refer to your Product Guide for information regarding how many phone numbers your modem can store.

For example:

To dial the stored number two:

- Type ATDS=2 <E>

W wait for dial tone

The W modifier causes the modem to wait for a dial tone before dialling. If the modem does not detect a dial tone within 30 seconds, it returns a message of NO DIALTONE, hangs up and returns to local command state.

You can change the dial tone waiting period from the default period of 30 seconds by changing the value in S Register 7.

- ☞ **When using the W modifier, the length of time your modem waits for a dial tone is determined by the value contained in S Register 7 (Wait for Carrier) and not the value in S Register 6 (Wait for Dial Tone).**
- ☞ **UK Modems. Setting S Register 7 with a value above 58 may invalidate the approval of your modem. S Register 7 must be set to 20 before issuing the W dial modifier.**

If the modem received any characters from the computer while it is waiting for a dial tone, it will hang up, return to local command state and send a NO CARRIER message.

For example:

To wait for a dial tone and then dial 111-0123:

- Type: ATDW1110123 <E>

See Also

&Z Command	Store Phone Number
S Register 6	Wait Time for Dial Tone
S Register 7	Wait Time for Carrier
S Register 8	Length of Dial Pause
S Register 29	Hook Flash Duration

ATE Echo

The E commands enables you to select whether the characters you type at your keyboard (while in the local command state) will be echoed back to the screen by the modem.

Options

- | | |
|--------|----------------------------------|
| ATE0 | Disable local command state echo |
| ATE1 ■ | Enable local command state echo |

Range

0-1

ATH Hang Up

The H command forces the modem to hang up.

The H0 command (Hang up) is used to terminate a call.

The H1 command (Go off-hook) can be used to make your modem appear as busy to a remote modem trying to dial in.

When you issue the H1 command, the modem goes off-hook but will not generate carrier or answer tones.

The H2 command causes the modem to go off-hook after the current connection terminates. This is used to take a modem out of service without interrupting the current connection.

Options

ATH0	Hang up
ATH1	Go off-hook
ATH2	Go off-hook after current connection terminates

Range

0-2

ATI Identity

Your modem contains a product identity code, also known as the firmware identity code. You can use the I command to display these codes.

Options

ATI0	Display numeric identity code
ATI1	Return a checksum of modem's firmware
ATI3	Display model identifier
ATI4	Display code revision and creation date
ATI5	Display manufacturer identification
ATI9	Display complete product identification
ATI10	Display modem statistics

Range

0-1, 3-5, 9, 10

ATL Speaker Volume Control

Your modem has a volume control which allows you to adjust the volume of its internal speaker.

Your modem is preset for comfortable listening levels in a normal office environment, so most users will not need to change the preset volume of their modem.

There are four speaker volume levels:

- 0 Lowest volume level
- 1 Low volume level
- 2 Medium level
- 3 Highest volume level

To adjust the volume level:

- Type: ATL0 <E>
(or type 1,2,3 as appropriate)

Options

ATL0	Lowest volume level
ATL1	Low volume level
ATL2 ■	Medium level
ATL3	Highest volume level

Range

0-3

See Also

M Command Monitor

ATM Monitor

Your modem has a built-in speaker enabling you to monitor the progress of calls. You can listen for dial tones, busy signals, a successful connection to another modem, or someone answering your call.

The M command controls the operation of the speaker.

☛ *Some modems also provide volume control via the L command.*

Options

ATM0	Speaker is always off
ATM1 ■	Speaker is on whenever the modem is dialling or answering a call. When a connection is established, the speaker is switched off
ATM2	Speaker is always on
ATM3	Speaker is off whenever the modem is dialling or once a connection is established
ATM4	Speaker is on whenever the modem is dialling or answering. The speaker will also be on during retrains or rate changes.

Range

0-4

See Also

L Command Speaker Volume Control

ATO Return to On-line State

The O command enables you to return to on-line state from command state. When you are on-line (connected to a remote computer), anything you type is treated as data by your modem. If you want to send commands to your modem, you must return to local command state by typing the escape sequence (+++). When you are ready to return to on-line state, use the O command. If you are off line (modem is on hook) when you are use an ATO command, the modem will go off hook and attempt to connect in answer mode.

☛ ***The O command must be the last command on the command line. If you have established a connection at greater than 1200bps and are encountering a large number of data errors in your communications, use the ATO1 command to go on line and force an equaliser retrain. (An equaliser retrain conditions the phone line frequencies to reduce the levels of interference and improve data transmission.)***

☛ ***Retrains cannot overcome noise on the line.***

Options

ATO0	Enter on-line state
ATO1	Enter on-line state and force equaliser retrain (2400bps and higher speeds only)
ATO2	Retrain, not on-line (2400bps & higher speeds only)
ATO3	Change line speed to 4800 bps (V.32bis/V.34)
ATO4	Change line speed to 7200 bps (V.32bis/V.34)
ATO5	Change line speed to 9600 bps (V.32bis/V.34)
ATO6	Change line speed to 12,000 bps (V.32bis/V.34)
ATO7	Change line speed to 14,400 bps (V.32bis/V.34)
ATO8	Change line speed to 16,800 bps (V.34)
ATO9	Change line speed to 19,200 bps (V.34)
ATO10	Change line speed to 21,600 bps (V.34)
ATO11	Change line speed to 24,000 bps (V.34)
ATO12	Change line speed to 26,400 bps (V.34)
ATO13	Change line speed to 28,800 bps (V.34)
ATO14	Change line speed to 32,000 bps (V.34)
ATO15	Change line speed to 33,600 bps (V.34)
ATO23	Change line speed to 4800 bps (V.32bis/V.34)
ATO24	Change line speed to 7200 bps (V.32bis/V.34)
ATO25	Change line speed to 9600 bps (V.32bis/V.34)
ATO66	Change line speed to 12,000 bps (V.32bis/V.34)

ATO27	Change line speed to 14,400 bps (V.32bis/V.34)
ATO28	Change line speed to 16,800 bps (V.32bis/V.34)
ATO29	Change line speed to 19,200 bps (V.32bis/V.34)
ATO30	Change line speed to 21,600 bps (V.32bis/V.34)
ATO31	Change line speed to 24,000 bps (V.32bis/V.34)
ATO32	Change line speed to 26,400 bps (V.32bis/V.34)
ATO33	Change line speed to 28,800 bps (V.32bis/V.34)
ATO34	Change line speed to 32,000 bps (V.32bis/V.34)
ATO35	Change line speed to 33,600 bps (V.32bis/V.34)

Range

0-35

ATQ Quiet (Suppress Response Codes)

Your modem has a variety of messages or response codes which it sends in response to various commands.

Examples of these codes are the OK and CONNECT messages.

The Q command allows you to switch these messages on and off. If you switch the messages off, no response codes will be displayed on your screen — with the exception of responses from the ATSn? command and AT&V command.

Options

ATQ0 ■	Send response codes to the screen
ATQ1	Do not send response codes to the screen
ATQ2	Modem does not return RINGING, CONNECT or NO CARRIER messages when in answer mode.

Range

0-2

See Also

Sn? command	Display S Register Value
V command	Verbal Response Codes
X command	Extended Response Codes
SRegister 95	Extended Response Codes

ATR Set Terminal Speed

The R command allows you to switch off “autobauding” and specify the terminal speed at which your modem operates.

Normally your modem uses autobauding, meaning that when you issue commands to your modem, it automatically detects the speed at which you issue the commands and changes its terminal speed to match your computers terminal speed. For example, if your computer is set to a terminal speed of 9,600 bps and you change it to 19,200 bps, when you next issue an AT command to the modem, the modem detects the command was issued at 19,200 bps and changes its terminal speed (that is, the modems terminal speed) to 19,200 bps.

When autobauding is switched off, your modem does not change its terminal speed to match your computers terminal speed. For example, if you set your modem to use a fixed terminal speed of 26,400 bps, all AT commands must be issued to the modem at 26,400 bps. If you issue commands to your modem at another speed, the modem will not accept the commands.

When using locked speeds or autobauding at 230kbps, the character format and parity is specified by the AT+ICF command. the default is 8 bits, no parity.

Your modem can autobaud at 1,200 bps through to 230,400 bps.

☛ ***IBM PC and compatible computers cannot support some of the high speeds provided by your modem. If you wish to use terminal speeds above 19,200 bps, we recommend you install a serial card fitted with 16550 chip. This ensures reliable operation at high speeds when used with the correct drivers and software setup.***

If you wish to set your computer terminal speed to another speed, you must issue the appropriate R command immediately prior to setting the computers terminal speed.

Options

ATR0 ■	Autobaud enabled
ATR1	1200 bps (locked terminal speed - no autobaud)
ATR2	2400 bps (locked terminal speed - no autobaud)
ATR4	4800 bps (locked terminal speed - no autobaud)
ATR7	7200 bps (locked terminal speed - no autobaud)
ATR9	9600 bps (locked terminal speed - no autobaud)
ATR12	12,000 bps (locked terminal speed - no autobaud)
ATR14	14,400 bps (locked terminal speed - no autobaud)
ATR16	16,800 bps (locked terminal speed - no autobaud)
ATR19	19,200 bps (locked terminal speed - no autobaud)
ATR21	21,600 bps (locked terminal speed - no autobaud)
ATR24	24,000 bps (locked terminal speed - no autobaud)

ATR26	26,400 bps (locked terminal speed - no autobaud)
ATR28	28,800 bps (locked terminal speed - no autobaud)
ATR38	38,400 bps (locked terminal speed - no autobaud)
ATR57	57,600 bps (locked terminal speed - no autobaud)
ATR76	76,800 bps (locked terminal speed - no autobaud)
ATR96	96,000 bps (locked terminal speed - no autobaud)
ATR115	115,200 bps (locked terminal speed - no autobaud)
ATR230	230,400 bps (locked terminal speed - no autobaud)
ATR460	460,800 bps (locked terminal speed - no autobaud)

K56 modems can autobaud at 115kbps and 230kbps.

☛ ***At 230kbps the modem cannot autobaud with parity. If you wish to use parity at 230kbps, use the AT+ICF command to set the format and parity.***

Range

0, 1, 2, 4, 7, 9, 12, 14, 16, 19, 21, 24, 26, 28, 38, 57, 76, 96, 115, 230, 460

See Also

+ICF command Character Framing & Parity

ATSn? Display S Register Value

The Sn? command allows you to read the value in a particular Special Register (S Register).

The command is in the form:

ATSn?

where n is the number of the S Register you want to read.

For example:

The number of times the modem will allow the phone to ring before answering an incoming call is determined by the value in S Register 0. To see the current value of this register:

- Type: AT\$0? <E>

Options

ATS2? Display the value contained in S Register 2

See Also

Sn= command Set S Register Value

&V command View Configuration Profile

ATS_n= Set S Register Value

The S_n= commands enables you to change the value in a Special Register (S Register).

The format for the command is:

ATS_n=x

where n is the number of the S Register whose value you wish to change and x is the value you wish to place in the register.

For example:

The character interpreted as being a carriage return, is determined by the value in S Register 3.

The default value of this register is 13. To change this value to 15:

- Type: ATS3=15 <E>

It is important to alter values only in those S Registers listed for your modem. Placing a value in any other S Register can have unforeseen consequences. Default values and the permissible range of values for each S Register are detailed in the S Register section of this guide.

Options

ATS2=2 Set S Register 2 with a value of 2

See Also

Sn? command Display S Register Value

ATV Verbal Response Codes

Your modem can display either verbal or numeric response codes in response to various commands.

The V command enables you to select which type of response code you want to display.

Basic response codes common to all modems are:

Verbal	Numeric	Meaning
OK	0	Command accepted and executed
CONNECT	1	Carrier detected and connection established
RING	2	Ringing signal detected
NO CARRIER	3	Carrier lost or not detected
ERROR	4	Error in command string or command line longer than 80 characters or S69 time out

Options

ATV0 Numeric response codes

ATV1 ■ Verbal response codes

Range

0-1

See Also

X command	Extended Response Codes
Q command	Quiet (Suppress Response Codes)
\W command	Error Correction Response Codes
SRegister 95	Extended Response Codes

☛ **Refer to the Response Codes table.**

ATW Connection Speed Information

The W command allows you to decide whether your modem will report its line speed or terminal speed when it connects to another modem.

Options

ATW0	The CONNECT message reports the terminal speed
ATW1	The CONNECT message reports the terminal speed
ATW2 ■	The CONNECT message reports the line speed

Range

0-2

See Also

V command	Verbal Response Codes
X command	Extended Response Codes
SRegister 95	Extended Response Codes

ATX Extended Response Codes

The X command enables you to choose which response codes will be displayed. The basic response codes for all modems are:

Verbal	Numeric	Meaning
OK	0	Command accepted and executed
CONNECT	1	Carrier detected and connection established
RING	2	Ringing signal detected
NO CARRIER	3	Carrier lost or not detected
ERROR	4	Error in command or command line longer than 80 characters or S69 time out

Depending on the modem you are using, other extended response codes are also available.

For example:

All modems which can operate at 1200 bps or 1200/75 bps use response code 5 (CONNECT 1200), and those operating at 2400 bps use response code 10 (CONNECT 2400).

You can choose to display only basic response codes or you can display sets of extended response codes, depending on the capabilities of your modem.

☛ **Response Code 8 (NO ANSWER) is controlled by the Wait For Quiet Answer dial modifier. /REL Response Codes appear only if \V1, \V8, or \V9 is selected.**

☛ **X0, X1, X3 & X6 disables dial tone detection. This allows you to dial when there is no dial tone or the dial tone is not standard.**

X0, X1 & X2 disable busy detection. If a busy signal is received it is ignored. The modem will hangup after 57 seconds.

Options

ATX0	Display extended response codes(0-4) only
ATX1	Display extended response codes (0-5,10-12,30-40,60-62)
ATX2	Display extended response codes (0-6,10-12,30-40,60-62)
ATX3	Display extended response codes (0-5,7,10-12,30-40,60-62)
ATX4	Display extended response codes (0-7,10-12,30-40,60-62)
ATX5 ■	Display extended response codes (0-7,10-13,30-40,60-62)
ATX6	Display extended response codes (0-5, 7-8, 10-13, 30-40,60-62)

Range

See Also

Q command	Quiet (Suppress Response Codes)
V command	Verbal Response Codes
W command	Connection Speed Information
\V command	Error Correction Response Codes
%U command	V.42 Response Codes
S Register 95	Extended Response Codes

ATZn Restore Configuration Profile

Your modem is supplied with a default operating set up. You can change this temporarily by issuing commands while you are working, or permanently by using the &Wn command to store profiles you've made in non-volatile memory (where n=profile 0,1,2 or 3).

The Zn command returns the modem to saved configuration profile n. For example: If you have saved a configuration into profile 2 by using &W2, you can restore the modem to the values contained in saved configuration 2 by:

- Type: ATZ2 <E>

To restore factory defaults use the &F command.

☞ **The Zn command must be the last command on a line.**

Options

ATZ0	Restore active configuration from stored profile 0
ATZ1	Restore active configuration from stored profile 1
ATZ2	Restore active configuration from stored profile 2
ATZ3	Restore active configuration from stored profile 3

See Also

&Wn command	Write Configuration
&F command	Restore Factory Defaults
&F. command	Reinitialise modem
&V command	View Active Configuration

AT&B Character Length

The &B command allows the modem to use character lengths of 8, 9, 10 or 11 bits.

☛ *The modem will only match the speed of your computer when 10-bit or 11-bit characters are selected.*

Range

0-4

Options

AT&B0	8 bit characters
AT&B1	9 bit characters
AT&B2	10 bit characters
AT&B3	11 bit characters
AT&B4 ■	Use 10 or 11-bit format as detected by autobaud

AT&C Controlling Data Carrier Detect

The &C command enables you to control how DCD will operate. DCD is a RS-232 interface signal from the modem to a remote device, such as a terminal or a computer, indicating that the modem is receiving a carrier signal from a remote modem. This signal is switched on (asserted) when your modem is receiving a valid carrier signal from a remote modem. The &C3 option allows a connection that was commenced as a voice call to switch to fax or data mode without an interruption to the DCD signal (which might cause the application to think that the line has been lost).

☞ **The &C command will only have effect when the DCD option switch is in the UP position and %T0 is selected. (Refer to the Dumb Mode Section for details.)**

Options

AT&C0	DCD signal is always asserted
AT&C1 ■	DCD signal responds to remote modem
AT&C2	DCD signal always on, pulses low on disconnect
AT&C3	DCD asserted during voice session

☞ **We recommend &C2 for UNIX computers which require DCD to be asserted when issuing commands to the modem.**

Range

0-3

See Also

S Register 9	Carrier Detect Response Time
S Register 10	Lost Carrier/Hang Up Delay
%T	DCD Control
	Dumb Mode Switches
%P	Connect Message Timing

AT&D Controlling Data Terminal Ready

The DTR signal is used to indicate to the modem whether your computer is ready to communicate.

☞ **The &D command will only take effect when the DTR option switch is in the UP position and %S0 is selected. (See the Dumb Mode Section for details.)**

Options

AT&D0	The modem ignores the DTR signal and acts as if it is asserted (the modem assumes the computer is ready to communicate).
AT&D1	The modem will return to on line command state if DTR is lowered during a connection.
AT&D2 ■	The modem will hang up, return to local command state and disable auto-answer whilst DTR is low (is not asserted). To enable auto-answer, the DTR signal must be asserted. The computer must assert DTR before dialling or answering may commence.
AT&D3	If DTR is lowered, the modem will hang up, return to local command state and initialise itself with the values stored in the &Y profile.
AT&D4	The modem will hang up, return to local command state and go off-hook. It will remain off-hook whilst DTR is low.

☞ **S Register 25 determines how long DTR must be low before the modem recognises it as such.**

☞ **S Register 57 determines how long DTR must be high before the modem recognises it as such.**

Range

0-4

See Also

S 25, S 57 DTR Detection Times

AT&F. Reinitialise Modem

The &F. command will completely re-initialise your modem. This command will delete stored phone numbers, security, and encryption settings. We recommend you execute this command immediately after installing your modem.

All of the stored profiles in non-volatile memory will be restored to factory defaults.

- Type: AT&F.

Do not press ENTER

A message will be displayed: OK

If you do not receive this message, re-check the connection of your modem to your computer. Repeat the command. If the message still does not appear, contact your dealer.

☞ The Security Database will not be cleared by the &F. if the Security

Lock feature is enabled.

Options

AT&F. Total reinitialisation

See Also

#S Command Security Menu Options

AT&F Restore Factory Defaults

Your modem comes with factory default settings for all communications settings and S Registers. The &F command enables you to restore the factory default values to the command settings and S Registers. This command does not reset stored phone numbers, security, or encryption settings.

The &F1 command selects non-error correction factory defaults. The defaults selected are:

```
X0 &K0 &D2 \N1 %C0
```

The &F2 command selects synchronous mode factory defaults. The defaults selected are:

```
B13 E0 Q1 &M2
```

You must use the &W command if you wish to save the default values to nonvolatile memory, and thus preserve these values when you switch the modem off.

☞ If you issue the &F command while the modem is off-hook, an ERROR message will be returned.

Options

AT&F0	Restore Command and S Registers to Factory Defaults
AT&F1	Select non-error correction factory defaults
AT&F2	Select synchronous mode factory defaults

See Also

&V command	View the Active Configuration
Z command	Restore Configuration
&W command	Save Configuration

AT&G Guard Tone

The &G command controls the generation of guard tones.

A guard tone is a predetermined frequency generated by the modem to supervise the communications path.

The &G command only affects V.22 and V.22bis connections.

Options

AT&G0 ■	Do not generate guard tones
AT&G1	Generate guard tones of 550Hz
AT&G2	Generate guard tones of 1800Hz

Range

0-2

AT&H Clock Control

The &H command determines when clocks will be applied to the 'RxC' RS-232 signal.

With &H0 selected, the RxC signal will be active whenever a synchronous mode is selected.

With &H1 selected, the clock will only be present after a connection has been established to another modem.

Options

- AT&H0 ■ Clock always present in synchronous mode
- AT&H1 Clock only appears after connection

Range

0-1

AT&K Flow Control

The &K command enables you to select the type of flow control used between your modem and the local computer when asynchronous mode is selected. You may want to do this to prevent possible data loss resulting from buffer overflow.

Using flow control guarantees that data buffers in your modem and computer won't overflow. Your modem and your terminal or computer must be using the same type of flow control.

☞ **Flow control is only available when your modem is configured for constant speed mode or reliable or auto-reliable modes and is operating in on-line state.**

Flow control will be ignored when your modem is configured for variable speed mode (AT\N1) or is in local command state.

WARNING

XON/XOFF flow control must not be selected when you are using XModem, YModem and SEALink file transfers. XON/XOFF flow interferes with the operation of these file transfer protocols and will cause unreliable operation.

Options

AT&K0	Flow control disabled
AT&K3 ■	RTS/CTS (hardware) flow control The modem and computer use the CTS (Clear to Send) and RTS (Request to Send) signals on the RS-232 serial connection to control data flow.
AT&K4	XON/XOFF (software) flow control The modem and computer use the XON and XOFF characters (DC1 and DC3) to control the flow of data.
AT&K5	Transparent XON/XOFF flow control The modem and computer encode and decode XON and XOFF characters which are part of the data stream. Transparent XON/XOFF provides reliable operation when using file transfer protocols.
AT&K9	Failsafe flow control When the modem's data buffer approaches maximum capacity, the modem will lower the CTS signal. If the computer subsequently sends more than 60 (S82) characters to the modem, the modem will send an XOFF character to the computer. When the modem is ready to accept more data from the computer it will assert CTS and, if an XOFF was sent by the modem, will send an XON character to the computer. Failsafe flow control only affects data being transmitted from the computer to the modem. Flow control is not supported for data being transmitted by

the modem to the computer.

Range

0, 3-5, 9

See Also

\N command	Operating Mode
\Q command	Extended Flow Control
S Register 80	Flow Control High Water Mark
S Register 81	Flow Control Low Water Mark
S Register 82	Failsafe Flow Control Overrun

AT&L Leased Line

The &L command allows you to specify whether your modem will be connecting over the public switched telephone network (PSTN) or leased lines (point-to-point connection).

When the leased-line mode is selected, if the carrier from the remote modem is lost, the modem will continuously attempt to re-establish a connection.

If you select leased line operation with the &L1 command, you must issue the ATA command to answer a call, and the ATD command to initiate a call.

If you use the &L2 or &L3 command to select Auto leased line operation, you do not need to issue the ATA or ATD commands; &L2 selects Originate mode automatically and &L3 selects Answer mode automatically. The modem's TALK/DATA switch must be set to DATA and DTR must be raised to make the modem go off-hook and DTR lowered (or the TALK/DATA switch is set to TALK) to return to local command state.

☞ ***If your modem has a TALK/DATA switch, it must be set to DATA when using &L2 or &L3.***

See the section — Leased Line Operations — for a detailed explanation of the &L command and leased line operations.

☞ ***UK Modems. Warning. Please ensure that the &L1, &L2 or &L3 command is issued prior to establishing a connection across leased line circuits.***

Options

AT&L0 ■	PSTN mode
AT&L1	Leased-line mode
AT&L2	Auto leased line Originate mode
AT&L3	Auto leased line Answer mode

Range

0-3

AT&M Synchronous/Asynchronous Mode

The &M command enables you to select either asynchronous or synchronous operation.

During asynchronous transmissions, the time between characters being sent may vary, and the characters are delimited by start and stop bits to co-ordinate data transfer.

During synchronous transmissions, the interval between the transmission of each character is of equal length, controlled by clock signals.

Synchronous transmission is most commonly used in communications involving mainframe computers.

Options

- AT&M0** ■ Asynchronous mode
The modem will dial and answer in the asynchronous mode and then enter asynchronous on-line state when a connection is established.
- AT&M1** Synchronous mode with asynchronous dialling
The modem remains in asynchronous mode while it is on-hook, dialling or answering. When a connection is established, the modem automatically switches to synchronous operation.
- AT&M2** Synchronous mode with dialling invoked by the DTR signal
The modem remains in asynchronous mode while it is on-hook, dialling or answering.
You must issue the AT&D2 command prior to using this synchronous mode.
When your local computer asserts the DTR (Data Terminal Ready) signal, the modem will dial stored phone number zero (see the &Zn command).
When an incoming call is detected, the modem will attempt to answer it as soon as the DTR signal is asserted and the number of rings specified in S Register 0 is reached.
As soon as a connection is established, the modem automatically switches to synchronous operation.
If DTR is lowered at any time, the modem will hang up.
- AT&M4** Asynchronous mode with dialling invoked by the DTR signal
When your computer asserts the DTR signal, the modem will dial stored phone number zero (see &Zn command).
You must issue the AT&D2 command prior to using this synchronous mode.
When an incoming call is detected, the modem will attempt to answer it as soon as the DTR signal is asserted and the number of rings specified in S Register 0 is reached.
If DTR is lowered at any time, the modem will hang up.

Range

0-2, 4

See Also

&D command	Controlling DTR
&X command	Synchronous Clocks
&Z command	Stored Phone Number

AT&N Abort Connection

The &N command determines whether the modem will abort the attempt to make a connection if sent a character by the computer.

You can abort connection by either lowering the DTR (Data Terminal Ready) signal, or by sending a character (except a null or line feed character) to the modem.

☞ ***If you have used the &N0 command and the DTR Option switch is in the down position, you will not be able to abort dialling after the D (Dial) command is issued.***

Options

AT&N0	Disable abort connection
AT&N1 ■	Enable abort connection

Range

0-1

AT&R RTS/CTS Control

The &R command allows you to determine the relationship between the RTS (Request to Send) and CTS (Clear to Send) signals, when operating in synchronous mode.

The &R command is ignored whenever asynchronous mode is selected.

%R1 overrides the &R command.

Options

AT&R0 ■ CTS follows RTS when the modem is on line.

AT&R1 CTS is always asserted.

Range

0-1

See Also

%R command CTS Override

AT&S Controlling DSR

The &S command allows the modem to control the state of the DSR (Data Set Ready) signal.

This command will only take effect when the DSR option switch is in the UP position (see your Dumb Mode Section for details).

%S overrides the &S command.

Options

AT&S0 ■	DSR signal will always be asserted
AT&S1	DSR signal asserted at the start of handshake
AT&S2	DSR signal asserted at end of handshake (before CONNECT message)

Range

0-2

See Also

%S command DSR Control

AT&Vn View Active Configuration Profile

The &V command allows you to view the active configuration profile of your modem.

This shows the settings of AT commands and S Registers. Not all AT commands and S Registers will be shown. For example, the commands which relate to V.25bis operation will only appear when V.25bis mode is selected.

&V0 - &V3 displays the contents of stored profiles 0 to 3 respectively

☞ *For this command &V is different from &V0*

☞ *The &V command must be the last command on the command line.*

Options

AT&V	View active configuration profile
AT&V0	View stored configuration profile 0
AT&V1	View stored configuration profile 1
AT&V2	View stored configuration profile 2
AT&V3	View stored configuration profile 3
AT&V8	View differences between active configuration and default settings of the S Registers

Range

0-1, 3-8

See Also

S Register 96	Help Page Width
S Register 97	Help Page Length

Range

0-3, 8

AT&Wn Write Configuration Parameters

The &Wn command allows you to save the current configuration profile including communications settings and S Register values into 1 of 4 stored profiles in the modem's non-volatile memory.

The values contained in the modem's non-volatile memory specified by the &Y command will be loaded when the modem is next switched on.

The &Zn command restores the specified profile to the active configuration. See the topics of S Register Settings and Modem Memory in the S Register section of this Guide for a description of the different types of memory in your modem and how they function.

Options

AT&W0	Save current configuration into profile 0
AT&W1	Save current configuration into profile 1
AT&W2	Save current configuration into profile 2
AT&W3	Save current configuration into profile 3

See Also

Sn=x command	Set S Register
Zn command	Restore active profile from stored configuration
&Y command	Select Power-up Profile

Range

0-3

AT&X Transmit Clock

The &X command nominates the source of its transmit clock signal when operating in synchronous mode.

The receive clock is always derived from the receive (remote) carrier signal.

Options

- AT&X0 ■ Synchronous clocks generated by Modem.
The modem generates the transmit clock and applies it to pin 15 of the RS-232 socket
- AT&X1 Clocks generated by computer - external clocking.
The clock generated by the computer or terminal (received on pin 24 of the RS-232 socket) is directly applied to pin 15. This is known as external clocking.
- AT&X2 Clocks generated by remote system - slave clocking.
The receive clock (derived from the incoming carrier signal) is applied to pin 15 of the RS-232 socket. This is known as slave clocking.

See Also

&M command Synchronous/Asynchronous Mode

Range

0-2

AT&Yn Select Stored Profile on Power Up

The &Yn command determines which stored (User) profile is selected as the Active profile when the modem is switched on and also when &D3 is selected and DTR drops.

Options

AT&Y0	Select stored profile 0 on power up
AT&Y1	Select stored profile 1 on power up
AT&Y2	Select stored profile 2 on power up
AT&Y3	Select stored profile 3 on power up

Range

0-3

AT&Z Stored Phone Number

The &Z command enables you to store phone numbers in your modem's nonvolatile memory. The command takes the form &Zn=x, where x is the phone number you want to store and n indicates which of the stored phone numbers it will be saved as. Stored numbers may contain up to 20 characters, including dial modifiers.

Do not include, in the stored phone number:

- an AT
- a D (Dial) command
- an S (Stored number) dial modifier

If you are using synchronous mode 2, do not use the ; (return to local command state) dial modifier in the number.

The stored phone numbers are displayed by the &V display.

Options

AT&Z2=12345

Store the phone number 12345 as stored phone number two

AT&Z4=P0,T12345

Store the following as stored number four; first pulse dial 0, wait for two seconds to get an outside line and then tone dial 12345

See Also

- D command Dial (and S dial modifier)
- &M2 command
- &M4 command
- &V command View Active Configuration Profile

Range

0-9

AT#A Universal Remote Access

This command allows a controlling modem to take control of a remote modem. All commands of the remote modem(s) are available to the controlling modem, with the exception of the Test commands. (DES keys can be changed and will take effect from the next connection made to the modem.)

To initiate remote access, the user of the controlling modem should:

- Type: **** (the remote access sequence)
(with 1.0 sec guard time before and after the ****)

If #A2 has been set, after receiving the remote access sequence, the remote modem will send back a request to enter password. The password it is expecting is its security menu password (see #S command). If no password has been defined, remote access is disabled.

If the password you type is incorrect, the following message appears:

Incorrect. Please try again

You must re-initiate the remote access by typing the remote access sequence again before you can re-type the password.

If the password you type is correct, the following message will be displayed:

Remote control enabled

To terminate the remote control, the user of the controlling modem should, while in on-line state:

- Type: ATO <E>

Guard time can be adjusted by changing the value in S Register 66 (default 1 second). The remote access character is specified in S Register 67. The default value is 42 — the asterisk (*) character.

☞ **AT#A2 is only available if your modem supports the security menu (#S).**

Options

AT#A0	Prevent remote access
AT#A1	Allow remote access
AT#A2 ■	Allow remote access with security password

☞ **If your product does not have security features, the default is # A0**

See Also

****	Remote Access Sequence
#S command	Security Menu
S Register 66	Remote access guard time
S Register 67	Remote access character

Range

0-2

AT#B 1200bps Originate Mode

The #B command determines whether the modem will use V.23 or V.22 for its 1200 bps originate speed when B0 or B2 is selected.

By default, your modem will use V.23 as its 1200 bps connection standard with B0 selected and V.22 with B2. #B1 reverses these settings.

Options

AT#B0 ■ B0 = V.23 B2 = V.22

AT#B1 B0 = V.22 B2 = V.23

See Also

B command Select Communications Standards

Range

0-1

AT#C V.25 Calling Tones

The #C command determines whether the modem will generate V.25 calling tones when operating in originate mode.

V.25 calling tones are generated as a measure of courtesy if the telephone number you dial is answered by a person rather than a modem or other electronic device. It also allows an electronic device to select the appropriate operating mode.

V.25 tones indicate to the answerer of a call that a modem in data mode (not fax) is the originator of the call.

Options

AT#C0	V.25 calling tones disabled
AT#C1 ■	V.25 calling tones enabled

See Also

X command	Response codes
D command	F or ^ dial modifiers

Range

0-1

AT#CID Caller ID

The #CID command allows the user can set up the modem to display the number of all inbound calls and selectively answer or not answer the call depending on whether the caller is known. The modem can also be programmed to play a unique 'tune' if the caller is known.

When enabled a message will be inserted between the 1st and 2nd RING responses from the modem.

The message will be in the form:

DATE = mmdd	where mm is the month number (01 to 12) and dd is the day number (01-31)
TIME = hhmm	where hh is the hour number (00 to 23) and mm is the minute number (00-59)
NMBR = nnn...nnn	where nnn...nnn is the calling number. If the number is private the number is reported as 'P' if the network was unable to supply the number the number is reported as 'O'
NAME = ttt...ttt	where ttt...ttt is the name of the caller, if supplied by the network or if saved in the security database. This format is compatible with standard Rockwell modem responses. If the extended response option is selected (AT#CID3) the following messages are also available:
REASON NO NAME=<message>	where message is 'Out Of Area' or 'Private' is displayed if the network does not provide a name
QUAL = Long Distance	is displayed if the call is long distance
REDIRECT = <message>	where message can be 'Call Forward' or 'Call Forward: First Number Busy' or 'Call Forward: First Number Didn't Answer' if the call has been re-directed from another number.
LOOKUP NAME = ttt...ttt	where ttt...ttt is the name looked up by the modem in its security database.
CALLBACK NMBR = nnn nnn	where nnn...nnn is the phone number to use to ring the caller back (which may be different from the number he dialled in on)

The modem also supports the following commands:

AT#CID?	Which returns the current setting of the #CID command
AT#CID=?	Which returns the available settings of the #CID command (0,1,2,3)

Options

AT#CID0 ■ Caller ID disabled

AT#CID1	Caller ID enabled
AT#CID2	Caller ID enabled with response to host in hex format
AT#CID3	Caller ID enabled with extended response

See Also

Refer to the section on Caller ID

#S Command Security Menu

Range

0-3

AT#D V.25bis Direct Calling

This command determines whether direct calling procedures (or ‘DTR dialling’) will be used when V.25bis mode is selected.

Refer to the section titled ‘Direct Dialling’, which appears in the V.25bis chapter, for details of how direct dialling works.

Options

- AT#D0 ■ Disable direct calling procedures
- AT#D1 Enable direct calling procedures

Range

0-1

AT#E Encryption

The #E command allows you to select DES encryption operating mode.

The #E1 command enables standard DES encryption.

DES encryption allows you to encrypt data being passed to a remote modem. The remote modem must support Cipher Feedback (or CFB) DES encryption to decrypt the data sent from your modem. You may compress the data before encryption using %C option.

The #E2 command enables the SuperSecure option.

Full details on Encryption and SuperSecure can be found in this guide in the Security Section.

WARNING

Only reliable error correction modes should be used with DES. This ensures only DES connections will be established with another modem. Refer to the \N command for details of the error correction modes.

☞ For countries other than Australia, DES encryption is only available to end users who meet the security requirements of the Australian Department of Defence. Contact your modem supplier for details of making application for a DES equipped modem to be supplied to you.

Options

AT#E0 ■	DES encryption disabled
AT#E1	DES encryption enabled
AT#E2	SuperSecure enabled (some models only)
AT#E3	DES MultiKey
AT#E4	DES AutoIV

Range

0-2

See Also

#S Command	Security Menu
*K Command	Select Primary DES key

AT#H Display Help

The #H or ? command may be followed by a command or keyword to display a description of a command.

See Also

? Command Display Commands

AT#I V.22bis Leased Line

The ITU specifies that in V.22 and V.22bis a different handshake should be used for leased line mode. This mode is specified by default.

Some modems still use the standard PSTN handshake for leased line connections.

Use #I1 to connect to these modems in V.22bis leased line mode.

Options

AT#I0 ■ V.22bis leased line normal
AT#I1 Use non-standard PSTN V.22bis over leased line

See Also

&L Command Leased Line

Range

0-1

AT#J V.42 Capability Checking

The #J command allows you to select whether your modem will check if the modem it is connecting to supports V.42, MNP or no error correction. This command only affects your modem when it dials another modem.

If #J0 is selected, your modem will assume the answering modem is a V.42 modem. You should only issue the AT#J0 command when you are certain the other modem is a V.42 modem.

WARNING

You will not be able to communicate with a non-V.42 modem if the AT#J0 command has been issued, regardless of the setting of the \N command. When #J1 is selected, your modem uses the ‘V.42 detect phase’ to test whether the answering modem supports V.42. This allows your modem to fall back to MNP or non-error corrected mode.

Options

AT#J0	Assume V.42 capable
AT#J1 ■	Check V.42 compatibility

See Also

\N command	Asynchronous Operating Mode
S Register 62	V.42 Detection Phase Timeout

Range

0-1

AT#K MNP 10 mode

MNP 10 works in conjunction with error correction and data compression to improve the performance of your modem when operating with poor or varying quality telephone lines (as sometimes found with cellular or overseas telephone connections).

MNP is the only type of error correction allowed with MNP 10 and is only available when connected to another modem that supports MNP 10. Refer to the chapter titled ‘Error Correction’ for details of MNP 10.

If you are using MNP 10 over bad telephone lines or cellular connections, issue the %H1 command before dialling, or use the J or L dial modifiers. This ensures an MNP 10 connection is established. Issue the AT#K2 command for cellular connections; it makes MNP 10 try harder to maintain the connection if the cellular call ‘drops out’.

Options

AT#K0	Disable MNP 10
AT#K1 ■	Enable MNP 10
AT#K2	Enable MNP 10 with cellular options

See Also

\N command	Asynchronous Operating Mode
%C command	Data Compression
%H command	MNP 10 Negotiation Speed
M dial modifier	Initiate MNP 10 at 4800 bps
J dial modifier	Initiate MNP 10 at 1200 bps
K dial modifier	Initiate MNP 10 Cellular option
-Q command	MNP 10 fallback to V.22 option

AT#M Command Mode Selection

The #M command selects AT command mode or V.25bis operating mode.

See the section — V.25bis Operations — for an explanation of V.25bis.

The #M command doesn't take effect until the an AT&W and an ATZ command are issued.

Options

AT#M0 ■	AT command operation
AT#M1	Asynchronous V.25bis
AT#M2	Synchronous V.25bis (HDLC framing)
AT#M3	Synchronous V.25bis (Char. framing-BSC mode)

See Also

Z command	Reset
&W command	Write Configuration Parameters

Range

0-3

AT#N V.25bis Character Encoding

Use the #N command to select either NRZ or NRZI character encoding for V.25bis synchronous operation.

This command only takes effect when a synchronous V.25bis operating mode is selected.

Before setting the #N command, check which character encoding method is expected by your computer.

Options

AT#N0 ■ NRZ Character Encoding
AT#N1 NRZI Character Encoding

Range

0-1

AT#O Buffer Overflow

The #O command decides what happens when your modem buffers fill and can no longer accept data. This will occur if data is received faster than your computer or modem can accept it.

☞ **The #O command is not supported when a variable speed mode connection is established.**

Options

- AT#O0 ■ Characters are ignored if the modem buffers overflow.
- AT#O1 Modem disconnects if the terminal buffer overflows (that is, data from the computer to the modem). S Register 42 (the Disconnect Reason) is set to 10.
- AT#O2 Modem disconnects if the line buffer overflows (that is, data from the line to the modem). S Register 42 is set to 9.
- AT#O3 Modem disconnects if either buffer overflows. S Register 42 will be set to 9 or 10, depending upon whether the line or terminal buffer overflowed.

See Also

- S Register 42 Disconnect Reason

Range

0-3

AT#Q V.25bis Terminal Speed

This command allows you to specify the V.25bis terminal speed.

When AT#Q0 is issued, your modem will use the speed at which you issued the last AT command for V.25bis mode. Alternatively, you may issue one of the other #Q commands to select a specific V.25bis terminal speed.

Options

#Q0 Use last autobaud speed
 Other options are the same as the ATR command

Range

0, 1, 2, 3, 4, 7, 9, 12, 14, 16, 19, 21, 24, 26, 28, 38, 57, 76, 96, 115, 230

AT#R Enable Remote Control

The #R command allows a remote modem to control your modem. Once a connection has been established, issuing the #R command will enable remote control mode.

After the command is issued, any commands the remote modem sends to your modem will be acted upon by your modem, as if commands were being issued from the computer attached to your modem.

You can terminate remote control by issuing an ATO command.

Options

AT#R Enable remote control mode

See Also

O command On-Line

AT#S Security Menu

The #S command orders the modem to enter the Security Menu mode. When the modem is in Security Menu mode, the Security Menu will be displayed on your computer screen:

You'll find details on the Security Menu and its use in the Security Section of this guide.

Options

AT#S Display Security Menu

See Also

*K command Select Primary DES key

#E command Encryption

AT#U V.25bis Character Set

The #U command is used to select the character set to be used when V.25bis mode is selected.

ASCII | Extended ASCII | EBCDIC | IBM

Options

Range

AT#V Verifier

The #V command selects whether your modem will check the validity of the commands you issue to it.

Your modem can check both AT commands and values you write to the S Registers.

When you use the #V0 command, no checking is performed on commands you issue. If you issue an unsupported command, the modem responds with an OK message.

With #V1 selected, if you attempt to issue an invalid command or read or write to a reserved S Register, the modem will return an ERROR message.

☞ ***If you issue an AT command string containing multiple commands, and one has incorrect syntax then none of the commands in the line will be executed***

Options

AT#V0 Command and S Register verifier off

AT#V1■ Command and S Register verifier on

Range

0-1

AT%B AutoAnswer Setting

The %B command sets the number of rings before your modem answers. The default setting %B0 turns off AutoAnswer.

Options

- AT%B0 ■ S0=0 No AutoAnswer
- AT%B2 S0=2 Modem answers after two rings

AT%C Compression Control

Data compression is a technique used to reduce the size of data being transmitted without losing any of the original information.

Compressed data must be decoded at the receiving end of the communications path in order to extract the original information.

Full details on the subject of data compression can be found in the Error Correction Section of this guide.

☛ ***When selecting a data compression mode, error correction must also be selected. (See the \N command for details of error correction.)***

Options

AT%C0	Compression disabled
AT%C1	MNP 5 compression enabled
AT%C2	V.42bis data compression enabled
AT%C3 ■	V.42bis data compression enabled with fallback to

MNP 5

See Also

\N command	Error correction
*V command	V.42bis compression table size

Examples

AT%C3\N3	Select V.42bis with auto-reliable error correction
AT%C1\N3	Select MNP5 with auto-reliable error correction

Range

0-3

AT%D Set Disconnect Delay

The %D command enables you to set a delay between the time the modem is told to hang up and when it actually goes on hook.

The modem will hang up whenever you issue an ATH command or the DTR (Data Terminal Ready) signal is lowered — after an &D2 or &D3 command is issued.

A value of 0 or 255 disables the disconnect delay.

If you have defined a disconnect delay, the modem will attempt to empty the contents of its data buffers before hanging up. If the modem's buffers are emptied before the disconnect delay expires, the modem will hang up immediately.

The modem will respond with NO CARRIER, rather than OK, if %D is between 1 and 255 and the modem's buffers have not been emptied when it hangs up.

Options

- AT%D0 ■ No disconnect delay
- AT%D30 Set the disconnect delay to 30 seconds

Range

0-255

AT%E Auto EQM Retrain

The %E command allows an originating modem to automatically retrain its communications equalisers during V.22bis MNP connections, or change the speed at which it is connected to another modem.

S Register 33 and S Register 45 contain EQM (Eye Quality Monitor) threshold values. When the quality of the connection deteriorates to this value, the modem will attempt to retrain the connection.

The %E2 command allows an originating modem to automatically retrain to a lower speed if the line quality deteriorates. This only works between two modems, both supporting the feature.

☞ ***In all V.32 and V.32bis connections, Auto Retrain is enabled.***

Options

AT%E0	Auto EQM Retrain OFF
AT%E1	Auto EQM Retrain ON
AT%E2 ■	V34/V32 auto rate change

See Also

S Register 33	V.32/V.32bis EQM Threshold Value
S Register 45	V.22bis EQM Threshold Value
O Command	Return to On-line State
%Q Command	Line Signal Quality

Range

0-2

AT%F DTR/DSR override

Front panel Option switches 1 and 2 may be used to control the DTR and DSR signals, or select V.25bis operation.

Refer to the Dumb Mode section for details

Options

AT%F0 A & B switches control V.25bis function
AT%F1 ■ Switch A forces DTR on, Switch B forces DSR high

Range

0-1

AT%H MNP 10 Negotiation Speed

This command allows you to determine the speed at which your modem will begin MNP 10 connections.

MNP 10 can change the speed of the connection depending upon the quality of the line. This command sets the initial connection speed only.

By initiating MNP 10 at a lower speed you can ensure that an error correcting link is established when this may not be possible at the highest speeds.

Refer to the chapter titled 'Error Correction' for details of MNP 10.

Options

AT%H0 ■	Use the B setting for initial MNP 10 connection speed. The B setting is the maximum speed.
AT%H1	Initial connection speed is made at 1200 bps (V.22). The maximum speed is defined by the B setting.
AT%H2	Initial connection made at 4800 bps (V.32). The maximum speed is limited by the B setting.
AT%H3	Initial connection made at 9600 bps (V.32). The maximum speed is limited by the B setting.
AT%H9	Use the B setting for the initial connection speed, but do not upshift until the connection is established. (NetComm modems only).

See Also

#K command	MNP 10 mode
J dial modifier	Initiate MNP 10 at 1200 bps
K dial modifier	MNP 10 Cellular Power level
L dial modifier	Initiate MNP 10 at 4800 bps

Range

0-3, 9

AT%K CTS During Dial and Handshake

This command may be used with computers that expect the CTS signal to be raised when your modem is connected to a remote modem and is ready to send data.

This command will interfere with the Abort Connection command (&N) if your computer cannot send characters to the modem when CTS is low.

Options

- | | |
|---------|--|
| AT%K0 ■ | CTS operates normally |
| AT%K1 | CTS is lowered when an ATD command is issued and remains low until a connection is established |

See Also

&N command Abort Connection

Range

0-1

AT%L Display Line Signal Level

The %L command allows you to display the received signal level. The value returned is a 3-digit number, for example:

009 = -9 dBm

043 = -43 dBm

AT%L Display received signal level

Examples

- Type: AT%L <E>

The line signal level is displayed.

AT%Ln Transmit Level (Data Mode)

This command allows you to alter the transmit level of your modem. The command is in the form:

AT%Ln

where n is the level you wish to select.

For example:

To set the transmit level to -15dBm:

- Type: AT%L15 <E>

WARNING

Do not change the transmit level of your modem unless you have a specific reason for doing so. Changing the transmit level of your modem may adversely affect its performance.

Options

11-19 (13 default) -11dB-19dB transmit level

Range

11-19

☞ *The %L command is **not** reset by the AT&F command. Fax Tx Levels are set by S register S103 with lower values giving higher levels.*

AT%M Mode LED Indication

If your modem has three 'Mode' LEDs, you can use the %M command to determine whether the LEDs will indicate the line speed or the quality of the line.

The Mode LEDs provide an indication of the line speed or line quality when you are connected to another modem only.

If you have issued the %M0 command, refer to the table on the underside of your modem to determine the line speed.

If you have issued the %M1 command:

Mode 1 LED will illuminate whenever the line quality is judged to be poor, Mode 2 LED will flash whenever a V.42 or MNP error is detected

Mode 3 LED will glow whenever the modem's flow control has indicated to your computer that it is unable to send data.

Options

AT%M0 ■ Mode LEDs indicate the connection speed

AT%M1 Mode LEDs indicate the line quality, V.42/MNP errors and flow control

Range

0-1

AT%N Non-Standard Terminal Speeds

Options

AT%N0 ■	Standard Baud Rates
AT%N1	Standard to 14400 then 20800, 31200, 41600 and 62400
AT%N2	Standard to 38400 then 51200

AT%P CONNECT Message Timing

This command allows you to determine whether the CONNECT message will be sent before or after the DCD signal is asserted by your modem. Some Unix computers require the CONNECT message to appear after DCD is asserted. In this case, the AT%P1 command should be used.

Options

- AT%P0 ■ CONNECT message appears before DCD is asserted
- AT%P1 CONNECT message appears after to DCD is asserted

Range

0-1

AT%Q Line Signal Quality

The %Q command allows you to display the line signal quality.

This command is not applicable to V.21, V.23 or Bell 103 connections. A lower value indicates a good quality connection. Values above 40 indicate a bad quality line signal and that you should shift to a lower speed or use MNP10. Values below 30 indicate a good quality line signal.

Options

AT%Q Display line signal quality

Examples

- Type: AT%Q <E>

The line signal quality is displayed.

AT%R CTS Override

The %R command allows you to determine the state of the CTS signal.

This command is intended to replace the CTS switch if your modem does not have one (eg Pocket & Rack Modems) This command overrides any &R setting.

☛ **The %R command does not revert to the default setting after an ATZ, AT&F or modem power off is performed.**

Options

AT%R0 ■	&R command determines the state of CTS
AT%R1	CTS always follows RTS (both in on-line state and local command state)
AT%R2	V.25bis mode: CTS on when ready to accept a command

See Also

&R	Sync RTS/CTS control
S Register 26	RTS/CTS Delay

Range

0-2

AT%S DSR Override

The %S command allows you to determine the state of the DSR signal.

This command is intended to replace the DSR switch if your modem does not have one (eg. Pocket & Rack Modems).

If your modem has a DSR option switch, the switch setting will take preference to %S. %S1 overrides any &S setting.

☞ The %S command does not revert to the default setting after an ATZ, AT&F or modem power off is performed.

Options

AT%S0 ■	DSR is not overridden
AT%S1	DSR mimics the state of the DTR signal (only reset by &F.)

Range

0-1

AT%T DCD Override

The %T command allows you to determine the state of the DCD signal.

This command is intended to replace the DCD switch if your modem does not have one (eg. Pocket & Rack Modems).

If your modem has a DCD option switch, the switch setting will take preference to %T. %T1 overrides any setting of &C

☞ ***The %T command does not revert to the default setting after an ATZ, AT&F or modem power off is performed.***

Options

AT%T0 ■ DCD always follows the state of the carrier from the remote modem
AT%T1 DCD is always high (only reset by &F.)

Range

0-1

AT%U V.42 Response Codes

The %U command allows you to change the response codes issued by your modem when a V.42 connection is established. Compression & encryption messages will be added if active.

After the %U1 command is issued, if your modem establishes a connection with V.42 error correction, a CONNECT/LAP-M message will be sent to your computer. If an MNP connection is established, a CONNECT/REL message will be sent to your computer.

After the %U2 command is issued, a CONNECT/REL-10 or CONNECT/ LAP-M message will be sent to your computer to indicate an MNP 10 or V.42 connection has been established.

☛ ***The %U command does not revert to the default setting after an ATZ, AT&F or modem power off is performed. The %U command has no effect on numeric response codes issued by the modem.***

Options

AT%U0 ■	Standard error correction response codes
AT%U1	V.42 response codes sent when a V.42 error corrected connection is established
AT%U2	Append /LAP-M or/REL (2,4,10) or /MNP-5 or /V.42bis or /DES messages to the CONNECT message when established

See Also

\V command	Error Correction Response Codes
X command	Extended Response Codes

Range

0-2

AT%W Welcome Message

The %W command allows the answering modem to send a user specified message to the originating modem immediately after connection. This facility can be used to identify a company name, a particular service provided by this modem or simply to identify the modem itself.

The message to be sent to the remote modem is specified by using the *W command.

If used with dial back security the original answering modem will transmit the welcome message after it has dialled back.

Options

AT%W0 ■ Welcome Message disabled
AT%W1 Welcome Message enabled

See Also

*W Command Welcome Message Text

Range

0-1

AT\A MNP Block Size

The \A command allows you to select the maximum block size to be used by your modem over an MNP error-corrected connection.

Options

AT\A0	64 character block size
AT\A1	128 character block size
AT\A2	192 character block size
AT\A3 ■	256 character block size

Range

0-3

AT\Bn Generate Break

The \Bn command is used to send a break sequence to the remote modem of length $n \times 100\text{mS}$.

The length of the break sequence may be set from 0.1 seconds to 0.9 seconds.

The default length of breaks generated by the modem is 0.3 seconds.

The \K command determines how the modem will react when a break sequence is received.

This command stores the break length into S43 in units of 20mS.

Options

AT\B4 Generate a break sequence 0.4 seconds long

Default

3

See Also

\K command Break Control
S Register 43 Break Sequence Length

Range

1-9

AT\J Auto-Reliable Fallback

This command allows you to select whether your modem (when operating in auto-reliable mode) will use Constant Speed mode or Variable Speed mode. If, with \J0 selected, an error corrected auto-reliable connection cannot be established with another modem, the modem will fall back to Constant Speed mode.

Selecting \J1 will cause the modem to operate in Variable Speed mode. If an error corrected auto-reliable connection cannot be established with another modem, the modem will fall back to Variable Speed mode after sending the CONNECT message to your computer. The modem will alter its terminal speed to match the connection speed to the remote modem.

Options

- AT\J0 ■ Fallback Constant Speed mode
- AT\J1 Fallback to Variable Speed mode

Range

0-1

AT\K Break Control

The \K command determines how the modem will react when a break sequence is sent from your computer or received from the remote modem. During error corrected connections the modem sending the break determines how the receiving modem will react. During non-error corrected connections, the receiving modem determines how it will react. The default break control setting is \K5.

The following tables show how the modem will react when it receives a break sequence from either the remote modem or your computer.

Break sent from your computer, while in On-line state, during a Constant speed or error corrected connection.

\K0,2,4	Enter Local Command state, do not send Break
\K1	Empty data buffers in both sending and receiving modems and immediately send Break
\K3	Immediately send Break
\K5	Send data in buffer before sending Break

\B command issued during a Constant speed or error corrected connection.

\K0,1	Empty data buffers in both sending and receiving modems and immediately send Break
\K2,3	Immediately send Break
\K4,5	Send data in buffer before sending Break

☞ *During a variable speed connection, if the \B command is issued, the modem will send the break immediately.*

Break sent from your computer, while in On-line state, during a Variable speed connection.

\K0,2,4	Immediately send Break and enter Local command state
\K1,3,5	Immediately send Break

Break received from the remote modem, while in On-line state, during a Constant speed connection.

\K0,1	Empty buffers in both sending and receiving and immediately send Break to computer
\K2,3	Immediately send Break to computer
\K4,5	Send data in buffer before sending Break to computer

☞ *If a break sequence is received by the modem while it is in local command state (and is maintaining a constant speed connection), the modem will not process the break until it returns to on-line state. If the break sequence is received by the modem while it is in local command state and maintaining a variable speed connection, the break will be ignored. Breaks*

received from a remote modem during an error corrected connection are handled by your modem according to the setting of the \K command in the remote modem.

See Also

\B command Generate Break

Default

\K5

Range

0-5

AT\N Asynchronous Operating Mode

The \N command allows you to select any of your modem's four asynchronous operating modes. AT\N0 selects constant speed mode, enabling the modem to use different terminal and line speeds.

Your modem supports constant terminal speeds from 300 bps to 460,400 bps. For example, with constant speed selected the modem could connect with a remote system using V.22 (1200 bps) while communicating with your computer at 115,200 bps. Selecting constant speed mode also means the modem will not modify its terminal speed when answering incoming calls.

☞ ***It is necessary to select flow control (&K command) between the modem and your computer when you use constant speed mode.***

AT\N1 selects variable speed mode. With variable speed mode selected, the modem adjusts its terminal speed to match line speed. If the terminal speed is higher than the modem's maximum line speed, the modem will attempt to connect using its highest speed.

☞ ***Flow control will be ignored when your modem is configured for variable speed mode or is in local command state. Flow control is only available when the modem is configured for constant speed mode or reliable or auto-reliable modes and is operating in on-line state.***

When answering, the modem automatically adjusts its terminal speed to match the standard used by the calling modem.

☞ ***With variable speed mode selected, your modem's terminal speed should not be changed once connected to another modem.***

Changes to \N when on-line will not take effect until the next connection.

Options

AT\N0	Constant speed mode
AT\N1	Variable speed mode
AT\N2	MNP Reliable mode
AT\N3 ■	V.42/MNP auto-reliable mode
AT\N4	V.42 reliable mode
AT\N5	V.42 auto-reliable mode
AT\N6	V.42/MNP reliable mode with fallback to MNP reliable mode, disconnect if MNP not supported by remote modem.
AT\N7	MNP auto-reliable mode

See Also

B command Communications Standard

&K command	Flow Control
\J command	MNP Fallback
#J command	V.42 Detect Phase

Range

0-7

AT\Q Extended Flow Control

The \Q command enables you to select flow control (handshaking) between your modem and computer. While performing the same function as the &K command, the \Q command provides compatibility with Microcom modems.

Flow control is only available when the modem is configured for constant speed mode or reliable or auto-reliable modes, and is operating in on-line state.

Flow control will be ignored when your modem is configured for variable speed mode or is in local command state.

Options

AT\Q0	Flow control disabled
AT\Q1	XON/XOFF flow control The modem and computer use the XON and XOFF characters (DC1 and DC3) to pause the flow of data.
AT\Q2	CTS flow control #1 The modem uses the CTS (Clear To Send) signal to pause data flow, but will not respond if the computer changes the state of the RTS (Request To Send) signal.
AT\Q3	CTS/RTS flow control #1 The modem and computer use the CTS and RTS signals to control data flow (as per &K3).
AT\Q4	Modem XON/XOFF flow control The modem uses the XON and XOFF characters (DC1 and DC3) to pause the flow of data but will not respond if the computer sends XON or XOFF characters.
AT\Q5	CTS flow control #2 The modem uses the CTS (Clear To Send) signal to pause data flow and keeps CTS low until a connection is established with a remote modem. The modem will not respond if the computer changes the state of the RTS (Request To Send) signal.
AT\Q6	CTS/RTS flow control #2 The modem and computer use the CTS and RTS signals to control data flow. CTS remains low until a connection is established with a remote modem.

See Also

&K command Flow Control

Range

0-6

AT\S Display Active Configuration

The \S command allows you to display the current active configuration. The following is a sample of the \S command output:

Options

AT\S Display Active Configuration

AT\Tn Inactivity Timer (Data Mode)

The \Tn command specifies the number of minutes the modem will stay on line when no activity is occurring.

Options

See Also

Range

AT\V Error Correction Response Codes

The \V command allows you to select the error correction response codes when an error corrected connection is established. With error correction response codes enabled, the messages are returned when a connection is established using error correction.

If the ATX0 command has been issued, only the CONNECT/REL will be generated by the modem, regardless of the connection speed, after the \V1 command is issued.

☛ **Your communications software may not expect the modem to return error correction response codes. If this is the case, disable the error correction response codes. When disabled, the modem will generate standard CONNECT messages for both error correction and normal connections.**

Options

AT\V0 ■	Disable error correction response codes
AT\V1	Enable error correction response codes
AT\V8	Enable error correction response codes plus details of the error correction and data compression negotiated with the remote modem is displayed immediately before the CONNECT message.
AT\V9	Enable error correction response codes plus details of the error correction and data compression negotiated with the remote modem and diagnostic information displayed immediately before the CONNECT message.

See Also

X command	Extended Response Codes
%U command	V.42 Response Codes

Range

0-1, 8-9

AT\X ON/XOFF Pass Through

The \X command enables you to define whether XON and XOFF (software handshake) characters are allowed to pass through the modem to the remote system.

The \X command only affects XON/XOFF characters sent from your computer to your modem. It does not affect XON/XOFF characters sent from a remote system to your modem.

☛ ***When the modem is configured for XON/XOFF flow control, passing through XON/XOFF characters may interfere with the modem's control of data flow. It is usually best to disable pass through.***

The \X command only takes effect when XON/XOFF flow control is enabled (&K4).

Options

AT\X0 ■ Remove received XON/XOFF characters from received data
AT\X1 Pass through received XON/XOFF characters

See Also

&K command Flow Control
\Q command Extended Flow Control

Range

0-1

AT*K Select Primary DES KEY from Stored Keys

The *K command allows the user to select the DES key from the 10 available stored keys.

Default

0

Range

0-9

See Also

#S	Security
#E	Encryption

☞ *The Security & Encryption section contains information on the application of the *K command.*

AT*R V.13 Remote RTS Signalling

The *R command allows your modem to simulate carrier control on a Synchronous Link by transmitting the local state of RTS to the remote modem.

Some systems rely on RTS as an indicator of Terminal Ready to Send. When modems are inserted between the host and the terminal the status of RTS is not known since the state of RTS is not normally transmitted over the link. The V.13 recommendation allows the state of RTS to be transmitted over the link by sending a unique stream of data. This stream of data will appear as rubbish to the host (which will discard it), however the receiving modem in V.13 mode will recognise the stream and convey it to the host via the DCD (RSLD) line. DCD high indicates remote RTS high and vice versa.

The local CTS line will mimic the state of the local RTS signal on the local modem.

The remote DCD line will mimic the state of the local RTS signal on the remote modem

☞ ***When this option is selected the modems may take a little longer to disconnect than usual since the normal function of Carrier Detect has been disabled. The modems rely on poor EQM values to confirm disconnect.***

☞ ***Not available in FSK (V.21 V.23 Bell 103) modes.***

Options

AT*R0 ■ V.13 mode off
 AT*R1 V.13 mode on

See Also

&M command Synchronous Mode

AT*S Change Current User Password

The *S command allows the user to change their own password. If the user is connected the modem will ask for the current password before prompting for a new password. The user will then be asked to repeat the new password for verification.

If the user is not connected the name of the user whose password is to be altered must also be specified.

☞ *If password expiry is enabled the password age will be reset to zero days.*

See Also

#S Command Security menu

AT*T Auto Call Redial

The *T command allows you to select whether the modem will redial the last number dialled automatically. If enabled the modem will dial the last number after 10 seconds.

Options

- AT*T0 ■ Disable auto call redial
- AT*T1 Enable auto call redial

Range

0-1

AT*V Maximum V.42bis Dictionary Size

The V.42bis dictionary size is normally negotiated during the V.42 handshake.

The NetComm SmartModems have enough memory to store 8,192 dictionary entries. This will allow 8:1 compression on some file types.

Some modems do not correctly negotiate the dictionary size, in these cases the user should reduce the dictionary size to 2,048 entries (4:1 compression ratio).

If the remote modem exhibits wrong negotiation the user will see corrupted data and/or sudden disconnection.

Options

AT*V0 ■	8,192 dictionary entries
AT*V1	2,048 dictionary entries

See Also

%C command	Compression options
------------	---------------------

AT*W Welcome Message Text

The *W command allows the user to specify the message that will be sent to the originating modem immediately after CONNECT if the %W1 Welcome Message is enabled.

The message may contain any text limited only by the maximum command line size (80). The message may include new lines which are indicated by using the ‘|’ character.

If %W1 is enabled the text you have specified will be displayed at the end of the &V display.

Examples

AT*W You are connected to a NetComm SmartModem

This will send the following text to the remote modem after connection:

You are connected to a NetComm SmartModem

See Also

%W Enable Welcome Message

AT*Y Escape Seq. Detection in Sync.

Escape Sequence Detection (i.e. +++) is normally disabled in all synchronous modes. This is because synchronous data cannot generate silences around the +++. However to diagnose line performance you need to be able to escape to command mode.

To allow these diagnostics to take place the user may select the *Y1 option before making a synchronous connection and then attaching a asynchronous terminal to the modem. The user may then issue +++ as in asynchronous modes to return to command mode.

Options

- AT*Y0 ■ Escape Sequence Detection in Sync mode disabled
- AT*Y1 Escape Sequence Detection in Sync mode enabled

AT+ICF Character Framing and Parity Select

The +ICF command is used in conjunction with the R command to select the character format and parity of the RS232 interface when not in autobauding mode or if autobauding to 230kbps.

The syntax is: AT+ICF=<format>[,<parity>]

Format can be:

0 ■	auto
1	8 data bits no parity 2 stop bits
2	8 data bits with parity 1 stop bit
3	8 data bits no parity 1 stop bit
4	7 data bits no parity 2 stop bits
5	7 data bits with parity 1 stop bit
6	7 data bits no parity 1 stop bit

Parity can be:

0	odd
1	even
2	mark
3	space

You can use AT+ICF=? to display the legal parameters and AT+ICF? to show the current setting.

Default

+ICF=0 auto mode.

See Also

ATR Command

AT+MS Select Modulation

The +MS command selects the modulation, optionally enables or disables automode, and optionally specifies the lowest and highest connection rates using one to six subparameters. The command format is:

+MS= <mod>

[,<automode>][,<min_rate>][,<max_rate>][,<x_law>][,<rb_signaling>]]]]<CR>

Subparameters not entered (enter a comma only or <CR> to skip the last subparameter) remain at their current values.

The maximum speed in bps of the modulation is bound by the DTE speed in bps. If the DTE speed exceeds the maximum capable by the selected modulation, then the DTE speed has no effect in limiting the resultant modulation speed on connection. If the DTE speed is less than the maximum capable modulation, then, (resulting connection modulation speed) < (DTE speed)

For example:

1. DTE speed: 19200 bps
Modem configuration: +MS=11, 1, 300, 19200
Maximum obtainable modulation speed: 19200 bps
2. DTE speeds 38400 bps
Modem configuration: +MS=11, 1 300, 33600
Maximum obtainable modulation speed: 33600 bps

This feature allows the modulation over the telephone line to be more reliable and give better throughput, since the maximum throughput obtainable is governed by the DTE speed.

<mod>

A decimal number which specifies the preferred modulation (automode enabled) or the modulation (automode disabled) to use in originating or answering a connection. The options are:

<mod>	Modulation	Possible Rates (bps)
0	V.21	300
1	V.22	1200
2	V.22bis	2400 or 1200
3	V.23	1200
9	V.32	9600 or 4800
10	V.32bis	14400, 12000, 9600, 7200, or 4800
11	V.34	33600, 31200, 28800, 26400, 24000, 21600, 19200, 16800, 14400, 12000, 9600, 7200, 4800, or 2400

12 ■	V.90	56000, 54667, 53333, 52000, 50667, 49333, 48000, 46667, 44000, 42667, 41333, 40000, 38667, 37333, 36000, 34667, 33333, 32000, 30667, 29333, 28000
64	Bell 103	300
69	Bell 212	1200

The modem may also automatically switch to another modulation (automode), subject to the following constraints:

- The modem may not be able to automatically switch from the current modulation (specified by <mod>) to some other modulation. For example, there is no standard way to automode from Bell 103 to V.23.
- The DTE may disable automode operation (see <automode> below).
- The DTE may constrain the range of modulations available by specifying the lowest and highest rates (see <min_rate> and <max_rate> below).

<automode>

Automode is an optional numeric value which enables or disables automatic modulation negotiation using V.8 or V.32 bis Annex A. The options are:

The default value is 1, which enables automode. Note, however, there are modulations for which there is no automatic negotiation, for example: Bell 212 (<mod> = 69).

For <automode> = 0 (automode disabled, i.e., fixed modulation):

- If <max_rate> is within the rates supported by the selected modulation, the selected rate is that specified by <max_rate>. For example:
+MS=9,0,1200,4800 selects V.32 4800 bps fixed rate.
- If <max_rate> is greater than the highest speed supported by the modulation specified by <mod>, the starting rate is the highest rate supported by the selected modulation. For example:
+MS=9,0,2400,14400 selects V.32 9600 or 4800 bps.
- To select fixed mode operation (or emulate issuance of the N0S=x command sequence) specify the <max_rate> and <min_rate> to be the same requested speed, and <mod> to be the modulation for that speed.

For example:

+MS=11,0,16800,16800 selects V.34 16800 bps fixed mode (no comparable S37 command).
+MS=9,0,12000,12000 selects V.32 bis 12000 bps fixed mode (same as N1S37=10).

For <automode> = 1 (automode enabled, i.e., automatically selected speed and modulation):

The modem connects at the highest possible rate in accordance with V.8, or V.32 bis Annex A if V.8 is not supported by the remote modem.

- When V.90 is enabled the speeds listed can be used to set the maximum speed. For example:
AT+MS=12,1,300,38667

This sets the maximum V.90 speed to 38667. Only the maximum speed is applicable when using V.90. The minimum speed cannot be set.

- If `<max_rate>` is greater than the highest rate supported by the modulation specified by `<mod>`, the modem automodes down from the highest rate of the selected modulation. For example:
+MS=10,1,1200,24000 selects automodging down from V.32 bis 14400 bps.
- To emulate issuance of the NIS37=`x` sequence command, specify the modulation and the rate to start automodging down from using `<mod>` and `<max_rate>`, respectively. Set `<min_rate>` to 300 to allow automodging all the way down to V.21 300 bps. For example:
+MS=11,1,300,16800 selects automode starting at V.34 16800 bps (no comparable S37 command).
+MS=9,1,300,12000 selects automode starting at V.32 12000 bps (same as S37=10).

`<min_rate>`

Is an optional number which specifies the lowest rate at which the modem may establish a connection. The value is decimal coded, in units of bps, e.g., 2400 specifies the lowest rate to be 2400 bps. The default is 300 for 300 bps.

☞ ***When using V.90, the minimum rate can not be specified.***

`<max_rate>`

Is an optional number which specifies the highest rate at which the modem may establish a connection. The value is decimal coded, in units of bps, e.g., 14400 specifies the highest rate to be 14400 bps. The default is 56000 for 56000 bps.

`<x_law>`

Is an optional number which specifies the codec type. The option are:

0 = m-Law

1 = A-Law

☞ ***When using V.90, the appropriate law is selected automatically and the user setting will be ignored.***

<rb_signaling>

is an optional number which enable or disables robbed bit signaling generation in a server modem or enables or disables robbed bit signaling detection in a client modem. The options are:

0 = Robbed bit signaling generation (server modem) or detection (client modem) disabled (default)

1 = Robbed bit signaling generation (server modem) or detection (client modem) enabled

+MS? Reporting selected options

+MS=? Reporting supported options

Nn Automode

1. Use of the Nn command is not recommended but is provided for compatibility with existing communication software.
2. This command is product dependant.

☛ ***The ATB command can be used instead of the AT+MS command to limit the maximum speed.***

Connecting with 56k technology

Connection speeds higher than 33600bps can only be obtained by calling an Internet Service Provider (ISP) or Central Site which supports the V.90 protocol. The speeds at which you will be able to connect also depend on the quality of the telephone line used for making the connection.

AT+MS=? Reporting Supports Options

The modem can send a string of information to the DTE consisting of supported options:

Options

+MS=?

Example

+MS: (0, 1, 2, 3, 8, 9, 10, 11, 12, 56, 64, 69, 74), (0,1) (300-56000), (300-56000)

See Also

+MS? Reporting selected options

+MS Select modulation

Range

+MS: (list of supported <mod> values), (list of supported <automode> values), (list of supported <min_rate> values), (list of supported <max_rate> values).

AT-Q MNP10 Fallback to V.22bis

The -Q command permits the modem to fallback from a V.34, V.32bis or V.32 connection with MNP10, to a V.22bis or V.22 MNP10 connection. MNP10 has the ability to make decisions regarding line quality and will request a change in speeds if it decides the phone line is not sufficient quality to maintain the current connection speed.

Options

- | | |
|---------|---|
| AT-Q0 | Disable fallback to V.22bis or V.22 |
| AT-Q1 ■ | Enable fallback to V.22bis or V.22 with MNP10 |

Range

0-1

AT-DATE Time & Date

The -DATE command allows the modem to record the Time and Date in the log information inbound and outbound calls.

The Time and Date will be set by an inbound call with Caller ID information or by issuing the AT-DATE command.

The Call Logging Function (AT-LOG) automatically records the Date, Time, Phone Number and Name of any inbound call that has Caller ID information. In addition the modem will also log all outbound calls that are originated by the modem and record the phone number, connect speed, disconnect reason and call duration.

☞ ***The modem does not have a non-volatile real time clock so the current time and date will be forgotten if the modem is turned off.***

See Also

AT-LOG Call Log

AT-LOG Call Log

The AT-LOG command will automatically record the Date, Time, Phone Number and Name of any inbound call that has Caller ID information. In addition the modem will also log all outbound calls that are originated by the modem and record the phone number, connect speed, disconnect reason and call duration. The modem will also log information about anonymous inbound calls if the call makes a data or fax connection.

If the Time and Date have been set it will also record this. The Time and Date will be set by an inbound call with Caller ID information or by issuing the ATDATE command.

☞ ***The modem does not have a non-volatile real time clock so the current time and date will be forgotten if the modem is turned off. The current time and date is displayed at the end of the &V display if it has been set.***

Options

AT-LOG Display the most recent calls (The modem has enough storage for approximately 400 calls)

AT-LOG2 Delete call log (confirming the deletion with Y)

☞ ***AT&F and AT&F do not delete the call log, it can only be explicitly deleted using AT-LOG2.***

If you wish to secure the call log so that it cannot be deleted by unauthorised users, the AT-LOG2 command can be disabled from the security menu 'L' command (which also locks the encryption mode) and re-enabled using the 'F' command.

The Call Log is displayed most recent call first. The information saved in the call log is:

DATE	in format mm/dd (month/day)
TIME	in format hh:mm (hour/minute)
NUMBER	for both inbound and outbound calls
NAME	the name of an inbound call is displayed if the name was provided in the Caller ID information or if the number was listed in the security database.
	Duration in format hh:mm:ss (hours:minutes:seconds) the total duration of the call.
	S42 the code number for the disconnect reason. Maybe helpful for tracking down call that drop out mysteriously. Refer to manual or help text for information on the S42 codes.
SPEED	the connect line speed
ERROR CORRECTION	L for LAPM M for MNP - for no error correction

AT:E V.32 compromise Equaliser

This command switches on or off the V.32 compromise equaliser. When operating over cellular connections, it may be desirable to switch off the V.32 compromise equaliser. For dial-up lines, the equaliser should be switched on.

Options

- AT:E0 Disable the V.32 compromise equaliser
- AT:E1 ■ Enable the V.32 compromise equaliser

Range

0-1

V.25BIS - CIC Connect Incoming Call

The CIC command may be issued if you decide to accept an incoming call after issuing the DIC command.

For details, refer to the 'V.25bis Operations' section of this guide.

Options

CIC Accept an incoming call after the DIC command has been issued

See Also

DIC command	Disregard Incoming Call
S Register 71	Ignore Incoming Call

V.25BIS - CRN Dial

This command allows you to dial a telephone number. The basic dialling command is:

CRN followed by the telephone number.

For example:

To dial the number (09) 111-1234

- Type: CRN091111234 <E>

You can use hyphens, spaces or parentheses. They will be ignored by the modem, but they will make it easier to read the command line.

For example:

CRN (09) 111-1234

Dial modifiers may be included in the dial command.

Dial Modifiers

Dial modifiers enable you to change the characteristics of dialling. (Definitions for all modifiers appear on the following pages.)

Modifier	Meaning
<	pause
:	wait for dial tone
&	hook flash

Options

CRN12345 Dial number 12345

< pause

This modifier orders the modem to pause before dialling the rest of the phone number. This is useful when using a PABX and you need to dial a number to connect to an outside line.

For example: If you must dial 0 to connect to an outside line before dialling (09) 111-1234

- Type: CRN0<091111234 <E>

The length of the pause is determined by the value in S Register 8.

☛ UK Modems. If your PABX requires more than four seconds to obtain a line, add no more than one extra < to your dial command.

& hook flash

The & dial modifier issues a hook flash signal — the modem hangs up for a short period. Hook flashes are commonly used with PABXs to transfer calls.

For example:

To dial 0, hook flash and then dial 12345:

- Type: CRN0&12345 <E>

: wait for dial tone

The : modifier causes the modem to wait for a dial tone before dialling. If the modem does not detect a dial tone within 30 seconds, it returns a message of CFI AB, hangs up and returns to local command state.

You can change the dial tone waiting period from the default period of 30 seconds by changing the value in Register 7.

☞ **When using the : modifier, the length of time your modem waits for a dial tone is determined by the value contained in S Register 7 (Wait for Carrier) and not the value in S Register 6 (Wait for Dial Tone).**

☞ **UK Modems. Setting S Register 7 with a value above 58 may invalidate the approval of your modem. S Register 7 must be set to 20 before issuing the : dial modifier.**

For example:

To wait for a dial tone and then dial 111-0123:

- Type: CRN:1110123 <E>

See Also

CRS command	Dial Stored Number
S Register 6	Wait Time for Dial Tone
S Register 7	Wait Time for Carrier
S Register 8	Length of Dial Pause

V.25BIS - CRS Dial Stored Number

Your modem allows you to store phone numbers in non-volatile memory. The basic form of the CRS command is:

CRS n

where n is the stored phone number you wish to dial.

For example:

To dial stored phone number one:

- Type: CRS 1 <E>

☛ **Refer to your Modem Commands for details of how many phone numbers may be stored in your modem.**

Options

CRS 4 Dial stored phone number four

See Also

PRN command Store Phone Number

V.25BIS - DIC Disregard Incoming Call

The DIC command is used to disregard incoming calls.

When your modem receives an incoming call, an INC message is sent to your computer. You then have the number of seconds defined by S Register 71 to disregard the call.

If you issue the DIC command, the call will be ignored, otherwise the modem will answer the call after the number of seconds defined by S Register 71.

Options

DIC Disregard the incoming call

See Also

CIC Connect Incoming Call

S Register 71 Ignore Incoming Call

V.25BIS - PRN Stored Phone Number

The PRN command allows you to store phone numbers in your modem's nonvolatile memory.

The command takes the form:

PRNn;x

where x is the phone number you want to store and n indicates which of the stored phone numbers it will be saved as.

Stored phone numbers may contain up to 20 characters, including dial modifiers.

Options

PRN2;12345

Store the phone number 12345 as stored phone number two

PRN4;P0,T12345

Store the following as stored number four; first pulse dial 0, wait for two seconds to get an outside line and then tone dial 12345

See Also

CRS

Dial a Stored Number

V.25BIS - RST Reset

Your modem is supplied with a default operating set up. You can change this temporarily by issuing commands while you are working, or permanently by using the &W command to store changes you've made in non-volatile memory.

The RST command returns the modem to the last saved configuration and causes it to perform a power-on self-test.

☛ ***When you issue the RST command, you must issue an ATZ command to select V.25bis command mode. Your modem always resets and powers up in AT command mode, regardless of the setting of the #M command.***

Options

RST Reset the modem and restore the saved configuration profile

See Also

&F command Restore Factory Defaults

&F. command Reinitialise modem

&W command Write Configuration

S Registers

Introduction

Your modem contains a number of registers — memory stores — which define the modem's operating characteristics. These registers are called Special Registers or S Registers.

This section of the SmartModem56 User Guide shows you the function and usage of each S Register, how to check the current contents of your S Registers, how to change S Register settings and how to save the settings in non-volatile memory.

Reading and Changing S Registers

The Read Register command (Sn?) enables you to check the current contents of an S Register.

For example:

To check how long the modem will wait for a dial tone before starting to dial, you would check S Register 6. To do this:

- Type: AT\$6? <E>

The modem will display the current contents of the S6 Register.

If you want to change the register setting, use the Set Register command (Sn=x).

For example:

To change the setting of your modem, so the modem waits five seconds for a dial tone before starting to dial:

- Type: AT\$6=5 <E>

S Register Settings and Modem Memory

Your modem comes configured with a set of default values for each of the special registers. Any changes you make using the Sn=x command will only last while the modem is switched on.

Once you switch the modem off, these changes will be lost and the next time the modem is switched on, the factory-set default values will be in effect.

To understand this, consider the following. Modems use three different types of memory chips:

- 1 RAM chips that only hold information in their memory while the modem has power supplied to it. You can easily change information in RAM. This memory is used to temporarily store any changes you make to Commands or S Registers during a communications session.
- 2 ROM chips that have their data placed into them at the factory. They retain their information when the power is switched off. You cannot make changes to information stored in ROM chips. Information such as factory default settings for S Registers is stored in your modem's ROM chips.

- 3 Non-volatile memory retains data without requiring power. You can change the data in non-volatile memory by using a special command (&Wn) to write the current settings to memory. This memory can be used to provide a more permanent storage of changes you make to the settings of your modem.

Any parameter stored in RAM will take precedence over any other stored in non-volatile memory or ROM. Any parameter stored in non-volatile memory will take precedence over those stored in ROM.

If you have not made any changes to your modem's settings since it was unpacked after purchase, the default parameters in ROM will control the modem.

If you have made changes and stored them as profiles in non-volatile memory — using the Write Configuration (&Wn) command where n = profile 0,1,2 or 3— those settings that have been changed in the active profile will take precedence over those in ROM, even after switching the modem off and on.

Temporary changes — made during a communications session — to values using any AT command, will be stored in RAM and will take precedence until you switch the modem off.

To use the current S Register settings with the Write Configuration command (&Wn):

- Type: AT&Wn <E>
(where n = the profile number you wish to use 0-3)

To return to the original factory default settings:

- Type: AT&F <E>

☞ ***Re-loading the factory default settings with AT&F will not save these default settings to non-volatile memory.***

To save factory defaults to non-volatile memory so they can be used again, after switching the modem off and on, follow the &F command with the Write Configuration (&Wn) command.

To reset and store all settings to the factory default:

- Type: AT&F.

ATS0 Rings Before Answer

S Register 0 contains a decimal value (from 0-255) indicating the number of rings the modem will wait before answering an incoming call.

If you place a value of 0 in this S Register, auto-answer operation will be disabled.

The default value for S Register 0 is 0 — the modem will not answer an incoming call.

Examples

ATS0=0 Disable auto-answer

ATS0=4 Wait four rings before answering an incoming call

Default

0

Range

0-255

ATS1 Ring Count

S Register 1 contains a decimal value (from 0 to 255) indicating the number of rings detected.

S Register 1 is incremented each time a ring is detected. It will be cleared if no ring occurs within 8 seconds of the last ring.

Default

0

Range

0-255

ATS2 Escape Sequence Character

S Register 2 contains the ASCII value of the characters which form the escape sequence.

The default value for this register is 43. The modem will recognise three + characters (+++) as the escape sequence.

Setting this register to a value greater than 127 disables the modem's recognition of the escape character.

Examples

ATS2=36 Recognise three \$ (\$\$\$) characters as the escape sequence

ATS2=64 Recognise three @ (@@@) characters as the escape sequence

Default

43 (the + character)

See Also

S Register 12 Escape Sequence Guard time

Range

1-255

ATS3 Carriage Return Character

S Register 3 contains the ASCII value of the character recognised by the modem as the Carriage Return character in local command state.

Default

13

Example

ATS3=127 Recognise the DEL character as the carriage return

Range

0-127

ATS4 Line Feed Character

S Register 4 contains the ASCII value of the character recognised by the modem as the Line Feed character in local command state.

Default

10

Example

ATS4=13 Recognise the Carriage Return character as the line feed

Range

0-127

ATS5 Backspace Character

S Register 5 contains the ASCII value of the character recognised by the modem as the Backspace character in local command state.

The preferred values for this register are ASCII codes 0 to 32 or 127.

Default

8

Example

ATS5=127 Recognise the DEL character as the backspace.

Range

0-127

ATS6 Dial Tone Wait Time

S Register 6 determines how long the modem will wait for a dial tone after going off-hook and before dialling.

This register contains a value indicating the number of seconds the modem will wait for a dial tone. This provides slow telephone exchanges the opportunity to apply a dial tone to the line before the modem attempts to dial.

If the W dial modifier is included in the phone number being dialled, the value in S Register 6 will be ignored, unless the X2, X4, or X5 commands have been issued.

Examples

ATS6=5 Wait five seconds for a dial tone before dialling.

Default

4

See Also

D command	Dial
W dial modifier	Wait
X command	Extended Response Codes

Range

4-7

ATS7 Wait for Carrier

S Register 7 contains a value, in seconds, equivalent to the length of time the modem will wait for answer tone after dialling. If an answer tone is not detected within the time specified in this register, the modem will hang up and return a NO CARRIER message. After an answer tone is detected the modem has another 57 seconds to complete the handshake

The answering modem has 57 seconds to complete the handshake after starting answer tone.

This register is also used by the W modifier to determine how long the modem will wait for a dial tone to be applied to the line before reporting a NO DIALTONE message.

☛ **UK Modems. Setting S Register 7 with a value above 58 may invalidate the approval of your modem. S Register 7 must be set to 20 before issuing the W dial modifier. Any other change to this register will invalidate the approval of your modem.**

Examples

ATS7=20 Wait for 20 seconds for a connection

Default

30

Range

1-60

ATS8 Pause Dial Modifier Delay

S Register 8 contains the time in seconds the modem will wait when it encounters a comma (the pause dial modifier) in a dialling sequence.

☛ **UK Modems. Changing S Register 8 from its default value may invalidate the approval of your modem.**

Examples

ATS8=6 Wait six seconds when a comma is encountered in the dialling sequence

Default

4

See Also

D command Dial (and , modifier)

Range

1-7

ATS9 Carrier Detect Response Time

S Register 9 contains the length of time, in tenths of a second, the modem will wait before asserting the DCD (Data Carrier Detect) signal, after a carrier has been detected.

The longer the time taken before asserting DCD, the less chance of line noise being mistaken by the modem as a carrier signal.

If you have previously issued an AT&C0 command or placed the DCD option switch in the DOWN position, the modem will assert the DCD signal regardless of the presence of a carrier signal from the remote system.

☞ V.21, Bell 103 and V.23 only.

Examples

ATS9=9 Wait 0.9 seconds after detecting a carrier before connecting to the phone line (asserting DCD).

Default

6

See Also

&C command Controlling Data Carrier Detect

Range

1-255

ATS10 Lost Carrier/Hang Up Delay

S Register 10 contains the amount of time, in tenths of a second, the modem will wait after the carrier has been lost before hanging up.

If a value of 255 is placed in this register, the modem will not hang up after the carrier is lost from the remote modem. In this case, you must use the H command to hang up.

Examples

ATS10=12 Wait 1.2 seconds after losing carrier before hanging up

Default

18

Range

1-255

ATS11 DTMF Tone Timing

S Register 11 contains the time, in thousandths of a second, of the duration and spacing of tones when tone dialling (DTMF tones).

Examples

ATS11=120 Space tones at 0.120 second intervals

Default

95

Range

70-254

ATS12 Escape Sequence Guard Time

The Escape Sequence Guard Time is the time delay required immediately before and after entering an escape sequence.

For your modem to distinguish the escape sequence from ordinary data, there must be a period of silence both before and after the escape sequence is entered.

If the Escape Sequence Guard Time is one second and the escape sequence character has been defined as +, for the modem to recognise an escape sequence you must maintain silence on the line for one second, then type +++ in rapid succession, and then maintain another second's silence.

The guard time is in units of 20 milliseconds (or 1/50 of a second).

☛ ***S Register 12 is also used to time the period between the escape sequence characters as they are typed.***

If the period between the first and second escape characters or second and third escape characters being entered is greater than the value in S Register 12, the modem will not recognise the escape sequence.

Examples

ATS12=100 Maintain silence on the line for 2 seconds before and after entering the escape sequence

Default

50

See Also

S Register 2 Escape Sequence Character

Range

3-255

ATS16 Test in Progress (read only)

S Register 16 contains the number of the &T test command in progress. If no test is in progress S16 is 0.

Examples

ATS16

Default

0

See Also

&T	Self Test
S Register 18	Test Timer

Range

0-8

ATS18 Test Timer

S Register 18 contains the length of time, in seconds, that the modem will perform tests initiated with any of the &T commands.

You can terminate any test by issuing an AT&T0 command, or by allowing the time in the Test Timer to expire.

Placing a value of 0 in S Register 18 disables the Test Timer, forcing you to use an AT&T0 command to terminate tests.

Examples

ATS18=30 Terminate test after 30 seconds

Default

0

See Also

S Register 16 Test in Progress (read only)

Range

0-255

ATS25 DTR Loss Detection

S Register 25 determines the time, in hundredths of a second, the DTR (Data Terminal Ready) signal must remain low before the modem will recognise a loss of DTR.

Examples

ATS25=8 DTR must remain low for 0.08 seconds before the modem will recognise loss of DTR

Default

5

See Also

&D DTR mode

Range

0-255

ATS26 RTS/CTS Delay

If the RTS (Request To Send) signal is asserted when operating in synchronous mode, the modem will wait for the period defined by S Register 26 before asserting the CTS (Clear To Send) signal, when &R0 is selected.

Values in this register are in tenths of a second.

Examples

ATS26=15 Wait 1.5 seconds after RTS has been asserted before asserting CTS.

Default

0

See Also

&R RTS/CTS Control

%R CTS Control

Range

0-255

ATS27 Delay Before Dial

S Register 27 is used to define a delay of between 0 and 255 seconds which occurs after the D command is issued and before dialling commences.

This should only be used when you intend to implement callback security. Providing a delay between the dialling command and actual dialling allows the calling modem sufficient time to hang up before the modem begins to call back.

A 30-second delay should be sufficient time to allow most modems to hang up.

When you are not using security callback, this register should always contain a zero value.

☞ ***UK Modems. Waiting 30 seconds may not work with UK telephone exchanges. Consult the supplier of your telephone line for a solution.***

Example

ATS27=10 Wait 10 seconds between the Dial command being issued and commencement of the dialling

Default

0

Range

0-255

ATS29 Hook Flash Duration

This S Register allows you to set the duration of the hook flash performed by your modem when the ! dial modifier is executed.

Some PABXs may require a different hook flash length to the standard 0.5 seconds.

The value held in S Register 29 is in hundredths of a second.

Examples

ATS29=30 Set the hook flash duration to 0.3 seconds

Default

50

See Also

!Dial Modifier Hook Flash

Range

10-100

ATS30 Inactivity Timer

Data Mode

This S Register allows you to set the duration of the hook flash performed by your modem when the ! dial modifier is executed.

Some PABXs may require a different hook flash length to the standard 0.5 seconds.

The value held in S Register 29 is in hundredths of a second.

Examples

ATS30=60 Hang up after 10 minutes of inactivity on the line

Default

0

See Also

\T command Set Inactivity Timer

Range

0-255

Voice Mode

This S Register sets how long the modem remains in voice mode, when on-hook and in non-autobauding mode, and when no characters are received from the computer, in 1 second units.

If the 'Dead Man' timer expires, the modem returns to data mode.

If S30 is set whilst in voice mode, the value is redirected to S105, the voice dead-man timer.

Examples

ATS30=60 Set the dead-man timer to 60 seconds

ATS30=0 Disable the deadman timer

Default

30

See Also

ATS105Voice 'Dead-man' Timer

Range

0-255

ATS33 EQM Threshold Value

S Register 33 is used to define the rate of change in the EQM (Eye Quality Monitor) value the modem will tolerate before initiating an equaliser retrain sequence. This S Register applies to V.32, V.32bis, V.FC & V.34 only.

By setting this register with a low value, the modem will demand a high quality connection. Setting a high value in S33 will allow the modem to operate on degraded lines without invoking retrains.

A value of zero will also disable automatic EQM retraining for V.32, V.32bis, V.FC, & V.34.

☞ ***The value in this register should only be altered by people with previous EQM experience. Changing the EQM value will affect the data throughput and reliability of connections.***

ATS33=5 Set EQM change rate threshold to 5

Range

0-255

Default

3

Example

ATS38 Disconnect Delay

S Register 38 determines the number of seconds the modem will wait before hanging up after the ATH command is issued or the DTR signal is lowered — after the &D2 command has been issued. If a disconnect delay has been defined, the modem will attempt to empty the contents of its data buffers before actually going on-hook.

If the modem empties its buffers before the defined disconnect delay expires, the modem will hang up immediately.

The modem will respond with NO CARRIER, rather than OK, if S Register 38 is between 1 and 255 and the modem's buffers have not been emptied when it hangs up.

The length of the disconnect delay may be selected with the %D command.

Examples

ATS38=30 Wait 30 seconds before hanging up.

Default

0

See Also

%D command Set Disconnect Delay

Range

0-255

ATS42 Modem Disconnect Reason

S Register 42 contains a value indicating the reason the modem last disconnected.

This allows you to check for possible faults if your modem suddenly hangs up or returns to local command state without you entering an escape sequence.

The modem will return one of the following values in S Register 42:

Value	Meaning
0	Modem reset
1	An escape sequence was entered or DTR was lowered after the &D1 command was issued
2	DTR lowered by the computer after an &D2 or &D3 command was issued
3	Carrier lost from remote modem
4	Disconnect using the TALK/DATA switch
5	Connection failed or timed out
6	No answer tone detected
7	Connected at wrong speed
8	S Register 7 time limit exceeded
9	Receive data buffer (line buffer) overflowed
10	Receive data buffer (terminal buffer) overflowed
11	Failure to negotiate MNP class 3 or 4 connection
12	Inactivity timer expired
13	Unable to establish MNP connection with reliable mode selected
14	Retrain failed
15	A break sequence received from the remote modem after the Y1 command was issued
16	Character received while modem was attempting to establish a connection
17,18	Internal error — MNP
19	NORMAL MNP or V.42 disconnect. Disconnect request from remote modem
20	MNP disconnected after 12 attempts to send a packet
21-26	Internal protocol errors — MNP
27	Analog loopback switch asserted while on line
28	Security system rejected user
29	DES encryption could not achieve an error corrected connection
30	MNP10 rate fallback failed
31	CTS stuck (continuous retrains or data pump failure)
32	Incoming call: Access denied
33	LAPM protocol error
34	DES Multikey: Key and/or IV did not match remote modem
35	Too many retrains, unable to get a good connection
42	V.42bis received an invalid token
60	Fax completed successfully
61, 62	Fax error caused disconnect
63	Remote fax busy
99	Abnormal exit from on line state

ATS43 Break Sequence Length

The value in S Register 43 defines the length of a break (long space) sequence generated by the modem to your computer when constant speed, reliable or auto-reliable modes are selected.

The \B command determines the length of breaks to the remote modem.

Each unit is equivalent to 0.02 second.

☞ **S Register 43 does not affect the length of the break generated by the modem when variable speed mode is selected. In variable speed mode, the Y command controls the length of breaks generated by the modem.**

Examples

ATS43=10 Generate a break of 0.2 seconds

Default

15

See Also

Y command Long Space Disconnect

\B command Generate Break

Range

1-255

ATS45 V.22bis EQM Threshold Value

S Register 45 is used to define the EQM (Eye Quality Monitor) value the modem will tolerate before initiating an equaliser retrain sequence. This S Register applies to V.22bis only.

By setting this register with a low value, the modem will demand a high quality connection. Setting a high value will allow the modem to operate on degraded lines without invoking retrains.

A value of zero will disable automatic EQM retraining for V.22bis.

☞ ***The value in this register should only be altered by people with previous EQM experience. Changing the EQM value will affect the data throughput and reliability of connections.***

Default

98

Example

ATS45=5 Set EQM threshold to 5. If EQM level is equal to or greater than 5, the modem will retrain the connection.

Range

0-255

ATS57 DTR High Detection

S Register 57 determines the amount of time, in hundredths of a second, that the DTR (Data Terminal Ready) signal must be high before the modem will recognise DTR being asserted.

Example

ATS57=8 DTR must be high for 0.08 seconds before the modem will recognise DTR being asserted

Default

0

See Also

&D DTR Mode

Range

0-255

ATS62 V.42 Detection Timer

S Register 62 allows you to set the V.42 detection timer. This specifies how long (in units of 0.01 seconds) the modem will send a V.42 detection pattern and wait for a V.42 detection pattern from the other modem.

The originating modem sends the pattern then waits for a reply, the answering modem waits for the pattern then sends one in reply.

☛ ***Changing the value of this S Register may cause unreliable operation when attempting V.42 connections.***

Examples

ATS62=100 Set the timer to one second

Default

75 (0.75 second)

See Also

#J command V.42 Compatibility

Range

0-255

ATS66 Remote Access Guard Time

The Remote Access Guard Time is the time delay required immediately before and after entering a remote access sequence.

If the Remote Access Guard Time is one second and the remote access character has been defined as * (asterisk), you must maintain silence on the line for one second, then type **** (four asterisks) in rapid succession, then maintain another one second's silence.

The guard time is in units of 100 milliseconds (1/10th of a second).

Examples

ATS66=20 Set the remote access guard time to two seconds

Default

10

See Also

S Register 67	Remote Access Character
#A command	Universal Remote Access
**** command	Remote Access Sequence

Range

1-255

ATS67 Remote Access Character

S Register 67 contains the ASCII value of the characters which form the remote access sequence.

The default value of this register is 42 (asterisk character). The modem will recognise four * characters (****) as the remote access sequence.

Examples

ATS67=36 Recognise four \$ (\$\$\$\$) characters as the remote access sequence

Default

42 (the * character)

See Also

S Register 66	Remote Access Guard Time
#A command	Universal Remote Access
**** command	Remote Access Sequence

Range

1-125

ATS69 Command Line Time-out

S Register 69 determines how long you have to type a command, after typing an 'AT', expressed as seconds.

If the modem times-out before you complete a command, an ERROR message will be sent by the modem.

The default value of 60 allows you 60 seconds between the time you have typed 'AT' and when you press the ENTER key.

A value of 0 (zero) disables this feature.

Examples

ATS69=120 Allow 120 seconds to type a command to the modem before timing out.

ATS69=0 Never time-out a command

Default

60

Range

0-255

ATS71 Ignore Incoming Call

This S Register is only applicable when your modem is operating in V.25bis mode.

After an incoming call is detected, your modem will wait the number of seconds defined by S Register 71, allowing you to issue the DIC command if you do not wish to accept the call.

For more details, refer to the section titled 'Answering Calls' which appears in the 'V.25bis Operations' chapter.

Examples

ATS71=10 Wait 10 seconds before accepting an incoming call.

Default

0

See Also

CIC command Connect Incoming Call
DIC command Disregard Incoming Call

Range

0-30

ATS74 Disconnect Reason for Prev. Call

S Register 74 contains a value indicating the reason the modem returned to local command state, for the call before last.

Thus, the value in S Register 42 will be copied to S Register 74 prior to a new disconnect reason being placed in S Register 42. This register is mainly used to allow a remote modem to dial in, invoke remote access and enquire as to why the last connection failed.

For details of the disconnect reasons placed in S Register 74, refer to the description of S Register 42.

☞ ***This is a read only S Register.***

Examples

ATS74? Read the disconnect reason for the previous call

See Also

S Register 42 Modem Disconnect Reason

ATS80 Flow Control High Water Mark

This S Register controls when your modem uses flow control to stop data from your computer. Data to be sent by your modem is stored in a ‘buffer’ (a temporary storage area) until it can be sent by your modem. If the buffer begins to fill, your modem will use flow control to stop your computer sending more data.

S Register 80 allows you to set the level at which the modem will use flow control stop your computer sending more data. Unless you have a sound reason for doing so, the high water mark should never be set higher than 75%. Using a higher water mark may cause problems with computers that are slow to respond to your modem’s flow control.

Each unit is equivalent to 5% of your modem’s buffer.

☛ ***Do not change the value of this S Register unless you are an experienced communications user. An inappropriate value may cause flow control between your computer and modem to become unreliable.***

Refer to the chapter titled ‘Getting Started’ for details of flow control.

Examples

ATS80=12 Use flow control when the buffer becomes 60% full

Default

15 (75% of the buffer)

See Also

S Register 81 Flow Control Low Water Mark
&K command Flow Control

Range

1-19

ATS81 Flow Control Low Water Mark

This S Register controls when your modem uses flow control to resume the transmission of data from your computer.

Refer to S Register 80 for a description of flow control water marks.

Do not change the value of this S Register unless you are an experienced communications user. An inappropriate value may cause flow control between your computer and modem to become unreliable.

Each unit is equivalent to 5% of your modem's buffer.

Refer to the chapter titled 'Getting Started' for details of flow control.

Examples

ATS81=2 Use flow control when the buffer becomes 10% full 3 (15% of the buffer)

See Also

S Register 80 Flow Control High Water Mark
&K command Flow Control

Range

1-19

ATS82 Failsafe Flow Control Overrun

This S Register works in conjunction with the AT&K9 command. If you are in &K9 mode and the modem needs to assert flow control it first drops CTS. If the host is using CTS flow control it should stop sending further characters. If the host is using XOFF flow control it will ignore the CTS signal and keep sending data. S82 determines the number of characters the modem will accept after dropping CTS before sending XOFF. If the value is too low some hosts will not respond to the CTS quickly enough. If the number is too large the buffer might overflow.

Examples

ATS82=20 Accept 20 characters after CTS is dropped before sending XOFF

Default

60

See Also

S Register 80	Flow Control High Water Mark
S Register 81	Flow Control Low Water Mark
&K command	Flow Control

Range

1-255

ATS95 Extended Response Codes

S Register 95 allows your modem to display extended response codes (or result codes). Because this S Register is a 'bit-mapped' register, values must be changed by storing the decimal number equivalent of the binary value represented by the total of the bits.

Examples

ATS95=46 Displays the CARRIER, PROTOCOL and COMPRESSION messages and adds the /REL to the CONNECT message (assuming S Register 95 was previously set to zero)

See Also

W command Connection Messages Control
X command Extended Response Codes
Q command Quiet (Suppress Response Codes)

Range

0-255

ATS96 Help Page Width

This S Register allows you to set the width of each Help page and the Configuration Profile (&V).

You may change the width of each page to suit your computer.

Examples

ATS96=40 Set the Help page width to 40 characters

Default

80

See Also

S Register 97	Help Page Length
&V command	View Active Configuration Profile
?	Interactive Help

Range

1-255

ATS97 Help Page Length

This S Register allows you to set the length of each Help page and the Configuration Profile (&V).

You may change the length of each page to suit your computer.

Examples

ATS97=10 Set the Help page length to 10 lines

Default

24

See Also

S Register 96	Help Page Width
&V command	View Active Configuration Profile
?	Interactive Help

Range

1-255

ATS105 Voice 'Dead Man' Timer

This S Register sets how long the modem remains in voice mode, when onhook and in non-autobauding mode, and when no characters are received from the computer.

If the 'Dead Man' timer expires, the modem returns to data mode.

This register may also be accessed by writing to S30 when in voice mode.

Examples

ATS105=60 Set the dead-man timer to 60 seconds

ATS105=60 Disable the dead-man timer

Default

30

See Also

ATS30 'Dead Man' Timer (voice mode)

Range

0-255

ATS122 AutoRateChange

The maximum average EQM level reached before the modem will downshift a speed. The default is 55 which means that if the average EQM ever goes higher than 55, then a downshift in speed will occur.

☛ **EQM stands for Eye Quality Monitor, and is a reading of the current line quality.**

To view the current EQM, after connecting enter local mode by typing +++ and then type:

```
AT\V7<cr>.
```

You will be presented with a realtime reading from the modem similar to the following:

Speed EQM:	max min av hex limit Rx-Dbm S10 S09 C=cts loss S=rlsd loss 19200 075A 008 007 007 (07) 016 029 018 000
Speed:	the line speed currently connected at.
EQM:	the Eye Quality Monitor (a numeric reading of the line condition).
max:	maximum EQM reached for this connection.
min:	minimum EQM reached for this connection.
av:	average EQM (this is the value that the above S registers refer to).
hex:	hexidecimal reading of the EQM value.
Rx-Dbm:	the receive level that the modem is operating at.

Default

55

Range

30-100

ATS123 AutoRateChange

This S Register sets the average EQM limit that the modem must do better than, to achieve an upshift. The default is 16 which means that for an upshift to be possible the average EQM must be 16 or lower (for S124 + 12 seconds).

Default

16

Range

0-20

ATS124 Duration EQM

This S Register sets the number of seconds after 12 that the modem must maintain the average EQM below the S123 value. The default is 30 which means that for an upshift to be possible with a setting of S123=16, the modem must maintain an average EQM of below 16 for a minimum of 42 seconds.

Default

30

Range

1-255

Modem Response Codes

Numeric	Verbal	Meaning
0	OK	Command executed
1	CONNECT	Connection established
2	RING	Ringing signal detected
3	NO CARRIER	Carrier lost or not detected
4	ERROR	Command error, command longer than 80 characters or timeout
5	CONNECT 1200	Connection at 1200 or 1200/75 bps
6	NO DIALTONE	Dial tone not detected on line
7	BUSY	Number dialled was engaged
8	NO ANSWER	Quiet answer not detected
10	CONNECT 2400	Connection at 2400 bps
11	CONNECT 4800	Connection at 4800 bps
12	CONNECT 9600	Connection at 9600 bps
13	RINGING	Dialled number is ringing
20	CONNECT/REL	Error corrected connection at 300 bps
22	CONNECT 1200/REL	Error corrected connection at 1200 bps
23	CONNECT 2400/REL	Error corrected connection at 2400 bps
24	CONNECT 4800/REL	Error corrected connection at 4800 bps
25	CONNECT 9600/REL	Error corrected connection at 9600 bps
26	CONNECT 12000/REL	Error corrected connection at 12,000 bps
27	CONNECT 14400/REL	Error corrected connection at 14,400 bps
28	CONNECT 7200/REL	Error corrected connection at 7200 bps
30	CONNECT 12000	Connection at 12,000 bps
31	CONNECT 14400	Connection at 14,400 bps
32	CONNECT 7200	Connection at 7200 bps
33	CONNECT 16800	Connection at 16,800 bps
34	CONNECT 19200	Connection at 19,200 bps
35	CONNECT 21600	Connection at 21,600 bps
36	CONNECT 24000	Connection at 24,000 bps
37	CONNECT 26400	Connection at 26,400 bps
38	CONNECT 28800	Connection at 28,800 bps
95	CONNECT 31200	Connection at 31,200 bps
97	CONNECT 33600	Connection at 33,600 bps
39	CONNECT 38400	Connection at 38,400 bps
40	CONNECT 57600	Connection at 57,600 bps
43	CONNECT 16800/REL	Error corrected connection at 16,800 bps
44	CONNECT 19200/REL	Error corrected connection at 19,200 bps
45	CONNECT 21600/REL	Error corrected connection at 21,600 bps
46	CONNECT 24000/REL	Error corrected connection at 24,000 bps
47	CONNECT 26400/REL	Error corrected connection at 26,400 bps
48	CONNECT 28800/REL	Error corrected connection at 28,800 bps
96	CONNECT 31200/REL	Error Corrected connection at 31,200 bps
98	CONENCT 33600/REL	Error Corrected connection at 33,600 bps
49	CONNECT 38400/REL	Error corrected connection at 38,400 bps
50	CONNECT 57600/REL	Error corrected connection at 57,600 bps
60	CONNECT 76800	Connection at 76,800 bps
61	CONNECT 96000	Connection at 96,000 bps
62	CONNECT 115200	Connection at 115,200 bps
63	CONNECT 230400	Connection at 230,400 bps
70	CONNECT 76800/REL	Error corrected connection at 76,800 bps
71	CONNECT 96000/REL	Error corrected connection at 96,000 bps
72	CONNECT 115200/REL	Error corrected connection at 115,200 bps
73	CONNECT 230400/REL	Error corrected connection at 230,400 bps
165	CONNECT 32000/REL	Error corrected connection at 32,000 bps
166	CONNECT 34000/REL	Error corrected connection at 34,000 bps
167	CONNECT 36000/REL	Error corrected connection at 36,000 bps

168	CONNECT 38000/REL	Error corrected connection at 38,000 bps
169	CONNECT 40000/REL	Error corrected connection at 40,000 bps
170	CONNECT 42000/REL	Error corrected connection at 42,000 bps
171	CONNECT 44000/REL	Error corrected connection at 44,000 bps
172	CONNECT 46000/REL	Error corrected connection at 46,000 bps
173	CONNECT 48000/REL	Error corrected connection at 48,000 bps
174	CONNECT 50000/REL	Error corrected connection at 50,000 bps
175	CONNECT 52000/REL	Error corrected connection at 52,000 bps
176	CONNECT 54000/REL	Error corrected connection at 54,000 bps
177	CONNECT 56000/REL	Error corrected connection at 56,000 bps
178	CONNECT 28000/REL	Connection at 28,000 bps
179	CONNECT 29333/REL	Connection at 29,333 bps
180	CONNECT 30667/REL	Connection at 30,667 bps
181	CONNECT 32000/REL	Connection at 32,000 bps
182	CONNECT 33333/REL	Connection at 33,333 bps
183	CONNECT 34667/REL	Connection at 34,667 bps
184	CONNECT 36000/REL	Connection at 36,000 bps
185	CONNECT 37333/REL	Connection at 37,333 bps
186	CONNECT 38667/REL	Connection at 38,667 bps
187	CONNECT 40000/REL	Connection at 40,000 bps
188	CONNECT 41333/REL	Connection at 41,333 bps
189	CONNECT 42667/REL	Connection at 42,667 bps
190	CONNECT 44000/REL	Connection at 44,000 bps
191	CONNECT 45333/REL	Connection at 45,333 bps
192	CONNECT 46667/REL	Connection at 46,667 bps
193	CONNECT 48000/REL	Connection at 48,000 bps
194	CONNECT 49333/REL	Connection at 49,333 bps
195	CONNECT 50667/REL	Connection at 50,667 bps
196	CONNECT 52000/REL	Connection at 52,000 bps
197	CONNECT 53333/REL	Connection at 53,333 bps
198	CONNECT 54667/REL	Connection at 54,667 bps
199	CONNECT 56000/REL	Connection at 56,000 bps

V.25bis Indications

CFI AB	Call failure; abort
CFI ET	Call failure; engaged
CNX	Connection
INC	Incoming call
INV	Invalid
VAL	Valid

Glossary

A

ACK (Acknowledge)

Control Character transmitted by a receiving device as an affirmation to a sending device.

Alphanumeric

Roman Letters (alphabetic) and Arabic numbers (numeric).

Amplitude

The height of a waveform measured in volts.

Amplitude Modulation (AM)

Transmission of information by varying the amplitude of a carrier signal.

Analog Data

Data in the form of continuously variable physical qualities. Compare with Digital data.

Analog signal

A signal such as voice or music that varies in a continuous manner (smooth transitions to different levels).

ANSI

American National Standards Institute, primary standards development body in the USA.

ASCII

American Standard Code for Information Interchange. Pronounced as-kee. A code by which alphanumeric, punctuation and control characters, commonly found on computer keyboards, are each assigned a unique value between 0-127 (decimal).

Asynchronous

A data transmission in which the time between characters may vary. Characters are delimited by start and stop bits.

Attenuation

The loss of power through transmission equipment, lines or other communication devices.

Auto answer

A modem capability that allows automatic pick-up — by the modem — when the phone answers.

Auto dial

The ability to make a connection with another modem automatically. (To dial a number automatically, usually using a stored number.)

Auto range

The ability of a modem to range over several modem standards to determine the standard of the calling modem.

B**Bandwidth**

The range of signal frequencies that are accepted or passed by a circuit or network. (The normal bandwidth on a telephone line is 3100Hz.)

Baseband

The frequency band occupied by a signal in its original or unmodulated form.

Baud

This term represents the number of signal elements per second. Because a signal element can represent more than one bit, this term is not equivalent to BPS (bits per second), although it is often used in this way. Compare with bit rate.

Baud Rate

Number of discrete signalling events per second; not necessarily the same as bits per second. For example, a V22bis, 2400 bps modem uses a 600 baud by 4-bit encoding scheme.

Baudot Code

Code for transmitting data using five bits to represent a single character.

BBS

An acronym for Bulletin Board System. See Bulletin Board.

Binary

A number system with a base of two, using the digits 0 and 1. Commonly used in computers since the values 0 and 1 can easily be represented as OFF and ON in electrical circuits.

Binary Synchronous Communications (BSC or BiSync)

A communications protocol developed by IBM which has become an industry standard. It uses a defined set of control character sequences for synchronized transmission of data.

Bit

The smallest piece of information in a binary number system. The word stands for Binary digIT.

Bit rate

The speed at which bits are transmitted, usually expressed as bits per second (BPS).

Block

Group of characters treated as a unit for the purpose of data transmission.

BPS

An acronym for Bits Per Second. Transmission rate of binary numbers. Compare with Baud.

Break

A special, non-data signal used by computer equipment to interrupt some processes.

Buffer

Temporary storage area used to compensate for a difference in the rate of data flow into and out of a device.

Bulletin Board

A generic term covering a wide variety of on line information services. Many bulletin boards are open to the public, run at no cost to users and provide the ability to download public domain software and exchange electronic mail.

Byte

A grouping of bits to specify a single character usually consisting of eight consecutive bits. See also Bit.

C**Carrier signal**

An analog signal of known specifications, such as level and frequency, which is modulated by another signal containing information to be transmitted. This is the high-pitched sound you can hear when you first connect to a remote system.

Carrier Detect

An RS-232 interface signal from the modem to a terminal or personal computer indicating that the modem is receiving a signal from a remote modem. See also DCD.

Channel

An electronic communications path. A voice grade channel generally ranges from 300 to 4000 Hz.

Character

A letter, number or other symbol contained in a message or used in a control function. See Byte.

Character Set

The characters that can be coded or used by a particular machine.

Clear to Send (CTS)

An RS-232 control signal sent by the DCE to indicate that the DTE may begin a transmission.

Clock

Source of timing signals used in synchronous transmission.

Code

A predefined set of rules specifying the way data is to be represented by the transmitting and receiving device.

Common Carrier

Telephone company that furnishes communications services to the general public.

Conditioning

The addition of equipment to a leased voice-grade line to improve the transmission characteristics of the line.

Conferencing

A form of bulletin board that allows real-time communication between multiple users. In the U.S.A., conferencing systems have been established to allow large numbers of individuals to simultaneously discuss a wide range of specialised topics and interests.

Connector

A physical devices, such as a plug, socket or jack, used to connect one hardware component of a system to another. A connector may also be called a port.

Connect Time

The amount of time spent on line with an information service.

Console

Part of a computer system, usually a video display terminal, used by the operator to communicate with the computer.

Contention

Condition arising when two or more devices try to transmit at the same time using the same channel.

Control Character

Any character assigned as ASCII numeric code less than the SPACE character. These characters are used to initiate a control function on the receiving device. Also a symbol you can create by pressing one of your computer's keys while holding down the Control key. These symbols are not usually printed, and are generally used to control screen formatting and cursor positioning.

CPU

Central Processing Unit. The computer hardware which processes software instructions to control the computer system and its peripherals.

CRT

Cathode Ray Tube. This term is commonly used to stand for the video display terminal.

CTS

An acronym for Clear To Send. This signal is generated by a modem in response to RTS to indicate that a communications channel has been established and that data can be sent.

Cyclic Redundancy Check

An error-detection technique in which a data validation value is mathematically derived from a block of data and transmitted at the end of the block. The receiving end recomputes the value and if it matches the value sent, the data is assumed to be valid (error-free). If not, the receiver notifies the transmitter that an error has occurred and the block is retransmitted.

D

Data

Any type of information, such as numbers, letters and symbols, that can be processed by a computer.

Database

A source or collection of information. In the context of communications, a dialup service from which users can exchange or retrieve information.

Data Bits

The actual characters being transmitted between two computers when asynchronous communications is being used. Usually 7 or 8 data bits are used.

Data Communications

A broad term covering any exchange of information between computers or similar systems over telephone lines.

Data Communications Equipment

Equipment that is used to access a communications network. The DCE provides all the functions required to establish, maintain and terminate a connection, and provides the signal conversion required for communications between the Data Terminal Equipment (DTE) and the telephone network. With RS-232 connections, the modem is generally the DCE device while the computer or terminal connected to a modem is generally the DTE device. See also Data Terminal Equipment.

Data Compression

An encoding technique which provides for the transmission of fewer data bits without the loss of information. The receiving end expands the data received to its original form.

Data Set

See Data Communications Equipment and Modem.

Data Set Ready (DSR)

An RS-232 control signal used to indicate the readiness of the DCE (Usually a modem) to accept data from the DTE (usually a terminal or computer).

Data Terminal Equipment (DTE)

The equipment which provides the data source and/or receiving end of a data transmission link. The DTE may be a CRT or teletype terminal, a personal computer, a printer, a front-end processor to a large mainframe computer or any other device which can transmit or receive data. With RS-232 connections the designation of DTE or DCE determines which device is responsible for generating certain control signals. See also Data Communications Equipment.

Data Terminal Ready (DTR)

An RS-232 control signal used to indicate the readiness of the DTE for data transmission.

DCD

An acronym for Data Carrier Detect. See also Carrier Detect.

DCE

An acronym of Data Communications Equipment. See Data Communications Equipment.

Decibel (dB)

Unit of measure indicating the logarithmic ratio of output signal power to input signal power.

Dedicated Line

A communications line which is not dialled. Also known as a leased or private line.

Default

A value, action or setting that is automatically used by a computer system when no other explicit information has been given.

Demodulate

To recover the information being transmitted by a modulated signal. For example, a conventional radio receiver demodulates an incoming broadcast signal to convert it into sound emitted by a speaker. See also Modulate and Modem.

Device

A piece of equipment connected to a computer — maybe a Fax Card or Modem.

Dial-up

Establishing a temporary connection to a remote system or computer via the public switched telephone network.

Dial Tone

A call progress signal returned by a telephone switching machine to indicate that it is ready to accept a telephone number.

Dibit

A grouping of two bits.

Digital Signal

A signal composed of discrete signal levels as opposed to the continuous signal levels of an analog signal.

Direct Keying

In videotex terminology direct keying refers to accessing a page by specifying its page number rather than using index pages.

Distortion

Undesired change in a signal's original waveform resulting from the characteristics of the transmission circuits or other external influences.

Downloading

See Software Downloading.

DTE

An acronym of Data Terminal Equipment. See Data Terminal Equipment.

Double-Digit Keying

Pressing two number keys in rapid succession to access a page in a videotex system. The first number accesses an intermediate index (see Intermediate Page) which in turn accesses the page. See also Single-Digit Keying.

Dumb Terminal

Terminals that do not contain an intelligent microprocessor and usually send data one character at a time.

Duplex Transmission

Independent, simultaneous, two-way transmission.

E

EBCDIC

Extended Binary Coded Decimal Interchange Code. An eight bit code used primarily by IBM equipment.

Echo

The re-transmission of characters received by either the modem or remote system back to the DTE.

Echoplex

Method of verification of transmitted data by echoing the characters transmitted back to the source device for verification. Echoplex is sometimes called remote echo and, erroneously, half-duplex.

EEPROM

Electrically Erasable Programmable Read Only Memory.

EIA

Electronic Industries Association. Organisation in the USA that sets standards for the functional characteristics of electronic interfaces.

Electronic Mail

A means by which users of a particular bulletin board or videotex system can send messages to other users of that system. Some dial-up services deal exclusively with providing electronic mail facilities.

E-MAIL

See Electronic Mail.

ENQ

Control character used to enquire as to the identification or status of a remote device.

Even Parity

Even parity refers to the addition of a 0 value or 1 value bit to the data bits which form a character to cause an even number of 1 value data bits to be sent. See also Parity.

ETX

Control character which indicates the End of Text in a transmitted message.

F

Firmware

Computer program stored permanently in Read Only Memory.

Forward Error Correction (FEC)

Technique of transmitting additional information with the original data so that if small errors are detected the correct information can be recreated by the receiving end without requiring a re-transmission.

Frame

See Block.

Frequency Modulation (FM)

A method of transmitting information by varying the carrier frequency.

Frequency Shift Keying

A form of frequency modulation in which the frequency of the carrier is shifted between two frequencies to represent digital data.

Front-end Processor

Computer equipment designed primarily for communications control associated with a large mainframe.

Full Duplex

Data transmission which allows data to flow in two directions at the same time.

G

Gateway

An electronic connection of some type, generally transparent to the user, by which multiple computers can be connected together.

Graphics

Information in the form of pictures or images. Also, the display of pictures or images on a computer's display screen.

Guard Band

Narrow frequency band left unused between adjacent channels to minimize interference.

H

Half Duplex

Data transmission in which data may flow in either direction at one time, but not both directions simultaneously. Transmission direction is alternatively switched to allow two way flow of data.

Handshake

A predetermined interchange of signals between two devices to establish conditions for a transfer of data.

Hardware

The electronic or electro-mechanical devices in a computer system as opposed to the programs or software.

Hardware Handshaking

The use of special RS-232 signals to halt or commence the flow of data between two computers or terminals, between computers and modems or between facsimile machines. See also Software Handshaking, RTS and CTS

Harmonics

Frequencies which are integer multiples of some fundamental frequency.

Harmonic Distortion

A line impairment caused by equipment which distorts the original signal at multiples of the same fundamental frequency.

Hexadecimal Numbers

A number system with a base of 16. The first ten digits are represented by 0- 9 while the last six digits are represented by A-F. Hexadecimal numbers can be easily translated from binary numbers and are easier for humans to understand and read than are binary numbers.

HDLC

High Level Data Link Control. Communications protocol developed by the International Standards Organization.

Header

In communications protocols, this is the control information that precedes the message or text portion of a block of data.

Hertz (Hz)

Unit of frequency, one cycle per second.

Horizontal Redundancy Checking (HRC)

Technique in which redundant information is included with a block of data for validating the transmitted data at the receiving end.

Host Computer

A computer that manages information for many terminals. A host computer may be mainframe, minicomputer or a microcomputer.

I

ID Name

See ID Number.

ID Number

A security code, used mainly with remote systems that either charge a subscription fee, allow the purchasing of goods and services on line or both. The code is known only to the user and protects the user from unauthorised access to her/his account. See also Password.

Input

Information transferred into a computer from some external source, such as the keyboard, a disk drive, a modem or a scanner. Also, the act or process of transferring such information.

Input/Output Device

A device that transfers information into or out of a computer.

Interface

A physical point of interconnection between two devices where electrical signal levels, timing, handshaking and pin numbers are defined. The devices, rules or convention by which one component of a system communicates with another.

Interference

Undesirable disturbances or distortions in a data transmission signal.

Intermediate Page

An index page which, when used with another index page, allows users to perform double-digit keying.

I/O

Input/Output. The transfer of information into and out of a computer.

ISO

International Standards Organization.

ITU

International Telecommunications Union (formerly known as CCITT). ITU is the principal communications standards organisation.

J

Jack

A socket used for telephone line or other electrical connections.

K

Kermit

Kermit is a file transfer protocol developed for operating systems which could not support the XModem protocol. Kermit was developed at Columbia University in 1981.

Keying

Videotex systems only. Refers to pressing of numeric keys to access an item from an index.

L

Leased Line

A telephone line permanently connecting two or more locations. It does not have any switching equipment associated with it and runs between specific, fixed locations. Also known as a private line.

LED

Acronym for light emitting diode. See Light Emitting Diode.

Light Emitting Diode

A diode which glows when a current flows through it. Often used as an indicator light.

Link

A circuit or transmission path, including all equipment, between a sender and a receiver.

Local Echo

A method of communication in which your modem or software displays data locally on your screen, without relying on the host computer to echo the characters back.

Log on

To connect to or access a bulletin board or videotex system.

Log Off

To disconnect from a bulletin board or videotex system.

Longitudinal Redundancy Check

Error detection technique that consists of a byte where each bit is calculated on the basis of the parity of all bits in the block in the same position.

Loopback

Directing signals back toward the source at some point in the communications path.

M**Mailbox**

A term used to describe the holding, by a bulletin board, videotex or electronic mail system, of electronic messages (mail) for a user. Usually, the system will announce if the user has any unread mail when she/he logs on.

Mainframe

Large scale computer system composed of a large number of peripherals and comprehensive software.

Mark

One of the two possible states of a binary data element. The closed circuit and idle condition in a teleprinter circuit. Also see Space.

Modem

Modulator/Demodulator. A device to convert data from a computer or terminal into a form suitable for transmission across a telephone system.

Modem Eliminator

A usually passive device which takes the place of a modem between a local terminal which requires a modem and a computer.

Modulate

To modify or alter a signal so as to transmit information. For example, conventional broadcast radio transmits sound by modulating the amplitude (Amplitude Modulation, or AM) or the frequency (Frequency Modulation, or FM) or a carrier signal. See also Demodulate and Modem.

Monitor

A program or device used to observe an operation without interfering with the operation.

Multidrop Line

Single communications circuit interconnecting many stations (nodes) each containing terminal devices.

Multiplex

To interleave or simultaneously transmit two or more messages on a single channel.

N**NAK**

Negative Acknowledgement. This control character indicates that the last block transmitted was in error and that the receiver is expecting a retransmission.

Node

A point of interconnection on a circuit.

Noise

Random electrical signals introduced by components of the circuit or natural disturbances which can produce errors in transmission.

Null Modem

See Modem Eliminator.

O**Odd Parity**

Odd parity refers to the appending of a 0 or 1 value bit to the data bits of a character to ensure that an odd number of 1 value bits are sent. See also Even Parity and Parity.

Off line

Describes equipment and activities connected to, but not currently accessible by, a computer.

On line

Describes activities and equipment currently connected to an accessible by a computer.

P**PABX**

Private Automatic Branch Exchange. An automatic switchboard for handling large concentrations of telephones (extensions).

Packet

Group of bits including data and control elements that are transmitted as a whole.

Packet Switched Network

System where messages are transmitted in packets, each individually addressed and routed through the network.

Packetised Ensemble Protocol (PEP)

A patented data transmission technique used by the TrailBlazer modem to transmit data at up to 18000 bps on the switched telephone network.

Parity

A simple method of error checking by which the number of data bits received are added together to ensure that the correct number have been received. Most bulletin boards do not use any parity checking.

Password

A second-level security device, generally being a set number of characters. The length and types of passwords used with bulletin boards varies from one system to another. On most videotex systems a four character password is used. See also ID Number.

PBX

See PABX.

PEP

See Packetised Ensemble Protocol.

Peripheral

(Or peripheral device). A device, such as a video monitor, disk drive, printer or modem, used in conjunction with a computer. Often (but not necessarily) physically separate from the computer and connected to it by wires, cables or some other form of interface.

Phase Modulation (PM)

A method of modulating the carrier wave based on the data by varying the phase relationship of the signal elements.

Point-to-point

A connection between two points as opposed to a multipoint or multidrop line.

Port

The point of connection, usually a physical connector, between a computer and a peripheral device, another computer or a network.

Private Line

See Leased Line.

PROM

Programmable Read Only Memory.

Propagation Delay

The time required for a signal to travel from one end of a circuit to another.

Protocol

A set of conventions controlling the timing and format of data communications between two pieces of communications equipment.

Protocol Convertor

Device that converts from one protocol to another.

Public Domain Software

Software from which its author has relinquished copyrights. This software is free of charge and may be distributed for non-commercial purposes. Many bulletin boards and videotex systems carry public domain software for users to download. See also Shareware.

Public Switched Network

Telephone system providing circuit switching to many customers.

Pulse

An abrupt and relatively short change in voltage, either positive or negative, resulting in the conveyance of data in a circuit.

Q**Quadrature Amplitude Modulation (QAM)**

A modulation technique which employs both amplitude and phase modulation to encode multiple bits in a single element.

R**RAM**

Random Access Memory.

Received Line Signal Detector

See Carrier Detect.

Redundancy Check

Technique of error detection involving the transmission of additional data related to the message so that the receiving device can determine if the data transmitted is valid (error-free).

Remote System

Usually a bulletin board or videotex system that registered users or the public can dial up and communicate with via modem.

Request to Send

RS-232 control signal by the DTE to inform the DCE that it is ready to transmit data. When used for flow control between the DTE and the modem, this signal indicates to the modem that the DTE is ready to accept data.

Ring Indicator

RS-232 control signal used by the DCE to inform the DTE that it is receiving a ringing signal.

ROM

Read Only Memory.

RS-232C

Frequently shortened to RS-232. A standard which defines the physical and electrical interface between Data Communications Equipment and Data Terminal Equipment. The most commonly used interface between modems and computers. Also known as CCITT V24.

RTS

An acronym for Request To Send. This signal is generated by the terminal or computer indicating that it requires to send data to the modem. Used mainly in half-duplex communications.

S

SDLC

The standard Synchronous Data Link Control protocol used by IBM for products which conform to its System Network Architecture.

Serial Data

Data transmission in which each bit of information is sent sequentially through a single data path.

Shareware

An extension of public domain software. Individuals can obtain copies of software for free from bulletin boards or other computer users. If the software is useful to them, they are encouraged to send a small fee to the program's author, usually for a printed manual, registration and any software updates that are available. See also Public Domain Software.

SIG

An acronym for Special Interest Group. Groups of user's who share an interest in a particular topic. Often SIGs set up bulletin boards, available only to SIG members.

Simplex

Data communications in one direction only.

Single-Digit Keying

Refers to videotex systems where you only need to press one numeric key from an index. See also Double-Digit Keying.

Software

Computer program or set of computer programs held in storage, and loaded into RAM for execution.

Software Downloading

Known as software downloading or teleloading on videotex systems and downloading on some bulletin boards. Refers to the transferring of software from a remote system to your computer.

Software Handshaking

A method of controlling the flow of data between two computers or terminals. Special control characters are sent from one terminal to the other in order to halt or re-commence the flow of data. See also Hardware Handshaking.

SOH

Start Of Header used in synchronous transmissions indicating the start of a header block.

Space

One of the two possible states of a binary data element. The open circuit condition in a teleprinter circuit. Also see Mark.

Special Interest Group

See SIG.

Start Bit

When a character is transmitted asynchronously to another computer, a start bit always precedes the actual data. Seven or eight data bits, an optional parity bit and a stop bit will follow.

Stop Bit

The last bit or element transmitted in asynchronous transmission of a character to return the circuit to an idle state. One or two stop bits are sent at the end of each character of data.

STX

Start Of Text control character used in synchronous transmission which precedes the text portion of the data block.

SYN

Synchronous Idle control character transmitted when the line is idle in synchronous transmissions.

Synchronous

A data transmission in which the time between characters is fixed by synchronising the transmitting and receiving communications equipment. The clock signal is typically derived from the data stream in order to maintain synchronisation.

Sysop

System Operator. This is the person or organisation who controls and maintains a videotex or bulletin board system. Most bulletin board systems display the name of their individual sysops when you first log on.

T

Telecommunications

The transmission of information across long distances, such as over telephone lines.

Tele-downloading

See Software Downloading.

Teleload

See Software Downloading.

Teletext

A non-interactive information system that was the predecessor to videotex systems. Teletext terminals consist of a specially modified television set and keypad to provide 24 lines of 40 column colour text and graphics. Connection is made to teletext systems by specially assigned television broadcast channels, hence the need to use a television set. Videotex terminals cannot access the information contained in a teletext system.

Terminal

An input/output device consisting of a typewriter-like keyboard and a display device, used for communicating with a large computer. Any device capable of sending and/or receiving data over a communications channel.

Terminal Emulation

Refers to the type of ASCII terminal your software will imitate (the control characters used to perform certain screen and cursor movement tasks vary from one terminal to another).

Text

The message portion of a data block in synchronous data transmissions.

Turnaround Time

The time required to reverse the direction of transmission when operating in half duplex mode.

U

Upload

Refers to sending files or text from the user's computer to another user, a bulletin board or videotex system. (Many bulletin boards that offer public domain software encourage users to upload their own programs so that other users can download them).

V

Vertical Redundancy Check (VRC)

A method of character parity checking.

Videotex

An interactive information system which is also known as Videotext or Viewdata. Videotex systems usually operate over switched telephone lines and allow 40 columns by 24 lines of colour text and graphics to be displayed on the screen. Information is arranged in pages, each page having a unique page number. Well known videotex systems include Prestel (Britain), Discovery 40 (Australia), and Minitel (France). See also Teletext.

Videotext

See Videotex.

Voice Grade Line

Channel with a frequency range of 300 to 3400 Hz suitable for the transmission of speech or data in analog form.

X

XModem

A communications protocol developed in the late '70s by Ward Christensen to perform error checking on data being sent between two computers.

XON/XOFF

Special control characters used to control the flow of data between your computer and a remote system. See Software Handshaking.

Y

Y Modem

An extension of the original XModem transfer protocol. Added features included transfer of file names, multi-file transfers, increased reliability of error checking and increased data throughput.

Z

ZModem

Designed to rectify some of the limitations associated with YModem as well as providing support for high speed, packet and network communications environments.

Specifications

Dimensions

Height: 31mm

Length: 218mm

Width: 122mm

Communications

V.90 56,000bps

ITU-T V.34 (2400-33600bps)

ITU-T V.32bis (4800-14400bps)

ITU-T V.32 (4800-9600bps)

ITU-T V.22bis (2400bps)

ITU-T V.22 (1200bps)

ITU-T V.23 (1200/75bps)

ITU-T V.21 (300bps)

Bell 212A (1200bps)

Bell 103 (300bps)

Terminal Speeds

300bps - 460,800bps

Power Requirements

15V Ac 6Va Plug Pack - Supplied
or 12~18VDC.

Caller ID

Austel TS 030

Bellcore MDMF message format

Command Sets

AT commands

V.25bis commands

Data Formats

Synchronous, Asynchronous: 7/8 data bits

Flow Control RTS/CTS, XON/XOFF and

Transparent XON/XOFF (async mode only)

Error Correction

V.42, MNP 2-4, MNP10

Data Compression

V.42bis, MNP 5

Encryption

DES 64-bit Cypher Feedback (Aust only)

SuperSecure

Environmental

Operating: 0° to +45° C

Non-operating: -10° to +50°C

Humidity

Operating: 10% to 90% noncondensing

Non-operating: 5% to 90% non-condensing

Registering your NetComm Product

To ensure that the conditions of your warranty are complied with, please go to the NetComm web site for quick and easy registration of your product at

www.netcomm.com.au

Alternatively, you can fill in the Warranty Registration Form and mail it to NetComm Limited, PO Box 1200, Lane Cove NSW 2066.

Contact Information

If you have any technical difficulties with your product, please do not hesitate to contact NetComm's Customer Support Department.

Email: support@netcomm.com.au

Fax: (02) 9424-2010

Web: www.netcomm.com.au

Product Warranty

The warranty is granted on the following conditions:

1. This warranty extends to the original purchaser (you) and is not transferable;
2. This warranty shall not apply to software programs, batteries, power supplies, cables or other accessories supplied in or with the product;
3. The customer complies with all of the terms of any relevant agreement with NetComm and any other reasonable requirements of NetComm including producing such evidence of purchase as NetComm may require;
4. The cost of transporting product to and from NetComm's nominated premises is your responsibility; and,
5. NetComm does not have any liability or responsibility under this warranty where any cost, loss, injury or damage of any kind, whether direct, indirect, consequential, incidental or otherwise arises out of events beyond NetComm's reasonable control. This includes but is not limited to: acts of God, war, riot, embargoes, acts of civil or military authorities, fire, floods, electricity outages, lightning, power surges, or shortages of materials or labour.
6. The customer is responsible for the security of their computer and network at all times. Security features may be disabled within the factory default settings. NetComm recommends that you enable these features to enhance your security.

The warranty is automatically voided if:

1. You, or someone else, use the product, or attempts to use it, other than as specified by NetComm;
2. The fault or defect in your product is the result of a voltage surge subjected to the product either by the way of power supply or communication line, whether caused by thunderstorm activity or any other cause(s);
3. The fault is the result of accidental damage or damage in transit, including but not limited to liquid spillage;
4. Your product has been used for any purposes other than that for which it is sold, or in any way other than in strict accordance with the user manual supplied;
5. Your product has been repaired or modified or attempted to be repaired or modified, other than by a qualified person at a service centre authorised by NetComm; and,
6. The serial number has been defaced or altered in any way or if the serial number plate has been removed.

Limitations of Warranty

The Trade Practices Act 1974 and corresponding State and Territory Fair Trading Acts or legislation of another Government ("the relevant acts") in certain circumstances imply mandatory conditions and warranties which cannot be excluded. This warranty is in addition to and not in replacement for such conditions and warranties.

To the extent permitted by the Relevant Acts, in relation to your product and any other materials provided with the product ("the Goods") the liability of NetComm under the Relevant Acts is limited to, at the option of NetComm to:

- Replacement of the Goods; or
- Repair of the Goods; or
- Payment of the cost of replacing the Goods; or
- Payment of the cost of having the Goods repaired.

All NetComm ACN 002 490 486 products have a standard 12 months warranty from date of purchase. However some products have an extended warranty option (refer to packaging). To be eligible for the extended warranty you must supply the requested warranty information to NetComm within 30 days of the original purchase by registering on-line via the NetComm web site at www.netcomm.com.au.

NetComm reserves the right to request proof of purchase upon any warranty claim.

Legal & Regulatory Information

Copyright Information

This manual is copyright. Apart from any fair dealing for the purposes of private study, research, criticism or review, as permitted under the Copyright Act, no part may be reproduced, stored in a retrieval system or transmitted in any form, by any means, be it electronic, mechanical, recording or otherwise, without the prior written permission of NetComm Limited.

NetComm Limited accepts no liability or responsibility, for consequences arising from the use of this product.

NetComm Limited reserves the right to change the specifications and operating details of this product without notice.

NetComm is a registered trademark of NetComm Limited.

All other trademarks are acknowledged the property of their respective owners.

Australian Customer Information

ACA (Australian Communications Authority) requires you to be aware of the following information and warnings:

Users may experience minor audio distortion when using te VoiceModem series. This distortion may be generated by the low bit rate for voice sampling when using either the headset or hands free operation.

Some of the modem default settings have been selected to comply with Austel technical specifications.

If you intend to change any default settings you must comply with the following rules:

- The modem must not answer an incoming call less than two seconds after the first ring signal. As a "rule-of-thumb" your modem should be set so it answers incoming calls after the second ring (ATS0=2).
- If Busy signal detection is switched off, the modem must not attempt more than two automatic redials and must wait at least two seconds before redialling.
- If Busy signal detection is switched on, the modem must not attempt more than nine automatic redials and must wait at least two seconds before redialling.
- If, after redialling the maximum number of times, the modem is still unable to establish a connection you must wait 30 minutes before attempting to redial.
- The use of Bell standard 103 and 212A is not permitted in Australia. Use of these modes will cause your modem to lose its permit status.

Changing the default values of the modem, in such a way as to cause your modem to operate in a noncompliant manner when connected to a telecommunications network operated by a carrier, is contrary to the Telecommunications Act and may result in penalties of \$12,000.

The Telephone Line Cord used with this unit must comply with the ACA Technical Standard TS008.

New Zealand Customer Information

New Zealand Telecom requires you to be aware of these important warnings:

This equipment may not necessarily provide for the effective hand-over of a call to or from a telephone connected to the same line.

The operation of this equipment on the same line as telephones or other equipment with audible warning devices or automatic ring detectors will give rise to bell tinkle or noise and may cause false tripping of the ring detector. Should such problems occur, the user is not to contact Telecom Faults Service.

The telephone associated with the authorised apparatus must be permitted for connection to the New Zealand public telephone network.

The transmit level from this device is set at a fixed level and because of this there may be circumstances where the device does not give its optimum performance. Before reporting such occurrences as faults, please check the line with a standard Telepermitted telephone, and do not report a fault unless the telephone performance is impaired.

If your modem ever suffers physical damage that causes its internal parts to become exposed, it should be disconnected from the phone line immediately. The modem must then be repaired before reconnection to the phone line is permissible.

Should it be necessary to physically move your modem, disconnect it from the phone line or earthing lead before disconnecting the power connection. When reconnecting your modem, reconnect the power or earthing lead before reconnecting it to the phone line.

Some parameters required for compliance with Telecom's PTC Specifications are dependent on the equipment connected to the RS 232 port. The connected equipment shall be set to operate within the following limits for compliance with Telecom Specifications:

1. Equipment connected to the RS 232 port shall be certified to meet the requirements of Reg. 18 of the New Zealand Wiring Regulations 1976.
2. When the user manually initiates a call, via equipment connected to the RS232 port, the equipment shall operate within the following restrictions:
 - a. Not more than 5 call attempts shall be made to the same number within a one hour period.
 - b. There shall be at least 60 seconds between call attempts.
 - c. Not more than a total of 10 call attempts shall be made to the same number for any single manual call initiation.
 - d. Automatic calls to different numbers shall be not less than 5 seconds apart.

FAILURE TO MEET THE ABOVE REQUIREMENTS MAY NEGATE THE USER RIGHTS UNDER THE TELECOM TERMS OF SERVICE.

When operating in V.22bis or V.22 mode over some older telephone exchanges, it may be necessary to issue the &G2 command.

Setting the S0 register (auto-answer) to S0 = 1 or to values greater than 5 will render this equipment non-compliant with the Telepermit requirements.

This equipment does not provide a guard tone with the V.22 and V.22bis answer modes. In some circumstances this could cause interference with the telephone network signalling systems, and could result in lost calls. Telecom will not accept responsibility should such problems occur. Such occurrences will be rare.

The preferred method is to use DTMF tones (ATDT...) as this is faster than pulse (decadic) dialling, and is available on most New Zealand telephone exchanges. Where DTMF is not available and decadic must be used, your communications software must be set up to record numbers according to the following translation table as the modem is not directly compatible with the New Zealand (10-N) Reverse dialling standard.

Number to be dialled	Number to program into computer 0 0
1	9
2	8
3	7
4	6
5	5
6	4
7	3
8	2
9	1

Note that where DTMF dialling is used, the numbers should be entered normally.

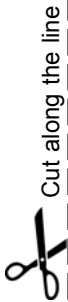

Cut along the line

Warranty Registration Form

Date of Purchase

Name

Company

Address

..... Post Code

Tel No () Fax No ()

E-mail

The following information is vital for your warranty

Please make sure it's correct and complete.

Serial No

Model

Product Type:

<input type="checkbox"/> PC Card	<input type="checkbox"/> External
<input type="checkbox"/> Internal	<input type="checkbox"/> Other

Make sure you fill this section in!

I intend to use this modem at:

<input type="checkbox"/> Home	<input type="checkbox"/> School/College/University
<input type="checkbox"/> Business	<input type="checkbox"/> Government Office

Dealer's Name

Dealer's Address

..... Post Code

Tel No () Fax No ()

How did you find out about our products?

.....

.....

SmartModem 56

Connect to the world with NetComm's SmartModem56 – the 7th generation of the renowned, Australian-designed SmartModem family. Whatever your communication needs, SmartModem56 will fulfill them – faster and more reliably.

MISSION CRITICAL RELIABILITY

SmartModem56 has been designed to perform mission-critical communications operations, quickly, safely and reliably. When you have to rely on your data comms, you can rely on NetComm SmartModem56.

FASTER DATA PROCESSING

SmartModem56 incorporates the latest processor and data compression technology to ensure the maximum throughput with minimal overhead on your PC or server processor.

CORPORATE GRADE SECURITY

Mission-critical operations almost invariably involve high data security requirements, so SmartModem56 incorporates the latest in security features, including dial-back, password protection, dial-out restrictions and 64 Bit DES encryption with Super Secure enhanced key management.

COMPLETE COMPATIBILITY

The NetComm SmartModem56 is fully compatible with all data transmission protocols, including 56klex and V.90, and includes an extensive command set to ensure compatibility with all hosts.

MAXIMUM DEPLOYABILITY

NetComm SmartModem56 will perform in any environment, you choose to deploy it. It includes support for synchronous and asynchronous communications, as well as for both leased line and PSTN operation.

FLASH ROM UPGRADABLE

NetComm SmartModem56 comes with Flash ROM, so you can keep your modem up to date and efficient, within the V90 standard.



THE ADVANCED MODEM FOR MISSION-CRITICAL SECURE COMMUNICATIONS

3 YEAR WARRANTY*

1 year warranty out of the box.
Extra 2 years **FREE** with online
registration at www.netcomm.com.au
* Conditional upon registration online.

NetComm is Australia's own data communications and networking solutions provider. For more information on this and other NetComm products, please visit www.netcomm.com.au

NetComm Limited, ABN 85 002 490 486 • PO Box 1200, Lane Cove NSW 2066 Australia.

PHONE (02) 9424 2070 • FAX (02) 9424 2010 • EMAIL sales@netcomm.com.au

www.netcomm.com.au

Trademarks and registered trademarks are the property of NetComm Limited or their respective owners. Specifications are subject to change without notice. Product Code: **SM5695**