



Tempest i5000PX



S5380

Version 1.0

Copyright

Copyright © TYAN Computer Corporation, 2006. All rights reserved. No part of this manual may be reproduced or translated without prior written consent from TYAN Computer Corp.

Trademark

All registered and unregistered trademarks and company names contained in this manual are property of their respective owners including, but not limited to the following.

TYAN, Tempest i5000PX are trademarks of TYAN Computer Corporation. Intel, Blackford, and combinations thereof are trademarks of Intel Corporation. Phoenix, Phoenix-AwardBIOS are trademarks of Phoenix Technologies.













Notice

Information contained in this document is furnished by TYAN Computer Corporation and has been reviewed for accuracy and reliability prior to printing. TYAN assumes no liability whatsoever, and disclaims any express or implied warranty, relating to sale and/or use of TYAN products including liability or warranties relating to fitness for a particular purpose or merchantability. TYAN retains the right to make changes to product descriptions and/or specifications at any time, without notice. In no event will TYAN be held liable for any direct or indirect, incidental or consequential damage, loss of use, loss of data or other malady resulting from errors or inaccuracies of information contained in this document.

Table of Contents

Check the box contents!	3
Chapter 1: Introduction	
1.1 Congratulations.....	5
1.2 Hardware Specifications.....	5
Chapter 2: Board Installation	
2.1 Board Image.....	8
2.2 Block Diagram.....	9
2.3 Board Parts, Jumpers and Connectors.....	10
2.4 Tips on Installing Motherboard in Chassis.....	20
2.5 Installing the Processor(s).....	21
2.6 Installing the Memory.....	24
2.7 Attaching Drive Cables.....	26
2.8 Installing Add-in Cards.....	28
2.9 Connecting External Devices.....	29
2.10 Installing the Power Supply.....	30
2.11 Finishing up.....	30
Chapter 3: BIOS Setup	
3.1 About the BIOS.....	31
3.2 BIOS Main Menu.....	33
3.3 Advanced Menu.....	41
3.4 Security Menu.....	54
3.5 Power Menu.....	55
3.6 Boot Menu.....	56
3.7 Exit Menu.....	57
Chapter 4: Diagnostics	
4.1 Beep Codes.....	59
4.2 Flash Utility.....	59
4.3 BIOS Post Code.....	60
Appendix I: SMDC Information	
Appendix II: How to Make a Driver Diskette	
Glossary	

Check the box contents!

	1x S5380 motherboard
	1x 34-Pin floppy drive cable
	1 x Ultra-DMA-133/100/66/33 IDE cable
	3 x Serial ATA power cable
	6 x Serial ATA Cable
	1 x USB2.0 cable
	1 x COM Port Cable
	1 x S5380 user's manual
	1 x S5380 Quick Reference guide
	1 x TYAN driver CD
	1 x I/O shield
	2 x CPU Back Plane

If any of these items are missing, please contact your vendor/dealer for replacement before continuing with the installation process.

Chapter 1: Introduction

1.1 - Congratulations

You have purchased one of the most powerful server solutions. The Tempest i5000PX (S5380) is a flexible Intel® platform for multiple applications, based on Intel® “Blackford” MCH and ESB2 chipsets.

Designed to support Intel® Dempsey/Woodcrest processors and max 16GB DDR2-533/667 FB-DIMM memory, and featured with integrated Dual Gigabit Ethernet LAN, PCI-Express, PCI/PCI-X 32/64bit PCI bus plus six serial ATA ports, the S5380 offers exceptional performance and versatile solution for your server platform.

Remember to visit TYAN's Website at <http://www.TYAN.com>. There you can find information on all of TYAN's products with FAQs, online manuals and BIOS upgrades.

1.2 - Hardware Specifications

Processors

- Dual LGA771 sockets
- Supports up to two (x2) Intel® Dempsey/Woodcrest processors with 1066/1333 MHz FSB
- VRM 11.0

Chipset

- Intel® “Blackford” MCH+ESB2 chipset
- Supports for 1066/1333 MHz FSB
- Winbond 83627HF super I/O chip

Memory

- Eight (x8) 240-pin DDR2 FBDIMM* sockets
- Maximum of 16GB DDR2-533/667 FB-DIMM

*FB-DIMM: Fully Buffered DIMM

Integrated Video Controller

- ATI ES1000
- PCI interface
- 32MB DDR memory

Integrated LAN Controllers

- One (x1) Intel Gigal network controller
 - Direct link to ESB2
- Two (x2) Gigal LAN ports
- Two (x2) front panel LED headers

Intelligent Platform

- Management Interface** (Option) Baseboard Management Controller (BMC) from daughter card M3291
- Tailored for IPMI 2.0 specification
- Supports remote power on/off and reset support (IPMI-over-LAN)
- Server Management Daughter card via built-in 2x25 header

Expansion Slots

- Two (x2) 64/133 PCI-X slots
 - One inverted PCIe x4 slot (w/ x8 signals from ESB2) for risers, in-lined with the 1st PCI-X slot
- Two (x2) PCI Express x16 slot (w/ x8 signals from Blackford MCH)
- One (x1) PCI Express x8 slot (w/ x4 signals from ESB2)
- Five expansion slots in total

Integrated I/O

- One (x1) 9-pin 16550 UART serial port
- One (x1) 15-pin VGA port
- One (x1) IDE port
- One (x1) Floppy port
- Total Eight (8) USB 2.0 ports (6 in rear and 2 onboard with vertical USB Type A connectors
 - One (x1) 2-USB-port connector
 - Two (x2) 2-USB-port + 1 RJ45 10/100/1000 LAN port
- PS/2 mouse & keyboard connectors
- Standard/integrated SATA connectors

System Management

- Analog Devices ADT7468 Hardware Monitor ASIC
- CPU thermal & voltage monitor support
- 2-pin chassis intrusion header
- Multiple 4-pin and 3-pin fan monitoring headers

Integrated SATA 2.0 Controller

- Six SATA 2.0 ports from Intel ESB2
- Integrated RAID 0/1/5 support

BIOS

- PhoenixBIOS on 8Mbit Flash ROM
- Support APM 1.2, ACPI 1.0b
- Serial Console Redirect
- PXE via Ethernet, USB device boot
- PnP, DMI 2.0, WfM 2.0 power management
- User-configurable hardware monitoring
- Auto-configuration of hard disk types
- Multiple boot options
- 48-bit LBA support

Form Factor

- SSI/Extended ATX (12" x 13")
- EPS 12V/SSI (24+8+4 pin) power connectors
- Stacked PS/2 keyboard and mouse connectors
- Stacked USB 2.0 connectors (x2)
- Serial (x1) and VGA (x1) connectors
- Two (x2) side-by-side stacked RJ-45 LAN + Two (x2) USB ports connectors with LEDs

Regulatory

- FCC Class B (DoC)
- European Community CE (DoC)

Chapter 2: Board Installation

You are now ready to install your motherboard. The mounting hole pattern of the Tempest i5000PX S5380 matches the SSI CEB v1.01 specification. Before continuing with installation, confirm that your chassis supports an SSI CEB v1.01 motherboard.

How to install our products right... the first time

The first thing you should do is reading this user's manual. It contains important information that will make configuration and setup much easier. Here are some precautions you should take when installing your motherboard:

- (1) Ground yourself properly before removing your motherboard from the antistatic bag. Unplug the power from your computer power supply and then touch a safely grounded object to release static charge (i.e. power supply case). For the safest conditions, TYAN recommends wearing a static safety wrist strap.
- (2) Hold the motherboard by its edges and do not touch the bottom of the board, or flex the board in any way.
- (3) Avoid touching the motherboard components, IC chips, connectors, memory modules, and leads.
- (4) Place the motherboard on a grounded antistatic surface or on the antistatic bag that the board was shipped in.
- (5) Inspect the board for damage.

The following pages include details on how to install your motherboard into your chassis, as well as installing the processor, memory, disk drives and cables.

NOTE

DO NOT APPLY POWER TO THE BOARD IF IT HAS BEEN DAMAGED

2.1- Board Image

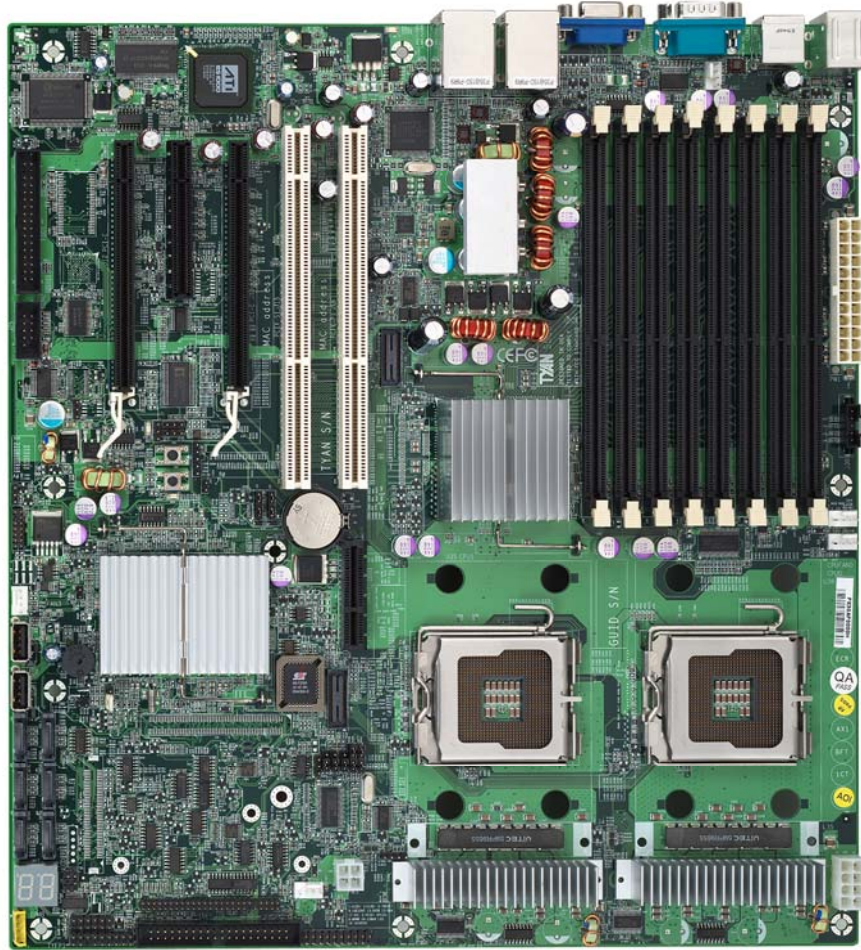

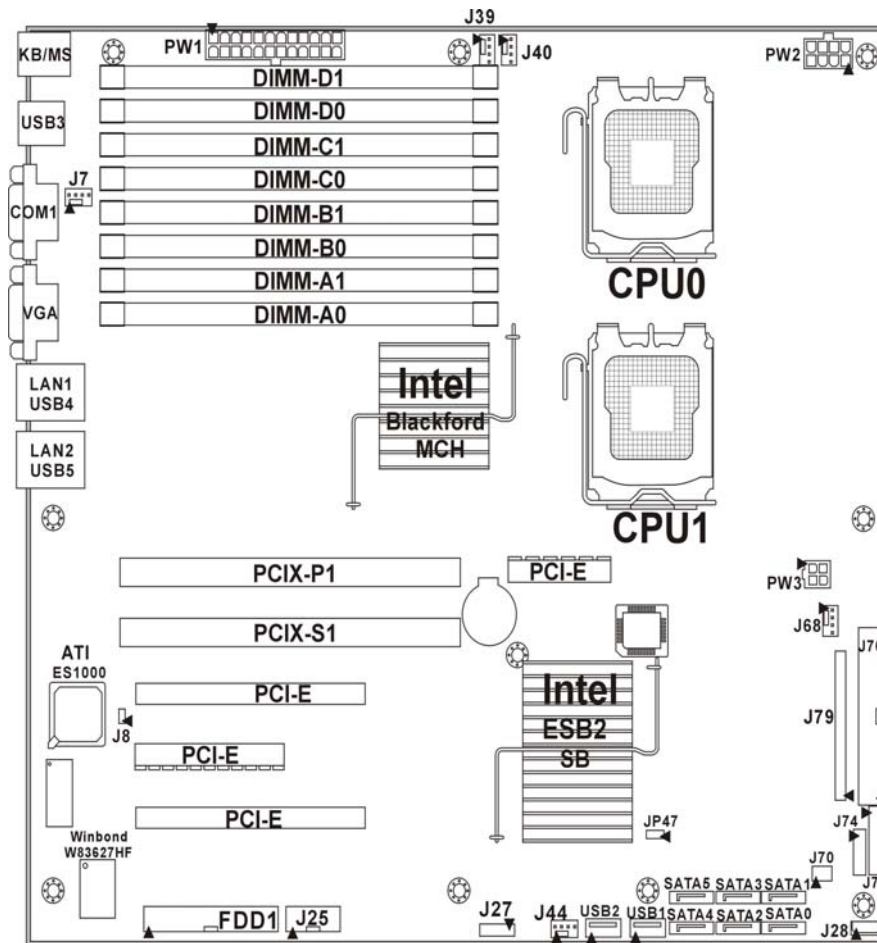

This picture is representative of the latest board revision available at the time of publishing. The board you receive may or may not look exactly like the above picture.

2.3 - Board Parts, Jumpers and Connectors



This diagram is representative of the latest board revision available at the time of publishing. The board you receive may not look exactly like the above diagram.

Jumper Legend

	OPEN - Jumper OFF, without jumper cover
	CLOSED – Jumper ON, with jumper cover

Jumper/Connector	Function
J8	Onboard VGA Jumper - Open: Enable VGA (Default) - Closed: Disable VGA
J25	COM2 Header
J27	Fan Connector (for barebone use only)
J28	IPMB Connector
J7/J44/J68	Chassis Fan Connectors J7: FAN1, J44: FAN3, J68: FAN2
J39/J40	CPU Fan Connectors J39: CPUFAN1 J40:CPUFAN0
J70	Chassis LCD Module Interface Header
J76	IDE Connector
J74	The 2 nd Front Panel Header
J77	The 1 st Front Panel Header
J79	SMDC Connector
JP47	Clear CMOS Jumper - Pin 1-2 closed: Normal (Default) - Pin 2-3 closed: Clear
USB1/USB2	Front USB Connectors

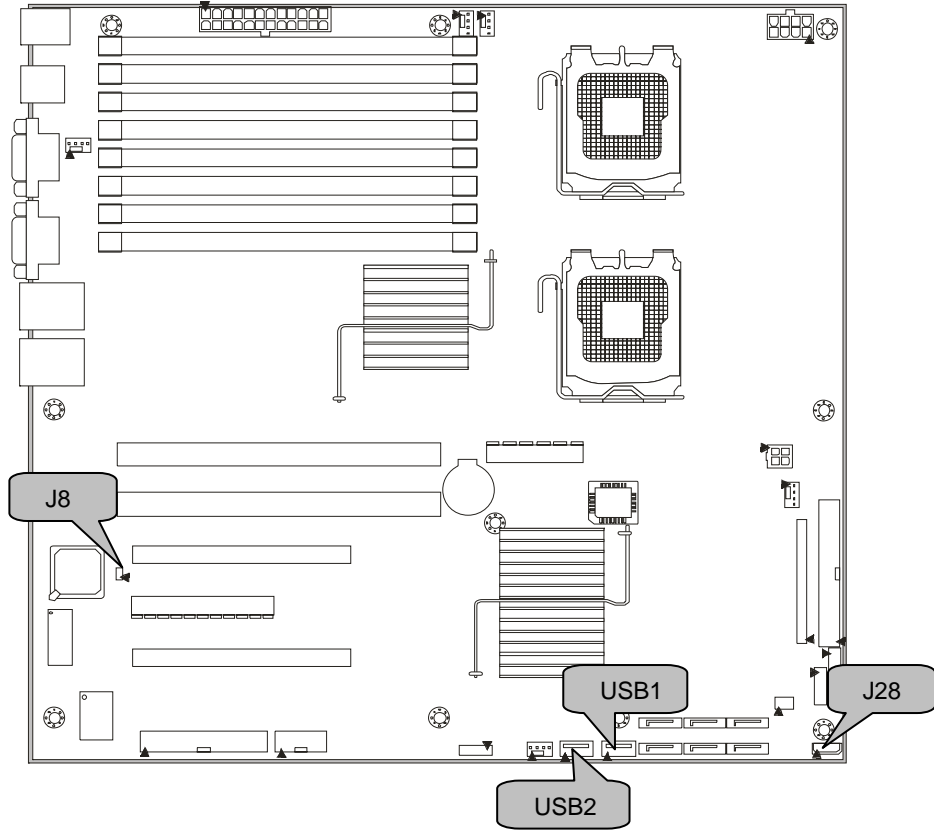

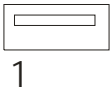

USB1/USB2: Front Panel USB2.0 Connector

 1	Pin 1	USB PWR	Pin 2	USB_N_FB
	Pin 3	USB_P_FB	Pin 4	GND

Use these headers to connect to the USB devices.

J8: Onboard VGA Jumper

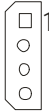

	Enable the onboard ATI VGA function.
	Disable the onboard ATI VGA function

J28: IPMB Connector

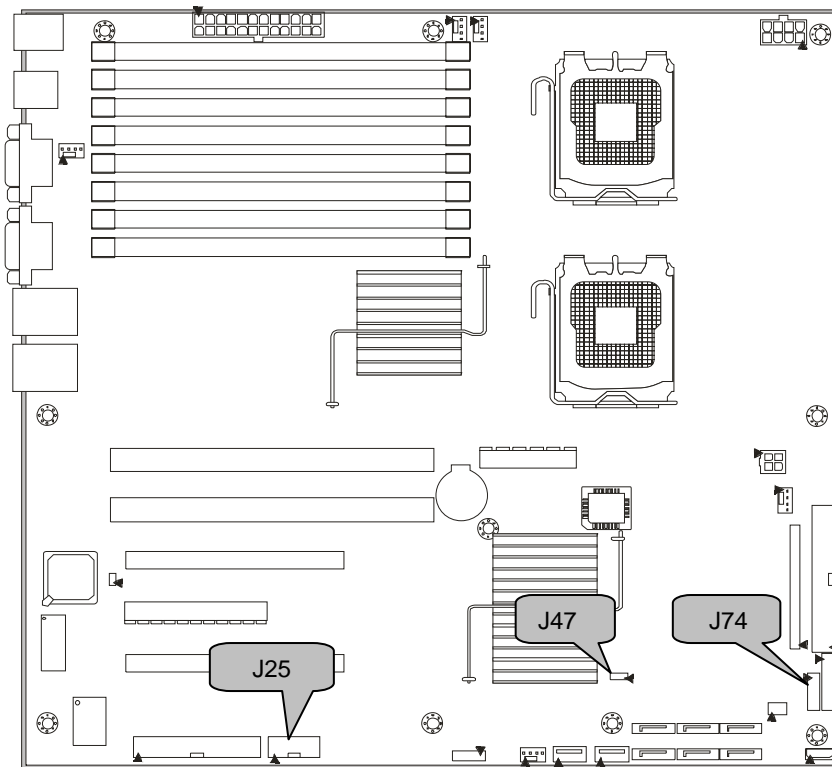
 1	Pin 1	IPMB DATA	Pin 2	GND
	Pin 3	IPMB CLK	Pin 4	NC



JP47: Clear CMOS Jumper

 <p>Normal (Default)</p>	<p>Use this jumper when you forgot your system/setup password or need to clear system BIOS setting.</p> <p>How to clear the CMOS data</p> <ul style="list-style-type: none"> - Power off system and disconnect power supply from AC source
 <p>Clear</p>	<ul style="list-style-type: none"> - Use jumper cap to close Pin_2 and 3 for several seconds to Clear CMOS - Replace jumper cap to close Pin_1 and 2 <p>Reconnect power supply to AC source Power on system</p>

J25: COM2 Header

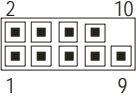
	<p>Use these pin definitions to connect a port to COM2. *TYAN does not provide cable for this header. It is designed for OEM use only.</p> <table border="1" data-bbox="635 667 1093 851"> <thead> <tr> <th>Signal</th> <th>Pin</th> <th>Pin</th> <th>Signal</th> </tr> </thead> <tbody> <tr> <td>DCD</td> <td>1</td> <td>2</td> <td>DSR</td> </tr> <tr> <td>RXD</td> <td>3</td> <td>4</td> <td>RTS</td> </tr> <tr> <td>TXD</td> <td>5</td> <td>6</td> <td>CTS</td> </tr> <tr> <td>DTR</td> <td>7</td> <td>8</td> <td>RI</td> </tr> <tr> <td>GND</td> <td>9</td> <td>10</td> <td>Key</td> </tr> </tbody> </table>	Signal	Pin	Pin	Signal	DCD	1	2	DSR	RXD	3	4	RTS	TXD	5	6	CTS	DTR	7	8	RI	GND	9	10	Key
Signal	Pin	Pin	Signal																						
DCD	1	2	DSR																						
RXD	3	4	RTS																						
TXD	5	6	CTS																						
DTR	7	8	RI																						
GND	9	10	Key																						

J74: The 2nd Front Panel Header

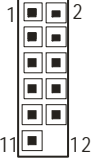
	<table border="1" data-bbox="635 974 1093 1198"> <thead> <tr> <th>Signal</th> <th>Pin</th> <th>Pin</th> <th>Signal</th> </tr> </thead> <tbody> <tr> <td>LAN1 LED+</td> <td>1</td> <td>2</td> <td>LAN1 LED-</td> </tr> <tr> <td>LAN2 LED+</td> <td>3</td> <td>4</td> <td>LAN2 LED-</td> </tr> <tr> <td>NC</td> <td>5</td> <td>6</td> <td>NC</td> </tr> <tr> <td>ID LED+</td> <td>7</td> <td>8</td> <td>ID LED-</td> </tr> <tr> <td>ID SW+</td> <td>9</td> <td>10</td> <td>ID SW-</td> </tr> <tr> <td>Reserved</td> <td>11</td> <td>12</td> <td>Key</td> </tr> </tbody> </table> <p>The 2nd Front Panel Header is used to connect some control or signal wires from motherboard to chassis, such as LAN LED or ID LED.</p>	Signal	Pin	Pin	Signal	LAN1 LED+	1	2	LAN1 LED-	LAN2 LED+	3	4	LAN2 LED-	NC	5	6	NC	ID LED+	7	8	ID LED-	ID SW+	9	10	ID SW-	Reserved	11	12	Key
Signal	Pin	Pin	Signal																										
LAN1 LED+	1	2	LAN1 LED-																										
LAN2 LED+	3	4	LAN2 LED-																										
NC	5	6	NC																										
ID LED+	7	8	ID LED-																										
ID SW+	9	10	ID SW-																										
Reserved	11	12	Key																										

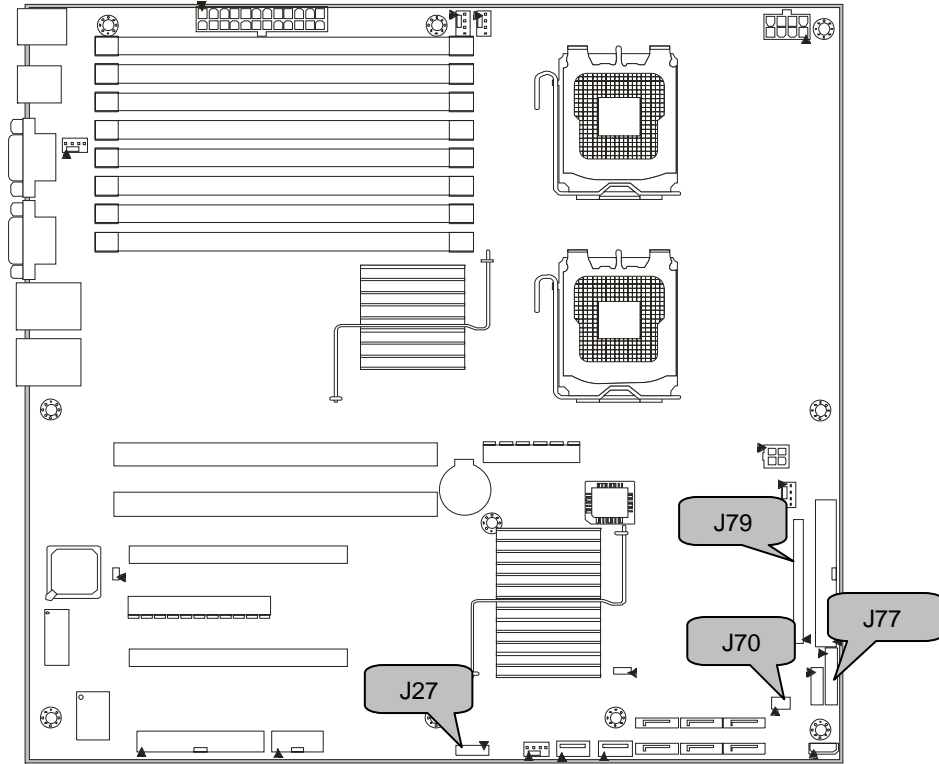

J27: FAN Connector (for barebone use only)

Use these pin definitions to connect to the barebone fans.

Signal	Pin	Pin	Signal
CPU0-TACH	1	2	SYS4-TACH
CPU1-TACH	3	4	SYS5-TACH
FAN3-TACH	5	6	SYS6-TACH
FAN1-TACH	7	8	SYS7-TACH
FAN2-TACH	9	10	SYS8-TACH
GND	11	12	Key
GND	13	14	HMO-FANPWM1

J70: LCM Module Header

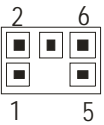

Signal	Pin	Pin	Signal
+5V	1	2	SIN
Key	3	4	GND
+5Vsb	5	6	SOUT

Use this header to connect the LCM module with system monitoring function. This header is reserved for barebone use.

J79: SMDC Connector

The SMDC connector allows you to connect with Tyan Server Management Daughter Card (SMDC). The S5380 supports Tyan SMDC M3291. See Appendix I for more information on SMDC.

J77: The 1st Front Panel Header

The 1st Front Panel Header is used to connect some control or signal wires from motherboard to chassis, such as HDD LED, power LED, power button, and reset button.

HDDLED+	1	2	PWR LED+
HDDLED-	3	4	PWR LED-
GND	5	6	PWR SW+
Reset SW+	7	8	GND
Ground	9	10	W_LED+
NMI_BTN	11	12	W_LED-
5Vsb	13	14	key
SMBus Data	15	16	GND
SMBus Clock	17	18	Chassis Intr# (Active Low)

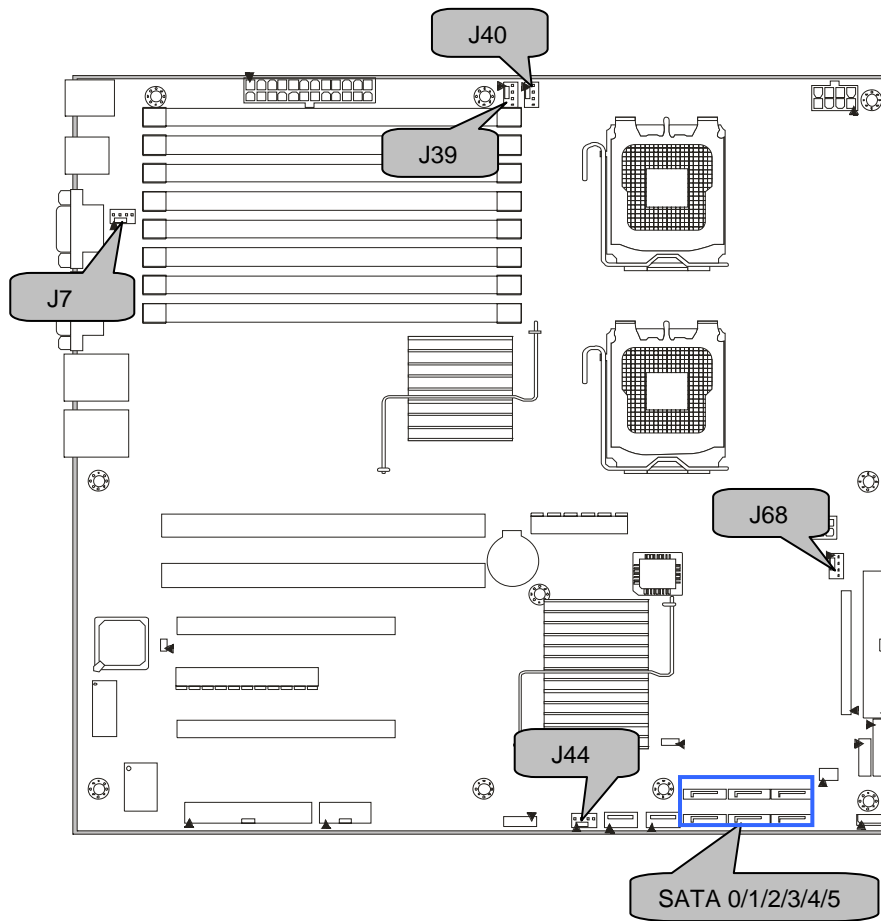

J39/J40: CPU0/CPU1 Fan Connectors

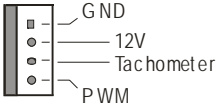
	<p>Use this header to connect the processor cooling fan to your motherboard to keep the system at optimum performance levels.</p> <p>J39: CPUFAN1; J40: CPUFAN0</p>
---	---

J68: Chassis Fan Connector

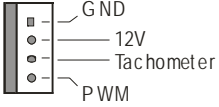
	<p>Use this header to connect the chassis cooling fan to your motherboard to keep the system at optimum performance levels.</p> <p>J68: FAN2</p>
---	--

J7/J44: Chassis Fan Connectors

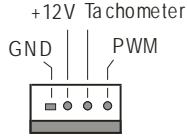
	<p>Use this header to connect the chassis cooling fan to your motherboard to keep the system at optimum performance levels.</p> <p>J7: FAN1; J44: FAN3</p>
---	--

SATA0/1/2/3/4/5: Serial ATA RAID Connector

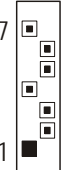
	<table border="1"> <tr><td>7</td><td>GND</td></tr> <tr><td>6</td><td>RXP</td></tr> <tr><td>5</td><td>RXN</td></tr> <tr><td>4</td><td>GND</td></tr> <tr><td>3</td><td>TXN</td></tr> <tr><td>2</td><td>TXP</td></tr> <tr><td>1</td><td>GND</td></tr> </table>	7	GND	6	RXP	5	RXN	4	GND	3	TXN	2	TXP	1	GND	<p>Connects to the Serial ATA ready drives via the Serial ATA cable</p> <p>You may use these six Serial ATA ports to have the support of RAID 0 or 1 through the on board Intel ESB2 chipset.</p>
7	GND															
6	RXP															
5	RXN															
4	GND															
3	TXN															
2	TXP															
1	GND															

2.4 - Tips on Installing Motherboard in Chassis

Before installing your motherboard, make sure your chassis has the necessary motherboard support studs installed. These studs are usually metal and are gold in color. Usually, the chassis manufacturer will pre-install the support studs. If you are unsure of stud placement, simply lay the motherboard inside the chassis and align the screw holes of the motherboard to the studs inside the case. If there are any studs missing, you will know right away since the motherboard will not be able to be securely installed.

Some chassis' include plastic studs instead of metal. Although the plastic studs are usable, TYAN recommends using metal studs with screws that will fasten the motherboard more securely in place.

Below is a chart detailing what the most common motherboard studs look like and how they should be installed.

Mounting the Motherboard

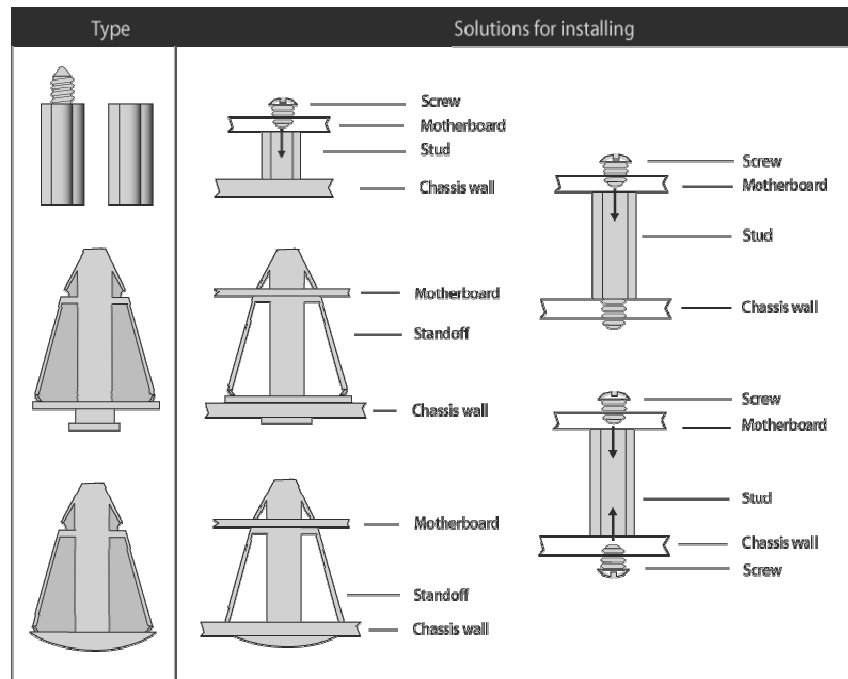

2.5 - Installing the Processor(s)

Your Tempest i5000PX S5380 supports the latest processor technologies from Intel. Check the TYAN website for latest processor support:

<http://www.tyan.com>

Processor Installation

The processor should be installed carefully. Make sure you are wearing an antistatic strap and handle the processor as little as possible.

Follow these instructions to install your processor

1. Locate the processor socket on the motherboard and lift the protective cover off as shown.

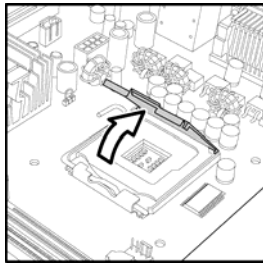

WARNING:

This new processor socket designed by Intel is easy to be damaged. The processor has to be installed very carefully to prevent the contact pins of the socket from breaking. It is strongly recommended the processor installation job to be handled by the experienced technician.

2. Pull the locking lever out of it's locked position and let it spring into the open position.

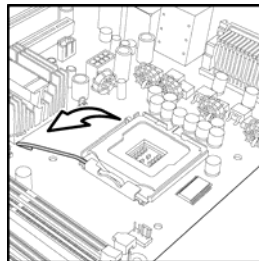
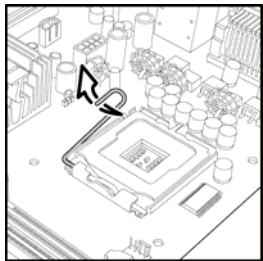

3. Lift the metal cover to expose the socket interior and place the socket in as shown.

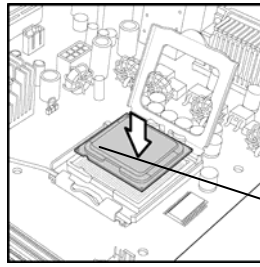
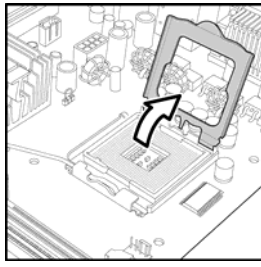

Pin 1

4. Close the cover and return the locking lever to its locked position.

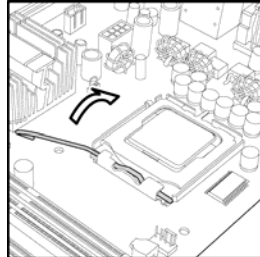
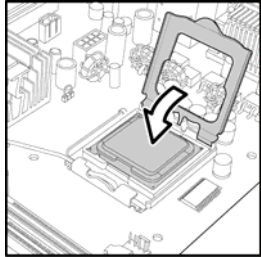

5. Repeat this procedure for the second processor socket.
6. Turn the board upside down and insert the heat sink spring mechanism as shown.

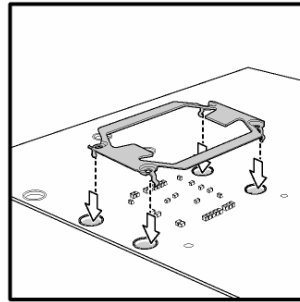

7. Turn the board the right way up again and screw the heat sink into place.

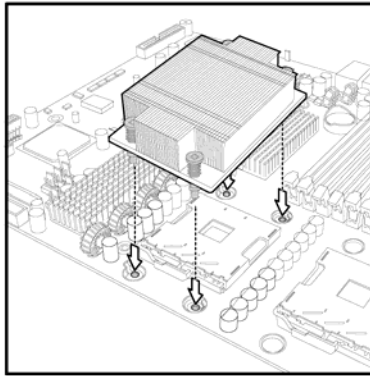
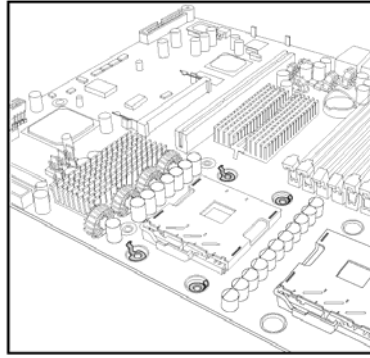

8. Repeat this procedure for the second processor.

Cooling Fan Installation

After you have installed the processor, the heatsink should be installed to ensure that the processor runs efficiently and does not overheat. Use the heatsink supplied for best results.

Follow these instructions to install the heatsink shown.

1. Apply some (a little will work, more doesn't equal better performance) thermal compound to the top of the processor. Try and apply a thin, even layer over the top of the processor.
2. Align the heatsink with the four holes around the processor socket.
3. Press the heatsink down until the four screws are securely seated in the holes.
4. Use screw driver to secure the four screws.

2.6 - Installing the Memory

Before installing memory, ensure that the memory you have is compatible with the motherboard and processor. Only DDR2-667/533 Fully Buffer DIMM (FB DIMM) modules are required. Check the TYAN Web site at: www.tyan.com for details of the type of memory recommended for your motherboard.

The following diagram shows common types of FB-DIMM memory modules.



Key points to note before installing memory:

- Only **DDR2 667/533 FB-DIMM** memory modules are supported.
- All installed memory will automatically be detected and no jumpers or settings need changing.
- The Tempest i5000PX S5380 supports up to 16GB of memory.

The following chart outlines the suggested rules for populating memory.

Memory Population Rules

Channel DIMM	Single	Dual	Four	Four
DIMMA0	X	X	X	X
DIMMA1				X
DIMMB0		X	X	X
DIMMB1				X
DIMMC0			X	X
DIMMC1				X
DIMMD0			X	X
DIMMD1				X

NOTE: Please always install memory beginning with DIMMA0. You can choose to install single, dual or four memory modules.

Memory Installation Procedure

Follow these instructions to install memory modules into the Tempest i5000PX S5380.

1. Press the locking levers in the direction shown in the following illustration.

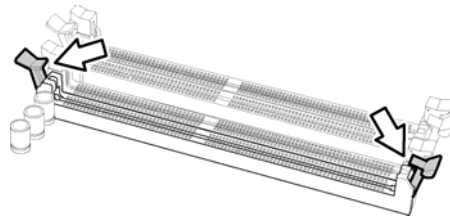

2. Align the memory module with the socket. The memory module is keyed to fit only one way in the socket.

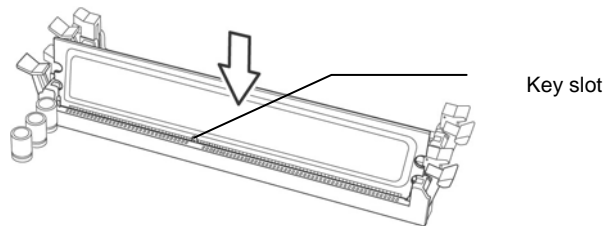

3. Seat the module firmly into the socket by gently pressing down until it sits flush with the socket. The locking levers pop up into place.

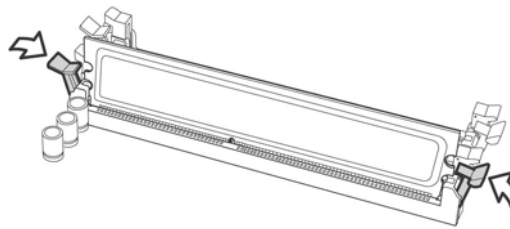

NOTE: The S5380 only supports DDR2 Fully Buffered DIMM. Registered Memory Module is **NOT** supported.

2.7 - Attaching Drive Cables

Attaching IDE Drive Cable

Attaching the IDE drive cable is simple. These cables are “keyed” to only allow them to be connected in the correct manner. TYAN motherboards have two on-board IDE channels, each supporting two drives. **The black connector designates the Primary channel, while the white connector designates the Secondary channel.**

Attaching IDE cables to the IDE connectors is illustrated below:

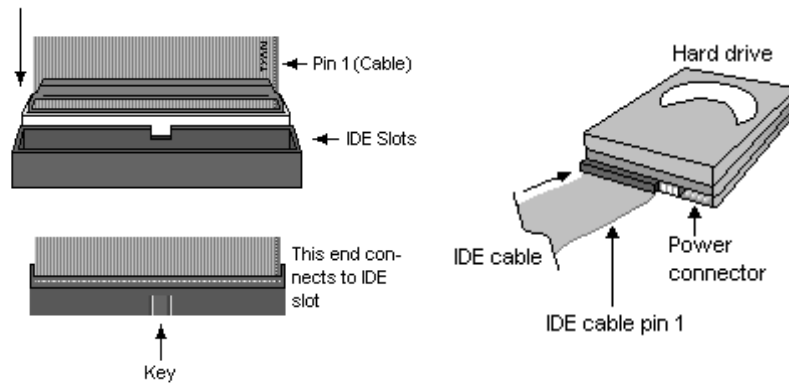

Simply plug in the BLUE END of the IDE cable into the motherboard IDE connector, and the other end(s) into the drive(s). Each standard IDE cable has three connectors, two of which are closer together. The BLUE connector that is furthest away from the other two is the end that connects to the motherboard. The other two connectors are used to connect to drives.

NOTE: Always remember to properly set the drive jumpers. If only using one device on a channel, it must be set as Master for the BIOS to detect it.

TIP: Pin 1 on the IDE cable (usually designated by a colored wire) faces the drive's power connector.

Attaching Serial ATA Cables

The Tempest i5000PX S5380 is also equipped with 6 Serial ATA (SATA) channels. Connections for these drives are also very simple.

There is no need to set Master/Slave jumpers on SATA drives.

Tyan has supplied two SATA cables and one SATA power adapter. If you are in need of other cables or power adapters please contact your place of purchase.

The following pictures illustrate how to connect an SATA drive

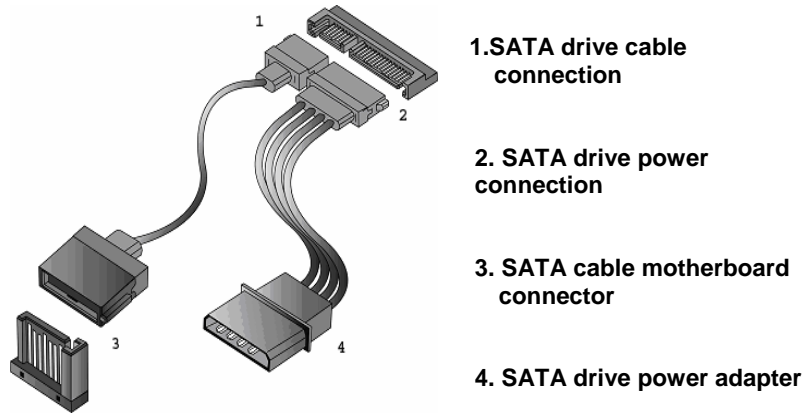

Attaching Floppy Drive Cables

Attaching floppy diskette drives are done in a similar manner to hard drives. See the picture below for an example of a floppy cable. Most of the current floppy drives on the market require that the cable be installed with the colored stripe positioned next to the power connector. In most cases, there will be a key pin on the cable which will force a proper connection of the cable.

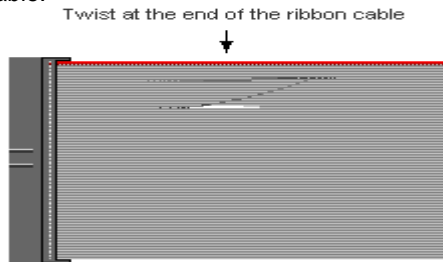

Attach first floppy drive (drive **A:**) to the end of the cable with the twist in it. Drive **B:** is usually connected to the next possible connector on the cable (the second or third connector after you install Drive **A:**).

2.8 - Installing Add-In Cards

Before installing add-in cards, it's helpful to know if they are fully compatible with your motherboard. For this reason, we've provided the diagrams below, showing the slots that appear on your motherboard.

PCI-X (64/133)

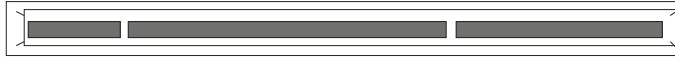

PCI Express (x4)

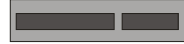

PCI Express (x16)



PCI Express (x8)



Simply find the appropriate slot for your add-in card and insert the card firmly. Do not force any add-in cards into any slots if they do not seat in place. It is better to try another slot or return the faulty card rather than damaging both the motherboard and the add-in card.

PCI IDESELs and IRQ Assignments

Slot or Device	IDSEL#	INT	REQ/GNT	CLK
PCI - X P1	AD17	PXIRQ_N0-3	PXREQ_N0 PXGNT0_N	PCIX_SLOT A_CLK
PCI - X S1	AD18	PXIRQ_N0-3	PXREQ_N1 PXGNT1_N	PCIX_SLOT B_CLK

NOTE

YOU MUST ALWAYS unplug the power connector from the motherboard before performing system hardware changes. Otherwise you may damage the board and/or expansion device.

2.9 - Connecting External Devices

The following diagrams will detail the rear port stack for this S5380 motherboard:

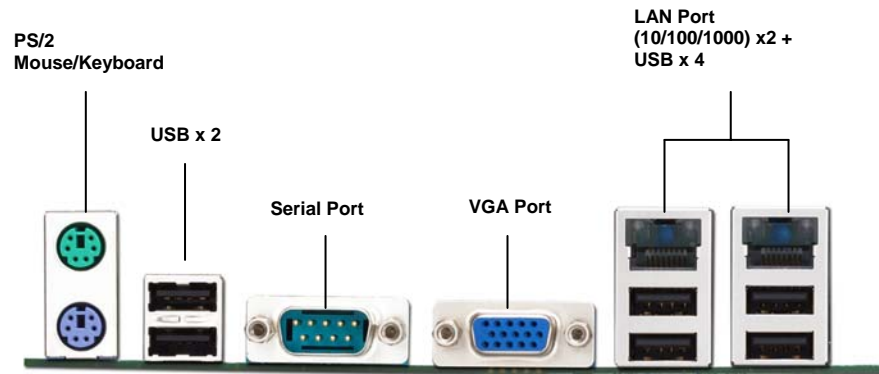

NOTE: Peripheral devices can be plugged straight into any of these ports but software may be required to complete the installation.

Onboard LAN LED Color Definition

The three onboard Ethernet ports have green and yellow LEDs to indicate LAN status. The chart below illustrates the different LED states.

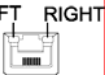
10/100/1000 Mbps LAN Link/Activity LED Scheme			
		Left LED	Right LED
10 Mbps	Link	Green	Off
	Active	Blinking Green	Off
100 Mbps	Link	Green	Green
	Active	Blinking Green	Green
1000 Mbps	Link	Green	Yellow
	Active	Blinking Green	Yellow
No Link		Off	Off

2.10 - Installing the Power Supply

There are three power connectors on your Tempest i5000PX S5380. The Tempest i5000PX S5380 requires that you have an EPS12V power supply that has a 24-pin, an 8-pin and a 4-pin power connectors. Except the 24-pin and 8-pin power supplies, **you also need to connect a 4-pin power supply for the power of South Bridge.**

NOTE: Please be aware that ATX 2.x, ATX12V and ATXGES power supplies may **not** be compatible with the board and can damage the motherboard and/or CPU(s).

24-Pin EPS/12V Power Connector



8-Pin 12V Power Connector



4-Pin 12V Power Connector



Applying power to the board

1. Connect the 12V 8-pin power connector.
2. Connect the EPS/12V 24-pin power connector.
3. Connect the 4-pin power connector.
4. Connect power cable to power supply and power outlet

NOTE

YOU MUST unplug the power supply before plugging the power cables to motherboard connectors.

2.11 - Finishing up

Congratulations on making it this far! You're finished setting up the hardware aspect of your computer. Before closing up your chassis, make sure that all cables and wires are connected properly, especially IDE cables and most importantly, jumpers. You may have difficulty powering on your system if the motherboard jumpers are not set correctly.

In the rare circumstance that you have experienced difficulty, you can find help by asking your vendor for assistance. If they are not available for assistance, please find setup information and documentation online at our website or by **calling your vendor's support line.**

Chapter 3: BIOS Setup

3.1. About the BIOS

The BIOS is the basic input/output system, the firmware on the motherboard that enables your hardware to interface with your software. The BIOS determines what a computer can do without accessing programs from a disk. The BIOS contains all the code required to control the keyboard, display screen, disk drives, serial communications, and a number of miscellaneous functions. This chapter describes the various BIOS settings that can be used to configure your system.

The BIOS section of this manual is subject to change without notice and is provided for reference purposes only. The settings and configurations of the BIOS are current at the time of print and are subject to change, and therefore may not match exactly what is displayed on screen.

This section describes the BIOS setup program. The setup program lets you modify basic configuration settings. The settings are then stored in a dedicated, battery-backed memory (called NVRAM) that retains the information even when the power is turned off.

To start the BIOS setup utility:

1. Turn on or reboot your system.
2. Press <F2> during POST (F4 on remote console) to start the BIOS setup utility.

3.1.1 Setup Basics

The table below shows how to navigate in the setup program using the keyboard.

Key	Function
Tab	Moves from one selection to the next
Left/Right Arrow Keys	Changes from one menu to the next
Up/Down Arrow Keys	Moves between selections
Enter	Opens highlighted section
PgUp/PgDn Keys	Changes settings.

3.1.2 Getting Help

Pressing [F1] will display a small help window that describes the appropriate keys to use and the possible selections for the highlighted item. To exit the Help Window, press [ESC] or the [F1] key again.

3.1.3 In Case of Problems

If you have trouble booting your computer after making and saving the changes with the BIOS setup program, you can restart the computer by holding the power button down until the computer shuts off (usually within 4 seconds); resetting by pressing CTRL-ALT-DEL; or clearing the CMOS.

The best advice is to only alter settings that you thoroughly understand. In particular, do not change settings in the Chipset section unless you are absolutely sure of what you are doing. The Chipset defaults have been carefully chosen either by TYAN or your system manufacturer for best performance and reliability. Even a seemingly small change to the Chipset setup options may cause the system to become unstable or unusable.

3.1.4 Setup Variations

Not all systems have the same BIOS setup layout or options. While the basic look and function of the BIOS setup remains more or less the same for most systems, the appearance of your Setup screen may differ from the charts shown in this section. Each system design and chipset combination requires a custom configuration. In addition, the final appearance of the Setup program depends on the system designer. Your system designer may decide that certain items should not be available for user configuration, and remove them from the BIOS setup program.

NOTE: The following pages provide the details of BIOS menu. Please be noticed that the BIOS menu are continually changing due to the BIOS updating. The BIOS menu provided are the most updated ones when this manual is written. Please visit Tyan's website at <http://www.tyan.com> for the information of BIOS updating.

3.2 BIOS Main Menu

In this section, you can alter general features such as the date and time, as well as access to the IDE configuration options. Note that the options listed below are for options that can directly be changed within the Main Setup screen.

PhoenixBIOS Setup Utility					
Main	Advanced	Security	Power	Boot	Exit
System Time:	[xx : xx : xx]			Item Specific Help	
System Date:	[xxxx-xx-xx]			[Tab], [Shift-Tab], or [Enter] selects field.	
BIOS Version:					
BIOS Build Date:					
Legacy Diskette A:	[1.44/1.25 MB 3½"]				
▶ IDE Primary/Master					
▶ IDE Primary/Slave					
▶ IDE Secondary/Master					
▶ IDE Secondary/Slave					
▶ Memory Cache					
▶ Boot Features					
System Memory:					
Extended Memory:					
F1 Help	↑ ↓ Select Item	-/+ Change Values	F9 Setup Defaults		
Esc Exit	← → Select Menu	Enter Select	▶ Sub-Menu	F10 Previous Values	

System Time / Date setup

System Time: Adjusts the system clock.

HHHours (24hr. format)

MMinutes

SSSeconds

System Date: Adjusts the system date.

MMMonths

DDDays

YYYYYears

BIOS Build Date

This displays the date of BIOS build.

Legacy Diskette A

Defines the floppy drive type

NONE / 360K, 5.25 in / 1.2 M, 5.25 in / 720 K, 3.5 in / **1.44 M, 3.5 in** /
2.88 M, 3.5 in

System Memory

This display allows you to change the amount of system memory present on the system.

Extended Memory

This displays/allows you to change the amount of extended memory present on the system.

3.2.1 IDE Primary/Secondary Master/Slave Setup

Computer detects IDE drive type from drive C to drive F. Press **Enter** on any of the Primary/Master, Primary/Slave, Secondary/Master, Secondary/Slave options to view advanced details of the corresponding drive. The system displays advanced details like the number of heads/cylinders/sectors on the detected disk and the maximum storage capacity of the disk.

PhoenixBIOS Setup Utility					
Main	Advanced	Security	Power	Boot	Exit
Type:	[Auto]			Item Specific Help	
Multi-Sector Transfers:	[Disabled]			User = your enter parameters of hard-disk drive installed at this connection.	
LBA Mode Control:	[Disabled]			Auto = autotypes hard-disk drive installed here.	
32 Bit I/O:	[Disabled]			1-39 = you select pre-determined type of hard-disk drive installed here.	
Transfer Mode:	[Standard]			CD-ROM = a CD-ROM drive is installed here.	
Ultra DMA Mode:	[Disabled]			ATAPI Removable = removable disk drive is installed here.	
F1 Help ↑↓ Select Item -/+ Change Values F9 Setup Defaults Esc Exit ←→ Select Menu Enter Select ► Sub-Menu F10 Previous Values					

The system displays advanced details like the number of heads/cylinders/sectors on the detected disk and the maximum storage capacity of the disk.

This option lets you set the following hard disk parameters:

Type

Selects the type of device connected to the system.

Auto / CD/DVD / Not Installed / ARMD

Multi-Sector Transfers

This option allows you to specify the number of sectors per block for multiple sector transfers.

16 Sectors / 2 Sectors / 4 Sectors / 8 Sectors / **Disabled**

LBA Mode Control

Enables or disables LBA Mode.

When LBA is turned on, the BIOS will enable geometry translation. This translation may be done in the same way that it is done in Extended CHS or

large mode, or it may be done using a different algorithm called LBA-assist translation. The translated geometry is still what is presented to the operating system for use in Int 13h calls. The difference between LBA and ECHS is that when using ECHS the BIOS translates the parameters used by these calls from the translated geometry to the drive's logical geometry. With LBA, it translates from the translated geometry directly into a logical block (sector) number.

Disabled / Enabled

32 Bit I/O

Enables or disables 32 bit data transfer mode.

Enabling this option causes the PCI hard disk interface controller to bundle together two 16-bit chunks of data from the drive into a 32-bit group, which is then transmitted to the processor or memory. This results in a small performance increase.

Enabled / **Disabled**

Transfer Mode

These modes determine the speed at which data is transferred to and from the drive. The Auto option automatically determines the correct transfer rates.

Auto / **Standard** / Fast PIO 1 / Fast PIO 2 / Fast PIO 3 / Fast PIO 4 / FPIO 3 / DMA 1 / FPIO 4 / DMA 2

Ultra DMA Mode

Enables or disables Ultra DMA Mode.

Ultra DMA (UDMA, or, more accurately, Ultra DMA/33) is a protocol for transferring data between a hard disk drive through the computer's data paths (or bus) to the computer's random access memory (RAM). The Ultra DMA/33 protocol transfers data in burst mode at a rate of 33.3 MBps (megabytes per second), twice as fast as the previous Direct Memory Access (DMA) interface. Ultra DMA support in your computer means that it will boot (start) and open new applications more quickly. It will also help users of graphics-intensive and other applications that require large amounts of access to data on the hard drive. Ultra DMA uses Cyclical Redundancy Checking (CRC), offering a new level of data protection.

Disabled / Mode 0 / Mode 1 / Mode 2 / Mode 3 / Mode 4 / Mode 5

3.2.2 Memory Cache

This setting allows you to tweak the various cache settings for optimal performance of your system. Press Enter to display the various cache settings.

PhoenixBIOS Setup Utility		
Main	Advanced	Security Power Boot Exit
Memory Cache		Item Specific Help
Cache System BIOS area:	[Write Protect]	Controls caching of system BIOS area.
Cache Video BIOS area:	[Write Protect]	
Cache Base 0-512K:	[Write Back]	
Cache Base 512K-640K:	[Write Back]	
Cache Extended Memory Area:	[Write Back]	
Cache A000 – AFFF:	[Disabled]	
Cache B000 – BFFF:	[Disabled]	
Cache C800 – CBFF:	[Write Protect]	
Cache CC00 – CFFF:	[Write Protect]	
Cache D000 – D3FF:	[Disabled]	
Cache D400 – D7FF:	[Disabled]	
Cache D800 – DBFF:	[Disabled]	
Cache DC00 – DFFF:	[Disabled]	
Cache E000 – E3FF:	[Write Protect]	
Cache E400 – E7FF:	[Write Protect]	
Cache E800 – EBFF:	[Write Protect]	
Cache EC00 – EFFF:	[Write Protect]	
F1 Help	↑ ↓ Select Item	-/+ Change Values
F9 Setup Defaults		
Esc Exit	← → Select Menu	Enter Select ▶ Sub-Menu
		F10 Previous Values

Cache System BIOS Area

This feature is only available when the system BIOS is shadowed. It enables or disables the caching of the system BIOS ROM at F0000h-FFFFFh via the L2 cache. This greatly speeds up accesses to the system BIOS. However, this does not necessarily make the system perform better because the OS does not need to access the system BIOS often.

As such, it would be a waste of L2 cache bandwidth to cache the system BIOS instead of data that are more critical to the system's performance. In addition, if any program writes into this memory area, it will result in a system crash. So, it is recommended that you write protect this area for optimal system performance.

Uncached / **Write Protect**

Cache Video BIOS Area

This feature is only valid when the video BIOS is shadowed. It enables or disables the caching of the video BIOS ROM at C0000h-C7FFFh via the L2 cache. This greatly speeds up accesses to the video BIOS. However, this does not necessarily make the system perform better because the OS bypasses the BIOS and uses the graphics driver to access the video card's hardware directly.

As such, it would be a waste of L2 cache bandwidth to cache the video BIOS instead of data that are more critical to the system's performance. In addition, if any program writes into this memory area, it will result in a system crash. So, it is recommended that you write protect this area for optimal system performance.

Uncached / **Write Protect**

Cache Base 0-512K

This feature allows you to control caching of 512K base memory.

Uncached / **Write Back** / Write Through / Write Protect

Cache Base 512K-640K

This feature allows you to control caching of 512K 640K base memory.

Uncached / **Write Back** / Write Through / Write Protect

Cache Extended Memory Area

This feature allows you to control caching of system memory above one megabyte.

Uncached / **Write Back** / Write Through / Write Protect

Cache A000-AFFF/B000-BFFF

These features allow you to control caching of A000-AFFF/B000-BFFF memory.

USMC Caching / **Disabled** / Write Through / Write Protect / Write Back

Cache C800-CBFF/Cache CC00-CFFF

These features allow you to control caching of C800-CBFF/CC00-CFFF memory.

Disabled / Write Through / **Write Protect** / Write Back

Cache D000-D3FF/Cache D400-D7FF/Cache D800-DBFF/Cache DC00-DFFF

These features allow you to control caching of D000-D3FF/D400-D7FF/D800-D8FF/DC00-DFFF memory.

Disabled / Write Through / Write Protect / Write Back

Cache E000-E3FF/Cache E400-E7FF/Cache E800-EBFF/Cache EC00-EFFF

These features allow you to control caching of Cache E000-E3FF/Cache E400-E7FF/Cache E800-EBFF/Cache EC00-EFFF memory

Disabled / Write Through / **Write Protect** / Write Back

3.2.3 Boot Features

This option allows setting boot parameters. Press Enter to view the Boot Features screen.

PhoenixBIOS Setup Utility					
Main	Advanced	Security	Power	Boot	Exit
Boot Features				Item Specific Help	
Floppy check:		[Disabled]			
Summary screen:		[Enabled]			
Boot-time Diagnostic Screen:		[Enabled]			
QuickBoot Mode:		[Enabled]			
Extended Memory Testing		[Just zero it]			
F1	Help	↑ ↓	Select Item	-/+	Change Values
Esc	Exit	← →	Select Menu	Enter	Select ▶ Sub-Menu
				F9	Setup Defaults
				F10	Previous Values

Floppy Check

This feature is used to verify floppy type on boot. Selecting "Disabled" will speed the boot process.

Disabled / Enabled

Summary Screen

Enables or disables the display of the summary screen during boot up.

When Summary Screen is Enabled (the default), a Phoenix BIOS Setup Utility summary screen appears during system boot after the power-on self-test (POST). The summary screen lists many of the system setup settings. When this option is set to Disabled, the summary screen does not appear.

Enabled / Disabled

Boot-time Diagnostic Screen

This feature is used to display the diagnostic screen during the boot process.

Enabled / Disabled

Quick Boot Mode

This BIOS feature allows you to decrease the time it takes to boot up the computer by shortening or skipping certain standard booting procedures.

If enabled, the BIOS will shorten the booting process by skipping some tests and shortening others. In addition, it will also perform the following to further speed up the booting process:

- Spin up the hard disks as soon as power is supplied (or as soon as possible)

- Initialize only critical parts of the chipset

- Read memory size from the SPD (Serial Presence Detect) chip on the memory modules

- Eliminate logo delays

If disabled, the BIOS will run the whole gamut of boot-up tests.

It is recommended that you disable this feature when you boot up a new computer for the first time or whenever you install a new piece of hardware. This allows the BIOS to run full diagnostic tests to detect any problems that may slip past Quick Boot's abbreviated testing scheme.

After a few error-free test runs, you should enable this feature for much faster booting.

Enabled / Disabled

Extended Memory Testing

Determines the tests that will be run on extended memory (memory above 1MB) during boot up.

Normal / **Just zero it** / None

3.3 Advanced Menu

This section facilitates configuring advanced BIOS options for your system.

PhoenixBIOS Setup Utility					
Main	Advanced	Security	Power	Boot	Exit
Installed O/S: [Win2K/KP] Reset Configuration Data: [No] Large Disk Access Mode: [DOS]				Item Specific Help	
▶ Advanced Chipset Control ▶ Advanced Processor Options ▶ I/O Device Configuration ▶ Hardware Monitor ▶ DMI Event Logging					
Legacy USB Support: [Enabled] ▶ Console Redirection					
F1 Help ↑ ↓ Select Item -/+ Change Values F9 Setup Defaults Esc Exit ← → Select Menu Enter Select ▶ Sub-Menu F10 Previous Values					

Installed OS

Select the operating system installed on the PC.

Note: An incorrect setting can cause the operating system to behave unpredictably.

Win2K/KP / Other

Reset Configuration Data

If you install a new piece of hardware or modify your computer's hardware configuration, the BIOS will automatically detect the changes and reconfigure the ESCD (Extended System Configuration Data). Therefore, there is usually no need to manually force the BIOS to reconfigure the ESCD.

However, sometimes, the BIOS may not be able to detect the hardware changes. A serious resource conflict may occur and the operating system may not even boot as a result. This is where the Reset Configuration Data BIOS feature comes in.

This BIOS feature allows you to manually force the BIOS to clear the previously saved ESCD data and reconfigure the settings. All you need to do is enable this BIOS feature and then reboot your computer. The new ESCD should resolve the conflict and allow the operating system to load normally.

Please note that the BIOS will automatically reset it to the default setting of No after reconfiguring the new ESCD. So, there is no need for you to manually disable this feature after rebooting.

Yes / **No**

Large Disk Access Mode

This option determines whether a hard drive with more than 1024 cylinders, more than 16 heads and or more than 64 tracks per sector is present on the system. Set this option to **DOS** if such a hard drive is present. Else, set this option to **Other**. Virtually, all modern hard disks have these characters so leave this option at **DOS**, unless you know otherwise.

DOS / Other

Legacy USB Support

When enabled, the BIOS takes control of the USB ports. Enable this only if you run an OS that does not support USB (e.g. DOS) or when you have USB hardware like USB mice that you want to use even before the operating system loads.

Enabled / Disabled

3.3.1 Advanced Chipset Control

This section allows you to fine tune the chipset configuration.

PhoenixBIOS Setup Utility	
Main	Advanced Security Power Boot Exit
Advanced Chipset Control	
	Item Specific Help
▶ ICH USB Control Sub-Menu ▶ LAN Control Sub-Menu Crystal Beach Configure Enable [Enabled] SERR signal condition [Single bit] 4GB PCI Hole Granularity [256 MB] Memory Branch Mode [Interleave] Branch 0 Rank Sparing [Disabled] Branch 1 Rank Sparing [Disabled] Enhanced x8 Detection [Enabled] WatchDog Timer [Disabled] Enable Multimedia Timer [No] Parallel ATA: [Enabled] Serial ATA: [Enabled] Native Mode Operation: [Auto] SATA Controller Mode Option [Compatible]	
F1 Help ↑ ↓ Select Item -/+ Change Values F9 Setup Defaults Esc Exit ← → Select Menu Enter Select ▶ Sub-Menu F10 Previous Values	

Crystal Beach Configure Enable

Enable the configuration of memory mapped accesses to the Crystal Beach Configuration space located in Device 8, Fn 0 and Fn 1.

Enabled / Disabled

SERR signal condition

Select ECC error conditions that SERR# be asserted.

None / **Single bit** / Multiple bit/ Both

4GB PCI Hole Granularity

This feature is used to select the granularity of PCI hole for PCI resource. If MTRRs are not enough, we may use this option to reduce the MTRR occupation.

256MB / 512MB / 1.0GB / 2.0GB

Memory Branch Mode

This option is used to select the type of memory operation mode.

Interleave / Sequential / Mirror

Branch 0/1 Rank Sparing

This option is used to enable/disable Branch 0/1 rank/DIMM sparing feature.

Enabled / **Disabled**

Enhanced x8 Detection

This feature is used to enable/disable enhanced x8 DRAM UC error detection.

Enabled / Disabled

Watchdog Timer

This feature allows you to enable watchdog timer.

Disabled / 2 Mins / 4 Mins / 6 Mins / 8 Mins /10 Mins

Enable Multimedia Timer

This feature is used to enable/disable Multimedia Timer support.

Yes / **No**

Parallel ATA

This feature is used to enable the PATA function.

Enabled / Disabled

Serial ATA

This feature is used to enable the SATA function.

Enabled / Disabled

Native Mode Operation

This feature is used to choose Native Mode for ATA. However, certain OS is not supported under Native Mode.

Auto / Serial ATA

SATA Controller Mode Option

This feature is used to select SATA controller mode. In “compatible mode”, SATA and PATA drives are auto-detected and placed in Legacy mode. In “Enhanced (non-AHCI) mode”, SATA and PATA drives are auto-detected and placed in Native IDE mode.

Compatible / Enhanced (non-AHCI)

3.3.1.1 ICH USB Control Sub-Menu

These items are used to control the various ICH USB devices.

PhoenixBIOS Setup Utility					
Main	Advanced	Security	Power	Boot	Exit
ICH USB Control Sub Menu				Item Specific Help	
USB – Device 29, All Function:		[Enabled]			
USB – Device 29, F1, F2 and F3:		[Enabled]			
USB – Device 29, F2 and F3:		[Enabled]			
USB – Device 29, F3 Only		[Enabled]			
USB – Device 29, Function 7:		[Enabled]			
F1	Help	↑ ↓	Select Item	-/+	Change Values
Esc	Exit	← →	Select Menu	Enter	Select ▶ Sub-Menu F9 Setup Defaults
					F10 Previous Values

USB Device 29, All Function

Enable or Disable all USB devices by setting item to the desired value.

Enabled / Disabled

USB Device 29, F1, F2 and F3

Enable or Disable these 3 USB functions by setting item to the desired value.

Enabled / Disabled

USB Device 29, F2 and F3

Enable or Disable these 2 USB functions by setting item to the desired value.

Enabled / Disabled

USB Device 29, F3 Only

Control the listed USB function by setting the item to the desired value.

Enabled / Disabled

USB Device 29, Function 7:

Control USB 2.0 functionality through this Setup Item.

Enabled / Disabled

3.3.1.2 Lan Control Sub-Menu

These items allow you to control the LAN devices.

PhoenixBIOS Setup Utility					
Main	Advanced	Security	Power	Boot	Exit
LAN Control Sub Menu				Item Specific Help	
LAN1 (Gilgal)		[Enabled]			
Option ROM Scan		[Disabled]			
LAN2 (Gilgal)		[Enabled]			
Option ROM Scan		[Disabled]			
F1 Help	↑ ↓ Select Item	-/+ Change Values	F9 Setup Defaults		
Esc Exit	← → Select Menu	Enter Select	▶ Sub-Menu	F10 Previous Values	

LAN1 Gilgal/LAN2 Gilgal

This feature is used to enable/disable the integrated LAN interface.

Enabled / Disabled

Option ROM Scan

This option allows you to initialize the device expansion ROM.

Disabled / Enabled

3.3.2 Advanced Processor Options

This section allows you to fine-tune the processor options.

PhoenixBIOS Setup Utility					
Main	Advanced	Security	Power	Boot	Exit
Advanced Processor Options				Item Specific Help	
Hyperthreading:		[Enabled]			
Numbers of Step Grant		[Per Core]			
Intel® Virtualization Technology		[Disabled]			
Machine Checking		[Enabled]			
C1 Enhanced Mode		[Enabled]			
Thermal Management 2		[Enabled]			
No Execute Mode Mem Protection		[Enabled]			
Set Max Ext CPUID = 3		[Disabled]			
Discrete MTRR Allocation		[Disabled]			
Intel ETST Support		[Enabled]			
F1 Help ↑↓ Select Item -/+ Change Values F9 Setup Defaults Esc Exit ←→ Select Menu Enter Select ▶ Sub-Menu F10 Previous Values					

Hyperthreading

Enable this only if you have an Intel Hyper Threading processor.

Hyper-Threading Technology enables multi-threaded software applications to execute threads in parallel. Hyper-Threading Technology provides thread-level-parallelism (TLP) on each processor resulting in increased utilization of processor execution resources. As a result, resource utilization yields higher processing throughput. Hyper-Threading Technology is a form of simultaneous multi-threading technology (SMT) where multiple threads of software applications can be run simultaneously on one processor. This is achieved by duplicating the architectural state on each processor, while sharing one set of processor execution resources. Hyper-Threading Technology also delivers faster response times for multi-tasking workload environments. By allowing the processor to use on-die resources that would otherwise have been idle, Hyper-Threading Technology provides a performance boost on multi-threading and multi-tasking operations for the Intel NetBurst® microarchitecture.

Enabled / Disabled

Numbers of Step Grant

This feature is used to configure the numbers of Step Grant.

Per Core / Single

Intel® Virtualization Technology

This feature is used to configure the Intel Virtualization technology.

Disabled / Enabled

Machine Checking

This feature is used to enable the function of machine checking.

Enabled / Disabled

C1 Enhanced Mode

This feature is used to enable the C1 Enhanced mode.

Enabled / Disabled

Thermal Management 2

This feature is used to enable the function of Thermal Management 2. When TM2 is enabled and the thermal sensor detects the die temperature is above the predetermined Thermal Monitor activation temperature, the TM2 mechanism will reduce the bus to core ratio to the value contained in the Thermal Monitor Core to Bus Ratio field in the Thermal Monitor 2 Core to Bus Ratio/Voltage selection register, and then step the operating voltage down to the value contained in the thermal Monitor VID field in the thermal Monitor 2 Core to Bus Ratio/Voltage selection register.

Enabled / Disabled

No Execute Mode Mem Protection

Execution protection prevents code execution from data pages such as the default heap, various stacks, and memory pools. Protection can be applied in both user and kernel-mode. Windows XP SP2 supports this technology.

Enabled / Disabled

Set Max Ext CPUID=3

This feature is used to set Max CPUID extended function value to 3.

Disabled / Enabled

Discrete MTRR Allocation

This feature is used to configure the MTRR method. Disabling the feature will set the MTRR method in continuous status.

Disabled / Enabled

Intel ETST Support

This feature is used to enable the Intel ETST support.

Enabled / Disabled

3.3.3 I/O Device Configuration

This setting allows you to configure I/O devices.

PhoenixBIOS Setup Utility		
Main	Advanced	Security Power Boot Exit
I/O Device Configuration		Item Specific Help
Floppy disk controller	[Enabled]	
Serial port A:	[Enabled]	
Base I/O address:	[3F8]	
Interrupt:	[IRQ4]	
Serial port B:	[Enabled]	
Base I/O address	[2F8]	
Interrupt:	[IRQ3]	
F1 Help ↑ ↓ Select Item -/+ Change Values F9 Setup Defaults		
Esc Exit ← → Select Menu Enter Select ► Sub-Menu F10 Previous Values		

Floppy Disk Controller

This defines how the floppy disk controller is detected and configured.

Enabled/ Disabled

Serial Port A/B

This defines how the serial port is detected and configured.

Enabled / Disabled

Base I/O Address

This sets the base I/O address for serial port A/B.

3F8 / 2F8 / 3E8 / 2E8

Interrupt

This sets the interrupt for serial port A/B.

IRQ3 / IRQ4

3.3.4 Hardware Monitor Configuration

This displays critical system parameters like CPU speed, fan speeds, voltage levels and CPU temperature.

PhoenixBIOS Setup Utility					
Main	Advanced	Security	Power	Boot	Exit
Hardware Monitor				Item Specific Help	
▶Voltage Monitoring Cpu0 Fan Cpu1 Fan Fan1 Fan2 Fan3 Cpu0 Temp. System Temp. Auto Fan Control [Disabled]					
F1	Help	↑ ↓	Select Item	-/+	Change Values
Esc	Exit	← →	Select Menu	Enter	Select ▶ Sub-Menu
				F9	Setup Defaults
				F10	Previous Values

3.3.4.1 Voltage Monitoring Sub-Menu

PhoenixBIOS Setup Utility					
Main	Advanced	Security	Power	Boot	Exit
Voltage Monitoring				Item Specific Help	
3.3Vsb (7468) V+12 (W627) = V-12 (W627) = V+5 (W627) = VcorA (W627) = VcorB (W627) = VCC (W627) =					
F1	Help	↑ ↓	Select Item	-/+	Change Values
F9	Setup Defaults				
Esc	Exit	← →	Select Menu	Enter	Select ▶ Sub-Menu
F10	Previous Values				

3.3.5 DMI Event Logging

PhoenixBIOS Setup Utility							
Main	Advanced	Security	Power	Boot	Exit		
DMI Event Logging				Item Specific Help			
Event log validity		Valid					
Event log capacity		Space Available					
View DIM event log		[Enter]					
Event Logging		[Enabled]					
ECC Event Logging		[Enabled]					
Mark DMI events as read		[Enter]					
Clear all DIM event logs		[No]					
F1 Help ↑↓ Select Item -/+ Change Values F9 Setup Defaults Esc Exit ←→ Select Menu Enter Select ► Sub-Menu F10 Previous Values							

View DMI Event Log

This allows you to view the contents of DMI event log.

Event Logging

This option configures the logging of DMI events.

Enabled/ Disabled

ECC Event Logging

This option configures the logging of ECC events.

Enabled/ Disabled

Mark DMI Events as Read

Press "Enter" to mark all DMI events in the event log as read.

Clear All DMI Event Logs

Setting this to "Yes" will clear the DMI event log after rebooting.

No / Yes

3.3.6 Console Redirection

PhoenixBIOS Setup Utility					
Main	Advanced	Security	Power	Boot	Exit
Console Redirection				Item Specific Help	
Com Port Address		[Disabled]			
Baud Rate		[19.2K]			
Console Type		[VT100]			
Flow Control		[None]			
Console connection:		[Direct]			
Continue C.R. after POST:		[Off]			
F1 Help ↑ ↓ Select Item -/+ Change Values F9 Setup Defaults Esc Exit ← → Select Menu Enter Select ▶ Sub-Menu F10 Previous Values					

Com Port Address

If enabled it will use a port on the motherboard.

Disabled / On-board COM A / On-board COM B / NULL

Baud Rate

This feature is used to enable the specified baud rate.

300 / **19.2K** / 1200 / 2400 / 9600 / 38.4K / 57.6K / 115.2K

Console Type

This feature is used to enable the specified console type.

VT100 / VT100.8bit / PC-ANSI, 7bit / PC ANSI / VT100+ / VT-UTF8 / NULL

Flow Control

This feature is used to enable the flow control.

None / XON/XOFF / CTS/RTS

Console Connection

This feature is used to indicate whether the console is connected directly to the system or a modem is used to connect.

Direct / Via modem

Continue C.R. after POST

This feature is used to enable console redirection after OS has loaded.

Off / On

3.4 Security

These settings allow you to configure the security options for your system.

PhoenixBIOS Setup Utility									
Main	Advanced	Security	Power	Boot	Exit				
Supervisor Password Is:				Item Specific Help					
User Password Is:									
Set Supervisor Password		[Enter]							
Set User Password		[Enter]							
Password on boot:		[Disabled]							
F1	Help	↑ ↓	Select Item	-/+	Change Values	F9	Setup Defaults		
Esc	Exit	← →	Select Menu	Enter	Select	▶	Sub-Menu	F10	Previous Values

The system displays the current supervisor and user passwords.

Set Supervisor Password

This option allows the supervisor to set the supervisor password to restrict access to the BIOS settings.

Set User Password

This option allows the user to set the user password.

Password on boot

When enabled, the system will ask for a password at every boot. The system will continue booting only if the correct password is entered. If the wrong password is entered three times, the system will automatically shut down.

Disabled / Enabled

3.5 Power

These settings allow you to configure the power options for your system.

PhoenixBIOS Setup Utility					
Main	Advanced	Security	Power	Boot	Exit
ACPI Sleep Mode				[S1/S3]	Item Specific Help
Resume on Time				[Off]	
Resume Time				[xx:xx:xx]	
Chassis Intrusion Detect				[No]	
After Power Failure				[Stay Off]	
F1	Help	↑ ↓	Select Item	-/+	Change Values
Esc	Exit	← →	Select Menu	Enter	Select ▶ Sub-Menu
				F9	Setup Defaults
				F10	Previous Values

ACPI Sleep Mode

This allows you to select one of the ACPI power states: S1, S2 or S3. If selected, the corresponding power state will support.

S1/S3 / S3 / S1

Resume On Time

When enabled, this allows the system to be worked up at a specified time. This time is specified by the Resume Time parameter.

Off / On

Resume Time

This option allows the user to specify the time when the system is to wake up.

Chassis Intrusion Detect

This feature is used to set the function: when chassis open event is detected, BIOS will record the event.

No / Yes

After Power Failure

Specifies the mode of operation after the system recovers from a power loss.

Stay off / Last State / Power on

3.6 Boot Menu

Use this screen to select options for the Boot Settings Configuration.

PhoenixBIOS Setup Utility						
Main	Advanced	Security	Power	Boot	Exit	
1: Legacy Floppy Drives				Item Specific Help		
2:				Keys used to view or configure devices:		
3:				<Enter> expands or collapses devices with a + or -		
4:				<Ctrl + Enter> expands all		
5:				<Shift + 1> enables or disables a device.		
6:				<+> and <-> moves the device up or down.		
7:				<n> May move removable device between Hard Disk or Removable Disk.		
8:				<d> Remove a device that is not installed.		
: Legacy Network Card						
; Bootable Add-in Cards						
F1	Help	↑ ↓	Select Item	-/+	Change Values	F9 Setup Defaults
Esc	Exit	← →	Select Menu	Enter	Select	▶ Sub-Menu F10 Previous Values

The boot menu will list all bootable devices. Use <Enter> to expand or collapses devices with a '+' or '-'. Use <+> or <-> to arrange the priorities of all bootable devices.

3.7 Exit Menu

These settings set the exit options on your system.

PhoenixBIOS Setup Utility									
Main	Advanced	Security	Power	Boot	Exit				
Exit Saving Changes Exit Discarding Changes Load Setup Defaults Discard Changes Save Changes				Item Specific Help Exit system Setup and save your changes to CMOS.					
F1	Help	↑ ↓	Select Item	-/+	Change Values	F9	Setup Defaults		
Esc	Exit	← →	Select Menu	Enter	Select	▶	Sub-Menu	F10	Previous Values

Exit Saving Changes

This exits BIOS setup after saving the changes made.

Exit Discarding Changes

This exits BIOS setup after discarding the changes made.

Load Setup Defaults

Loads the factory default values.

Discard Changes

Discards all changes made without exiting BIOS setup.

Save Changes

Saves all changes made without exiting BIOS.

NOTE

Chapter 4: Diagnostics

NOTE: If you experience problems with setting up your system, always check the following things in the following order:

Memory, Video, CPU

By checking these items, you will most likely find out what the problem might have been when setting up your system. For more information on troubleshooting, check the TYAN website at: <http://www.tyan.com>.

4.1 Beep Codes

Fatal errors, which halt the boot process, are communicated through two kinds of audible beeps.

- A single long beep followed by two short beeps: It indicates that a video error has occurred and the BIOS can't initialize the video screen to display and additional info.
- A single long beep repeatedly: This indicates that a DRAM error has occurred.

The most common type of error is a memory error.

Before contacting your vendor or TYAN Technical Support, be sure that you note as much as you can about the beep code length and order that you experience. Also, be ready with information regarding add-in cards, drives and O/S to speed the support process and come to a quicker solution.

4.2 Flash Utility

Every BIOS file is unique for the motherboard it was designed for. For Flash Utilities, BIOS downloads, and information on how to properly use the Flash Utility with your motherboard, please check the TYAN web site: <http://www.tyan.com/>

Note



Please be aware that by flashing your BIOS, you agree that in the event of a BIOS flash failure, you must contact your dealer for a replacement BIOS. There are no exceptions. TYAN does not have a policy for replacing BIOS chips directly with end users. In no event will TYAN be held responsible for damages done by the end user.

4.3 - BIOS Post Code

Code	Beeps / Description	Code	Beeps / Description
02h	Verify Real Mode	32h	Test CPU bus-clock frequency
03h	Disable Non-Maskable Interrupt (NMI)	33h	Initialize Phoenix Dispatch Manager
04h	Get CPU type	36h	Warm start shut down
06h	Initialize system hardware	38h	Shadow system BIOS ROM
08h	Initialize chipset with initial POST values	3Ah	Autosize cache
09h	Set IN POST flag	3Ch	Advanced configuration of chipset registers
0Ah	Initialize CPU registers	3Dh	Load alternate registers with CMOS values
0Bh	Enable CPU cache	42h	Initialize interrupt vectors
0Ch	Initialize caches to initial POST values	45h	POST device initialization
0Eh	Initialize I/O component	46h	2-1-2-3. Check ROM copyright notice
0Fh	Initialize the local bus IDE	48h	Check video configuration against CMOS
10h	Initialize Power Management	49h	Initialize PCI bus and devices
11h	Load alternate registers with initial POST values	4Ah	Initialize all video adapters in system
12h	Restore CPU control word during warm boot	4Bh	QuietBoot start (optional)
13h	Initialize PCI Bus Mastering devices	4Ch	Shadow video BIOS ROM
14h	Initialize keyboard controller	4Eh	Display BIOS copyright notice
16h	1-2-2-3. BIOS ROM checksum	50h	Display CPU type and speed
17h	Initialize cache before memory autosize	51h	Initialize EISA board
18h	8254 timer initialization	52h	Test keyboard
1Ah	8237 DMA controller initialization	54h	Set key click if enabled
1Ch	Reset Programmable Interrupt Controller	58h	2-2-3-1. Test for unexpected interrupts
20h	1-3-1-1. Test DRAM refresh	59h	Initialize POST display service
22h	1-3-1-3. Test 8742 KBD Controller	5Ah	Display prompt "Press F2 to enter SETUP"
24h	Set ES segment register to 4 GB	5Bh	Disable CPU cache
26h	Enable A20 line	5Ch	Test RAM between 512 and 640 KB
28h	Autosize DRAM	60h	Test extended memory
29h	Initialize POST Memory Manager	62h	Test extended memory address lines
2Ah	Clear 512 KB base RAM	64h	Jump to UserPatch1
2Ch	1-3-4-1. RAM failure on address	66h	Configure advanced cache registers
2Eh	1-3-4-3. RAM failure on data bits of low byte of memory bus	67h	Initialize Multi Processor APIC
2Fh	Enable cache before	68h	Enable external and CPU

	system BIOS shadow		caches
30h	1-4-1-1. RAM failure on data bits of high byte of memory bus	69h	Setup System Management Mode (SMM) area
6Ah	Display external L2 cache size	A2h	Check key lock
6Bh	Load custom defaults (optional)	A4h	Initialize Typematic rate
6Ch	Display shadow-area message	A8h	Erase F2 prompt
6Eh	Display possible high address for UMB recovery	AAh	Scan for F2 key stroke
70h	Display error messages	ACh	Enter SETUP
72h	Check for configuration errors	AEh	Clear Boot flag
76h	Check for keyboard errors	B0h	Check for errors
7Ch	Set up hardware interrupt vectors	B2h	POST done - prepare to boot operating system
7Eh	Initialize coprocessor if present	B4h	One short beep before boot
80h	Disable onboard Super I/O ports and IRQs	B5h	Terminate QuietBoot (optional)
81h	Late POST device initialization	B6h	Check password (optional)
82h	Detect and install external RS232 ports	B9h	Prepare Boot
83h	Configure non-MCD IDE controllers	BAh	Initialize DMI parameters
84h	Detect and install external parallel ports	BBh	Initialize PnP Option ROMs
85h	Initialize PC-compatible PnP ISA devices	BCh	Clear parity checkers
86h	Re-initialize onboard I/O ports.	BDh	Display MultiBoot menu
87h	Configure Motherboard Devices	BEh	Clear screen (optional)
88h	Initialize BIOS Data Area	BFh	Check virus and backup reminders
89h	Enable Non-Maskable Interrupts (NMIs)	C0h	Try to boot with INT 19
8Ah	Initialize Extended BIOS Data Area	C1h	Initialize POST Error Manager (PEM)
8Bh	Test and initialize PS/2 mouse	C2h	Initialize error logging
8Ch	Initialize floppy controller	C3h	Initialize error display function
8Fh	Determine number of ATA drives (optional)	C4h	Initialize system error handler
90h	Initialize hard-disk controllers	C5h	PnPnd dual CMOS (optional)
91h	Initialize local-bus hard-disk controllers	C6h	Initialize notebook docking (optional)
92h	Jump to UserPatch2	C7h	Initialize notebook docking late
93h	Build MPTABLE for multi-processor boards	C8h	Force check (optional)
95h	Install CD ROM for boot	C9h	Extended checksum (optional)
96h	Clear huge ES segment register	D2h	BIOS Boot Block

97h	Fixup Multi Processor table	E0h	BIOS Boot Block
98h	1-2. Search for option ROMs.	E1h	BIOS Boot Block
99h	Check for SMART Drive (optional)	E2h	Initialize the CPU
9Ah	Shadow option ROMs	E3h	Initialize system timer
9Ch	Set up Power Management	E4h	Initialize system I/O
9Dh	Initialize security engine (optional)	E5h	Check force recovery boot
9Eh	Enable hardware interrupts	E6h	Checksum BIOS ROM
9Fh	Determine number of ATA and SCSI drives	E7h	Go to BIOS
A0h	Set time of day	E8h	Set Huge Segment
E9h	Initialize Multi Processor	F1h	Initialize Run Time Clock
EAh	Initialize OEM special code	F2h	Initialize video
EBh	Initialize PIC and DMA	F3h	Initialize System Management Mode
ECh	Initialize Memory type	F4h	Output one beep before boot
EDh	Initialize Memory size	F5h	Boot to Mini DOS
EEh	Shadow Boot Block	F6h	Clear Huge Segment
EFh	System memory test	F7h	Boot to Full DOS
F0h	Initialize interrupt vectors		

Appendix I: SMDC Information

Overview

Tyan Server Management Daughter Card (SMDC) is a powerful yet cost-efficient solution for high-end server management hardware packages. Tyan's goal is to provide remote system monitoring and control even when the operating system is absent or simply fails. This empowers Tyan's server board with advanced industrial-standard features.

Tyan SMDC is a snap-in card that provides essential server management solution. It enables any IT Manager by providing multi-interfaces to access the hardware remotely and perform **monitor**, **control** and **diagnose** activities effectively.

Tyan SMDC is not a peripheral card. Unlike regular peripheral card such as AGP card, Network card or SCSI card, SMDC does not require any hardware specific driver. As long as a standby power comes into the system, SMDC will begin looking after the system.

Tyan SMDC provides diversified methods to communicate with the hardware. IT manager has the flexibility to choose among *Keyboard Controller Style (KCS)*, *Block Transfer (BT)* style, Intelligent Chassis Management Bus (ICMB), Intelligent Platform Management Bus (IPMB), Emergency Management Port (EMP) and standard IPMI-Over-LAN communication as defined in latest IPMI 1.5 specification.

Tyan SMDC is compatible with all IPMI-compliance software as well as Tyan System Operator™ (TSO) software package.

By adding SMDC, Tyan's server board becomes a highly manageable and IPMI compatible system with all the advanced features suggesting in IPMI Spec.

More detailed information on Tyan's SMDC card can be found on our website: <http://www.tyan.com>

Features of Tyan Server Management



Monitor various system components remotely
-such as fans, processor temperature, and more



Remote power on and power off



Console redirect
-the ability to view system remotely



Alert and error actions
-such as audible beep, e-mail, power down and reboot



SMDC runs on stand-by power
-the SMDC will continue to function, even if the system is not powered on

How SMDC and TSO Work

The brief descriptions below will help explain how these items function.

	<p>Agent – a system with SMDC installed The SMDC is installed in the Agent system that uses a compatible/supported Tyan motherboard.</p>
	<p>Manager – manages the Agent The Manger is set up to manage the Agent that has the SMDC. The Manager and Agent should be located in the same place.</p>
	<p>Console – communicates with Manager The Console is used to monitor and control the Agent through the Manager.</p>

Appendix II: How to Make a Driver Diskette

Follow the steps below to make a driver diskette from the TYAN driver CD provided.

1. Start the system and insert the TYAN CD into the CD-ROM drive to boot from CD. You will see the following menu. Then press [1] and [Enter] to boot the system to Tyan diskette maker. (If you would like to boot from hard disk, press 0 and Enter or just wait for 10 seconds to boot automatically from hard disk.).

```
Boot from CD:
ISOLINUX 2.00 2002-10-25 Copyright (C) 1994-2002 H. Peter Anvin
0) Boot from first hard drive
1) Boot to TYAN diskette maker
boot: 1_
```

2. Choose the chipset vender which you need from the main menu.

```
TYAN Driver Diskette Maker V1.0

** Main Menu**
====Choose Chipset Vendor=====

01  Adaptec
02  nVidia
03  LSI
04  Intel
05  Promise
06  Silicon Image
07  VIA

EXIT
```

3. The following picture pops up after selecting the chipset model.

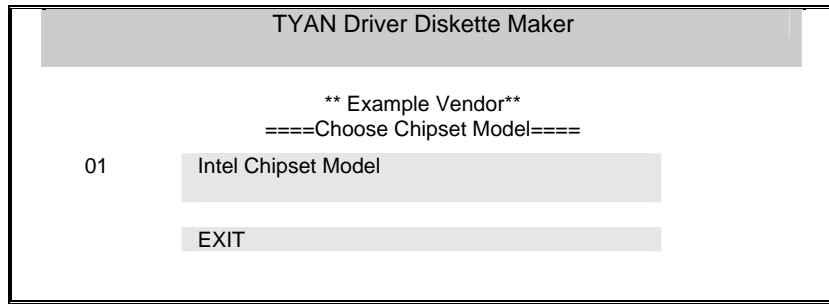

4. After selecting the chipset model, select the OS to start the diskette making.

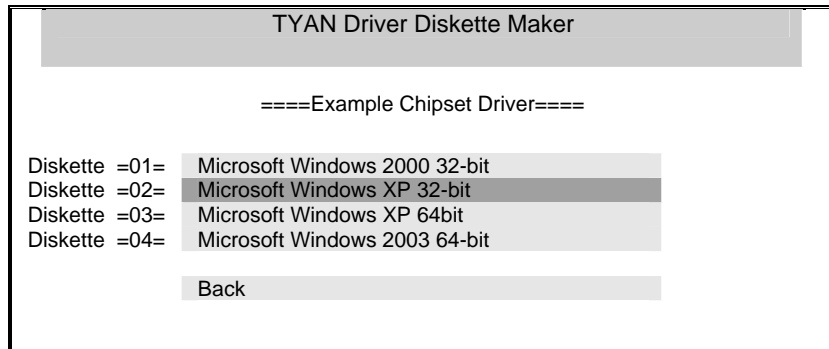

5. Follow the instruction on menu to insert a diskette and press [ENTER].

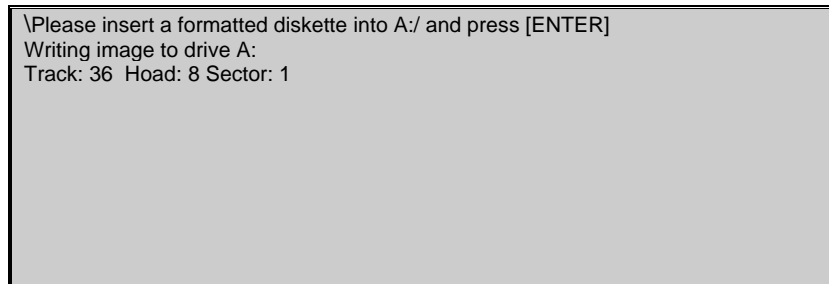

6. Using "ESC" key to quit the Tyan diskette maker. The system will automatically restart.

Glossary

ACPI (Advanced Configuration and Power Interface): a power management specification that allows the operating system to control the amount of power distributed to the computer's devices. Devices not in use can be turned off, reducing unnecessary power expenditure.

AGP (Accelerated Graphics Port): a PCI-based interface which was designed specifically for demands of 3D graphics applications. The 32-bit AGP channel directly links the graphics controller to the main memory. While the channel runs at only 66 MHz, it supports data transmission during both the rising and falling ends of the clock cycle, yielding an effective speed of 133 MHz.

ATAPI (AT Attachment Packet Interface): also known as IDE or ATA; a drive implementation that includes the disk controller on the device itself. It allows CD-ROMs and tape drives to be configured as master or slave devices, just like HDDs.

ATX: the form factor designed to replace the AT form factor. It improves on the AT design by rotating the board 90 degrees, so that the IDE connectors are closer to the drive bays, and the CPU is closer to the power supply and cooling fan. The keyboard, mouse, USB, serial, and parallel ports are built-in.

Bandwidth: refers to carrying capacity. The greater the bandwidth, the more data the bus, phone line, or other electrical path, can carry. Greater bandwidth, then, also results in greater speed.

BBS (BIOS Boot Specification): is a feature within the BIOS that creates, prioritizes, and maintains a list of all Initial Program Load (IPL) devices, and then stores that list in NVRAM. IPL devices have the ability to load and execute an OS, as well as provide the ability to return to the BIOS if the OS load process fails for some reason. At that point, the next IPL device is called upon to attempt loading of the OS.

BIOS (Basic Input/Output System): the program that resides in the ROM chip, and provides the basic instructions for controlling your computer's hardware. Both the operating system and application software use BIOS routines to ensure compatibility.

Buffer: a portion of RAM which is used to temporarily store data, usually from an application, though it is also used when printing, and in most keyboard drivers. The CPU can manipulate data in a buffer before copying it, all at once, to a disk drive. While this improves system performance --- reading to or writing from a disk drive a single time is much faster than doing so repeatedly --- there is also the possibility of losing your data should the system crash. Information stored in a buffer is temporarily stored, not permanently saved.

Bus: a data pathway. The term is used especially to refer to the connection between the processor and system memory, and between the processor and PCI or ISA local buses.

Bus mastering: allows peripheral devices and IDEs to access the system memory without going through the CPU (similar to DMA channels).

Cache: a temporary storage area for data that will be needed often by an application. Using a cache lowers data access times, since the needed information is stored in the SRAM instead of in the slow DRAM. Note that the cache is also much smaller than your regular memory: a typical cache size is 512KB, while you may have as much as 4GB of regular memory.

Cache size: refers to the physical size of the cache onboard. This should not be confused with the cacheable area, which is the total amount of memory which can be scanned by the system in search of data to put into the cache. A typical setup would be a cache size of 512KB, and a cacheable area of 512MB. In this case, up to 512KB of the main memory onboard is capable of being cached. However, only 512KB of this memory will be in the cache at any given moment. Any main memory above 512MB could never be cached.

Closed and open jumpers: jumpers and jumper pins are active when they are “on” or “closed”, and inactive when they are “off” or “open”.

CMOS (Complementary Metal-Oxide Semiconductors): chips that hold the basic startup information for the BIOS.

COM port: another name for the serial port, which is called as such because it transmits the eight bits of a byte of data along one wire, and receives data on another single wire (that is, the data is transmitted in serial form, one bit after another). Parallel ports transmit the bits of a byte on eight different wires at the same time (that is, in parallel form, eight bits at the same time).

DDR (Double Data Rate): is a technology designed to double the clock speed of the memory. It activates output on both the rising and falling edge of the system clock rather than on just the rising edge, potentially doubling output.

DIMM (Dual In-line Memory Module): faster and more capacious form of RAM than SIMMs, and do not need to be installed in pairs.

DIMM bank: sometimes called DIMM sockets, because the physical slot and the logical unit are the same. That is, one DIMM module fits into one DIMM socket, which is capable of acting as a memory bank.

DMA (Direct Memory Access): channels that are similar to IRQs. DMA channels allow hardware devices (like soundcards or keyboards) to access the main memory without involving the CPU. This frees up CPU resources for other tasks. As with

IRQs, it is vital that you do not double up devices on a single line. Plug-n-Play devices will take care of this for you.

Doze mode: in this mode, only the CPU's speed is slowed.

DRAM (Dynamic RAM): widely available, very affordable form of RAM which has the unfortunate tendency to lose data if it is not recharged regularly (every few milliseconds). This refresh requirement makes DRAM three to ten times slower than non-recharged RAM such as SRAM.

ECC (Error Correction Code or Error Checking and Correcting): allows data to be checked for errors during run-time. Errors can subsequently be corrected at the same time that they're found.

EEPROM (Electrically Erasable Programmable ROM): also called Flash BIOS, is a ROM chip which can, unlike normal ROM, be updated. This allows you to keep up with changes in the BIOS programs without having to buy a new chip. TYAN's BIOS updates can be found at <http://www.tyan.com>

EMRL: Embedded RAID Logic. An Adaptec specific RAID technology.

ESCD (Extended System Configuration Data): a format for storing information about Plug-n-Play devices in the system BIOS. This information helps properly configure the system each time it boots.

Fault-tolerance: a term describing a system where one component can quickly be replaced without causing a loss of service, such as in a RAID system.

Firmware: low-level software that controls the system hardware.

Form factor: an industry term for the size, shape, power supply type, and external connector type of the Personal Computer Board (PCB) or motherboard. The standard form factors are the AT and ATX, although TYAN also makes some Baby-AT and ATX Footprint boards.

Global timer: onboard hardware timer, such as the Real-Time Clock (RTC).

Handshaking: a process where two devices initiate communications. One device, typically the server, sends a message to another device, typically a client, in order to request establishment of a communications channel. The two devices will then exchange messages back and forth in order to settle on a communications protocol.

HDD: stands for Hard Disk Drive, a type of fixed drive.

H-SYNC: controls the horizontal synchronization/properties of the monitor.

IC (Integrated Circuit): the formal name for the computer chip.

IDE (Integrated Device/Drive Electronics): a simple, self-contained HDD interface. It can handle drives up to 8.4 GB in size. Almost all IDEs sold now are in fact Enhanced IDEs (EIDEs), with maximum capacity determined by the hardware controller.

IDE INT (IDE Interrupt): a hardware interrupt signal that goes to the IDE.

I/O (Input/Output): the connection between your computer and another piece of hardware (mouse, keyboard, etc.)

Initial Program Load (IPL): a feature built into BBS-compliant devices, describing those devices as capable of loading and executing an OS, as well as being able to provide control back to the BIOS if the loading attempt fails.

IPL: see Initial Program Load.

IRQ (Interrupt Request): an electronic request that runs from a hardware device to the CPU. The interrupt controller assigns priorities to incoming requests and delivers them to the CPU. It is important that there is only one device hooked up to each IRQ line; doubling up devices on IRQ lines can lock up your system. Plug-n-Play operating systems can take care of these details for you.

ISA (Industry Standard Architecture): a slower 8- or 16-bit bus (data pathway).

Latency: the amount of time that one part of a system spends waiting for another part to catch up. This is most common when the system sends data out to a peripheral device, and it waiting for the peripheral to send some data back (peripherals tend to be slower than onboard system components).

Mirroring: see RAID.

NVRAM: ROM and EEPROM are both examples of Non-Volatile RAM, memory that holds its data without power. DRAM, in contrast, is volatile.

OEMs (Original Equipment Manufacturers): Compaq or IBM package other companies' motherboards and hardware inside their case and sell them.

Parallel port: transmits the bits of a byte on eight different wires at the same time (that is, in parallel form, eight bits at the same time).

PCI (Peripheral Component Interconnect): a 32 or 64-bit local bus (data pathway) which is faster than the ISA bus. Local buses are those which operate within a single system (as opposed to a network bus, which connects multiple systems).

PCI PIO (PCI Programmable Input/Output) modes: the data transfer modes used by IDE drives. These modes use the CPU for data transfer (in contrast, DMA channels do not). PCI refers to the type of bus used by these modes to communicate with the CPU.

PCI-to-PCI bridge: allows you to connect multiple PCI devices onto one PCI slot.

Pipeline burst SRAM: a type of RAM that can maintain its data as long as power is provided to the memory chips. In this configuration, SRAM requests are pipelined, which means that larger packets of data are sent to the memory at one time, and acted upon quickly. This type of SRAM operates at bus speeds higher than 66MHz.

Pipelining: improves system performance by allowing the CPU to begin executing a second instruction before the first is completed. A pipeline can be likened to an assembly line, with a given part of the pipeline repeatedly executing a set part of an operation on a series of instructions.

PM timers (Power Management timers): software timers that count down the number of seconds or minutes until the system times out and enters sleep, suspend, or doze mode.

PnP (Plug-n-Play): a design standard that has become ascendant in the industry. Plug-n-Play devices require little set-up to use. Novice end users can simply plug them into a computer that is running on a Plug-n-Play aware operating system (such as Windows 98), and go to work. Devices and operating systems that are not Plug-n-Play require you to reconfigure your system each time you add or change any part of your hardware.

PXE (Preboot Execution Environment): one of four components that together make up the Wired for Management 2.0 baseline specification. PXE was designed to define a standard set of preboot protocol services within a client, towards the goal of allowing networked-based booting to boot using industry standard protocols.

RAID (Redundant Array of Independent Disks): a way for the same data to be stored in different places on many hard drives. By using this method, the data is stored redundantly, also the multiple hard drives will appear as a single drive to the operating system. RAID level 0 is known as striping, where data is striped (or overlapped) across multiple hard drives, but offers no fault-tolerance. RAID level 1 is known as mirroring, which stores the data within at least two hard drives, but does not stripe. RAID level 1 also allows for faster access time and fault-tolerance, since either hard drive can be read at the same time. RAID level 0+1 is both striping and mirroring, providing fault-tolerance, striping, and faster access all at the same time.

RAIDIOS: stands for RAID I/O Steering, a type of RAID technology from Intel. RAIDIOS is a specification used to enable an embedded I/O controller, embedded on the motherboard, to be used as just an I/O controller or to be the I/O component of a hardware RAID subsystem. The RAIDIOS circuit allows an I/O Processor (either embedded on the motherboard or on an add-in card) to configure the I/O controller and service the I/O controller's interrupts. The I/O controller and the I/O Processor together are two of the primary components of a hardware RAID subsystem.

RAM (Random Access Memory): technically refers to a type of memory where any byte can be accessed without touching the adjacent data, is often used to refer to the system's main memory. This memory is available to any program running on the computer.

ROM (Read-Only Memory): a storage chip which contains the BIOS; the basic instructions required to boot the computer and start up the operating system.

SATA (Serial ATA): is an evolutionary replacement for the Parallel ATA physical storage interface. Serial ATA is a drop-in solution in that it is compatible with today's software and operating systems. It will provide for systems which are easier to design, with cables that are simpler to route and install, smaller cable connectors, and lower voltage requirements.

SDRAM (Synchronous Dynamic RAM): called as such because it can keep two sets of memory addresses open simultaneously. By transferring data alternately from one set of addresses and then the other, SDRAM cuts down on the delays associated with non-synchronous RAM, which must close one address bank before opening the next.

Serial port: called as such because it transmits the eight bits of a byte of data along one wire, and receives data on another single wire (that is, the data is transmitted in serial form, one bit after another).

SCSI Interrupt Steering Logic (SISL): Architecture that allows a RAID controller, such as AcceleRAID 150, 200 or 250, to implement RAID on a system board-embedded SCSI bus or a set of SCSI busses. SISL: SCSI Interrupt Steering Logic (LSI) (only on LSI SCSI boards)

SIMM (Single In-line Memory Module): formally the most common form of RAM for motherboards. They must be installed in pairs, and do not have the carrying capacity or the speed of DIMM modules.

Sleep/Suspend mode: in this mode, all devices except the CPU shut down.

SRAM (Static RAM): unlike DRAM, this type of RAM does not need to be refreshed in order to prevent data loss. Thus, it is faster and more expensive.

SSI (Server System Infrastructure): an industry initiative intended to provide ready-to-use design specifications for common server hardware elements (chassis, power supplies, and racks) to promote and support server industry growth.

Standby mode: in this mode, the video and hard drives shut down; all other devices continue to operate normally.

Striping: see RAID

UltraDMA-33/66/100: a fast version of the old DMA channel. UltraDMA is also called UltraATA. Without proper UltraDMA controller, your system cannot take advantage of higher data transfer rates of the new UltraDMA/UltraATA hard drives.

USB (Universal Serial Bus): a versatile port. This one port type can function as a serial, parallel, mouse, keyboard or joystick port. It is fast enough to support video transfer, and is capable of supporting up to 127 daisy-chained peripheral devices.

VGA (Video Graphics Array): the PC video display standard

V-SYNC: controls the vertical scanning properties of the monitor.

ZCR: Zero Channel RAID. PCI card that allows a RAID card to use the onboard SCSI chip, thus lowering cost of RAID solution

ZIF Socket (Zero Insertion Force socket): these sockets make it possible to insert CPUs without damaging the sensitive CPU pins. The CPU is lightly placed in an open ZIF socket, and a lever is pulled down. This shift the processor over and down, guiding into the board and locking it into place.

Technical Support

If a problem arises with your system, you should turn to your dealer for help first. Your system has most likely been configured by them, and they should have the best idea of what hardware and software your system contains. Furthermore, if you purchased your system from a dealer near you, you can bring your system to them to have it serviced instead of attempting to do so yourself (which can have expensive consequences).

Help Resources:

1. See the beep codes section of this manual.
2. See the TYAN website for FAQ's, bulletins, driver updates, and other information: <http://www.tyan.com>
3. Contact your dealer for help BEFORE calling TYAN.
4. Check the TYAN user group:
alt.comp.periphs.mainboard.TYAN

Returning Merchandise for Service

During the warranty period, contact your distributor or system vendor FIRST for any product problems. This warranty only covers normal customer use and does not cover damages incurred during shipping or failure due to the alteration, misuse, abuse, or improper maintenance of products.

NOTE: A receipt or copy of your invoice marked with the date of purchase is required before any warranty service can be rendered. You may obtain service by calling the manufacturer for a Return Merchandise Authorization (RMA) number. The RMA number should be prominently displayed on the outside of the shipping carton and the package should be mailed prepaid. TYAN will pay to have the board shipped back to you.

**Notice for the USA**

Compliance Information Statement (Declaration of
Conformity Procedure) DoC
FCC Part 15: This device complies with part 15 of the FCC
Rules

Operation is subject to the following conditions:

This device may not cause harmful interference, and
This device must accept any interference received including interference that
may cause undesired operation. If this equipment does cause harmful
interference to radio or television reception, which can be determined by turning
the equipment off and on, the user is encouraged to try one or more of the
following measures:

Reorient or relocate the receiving antenna.
Increase the separation between the equipment and the receiver.
Plug the equipment into an outlet on a circuit different from that of the receiver.
Consult the dealer on an experienced radio/television technician for help.

Notice for Canada

This apparatus complies with the Class B limits for radio interference as
specified in the Canadian Department of Communications Radio Interference
Regulations. (Cet appareil est conforme aux norms de Classe B d'interference
radio tel que specifie par le Ministere Canadien des Communications dans les
reglements d'interference radio.)



Notice for Europe (CE Mark)
This product is in conformity with the Council Directive
89/336/EEC, 92/31/EEC (EMC).

CAUTION: Lithium battery included with this board. Do not puncture, mutilate,
or dispose of battery in fire. Danger of explosion if battery is incorrectly replaced.
Replace only with the same or equivalent type recommended by manufacturer.
Dispose of used battery according to manufacturer instructions and in
accordance with your local regulations.

Document #: D1760-100