

Always there to help you

Register your product and get support at
www.philips.com/welcome



BTM2056



User Manual

PHILIPS

Contents

1 Important 3

2 Your Micro System 4

- Introduction 4
 - What's in the box 4
 - Overview of the main unit 5
 - Overview of the remote control 6
-

3 Get started 8

- Placement 8
 - Prepare FM antenna 8
 - Prepare the remote control 8
 - Connect power 8
 - Turn on 9
 - Set clock 9
 - Store FM radio stations automatically 9
-

4 Play 10

- Play disc 10
 - Play from a USB storage device 10
 - Play from Bluetooth-enabled devices 11
 - Play options 11
 - Display different information 12
-

5 Listen to FM radio 13

- Tune to FM radio stations 13
 - Program FM radio stations automatically 13
 - Program FM radio stations manually 13
 - Select a preset radio station 13
 - Show RDS information 13
 - Select stereo/mono broadcast 14
-

6 Other features 14

- Set the alarm timer 14
 - Set the sleep timer 15
 - Play from an external device 15
 - Listen through the headphone 15
-

7 Product information 16

- Specifications 16
 - USB playability information 16
 - Supported MP3 disc formats 17
 - RDS program types 17
-

8 Troubleshooting 18

- About Bluetooth device 18
-

9 Notice 20

1 Important

Warning

- Never remove the casing of this micro system.
 - Never lubricate any part of this system.
 - Never place this system on other electrical equipment.
 - Never look into the laser beam inside this system.
 - Keep this system away from direct sunlight, naked flames or heat.
 - Make sure that you always have easy access to the power cord, plug or adaptor to disconnect the system from the power.
-
- Batteries (battery pack or batteries installed) shall not be exposed to excessive heat such as sunshine, fire or the like.
 - Battery usage CAUTION – To prevent battery leakage which may result in bodily injury, property damage, or damage to the remote control:
 - Install all batteries correctly, + and - as marked on the remote control.
 - Do not mix batteries (old and new or carbon and alkaline, etc.).
 - Remove batteries when the remote control is not used for a long time.
 - Make sure that there is enough free space around the product for ventilation.
 - The system shall not be exposed to dripping or splashing.
 - Do not place any sources of danger on the system (e.g. liquid filled objects, lighted candles).
 - Where the plug of the Direct Plug-in Adapter is used as the disconnect device, the disconnect device shall remain readily operable.

Hearing safety



Caution

- To prevent possible hearing damage, do not listen at high volume levels for long periods. Set the volume to a safe level. The louder the volume, the shorter is the safe listening time.

Be sure to observe the following guidelines when using your headphones.

- Listen at reasonable volumes for reasonable periods of time.
- Be careful not to adjust the volume continuously upwards as your hearing adapts.
- Do not turn up the volume so high that you can't hear what's around you.
- You should use caution or temporarily discontinue use in potentially hazardous situations.
- Excessive sound pressure from earphones and headphones can cause hearing loss.

2 Your Micro System

Congratulations on your purchase, and welcome to Philips! To fully benefit from the support that Philips offers, register your product at www.philips.com/welcome.

Introduction

With this micro system, you can:

- enjoy audio from discs, Bluetooth-enabled devices, USB devices, and other external devices; and
- listen to FM radio

You can enrich sound output with these sound effects:

- Digital Sound Control (DSC)
- Dynamic Bass Boost (DBB)

What's in the box

Check and identify the contents of your package:

- Main unit
- Remote control
- Power adapter
- Mounting kit (2 dowels and 2 screws)
- 2 x AAA batteries
- FM antenna
- Short user manual
- Safety & notice leaflet
- Wall mounting instructions

If you contact Philips, you will be asked for the model and serial number of this system. The model number and serial number are on the bottom of the system. Write the numbers here:

Model No. _____

Serial No. _____

Overview of the main unit

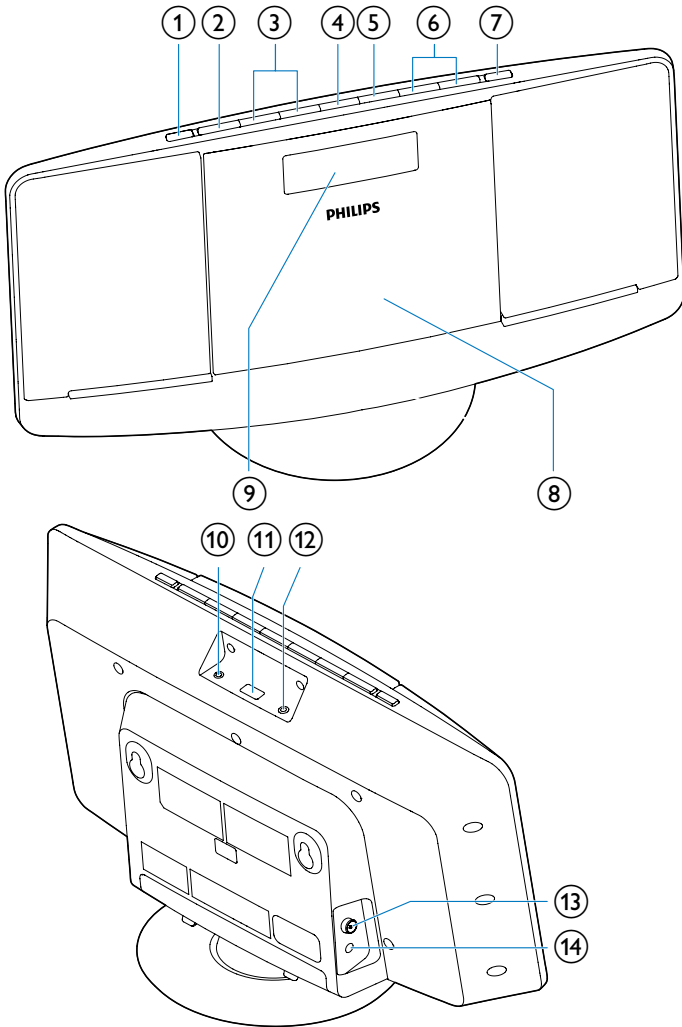

① 

- Turn the system on.
- Switch to standby mode.

② **SOURCE**

- Select a source: CD, Bluetooth, FM tuner, USB, or MP3 LINK.

- ③ **⏮ / ⏭**
 - Skip to the previous or next track.
 - Search within a track or disc.
 - Tune to FM radio stations.
 - Adjust time.
- ④ **▶ ||**
 - Confirm a selection.
 - Select mono or stereo broadcast.
 - Start or pause play.
- ⑤ **■**
 - Stop play or erase a program.
- ⑥ **VOLUME + / -**
 - Adjust volume.
- ⑦ **▲**
 - Open or close the disk tray.
- ⑧ **Disc tray**
- ⑨ **Display panel**
 - Show play information.
- ⑩ **MP3 LINK**
 - Connect an external audio device.
- ⑪ **↔**
 - Connect a USB device.
- ⑫ **🎧**
 - Headphone socket.
- ⑬ **FM ANT**
 - Improve FM reception.
- ⑭ **DC IN**
 - Connect power.

Overview of the remote control

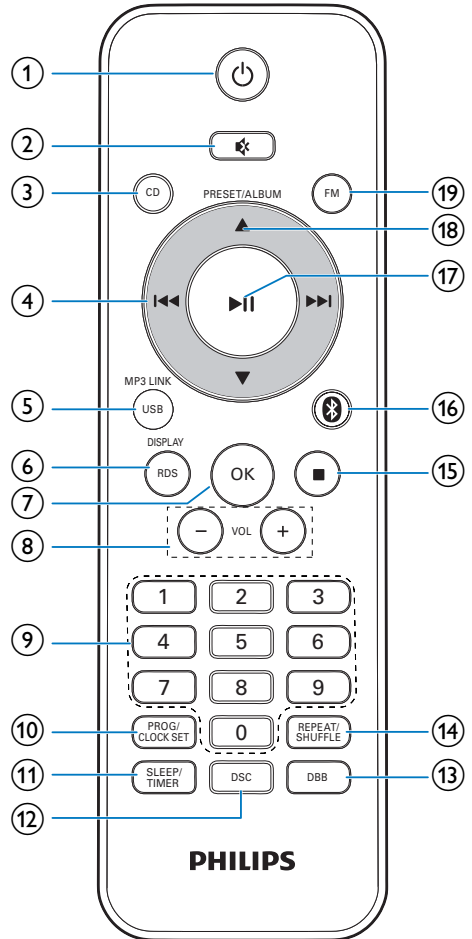

- ① **⏻**
 - Turn the system on.
 - Switch to standby mode.
- ② **🔇**
 - Mute or resume sound.
- ③ **CD**
 - Select CD source.

- ④ **⏮ / ⏭**
 - Skip to the previous or next track.
 - Search within a track or disc.
 - Tune to radio stations.
 - Adjust time.
- ⑤ **USB/MP3 LINK**
 - Select USB or MP3 link source.
- ⑥ **RDS/DISPLAY**
 - For FM radio stations with RDS signals: display RDS information.
 - Show time and play information.
- ⑦ **OK**
 - Confirm a selection.
- ⑧ **VOL +/-**
 - Adjust volume.
- ⑨ **Numeric Keypad 0 - 9**
 - Select a track from a disc or USB device directly.
 - Select a preset radio station.
- ⑩ **PROG/CLOCK SET**
 - Program tracks.
 - Program radio stations.
 - Set time.
- ⑪ **SLEEP/TIMER**
 - Set sleep or alarm timer.
- ⑫ **DSC**
 - Select a preset sound setting.
- ⑬ **DBB**
 - Turn dynamic bass enhancement on or off.
- ⑭ **REPEAT/SHUFFLE**
 - Play a track or all tracks repeatedly.
 - Play tracks in current album repeatedly.
 - Play tracks randomly.
- ⑮ **■**
 - Stop play or erase a program.
- ⑯ **📶**
 - Select Bluetooth source.
- ⑰ **▶ ||**
 - Start or pause play.
 - Select mono or stereo broadcast.
- ⑱ **▲ / ▼**
 - Select a preset radio station.
 - Skip to the previous or next album.
- ⑲ **FM**
 - Select FM tuner source.

3 Get started

! Caution

- Use of controls or adjustments or performance of procedures other than herein may result in hazardous radiation exposure or other unsafe operation.

Always follow the instructions in this chapter in sequence.

Placement

You can place the system on a flat surface or mount it on a wall.

Mount on a wall

See the wall mounting instructions included in the package.

Prepare FM antenna

* Tip

- For optimal reception, fully extend and adjust the position of the antenna.

Connect the supplied FM antenna to the **FM ANT** socket on the main unit.

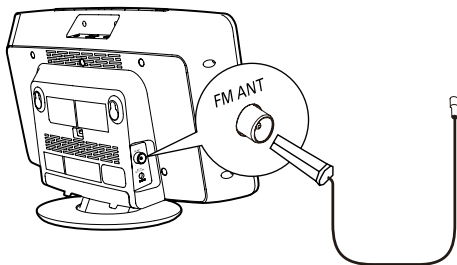

Prepare the remote control

- 1 Open the battery compartment.
- 2 Insert 2 AAA batteries with correct polarity (+/-) as indicated.
- 3 Close the battery compartment.

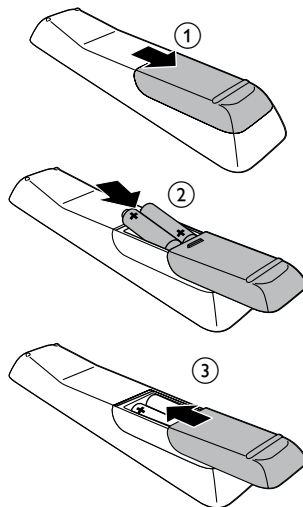

Connect power

! Caution

- Risk of product damage! Make sure that the power supply voltage corresponds to the voltage printed on the back of the system.
- Risk of electric shock! When you unplug the AC power adapter, always pull the plug from the socket. Never pull the cord.
- Before connecting the AC adapter, make sure that you have completed all other connections.

≡ Note

- The type plate is located on the back of the system.

Connect the power adapter to:

- the **DC IN** socket on the system.
- the wall power socket.

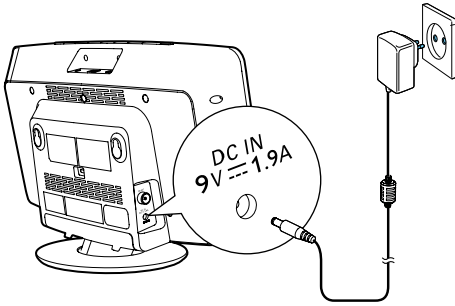

Turn on

Press **⏻**.

- ↳ The system switches to the last selected source.

Tip

- To select another source, press **SOURCE** repeatedly or the source selection buttons on the remote control.

Switch to standby mode

Press **⏻** to switch the system to standby mode.

- ↳ The clock (if set) appears on the display panel.
- ↳ The display backlight becomes dim.

Note

- In CD, USB, or Bluetooth mode, if the system stays inactive for 15 minutes, it switches to standby mode automatically.
- In MP3 link mode, if music is stopped or paused for 15 minutes and the MP3 link cable is not plugged, the system switches to standby mode automatically.

Set clock

- 1 In standby mode, press and hold **CLOCK SET** on the remote control for two seconds.
↳ **[SET CLOCK]** (set clock) scrolls on the display, then the 12/24 hour format blinks.
- 2 Press **⏪** / **⏩** repeatedly to select an hour format.
- 3 Press **CLOCK SET** to confirm.
↳ The hour digits blink.
- 4 Repeat steps 2-3 to set the hour.
- 5 Repeat steps 2-3 to set the minute.
- 6 Repeat steps 2-3 to select whether to synchronize time with RDS stations.
 - **[RDS TIME SYNC [Y]]**: synchronize time with RDS stations automatically.
 - **[RDS TIME SYNC [N]]**: deactivate time synchronization.

Note

- The accuracy of the transmitted time depends on the RDS station that transmits the time signal.
- If the system is idle for 90 seconds, it exits clock setting mode automatically.



Store FM radio stations automatically

When you connect AC power and no FM stations are stored, the system prompts you to search and store all the available FM stations.

- 1 Connect the system to the power supply.
↳ **[AUTO INSTALL - PRESS PLAY, STOP CANCEL]** (to auto install, press **▶||**; to cancel, press **■**) is displayed.

- 2 Press and hold ►|| for 3 seconds to start full scan.
 - ↳ The system automatically stores FM radio stations with sufficient signal strength.
 - ↳ The first preset station is broadcast automatically.

Tip

- To exit storing mode, press  or .

4 Play

Play disc

- 1 Press  to open the disc tray.
- 2 Insert a disc with the printed side facing up.

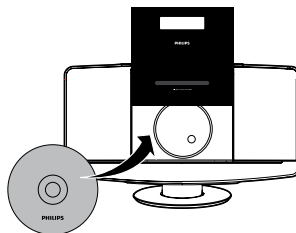

- 3 Press  to close the disc tray.
- 4 Press **CD** on the remote control to select the disc source.
 - ↳ **[Reading]** (reading) blinks for a moment, then CD starts playing automatically. If not, press ►||.

Play from a USB storage device

Note

- Make sure that the USB device contains playable audio content.

- 1 Insert the USB storage device into the  socket.

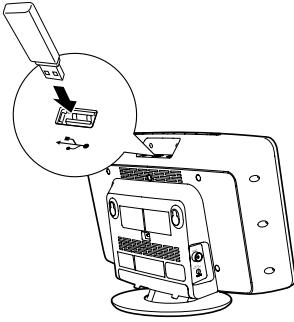

- 2 Press **USB** on the remote control to select the USB source.
 - ↳ Play starts automatically. If not, press **▶||**.

Play from Bluetooth-enabled devices

Note

- The effective operating range between the system and the paired device is approximately 10 meters (30 feet).
- Any obstacle between the system and the device can reduce the operational range.
- Compatibility with all Bluetooth devices is not guaranteed.

- 1 Press **0** to select Bluetooth source.
 - ↳ **[BT]** (Bluetooth) is displayed.
 - ↳ The Bluetooth indicator flashes blue.
- 2 On your Bluetooth device, enable Bluetooth and search for Bluetooth devices that can be paired (refer to the user manual of the device).
- 3 When **[BTM2056]** is displayed on your device, select it to start pairing and connection.
 - ↳ After successful pairing and connection, the Bluetooth indicator turns solid blue, and the system beeps twice.

- 4 Play audio on your device.
 - ↳ Audio streams from your device to this micro system.

Tip

- The system can memorize up to 5 previously connected Bluetooth devices.

To disconnect the Bluetooth-enabled device:

- Deactivate Bluetooth on your device; or
- Move the device beyond the communication range.

To clear Bluetooth pairing history:

Press and hold **■** for 3 seconds.

- ↳ The current Bluetooth connection is disconnected.
- ↳ After successful clearing, **[CLEAR]** (clear) is displayed for 3 seconds.

Play options

Control play

In CD or USB mode:

◀◀ / ▶▶	Select an audio file; Press and hold to fast reverse the track during playback, then release to resume play.
▲ / ▼	For MP3/WMA tracks, select an album or folder.
▶ 	Start or pause play.
■	Stop play.
OK	Confirm a selection.
Numeric buttons	Select a track directly.

REPEAT/SHUFFLE	<p>[]: Play the current track repeatedly.</p> <p>[] (for MP3/WMA only): play all tracks in this album repeatedly.</p> <p>[]: play all tracks repeatedly.</p> <p>[]: play all tracks randomly.</p> <p>To return to normal play, press REPEAT/SHUFFLE repeatedly until the repeat or shuffle icons disappear.</p>
-----------------------	---







DBB	Turn dynamic bass enhancement on or off.
DSC	Select a sound effect: [POP] (pop) [JAZZ] (jazz) [ROCK] (rock) [CLASSIC] (classic) [FLAT] (flat)

Display different information

During play, press **DISPLAY** repeatedly to view time and different play information.

Program tracks

You can program a maximum of 20 tracks.

- 1 In CD or USB mode, press  to stop playback.
- 2 Press **PROG** to activate the programming mode.
↳ [PROG] (program) is displayed.
- 3 For MP3/WMA tracks, press  /  repeatedly to select an album.
- 4 Press  /  repeatedly to select a track, then press **PROG** to confirm.
- 5 Repeat steps 3-4 to program more tracks.
- 6 To play the programmed tracks, press .
↳ During play, [PROG] (program) is displayed.
 - To erase the program, press  twice.

Adjust sound

During play, you can adjust volume and select different sound effects.

Key	Function
VOL +/-	Increase or decrease volume.
	Mute or resume sound.

5 Listen to FM radio

Tune to FM radio stations

Note

- Position the antenna as far as possible from TV,VCR, or other radiation source.
- Make sure that you have connected and fully extended the supplied FM antenna.

- 1 Press **FM** to select FM tuner mode.
- 2 Press and hold **◀◀ / ▶▶** for 3 seconds.
↳ **[SEARCH]** (search) is displayed.
↳ The system tunes to an FM station with strong reception automatically.
- 3 Repeat step 2 to tune to more stations.

To tune to a station with weak signal:

Press **◀◀ / ▶▶** repeatedly until you find good reception.

Program FM radio stations automatically

Note

- You can program a maximum of 20 preset FM radio stations.

In FM tuner mode, press and hold **PROG** for 3 seconds.

- ↳ **[AUTO]** (auto) is displayed.
- ↳ The system stores all the FM radio stations automatically, and then broadcasts the first preset radio station.

Program FM radio stations manually

- 1 In tuner mode, tune to an FM radio station.
- 2 Press **PROG** to activate programming mode.
↳ **[PROG]** (program) blinks.
- 3 Press **▲** or **▼** repeatedly to select a channel number.
- 4 Press **PROG** again to confirm.
- 5 Repeat steps 1-4 to store other FM stations.

Note

- To remove a pre-stored station, store another station in its place.

Select a preset radio station

In tuner mode, press **▲ / ▼** or the numeric buttons to select a preset number.

Show RDS information

RDS (Radio Data System) is a service that allows FM stations to show additional information. If you tune to an RDS station, an RDS icon is displayed.

- 1 Tune to an RDS station.
- 2 Press **RDS** repeatedly to scroll through the following information (if available):
 - ↳ Program service
 - ↳ Program type such as **[NEWS]** (news), **[SPORT]** (sport), **[POP M]** (pop music)...
 - ↳ Radio text message
 - ↳ Time

Select stereo/mono broadcast

Note

- Stereo broadcast is the default setting for tuner mode.
- For stations with weak signals: to improve the reception, change to monaural sound.

In FM tuner mode, press **▶||** to switch between mono and stereo broadcast.

6 Other features

Set the alarm timer

This system can be used as an alarm timer. You can select CD, FM tuner, or USB as alarm source.

Note

- Make sure that you have set the clock correctly.

- 1 In standby mode, press and hold **TIMER** until **[SET TIMER]** (set timer) scrolls on the display.
↳ **[SELECT SOURCE]** (select source) is displayed.
- 2 Press **SOURCE** repeatedly or the source selection buttons on the remote control to select a source: disc, FM tuner, or USB.
- 3 Press **TIMER** to confirm.
↳ The hour digits blink.
- 4 Press **◀◀** or **▶▶** to set the hour.
- 5 Press **TIMER** to confirm.
↳ The minute digits blink.
- 6 Repeat steps 4-5 to set the minute and alarm volume.

Tip

- If the system is idle for 90 seconds, it exits alarm setting mode automatically.

To activate or deactivate the alarm timer:

In standby mode, press **TIMER** repeatedly to activate or deactivate the alarm.

↳  appears when the alarm timer is activated.

Tip

- If CD or USB is selected as alarm source, yet there is no disc inserted or no USB connected, the system switches to the tuner source automatically.

Set the sleep timer

Note

- Make sure that you have set the clock correctly.

When the system is turned on, press **SLEEP** repeatedly to select the sleep timer period (in minutes).

↳ If the sleep timer is activated, **zZ** is displayed.

To deactivate the sleep timer:

Press **SLEEP** repeatedly until **[OFF]** (off) is displayed.

Play from an external device

You can also listen to an external audio device through this system.

- 1 Connect the audio cable (not supplied) to:
 - the **MP3 LINK** socket (3.5mm) on the system.
 - the headphone socket on an external device.

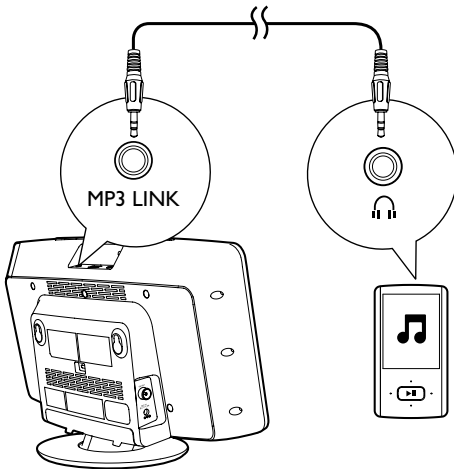

- 2 Press **MP3 LINK** to select the MP3 link source.

- 3 Play the external audio device (see the user manual of the device).

Listen through the headphone

Plug a headphone into the  socket on the system.

7 Product information

Note

- Product information is subject to change without prior notice.

Specifications

Amplifier

Maximum Output Power	15 W
Frequency Response	63 -14000 Hz, -3 dB
Signal to Noise Ratio	> 57 dBA
Total Harmonic Distortion	<1%
MP3 Link Input	650 mV RMS

Disc

Disc Diameter	12 cm/8 cm
Support Disc	CD-DA, CD-R, CD-RW, MP3-CD, WMA-CD

Tuner (FM)

Tuning Range	87.5 - 108 MHz
Tuning Grid	50 KHz
Sensitivity	
- Mono, 26dB S/N Ratio	<22 dBf
- Stereo, 46dB S/N Ratio	>51.5 dBf
Total Harmonic Distortion	<3%
Signal to Noise Ratio	>50 dBA

Bluetooth

Standard	Bluetooth Standard Version 2.1+EDR
Frequency Band	2.402~2.480 GHzISM Band
Range	10m (free space)

General information

AC Power	Model: AS190-090-AE190; Input: 100 - 240V ~, 50/60 Hz, 0.7 A; Output: 9V = 1.9 A
Operation Power Consumption	15 W
Standby Power Consumption	< 0.5 W
Dimensions - Main Unit (W x H x D)	400 x 235 x 98 mm
Weight - Main Unit	2.2 kg

USB playability information

Compatible USB devices:

- USB flash memory (USB1.1)
- USB flash players (USB1.1)
- memory cards (requires an additional card reader to work with this unit)

Supported formats:

- USB or memory file format: FAT12, FAT16, FAT32 (sector size: 512 bytes)
- MP3 bit rate (data rate): 32-320 Kbps and variable bit rate
- WMA v9 or earlier
- Directory nesting up to a maximum of 8 levels
- Number of albums/ folders: maximum 99
- Number of tracks/titles: maximum 999
- ID3 tag v2.0 or later
- File name in Unicode UTF8 (maximum length: 16 bytes)

Unsupported formats:

- Empty albums: an empty album is an album that does not contain MP3/WMA files, and is not be shown in the display.
- Unsupported file formats are skipped. For example, Word documents (.doc) or MP3 files with extension .dlf are ignored and not played.
- AAC, WAV, PCM audio files
- DRM protected WMA files (.wav, .m4a, .m4p, .mp4, .aac)
- WMA files in Lossless format

Supported MP3 disc formats

- ISO9660, Joliet
- Maximum title number: 999 (depending on file name length)
- Maximum album number: 99
- Supported sampling frequencies: 32 kHz, 44.1 kHz, 48 kHz
- Supported Bit-rates: 32~320 (kbps), variable bit rates

OTHER M	Special music programs
WEATHER	Weather
FINANCE	Finance
CHILDREN	Children's programs
SOCIAL	Social Affairs
RELIGION	Religion
PHONE IN	Phone In
TRAVEL	Travel
LEISURE	Leisure
JAZZ	Jazz Music
COUNTRY	Country Music
NATION M	National Music
OLDIES	Oldies Music
FOLK M	Folk Music
DOCUMENT	Documentary
TES	Alarm Test
ALARM	Alarm

RDS program types

NO TYPE	No RDS programme type
NEWS	News services
AFFAIRS	Politics and current affairs
INFO	Special information programs
SPORT	Sports
EDUCATE	Education and advanced training
DRAMA	Radio plays and literature
CULTURE	Culture, religion and society
SCIENCE	Science
VARIED	Entertainment programs
POP M	Pop music
ROCK M	Rock music
MOR M	Light music
LIGHT M	Light classical music
CLASSICS	Classical music

8 Troubleshooting



Warning

- Never remove the casing of this device.

To keep the warranty valid, never try to repair the system yourself.

If you encounter problems when using this device, check the following points before requesting service. If the problem remains unsolved, go to the Philips Web page (www.philips.com/support). When you contact Philips, make sure that the device is nearby and the model number and serial number are available.

No power

- Make sure that the AC power plug of the unit is connected properly.
- Make sure that there is power at the AC outlet.
- To save power, the system switches off automatically 15 minutes after track play reaches the end and no control is operated.

No sound or poor sound

- Adjust the volume.
- Disconnect the headphones.

No response from the unit

- Disconnect and reconnect the AC power plug, then turn on the unit again.
- As a power-saving feature, the system switches off automatically 15 minutes after track play reaches the end and no control is operated.

Remote control does not work

- Before you press any button, first select the correct source with the remote control instead of the main unit.
- Reduce the distance between the remote control and the system.
- Insert the battery with its polarities (+/- signs) aligned as indicated.

- Replace the battery.
- Aim the remote control directly at the sensor on the front of the system.

No disc detected

- Insert a disc.
- Check if the disc is inserted upside down.
- Wait until the moisture condensation at the lens has cleared.
- Replace or clean the disc.
- Use a finalized CD or correct format disc.

Cannot display some files in USB device

- The number of folders or files in the USB device has exceeded a certain limit. This phenomenon is not a malfunction.
- The formats of these files are not supported.

USB device not supported

- The USB device is incompatible with the unit. Try another one.

Poor radio reception

- Increase the distance between the unit and your TV or VCR.
- Fully extend the FM antenna.

Timer does not work

- Set the clock correctly.
- Switch on the timer.

Clock/timer setting erased

- Power has been interrupted or the power cord has been disconnected.
- Reset the clock/timer.

About Bluetooth device

The audio quality is poor after connection with a Bluetooth-enabled device.

- The Bluetooth reception is poor: Move the device closer to the micro system or remove any obstacle between the device and the system.

Cannot connect with the device.

- The Bluetooth function of the device is not enabled. Refer to the user manual of the device for how to enable the function.
- The system is already connected with another Bluetooth-enabled device. Disconnect that device and then try again.
- You have cleared the pairing history in the micro system. On your iPhone, iPad, or other smart phones, first select **[forget this device]** (the exact word may vary on different devices), then press **[BTM2056]** on your Bluetooth menu to reconnect with the device.

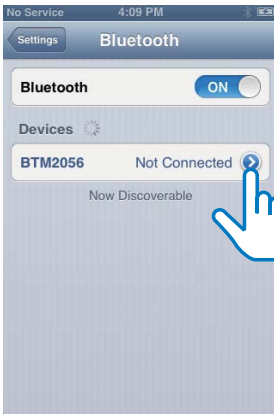

The paired device connects and disconnects constantly.

- The Bluetooth reception is poor. Move the device closer to the system or remove any obstacle between the device and the system.
- For some devices, the Bluetooth connection may be deactivated automatically as a power-saving feature. This does not indicate any malfunction of the system.

9 Notice

Any changes or modifications made to this device that are not expressly approved by WOOX Innovations may void the user's authority to operate the equipment.

CE 0890

This product complies with the radio interference requirements of the European Community.

A copy of the EC declaration of Conformity is available in the Portable Document Format (PDF) version of the user manual at www.philips.com/support.



Your product is designed and manufactured with high quality materials and components, which can be recycled and reused.



When this crossed-out wheeled bin symbol is attached to a product it means that the product is covered by the European Directive 2002/96/EC. Please inform yourself about the local separate collection system for electrical and electronic products.

Please act according to your local rules and do not dispose of your old products with your normal household waste. Correct disposal of your old product helps to prevent potential negative consequences for the environment and human health.



Your product contains batteries covered by the European Directive 2006/66/EC, which

cannot be disposed with normal household waste. Please inform yourself about the local rules on separate collection of batteries because correct disposal helps to prevent negative consequences for the environmental and human health.

Environmental information

All unnecessary packaging has been omitted. We have tried to make the packaging easy to separate into three materials: cardboard (box), polystyrene foam (buffer) and polyethylene (bags, protective foam sheet.)

Your system consists of materials which can be recycled and reused if disassembled by a specialized company. Please observe the local regulations regarding the disposal of packaging materials, exhausted batteries and old equipment.

This apparatus includes this label:



This is CLASS II apparatus with double insulation, and no protective earth provided.

The Bluetooth® word mark and logos are registered trademarks owned by Bluetooth SIG, Inc. and any use of such marks by Philips is under license.



The making of unauthorized copies of copy-protected material, including computer programs, files, broadcasts and sound recordings, may be an infringement of copyrights and constitute a criminal offence. This equipment should not be used for such purposes.



Specifications are subject to change without notice.
2014 © WOOX Innovations Limited. All rights reserved.
Philips and the Philips' Shield Emblem are registered
trademarks of Koninklijke Philips N.V. and are used by WOOX
Innovations Limited under license from Koninklijke Philips N.V.

BTM2056_12_UM_V2.0

