



# U6200A

## 6 GHz Universal Counter



&

# U6220A

## 400 MHz Frequency Counter



# Table of Contents

<b>1 GENERAL INFORMATION.....</b>	<b>5</b>
1.1 FEATURE OVERVIEW.....	5
1.2 WARRANTY INFORMATION.....	6
1.3 PRECAUTION OF OPERATION.....	7
1.4 UPKEEP OF THE U6200A/220A.....	8
1.5 SAFETY INFORMATION.....	8
1.6 SYMBOLS AND TERMS.....	9
1.7 INSPECTION.....	10
1.8 OPTIONS AND ACCESSORIES.....	10
1.9 U6200A/220A FUNCTION SUPPORT LIST.....	11
<b>2 OVERVIEW.....</b>	<b>12</b>
2.1 SETTING UP YOUR U6200A/220A.....	12
2.1.1 To adjust the handle.....	12
2.2 GETTING STARTED WITH THE U6200A/220A.....	14
2.2.1 The Front Panel.....	14
2.2.2 The Rear Panel.....	16
<b>3 MAKING MEASUREMENTS.....</b>	<b>17</b>
3.1 FREQUENCY MEASUREMENT.....	17
3.2 FREQUENCY RATIO MEASUREMENT.....	18
3.3 TIME INTERVAL MEASUREMENT.....	19
3.4 PERIOD MEASUREMENT.....	21
3.5 RISE/FALL TIME MEASUREMENT.....	22
3.6 PULSE WIDTH MEASUREMENT.....	23
3.7 DUTY CYCLE MEASUREMENT.....	25
3.8 TOTALIZE MEASUREMENTS.....	26
3.9 PHASE MEASUREMENTS.....	27
3.10 VOLTAGE PEAK MEASUREMENT.....	28
<b>4 FRONT PANEL OPERATIONS.....</b>	<b>31</b>
4.1 MEASUREMENT RESULT AND STATUS DISPLAY.....	31
4.2 KEY FUNCTIONS.....	32
4.2.1 Numeric Keypad and the Arrow Keys.....	32
4.2.2 Measurement Control Keys (Run and Stop/Single).....	33

4.3 GATE & EXTERNAL ARM OPERATIONS.....	34
4.4 SETTING SCALE AND OFFSET .....	42
4.5 LIMITS OPERATIONS .....	44
4.6 STATISTICS OPERATIONS .....	46
4.7 SETTING CHANNEL INPUT CONDITIONS .....	48
4.8 TRIGGER SETTING .....	48
4.9 SAVE AND RECALL FUNCTIONS .....	53
4.10 UTILITY OPERATIONS .....	55
4.11 DISPLAY TIPS .....	58
4.11.1 View Remote Command Error.....	58
4.11.3 Power up Default State Resetting.....	59
4.11.4 Synchronize Multiple Instruments.....	59
<b>5 REMOTE INTERFACE OPERATIONS.....</b>	<b>61</b>
5.1 PASS/FAIL OUTPUT VIA USB CONNECTOR.....	61
5.2 SETTING UP FOR REMOTE ACCESS .....	62
5.3 REMOTE INTERFACE COMMANDS.....	65
<b>6 MANUAL CALIBRATION PROCEDURES .....</b>	<b>77</b>
6.1 HOW TO DO THE OFFSET CALIBRATION VIA CH1 .....	77
6.2 HOW TO DO THE OFFSET CALIBRATION VIA CH2 .....	77
6.3 HOW TO DO THE ATT X 10 OFFSET CALIBRATION VIA CH1 .....	78
6.4 HOW TO DO THE ATT X 10 OFFSET CALIBRATION VIA CH2 .....	78
6.5 HOW TO DO THE GAIN CALIBRATION VIA CH1 .....	79
6.6 HOW TO DO THE GAIN CALIBRATION VIA CH2 .....	79
6.7 HOW TO DO THE ATT X 10 GAIN CALIBRATION VIA CH1.....	80
6.8 HOW TO DO THE ATT X 10 GAIN CALIBRATION VIA CH2.....	80
6.9 HOW TO DO THE TIME DOMAIN CALIBRATION (INCLUDING EXTERNAL ARM).....	81
6.10 HOW TO DO THE TIME INTERVAL CALIBRATION .....	82
6.12 HOW TO DO THE STANDARD TIMEBASE CALIBRATION .....	83
<b>7 ERROR MESSAGES .....</b>	<b>85</b>
7.1 COMMAND ERRORS .....	85
7.2 EXECUTION ERRORS.....	88
7.3 DEVICE-SPECIFIC ERRORS .....	89
7.4 QUERY ERRORS .....	89
7.5 COUNTER-SPECIFIC ERRORS.....	90
<b>APPENDIX.....</b>	<b>91</b>

A. SPECIFICATION LIST.....	91
B. PRESET VALUES AND SAVE/RECALL INFORMATION.....	96
C. GENERAL SPECIFICATIONS .....	97
D. REMOTE INTERFACE REFERENCE .....	98
<i>D.1 Introduction to the SCPI Language.....</i>	<i>98</i>
<i>D.2 Command Reference.....</i>	<i>102</i>
<i>D.3 IEEE-488 Common Commands.....</i>	<i>154</i>
<i>D.4 IEEE-488 Compliance Information.....</i>	<i>160</i>
E. ABOUT APPLICATION PROGRAMS.....	167

# 1 General Information

---

This section contains general information about PICOTEST U6200A Universal Counter and U6220A Frequency Counter (abbr. U6200A/220A). The information includes:

- Feature Overview
- Warranty Information
- Precaution of Operation
- Upkeep of U6200A/220A
- Safety Information
- Symbols and Terms
- Inspection
- Options and Accessories

**You can contact Picotest Corp. via the following telephone number for warranty, service, or technical support information.**

**Telephone: (886) 7-815-7183**

**Website <http://www.picotest.com.tw>**

**Or contact Picotest for more help by email.**

**Email: [sales@picotest.com.tw](mailto:sales@picotest.com.tw) or [info@picotest.com.tw](mailto:info@picotest.com.tw)**

---

## 1.1 Feature Overview

U6200A/220A offer:

- DC 1mHz ~ 400 MHz frequency range for U6200A channel 1 & 2.
- **Standard Channel 3 provides 375MHz~6GHz frequency range.**
- 12 digits resolution with 1s gate time.
- 40 ps time domain function resolution.
- Connection via USB, Ethernet 10M/100M, and GPIB (optional).

- Multi-parameter display of results.
- Optional third channel that provides measurements up to 20 GHz for U6200A only.
- Easy-to-use shortcut keys.
- Easy & free PC applications.

※ Note: The U6220A doesn't provide the channel 2 & 3 (colored green).

※ Note: Full U6200A/220A specifications are included in Appendix A.

※ Note: Picotest provides users a free software U6200A/220A PT-LINK (Ver 1.0). This software's GUI (Graphic User Interface) tool can get results from measurements, and transform data to Microsoft Excel or Word for analysis or reworking.

---

## 1.2 Warranty Information

If the equipment is used in a manner not specified by the manufacturer, the protection provided by the equipment may be impaired.

1. **Warranty:** PICOTEST CORP. guarantees that this product meets its published specifications at the time of shipment from the factory. Under proper installation it should work as expected.
2. **Warranty Period:** This equipment is warranted against defects in material and workmanship for a period of one year from date of shipment. During the warranty period, PICOTEST is responsible for necessary repairs as long as the product can be proved to be defective.  
For warranty service or repair, this product must be returned to a service facility designated by PICOTEST. Please contact your local service representative.
3. **Excluded Items:** This warranty does not include consumptive parts such as fuses, buttons and relays. Neither does this warranty cover defects caused by improper installation, improper or insufficient maintenance, unauthorized modification, improper operation, ignorance of environmental specifications or improper software or interfacing.
4. **Remarks:**
  - No other warranty is expressed or implied, except for the above

mentioned.

- The remedies provided herein are the buyer's sole and exclusive remedies. PICOTEST shall not be liable for any direct, indirect, special, incidental or consequential damages.

## **Limitation of warranty**

- 1.** Our warranties do not cover any damage resulting from unauthorized modification or misuse.
- 2.** Unless mentioned elsewhere in this document, our warranty does not apply to fuses, probes, and problems arising from normal wear or user's failure to follow instructions.
- 3.** Our warranties do not apply on any direct, incidental, special, or consequential damages.
- 4.** The above warranties are exclusive and no other warranty is expressed or implied. Picotest disclaims any implied warranties of MERCHANTABILITY, SATISFACTORY QUALITY, and FITNESS for any particular reasons.

---

## **1.3 Precaution of Operation**

- Please carefully read the manual before operating this device.
- This manual is for reference only. Please consult your local service representative for further assistance.
- The contents of this manual may be amended by the manufacturer without notice.
- Never dismantle the equipment by any unauthorized personnel, or equipment may be damaged.
- The equipment has been strictly tested for quality before delivery from our factory. However, this equipment must not be used in dangerous situations where damage may result.
- This production should be placed in a safe area in case of unpredicted personnel use.
- The rear protective conduct terminal needs to be connected to the actual earth ground or electrical shock may occur.

- The patent and related documents for the equipment belong to PICOTEST CORP. Any part of reproduction is illegal.

---

## 1.4 Upkeep of the U6200A/220A

- Although the U6200A universal counter is very durable and weather resistant, care should be taken not to expose it to severe impact or pressure.
- Keep the U6200A/220A far from water and damp environment.
- Calibration will be taken every year. Please contact with your local service representative for more information.
- If the incorrect display or abnormal beeps occurred you should stop using the equipment at once.
- Do not use the Counter around explosive gas or inflammable vapor.
- Wipe the surface of the U6200A universal counter with a piece of dry and clean cloth.

---

## 1.5 Safety Information



Caution! Please read through the following safety information before using the product.

To avoid possible electrical shock or personal injury, please read and follow these guidelines carefully:

- Follow the guidelines in this manual and DO NOT use the Counter if the case is damaged. Check the instrument case and terminals, and make sure all the devices are in the proper positions.
- Do not apply excessive voltage to the Universal counter. Apply voltage within the rated range only.
- Use caution when measuring voltages above 30 V RMS, 42 V peak, or 60 V DC. These voltages pose an electric shock hazard.
- If you need to open the instrument case or replace any parts, read through this manual first. You must be the qualified personnel to perform this action.



- Do not try to operate the instrument if it is damaged. Disconnect the power from the equipment and consult the local service representative. Return the product to Picotest service department if it's necessary.

---

## 1.6 Symbols and Terms



This symbol indicates hazards that may cause damages to the instrument or even result in personal injury.



This symbol indicates high voltage may be present. Use extra caution before taking any action.



This symbol indicates the frame or chassis terminal presented need to be connected to the actual earth ground.



This symbol indicates "Protective Conductor Terminal".



Underwriters Laboratories®.



This symbol indicates earth (ground) terminal.



This symbol indicates this product complies with the essential requirements or the applicable European laws or directives with respect to safety, health, environment and consumer protections.

---

## 1.7 Inspection

The product package is supplied with the following items:

- One U6200A/220A [107 (H) x 224 (W) x 380 (D) mm, approx. 3.2 Kg]
- One power cord.
- One USB cable.
- One CD (including this electronic User's Manual and software applications).
- Optional accessories as you ordered for U6200A only.
- GPIB interface card. (Optional)

---

## 1.8 Options and Accessories

The following options and accessories are available from Picotest for use with the U6200A. Please refer to **Table 1-1**.

**Table 1-1 Accessories**

Part Name	Part Number
High stability oven oscillator	U6200-opt01
250MHz-20GHz Input Channel	U6200-opt02
Rear panel input module (CH1/CH2)	U6200-opt04
Rear panel input module (CH1/CH2/CH3)	U6200-opt05
GPIB Card	M3500-opt04

※ Note: The only one available accessory for U6220A is the GPIB Card.

## 1.9 U6200A/220A Function Support List

Function	Channel	U6200A	U6220A
FREQUENCY	1	V	V
FREQUENCY	2	V	
FREQUENCY	3	V	
PERIOD	1	V	V
PERIOD	2	V	
PERIOD	3	V	
RATIO	1,2	V	
RATIO	2,1	V	
RATIO	1,3	V	
RATIO	3,1	V	
RISE TIME		V	
FALL TIME		V	
POS WIDTH		V	
NEG WIDTH		V	
TIME INTERVAL		V	
PHASE		V	
DUTY		V	
Totalize		V	V
VOLT_PTP	1	V	V
VOLT_PTP	2	V	
VOLT_MAX	1	V	V
VOLT_MAX	2	V	
VOLT_MIN	1	V	V
VOLT_MIN	2	V	
VOLT_CENT	1	V	V
VOLT_CENT	2	V	

※ Note: The unsupported functions, instructions and commands regarding the U6220A in the following will be colored green.

# 2 Overview

---

This chapter will give you an overview of the U6200A/220A's basic features and guide you through the basics of the U6200A/220A. Users will be familiar with those features after reading this chapter.

---

## 2.1 Setting up Your U6200A/220A

This section guides users to use the U6200A/220A. Users might want to check if they have all the parts with their counters. All our products are handled and inspected professionally before shipping out to customers. If any damaged or missing parts are found or any questions are from using the unit, please contact your local service representative immediately and do not attempt to operate the damaged product.

### 2.1.1 To adjust the handle

You may adjust the carrying handle for your purpose. The following figures show you how to do it.

#### **I. Taking off the handle from the Universal Counter**

**【Step 1】** (Turn up the handle)

Pull slightly outward on both sides of the handle and slowly rotate it up as shown in **Figure 2-1**.

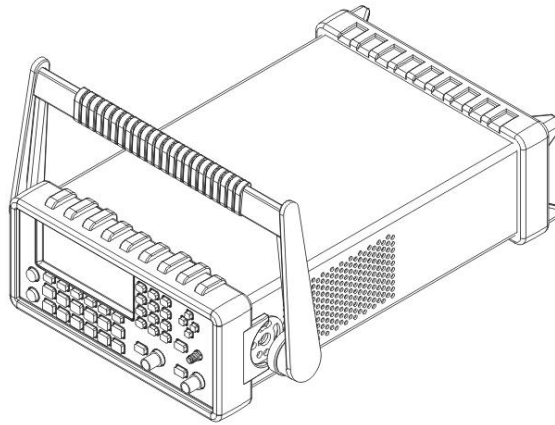

**Figure 2-1**

**【Step 2】** (Pull out the handle)

When the handle is turned up to 90° with the universal counter, please pull out the handle from the universal counter as shown in **Figure 2-2**.

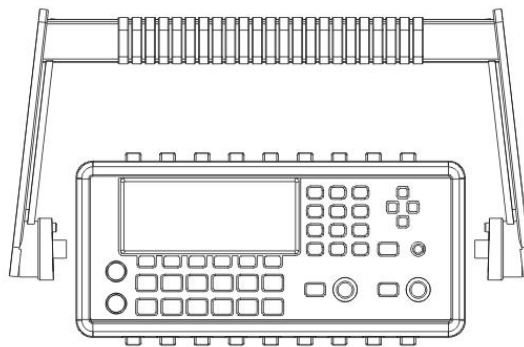

**Figure 2-2**

## **II. Adjusting the position for your convenience**

There are some example positions to suit users' needs.

**【Position 1】**

The default position is for packing as shown in **Figure 2-3**.

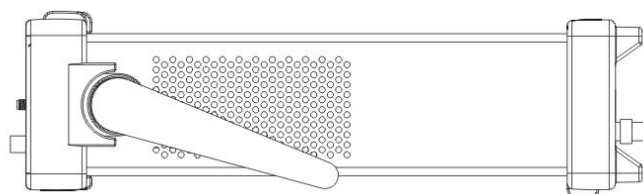

**Figure 2-3**

**【Position 2】**

The adjusted position is for operation as shown in **Figure 2-4**.

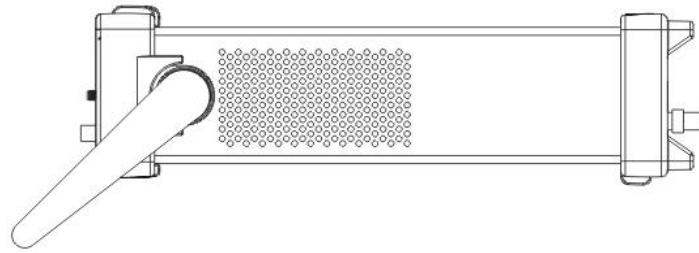

**Figure 2-4**

**【Position 3】**

The carrying position shows in **Figure 2-5**.

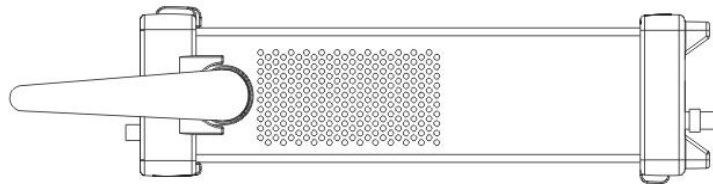

**Figure 2-5**

---

## 2.2 Getting Started with the U6200A/220A

The brief descriptions are mentioned in this chapter, such as connectors and buttons on the U6200A/220A's front and rear panels.

---

### 2.2.1 The Front Panel

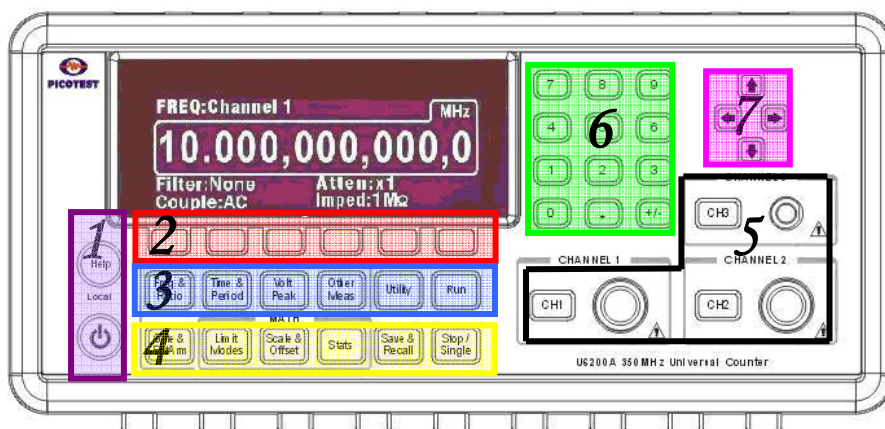

**Figure 2-6**

### **1. Power & Display (in the purple area):**

- Power: Turn on/off the U6200A/220A.
- Help: Instruction for the function you located.

### **2. First row softkeys: (in the red area):**

They provide access to the menu shows on the U6200A/220A's display.

### **3. Second row (in the blue area):**

- Freq & Ratio: Frequency and frequency ratio measurement functional menu key.
- Time & Period: Time interval and period measurement functional menu key.
- Volt Peak: Voltage peak measurement function menu key.
- Other Meas: Phase, duty cycle and totalize measurement menu key.
- Utility: Utility configuration menu key.
- Run: Key to start continuous measurement.

※ Note: The U6220A doesn't support "Time Domain" function.

### **4. Third row (in the yellow area):**

- Gate & ExtArm: Gate and External Arm menu key.
- Limit Modes: Limit setting and testing menu key.
- Scale & Offset: Scale and offset input key.
- Stats: Statistics function menu key.
- Save & Recall: Measurement setting save and recall menu key.
- Stop/Single: Key to make single measurement or stop continuous measurement after current measurement is finished.

### **5. Channel condition buttons and connectors (in the black area):**

- CH1: Channel 1 condition control key and connector.
- CH2: Channel 2 condition control key and connector.
- CH3: Channel 3 condition control key and connector.

※ Note: The U6220A doesn't provide the channel 2 & 3.

**6. Twelve numeric keys (in the green area):**

Numerical value input keys.

**7. Four arrow keys (in the pink area):** Keys to control cursor in order to increase or decrease numerical value and provide entry of alphabetical letters.

※Note: Among all the buttons and keys on the front panel, those in item 3 and 4 will light up to indicate its function in effect.

---

## 2.2.2 The Rear Panel

The rear panel of the U6200A/220A is shown in **Figure 2-7**.

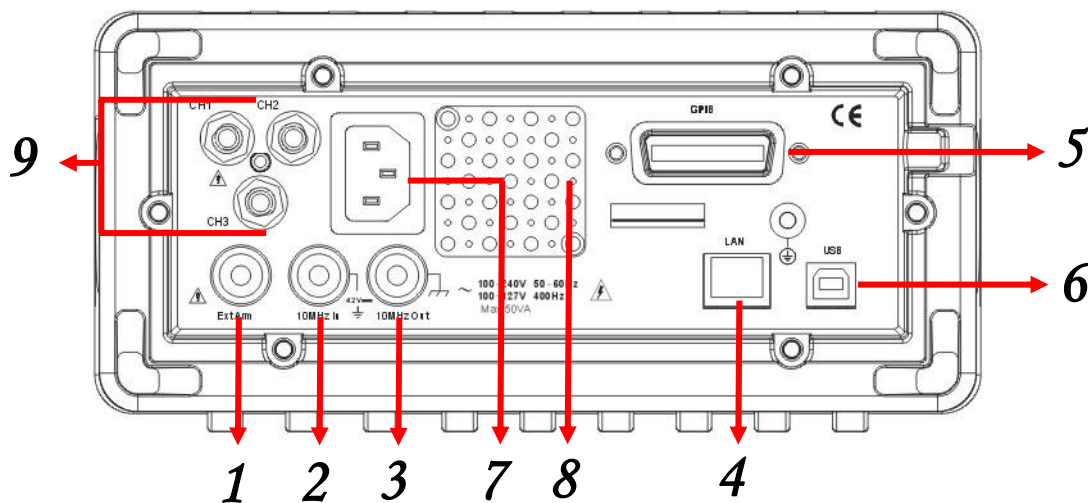

**Figure 2-7**

1. External Arm Input Terminal
2. External 10 MHz Input Terminal
3. External 10 MHz Output Terminal
4. LAN Interface Connector
5. GPIB Interface Connector
6. USB Interface Connector
7. Power cord connector
8. Fan
9. CH1/2/3 rear input

※ Note: The U6220A doesn't provide the rear input CH1/CH2/CH3.



# 3 Making Measurements

---

This chapter guides users how to make some basic measurement via the U6200A/220A, and to get to know the relative default parameters.

---

## 3.1 Frequency Measurement

Auto triggering is enabled by default for frequency measurement, and the trigger levels are set to the 50% points of the signal. One may manually disable the auto triggering function and change the trigger levels and slopes settings (refer to Ch.4.8).

### To measure frequency

1. Connect your signal source to the input channel you wish to use.
2. Press **FREQ & RATIO** button.
3. Press the softkey **FREQ** to select frequency measurement function. Press it again to select the desired channel.
4. Optional settings:
  - a. Use **GATE&ExtArm** button to set the gate time, resolution or arming if needed (refer to Ch.4.3).
  - b. Use **Scale&Offset** button to set the scaling and offset parameters if it's needed (refer to Ch.4.4).
  - c. Use **Limit Modes** button to set the upper and lower limits if it's needed (refer to Ch.4.5).

※ **Note: The U6220A doesn't support the "Limit Out" function.**

- d. Use **Stats** button to set up the statistics function and limit filtering if it's needed (refer to Ch.4.6).
- e. Use the selections in the CH1 to set the input conditions and the trig Sens.
- f. Use **Show Status** button to check the conditions of Input, Volt, Stats and Limit.
- g. Use **Save&Recall** button to save your settings (i.e., changes made in

steps a-d) if it's needed (refer to Ch.4.9).

5. Press RUN button to start continuous measurements.
6. Press STOP/SINGLE button to make single measurement or to stop continuous measurements.

### Remote Interface Command

Use the following commands to instruct the U6200A for making frequency measurement:

```
[[:SENSe]:FUNction[:ON] "[[:XNOnE:]:FREQuency [1|2|3]"
```

Or

```
:CONFigure[:SCALar][:VOLTage]:FREQuency [(@1)|(@2)|(@3)]
```

```
:READ[[:SCALar][:VOLTage]:FREQuency]?
```

Or

```
:MEASure[:SCALar][:VOLTage]:FREQuency? [(@1)|(@2)|(@3)]
```

※ **Note:** The U6220A doesn't provide the channel 2 & 3.

---

## 3.2 Frequency Ratio Measurement

Auto triggering is enabled by default for frequency ratio measurement, and the trigger levels are set to the 50% points of each signal. One may manually disable auto triggering and change the trigger levels and slopes settings (refer to Ch.4.8).

### To measure frequency ratio

1. Connect your signal sources to the input channels you wish to use.
2. Press **FREQ & RATIO** button.
3. Press the softkey under **RATIO** to select frequency ratio measurement function. Press it again to select the desired channels.
4. Optional settings:
  - a. Use **GATE&ExtArm** button to set the gate time, resolution or arming if it's needed (refer to Ch.4.3).
  - b. Use **Scale&Offset** button to set the scaling and offset parameters if it's needed (refer to Ch.4.4).
  - c. Use **Limit Modes** button to set the upper and lower limits if it's

needed (refer to Ch.4.5).

※ Note: The U6220A doesn't support the "Limit Out" function.

- d. Use Stats button to set up the statistics function and limit filtering if it's needed (refer to Ch.4.6).
  - e. Use the selections in the CH1 & CH2 to set the input conditions and the trig Sens.
  - f. Use Show Status button to check the conditions of Input, Volt, Stats and Limit.
  - g. Use Save&Recall button to save your settings (i.e., changes made in steps a-d) if it's needed (refer to Ch.4.9).
5. Press RUN button to make continuous measurements.
  6. Press STOP/SINGLE button to make single measurement or to stop continuous measurements.

### Remote Interface Command

Use the following commands for making frequency ratio measurement:

```
[[:SENSe]:FUNCTION[:ON] "[:][XNONE:]FREQuency:RATio [1,2|2,1|3,1|1,3]"
```

Or

```
:CONFigure[:SCALar][:VOLTage]:FREQuency:RATio
```

```
[(@1),(@2)|(@2),(@1)|(@1),(@3)|(@3),(@1)]
```

```
:READ[:SCALar][:VOLTage]:FREQuency:RATio?
```

Or

```
:MEASure[:SCALar][:VOLTage]:FREQuency:RATio?
```

```
[(@1),(@2)|(@2),(@1)|(@1),(@3)|(@3),(@1)]
```

※ Note: The U6220A doesn't support the "Frequency Ratio" commands.

---

## 3.3 Time Interval Measurement

Interval 1 to 2 measures the length of the duration between a start event on channel 1 and a stop event on channel 2. Auto triggering is enabled by default for time interval measurement, and the trigger levels are set to the 50% points of each signal. One may manually disable auto triggering and change the trigger levels and slopes settings (refer to Ch.4.8).

### **To measure time interval**

1. Connect the signal sources to the channel 1 and 2 respectively.
2. Press TIME&PERIOD button.
3. Use the softkey under Intval 1 to 2 to select interval measurement function.
4. Optional settings:
  - a. Use GATE&ExtArm button to set the gate time, resolution or arming if it's needed (refer to Ch.4.3).
  - b. Use Scale&Offset button to set the scaling and offset parameters if it's needed (refer to Ch.4.4).
  - c. Use Limit Modes button set the upper and lower limits if it's needed (refer to Ch.4.5).
  - d. Use Stats button to set up the statistics function and limit filtering if it's needed (refer to Ch.4.6).
  - e. Use the selections in the CH1 & CH2 to set the input conditions and the trig Sens.
  - f. Use Show Status button to check the conditions of Input, Volt, Stats and Limit.
  - g. Use Save&Recall button to save your settings (i.e., changes made in steps a-d) if it's needed (refer to Ch.4.9).
5. Press RUN button to make continuous measurements.
6. Press STOP/SINGLE button to make single measurement or to stop continuous measurements.

The start and the stop events may be triggered from the same source connected to one of the two channels. Refer to Ch.4.8 for detailed operations.

### **Remote Interface Command**

Use the following commands for making time interval measurement:

```
[ :SENSe]:FUNctIon[:ON] "[ :][XNOnE:]TINteRval [1,2]"
```

Or

```
:CONFigure[:SCALar][:VOLtAge]:TINteRval [(@1),(@2)]
```

```
:READ[:SCALar][:VOLtAge]:TINteRval?
```

Or

```
:MEASure[:SCALar][:VOLtAge]:TINteRval? [(@1),(@2)]
```

※ Note: The U6220A doesn't support "Time Interval" measurement.

---

## 3.4 Period Measurement

Auto triggering is enabled by default for period measurement, and the trigger levels are set to the 50% points of each signal. One may manually disable auto triggering and change the trigger levels and slopes settings (refer to Ch.4.8).

### To measure period

1. Connect your signal source to channel 1.
2. Press TIME&PERIOD button.
3. Press the softkey under Period to select period measurement function.
4. Optional settings:
  - a. Use GATE&ExtArm button to set the gate time, resolution or arming if needed (refer to Ch.4.3).
  - b. Use Scale&Offset button to set the scaling and offset parameters if needed (refer to Ch.4.4).
  - c. Use Limit Modes button set the upper and lower limits if needed (refer to Ch.4.5).
  - d. Use Stats button to set up the statistics function and limit filtering if needed (refer to Ch.4.6).
  - e. Use the selections in the CH1 to set the input conditions and the trig Sens.
  - f. Use Show Status button to check the conditions of Input, Volt, Stats and Limit.
  - g. Use Save&Recall button to save your settings (i.e., changes made in steps a-d) if it's needed (refer to Ch.4.9).
5. Press RUN button to make continuous measurements.
6. Press STOP/SINGLE button to make single measurement or to stop continuous measurements.

### Remote Interface Command

Use the following commands for making period measurement:

```
[[:SENSe]:]FUNCTION[:ON] "[:][XNOnE:]PERiod [1|2|3]"
```

Or

:CONFigure[:SCALar][:VOLTage]:PERiod [(@1)|(@2)|(@3)]

:READ[:SCALar][:VOLTage]:PERiod?

Or

:MEASure[:SCALar][:VOLTage]:PERiod? [(@1)|(@2)|(@3)]

※ **Note:** The U6220A doesn't provide the channel 2 & 3.

---

## 3.5 Rise/Fall Time Measurement

Auto triggering is enabled by default for rise/fall time measurement, and it automatically identifies the 10% and 90% points of the signal and sets the trigger levels in accordance. One may manually disable the auto triggering and override the automatic settings (refer to Ch.4.8).

### To measure rise or fall time

1. Connect your signal source to channel 1.
2. Press TIME&PERIOD button.
3. Press the softkey under EDGE to select edge measurement function. Press it again to toggle between rise and fall times.
4. Optional settings:
  - a. Use GATE&ExtArm button to set the gate time, resolution or arming if it's needed (refer to Ch.4.3).
  - b. Use Scale&Offset button to set the scaling and offset parameters if it's needed (refer to Ch.4.4).
  - c. Use Limit Modes button set the upper and lower limits if it's needed (refer to Ch.4.5).
  - d. Use Stats button to set up the statistics function and limit filtering if it's needed (refer to Ch.4.6).
  - e. Use the selections in the CH1 to set the input conditions and the trig Sens.
  - f. Use Show Status button to check the conditions of Input, Volt, Stats and Limit.
  - g. Use Save&Recall button to save your settings (i.e., changes made in steps a-d) if it's needed (refer to Ch.4.9).
5. Press RUN button to make continuous measurements.

6. Press STOP/SINGLE button to make single measurement or to stop continuous measurements.

### Remote Interface Command

Use the following commands for making rise or fall time measurement:

```
[:SENSe]:FUNction[:ON] "[XNONE:]RISE:TIME [1]"
```

```
[:SENSe]:FUNction[:ON] "[XNONE:]RTIME [1]"
```

```
[:SENSe]:FUNction[:ON] "[XNONE:]FALL:TIME [1]"
```

```
[:SENSe]:FUNction[:ON] "[XNONE:]FTIME [1]"
```

Or

```
:CONFigure[:SCALar][:VOLTage]:RISE:TIME [(@1)]
```

```
:CONFigure[:SCALar][:VOLTage]:RTIME [(@1)]
```

```
:CONFigure[:SCALar][:VOLTage]:FALL:TIME [(@1)]
```

```
:CONFigure[:SCALar][:VOLTage]:FTIME [(@1)]
```

```
:READ[:SCALar][:VOLTage]:RISE:TIME?
```

```
:READ[:SCALar][:VOLTage]:RTIME?
```

```
:READ[:SCALar][:VOLTage]:FALL:TIME?
```

```
:READ[:SCALar][:VOLTage]:FTIME?
```

Or

```
:MEASure[:SCALar][:VOLTage]:RISE:TIME? [(@1)]
```

```
:MEASure[:SCALar][:VOLTage]:RTIME? [(@1)]
```

```
:MEASure[:SCALar][:VOLTage]:FALL:TIME? [(@1)]
```

```
:MEASure[:SCALar][:VOLTage]:FTIME? [(@1)]
```

※ Note: The U6220A doesn't support "Rise/Fall Time Measurement".

---

## 3.6 Pulse Width Measurement

Auto triggering is enabled by default for pulse width measurement, and the trigger levels are set to the 50% points of each signal. One may manually disable the auto triggering and change the trigger levels and slopes settings (refer to Ch.4.8).

### To measure pulse width

1. Connect your signal source to channel 1.
2. Press TIME&PERIOD button.

3. Press the softkey under WIDTH to select pulse width measurement function. Press it again to select positive width or negative width.
4. Optional settings:
  - a. Use softkey Period CH1/CH2, and GATE&ExtArm button to set the gate time, resolution or arming if it's needed (refer to Ch.4.3).
  - b. Use Scale&Offset button to set the scaling and offset parameters if it's needed (refer to Ch.4.4).
  - c. Use Limit Modes button to set the upper and lower limits if needed (refer to Ch.4.5).
  - d. Use Stats button to set up the statistics function and limit filtering if needed (refer to Ch.4.6).
  - e. Use the selections in the CH1 to set the input conditions and the trig Sens.
  - f. Use Show Status button to check the conditions of Input, Volt, Stats and Limit.
  - g. Use Save&Recall button to save your settings (i.e., changes made in steps a-d) if it's needed (refer to Ch.4.9).
5. Press RUN button to make continuous measurement.
6. Press STOP/SINGLE button to make single measurement or to stop continuous measurement.

### **Remote Interface Command**

Use the following commands for making pulse width measurement:

```
[ :SENSe]:FUNctIon[:ON] "[ :][XNONE:]PWIDth [1]"
```

```
[ :SENSe]:FUNctIon[:ON] "[ :][XNONE:]NWIDth [1]"
```

Or

```
:CONFigure[:SCALar][:VOLTage]:PWIDth [(@1)]
```

```
:CONFigure[:SCALar][:VOLTage]:NWIDth [(@1)]
```

```
:READ[:SCALar][:VOLTage]:PWIDth?
```

```
:READ[:SCALar][:VOLTage]:NWIDth?
```

Or

```
:MEASure[:SCALar][:VOLTage]:PWIDth? [(@1)]
```

```
:MEASure[:SCALar][:VOLTage]:NWIDth? [(@1)]
```

※ Note: The U6220A doesn't support "Pulse Width Measurement".



---

## 3.7 Duty Cycle Measurement

The Duty cycle is defined by the following formula, and with its results from 0 to 1:

$$\text{Duty Cycle} = (\text{Positive Pulse Width})/\text{Period}$$

The dutycycle mode is only available to apply on Channel 1. Moreover, auto triggering is enabled by default for duty cycle measurement, and the trigger levels are set to the 50% points of each signal. One may manually disable the auto triggering and change the trigger levels and slopes settings (refer to Ch.4.8).

### To measure Duty Cycle

1. Connect your signal source to channel 1.
2. Press OTHER MEAS button.
3. Use the first row softkey under DUTY CYC1 to select duty cycle measurement function.
4. Optional settings:
  - a. Use GATE&ExtArm button to set the auto or external gate time if it's needed (refer to Ch.4.3).
  - b. Use Scale&Offset button to set the scaling and offset parameters if it's needed (refer to Ch.4.4).
  - c. Use Limit Modes button set the OnFail, OUT\*, Upper and Lower limits if it's needed (refer to Ch.4.5).
  - d. Use Stats button to set up the statistics function and limit filtering if it's needed (refer to Ch.4.6).
  - e. Use the selections in the CH1 to set the input conditions and the trig Sens.
  - f. Use Show Status button to check the conditions of Input, Volt, Stats and Limit.
  - g. Use Save&Recall button to save your settings (i.e., changes made in steps a-d) if it's needed (refer to Ch.4.9).
5. Press RUN button to make continuous measurements.
6. Press STOP/SINGLE button to make single measurement or to stop continuous measurements.

## Remote Interface Command

Use the following commands for making duty cycle measurement:

```
[ :SENSe]:FUNction[:ON] "[ :][XNOnE:]DCYClE [1]"
```

```
[ :SENSe]:FUNction[:ON] "[ :][XNOnE:]PDUTyCyclE [1]"
```

Or

```
:CONFigure[:SCALar][:VOLTage]:DCYClE [(@1)]
```

```
:CONFigure[:SCALar][:VOLTage]:PDUTyCyclE [(@1)]
```

```
:READ[:SCALar][:VOLTage]:DCYClE?
```

```
:READ[:SCALar][:VOLTage]:PDUTyCyclE?
```

Or

```
:MEASure[:SCALar][:VOLTage]:DCYClE? [(@1)]
```

```
:MEASure[:SCALar][:VOLTage]:PDUTyCyclE? [(@1)]
```

※ **Note:** The U6220A doesn't support "Duty Cycle Measurement".

---

## 3.8 Totalize Measurements

Totalize measurement counts and displays the number of events triggered from the input signal. Only channel 1 is available for this measurement. Auto-triggering is automatically turned off on channel 1 as the signal may not be suitable at the beginning of the measurement. If GATE:AUTO is selected (refer to Ch.4.3), the Counter will continuously display the count of events. Otherwise, the counting stops at the time constrained by the Gating&Arming settings. Counting is reset to zero when totalize function is first invoked, when the RUN button is pressed, or when STOP/SINGLE button is pressed.

※ **Note:** The totalize measurement function can't be used under **Scale & Offset, Limit Modes and Stats.**

### To make totalize measurement

1. Connect your signal source to channel 1.
2. Press OTHER MEAS button.
3. Press the softkey under TOTAL CH 1 to select totalize measurement function.
4. Optional settings:

- a. Use GATE&ExtArm button to set the gate time or external arming if it's needed (refer to Ch.4.3).
  - b. Use the selections in the CH1 to set the input conditions and the trig Sens.
  - c. Use Show Status button to check the conditions of Input, Volt, Stats and Limit.
  - d. Use Save&Recall button to save the changes made in step a if it's needed (refer to Ch.4.9).
5. Press RUN or STOP/SINGLE button to start measurement.

### Remote Interface Command

Use the following commands for making Totalize measurements:

```
[ :SENSe]:FUNCTION[:ON] "[ :][XNONE:]TOTAlize [1]"
```

Or

```
:CONFigure[:SCALar][:VOLTage]:TOTAlize:CONTInuous [(@1)]
```

```
:CONFigure[:SCALar][:VOLTage]:TOTAlize:TIMed [(@1)]
```

```
:READ[:SCALar][:VOLTage]:TOTAlize:TIMed?
```

Or

```
:MEASure[:SCALar][:VOLTage]:TOTAlize:CONTInuous? [(@1)]
```

```
:MEASure[:SCALar][:VOLTage]:TOTAlize:TIMed? [(@1)]
```

---

## 3.9 Phase Measurements

Phase 1 to 2 measures the phase difference between signals on channel 1 and channel 2, and the phase difference is shown in degree. Moreover, auto triggering is enabled by default for time interval measurement, and the trigger levels are set to the 50% points of each signal. One may manually disable auto triggering and change the trigger levels and slopes settings (refer to Ch.4.8).

The Channel 2 here acts as the reference. One period on Channel 2 will be defined  $360^\circ$ . As the Channel 1 leads the Channel 2, the pulse result will be positive.

### To make phase measurement

1. Connect your signal sources to channel 1 and channel 2 respectively.

2. Press OTHER MEAS button.
3. Press the softkey under (PHAS 1 to 2) to select phase measurement function.
4. Optional settings:
  - a. Use softkey "Phase 1 to 2" and GATE&ExtArm button to set the auto or external ARM if it's needed (refer to Ch.4.3).
  - b. Use Scale&Offset button to set the scaling and offset parameters if it's needed (refer to Ch.4.4).
  - c. Use Limit Modes button to set the OnFail, OUT\*, Upper and Lower limits if it's needed (refer to Ch.4.5).
  - d. Use Stats button to set up the statistics function and limit filtering if it's needed (refer to Ch.4.6).
  - e. Use the selections in the CH1 & CH2 to set the input conditions and the trig Sens.
  - f. Use Show Status button to check the conditions of Input, Volt, Stats and Limit.
  - g. Use Save&Recall button to save your settings (i.e., changes made in steps a-d) if it's needed (refer to Ch.4.9).
5. Press RUN button to make continuous measurements.
6. Press STOP/SINGLE button to stop current measurement or to make single measurement.

### Remote Interface Command

Use the following commands for making phase measurement:

```
[[:SENSe]:FUNCTION[:ON] "[:][XNOnE:]PHASe [1,2]"
```

Or

```
:CONFigure[:SCALar][:VOLTage]:PHASe [(@1),(@2)]
```

```
:READ[:SCALar][:VOLTage]:PHASe?
```

Or

```
:MEASure[:SCALar][:VOLTage]:PHASe? [(@1),(@2)]
```

※ Note: The U6220A doesn't support "Pulse Width Measurement".

---

## 3.10 Voltage Peak Measurement

The U6200A can also measure positive or negative voltage peak of the

input signal. Note that the Counter measures the input signal after the signal is conditioned by the input settings (impedance, coupling, attenuation, and filter, refer to Ch.4.7). The measurement result is corrected for X10 attenuation. Also note that Gating&Arming, Limit and Math are not available for voltage peak measurements.

### **To measure positive or negative voltage peak**

1. Connect your signal source to channel 1 or 2.
2. Press VOLT PEAK button to select voltage peak measurement function.
3. Press the softkey under VOLT to select input channel.
4. Optional settings:
  - a. Press the softkey under MODE to select the operational mode as Fast or Slow.
  - b. Press the softkey under SHOW to select display of the result as Vmax (positive peak), Vmin (negative peak), Vc (average from positive and negative peak) or Vpp (peak-to-peak).
  - c. Use the selections in the CH1 or CH2 to set the input conditions and the trig Sens.
  - d. Use Show Status button to check the conditions of Input, Volt, Stats and Limit.
  - e. Use Save&Recall button to save your settings (i.e., changes made in steps a-d) if it's needed (refer to Ch.4.9).
5. Press RUN button to make continuous measurements.
6. Press STOP/SINGLE button to stop current measurement or to make single measurement.

※ **Note: The U6220A doesn't provide the channel 2.**

### **Remote Interface Command**

Use the following commands for making voltage peak measurement:

```
[[:SENSe]:FUNction[:ON] "[[:XNOnE]:]VOLtage:MAXimum [1|2]"
```

```
[[:SENSe]:FUNction[:ON] "[[:XNOnE]:]VOLtage:MINimum [1|2]"
```

```
[[:SENSe]:FUNction[:ON] "[[:XNOnE]:]VOLtage: PTPeak [1|2]"
```

```
[[:SENSe]:FUNction[:ON] "[[:XNOnE]:]VOLtage: CENTer [1|2]"
```

Or

```
:CONFigure[:SCALar][:VOLtage]: MAXimum [(@1)|(@2)]
```

```
:CONFigure[:SCALar][:VOLTage]: MINimum [(@1)|(@2)]  
:CONFigure[:SCALar][:VOLTage]:PTPeak [(@1)|(@2)]  
:CONFigure[:SCALar][:VOLTage]: CENTER [(@1)|(@2)]  
:READ[:SCALar][:VOLTage]:PTPeak?
```

Or

```
:MEASure[:SCALar][:VOLTage]:MAXimum? [(@1)|(@2)]  
:MEASure[:SCALar][:VOLTage]:MINimum? [(@1)|(@2)]  
:MEASure[:SCALar][:VOLTage]:PTPeak? [(@1)|(@2)]  
:MEASure[:SCALar][:VOLTage]:CENTER? [(@1)|(@2)]
```

※ Note: The U6220A doesn't provide the channel 2.

# 4 Front Panel Operations

---

This chapter will guide you through different ways of configuring measurement functions. It contains information about how to change the parameters and settings for your measurements and all the other front panel operations for system settings. Remote interface settings are described in Chapter 5.

---

## 4.1 Measurement Result and Status Display

The U6200A/220A provide display of measurement results along with the information on the **executive** channel. The following options are available for all the measurement functions except Voltage Peaks:

By U6200A's display at Time & Period function as an example, please press Show Status softkey to check the messages located in the right bottom corner of the display as shown in Figure 4-1. Then, press the same softkey under the items to toggle the next information, for example, the Input item will appear as shown in Figure 4-2.



Figure 4-1



Figure 4-2

- Input: display the parameters of the input channel(s) as shown in Figure 4-3.
- Stats: display statistics (mean, std,  $\Delta P-P$  and N) and the number of measurements taken in getting the statistics as shown in Figure 4-4.
- Limit: display the measurement results in graph mode as shown in Figure 4-6.
- Volt: display the maximum, minimum, Vc and Vpp voltages of the input signal as shown in Figure 4-5.



Figure 4-3



Figure 4-4

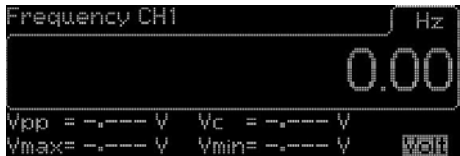

Figure 4-5

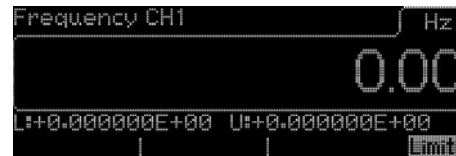

Figure 4-6

For Voltage Peaks function, the status will show the Input and Volt information.

Front panel operation:

1. Select your measurement function by pressing one of the measurement keys.
2. Press the softkey under STATUS.
3. Keep pressing the softkey to toggle between the options.
4. Continue with the procedure described in Chapter 3 for the measurement function of your choice.

---

## 4.2 Key Functions

The keys and buttons on the U6200A/220A lead users to their application purposes. Picotest provides two kinds of keys on the front panel. One is Numeric Keypad and Arrow Keys, and the other one is the measurement control keys.

---

### 4.2.1 Numeric Keypad and the Arrow Keys

There are 12 buttons on the numeric keypad plus four arrow keys, provided for numeric entry. To enter a numeric value, one may input the desired value directly on the numeric keypad or use the left/right arrow keys to move the cursor to the desired digit and the up/down arrow keys to increase or decrease the value. To finish the entry, press the softkey



under Done or under the desired unit/exponent to set the value. To cancel the changes, press the softkey under CANCEL.

---

## **4.2.2 Measurement Control Keys (Run and Stop/Single)**

There are two measurement modes in the U6200A/220A: Run and Single modes. Users can press the Run key to put the Counter in the Run mode while the Stop/Single key is in the Single mode.

### **Run mode operations**

- If the U6200A/220A are under one of the measurement modes, press the Run key to make the U6200A/220A enter the Run mode and start continuous measurements.
- If the U6200A/220A are under one of the measurement modes, press the Run key again to make the Counter abort the on-going measurement and (re-)enter the Run mode. This also clears any statistics being collected.
- If the U6200A/220A are under one of the measurement modes, press the Stop/Single key to make the Counter stop the measurement.
- If the U6200A/220A are under the Run mode, select another measurement function to make the Counter abort the on-going measurement.

### **Single mode operations**

- If the U6200A/220A are under one of the measurement modes, and on-going measurement is actuated, press the Stop/Single key to make the Counter enter the single mode and make single measurement or N measurements if STATS:SINGLE:N is selected and STATS:N CNT is set to N (refer to Ch.4.6). After the measurement is done, the Counter automatically exits the Single mode.
- If the U6200A/220A are under the Run mode, press the Stop/Single key to make the U6200A/220A enter the Single mode.
- If the U6200A/220A are under the Single mode, press the Stop/Single key to cause the Counter to abort the current

measurement.

### 4.3 Gate & External Arm operations

The U6200A/220A provide four arming modes: auto, time, digits and external. The descriptions are below the following table, giving the selection items under the functions, such as Freq/Period/Ratio, Phase (unavailable for U6220A), Totalize, Rise/Fall time (unavailable for U6220A) and Time Interval (unavailable for U6220A):

Freq,Period, Ratio	Phase	Totalize	Rise Time,Fall Time, +/-Width,Dutycycle	Time Interval
Auto Arming:  Gate: Auto	Auto Arming:  ARM: Auto	Auto Arming:  Gate: Auto	Auto Arming:  Gate: Auto	Auto Arming: *ARM: Auto Delay*: None Time Event Time*: <time> Event*: <events>
Digits Arming: Gate: Digits Digits: <digits>				
Time Arming: Gate: Time Time: <time>		Time Arming: Gate: Time Time: <time>		
External Arming: Gate: Ext Start: POS NEG Stop: Auto NEG POS Time Time: <time>	External Arming: ARM: Ext Slop: POS NEG	External Arming: Gate: Ext Start: POS NEG Stop: NEG POS Time Time: <time>	External Arming: Gate: Ext Slop: POS NEG	External Arming: *ARM: Ext *Slop: POS NEG *Delay: None Time Event *Time: <time> *Event: <events> Stop*: Auto Ext Slop*: POS NEG Delay* None Time Event Time*: <time> Event*: <events>

- **Auto Arming**

Under the Auto Arming mode as shown in the Figure 4-7 for the available measurement including frequency, period, frequency ratio, risetime, falltime, pulse width, dutycycle and phase, the counter takes measurements as fast as possible, except for totalize measurements. For totalize measurements, the counter starts to count whenever Run button or Stop/Single button is pressed.

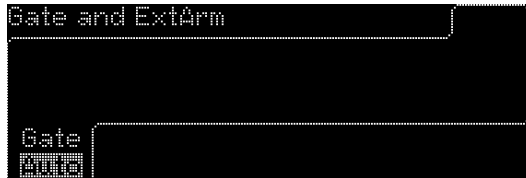

**Figure 4-7**

- **Time Arming**

Under the time arming mode as shown in the Figure 4-8 for the available measurement including frequency, period, ratio and totalize, users can set the length of time (gate time) for which the counter takes measurement.



**Figure 4-8**

- ※ Note1: The Gate Time Range on the frequency and the period is from 1E-3 to 1000 seconds.
- ※ Note2: The Gate Time Range on the Ratio is from 1E-3 to 200 seconds.

- **External Arming**

Under the External Arming mode as shown in the Figure 4-9 for the available measurement including period, frequency, ratio and totalize, a signal source must be connected to the Ext Arm connector on the rear panel. Start and end of measurement is then controlled by the external signal.

When the External Arming is toggled, two more items are available to set. One is Start (Neg/Pos), and the other one is Stop (Neg/Pos/Time/Auto)



**Figure 4-9**

- **Digits Arming**

Under the Digits Arming mode with the range from 3 to 15 as shown in the Figure 4-10 for the available measurement including frequency, period, and ratio, users can set the resolution they request.

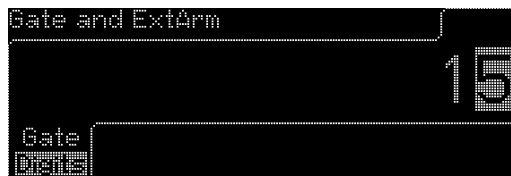

**Figure 4-10**

### **Gate and External Arm operations**

1. Press Stop/Single button to stop the Counter from taking continuous measuring.
2. Select your desired measurement function by pressing one of the measurement function keys and the corresponding softkey if it's needed (refer to Chapter 3).
3. Connect an external signal source to the Ext Arm connector on the rear panel if users want to apply the External Arming.
4. Press Gate&ExtArm button to further select from the menu.

### **For frequency, period and ratio measurements:**

Press the softkey under GATE to toggle from auto, time, digits and external.

- If Auto Arming is selected, the Counter will automatically start continuous measurement.
- If Digits Arming is selected, use the numeric keypad or the arrow keys to input a desired number of digits or resolution (refer to Ch.4.2.1).
- If Time Arming is selected, use the numeric keypad or the arrow keys to select a desired gate time (refer to Ch.4.2.1). The unit will show

on the top-right corner.

- If External Arming is selected, press the softkey under START to specify whether measurement should start at the positive or negative edge. Press the same key to toggle between positive and negative. Press the softkey under STOP to toggle between positive, negative, auto and time. This is to specify how measurement should stop. Positive and negative specifies the slope of the stop arm signal. Time is to set the duration of measurement. As time is selected, use the numeric keypad or the arrow keys to input a desired duration value (refer to Ch.4.2.1). The time unit will be shown on the top-right corner after the input is completed.

## Remote Interface Commands

### Auto arming:

```
[ :SENSe]:FREQuency:ARM[:START]:SOURce IMMEDIATE
```

```
[ :SENSe]:FREQuency:ARM:STOP:SOURce IMMEDIATE
```

### Digits arming:

```
[ :SENSe]:FREQuency:ARM[:START]:SOURce IMMEDIATE
```

```
[ :SENSe]:FREQuency:ARM:STOP:SOURce DIGITS
```

```
[ :SENSe]:FREQuency:ARM:STOP:DIGITS <numeric value>
```

### Time arming:

```
[ :SENSe]:FREQuency:ARM[:START]:SOURce IMMEDIATE
```

```
[ :SENSe]:FREQuency:ARM:STOP:SOURce TIMER
```

```
[ :SENSe]:FREQuency:ARM:STOP:TIMER <numeric value>
```

### External arming:

```
[ :SENSe]:FREQuency:ARM[:START]:SOURce EXTERNAL
```

```
[ :SENSe]:FREQuency:ARM[:START]:SLOPe POSitive|NEGative
```

```
[ :SENSe]:FREQuency:ARM:STOP:SOURce IMMEDIATE
```

```
[ :SENSe]:FREQuency:ARM:STOP:SOURce EXTERNAL
```

```
[ :SENSe]:FREQuency:ARM:STOP:SLOPe POSitive|NEGative
```

```
[ :SENSe]:FREQuency:ARM:STOP:SOURce TIMER
```

```
[ :SENSe]:FREQuency:ARM:STOP: TIMER <numeric value> [s]
```

※ Note: The U6220A doesn't support "Time interval, Rise/Fall Time, Duty Cycle and Width Measurement" color green.

### **For rise/fall time, duty cycle and width measurements:**

Press the Time & Period and Gate & ExtArm buttons, and then toggle between auto and external under the softkey Gate.

- If Auto Arming is selected, the Counter automatically starts continuous measurements.
- If External Arming is selected, press the softkey under SLOPE to toggle between Positive and Negative. This is to specify the slope of the external start arm signal.

### **Remote Interface Command**

#### **Auto arming:**

[[:SENSe]:TINTerval:ARM:ESTART:LAYer2:SOURce IMMEDIATE

#### **External arming:**

[[:SENSe]:TINTerval:ARM:ESTART:LAYer2:SOURce EXTERNAL

[[:SENSe]:TINTerval:ARM:ESTART:LAYer2:SLOPe POSitive|NEGative

ESTART:LAY2:SOURce	Front-Panel Arming Mode
IMMEDIATE	Auto
EXTERNAL	EXTERNAL

### **For phase measurements:**

Press the Other Meas and Gate & ExtArm buttons, and then toggle between auto and external under the softkey ARM.

- If Auto Arming is selected, the Counter automatically starts continuous measurements.
- If External Arming is selected, press the softkey under SLOPE to toggle between Positive and Negative. This is to specify the slope of the external start arm signal.

### **Remote Interface Command**

#### **Auto arming:**

[[:SENSe]:PHASe:ARM[:START]:SOURce IMMEDIATE

#### **External arming for U6200A only:**

[[:SENSe]:PHASe:ARM[:START]:SOURce EXTERNAL

[[:SENSe]:PHASe:ARM[:START]:SLOPe POSitive|NEGative

START: SOURce	Front-Panel Arming Mode
IMMediate	Auto
EXTErnal	EXTERNAL

### For totalize measurements:

Press the softkey under GATE to toggle from auto, time and external.

- If Auto Arming is selected, the counter automatically starts continuous measurements.
- If Time Arming is selected, use the numeric keypad or the arrow keys to select a desired gate time (refer to Ch.4.2.1). The time unit will be displayed on the top-right corner.
- If External Arming is selected, press the softkey under START to toggle between positive and negative. This is to specify the slope of the start arm signal. Press the softkey under STOP to toggle between positive, negative and time. This is to specify how measurement should stop. Positive and negative specifies the slope of the stop arm signal. Time is to set the duration of measurement. As time is selected, use the numeric keypad or the arrow keys to input a desired duration value (refer to Ch.4.2.1). The time unit will be shown on the top-right corner.

### Remote Interface Command

#### Auto arming:

[ :SENSe]:TOTAlize:ARM[:START]:SOURce IMMEDIATE

[ :SENSe]:TOTAlize:ARM:STOP:SOURce IMMEDIATE

#### Time arming:

[ :SENSe]:TOTAlize:ARM[:START]:SOURce IMMEDIATE

[ :SENSe]:TOTAlize:ARM:STOP:SOURce TIMer

[ :SENSe]:TOTAlize:ARM:STOP:TIMer <numeric value> [S]

#### External arming:

[ :SENSe]:TOTAlize:ARM[:START]:SOURce EXTErnal

[ :SENSe]:TOTAlize:ARM[:START]:SLOPe POSitive|NEGative

[ :SENSe]:TOTAlize:ARM:STOP:SOURce EXTErnal

[ :SENSe]:TOTAlize:ARM:STOP:SLOPe POSitive|NEGative

[ :SENSe]:TOTAlize:ARM:STOP:SOURce TIMer

[ :SENSe]:TOTAlize:ARM:STOP:TIMer <numeric value> [S]

START: SOURce	STOP: SOURce	Front-Panel Gating Settings	
		GATE	STOP
IMMediate	IMMediate	Auto	----
IMMediate	TIMer	Time	----
EXTErnal	EXTErnal	EXTERNAL	POS, NEG
EXTErnal	TIMer	39EXTERNAL	Time

### For time interval measurement:

Press the softkey under GATE to toggle between auto and external. Press the softkey under DONE to finish the selection.

- If Auto Arming is selected, the counter automatically starts continuous measurements. Besides, users can press the softkey under Delay\* to toggle between None, Time and Event. In the settings of Time and Event, users also can input parameters according to purposes.
- If External Arming is selected, users can define the delay time and other settings by pressing the softkey under \*Dely to toggle between None, Time and Event, the softkey under \*Slop to toggle between Pos (Positive) and Neg (Negative), the softkey under Dely\* to toggle between None, Time and Event, the softkey under Stop\* to toggle between Auto and Ext. Please note that as the softkey is toggled to the Ext, the Slop\* item will appear for users to toggle between Pos (Positive) and Neg (Negative). The setting information is in the following.

Start Delay TimeRange: 100 ns to 999.9999 ms  
Start Delay Time Resolution: 100 ns  
Start Delay Event Range: 1 to 99,999,999 Channel 2 events  
Start Delay Event Rate: 10 MHz maximum  
Start Delay Event Setup Time: 30 ns minimum

Stop Delay Time Range: 100 ns to 10 s  
Stop Delay Time Resolution: 100 ns from 100 ns to 1 s  
1 ms from 1 s to 10 s  
Stop Delay Event Range: 1 to 99,999,999 Channel 2 events  
Stop Delay Event Rate: 10 MHz maximum  
Stop Delay Event Setup Time: 30 ns minimum

※ Note: For positive and negative of the \*Slop, they specify the slope of the start arm signal. For positive and negative of the Stop\*, they specify how measurement should stop. And for the Time, it's to set the duration of measurement. As time is selected, use the numeric keypad or the arrow keys to input a desired duration value (refer to Ch.4.2.1). The time unit will be shown on the top-right corner.



## Remote Interface Command

### Auto arming:

[:SENSe]:TINTerval:ARM:ESTART:LAYer2:SOURce IMMEDIATE  
[:SENSe]:TINTerval:ARM:ESTOP:LAYer2:SOURce IMMEDIATE  
[:SENSe]:TINTerval:ARM:ESTOP[:LAYer[1]]:SOURce IMMEDIATE  
[:SENSe]:TINTerval:ARM:ESTOP[:LAYer[1]]:SOURce TIMER  
[:SENSe]:TINTerval:ARM:ESTOP[:LAYer[1]]:SOURce INTERNAL2  
[:SENSe]:TINTerval:ARM:ESTOP[:LAYer[1]]:TIMER <numeric\_value> [S]  
[:SENSe]:TINTerval:ARM:ESTOP[:LAYer[1]]:ECOunt <numeric\_value>

### External arming for U6200A:

[:SENSe]:TINTerval:ARM:ESTART:LAYer2:SOURce EXTERNAL  
[:SENSe]:TINTerval:ARM:ESTART:LAYer2:SLOPe POSitive | NEGative  
[:SENSe]:TINTerval:ARM:ESTART[:LAYer[1]]:SOURce IMMEDIATE  
[:SENSe]:TINTerval:ARM:ESTART[:LAYer[1]]:SOURce TIMER  
[:SENSe]:TINTerval:ARM:ESTART[:LAYer[1]]:SOURce INTERNAL1  
[:SENSe]:TINTerval:ARM:ESTART[:LAYer[1]]:TIMER <numeric\_value> [S]  
[:SENSe]:TINTerval:ARM:ESTART[:LAYer[1]]:ECOunt <numeric\_value>  
[:SENSe]:TINTerval:ARM:ESTOP:LAYer2:SOURce IMMEDIATE  
[:SENSe]:TINTerval:ARM:ESTOP:LAYer2:SOURce EXTERNAL  
[:SENSe]:TINTerval:ARM:ESTOP:LAYer2:SLOPe POSitive | NEGative  
[:SENSe]:TINTerval:ARM:ESTOP[:LAYer[1]]:SOURce IMMEDIATE  
[:SENSe]:TINTerval:ARM:ESTOP[:LAYer[1]]:SOURce TIMER  
[:SENSe]:TINTerval:ARM:ESTOP[:LAYer[1]]:SOURce INTERNAL2  
[:SENSe]:TINTerval:ARM:ESTOP[:LAYer[1]]:TIMER <numeric\_value> [S]  
[:SENSe]:TINTerval:ARM:ESTOP[:LAYer[1]]:ECOunt <numeric\_value>

ESTART:LAY2 :SOURce	ESTART:LAY1 :SOURce	ESTOP:LAY2 :SOURce	ESTOP:LAY1 :SOURce	Front-Panel Arming Setting			
				*START	*DELAY	STOP*	DELAY*
IMMediate	IMMediate	IMMediate	IMMediate	Auto	----	Auto	None
IMMediate	IMMediate	IMMediate	TIMer	Auto	----	Auto	Time
IMMediate	IMMediate	IMMediate	INTernal2	Auto	----	Auto	Event
EXTernal	IMMediate	IMMediate	IMMediate	Ext	None	Auto	None
EXTernal	IMMediate	IMMediate	TIMer	Ext	None	Auto	Time
EXTernal	IMMediate	IMMediate	INTernal2	Ext	None	Auto	Event
EXTernal	IMMediate	EXTernal	IMMediate	Ext	None	Ext	None
EXTernal	IMMediate	EXTernal	TIMer	Ext	None	Ext	Time
EXTernal	IMMediate	EXTernal	INTernal2	Ext	None	Ext	Event
EXTernal	TIMer	IMMediate	IMMediate	Ext	Time	Auto	None
EXTernal	TIMer	IMMediate	TIMer	Ext	Time	Auto	Time
EXTernal	TIMer	IMMediate	INTernal2	Ext	Time	Auto	Event
EXTernal	TIMer	EXTernal	IMMediate	Ext	Time	Ext	None
EXTernal	TIMer	EXTernal	TIMer	Ext	Time	Ext	Time
EXTernal	TIMer	EXTernal	INTernal2	Ext	Time	Ext	Event
EXTernal	INTernal1	IMMediate	IMMediate	Ext	Event	Auto	None
EXTernal	INTernal1	IMMediate	TIMer	Ext	Event	Auto	Time
EXTernal	INTernal1	IMMediate	INTernal2	Ext	Event	Auto	Event
EXTernal	INTernal1	EXTernal	IMMediate	Ext	Event	Ext	None
EXTernal	INTernal1	EXTernal	TIMer	Ext	Event	Ext	Time
EXTernal	INTernal1	EXTernal	INTernal2	Ext	Event	Ext	Event

## 4.4 Setting Scale and Offset

The U6200A/220A provides the option of performing scaling and offset calculations on the measurement results before they are displayed. The mathematical formula involved is listed as follows:

$$(\text{Displayed Result}) = (\text{Scale} \times \text{Measurement Result}) + \text{Offset}$$

The Scale and Offset are user-specified parameters as shown in the Figure 4-10, and provide multiplication and addition functions for user purposes to offset systematic errors or to present the percentage difference between signals. This option is disabled by default. It is automatically turned on when either Scale or Offset is specified.



Figure 4-10

### **To Enable/Disable Math Calculation with Scale and Offset**

1. Press SCALE&OFFSET button.
2. Press the softkey under Scale or Offs to do specific settings.

### **Remote interface command**

Use this command to enable or disable the math operation:

:CALCulate:MATH:STATe OFF | ON

### **To Specify the value of Scale**

1. Press SCALE&OFFSET button.
2. Press the softkey under Scale. The present value of Scale is then displayed.
3. Use the numeric keypad or the arrow keys to enter a desired value (refer to Ch.4.2.1).

SCALE Range:    -9.999,999E+12 to -1.000,000E-13  
                  0.000,000  
                  +1.000,000E-13 to +9.999,999E+12

Value Resolution: 7 digits

4. Press the softkey under Done to finish the entry or the softkey under Cancel to withdraw the changes.

### **Remote interface command**

Use the following command to specify the value of Scale:

:TRACe[:DATA] SCALE,<numeric value>

### **To Specify the value of Offset**

1. Press SCALE&OFFSET button.
2. Press the softkey under Offs. The present value of Offset is then displayed.
3. Use the numeric keypad or the arrow keys to enter a desired value (refer to Ch.4.2.1).

Offset Range:    -9.999,999,000,0E+12 to -1.000,000,000,0E-13  
                  0.000,000,000,0  
                  +1.000,000,000,0E-13 to +9.999,999,000,0E+12

Value Resolution: 11 digits

4. Press the softkey under Done to finish the entry of this value or the softkey under Cancel to withdraw the changes.

### Remote interface command

Use the following command to specify the value of Offset:

```
:TRACe[:DATA] OFFSET,<numeric value> [HZ|S|DEG]
```

### To specify Set Offs?

To enable Set Offs, the value will be set in negative automatically.

1. Press Scale & Offset button.
2. Press the softkey under Set Offs?

---

## 4.5 Limits Operations

The U6200A/220A lets you set upper and lower measurement limits, and you can instruct the Counter to stop or keep measuring when the measurement exceeds the limits.

Please note that the Limit Modes are not available for the Totalize (located in Other Meas.) and the Voltage Peak measurement.

By the functions on the Limit Modes as shown in the Figure 4-11, users can stop measurement as they set (OnFail: Stop), and get measured value exceeding user-defined parameters. On the contrary, the measurement can keep going as the setting is (OnFail: Go on), although measurement exceeds user-defined parameters. And the exceeded values will be transmitted to another unit for diagnosing via USB as the (OUT\* USB) is enabled.

※ Note: The U6220A doesn't support (OUT\* USB) function.



Figure 4-11

Besides, the (OnFail: Stop) won't effect any change under single measurement mode.

### **To set upper or lower limit**

1. Press LIMIT MODES button.
2. Press the softkey under Upper to select upper limit or under Lower to select lower limit. Use the numeric keypad or the arrow keys to enter a desired limit value (refer to Ch.4.2.1).

Upper Range:     -9.999,999,000,0E+12 to -1.000,000,000,0E-13  
                  0.000,000,000,0  
                  +1.000,000,000,0E-13 to +9.999,999,000,0E+12

Value Resolution: 11 digits

Lower Range:     -9.999,999,000,0E+12 to -1.000,000,000,0E-13  
                  0.000,000,000,0  
                  +1.000,000,000,0E-13 to +9.999,999,000,0E+12

Value Resolution: 11 digits

3. Press the softkey under DONE to finish setting the limits.

### **Remote Interface Command**

Use the following commands to set upper/lower limits:

:CALCulate2:LIMit:UPPer[:DATA] <numeric value> [HZ|S|DEG]

:CALCulate2:LIMit:LOWer[:DATA] <numeric value> [HZ|S|DEG]

### **To use limit testing**

1. Press LIMIT MODES button.
2. Press the softkey under ONFAIL to toggle between GO-ON and STOP. Select GO-ON so that the Counter keeps making measurements when the measurement exceeds the limits, or select STOP so that the counter stops measuring when the measurement exceeds the limits.
3. Press the softkey under DONE to finish the setting.

### **Remote Interface Command**

Use the following commands to activate the limit testing and to set ONFAIL mode:

:CALCulate2:LIMit:STATe OFF|ON

:INITiate:AUTO OFF

:INITiate:AUTO ON

### **To display graph for limit testing result**

The counter display Limit Testing results in a graph where a circle within two vertical bars represents a measurement within user-defined limits, and the setting information will be showed. Users Show Status > Limit. When users finish the Limit Testing settings and press the softkey under DONE, the graph display mode will be presented at the bottom of the display by pressing the softkey "Show Status", and toggle between options until "Limit" appears.

### **Remote Interface Command**

Use the following command to select display mode for Limit Testing result:

:CALCulate2:LIMit:DISPlay GRAPH | NUMBer

### **To specify OUT\***

Please refer to the instruction in Chapter 5.

1. Press Limit Modes button.
2. Press the softkey under OUT\* to toggle between Off, USB

※ **Note:** The U6220A doesn't support (OUT\* USB) function.

### **Remote Interface Command**

:SYSTem:COMMunicate:SERial:CONTrol:DTR OFF|LIM

:SYSTem:COMMunicate:SERial:SOURce USB (for U6200A only)

---

## **4.6 Statistics Operations**

The U6200A/220A may be activated to collect statistics on measurements within specified limits or on other measurement except Peak Volts and Totalize. Press the STATS button to enter the menu for setting up statistics operations:

- **To enable/disable statistics operations:** press the STATS in the

MATH area on the front panel to turn on or off the statistics operation.

- **To select which statistic to display:** press the softkey under SHOW to toggle between Stdev, Max, Min, Mean, Delta and Meas.
- **To display measurement:** press the softkey under SHOW to toggle through the options until MEAS appears.
- **To set number of measurements** made for each computed statistic: press the softkey under N Cnt to enter the number of counts. Use the numeric keypad and the arrow keys to set the desired value (refer to Ch.4.2.1). The number range is from 2 to 1,000,000.
- **To display the statistics on measurements within limits** (refer to Ch. 4.5 for setting the limits): press the softkey under USE to toggle between All (taking all measurements) and InLimit (taking only measurements within limits).
- **To specify whether to make single or N measurements** (specified by N Cnt) when the STOP/SINGLE button is pressed: press the softkey under SINGLE to toggle between Once and N. Also refer to the single mode operation in Ch.4.2.2. N means the number of limited measurement.

※ **Note:** Generally, measurement resolution will be improved in proportion to  $\sqrt{2}$ , even up to the numerical process limits of the instrument.

### Remote Interface Command

Use the following commands for statistic operations:

:CALCulate3:AVERage[:STATe] OFF|ON

:CALCulate3:AVERage:COUNT <numeric value>

:CALCulate3:LFILter:STATe ON|OFF

:CALCulate3:AVERage:TYPE MAXimum | MINimum | SDEVIation | MEAN or SCALar | DELTa

:DISPlay[:WINDow]:TEXT:FEED "CALC3"

:TRIGger:COUNT:AUTO ON | OFF

---

## 4.7 Setting Channel Input Conditions

Press CH1 or CH2 (for U6200A only) button to enter the channel conditioning menu in which you can set up the input conditions of the corresponding channel. Procedures for setting up the input conditions are identical for both channels.

- **To Set Input Impedance:** press the softkey under IMPED to toggle between 1 M $\Omega$  and 50 $\Omega$ .
- **To Set Input Coupling:** press the softkey under COUPL to toggle between AC and DC.
- **To Set Attenuation of signals:** press the softkey under ATTEN to toggle between X1 and X10.
- **To Set Filter:** press the softkey under FILTER to toggle between NONE and 100k.
- **Input Front/Rear:** Users also can do measurement from the rear terminal by pressing the softkey under Input Front, once the source connection is established in the rear. Please note that if sources are from the rear, users have to purchase the accessory U6200-opt04.

※ **Note:** The U6220A doesn't provide the rear input CH1/CH2/CH3.

### Remote Interface Command

Use the following commands for assigning your channel conditions:

```
:INPut[1|2]:IMPedance 1E6|50 [OHM]
```

```
:INPut[1|2]:COUPLing AC|DC
```

```
:INPut[1|2]:ATTenuation 1|10
```

```
:INPut[1|2]:FILTer ON|OFF
```

```
:INPut[1|2]:PATH FRONT|REAR
```

※ **Note:** The commands via channel 2 are for U6200A only.

---

## 4.8 Trigger Setting

All measurement functions are almost performed in auto-trigger default mode. One may manually turn off auto triggering and/or make changes



on related settings if it's needed.

When auto-triggering is off, users are allowed to specify the voltage level at which the corresponding input channel triggers an event. When auto-triggering is on, users are allowed to specify the percentage of an input signal at which the Counter triggers an event. In addition, one may specify sensitivity level to avoid incorrect events triggered due to noise.

Sensitivity at a particular frequency is the lowest amplitude signal to trigger the counter for counting. The amplifier gain and the voltage difference between the trigger hysteresis levels determine the sensitivity of the counter. Sensitivity is specified by the upper and lower levels with the trigger level fixed at the middle. The input signal must cross both the upper and lower levels in order to trigger a count as shown in Figure 4-12. If the peak-to-peak amplitude of a signal does not exceed the limits, this signal will not trigger a count as shown in Figure 4-13. Moreover, the counter also won't do a count as the trigger level which is set below the midpoint of the signal can't cross the limit as shown in Figure 4-14.

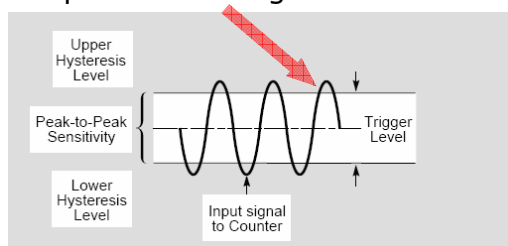

**Figure 4-12**

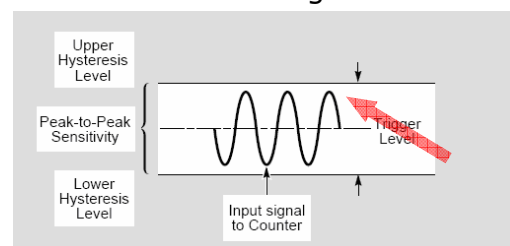

**Figure 4-13**

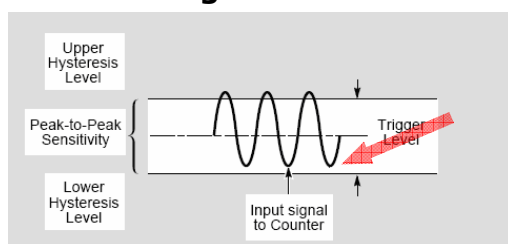

**Figure 4-14**

Triggering menu is associated with input channel. Press CH1 or CH2 (for U6200A only) and the softkey under TRIG SENS as shown in the Figure 4-15 to enter the menu. Then follow the instructions below for different operations:



**Figure 4-15**

- **To turn on/off auto triggering:** press the softkey under AUTO to toggle between ON and OFF as shown in the Figure 4-16.



**Figure 4-16**

- **To set trigger level:** press the softkey under LEVEL and use the numeric keypad or arrow keys to enter a desired value as shown in the Figure 4-17 (refer to Ch.4.2.1).

Trig Auto ON: 0 to 100 PCT  
 Trig Auto OFF: ATT X1: -5.125 to +5.125V  
                   ATT X10: -51.25 to +51.25V  
 Numeric\_value Resolution: ATT X1: 0.0025V  
                                   ATT X10: 0.025V



**Figure 4-17**

- **To specify triggering slope/edge:** press the softkey under SLOPE as shown in the Figure 4-18 to toggle between POS (positive) as shown in Figure 4-19 and NEG (negative) as shown in Figure 4-20.

High: 0 PCT  
 Middle: 50 PCT  
 Low: 100 PCT



**Figure 4-18**

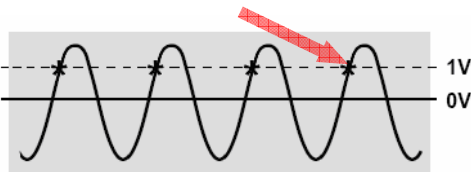

**Figure 4-19**

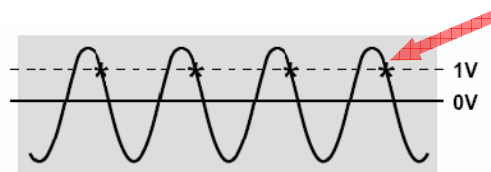

**Figure 4-20**

- **To set sensitivity:** Press the softkey under SENS to toggle between LOW, MED (medium) and HIGH as shown in the Figure 4-21.



**Figure 4-21**

- **To set Com.:** The setting is enabled only by using Time Interval as shown in the Figure 4.22. To toggle the softkey Com. OFF, sources will be inputted to the CH1 and CH2 individually as the Time Interval is working. To toggle the softkey Com. ON, sources will be supported via CH1 only as the Time Interval is working.

## Remote Interface Command

### To turn on/off auto triggering

[[:SENSe]:EVENT[1|2]:LEVel[:ABSolute]:AUTO ON|OFF

### To set trigger level

[[:SENSe]:EVENT[1|2]:LEVel[:ABSolute] <numeric value> [v]

[[:SENSe]:EVENT[1|2]:LEVel:RELative<numeric value> [PCT]

### To set sensitivity

[[:SENSe]:EVENT[1|2]:HYSTeresis:RELative 100|50|0

### To specify triggering slope/edge

[[:SENSe]:EVENT[1|2]:SLOPe POSitive|NEGative

### To set common

[[:SENSe]:EVENT2:FEED "[[:]INPut[1] | [[:]INPut2" (for U6200A only)

## Using Com. to Make Time Interval (TI) Measurement on a Single Signal

As described in Ch.3.3, Interval 1 to 2 measures the length of the duration between a start event on channel 1 and a stop event on channel 2. And users also can do the settings on level, slope or sensitivity for application purposes. One may also follow the following instructions such that the start and the stop events are triggered from the same source connected to one of the two channels:

1. Connect a signal source to channel 1 (or 2).
2. Press TIME&PERIOD button.
3. Use the softkey under (INTVL 1 to 2) to select interval measurement
4. Press CH1 (or CH2) button to enter the channel conditioning menu.
5. Press the softkey under TRIG SENS to enter the trigger setting menu.
6. Press the softkey under Com. to select OFF (or ON) as shown in the Figure 4-22. This instructs the Counter to count the signal interval time from channel 1 (or 2) to channel 2 (or 1).



Figure 4-22

※ Note: The U6220A doesn't support "Time Interval Measurement" colored green.

---

## 4.9 Save and Recall Functions

The U6200A/220A provide functions to save and recall your measurement settings which determine how the U6200A/220A measure, analyzes and reports answers, especially, the functions can reserve measurement settings, desired precision, specific offset/scale, limit range and statistics. The settings are stored in non-volatile memory and will not be erased after power-down. The U6200A/220A can save up to 20 different measurement settings as shown in the Figure 4-23. Refer to Table in Appendix B for all the measurement parameters that are handled by Save and Recall function.

### To save measurement setting

1. Press SAVE&RECALL button.
2. Use the softkey under SAVE to select "save" function.
3. Toggle the same softkey or use the numeric or arrow keys to enter the memory address (1-20) to which you want to save the current settings.
4. Press the softkey under ENTER to select one of specified records.
5. Press the softkey under Run Store to do the save action as shown in the Figure 4-23.



**Figure 4-23**

### Remote Interface Command

\*SAV <Nrf>

### To recall measurement setting

1. Press SAVE&RECALL button.
2. Use the softkey under Recall to select the "recall" function.
3. Toggle the same Recall softkey to enter the memory address from which you want to recall the settings.
4. Press the softkey under Run Recall to do the recall action as shown in the Figure 4-24.



**Figure 4-24**

**Remote Interface Command**

\*RCL<Nrf>

**To erase measurement setting**

1. Press SAVE&RECALL button.
2. Use the softkey under Erase to select the "erase" function.
3. Toggle the same Erase softkey to enter the memory address in which you want to erase the settings.
4. Press the softkey under Run Erase to do the erasion as shown in the Figure 4-25.



**Figure 4-25**

**To Power on Recall**

1. Press Save & Recall button.
2. Press the softkey under Save to select the memory number from 1 to 20 for stocking present settings. As well the arrow and numeric keys are available to be used. (It's better that users take memo on each saved number.)
3. Press the softkey under Done to finish.
4. Press the softkey under RwrOn Recall to toggle between the saved memory numbers shown on the display.
5. Press the softkey under Done to select the desire number as the power-on default.

---

## 4.10 Utility Operations

The Utility operations let users execute manual calibration, configure interface, enable or disable Beep function, run self-test, and set up timebase as shown in the Figure 4-26.



Figure 4-26

### I/O configuration

Refer to chapter 5 for interface configuration.

### Calibration

Users need a security code, such as "6200" for the U6200A and "6220" for the U6220A. Only when a correct security code is entered, users will enter to the calibration menu.

1. Press the UTILITY button, and it works with a lighting signal.
2. Use the softkey under CAL to select the calibration operation.
3. Use the numeric keypad or the arrow keys to enter the correct security code as shown in the Figure 4-27.
4. Press the softkey under Cal Diag to manually set calibration conditions, such as Gain, Offs and T-F as shown in the Figure 4-28 (users can save the settings according to purposes by pressing the softkey under Save.). For more calibration information, please check the List 4-1.
5. Press the softkey under Run Cal when everything is set ready.



Figure 4-27



Figure 4-28

Item	Softkeys	Description
1.	Gain Inp1 + Run Cal	DC +5V Calibration at CH1
2.	Gain Inp2 + Run Cal	DC +5V Calibration at CH2
3.	Gain Att1 + Run Cal	DC +9V ATT x 10 Calibration at CH1
4.	Gain Att2 + Run Cal	DC +9V ATT x 10 Calibration at CH2
5.	Offs Inp1 + Run Cal	DC +0V Calibration at CH1
6.	Offs Inp2 + Run Cal	DC +0V Calibration at CH2
7.	Offs Att1 + Run Cal	DC +0V ATT x 10 Calibration at CH1
8.	Offs Att2 + Run Cal	DC +0V ATT x 10 Calibration at CH2
9.	T-F Quick + Run Cal	Time Domain Calibration (incl. External Arm)
10.	T-F Fine1 + Run Cal	Time Interval Calibration
11.	T-F Fine2 + Run Cal	Time Interval Calibration ( incl. External Arm)
12.	T-F Freq + Run Cal	10 MHz Calibration
13.	Save	Save the settings in the memory

**List 4-1**

※ Note: The U6220A doesn't support some calibration items colored green.

### Remote Interface Command

Use these commands to run calibration:

:CALibration:SECurity:STATe <Boolean>,<NRf>

### System Setup

Under the System Setup menu as shown in the Figure 4-29, users can run self-test, adjust the beeper setting, choose dot convention (i.e., using comma or period to separate the integral portion and fraction portion of a number), and TOUT (i.e., If the time out "ON" is chosen, the time out mode will be enabled, and as measurement time exceeds time-out limit, the counter will send a not-a-number value to the computer. For this purpose, the counter can prevent keeping measurement. Besides, the time out "OFF" is set to disabled the function.

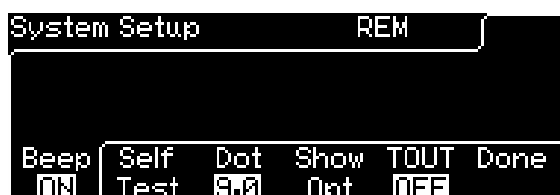



**Figure 4-29**

1. Press the UTILITY button.
2. Use the softkey under Syst to enter the system setup menu.
3. To enable/disable beeper: press the softkey under BEEP to toggle between OFF and ON.
4. To run self-test: Press the softkey under SelfTest to start the test.
5. To select dot convention: press the softkey under Dot 9.0 to toggle between dot and comma conventions.
6. To show option: Press the softkey under Show Opt to present the built-in accessory information.
7. To enable/disable time out: press the softkey under TOUT to toggle between OFF and ON.

### Remote Interface Command

\*TST?

:SYSTem:BEEPer:STATe ON|OFF

:DISPlay[:WINDow]:TEXT:RADix DPOint | COMMa

:SYSTem:TOUT ON|OFF

:SYSTem:TOUT <numeric\_value>

### TimeBase Source

Follow the following instruction to select TimeBase source:

1. Press UTILITY button.
2. Use the softkey under TimeBase to select timebase source.
3. Use the softkey under TimeBase to toggle between AUTO, INT (internal) and EXT (external) as shown in the Figure 4-30.



**Figure 4-30**

### Remote Interface Command

[:SENSe]:ROSCillator:SOURce INT | EXT

[:SENSe]:ROSCillator:SOURce:AUTO ON|OFF

### Style

The Style function is the way to present values on the display. Users can toggle the softkey under Style between the E-6 and  $\mu\text{Hz}$  notations. Here,  $\mu\text{Hz}$  refers to the engineering notation and E-6 refers to the E notation.

1. Press Utility button.
2. Use the softkey under Style to toggle between  $\mu\text{Hz}$  and E-6 as shown in the Figure 4-31 and Figure 4-32 respectively.

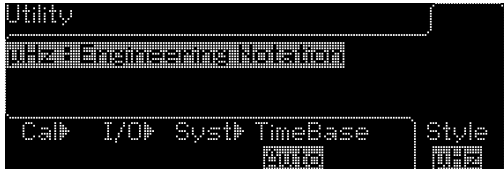

**Figure 4-31**



**Figure 4-32**

---

## 4.11 Display Tips

The display tips including 1. View remote Command error, 2. Get HELP on any key, 3. Power up Default state resetting, 4. Synchronize multiple instruments, 5. PICOTEST Technical Support, will be presented via the following procedures.

---

### 4.11.1 View Remote Command Error

Via the display tips, users will easily view remote command error. The operation procedures are in the following.

1. Press the Help button on the front panel.
2. Press the softkeys under  $\downarrow$ ,  $\uparrow$  and SELECT to select item 1 "View remote command error". Command error information **would** be shown on the display **if an error exists**.
3. Press the softkey under Done to exit from the display to the operation mode. Error messages will be erased, and the display will show +0, "No error" as the command SYST:ERR? is executed.

---

### 4.11.2 Get HELP on ANY KEY

Users can get HELP from pressing each button including the softkey, which can provide service. The operation procedures are in the following.

1. Press the Help button on the front panel.
2. Press the softkeys under ↓, ↑ and SELECT to select item 2 "Get HELP on any key". The HELP information will be shown on the display: **To get brief help information on any front-panel key or menu soft-key, press and hold the key for few seconds.**
3. Press the softkey under Done to finish the setting, and return to the operation mode.

---

### 4.11.3 Power up Default State Resetting

Users can follow the tips to power up from a specific default state. The operation procedures are in the following.

1. Press the Help button on the front panel.
2. Press the softkeys under ↓, ↑ and SELECT to select item 3 "Power up Default state resetting". The teaching instruction will be there, such as 1: Press [Save&Recall]. 2: Press "PwrOn Recall" to select default on record "0". 3: Press "Done" to complete setting.
3. Press the softkey under Done to exit from the display to the operation mode.

---

### 4.11.4 Synchronize Multiple Instruments

Users can follow the tips to synchronize multiple instruments. The operation procedures are in the following.

1. Press the Help button on the front panel.
2. Press the softkeys under ↓, ↑ and SELECT to select item 4 "Synchronize multiple instruments". The teaching instruction will be there, such as 1: Connect the [10MHz In] connector from one

- instrument to the other instrument. 2: Press [Utility]. 3. Press "TimeBase" to select "Auto" or "Ext" as time base source. 4: Press "Done"
3. Press the softkey under Done to exit from the display to the operation mode.

---

#### **4.11.5 PICOTEST Technical Support**

Via the tips, users can find the PICOTEST contact information. The operation procedures are in the following.

1. Press the Help button on the front panel.
2. Press the softkeys under ↓, ↑ and SELECT to select item 5 "PICOTEST Technical Support". The PICOTEST contact information and website will be shown on the display: **To obtain technical support, dial the number +886-7-815-7183 or visit PICOTEST Website [Http://www.picotest.com.tw](http://www.picotest.com.tw) for technical support.**
3. Press the softkey under Done to return to the operation mode.

# 5 Remote Interface Operations

The U6200A/220A support three interfaces for remote access: USB, LAN and GPIB (IEEE-488). USB and LAN are built in the U6200A/220A. GPIB is available as an optional interface card. In addition to setting up the interfaces, this Chapter lists the SCPI (Standard Commands for Programmable Instrument) commands available for controlling the U6200A/220A remotely. For the new users to apply SCPI commands, please refer to Appendix C for more information.

## 5.1 Pass/Fail Output via USB Connector

The USB connector on the rear panel of U6200A is a series "B" connector. When users press the Limit Modes button and the softkey under OUT\* to toggle to USB, the internal pass and fail TTL output signals (limit testing) will be transmitted via the USB port.

The pass and fail signals are low true and indicate the Math Pass/Fail Limit Test result for the *next* reading to be output to the GPIB interface. The signals are active low for approximately 2ms ( $\pm 100 \mu\text{sec}$ ) for each reading taken. **Figure 5-1** shows the USB connector (series "B").

Contact Number	Signal Name	Typical Wiring Assignment	Description
1	VBUS	Red	Floating
2	D-	White	Limit Test Pass
3	D+	Green	Limit Test Fail
4	GND	Black	GND

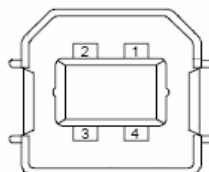

**Figure 5-1**

- ※ Note: The Pass/Fail Output can't be used on Volt Peak and Totalize.
- ※ Note: The U6220A doesn't support "OUT\*" function colored green.

---

## 5.2 Setting Up for Remote Access

Users may use the U6200A/220A application developed by PICOTEST to remotely control the universal counter through USB, LAN or GBIP interface.

### To set up the USB interface

The USB cord should be connected well between the U6200A/220A and user's PC. Install the U6200A/220A application in the PC and execute the program. Click Tool tab for PT Assistant, then input commands.

### To check USB ID

1. Press the UTILITY button and then the softkey under I/O to select the I/O menu.
2. Press the softkey under SHOW USBID. The USB ID will then be displayed.

### To set up the GPIB interface

Insert a GPIB interface card into the interface slot on the rear panel. Assign an address for the interface. Then install the U6200A/220A application in the PC and execute the program. Click Tool tab for PT Assistant, then type in commands.

### How to assign GPIB address

1. Press Utility button and then the softkey under I/O to select the I/O menu.
2. Press the softkey under "GPIB Addr" to specify the GPIB address as shown in the Figure 5-3.
3. Use the numeric keypad or the arrow keys to input a desired address (refer to Ch.4.2.1).



**Figure 5-3**

※ Note: The GPIB address is from 0 ~ 30.

### LAN Configuration

To configure user's local area network interface, A few parameters need to be configured. Users may need to contact network administrators for information to establish communication with the LAN interface.

※ Note: The U6200A/220As' LANs support the environments including Web Server and Java (TM) SE Runtime 6 (Update 1) or up.

### To configure LAN interface

1. Press UTILITY button and then the softkey under I/O to select the I/O menu.
2. Press the softkey under LAN to enter the LAN menu where users can set up IP addresses and DNS as shown in the Figure 5-4.

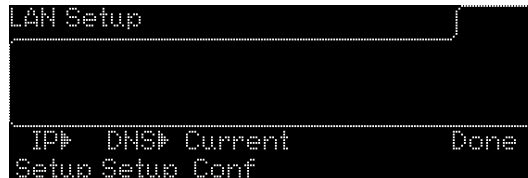

**Figure 5-4**

### To set up IP addresses

1. Press the softkey under IP SETUP to enter the IP address menu.
2. Use the softkey under DHCP to toggle between ON and OFF as shown in the Figure 5-5.



**Figure 5-5**

※ **Note:** The address 192.168.0.248 set as a default is an example for users' reference.

IP address, network mask and gateway will be assigned automatically by the DHCP server at the time of connecting the U6200A/220A to the network, if users enable DHCP. On the contrary, if users disable the DHCP function, then they need to set IP address, network mask and gateway manually. For more IP address information, users have to contact local network administrators.

The ways to set up these values are identical. The values are all in IP address format in form of "n.n.n.n" where n is an integer between 0 and 255. The procedure is described as follows.

#### **To set IP address, network mask or gateway**

1. Press the softkey under DHCP to turn off DHCP.
2. Press the softkey under IP ADDR, NET MASK or GATEWAY.
3. Use the numeric keys to enter the value.
4. Press the softkey under ENTER to set the value or the softkey under CANCEL to withdraw the changes.

#### **To set up DNS**

DNS (Domain Name Service) translates domain names into IP addresses. If the DNS is being used, consult local network administrators with the information about the host name, domain name and DNS server address. A DNS server address is in the form of "n.n.n.n" as shown in the Figure 5-3 where n is an integer between 0 and 255.



**Figure 5-3**

- **To set the DNS server address:** In the LAN menu, press the softkey under DNS Setup and then the softkey under DNS server. Use the numeric keys or the arrow keys to enter the DNS server address (refer to Ch.4.2.1).



- **To set the host name:** In the LAN menu, press the softkey under Host Name. Use the numeric keys or the arrow keys to enter the Host name (refer to Ch.4.2.1).
- **To set the domain name:** In the LAN menu, press the softkey under Domain Name. Use the numeric keys or the arrow keys to enter the Domain name (refer to Ch.4.2.1).

---

## 5.3 Remote Interface Commands

One may instruct the U6200A/220A to take measurement by using the SCPI commands on a remote PC after the Counter and the PC are connected and interface is properly configured as described in Ch.5.1. The SCPI commands available for the U6200A/220A are listed below for quick reference. Refer to Appendix C for detailed command syntax and description. For the new users to apply SCPI commands, please refer to Appendix C.1 for the introductory material on SCPI.

※ **Note:** The following conventions are used in SCPI command listing. Triangle brackets (<>) indicates that users must specify a value for the enclosed parameter. The square brackets ([]) indicates that the parameter is optional and can be omitted. A vertical bar (|) separates several options for a parameter.

<function>	<parameters>	[,source_list]
[:VOLTage]:FREQuency	[<expected_value> [,<resolution>]]	[(@1) (@2) (@3)]
[:VOLTage]:FREQuency:RATio	[<expected_value> [,<resolution>]]	[(@1),(@2) (@3)]  [(@2) (@3),(@1)]
[:VOLTage]:PERiod	[<expected_value> [,<resolution>]]	[(@1) (@2) (@3)]
[:VOLTage]:RISE:TIME [:VOLTage]:RTIME	[<lower_reference> [,upper_reference]]	[(@1)]
[:VOLTage]:FALL:TIME [:VOLTage]:FTIME	[<lower_reference> [,upper_reference]]	[(@1)]
[:VOLTage]:PWIDth	[<reference>]	[(@1)]
[:VOLTage]:NWIDth	[<reference>]	[(@1)]
[:VOLTage]:TINTerval		[(@1),(@2)]

[[:VOLTage]:PTPeak		[(@1),(@2)]
[[:VOLTage]:MAXimum		[(@1),(@2)]
[[:VOLTage]:MINimum		[(@1),(@2)]
[[:VOLTage]:CENTer		[(@1),(@2)]
[[:VOLTage]:PHASe		[(@1),(@2)]
[[:VOLTage]:DCYcle	[<reference>]	[(@1)]
[[:VOLTage]:PDUTYcycle		
[[:VOLTage]:TOTalize:CONTinuous		[(@1)]
[[:VOLTage]:TOTalize:TIMed	[<gate_time>]	[(@1)]

※ Note: The command [[:VOLTage]:TOTalize:CONTinuous] is allowed with CONFigure only.

※ Note: The U6220A doesn't support the commands and the channel 2 & 3 selections colored green.

### The MEASure? Command

Although it does not offer much flexibility, using the command :MEASure? is the simplest way to program the Counter for measurement. With the command, the Counter makes measurement according to the selected measurement function and sends the result to the output buffer.

#### **:MEASure[:SCALar]:<function>? <parameters> [,<source\_list>]**

For more information about <function>, <parameters> and <source\_list>, please refer to the above table.

- If users skip the parameters and the function, or use the keyword DEFault, the default setting (parameters and function) will be used.
- Using this command automatically turns off the statistics, scale and offset and limit testing operations.
- If the trigger level is not specified in <parameters>, then auto-triggering will be enabled and the trigger levels will be automatically set in all functions but Voltage Peaks and Totalize on the measurement channel.

#### **:MEASure**

#### **:MEASure[:SCALar]**

[[:VOLTage]:FREQUency? [<expected\_value> [,<resolution>]]  
 [,(@1)|(@2)|(@3)]

```

[:VOLTage]:FREQuency:RATio? [<expected_value> [,<resolution>]]
    [,(@1),(@2)|(@3)]|[(@2)|(@3),(@1)]
[:VOLTage]:PERiod? [<expected_value> [,<resolution>]]
    [,(@1)|(@2)|(@3)]
[:VOLTage]:RISE:TIME? [<lower_reference> [,upper_reference]][,(@1)]
[:VOLTage]:RTIME? [<lower_reference> [,upper_reference]][,(@1)]
[:VOLTage]:FALL:TIME? [<lower_reference> [,upper_reference]][,(@1)]
[:VOLTage]:FTIME? [<lower_reference> [,upper_reference]][,(@1)]
[:VOLTage]:PWIDth? [<reference>][,(@1)]
[:VOLTage]:NWIDth? [<reference>][,(@1)]
[:VOLTage]:TINTerval? [(@1),(@2)]
[:VOLTage]:PTPeak? [(@1),(@2)]
[:VOLTage]:MAXimum? [(@1),(@2)]
[:VOLTage]:MINimum? [(@1),(@2)]
[:VOLTage]:CENTer? [(@1),(@2)]
[:VOLTage]:PHASe? [(@1),(@2)]
[:VOLTage]:DCYCLE? [<reference>][,(@1)]
[:VOLTage]:PDUcycle? [<reference>][,(@1)]
[:VOLTage]:TOTalize:TIMed? [<gate_time>][,(@1)]

```

※ Note: The U6220A doesn't support the commands and the channel 2 & 3 selections colored green.

### The CONFigure Command

The CONFigure command offers a little more flexibility than the command MEASure? and is usually used with the commands READ?. The universal counter sets the parameters for the requested function, but does not make measurement. Users have an option to change the configuration. To initiate the measurement, READ? Or INITiate commands can be used.

**:CONFigure[:SCALar]:<function> <parameters> [,<source\_list>]**

For more information about <function>, <parameters> and <source\_list>, please refer to the above table.

- If you skip the parameters or the function, or the source list, or use the keyword DEFault instead, the default settings (parameters, function and source) will be used.
- Using this command automatically turns off the statistics operation, scale

and offset operation and limit testing.

- If the trigger level is not specified in <parameters>, then auto-triggering will be enabled and the trigger levels will be automatically set in all functions but Voltage Peaks and Totalize on the measurement channel.

## **:CONFigure**

### **:CONFigure[:SCALAr]**

```
[:VOLTage]:FREQuency [<expected_value> [,<resolution>]]
    [,(@1)|(@2)|(@3)]
[:VOLTage]:FREQuency:RATio [<expected_value> [,<resolution>]]
    [,(@1)|(@2)|(@3)]|[(@2)|(@3),(@1)]
[:VOLTage]:PERiod [<expected_value> [,<resolution>]]
    [,(@1)|(@2)|(@3)]
[:VOLTage]:RISE:TIME [<lower_reference> [,upper_reference]][,(@1)]
[:VOLTage]:RTIME [<lower_reference> [,upper_reference]][,(@1)]
[:VOLTage]:FALL:TIME [<lower_reference> [,upper_reference]][,(@1)]
[:VOLTage]:FTIME [<lower_reference> [,upper_reference]][,(@1)]
[:VOLTage]:PWIDth [<reference>][,(@1)]
[:VOLTage]:NWIDth [<reference>][,(@1)]
[:VOLTage]:TINTerval [(@1),(@2)]
[:VOLTage]:PTPeak [(@1),(@2)]
[:VOLTage]:MAXimum [(@1),(@2)]
[:VOLTage]:MINimum [(@1),(@2)]
[:VOLTage]:CENTer [(@1),(@2)]
[:VOLTage]:PHASe [(@1),(@2)]
[:VOLTage]:DCYCLE [<reference>][,(@1)]
[:VOLTage]:PDUtYcycle [<reference>][,(@1)]
[:VOLTage]:TOTalize:CONTinuous [(@1)]
[:VOLTage]:TOTalize:TIMed [<gate_time>][,(@1)]
```

※ Note: The U6220A doesn't support the commands and the CH2 & 3 selections colored green.

## **The READ? Command**

The command READ? is often used with the command CONFigure? to have a effect similar to the command MEASure? in which the users provide required parameters, configure the counter and make

measurements. The command :CONFigure? does the configuration part of the measurement, and the command :READ? does the data acquisition and post processing (if any), and puts the result in the Output queue. Use this command combination to instruct the counter to perform something between the measurement setup and data acquisition.

#### **:READ[[:SCALar]:<function>]?**

For more information about <function>, <parameters> and <source\_list>, please refer to the above table.

Using the command READ? has a same effect as using the command INITiate[:IMMediate] followed by the command :FETCh?.

#### **:READ**

##### **:READ[:SCALar]**

[ :VOLTage]:FREQuency?

[ :VOLTage]:FREQuency:RATio?

[ :VOLTage]:PERiod?

[ :VOLTage]:RISE:TIME?

[ :VOLTage]:RTIME?

[ :VOLTage]:FALL:TIME?

[ :VOLTage]:FTIME?

[ :VOLTage]:PWIDth?

[ :VOLTage]:NWIDth?

[ :VOLTage]: TINTerval?

[ :VOLTage]:PTPeak?

[ :VOLTage]:MAXimum?

[ :VOLTage]:MINimum?

[ :VOLTage]:CENTer?

[ :VOLTage]:PHASe?

[ :VOLTage]:DCYClE?

[ :VOLTage]:PDUtYcycle?

[ :VOLTage]:TOTalize:TIMed?

※ **Note:** The U6220A doesn't support the commands colored green.

#### **The Commands INITiate and FETCh?**

These two commands provide the lowest level of control of measurement

triggering and reading retrieval, but offer the most flexibility. After you have configured the universal counter, use the command INITiate to initiate the measurements. The results are sent to the internal memory and stored until you are ready to read them.

### **FETCh[[:SCALar]:<function>]?**

For more information about <function>, please refer to the above table.

The command FETCh? sends the data in the universal counter's internal memory to the output buffer where you can read them into your bus controller.

### **:INITiate**

:AUTO<Boolean>

:CONTinuous<Boolean>

[:IMMEDIATE]

### **:FETCh**

#### **FETCh[:SCALar]**

[:VOLTage]:FREQuency?

[:VOLTage]:FREQuency:RATio?

[:VOLTage]:PERiod?

[:VOLTage]:RISE:TIME?

[:VOLTage]:RTIME?

[:VOLTage]:FALL:TIME?

[:VOLTage]:FTIME?

[:VOLTage]:PWIDth?

[:VOLTage]:NWIDth?

[:VOLTage]: TINTerval?

[:VOLTage]:PTPeak?

[:VOLTage]:MAXimum?

[:VOLTage]:MINimum?

[:VOLTage]:CENTer?

[:VOLTage]:PHASe?

[:VOLTage]:DCYClE?

[:VOLTage]:PDUtYcycle?

[:VOLTage]:TOTalize:TIMed?

※ Note: The U6220A doesn't support the commands colored green.

### The [:SENSe] command

The commands [:SENSe] control directly on the instrument-specific setting, but not the ones related to the signal-oriented characteristics.

#### [:SENSe]

:DATA? [":]SENSe[1]"

#### [:SENSe]

:EVENT2:FEED [":]INPut[1]|[:]INPut2"

:EVENT[1|2]:HYSTEResis:RELative <numeric value> [PCT]

:EVENT[1|2]:LEVel[:ABSolute] <numeric value> [V]

:EVENT[1|2]:LEVel[:AUTO] <Boolean>

:EVENT[1|2]:LEVel:RELative <numeric value> [PCT]

:EVENT[1|2]:SLOPe POSitive|NEGative

:EVENT3:LEVel[:ABSolute]?

:EVENT3:SLOPe?

#### [:SENSe]

:FREQuency:ARM[:START]:SLOPe POSitive|NEGative

:FREQuency:ARM[:START]:SOURce IMMEDIATE|EXTernal

:FREQuency:ARM:STOP:DIGits <numeric value>

:FREQuency:ARM:STOP:SLOPe POSitive|NEGative

:FREQuency:ARM:STOP:SOURce IMMEDIATE|EXTernal|TIMER|DIGits

:FREQuency:ARM:STOP:TIMER <numeric value> [S]

:FREQuency:EXPeCted[1|2|3] <numeric value> [HZ]

:FREQuency:EXPeCted[1|2|3]:AUTO ON

#### [:SENSe]

:PHASe:ARM[:START]:SLOPe POSitive|NEGative

:PHASe:ARM[:START]:SOURce IMMEDIATE|EXTernal

#### [:SENSe]

:TINTerval:ARM[:START]:SLOPe POSitive|NEGative

:TINTerval:ARM[:START]:SOURce IMMEDIATE|EXTernal

:TINTerval:ARM:STOP:SOURce IMMEDIATE|TIMER

:TINterval:ARM:STOP:TIMer <numeric value> [S]

### **[ :SENSE ]**

:TOTaLize:ARM[:START]:SLOPe POSitive|NEGative

:TOTaLize:ARM[:START]:SOURce IMMEDIATE|EXTernal

:TOTaLize:ARM:STOP:SLOPe POSitive|NEGative

:TOTaLize:ARM:STOP:SOURce IMMEDIATE|EXTernal|TIMer

:TOTaLize:ARM:STOP:TIMer <numeric value> [S]

### **[ :SENSE ]**

:VOLTage:MODE FAST | SLOW

※ Note: The U6220A doesn't support the commands and channel 2 & 3 selections colored green.

## **The :TRACe Commands**

The :TRACe commands are used to set up the scale and offset values.

### **:TRACe**

:CATalog?

[ :DATA ] OFFSET, <numeric value> [ HZ | S | DEG ]

[ :DATA ] OFFSET, <arbitrary block>

[ :DATA ]? OFFSET

[ :DATA ] SCALE, <numeric value>

[ :DATA ] SCALE, <arbitrary block>

[ :DATA ]? SCALE

## **The COMMANDS CALCulate**

All commands :CALCulate perform mathematical operations on the measurements, but among those commands the commands :CALCulate[1] deal with the calculations related to SCALE and OFFSET operations, and commands :CALCulate2 performs operations related to limit testing, and commands :CALCulate3 do all calculations related to statistics operations.

### **:CALCulate[1]**

:DATA?



:FEED "[:]SENSe[1]"  
:IMMediate  
:IMMediate:AUTO <Boolean>  
:MATH[:EXPRession]:CATalog?  
:MATH[:EXPRession][:DEFine]?  
:MATH[:EXPRession]:NAME SCALE\_OFFSET

Or

:MATH[:EXPRession]:SElect SCALE\_OFFSET  
:MATH:STATe <Boolean>

### **:CALCulate2**

:FEED "[:]CALCulate[1]"  
:IMMediate  
:IMMediate:AUTO <Boolean>  
:LIMit:CLEar:AUTO <Boolean>  
:LIMit:CLEar[:IMMediate]  
:LIMit:DISPlay GRAPH | NUMBer  
:LIMit:FAIL?  
:LIMit:FCOunt:LOWer?  
:LIMit:FCOunt:UPPer?  
:LIMit:FCOunt[:TOTal]?  
:LIMit:LOWer[:DATA] <numeric\_value> [HZ|S|DEG]  
:LIMit:UPPer[:DATA] <numeric\_value> [HZ|S|DEG]  
:LIMit:PCOunt[:TOTal]?  
:LIMit:STATe <Boolean>

### **:CALCulate3**

:AVERage:ALL?  
:AVERage:CLEar  
:AVERage:COUnT <numeric\_value>  
:AVERage:COUnT:CURRent?  
:AVERage[:STATe] <Boolean>  
:AVERage:TYPE MAXimum | MINimum | SEDViation | SCALar or MEAN |  
DELTA  
:DATA?  
:FEED "[:]CALCulate[1]"  
:LFILter:LOWer[:DATA] <numeric\_value> [HZ|S|DEG]

:LFILter:UPPer[:DATA] <numeric\_value> [HZ|S|DEG]  
:LFILter:STATe <Boolean>  
:PATH?

## Commands SYSTEM-RELATED

### :ABORt

### :DISPlay

:ENABle <Boolean>  
:MENU[:STATe] OFF  
[:WINDow]:TEXT:FEED "[:]CALCulate2" | "[:]CALCulate3"  
[:WINDow]:TEXT:RADix COMMa | DPOint

### :FORMat

[:DATA] ASCii | REAL

### :SYSTem

COMMunicate:SERial:CONTrol:DTR OFF | LIMit  
COMMunicate:SERial:SOURce USB  
:COMMunicate:RLSTate REMote | LOCal | RWLock  
:ERRor?  
:KEY <Numeric value>  
:KEY:LOG?  
:VERsion?  
:BEEPer:STATe ON | OFF  
:IDNStr <QUOTED STRING>

Example: SYSTem:IDNStr "PICOTEST U6200A,0,0,0"

## CALIBRATION COMMANDS

The U6200A/220A have a security code to protect the counter from an accidental calibration, such as "6200" for the U6200A and "6220" for the U6220A. You have to enter a correct security code before you can calibrate the counter.

### :CALibration

:SECurity:STATe <Boolean>,<NRf>  
:SECurity:CODE <new code>

:DATA <arbitrary block>

## **Miscellaneous**

### **:INPut[1|2]**

:ATTenuation 1|10

:COUPling AC|DC

:FILTer[:LPASs][:STATe] <Boolean>

:FILTer[:LPASs]:FREQuency?

:IMPedance <numeric value> [OHM]

### **:INPut3**

:COUPling?

:IMPedance?

### **:TRIGger**

:COUNT:AUTO <Boolean>

### **:MEMory**

:NSTates?

## **IEEE-488.2 COMMON COMMANDS**

\*CLS

\*DDT <arbitrary block>

\*ESE <NRf>

\*ESE?

\*ESR?

\*IDN?

\*OPC

\*OPC?

\*OPT?

\*RCL <NRf>

\*RST

\*SAV <NRf>

\*SRE <NRf>

\*SRE?

\*STB?

\*TRG

\*TST?

\*WAI

※ Note: The U6220A doesn't support the commands and the channel 2 & 3 selections colored green.

# 6 Manual Calibration Procedures

---

The manual calibration is via the following procedures: UTILITY > CAL > Enter Security Code > Cal Diag > (Gain, Offs, T-F) > RunCal. After pressing the softkey under RunCal, the counter's display will show "Calibrating...". The finished message will disappear from the display as calibration is done. On the contrary, the NG message will show on the display as calibration is failed. The Calibration can be saved by pressing the softkey under Save.

※ Note: The Offset calibration is more prior than the Gain calibration.

---

## 6.1 How to do the Offset Calibration via CH1

The Offset Calibration via CH1 is for checking DC +0V. Please do the following procedures to finish the calibration.

1. Press UTILITY > CAL > Enter Security Code > Cal Diag > Offs Inp1.
2. Remove all sources on the counter.
3. Press the softkey under RunCal to do the calibration. Then, the counter's display will show "Calibrating...". The finished message will disappear from the display as calibration is done. On the contrary, the NG message will show on the display as calibration is failed.

---

## 6.2 How to do the Offset Calibration via CH2

The Offset Calibration via CH2 is for checking DC +0V. Please do the following procedures to finish the calibration.

1. Press UTILITY > CAL > Enter Security Code > Cal Diag > Offs

- Inp2.
2. Remove all sources on the counter.
  3. Press the softkey under RunCal to do the calibration. Then, the counter's display will show "Calibrating...". The finished message will disappear from the display as calibration is done. On the contrary, the NG message will show on the display as calibration is failed.

※ Note: The U6220A doesn't support the calibration via channel 2.

---

### **6.3 How to do the ATT x 10 Offset Calibration via CH1**

The Offset Calibration via CH1 is for checking ATT x 10 and DC +0V. Please do the following procedures to finish the calibration.

1. Press UTILITY > CAL > Enter Security Code > Cal Diag > Offs Att1.
2. Remove all sources on the counter.
3. Press the softkey under RunCal to do the calibration. Then, the counter's display will show "Calibrating...". The finished message will disappear from the display as calibration is done. On the contrary, the NG message will show on the display as calibration is failed.

---

### **6.4 How to do the ATT x 10 Offset Calibration via CH2**

The Offset Calibration via CH2 is for checking ATT x 10 and DC +0V. Please do the following procedures to finish the calibration.

1. Press UTILITY > CAL > Enter Security Code > Cal Diag > Offs Att2.
2. Remove all sources on the counter.
3. Press the softkey under RunCal to do the calibration. Then, the counter's display will show "Calibrating...". The finished message will disappear from the display as calibration is done. On the contrary, the NG message will show on the display as calibration is failed.

※ Note: The U6220A doesn't support the calibration via channel 2.

---

## 6.5 How to do the Gain Calibration via CH1

The Offset Calibration via CH1 is for checking DC +5V. Please do the following procedures to finish the calibration.

1. Press UTILITY > CAL > Enter Security Code > Cal Diag > Gain Inp1.
2. Use the BNC T-connector with 2 BNC cords to link an Agilent 33220A and a DMM (multimeter) as shown in the Figure 5-1.
3. Under the Agilent 33220A operation, the procedures should be Utility > DC ON > Output Setup > Hi-Z.
4. Adjust the voltage on the Agilent 33220A, and let the DMM displays  $+5.000V \pm 0.001V$ .
5. Remove the input source, from the DMM, on the counter.
6. Press the softkey under RunCal to do the calibration. Then, the counter's display will show "Calibrating...". The finished message will disappear from the display as calibration is done. On the contrary, the NG message will show on the display as calibration is failed.

---

## 6.6 How to do the Gain Calibration via CH2

The Offset Calibration via CH2 is for checking DC +5V. Please do the following procedures to finish the calibration.

1. Press UTILITY > CAL > Enter Security Code > Cal Diag > Gain Inp2.
2. Use the BNC T-connector with 2 BNC cords to link an Agilent 33220A and a DMM (multimeter).
3. Under the Agilent 33220A operation, the procedures should be Utility > DC ON > Output Setup > Hi-Z.
4. Adjust the voltage on the Agilent 33220A, and let the DMM displays  $+5.000V \pm 0.001V$ .

5. Remove the input source, from the DMM, on the counter.
6. Press the softkey under RunCal to do the calibration. Then, the counter's display will show "Calibrating...". The finished message will disappear from the display as calibration is done. On the contrary, the NG message will show on the display as calibration is failed.

※ Note: The U6220A doesn't support the calibration via channel 2.

---

## 6.7 How to do the ATT x 10 Gain Calibration via CH1

The Offset Calibration via CH1 is for checking ATT x 10 and DC +9V. Please do the following procedures to finish the calibration.

1. Press UTILITY > CAL > Enter Security Code > Cal Diag > Gain Att1.
2. Use the BNC T-connector with 2 BNC cords to link an Agilent 33220A and a DMM (multimeter).
3. Under the Agilent 33220A operation, the procedures should be Utility > DC ON > Output Setup > Hi-Z.
4. Adjust the voltage on the Agilent 33220A, and let the DMM displays  $+5.000V \pm 0.001V$ .
5. Remove the input source, from the DMM, on the counter.
6. Press the softkey under RunCal to do the calibration. Then, the counter's display will show "Calibrating...". The finished message will disappear from the display as calibration is done. On the contrary, the NG message will show on the display as calibration is failed.

---

## 6.8 How to do the ATT x 10 Gain Calibration via CH2

The Offset Calibration via CH2 is for checking ATT x 10 and DC +9V. Please do the following procedures to finish the calibration.

1. Press UTILITY > CAL > Enter Security Code > Cal Diag > Gain



Att2.

2. Use the BNC T-connector with 2 BNC cords to link an Agilent 33220A and a DMM (multimeter).
3. Under Agilent 33220A operation, the procedures should be Utility > DC ON > Output Setup > Hi-Z.
4. Adjust the voltage on the Agilent 33220A, and let the DMM displays  $+5.000V \pm 0.001V$ .
5. Remove the input source, from the DMM, on the counter.
6. Press the softkey under RunCal to do the calibration. Then, the counter's display will show "Calibrating...". The finished message will disappear from the display as calibration is done. On the contrary, the NG message will show on the display as calibration is failed.

※ Note: The U6220A doesn't support the calibration via channel 2.

---

## 6.9 How to do the Time Domain Calibration (Including External ARM)

The calibration is for Time Domain excluding the Time Interval. Please do the following procedures to finish the calibration.

1. Press UTILITY > CAL > Enter Security Code > Cal Diag > T-F Quick.
2. Under the Agilent 33220A operation, the procedures should be Utility > DC ON > Output Setup > Load.
3. Adjust the square wave to 20MHz, and set the Ampl to 1.65Vpp, the Offs to 0.75Vdc and DutyCycle to 50% on the Agilent 33220A.
4. Connect Agilent 33220A's Sync to the Counter's External ARM.
5. Under the Agilent 81110A operation, the procedures should be MODE/TRG > Pulse-Period > internal PLL.
6. Under the Agilent 81110A operation, press LEVELS and then Output1 buttons to set Amplit to 1V and the Offset to 0V.
7. Under the Agilent 81110A operation, press TIMING, and set the Freq to ON, and adjust it to 1MHz. Besides, in the output1, set the Delay to 0s, DtyCyc to 50 % and LeadE to 0.8ns.

8. Connect from the OUTPUT1 of the Agilent 81110A to the Counter's CH1.
9. Press the softkey under RunCal to do the calibration. Then, the counter's display will show "Calibrating...". The finished message will disappear from the display as calibration is done. On the contrary, the NG message will show on the display as calibration is failed.

---

## 6.10 How to do the Time Interval Calibration

The calibration is for Time Interval excluding the External ARM. Please do the following procedures to finish the calibration.

Press UTILITY > CAL > Enter Security Code > Cal Diag > T-F Fine1.

Under the Agilent 81110A operation, the procedures should be MODE/TRG > Pulse-Period > internal PLL.

Under the Agilent 81110A operation, press LEVELS and then Output1 & Output2 buttons to set Amplit to 1V and the Offset to 0V respectively.

Under the Agilent 81110A operation, press TIMING, and set the Freq1 & Freq2 to ON, and adjust them to 1MHz respectively.

Under the Agilent 81110A operation, in the Output1 and Output2, set the Delay to 0s, DtyCyc to 50 % and LeadE to 0.8ns.

Connect from the OUTPUT1 and OUTPUT2 of the Agilent 81110A to the Counter's CH1 and CH2 respectively.

Press the softkey under RunCal to do the calibration. Then, the counter's display will show "Calibrating...". The finished message will disappear from the display as calibration is done. On the contrary, the NG message will show on the display as calibration is failed.

※ Note: The U6220A doesn't support "Time Interval Calibration".

---

## 6.11 How to do the Time Interval Calibration (Including External ARM)

The calibration is for Time Interval including the External ARM. Please do

the following procedures to finish the calibration.

1. Press UTILITY > CAL > Enter Security Code > Cal Diag > T-F Fine2.
2. Under the Agilent 33220A operation, the procedures should be Utility > DC ON > Output Setup > Load.
3. Adjust the square wave to 20MHz, and set the Ampl to 1.65Vpp, the Offs to 0.75Vdc and DutyCycle to 50% on the Agilent 33220A.
4. Connect Agilent 33220A's Sync to the Counter's External ARM.
5. Under the Agilent 81110A operation, the procedures should be MODE/TRG > Pulse-Period > internal PLL.
6. Under the Agilent 81110A operation, press LEVELS and then Output1 and Output2 buttons to set Amplit to 1V and the Offset to 0V respectively.
7. Under the Agilent 81110A operation, press TIMING button, and set the Freq1 & Freq2 to ON, and adjust them to 1MHz respectively.
8. Under the Agilent 81110A operation, in the Output1 set the Delay to 0s, DtyCyc to 50 % and LeadE to 0.8ns. And in the Output2 set the Delay to 125ns, DtyCyc to 50% and LeadE to 0.8ns.
9. Connect from the OUTPUT1 and OUTPUT2 of the Agilent 81110A to the Counter's CH1 and CH2 respectively.
10. Press the softkey under RunCal to do the calibration. Then, the counter's display will show "Calibrating...". The finished message will disappear from the display as calibration is done. On the contrary, the NG message will show on the display as calibration is failed.

※ Note: The U6220A doesn't support "Time Interval Calibration".

---

## 6.12 How to do the Standard Timebase Calibration

The calibration is for 10MHz. Please do the following procedures to finish the calibration.

1. After powering the counter, users have to warm it up at least 30

minutes.

2. Press UTILITY > CAL > Enter Security Code > Cal Diag > T-F Freq.
3. Input 10 MHz source to the counter's CH1.
4. The standard specification for a 10 MHz is 10.000,000,00 MHz  $\pm 1\text{Hz}$ .
5. Press the softkey under RunCal to do the calibration. Then, the counter's display will show "Calibrating...". The finished message will disappear from the display as calibration is done. On the contrary, the NG message will show on the display as calibration is failed.

# 7 Error Messages

---

Errors are retrieved in first-in-first-out (FIFO) order. The first error returned is the first error that was stored. Use :SYST:ERR? to read errors. When user has read all errors from the queue, the error queue becomes empty and any error query will return +0, "No error". The U6200A beep once each time an error occurs.

Should more than 29 errors have existed, the last error stored in the queue (the most recent error) is replaced with -350, "Queue overflow". No additional errors are saved until you remove errors from the queue.

The error queue is cleared when power is off or after a \*CLS (clear status) command is executed. The \*RST (reset) command does not clear the error queue.

---

## 7.1 Command Errors

- **+0 No error**

There is no error in the error queue. (:SYSTem:ERRor? query) or the queue was cleared by power-on or \*CLS.
- **-100 Command error**

This is the generic syntax error used when the Counter cannot detect more specific errors.
- **-101 Invalid character**

A syntactic element contains a character that is invalid for that type. For example, a header containing an ampersand, :INP:COUP& AC.
- **-102 Syntax error**

An unrecognized command or data type was encountered.
- **-103 Invalid separator**

The parser was expecting a separator but encountered an illegal character.
- **-104 Data type error**

The parser recognized a data element different than one with the allowed

type. For example, numeric or string data was expected, but block data was received.

- **-105 GET not allowed**  
A Group Execute Trigger was received within a program message.
- **-108 Parameter not allowed**  
More parameters were received than expected for the header.
- **-109 Missing parameter**  
Fewer parameters were received than required for the header.
- **-112 Program mnemonic too long**  
The header or character data element contains more than twelve characters.
- **-113 Undefined header**  
The header is syntactically correct, but it is undefined for the Counter. For example, \*XYZ is not defined for the Counter.
- **-120 Numeric data error**  
This error, as well as errors -121 through -129, are generated when parsing a data element which appears to be numeric, including the non-decimal numeric types. This particular error message is used when the Counter cannot detect a more specific error.
- **-121 Invalid character in number**  
An invalid character for the data type being parsed was encountered. For example, a "9" in octal data.
- **-123 Exponent too large**  
Numeric overflow.
- **-124 Too many digits**  
The mantissa of a decimal numeric data element contained more than 255 digits excluding leading zeros.
- **-128 Numeric data not allowed**  
A legal numeric data element was received, but the Counter does not allow one in this position for the header.
- **-131 Invalid suffix**  
The suffix does not follow the syntax described in IEEE 488.2 or the suffix is inappropriate for the Counter.
- **-134 Suffix too long**  
The suffix contained more than 12 characters.
- **-138 Suffix not allowed**  
A suffix was encountered after a numeric element that does not allow suffixes.

- **-141 Invalid character data**  
An invalid character was detected in the character data element.
- **-148 Character data not allowed**  
A legal character data element which was prohibited by the Counter was detected.
- **-150 String data error**  
This error can be generated when parsing a string data element. This particular error message is used if the Counter cannot detect a more specific error.
- **-151 Invalid string data**  
A string data element was expected but was invalid for some reason. For example, an END message was received before the terminal quote character.
- **-158 String data not allowed**  
A string data element was encountered but was not allowed by the Counter at this point in parsing.
- **-160 Block data error**  
This error can be generated when parsing a block data element. This particular error message is used if the Counter cannot detect a more specific error.
- **-161 Invalid block data**  
A block data element was expected, but it was not allowed by the Counter at this point in parsing.
- **-168 Block data not allowed**  
A legal block data element was encountered but was not allowed by the Counter at this point in parsing.
- **-170 Expression errors**  
This error can be generated when parsing an expression data element. It is used if the Counter cannot detect a more specific error.
- **-171 Invalid expression**  
The expression data element was invalid (see IEEE 488.2). For example, unmatched parentheses or an illegal character.
- **-178 Expression data not allowed**  
Expression data was encountered but was not allowed by the Counter at this point in parsing.
- **-181 Invalid outside macro definition**  
Indicates that a macro parameter placeholder ( $\$(\text{number})$ ) was encountered outside of a macro definition.

---

## 7.2 Execution Errors

- **-200 Execution error**

This is the generic syntax error if the Counter cannot detect more specific errors. This code indicates only that an Execution Error has occurred.

- **-210 Trigger error**

Used when the Counter cannot detect a more specific error from the :INIT, :TRIG, or :ABOR subsystems.

- **-211 Trigger ignored**

Indicates that a GET or \*TRG was received and recognized by the Counter but was ignored.

- **-213 Init ignored**

Indicates that a request for a measurement initiation was ignored as another measurement was in progress.

- **-220 Parameter error**

Indicates that a program data element related error occurred. This error is used when the Counter cannot detect more specific errors.

- **-221 Setting conflict**

Indicates that a legal program data element was parsed but could not be executed due to the current Counter state.

- **-222 Data out of range**

Indicates that a legal program data element was parsed but could not be executed because the interpreted value is outside the legal range defined by the Counter. Typically, the value is clipped to legal limit.

- **-223 Too much data**

Indicates that a legal program data element of block, expression, or string type was received that contained more data than the Counter could handle due to memory or related Counter-specific requirements.

- **-224 Illegal parameter value**

Used where exact value, from a list of possible values, was expected.

- **-230 Data corrupt or stale**

No valid data available. New measurement started but not completed.

- **-240 Hardware error**

Indicates that a legal program command or query could not be executed because of a hardware problem in the Counter.

- **-241 Hardware missing**

Indicates that a legal program command or query could not be executed because of



missing Counter hardware. For example, the Channel 3 option was not installed.

- **-272 Macro execution error**

Indicates that a syntactically legal macro program data sequence could not be executed due to some error in the macro definition.

---

## 7.3 Device-Specific Errors

- **-300 Device-specific error**

This is the generic device-dependent error.

- **-310 System error**

Indicates that a system error occurred.

- **-330 Self-test failed**

Indicates at least one failure occurred when \*TST? was executed.

- **-350 Queue overflow**

There is no more room in the error queue and an error occurred.

---

## 7.4 Query Errors

- **-400 Query error**

This is the generic query error.

- **-410 Query INTERRUPTED**

Indicates that a condition causing an INTERRUPTED Query error occurred. For example, a query followed by DAB or GET before a response was completely sent.

- **-420 Query UNTERMINATED**

Indicates that a condition causing an UNTERMINATED Query error occurred. For example, the Counter was addressed to talk and an incomplete program message was received.

- **-430 Query DEADLOCKED**

Indicates that a condition causing a DEADLOCKED Query error occurred. For example, both input buffer and output buffer are full and the Counter cannot continue.

- **-440 Query UNTERMINATED after indefinite response**

Indicates that a query was received in the same program message after a query requesting an indefinite response ( for example, \*IDN? or \*OPT?) was executed.

---

## 7.5 Counter-Specific Errors

- **+2000 Offset calibration on channel 1 failed**
- **+2001 Offset calibration on channel 2 failed (for U6200A only)**
- **+2002 Gain calibration on channel 1 failed**
- **+2003 Gain calibration on channel 2 failed (for U6200A only)**
- **+2004 Interpolator calibration failed**
- **+2005 Oscillation calibration failed**
- **+2006 Time interval calibration failed (for U6200A only)**
- **+2007 Measurement hardware calibration failed**

A measurement calibration failed on the last measurement.
- **+2009 No valid external timebase**

Users have selected external reference and there is no external reference applied to the rear-panel Ref In connector, or the external signal is not an allowed frequency.
- **+2010 External timebase failed during measurement**

Users have selected the auto reference mode and the Counter detected that the external reference became invalid *during* the measurement. Therefore, the current result is not valid, and the Counter switches to using the internal reference.
- **+2011 Recall setup failed; hardware failure**

\*RCL failed.
- **+2011 Recall setup failed; empty register**

\*RCL failed because the register specified for recall is empty.
- **+2012 Save setup failed**

\*SAV failed, or \*RCL couldn't save to register 0.
- **+2013 EEPROM failed**

A request to update a setting which is stored in the EEPROM  
:SYST:COMM:SER:CONT:DTR, :DISP[:WIND]:TEXT:RAD,  
:CAL[:DATA] resulted in a hardware failure.

# Appendix

## A. Specification List

This appendix contains the specifications of the U6200A/220A. It covers the AC, DC, Resistance, Temperature, and Frequency/Period characteristics under a variety of conditions. It also contains the general characteristics and accuracy calculations for your convenience. A lot of efforts are made to make sure these specifications serve your needs for production, engineering and/or research purposes. All specification applies to the U6200A/220A unless noted otherwise.

※ Note: The U6220A doesn't provide the specifications colored green.

Channel 1 & 2 (for U6200A only) Input Specifications	
<b>DC Coupled</b>	1mHz to 400 MHz
<b>AC Coupled</b>	200KHz to 400 MHz (50 Ω) 30 Hz to 400 MHz (1 MΩ)
<b>FM Tolerance</b>	FM Tolerance: 25%
Voltage Range and Sensitivity	
<b>1mH to 225 MHz</b>	20 mVrms to ±5 V ac + dc (Medium and High) 25 mVrms to ±5 V ac + dc (Low) (75 mVrms with optional rear connectors)
<b>225 MHz to 400 MHz</b>	30 mVrms to ±5 V ac + dc (75 mVrms with optional rear connectors)
Channel 1 & 2 (for U6200A only) Input Characteristics	
<b>Impedance</b>	1 MΩ or 50 Ω
<b>(ATT X 1, 1 MΩ Capacitance)</b>	24 pF
<b>(ATT X 10, 1 MΩ Capacitance)</b>	15 pF
<b>Coupling</b>	AC or DC
<b>Low-Pass Filter</b>	100 KHz (or disabled) - 20 dB at > 1 MHz
<b>Input Sensitivity</b>	Selectable between Low, Medium(default), or High Medium is approximately 1.35x High Sensitivity, low is approximately 1.7x High Sensitivity
Voltage Range and Sensitivity (Single-Shot Pulse)	

<b>1.5ns to 10ns Pulse Width</b>	80 mVpp to 10 Vpp (150 mVpp with optional rear connectors)	
<b>&gt;10 ns Pulse Width</b>	50 mVpp to 10 Vpp (150 mVpp with optional rear connectors)	
<b>Trigger Level(ATT x 1)</b>		
<b>Range</b>	±5.125 V	
<b>Accuracy</b>	±(15 mV + 1% of trigger level)	
<b>Resolution</b>	2.5mV	
<b>ATT x 10 Range</b>	X 10	
<b>Trigger Slope</b>	Positive or Negative	
<b>Auto Trigger Level</b>	<b>Range</b>	0 to 100% in 1% steps
	<b>Frequency</b>	Peak Voltage fast mode >10 KHz Peak Voltage slow mode > 100 Hz Amplitude > 100 mVpp (No amplitude modulation)
<b>Damage Level</b>		
<b>DC~400MHz 50 Ω</b>	12 Vrms	
<b>0 to 3.5 kHz, 1 MΩ</b>	350 V dc + ac pk	
<b>3.5 kHz to 100KHz, 1 MΩ</b>	350 V dc + ac pk linearly derated to 12 Vrms	
<b>100KHz to 400MHz, 1 MΩ</b>	12 Vrms	
<b>Attenuator</b>		
<b>Voltage Range</b>	x10	
<b>Trigger Range</b>	x10	

1. Specifications and Characteristics for Channels 1 and 2 are identical for both Common and Separate Configurations.
2. Values shown are for x 1 attenuator setting. Multiply all values by 10 (nominal) when using the x 10 attenuator setting. Note that it may necessary to recalibrate the input offset in the application environment (especially at high temperature) to achieve maximum sensitivity.

<b>Channel 3 Input Specifications (for U6200A only)</b>	
<b>Frequency Range</b>	375 MHz to 6 GHz
<b>Channel 3 Input Characteristics (for U6200A only)</b>	
<b>Impedance</b>	50 Ω
<b>Coupling</b>	AC
<b>VSWR</b>	< 2.5:1
<b>Power Range and Sensitivity (Sinusoid)</b>	
<b>375 MHz to 500 MHz</b>	-16 dBm to +15 dBm
<b>500 MHz to 1 GHz</b>	-20 dBm to +15 dBm
<b>1 GHz to 2 GHz</b>	-23 dBm to +15 dBm
<b>2 GHz to 4 GHz</b>	-25 dBm to +15 dBm
<b>4 GHz to 5 GHz</b>	-21dBm to +15 dBm
<b>5 GHz to 5.5 GHz</b>	-20 dBm to +15 dBm
<b>5.5 GHz to 6 GHz</b>	-17 dBm to +15 dBm
<b>Damage Level</b>	

+25 dBm, DC ±12V		
<b>Option Channel 3 Input Specifications (U6200-opt02: for U6200A only)</b>		
<b>Frequency Range</b>	250 MHz to 20 GHz	
<b>Option Channel 3 Input Characteristics (U6200-opt02: for U6200A only)</b>		
<b>Impedance</b>	50 Ω	
<b>Coupling</b>	AC	
<b>VSWR</b>	< 2.5:1	
<b>Power Range and Sensitivity (Sinusoid, at 25°C)</b>		
<b>250-500MHz</b>	<b>-22~+23dBm</b>	
<b>0.5-14GHz</b>	<b>-27~+23dBm</b>	
<b>14-15GHz</b>	<b>-21~+23dBm</b>	
<b>15-16GHz</b>	<b>-19~+23dBm</b>	
<b>16-19GHz</b>	<b>-17~+23dBm</b>	
<b>19-20GHz</b>	<b>-13~+23dBm</b>	
<b>Damage Level</b>		
+26 dBm, DC ±24V		
<b>External Arm Input Specifications</b>		
<b>Signal Input Range</b>	LVTTTL and TTL compatible	
<b>Timing Restrictions</b>		
<b>Pulse Width</b>	> 50 ns	
<b>Transition Time</b>	< 250 ns	
<b>Start-to-Stop Time</b>	> 50 ns	
<b>Damage Level</b>	12 Vrms	
<b>External Arm Input Characteristics</b>		
<b>Impedance</b>	1 kΩ	
<b>Input Capacitance</b>	17 pF	
<b>Start Slope</b>	Positive or Negative	
<b>Stop Slope</b>	Positive or Negative	
<b>Notes</b>	1. External Arm is available for all measurements except Peak Volts. 2. External Arm is referred to as External Gate for some measurements.	
<b>Internal Time Base Stability</b>		
	Standard (0° to 50°C)	High Stability Oven (U6200-opt01 for U6200A only)
<b>Temperature Stability (referenced to 25°C)</b>	± 1 x 10E-6	± 5 x 10E-9
<b>Aging Rate</b>		± 8 x 10E-10
	Per Day Per Month Per Year	± 8 x 10E-8
<b>Turn-on stability vs. time (30 min.)</b>		± 2.0 x 10E-8 (referenced to 24 hours)
<b>Calibration</b>	Electronic	Electronic

External Time Base Input Specifications		
<b>Voltage Range</b>	200 mVrms to 10 Vrms	
<b>Damage Level</b>	12 Vrms	
External Time Base Input Characteristics		
<b>Threshold</b>	0 V	
<b>Impedance</b>	1 k $\Omega$	
<b>Input Capacitance</b>	25 pF	
<b>Input Frequency</b>	10 MHz	
<b>Internal vs. External Time Base Selection</b>	<b>Manual</b>	Select Internal or External
	<b>Automatic</b>	Internal used when External not present (default)
Time Base Output Specifications		
<b>Output Frequency</b>	10 MHz	
<b>Voltage</b>	570 mVpp (0 dBm), typical	
<b>Impedance</b>	50 $\Omega$ (typical), AC coupled	
Measurement Specifications		
<b>Frequency, Period Channel 1 and 2</b>	1 mHz to 400 MHz (2.5 ns to 1000 s)	
<b>Trigger</b>	Default setting is Auto Trigger at 50 %	
<b>"Auto" Gate Time</b>	0.1 sec	
<b>STD CH 3</b>	375 MHz to 6 GHz (0.166 ns to 2.6 ns)	
<b>Frequency Ratio</b>	CH 1/ CH 2, CH 1/ CH 3, CH 2/ CH 1, CH 3/ CH 1 (Measurement is specified over the full signal range of each input.)	
<b>Results Range</b>	10E-10 to 10E+11	
<b>"Auto" Gate Time</b>	0.1 sec	
<b>Time Interval</b>	Measurement is specified over the full signal ranges of Channels 1 and 2. The width of the pulse must be greater than 1 ns, frequency range to 300 MHz.	
<b>Trigger</b>	Default setting is Auto Trigger at 50 %	
<b>Results Range</b>	-0.5 ns to 10E+5 s	
<b>Resolution</b>	40 ps	
<b>RMS Resolution</b>	120 ps	
<b>Systematic Uncertainty</b>	$\pm(TI \times \text{Time Base Error}) \pm \text{Trigger Level Timing Error} \pm 500 \text{ ps Differential Channel Error}$	
<b>Pulse Width Time</b>	Measurement is specified over the full signal range of Channel 1. The width of the pulse must be greater than 1 ns frequency range to 300 MHz).	
<b>Pulse Selection</b>	Positive or Negative	
<b>Trigger</b>	Default setting is Auto Trigger at 50%	
<b>Results Range</b>	1.5 ns to 10E+5 s	
<b>Resolution</b>	40 ps	
<b>RMS Resolution</b>	120 ps	
<b>Systematic Uncertainty</b>	$\pm (\text{Pulse Width Time} \times \text{Time Base Error}) \pm \text{Trigger Level Timing Error} \pm 500 \text{ ps Differential Channel Error.}$	
<b>Rise/Fall Time</b>	Measurement is specified over the full signal range of Channel 1. The width of the pulse must be greater than 1 ns frequency range to 300 MHz).	
<b>Edge Selection</b>	Positive or Negative	
<b>Trigger</b>	Default setting is Auto Trigger at 10% and 90%	
<b>Results Range</b>	2 ns to 10E+5 s	
<b>Resolution</b>	40 ps	

<b>RMS Resolution</b>	120 ps		
<b>Systematic Uncertainty</b>	$\pm (\text{Edge Time} \times \text{Time Base Error}) \pm \text{Trigger Level Timing Error} \pm 500 \text{ ps Differential Channel Error}$		
<b>Phase</b>	Measurement is specified over the full signal range of each input. The width of the pulse must be greater than 1 ns, frequency range to 300 MHz		
<b>Results Range</b>	-180° to +360°		
<b>Resolution</b>	40 ps		
<b>RMS Resolution</b>	120 ps		
<b>Systematic Uncertainty</b>	$\pm (\text{Trigger Level Timing Error}) \times \text{Frequency}$		
<b>Duty Cycle</b>	Measurement is specified over the full signal range of Channel 1. The width of the pulse must be greater than 1 ns, frequency range to 300 MHz		
<b>Pulse Selection</b>	Positive or Negative		
<b>Trigger</b>	Default setting is Auto Trigger at 50 %		
<b>Results Range</b>	0 to 1		
<b>Resolution</b>	40 ps		
<b>RMS Resolution</b>	120 ps		
<b>Systematic Uncertainty</b>	$\pm \text{Trigger Level Timing Error} \pm 500 \text{ ps Differential Channel Error}$		
<b>Totalize</b>	Measurement is specified over the full signal range of Channel 1. The width of the pulse must be greater than 1 ns, frequency range to 400 MHz		
<b>Pulse Selection</b>	Positive or Negative		
<b>Trigger</b>	Default setting is Trigger at 0 V		
<b>Results Range</b>	0 to 10E+15		
<b>Resolution</b>	1 count		
<b>Systematic Uncertainty</b>	$\pm 1 \text{ count}$		
<b>Peak Voltage</b>	<b>Results Range</b>	-5.1 V to + 5.1 V	
	<b>Resolution</b>	2.5 mV	
<b>DC Signals</b>		15 mV + 2 % of V	peak-to-peak amplitude greater than 200 mV
<b>DC Signals (ATT x 10)</b>		150 mV + 2 % of V	peak-to-peak amplitude greater than 1 V
<b>1 Vp-p, 50 Ω, ATT OFF</b>	100 Hz ~ 10 KHz	15 mV + 2 % of V	peak-to-peak amplitude greater than 200 mV
	10 KHz ~ 5 MHz	15 mV + 4 % of V	
	5 MHz ~ 80 MHz	15 mV + 7 % of V	
	80 MHz ~ 300 MHz	15 mV + 15 % of V	

The peak volts measurement will keep operating up to 400 MHz, although results act as references only. Tres is the resolution including effect of certain internal errors.

The differential channel Error terms which counted by many systematic uncertainty equations result channel-to-channel disaccord and internal noise. These issues can be improved by the TI calibration in the well-controlled temperature environment.

## B. Preset Values and Save/Recall Information

※ Note: The U6220A doesn't provide the function via the channel 2 colored green.

		Value at *RST ( GPIB Reset )	In Save/Recall	In non-volatile memory
Input impedance	CH1	1E+6Ohms	yes	no
	CH2	1E+6Ohms	yes	no
Input Attenuation	CH1	×1	yes	no
	CH2	×1	yes	no
Trigger Level	CH1 (percent)	50	yes	no
	CH2 (percent)	50	yes	no
	CH1 (volts)	0	yes	no
	CH2 (volts)	0	yes	no
Trigger Slope	CH1	positive	yes	no
	CH2	positive	yes	no
Sensitivity	CH1	high	yes	no
	CH2	high	yes	no
Scale		1	yes	no
Offset		0	yes	no
Limits parameters	Limit test on/off	off	yes	no
	On fail stop/go on	go on	yes	no
	Lower limit	0	yes	no
	Upper Limit	0	yes	no
Stats parameters	Stats on/off	off	yes	no
	Measurement count	100	yes	no
	Display measurement/stats	measurement	yes	no
	Use all/in limits	all	yes	no
	On-single measurement	1	yes	no
Timebase		auto	yes	no
Expected Frequency Parameters			no	no
Auto-frequency parameters		on	no	no
Trigger Offset Cal parameters			no	yes
Trigger Gain Cal parameters			no	yes
Time Interval Offset Cal parameters			no	yes
Utility	Option Timebase Cal			



## C. General Specifications

※ Note: The U6220A doesn't support the accessories from item 1 ~ 4 color green.

Item	Limitation & description
Power Supply Voltage	<b>100V/240V ± 10% 50Hz~60Hz ± 10%</b>
	<b>100V/120V ± 10% 400Hz ± 10%</b>
Power Requirements	<b>50 VA Maximum</b>
Operating Humidity	<b>Maximum relative humidity 80% for temperature up to 31 °C decreasing linearly to 50% relative humidity at 40°C</b>
Operating Environment	<b>0 to 55 °C</b>
Storage Temperature	<b>- 40 °C to 70 °C</b>
Operating Altitude	<b>Up to 2000m</b>
Bench Dimensions (WxHxD)	<b>210mm x 85mm x 350mm</b>
Weight	<b>3200g</b>
Safety	<b>IEC61010-1:2001/EN61010-1:2001 (2<sup>nd</sup> Edition)</b>
EMC	<b>EN61326, IEC61000-3, IEC61000-4</b>
Warm-up Time	<b>1 Hour</b>
Warranty	<b>1 Year</b>
Accessory	<ol style="list-style-type: none"> <li><b>1. U6200-opt01: High Stability Oven</b></li> <li><b>2. U6200-opt02: 250 MHz~20 GHz Input Channel 3.</b></li> <li><b>3. U6200-opt04: Rear panel input module (CH1/CH2)</b></li> <li><b>4. U6200-opt05: Rear panel input module (CH1/CH2/CH3)</b></li> <li><b>5. M3500-opt04: GPIB Card</b></li> </ol>

---

## D. Remote Interface Reference

### D.1 Introduction to the SCPI Language

SCPI (*Standard Commands for Programmable Instruments*) is an ASCII-based instrument command language designed for test and measurement instruments. Refer to “Simplified Programming Overview,” for an introduction to the basic techniques used to program the universal counter over the remote interface.

SCPI commands are based on a hierarchical structure, also known as a *tree system*. In this system, associated commands are grouped together under a common node or root, thus forming *subsystems*. A portion of the SENSE subsystem is shown below to illustrate the tree system.

#### **SENSe:**

TOTALize:ARM[:START]:SLOPe POSitive|NEGative

PHASe:ARM[:STOP]:SLOPe: POSitive|NEGative

SENSe is the root keyword of the command, TOTALize and PHASe are second-level keywords, and ARM is third-level keyword. A *colon ( : )* separates a command keyword from a lower-level keyword.

#### **Command Format Used in This Manual**

The format used to show commands in this manual is shown below:

**[ :SENSe ] :TINteRval :ARM [ :START ] :SLOPe Positive | Negative**

※ **Note:** The U6220A doesn't support the command colored green.

The command syntax shows most commands (and some parameters) as a mixture of upper- and lower-case letters. The upper-case letters indicate the abbreviated spelling for the command. For shorter program lines, send the abbreviated form. For better program readability, send the long form.

For example, in the above syntax statement, SENS and SENSE are both acceptable forms. You can use upper- or lower-case letters. Therefore, SENSE, sens, and Sens are all acceptable. Other forms, such as SEN and SE, will generate an error.

A *vertical bar* ( | ) separates multiple parameter choices for a given command string.

*Triangle brackets* ( < > ) indicate that you must specify a value for the enclosed parameter. For example, the above syntax statement shows the *range* parameter enclosed in triangle brackets. The brackets are not sent with the command string. You must specify a value for the parameter (such as "INPut:COUPling AC").

Some parameters are enclosed in *square brackets* ( [ ] ). The brackets indicate that the parameter is optional and can be omitted. The brackets are not sent with the command string. If you do not specify a value for an optional parameter, the universal counter chooses a default value.

### **Command Separators**

A *colon* ( : ) is used to separate a command keyword from a lower-level keyword. You must insert a *blank space* to separate a parameter from a command keyword. If a command requires more than one parameter, you must separate adjacent parameters using a *comma* as shown below:

```
:READ:SCALar:FALL:TIME
```

A *semicolon* ( ; ) is used to separate commands within the *same* subsystem, and can also minimize typing. For example, sending the following command string:

```
:DISP:MENU OFF; TEXT:FEED "CALC2"
```

... is the same as sending the following two commands:

```
:DISP:MENU OFF
```

```
:DISP:TEXT:FEED "CALC2"
```

Use a colon *and* a semicolon to link commands from *different* subsystems. For example, in the following command string, an error is generated if you do not use both the colon *and* semicolon:

```
:DISP:MENU OFF;:CALC2:LIM:DISP NUMBER
```

## Querying Parameter Settings

You can query the current value of most parameters by adding a *question mark (?)* to the command. For example, the following command sets the input attenuation to 10:

```
:INPut:ATTenuation 10
```

You can query the input attenuation by executing:

```
:INPut:ATTenuation?
```

**✘Caution:** If you send two query commands without reading the response from the first, and then attempt to read the second response, you may receive some data from the first response followed by the complete second response. To avoid this, do not send a query command without reading the response. When you cannot avoid this situation, send a device clear before sending the second query command.

## SCPI Command Terminators

A command string sent to the universal counter *must* terminate with a *<new line>* character. The IEEE-488 *EOI* (end-or-identify) message is interpreted as a *<new line>* character and can be used to terminate a command string in place of a *<new line>* character. A *<carriage return>* followed by a *<new line>* is also accepted. Command string termination will *always* reset the current SCPI command path to the root level.

## IEEE-488.2 Common Commands

The IEEE-488.2 standard defines a set of *common commands* that perform functions like reset, self-test, and status operations. Common

commands always begin with an asterisk (\*), are four to five characters in length, and may include one or more parameters. The command keyword is separated from the first parameter by a *blank space*. Use a *semicolon (;)* to separate multiple commands as shown below:

```
*RST; *CLS; *ESE 32; *OPC?
```

### **SCPI Parameter Types**

The SCPI language defines several different data formats to be used in program messages and response messages.

***Numeric Parameters*** Commands that require numeric parameters will accept all commonly used decimal representations of numbers including optional signs, decimal points, and scientific notation.

***Discrete Parameters*** Discrete parameters are used to program settings that have a limited number of values (like IMMEDIATE, EXTERNAL). They have a short form and a long form just like command keywords. You can mix upper- and lower-case letters. Query responses will *always* return the short form in all upper-case letters. The following command uses discrete parameter:

```
:INITiate[:IMMEDIATE]
```

***Boolean Parameters*** Boolean parameters represent a single binary condition that is either true or false. For a false condition, the universal counter will accept "OFF" or "0". For a true condition, the universal counter will accept "ON" or "1". When you query a boolean setting, the instrument will *always* return "0" or "1". The following command uses a boolean parameter:

```
INPut:IMPedance:AUTO OFF|ON
```

***String Parameters*** String parameters can contain virtually any set of ASCII characters. A string *must* begin and end with matching quotes; either with a single quote or with a double quote. You can include the

quote delimiter as part of the string by typing it twice without any characters in between. The following command uses a string parameter:

```
DISPlay:TEXT "CALC2"
```

## D.2 Command Reference

### **:ABORt**

Aborts any measurement in progress as quickly as possible.

※ **Note:** The U6220A doesn't support some commands and instructions colored green.

#### **Notes**

- When this command is sent while the measurement cycle is idle (:INIT:CONT OFF and pending operation flag is false), it is ignored.
- When this command is sent while a single measurement is in progress (:TRIG:COUN:AUTO OFF or :CALC3:AVER OFF, :INIT:CONT OFF, and pending operation flag is true), the measurement will be aborted and pending operation flag set false.
- When this command is sent while repetitive measurement are being taken (:INIT:CONT ON), the current measurement in progress will be aborted and the pending operation flag set false. A new measurement will then be automatically initiated and the pending operation flag set true.
- When this command is sent while a block of measurements is in progress (:TRIG:COUN:AUTO ON and :CALC3:AVER ON, :INIT:CONT OFF, and the pending operation flag is true), the measurement block will be aborted, the pending operation flag set false and the Measuring bit in the Operation Status Register will be set false.
- Terminating a measurement in progress invalidates the result, but is the appropriate way to terminate an automatically armed Totalized measurement.

#### **The command :CALCulate[1]**

Performs data processing or transfer on data of scale and offset operation acquired by the :SENSe command. Be sure to send :CALCulate[1]:MATH:STATe ON to activate the operation before

any :CALCulate[1] command.

#### **:CALCulate[1]:DATA?**

Queries the measurement result using scale and offset calculation.

#### **Return**

- Results are formatted according to :FORMat[:DATA] ASCii|REAL setting.
- When using ASCii format, numeric data is transferred as ASCII bytes in <NR3> format. The number of significant digits will range from 1 to 15, depending on the measurement resolution. Only significant digits will be returned.
- If there is no valid result, error -230 will be generated and 9.91E37(Not A Number) will be returned.
- If Totalize or Voltage Peaks are chosen, error 0221 will be generated and 9.91E37(Not A Number) will be returned.

#### **Notes**

- If this command is sent when a measurement is in progress, the results will not be available until the measurement is completed, and it also holds off the subsequent commands unless there is a device clear or a power cycle.
- The last computed result remains valid until a new calculation is made to a relevant instrument state is modified.

#### **:CALCulate[1]:FEED "[[:]SENSe[1]"**

Feeds the data to the CALCulate[1] block.

#### **Return**

- The string "SENS" is returned.

#### **:CALCulate[1]:IMMediate**

Instructs the counter to re-compute the current data without re-acquiring data.

This command will not affect:

:CALC2:LIM:FCO

:CALC2:LIM:PCO

:CALC3:...

#### **Return**

- Results are formatted according to :FORMat[:DATA] ASCii|REAL setting.

- When using ASCII format, numeric data is transferred as ASCII bytes in <NR3> format. The number of significant digits will range from 1 to 15, depending on the measurement resolution. Only significant digits will be returned.
- If there is no valid result, error -230 will be generated and 9.91E37(Not A Number) will be returned.
- If Totalize or Voltage Peaks are chosen, error 0221 will be generated and 9.91E37(Not A Number) will be returned.

**Note**

- The recalculation is done automatically when any change is made to any of the :CALCulate[1|2] commands when :CALC:IMM:AUTO ON.

**:CALCulate[1]:IMMEDIATE?**

Queries the results of the new calculation.

**Note**

As the commands INIT:CONT OFF and CALCulate[1]:IMMEDIATE:AUTO OFF are inputted, the command :CALCulate[1]:IMMEDIATE? is just valid.

**:CALCulate[1]:IMMEDIATE:AUTO <Boolean>**

Sets if the re-calculation will automatically be done whenever there's any change made to any of the :CALCulate[1|2] commands.

When it is set to OFF, the :CALCulate[1|2] command produces new results when the command is executed, even when new data is not acquired. And this allows the user to have the new results on the same current data right after new configuration changes.

**Return**

- An ASCII-encoded byte. 0 means OFF, and 1 means ON.

**Notes**

- Affects all the recalculation command settings.
- This will be set to OFF after the counter has been turned off or a remote interface reset.

**:CALCulate[1]:MATH[:EXPRESSION]:CATalog?**

Queries the defined equation name.



**Return**

- Returns the string "SCALE\_OFFSET".

**:CALCulate[1]:MATH[:EXPRession][:DEFine]?**

Queries the equation used in the calculation.

**Return**

- A sequence of ASCII-encoded bytes("SENS"\*SCALE+OFFSET) terminated by a new line and EOI.

**Note**

- It should be the last query in a terminated program message or error-440 will be generated.

**:CALCulate[1]:MATH[:EXPRession]:NAME SCALE\_OFFSET**

Or

**:CALCulate[1]:MATH[:EXPRession]:SELEct SCALE\_OFFSET**

Defines the name of the expression used in mathematic operation.

**Return**

- A sequence of ASCII-encoded bytes:SCALE\_OFFSET.

**:CALCulate[1]:MATH:STATe <Boolean>**

Enables or disables the mathematic operation.

**Return**

- An ASCII-encoded byte. 0 means OFF, and 1 means ON.

**Note**

- This command will clear the limit counts(:CALC:LIM:FCO, :CALC:LIM:PCO).

**The command :CALCulate2**

This group performs limit testing and data transfer.

**:CALCulate2:FEED "[[:]CALCulate[1]"**

Sets or queries the data flow to be fed into the CALCulate2 block.

**Return**

- The string "CALC" is returned.

**:CALCulate2:IMMediate**

Instructs the counter to re-compute the current data without re-acquiring data.

This command will not affect:

:CALC2:LIM:FCO

:CALC2:LIM:PCO

:CALC3:...

**Note**

- The re-calculation is done automatically when any change is made to any of the :CALCulate[1|2] commands when :CALC:IMM:AUTO is ON.

**:CALCulate2:IMMediate:AUTO <Boolean>**

Sets if the re-calculation will automatically be done whenever there's any change made to any of the :CALCulate[1|2] commands.

When it is set to OFF, the :CALCulate[1|2] command produces new results when the command is executed, even when new data is not acquired. And this allows the user to have the new results on the same current data right after new configuration changes.

**Return**

- An ASCII-encoded byte. 0 means OFF, and 1 means ON.

**Notes**

- This will be set to OFF after the counter has been turned off or a remote interface reset.
- Affects all the recalculation command settings.
- The only limit result that can be post-processed is :CALC2:LIM:FAIL?. The limit counts (:CALC2:LIM:FCO and :CALC:LIM:PCO) reflect measurements that were limit-tested at time of data acquisition.

**:CALCulate2:LIMit:CLEar:AUTO <Boolean>**

Sets if the limit test results to be cleared when an :INITiate[:IMMediate] or an :INITiate:CONTiunuous ON command is encountered.

When it is set to OFF, only will the :CALC2:LIM:CLE[:IMM] command clear the limit testing results.

#### **Return**

- A single ASCII-encoded byte. 0 means OFF and 1 means ON.

#### **Notes**

- This will be set to ON after the counter has been turned off or a remote interface reset.
- When this is set to ON, the following will be done whenever :INIT[:IMM] or :INIT:CONT ON is executed:

The limit data gets cleared.

The :CALC2:LIM:FAIL, :CALC2:LIM:FCO

and :CALC2:LIM:PCO information gets cleared.

The Limit-Detect output of the RS-232 connector is set to the in-limit voltage level.

#### **:CALCulate2:LIMit:CLEar[:IMMEDIATE]**

Instructs the counter to invalidate the limit data immediately, and clear :CALC2:LIM:FAIL, :CALC2:LIM:FCO and :CALC2:LIM:PCO information, and also sets the limit-detect output of the RS-232 connector to the in-limit voltage level.

#### **Note**

- If the limit state is set to OFF, error -221 will be generated.

#### **:CALCulate2:LIMit:DISPlay GRAPH|NUMBER**

To execute the command for the display in number or graph, the display will show both result, number and graph.

#### **Return**

- A sequence of ASCII-encoded byte. GRAP means graphic and NUMB means numeric.

#### **:CALCulate2:LIMit:FAIL?**

Queries the status of the last measurement that was limit tested.

#### **Return**

- A single ASCII-encoded byte is returned. 0 means that the last measurement has passed the limit test, and 1 means that it failed the test.

### **Notes**

- If there is no valid measurement result, a "0" will be returned and error -230 will be generated.
- If this command is sent when limit test is on and a measurement is in progress, the response will not be available until the measurement is completed, and it also holds off the subsequent commands unless there is a device clear or a power cycle.
- If the current measurement function is Totalize or Voltage Peaks, a "0" will be returned and error -221 will be generated.

### **:CALCulate2:LIMit:FCOunt:LOWer?**

Queries the number of the measurement that fails the lower limit test.

### **Return**

- Numeric data transferred as ASCII bytes in <NR1> format.

### **Notes**

- If the limit test is off, a "0" will be returned and error -221 will be generated.
- If there is no valid measurement result, a "0" will be returned and error -230 will be generated.
- If the current measurement function is Totalize or Voltage Peaks, a "0" will be returned and error -221 will be generated.

### **:CALCulate2:LIMit:FCOunt[:TOTal]?**

Queries the total number of the measurement that fails the limit test.

### **Return**

- Numeric data transferred as ASCII bytes in <NR1> format.

### **Notes**

- If the limit test is off, a "0" will be returned and error -221 will be generated.
- If there is no valid measurement result, a "0" will be returned and error -230 will be generated.
- If the current measurement function is Totalize or Voltage Peaks, a "0" will be returned and error -221 will be generated.

### **:CALCulate2:LIMit:FCOunt:UPPer?**

Queries the number of the measurement that fails the upper limit test.

**Return**

- Numeric data transferred as ASCII bytes in <NR1> format.

**Notes**

- If the limit test is off, a "0" will be returned and error -221 will be generated.
- If there is no valid measurement result, a "0" will be returned and error -230 will be generated.
- If the current measurement function is Totalize or Voltage Peaks, a "0" will be returned and error -221 will be generated.

**:CALCulate2:LIMit:PCOunt[:TOTal]?**

Queries the total number of measurements that pass the limit test.

**Return**

- Numeric data transferred as ASCII bytes in <NR1> format.

**Notes**

- If the limit test is off, a "0" will be returned and error -221 will be generated.
- If there is no valid measurement result, a "0" will be returned and error -230 will be generated.
- If the current measurement function is Totalize or Voltage Peaks, a "0" will be returned and error -221 will be generated.

**:CALCulate2:LIMit:STATe <Boolean>**

Defines or queries the limit test state.

**Return**

- A single ASCII-encoded byte is returned. 0 means OFF and 1 means ON.

**Notes**

- This will be set to OFF after the counter has been turned off or a remote interface reset.
- The limit data and the :CALC2:LIM:FAIL, :CALC2:LIM:FCO and :CALC2:LIM:PCO information will be cleared.
- Sets the limit-detect output to the in-limit voltage level.

### **:CALCulate2:LIMit:LOWer[:DATA] <numeric value> [HZ|S|DEG]**

Sets or queries the lower limit in the limit test.

#### **Return**

- Numeric value transferred as ASCII bytes in <NR3> format with eleven significant digits.
- A fail will be returned if the result is less than the lower limit, but when the result is equal to the lower limit, the counter will not report a fail.

#### **Notes**

- The lower limit will be set to 0 after the counter has been turned off or a remote interface reset.
- Setting a new lower limit will clear the limit counts (:CALC2:LIM:FCO, :CALC2:LIM:PCO).
- If the limit testing is on (:CALC:MATH:STATe ON), user should consider the scaled and offset results when specifying the limit.

### **:CALCulate2:LIMit:UPPer[:DATA] <numeric value> [HZ|S|DEG]**

Sets or queries the upper limit in the limit test.

#### **Return**

- Numeric value transferred as ASCII bytes in <NR3> format with eleven significant digits.
- A fail will be returned if the result is greater than the upper limit, but when the result is equal to the upper limit, the counter will not report a fail.

#### **Notes**

- The upper limit will be set to 0 after the counter has been turned off or a remote interface reset.
- Setting a new upper limit will clear the limit counts (:CALC2:LIM:FCO, :CALC2:LIM:PCO).
- If the limit testing is on (:CALC:MATH:STATe ON), user should consider the scaled and offset results when specifying the limit.

## **The command :CALCulate3**

This group performs statistics calculation and data transfer.

### **:CALCulate3:AVERage:ALL?**

Queries all of the four statistics results: mean value, standard deviation, maximum value and minimum value.

#### **Return**

- Numeric data transferred as ASCII bytes in <NR3> format. The number of significant digits range from 1 to 15, depending on the resolution.

#### **Notes**

- The statistics operation should be enabled (:CALC3:AVER[:STATe] ON ) before using this command. If not, Not A Number 9.91E37 will be returned and error -221 will be generated.
- The result is separated by commas, and the display order is mean value, standard deviation, minimum value and then maximum value.
- If there is no valid result, Not A Number 9.91E37 will be returned and error -230 will be generated.
- If the current measurement operation is Totalize or Voltage Peaks, Not A Number 9.91E37 will be returned and error -221 will be generated.

### **:CALCulate3:AVERage:CLEar**

Clears the statistics data, sets the statistics counts to zero and reports the negative status condition to bit 8 of the Operation Status Register.

#### **Notes**

- If the statistics operation is not enabled (:CALC3:AVER[:STATe] OFF, error -221 will be generated.

### **:CALCulate3:AVERage:COUNT <numeric value>**

Sets or queries the number of measurement that to be used in the statistics operation. The range of this number is from 2 to 1,000,000.

#### **Return**

- Numeric data transferred as ASCII bytes in <NR1> format.

#### **Notes**

- This will be set to the counter's default, 100, after the counter has been turned off or a remote interface reset.

- When the specified number of measurement has been collected, another set of measurements has to be collected before the counter does another statistics calculation.

### **:CALCulate3:AVERAge:COUNT:CURRENT?**

Queries the number of measurement collected so far for statistics calculation. The range is from 0 to 1,000,000.

#### **Return**

- Numeric data transferred as ASCII bytes in <NR1> format.

#### **Notes**

- If the statistics operation is not enabled (:CALC3:AVER[:STATe] OFF, error -221 will be generated.
- If the current measurement operation is Totalize or Voltage Peaks, 0 will be returned and error -221 will be generated.

### **:CALCulate3:AVERAge[:STATe] <Boolean>**

Sets or queries the statistics operation state.

#### **Return**

- A single ASCII-encoded byte. 0 means OFF and 1 means ON.

#### **Note**

- This will be set to OFF after the counter has been turned off or a remote interface reset.

### **:CALCulate3:AVERAge:TYPE MAXimum|MINimum|SDEVIation|SCALar or MEAN**

Sets the statistical result for :CALC3:DATA? Command and display when :DISP[:WIND]:TEXT:FEED is set to "CALC3".

#### **Return**

- A sequence of ASCII-encoded bytes. There are MAX, MIN, SDEV, or MEAN.

#### **Note**

- This will be set to its default, MEAN, after the counter has been turned off or a remote interface reset.



### **:CALCulate3:DATA?**

Queries the statistical result selection made by :CALC3:AVER:TYPE command.

#### **Return**

- A result formatted by :FORMat[:DATA] ASCii|REAL command. If using the ASCII format, it returns numeric data transferred in <NR3> format. The number of significant digits will range from 1 to 15, depending on the resolution.

#### **Notes**

- Be sure to enable the statistics operation before query the result.
- If the statistics operation is not enabled (:CALC3:AVER[:STATe] OFF), or the current measurement function is Totalize or Voltage Peaks, Not A Number 9.91E37 will be returned and error -221 will be generated.
- If there is no valid result, Not A Number 9.91E37 will be returned and error -230 will be generated.
- The last calculated statistical result remains valid until a new calculation is made or a relevant instrument state is modified.

### **:CALCulate3:FEED "[[:]CALCulate[1]"**

Sets or queries the data flow to be fed into the CALCulate3 block.

#### **Return**

- The string "CALC" is returned.

### **:CALCulate3:LFILter:LOWer[:DATA] <numeric value> [HZ|S|DEG]**

Sets or queries the lower limit in statistics operation. The resolution is 11 digits and the range is from -9.9999990000E+12 to -1.0000000000E-13, 0.0000000000, and +1.0000000000E-13 to 9.9999990000E+12.

#### **Return**

- Numeric data transferred in ASCII bytes in <NR3> format with eleven significant digits.

#### **Notes**

- It will return to its power-on default, 0, after the counter has been turned off or a

remote interface reset.

- This command shares the same value with :CALC:LIM:LOW command.
- When limit filtering is enabled( :CALC:LFIL:STAT ON), any value lower than this value will not be used in the statistics calculation.
- If math operation is enabled(:CALC3:MATH:STATe ON), user should consider the scaled and offset measurement when specifying the limit.
- Setting a new lower limit will clear the limit counts (:CALC2:LIM:FCO, :CALC2:LIM:PCO).
- When the display is not able to show all of the significant digits of this value, the displayed value is different from the actual value because the displayed value has been rounded. But if you press ENTER while the number is still in display, the actual value will be updated to the value shown.

### **:CALCulate3:LFILter:UPPer[:DATA] <numeric value> [HZ|S|DEG]**

Sets or queries the upper limit in statistics operation. The resolution is 11 digits and the range is from -9.9999990000E+12 to -1.0000000000E-13, 0.0000000000, and +1.0000000000E-13 to 9.9999990000E+12.

### **Return**

- Numeric data transferred in ASCII bytes in <NR3> format with eleven significant digits.

### **Notes**

- It will return to its power-on default, 0, after the counter has been turned off or a remote interface reset.
- This command shares the same value with :CALC:LIM:UPP command.
- When limit filtering is enabled (:CALC:LFIL:STAT ON), any value higher than this value will not be used in the statistics calculation.
- If math operation is enabled (:CALC3:MATH:STATe ON), user should consider the scaled and offset measurement when specifying the limit.
- Setting a new upper limit will clear the limit counts (:CALC2:LIM:FCO, :CALC2:LIM:PCO).
- When the display is not able to show all of the significant digits of this value, the displayed value is different from the actual value because the displayed value has been rounded. But if you press ENTER while the number is still in display, the actual value will be updated to the value shown.

### **:CALCulate3:LFILter:STATe<Boolean>**

Sets or queries the state of the statistics filtering.

#### **Return**

- A single ASCII-encoded byte. 1 means ON and 0 means OFF.

#### **Notes**

- It will be returned to 0 after the counter has been turned off or a remote interface reset.
- When this is on, only the measurements (scaled and offset when math is on) within limits will be used in statistical calculation.

### **:CALCulate3:PATH?**

Queries the order in which CALCulate3 sub-blocks are to be processed.

#### **Return**

- A sequence of ASCII-encoded bytes: LFIL, AVER.

#### **Notes**

- For the counter, this sequence is fixed to be LFILter followed by AVERage.

## **The command :CALibration**

**:CALibration:SECurity:CODE<new code>**

Sets the security code for calibration. The range is from 0 to 99,999,999, and the resolution is 1. Default Security validate code is 6200.

#### **Note**

- The security code is stored in non-volatile memory and is unaffected by power-on, save/recall or \*RST.
- When the state is in the security code requirement, please input the correct code. After that, if you want to change the code please input a new one. Then, press the Enter button to store it.

**:CALibration:SECurity:STATe <Boolean>,<NRf>**

Sets or queries the security state of the calibration.

To unsecure the Counter for calibration, specify OFF with a valid security code. Once the Counter is unsecured, any calibration can be performed.

To secure the Counter, specify ON with a valid security code. When the Counter is secure against calibration, no calibration can be performed except for interpolator calibration.

### Return

- Single ASCII-encoded byte. 0 means the Counter is unsecure while 1 means the Counter is secure.

### Notes

- The security state is stored in non-volatile memory and is unaffected by power-on, save/recall or \*RST.
- The security code is set to 6200 when the Counter is shipped from the factory. If users forget the security code, they can use the **:CALibration:SECurity:CODE:RESet** command to recover to the default condition.

### **:CALibration:SECurity:CODE:RESet**

To prevent missing the user-defined code, and access the calibration mode quickly, users can execute the command to recover to the default condition.

### The Command **:CONFigure**

The commands **:CONFigure** and **:READ** offer more flexibility than the command **:MEASure**. It provides the configuration part of the measurement, but does not perform measurement nor query the result. When using the command **:CONFigure**, the Scale and Offset operation, statistics and limit-testing are all disabled. If an absolute trigger level is not specified in the <parameters>, auto-trigger and auto-trigger level will be enabled and set for all measurement function except Totalize and Voltage Peaks. Refer to (The Command **:MEASure**?) later in this section for the descriptions of the <parameters> and the <source list> for each function.

※Note: When you use this command, several default settings are automatically used. In order to switch to another function without changing the settings, use **[ :SENS]:FUNC[:ON]**

**:CONFigure[:SCALar]:<function> <parameters> [,<source\_list>]**

To perform the specified function without initiating the measurement, please use the

command `:INIT;FETC?` or `READ?` to make and query a measurement. Skipping the `<parameters>` and the `[,<source_list>]` will recover to the default condition.

### **:CONFigure?**

Queries the function configured by the last `:CONFigure` or `:MEASure` command.

#### **Return**

- A string with the form of "`<function> <parameter> [,<source list>]`" is returned.
- If there is not any specification before this query, an empty string is returned and an error -221,"Settings conflict" is generated.
- The response is unaffected by `*RST`, recall, or `[:SENS]:FUNC`.

#### **Note**

- Refer to (The Command `:MEASure?`) later in this section for the descriptions of the `<parameters>` and the `<source list>` for each function.

### **Device Clear**

Instructs the counter to clear the input buffer and Output Queue, resets the parser, execution control and response formatter. Clears any command that would prevent processing a command `*RST` or others. Disables the effect of previously executed the command `*OPC` and terminates the hold-off action of a `*WAI`, `*OPC?` Or data query (`:MEASure` query, `:READ` query, `:FETCh` query, `:CALC:DATA?`, `:CALC2:LIM:FAIL?`) waiting for pending operation to complete.

**Note:** Diagnostics or calibration initiated from front panel may be terminated if it is waiting for user input.

### **:DISPlay:ENABLE <Boolean>**

Sets or queries if the whole display is enabled.

#### **Return**

- A single ASCII-encoded byte. 0 means Disables and 1 means Enabled.

### Notes

- The display will be set back to Enabled after \*RST command.
- This value is unaffected by save&recall.

### **:DISPlay:MENU[:STATe] OFF**

Disables the menu display and shows the results. Response indicates whether menu or results is in display.

### Return

- A single ASCII-encoded byte. 0 means that the result display is in enabled and 0 means that the menu display is enabled.

### Notes

- The state of the display will be set back to OFF which means that the menu display is disabled and the result display is enabled after \*RST command.
- Use :SYST:KEY command or the front panel key to display the menu.
- This value is unaffected by save&recall.

### **:DISPlay[:WINDow]:TEXT:FEED "[[:]CALCulate2]"[:]CALCulate3"**

Sets or queries what data flow is fed into the display.

"[:]CALCulate2"---is used to direct any result other than statistics to the result display.

The result should be one of the following:

- Raw measurement result when the mathematical function is not enabled
- The scaled/offset measurement result when the mathematical function is enabled
- The limit graph when the limit testing is enabled and the graph mode is chosen.

"[:]CALCulate3"---is used to direct the statistics result to the result display. The particular statistic result displayed is determined by ::CALC3:AVER:TYPE.

### Return

- The string "CALC2" or "CALC3" is returned.

### Note

- This will be set back to "CALC2" after the \*RST command.

### **:DISPlay[:WINDow]:TEXT:RADix COMMa|DPOint**

Sets or queries the character used to separate integral and fractional portions of a displayed number.

When using COMMa, one thousand is displayed as 1.000,0, but 1,000.0 if you are using DPOint.

#### **Return**

- A sequence of ASCII-encoded byte: COMM or DPO.

#### **Note**

- This value is stored at non-volatile memory, so it will not change after the counter has been turned off, or after \*RST command or save&recall.

### **:FETCh[:SCALar]:<function>]**

This command queries the measurement taken by the command :INITiate (or :MEASure query or :READ?).

This command is the generic form of the Commands :FETCh?. Skipping the <function> and the <parameters> will instruct the counter to use the function specified by the last command :CONFigure, :MEASure, :READ, or :FETCh. When [:SCALar]:<function> is specified, the counter returns the specified result if it is consistent with the current measurement function or it can be derived from the current measurement function. The following table shows what functions can be derived from what functions.

Frequency ↔ Period
Voltage Peaks ↔ Voltage MAXimum
Voltage Peaks ↔ Voltage Minimum
Voltage Peaks ↔ Voltage CENTER
Voltage Maximum ↔ Voltage Peaks
Voltage Minimum ↔ Voltage Peaks
Voltage CENTER ↔ Voltage Peaks

For more information about <function> options, please refer to the table in Chapter 5.4.

#### **Return**

- Results will be formatted according to :FORMat[:DATA] ASCii|REAL specification.
- If choosing the ASCii format, numeric data is transferred as ASCII bytes in

<NR3> format. The number of significant digits ranges from 1 to 5 depending on the resolution.

- If there is no valid result, Not a Number 9.91E37 is returned and error -230 is generated.
- When an automatically armed Totalize measurement is in progress, sending a :FETCh? Command will cause error -221 and Not a Number 9.91E37 will be returned. To avoid this error, use :ABORt to terminate the measurement first.

#### **Note**

- Sending this command while a measurement is in progress will hold off further commands from being executed until the current measurement completes. However, you can use Device Clear or power-on to cancel this hold-off effect.

#### **:FORMat[:DATA] ASCii|REAL**

Sets or queries the format type of the data.

When choosing ASCii type, numeric data is transferred as ASCII bytes in <NR3> format. The numbers are separated by commas as specified in IEEE488.2. When there is no response data, Not A Number 9.91E37 will be returned.

When choosing REAL type, response data is transferred in a <definite length block> as a 64-bit IEEE754 floating point number. Not a Number 9.91E37 will be returned in the <definite length block> if there is no response data.

#### **Return**

- A sequence of ASCII-encoded bytes: ASCii or REAL.

#### **Notes**

- The format type of the data will be set back to ASCii after \*RST command.
- This command controls the response data type of the following commands:
  - :CALCulate:DATA?
  - :CALCulate3:DATA?
  - :FETCh?
  - :MEASure query
  - :READ?
  - [:SENSe]:DATA?
  - :TRACe[:DATA] query



**:INITiate:AUTO <Boolean>**

Sets or queries whether the counter stops or goes on measuring when a measurement exceeds the specified limits.

AUTO OFF instructs the counter to stop measuring when a measurement exceeds the limits and AUTO ON (set :INIT:CONT to OFF) instructs the counter to keep measuring even if the measurement fails the limit test.

**Return**

- A single ASCII-encoded byte. 0 means AUTO OFF and 1 means AUTO ON.

**Note**

- This will be set back to AUTO OFF after \*RST command.

**:INITiate:CONTinuous <Boolean>**

Sets or queries the enable for initiating measurements continuously.

When the CONTinuous is set to ON, the measurements are initiated continuously, when the CONTinuous is set to OFF, the counter does not issue any measurement until it receives :INITiate[:IMMediate] command or CONTinuous is set to ON.

**Return**

- A single ASCII-encoded byte. 0 means CONTinuous OFF and 1 means CONTinuous ON.

**Notes**

- This will be set back to CONTinuous OFF after \*RST command.
- When :INIT:CONT ON command is sent, the counter
  - Invalidates the statistics results,
  - Clears the current statistics count to 0,
  - Reports the negative status condition (NOT computing statistics) to bit 8 of Operation Status Register.
- When :CALC2:LIM:CLE:AUTO is ON and whenever the counter receives :INIT:CONT ON command, it :
  - Invalidates the limit data,
  - Clears the pass and fail counts (:CLAC2:LIM:FCO and :CALC2:LIM:PCO) in the limit testing.

- Sets the Limit-Detect output to the in-limit voltage level.
- When [:SENSe]:EVEN:LEV[:ABS]:AUTO is ON and :INIT:CONT ON command is sent, the counter issues an auto-trigger on the source channel and at the beginning of each measurement cycle while :INIT:CONT is ON.
- The state of :TRIG:COUN:AUTO has no affect on the operation of :INIT:CONT ON.
- :INIT:CONT ON operates as if :TRIG:COUN was 1.
- The beginning of the first measurement caused by setting :INIT:CONT ON sets the pending Operation Flag to true. The pending Operation Flag is set to false by aborting of a measurement, or by the completion of the last measurement after :INIT:CONT is set to OFF.
- When the measurements are being made continuously, :ABORt command will terminate the measurement in progress, but does not change the value of :INIT:CONT. If :INIT:CONT is set to ON prior to :ABORt, it remains ON and a new measurement is initiated.
- When a single measurement is in progress (:INIT:CONT is OFF):
  - Error -213 (Init ignored) is generated and the state if INIT:CONT is unaffected by :INIT:CONT ON.
  - Error -210 (Trigger error) is generated by :INIT:CONT OFF.
- The :INIT:CONT will be set to ON after the counter has been turned off, but set to OFF after \*RST command.

### **:INITiate[:IMMediate]**

Instructs the counter to initiate a single measurement or a specified number of measurements.

The counter will initiate one single measurement when

:TRIG:COUN:AUTO is OFF

or

:CALC3:AVER[:STAT] is OFF

or

[:SENS]:FUNC[:ON] is Totalize

or

[:SENS]:FUNC[:ON] is any Voltage Peaks.

The counter will initiate a complete block of measurements when

:TRIG:COUN:AUTO is ON

And

:CALC3:AVER[:STAT] is ON

And

`[:SENS]:FUNC[:ON]` is not Totalize or Voltage Peaks.

See `:TRIG:COUN:AUTO` for specifics.

### Notes

- When `:TRIG:COUN:AUTO` and `:CALC3:AVER[:STAT]` are both ON, the counter clears the statistics results and the current count when it receives `:INIT[:IMM]`.
- When `:CALC2:LIM:CLE:AUTO` is ON and whenever the counter receives `:INIT:CONT ON` command, it :
  - Invalidates the limit data,
  - Clears the pass and fail counts (`:CALC2:LIM:FCO` and `:CALC2:LIM:PCO`) in the limit testing.
  - Sets the Limit-Detect output to the in-limit voltage level.
- When `[:SENSe]:EVEN:LEV[:ABS]:AUTO` is ON and `:INIT[:IMM]` command is sent, the counter issues an auto-trigger on the source.
- If the counter is in the process of making a measurement or if `:iNItiate:CONTinuous` is set to ON, an `:IMMediate` command has no effect, and error -231 (Init ignored) is generated.
- Beginning a measurement or block of measurements with an `:INIT[:IMM]` sets the pending Operation Flag to true. Completing the measurement or block of measurements (normally or by aborting) sets Pending Operation Flag to false.
- For an automatically armed Totalize measurement, use `:ABORt` to terminate the measurement initiated with `:INIT[:IMM]`.

### **`:INPut[1|2]:ATTenuation 1|10`**

Sets or queries the input attenuation.

### Return

- Numeric data transferred as ASCII bytes in `<NR1>` format.

### Note

- The input attenuation is set to X1 after `*RST` command.

### **`:INPut[1|2]:COUPling AC|DC`**

Sets or queries the input coupling.

**Return**

- A sequence of ASCII-encoded bytes: AC or DC.

**Note**

- The input coupling is set to AC after \*RST command.

**:INPut[1|2]:FILTer[:LPASs][:STATe] <Boolean>**

Sets or queries the state of the low-pass filter.

**Return**

- A single ASCII-encoded byte. 0 means OFF and 1 means ON.

**Note**

- This will be set to OFF after \*RST command

**:INPut[1|2]:FILTer[:LPASs]:FREQuency?**

Queries the cut-off frequency of the low-pass filter.

**Return**

- Numeric data transferred as ASCII bytes in <NR3> format with six significant digits.
- A value of 100E+3 is returned.

**:INPut[1|2]:IMPedance <numeric value> [OHM]**

Sets or queries the input impedance. It is either 50Ω or 1MΩ.

**Return**

- Numeric data transferred as ASCII bytes in <NR3> format with six significant digits.

**Note**

- The input impedance will be set to 1E6 OHM after \*RST command.

**:INPut3:COUPling?**

Queries the channel 3 input coupling.

## Return

- A sequence of ASCII-encoded bytes:AC.

## **:INPut3:IMPedance?**

Queries the channel 3 input impedance.

## Return

- Numeric data transferred as ASCII bytes in <NR3> format with six significant digits.
- The value returned is 50.

## **The Commands :MEASure?**

The command :MEASure is the simplest way to make a measurement. It configures the counter, initiates the measurement and queries the result all in one command.

**:MEASure[:SCALar]:<function>? <parameters> [,<source\_list>]**

The above command is the generic form of the :MEASure? Commands. Skipping the <function> and the <parameters> will instruct the counter to use defaults. The description of each command :MEASure? is listed below.

**:MEASure[:SCALar][:VOLTage]:DCYcle? [<reference>][,(@1)]**

Sets the measurement arming to "auto" and measures Duty Cycle with the specified parameters.

The <reference> specifies the point on the pulse where the duty cycle is determined, and it can be specified as either a percentage or an absolute voltage. The default is in percentage.

The <reference> parameter is used to configure the trigger setting. When it is specified in percentage or default, auto-trigger is enabled and trigger level is the specified value. When it is specified in voltage, auto-trigger is disabled and the trigger level is the specified value.

<reference>	default	50 pct
	Percent range	0 to 100 pct
	Percent resolution	10%

	Voltage range	-5.125V to 5.125V for ×1 attenuation -51.25V to 51,25V for ×10 attenuation
	Voltage resolution	0.0025V for ×1 attenuation 0.025V for ×10 attenuation
<source list>	default	(@1)
	range	(@1)

**:MEASure[:SCALar][:VOLTage]:FALL:TIME?**

**[<lower\_reference> [,upper\_reference>]][,(@1)]**

Sets the measurement arming to "auto" and measures Fall Time with the specified parameters.

The <lower\_reference> and <upper\_reference> are used to specify the lower and upper points on the falling edge of the input signal. They can be specified as either a percentage or an absolute voltage.

The <lower\_reference> and <upper\_reference> are used to configure the trigger setting. When they are in percentage or defaults, auto-trigger is enabled and trigger level is the specified value. When they are specified in voltage, auto-trigger is disabled and the trigger level is the specified value.

<lower_reference>	default	10 pct
	Percent range	0 to 100 pct
	Percent resolution	10%
	Voltage range	-5.125V to 5.125V for ×1 attenuation -51.25V to 51,25V for ×10 attenuation
	Voltage resolution	0.0025V for ×1 attenuation 0.025V for ×10 attenuation
<upper_reference>	default	90 pct
	Percent range	0 to 100 pct
	Percent resolution	10%
	Voltage range	-5.125V to 5.125V for ×1 attenuation -51.25V to 51,25V for ×10 attenuation
	Voltage resolution	0.0025V for ×1 attenuation 0.025V for ×10 attenuation
<source list>	default	(@1)
	range	(@1)

**:MEASure[:SCALar][:VOLTage]:RISE:TIME?**

**[<lower\_reference> [,upper\_reference>]][,(@1)]**

Sets the measurement arming to "auto" and measures Rise Time with the specified

parameters.

The <lower\_reference> and <upper\_reference> are used to specify the lower and upper points on the falling edge of the input signal. They can be specified as either a percentage or an absolute voltage.

The <lower\_reference> and <upper\_reference> are used to configure the trigger setting. When they are in percentage or defaults, auto-trigger is enabled and trigger level is the specified value. When they are specified in voltage, auto-trigger is disabled and the trigger level is the specified value.

<lower_reference>	default	10 pct
	Percent range	0 to 100 pct
	Percent resolution	10%
	Voltage range	-5.125V to 5.125V for ×1 attenuation -51.25V to 51,25V for ×10 attenuation
	Voltage resolution	0.0025V for ×1 attenuation 0.025V for ×10 attenuation
<upper_reference>	default	90 pct
	Percent range	0 to 100 pct
	Percent resolution	10%
	Voltage range	-5.125V to 5.125V for ×1 attenuation -51.25V to 51,25V for ×10 attenuation
	Voltage resolution	0.0025V for ×1 attenuation 0.025V for ×10 attenuation
<source list>	default	(@1)
	range	(@1)

#### **:MEASure[:SCALar][:VOLTage]:FREQUency?**

**[<expected\_value> [,<resolution>]][,(@1)|(@2)|(@3)]**

Sets the measurement arming to “digits” and measures the frequency.

The <expected value> and <resolution> parameters are used to configure the number of digits of resolution arming setting.

The Channel 1 and Channel 2 share the same trigger setting so that the measurement channel has auto-trigger enabled at 50% with a positive slope.

<expected value> Ch1, Ch2	default	10 MHz
	Range	0.100 Hz to 400 MHz
	Resolution	<expected value> should be within 10% of input frequency for optimum arming configuration
<expected value>	Default	500 MHz

Ch3	Range	375 MHz to 6GHz
	Resolution	<expected value> should be within 10% of input frequency for optimum arming configuration
<resolution> Ch1, Ch2	Default	Value which indicates 4 digits of resolution for the specified <expected value>
	Range	1E-16 Hz ~ 1E6 Hz (15 to 3 digits of resolution)
	Resolution	<resolution> should use a mantissa of 1.0 and be an even power of 10
<resolution> Ch3	Default	Value which indicates 4 digits of resolution for the specified <expected value>
	Range	1E-7 Hz ~ 1E7 Hz (15 to 3 digits of resolution)
	Resolution	<resolution> should use a mantissa of 1.0 and be an even power of 10
<source list>	Default	(@1)
	Range	(@1 @2 @3)

**:MEASure[:SCALar][:VOLTage]:FREQuency:RATio?**

**[<expected\_value> [,<resolution>]][,(@1),(@2)](@1),(@3)[(@2),(@1)](@3),(@1)]**

Sets the measurement arming to "digits" and measures the frequency ratio between two inputs. The <expected value> and <resolution> parameters are used to configure the number of digits of resolution arming setting.

<expected value>	<b>default</b>	1
	<b>Range Ch1/Ch2, Ch1/Ch3</b>	1E-10 to 1E11
	<b>Range Ch2/Ch1, Ch3/Ch1</b>	1E-11 to 1E10
	<b>Resolution</b>	<expected value> should be within 10% of ratio for optimum arming configuration
<resolution>	<b>Default</b>	Value which indicates 4 digits of resolution for the specified <expected value>
	<b>Range Ch1/Ch2, Ch1/Ch3</b>	1E-25 ~ 1E8 (15 to 3 digits of resolution)
	<b>Range Ch2/Ch1, Ch3/Ch1</b>	1E-26 ~ 1E7 (15 to 3 digits of resolution)



	<b>Resolution</b>	<resolution> should use a mantissa of 1.0 and be an even power of 10
<b>&lt;source list&gt;</b>	<b>Default</b>	(@1,@2)
	<b>Range</b>	(@1,@2) (@1,@3) (@2,@1) (@3,@1)

**:MEASure[:SCALar][:VOLTage]:MAXimum? [(@1)|(@2)]**

Measures voltage maximum.

<b>&lt;source list&gt;</b>	<b>Default</b>	(@1)
	<b>Range</b>	(@1) (@2)

**:MEASure[:SCALar][:VOLTage]:MINimum? [(@1)|(@2)]**

Measures voltage minimum.

<b>&lt;source list&gt;</b>	<b>Default</b>	(@1)
	<b>Range</b>	(@1) (@2)

**:MEASure[:SCALar][:VOLTage]:NWIDTH? [<reference>][,(@1)]**

Sets the measurement arming to "auto" and measures negative pulse width.

The <reference> specifies the point on the pulse where the negative pulse width is determined.

This point can be specified in percentage or in voltage. The default unit is percent.

The <reference> parameter is used to configure the trigger setting. When it is specified in percentage or default, auto-trigger is enabled and trigger level is the specified value. When it is specified in voltage, auto-trigger is disabled and the trigger level is the specified value.

<b>&lt;reference&gt;</b>	default	50 pct
	Percent range	0 to 100 pct
	Percent resolution	10%
	Voltage range	-5.125V to 5.125V for ×1 attenuation -51.25V to 51.25V for ×10 attenuation
	Voltage resolution	0.0025V for ×1 attenuation 0.025V for ×10 attenuation
<b>&lt;source list&gt;</b>	default	(@1)
	range	(@1)

**:MEASure[:SCALar][:VOLTage]:PWIDTH? [<reference>][,(@1)]**

Sets the measurement arming to "auto" and measures positive pulse width.

The <reference> specifies the point on the pulse where the positive pulse width is determined.

This point can be specified in percentage or in voltage. The default unit is percent.

The <reference> parameter is used to configure the trigger setting. When it is specified in percentage or default, auto-trigger is enabled and trigger level is the specified value. When it is specified in voltage, auto-trigger is disabled and the trigger level is the specified value.

<reference>	default	50 pct
	Percent range	0 to 100 pct
	Percent resolution	10%
	Voltage range	-5.125V to 5.125V for ×1 attenuation -51.25V to 51,25V for ×10 attenuation
	Voltage resolution	0.0025V for ×1 attenuation 0.025V for ×10 attenuation
<source list>	default	(@1)
	range	(@1)

**:MEASure[:SCALar][:VOLTage]:PERiod? [<expected\_value> [,<resolution>]]  
[,@1)|(@2)|(@3)]**

Sets the measurement arming to “digits” and measures the period.

The <expected value> and <resolution> parameters are used to configure the number of digits of resolution arming setting.

The Channel 1 and Channel 2 share the same trigger setting so that the measurement channel has auto-trigger enabled at 50% with a positive slope.

<b>&lt;expected value&gt; Ch1, Ch2</b>	<b>Default</b>	100 ns
	<b>Range</b>	2 ns ~ 10 sec
	<b>Resolution</b>	<expected value> should be within 10% of the input period for optimum arming configuration
<b>&lt;expected value&gt; Ch3</b>	<b>Default</b>	<b>2 ns</b>
	<b>Range</b>	0.17 ns ~ 2.67 ns
	<b>Resolution</b>	<expected value> should be within 10% of the input period for optimum arming configuration
<b>&lt;resolution&gt; Ch1, Ch2</b>	<b>Default</b>	Value which indicates 4 digits of resolution for the specified <expected value>
	<b>Range</b>	1E-23 ~ 1E-2 sec (15 to 3 digits of resolution)
	<b>Resolution</b>	<resolution> should use a mantissa of 1.0 and be an even power of 10
<b>&lt;resolution&gt; Ch3</b>	<b>Default</b>	Value which indicates 4 digits of resolution for the specified <expected value>
	<b>Range</b>	1E-24 ~ 1E-11 sec (15 to 3 digits of resolution)

	<b>Resolution</b>	<resolution> should use a mantissa of 1.0 and be an even power of 10
<b>&lt;source list&gt;</b>	<b>Default</b>	(@1)
	<b>Range</b>	(@1)(@2)(@3)

**:MEASure[:SCALar][:VOLTage]:PHASe? [(@1),(@2)]**

Sets the measurement arming to "auto" and measures Phase.

The Channel 1 and Channel 2 share the same trigger setting so that the measurement channel has auto-trigger enabled at 50% with a positive slope.

<b>&lt;source list&gt;</b>	<b>Default</b>	(@1),(@2)
	<b>Range</b>	(@1),(@2)

**:MEASure[:SCALar][:VOLTage]:PTPeak? [(@1)|(@2)]**

Makes Peak-to-Peak measurement.

<b>&lt;source list&gt;</b>	<b>Default</b>	(@1)
	<b>Range</b>	(@1) (@2)

**:MEASure[:SCALar][:VOLTage]:CENTer? [(@1)|(@2)]**

Measures center voltage.

<b>&lt;source list&gt;</b>	<b>Default</b>	(@1)
	<b>Range</b>	(@1) (@2)

**:MEASure[:SCALar][:VOLTage]:TINterval? [(@1),(@2)]**

Measures Time Interval.

The first channel is the start channel and the second channel is the stop channel.

The Channel 1 and Channel 2 share the same trigger setting so that the measurement channel has auto-trigger enabled at 50% with a positive slope.

The measurement arming is set to "auto" with no delay. The input routing is coupled to separate inputs.

<b>&lt;source list&gt;</b>	<b>Default</b>	(@1),(@2)
	<b>Range</b>	(@1),(@2)

**:MEASure[:SCALar][:VOLTage]:TOTalize:TIMed? [<gate\_time>][,(@1)]**

Makes Totalize measurement during the specified <gate\_time>.

The trigger settings are coupled so that the measurement channel has auto-trigger disabled with a positive slope.

<b>&lt;gate time&gt;</b>	<b>Default</b>	0.1 sec
--------------------------	----------------	---------

	<b>Range</b>	1E-3 to 1,000 sec
	<b>Resolution</b>	1E-5 sec
<b>&lt;source list&gt;</b>	<b>Default</b>	(@1)
	<b>Range</b>	(@1)

### **:MEMory:NStates?**

Queries the number of available \*SAV/\*RCL states in the counter.

#### **Return**

- Numeric data transferred as ASCII bytes in <NR1> format, which is 21.
- The response is one greater than the maximum which can be sent as a parameter to the \*SAV and \*RCL commands.

### **:READ[[:SCALar]:<function>]?**

The command is usually used with a :CONFigure command to make measurements like Command :MEASure?. User can specify individual setting for their measurements by adding setting specification commands between them. This command is the generic form of the Command :READ?. Skipping the <function> and the <parameters> will instruct the counter to use the function specified by the last command :CONFigure, :MEASure, :READ, or :FETCh. When [[:SCALar]:<function> is specified, the counter returns the specified result if it is consistent with the current measurement function or it can be derived from the current measurement function. Refer to Commands :FETCh? in this section for the derivability of functions.

#### **Return**

- Result will be formatted according to :FORMat[:DATA] ASCii|REAL setting.
- If using ASCii format, numeric data is transferred as ASCII bytes in <NR3> format with 1 to 5 significant digits depending on the resolution.

#### **Notes**

- Sending this command while a measurement is in progress will terminate the current measurement, idle the measurement cycle before initiating the desired measurement and waits for the measurement to complete. It holds off further commands from being executed until the current measurement completes. However, you can use Device Clear or power-on to cancel this hold-off effect.

- When an automatically armed Totalize measurement is in progress, sending a :READ? Command will cause error -221 and Not a Number 9.91E37 will be returned. Use :INItiate to begin the measurement and :ABORt to end it; :FETCh? should be used to retrieve the terminated measurement result.

## The Command :SENSe

**[[:SENSe]DATA? [[:SENSe[1]]]**

Queries the current measurement results of the :SENSe commands (no scale or offset applied).

### Return

- Result is formatted according to :FORMat[:DATA] ASCii|REAL command.

### Notes

- If using the ASCii format, numeric data is transferred as ASCII bytes in <NR3> format. The number of significant digits ranges from 1 to 10 depending on the resolution.
- If there is no valid measurement result, Not A Number 9.91E37 will be returned and error -230 will be generated.
- If this command is executed while a measurement is in progress, the prior measurement result will be returned.
- If this command is executed while an automatically armed Totalize measurement is in progress, Not A Number 9.91E37 will be returned and error -221 will be generated. User should send :ABORt command to abort the measurement so that the error can be avoided.

**[[:SENSe]EVENT2:FEED [[:INPut[1]][:INPut2]]**

Sets or queries the state of the common/separate.

### Return

- The string "INP" or "INP2" is returned.

### Notes

- This will be set to its default, which is "INP2", after the counter has been turned off or after a remote interface reset.
- All functions but Time Interval allow fixed input route setting.

**[[:SENSe]EVENT[1|2]:HYSTeresis:RELative <numeric value> [PCT]**

Sets or queries the size of the hysteresis window as a percentage of the allowable hysteresis. For example, 0% is for the minimum hysteresis setting and 100% is for the maximum. Specifying 100% or MAXimum provides the greatest noise immunity (lowest sensitivity), while specifying 0% or MINimum provides the least noise immunity.

**Return**

- The "100", "50" or "0" PCT is returned.

**Note**

- As the command \*RST is executed, the noise immunity will be set to 50 PCT.

**[[:SENSe]EVENT[1|2]:LEVel[:ABSolute] <numeric value> [V]**

Sets or queries the level of the center of the hysteresis window. The range is -5.125 to 5.125 volts for X1 attenuation and -51.25 to 51.25 volts for X10 attenuation. The resolution is 0.0025V for X1 attenuation and 0.025V for X10 attenuation.

**Return**

- Numeric data transferred as ASCII bytes in <NR3> format with six significant digits.

**Note**

- Sending this command disables [[:SENS]:EVEN[1|2]:LEV:AUTO

**[[:SENSe]EVENT[1|2]:LEVel[:ABSolute]:AUTO <Boolean>**

Sets or queries the state of the auto-triggering.

When auto-triggering is enabled, the counter automatically measures and computes the trigger level according to the percentage specified by the command [[:SENS]:EVEN[1|2]:LEV:REL. Also the counter measures and computes trigger level each time :INIT or :INIT:COUNT ON command is sent.

When the auto-triggering is on, the counter checks for each measurement if the measurement signal is triggering, and the counter will measure and compute a new trigger level if no triggering is found.

**Return**

- A single ASCII-encoded byte. 0 means OFF and 1 means ON.

**Notes**

- This will be set to ON after the counter has been turned off or a remote interface reset.
- Specifying a trigger level by using the command `[:SENS]:EVEN[1 | 2]:LEV[:ABS]` to disable auto-triggering.

#### **[:SENSe]EVENT[1 | 2]:LEVel:RELative <numeric value> [PCT]**

Sets or queries the percentage of the peak-to-peak range of the signal at which the instrument automatically triggers. The range is from 0 to 100 PCT, and the resolution is 10 PCT.

The counter automatically measures and computes the trigger level according to the percentage specified by the command `[:SENS]:EVEN[1 | 2]:LEV:REL` when it receives this command.

#### **Return**

- Numeric data transferred as ASCII bytes in `<NR1>` format.

#### **Notes**

- This will be reset to 50 PCT after the counter has been turned off or a remote interface reset.
- This command only applies when `[:SENS]:EVEN[1 | 2]:LEV[:ABS]:AUTO` is ON

#### **[:SENSe]EVENT[1 | 2]:SLOPe POSitive|NEGative**

Sets or queries which edge of the input signal will be considered an event when the counter measures frequency, period, **frequency ratio**, **time interval**, totalize or **phase**.

If specifying the positive slope, a signal ascending from a lower voltage to a higher voltage will define an event at the upper hysteresis limit, on the other hand, if specifying the negative slope, a signal descending from a higher voltage to a lower voltage will define an event at the lower hysteresis limit.

#### **Return**

- A sequence of ASCII-encoded bytes, POS or NEG.

#### **Notes**

- This will be set to Positive after the counter has been turned off or a remote interface reset.
- The slope specified here is irrelevant from to the ones used in Rise/Fall Time, Duty Cycle and Pulse Width measurements.

### **[[:SENSE]EVENT3:LEVEL[:ABSOLUTE]?**

Queries the channel 3 trigger level.

#### **Return**

- Numeric data transferred as ASCII bytes in <NR3> format with six significant digits in volts as units.

#### **Note**

- The returned value is 0, and the unit is volts.

### **[[:SENSE]EVENT3:SLOPE?**

Queries which edge of channel 3 is used to define an event.

#### **Return**

- A sequence of ASCII-encoded bytes, POS.

Sets or queries Gate for Period, frequency and frequency ratio measurements. For more information about the front panel gating settings and the interface command parameters, please refer to the **FREQ** table in Chapter 5.4.

### **[[:SENSE]:FREQUENCY:ARM[:START]:SLOPE POSITIVE | NEGATIVE**

Sets or queries the slope of the external start arm signal used in external arming for Period, frequency and frequency ratio measurements.

#### **Return**

- A sequence of ASCII-encoded bytes. POS mean positive and NEG means negative.

#### **Notes**

- This will be set to Positive after the counter has been turned off or a remote interface reset.
- This command only applies when [[:SENSE]:FREQ:ARM[:STAR]:SOUR EXT is used.

### **[[:SENSE]:FREQUENCY:ARM[:START]:SOURCE IMMEDIATE | EXTERNAL**

Sets or queries the start arm for period, frequency and frequency ratio measurements.

#### **Return**



- A sequence of ASCII-encoded bytes. IMM means Immediate and EXT means External.

#### Note

- This will be set to Immediate after the counter has been turned off or a remote interface reset.

#### **[[:SENSE]:FREQUENCY:ARM:STOP:DIGITS <Numeric value>**

Sets or queries the resolution in terms of digits used in arming Period, Frequency and frequency ratio measurements.

#### Return

- Numeric data transferred as ASCII bytes in <NR1> format, and the range of the resolution is 3 to 15.

#### Notes

- This will be set to 4 after the counter has been turned off or a remote interface reset.
- This command only applies when [[:SENSE]:FREQ:ARM:STOP:SOUR DIG] is used.

#### **[[:SENSE]:FREQUENCY:ARM:STOP:SLOPE POSITIVE | NEGATIVE]**

Sets or queries the slope of the external stop arm signal used in external arming for Period, frequency and frequency ratio measurements.

#### Return

- A sequence of ASCII-encoded bytes. POS means Positive and NEG means Negative.

#### Notes

- This will be set to Negative after the counter has been turned off or a remote interface reset.
- This command only applies when [[:SENSE]:FREQ:ARM:STOP:SOUR EXT] is used.

#### **[[:SENSE]:FREQUENCY:ARM:STOP:SOURCE IMMEDIATE | EXTERNAL | TIMER | DIGITS]**

Sets or queries the stop arm for Period, Frequency and Frequency ratio measurements.

#### Return

- A sequence of ASCII-encoded bytes. IMM means Immediate, EXT means External,

TIM means Timer and DIG means Digits.

**Note**

- This will be set to Timer after the counter has been turned off or a remote interface reset.

**[[:SENSE]:FREQUENCY:ARM:STOP:TIMER <numeric value> [S]**

Sets or Queries the gate time used in arming Period, Frequency and Frequency ratio measurements. The range for the mentioned measurements is 1E-3 to 1,000 seconds and the resolution is 0.01E-3 seconds. But users have to note that the range for the Frequency ratio is 1E-3 to 200 seconds.

**Return**

- Numeric data transferred as ASCII bytes in <NR3> format with six significant digits.

**Notes**

- This will be set to the value of 0.1 second after the counter has been turned off or a remote interface reset.
- This command only applies when [[:SENSE]:FREQ:ARM:STOP:SOUR TIM is used.

**[[:SENSE]:FREQUENCY:EXPECTED[1 | 2 | 3] <numeric value> [HZ]**

Sets or queries the approximate value of the frequency for the input signal in Frequency, Period, Frequency ratio, Phase and Duty cycle measurements. The frequency range is 0.001 to 400E6 Hz for channel 1 and 2, 375E6 to 6E9 Hz for channel 3 and 250E6 to 20E9 Hz for channel 3 (option 02).

**Return**

- Numeric data transferred as ASCII byte in <NR3> format with fifteen significant digits.

**Notes**

- This actual result must be within 10% of this approximate value.
- Providing this value will shorten the preparation time, accelerate the measurements and help get more accurate results.
- When [[:SENS]:FREQ:EXP[1 | 2 | 3] is ON, Not A Number 9.91E37 will be returned and error -221 will be generated.
- Save/recall operation does not apply on this value.

### **[[:SENSe]:FREQUency:EXPEcted[1 | 2 | 3]:AUTO ON**

Configures the counter to determine the frequency of the input signal as a pre-measurement step for Period, Frequency, Phase, Duty cycle and Frequency ratio measurements. It also queries the state of this pre-measurement.

#### **Return**

- Single ASCII-encoded byte. 0 means OFF and 1 means ON.

#### **Notes**

- This will be set to ON after the counter has been turned off or a remote interface reset.
- Enabling the auto mode will clear the previously-specified value of approximate frequency if any.
- The only way to disable this is to set a approximate value for the frequency using the [[:SENSe]:FREQUency:EXPEcted[1 | 2 | 3] <numeric value> [HZ] command.
- Save/recall operation does not apply on this value.

### **[[:SENSe]:FUNctioN[:ON] <sensor function>**

Sets or queries the <sensor function> which will be sensed by the counter.

These are the <sensor function>s:

"[:][XNOnE:]DCYCLe[1]" or "[:][XNOnE:]PDUTYcycle[1]"

"[:][XNOnE:]FALL:TIME[1]" or "[:][XNOnE:]FTIME[1]"

"[:][XNOnE:]RISE:TIME[1]" or "[:][XNOnE:]RTIME[1]"

"[:][XNOnE:]FREQUency[1 | 2 | 3]"

"[:][XNOnE:]FREQUency:RATio[1,2 | 2,1 | 1,3 | 3,1]"

"[:][XNOnE:]PERiod[1 | 2 | 3]"

"[:][XNOnE:]PHASe[1,2]"

"[:][XNOnE:]NWIDth[1]"

"[:][XNOnE:]PWIDth[1]"

"[:][XNOnE:]TINterval[1,2]"

"[:][XNOnE:]TOTalize[1]"

"[:][XNOnE:]VOLTage:PTPeak[1 | 2]"

"[:][XNOnE:]VOLTage:MAXimum[1 | 2]"

"[:][XNOnE:]VOLTage:MINimum[1 | 2]"

"[:][XNOnE:]VOLTage:CENTer[1 | 2]"

#### **Return**

- "<function> <channel> [,<channel>]" string is returned.

### Notes

- This will be set back to default, which is "FREQuency 1" after the counter has been turned off or after a remote interface reset.
- If the specified channel is the default channel, the returned string will skip it, and it is shown only when the specified channel is not the default channel. For instance, if the sensor function is frequency on channel 1, the returned string will be "FREQ". If the sensor function is frequency on channel 2, then the string "FREQ 2" will be returned.
- When the optional channel specification is skipped, the counter will automatically choose to use the default channel, which is channel 1 for Frequency, Period, Rise/Fall time, Duty Cycle, Pulse width, Totalize and Voltage Peaks measurements, and channel 1 to channel2 for Time Interval, Frequency Ratio and Phase measurements.
- When the sensor function is Totalize, Voltage Maximum, Voltage Minimum or Voltage Peaks, use [:INIT]:IMM to initiate a single measurement.
- When sensor function is set to Rise Time, the trigger level for channel 1 is set to 10% and the trigger level for channel 2 is set to 90%. When the sensor function is set to Fall time, the trigger level for channel 1 is set to 90% and the trigger level for channel 2 is set to 10%. The auto-triggering is enabled in both cases.
- When the sensor function is set to Pulse Width or Duty Cycle, the trigger levels for both channel 1 and channel 2 are set to 50%. The auto-triggering is enabled.
- When the sensor function is set to [:][TINTerval[1,2], the input routing is set to separate ([:SENSe]:EVEN2:FEED "INP2"). Use [:SENS]:EVEN2:FEED "INP1" to select common-mode Time Interval.
- This command does not affect :FETCh?, READ?, or CONFigure?.

Sets or queries Gate for Phase measurements. For more information about the front panel gating settings and the interface command parameters, please refer to the PHASE table in Chapter 5.4.

### **[:SENSe]:PHASe:ARM[:START]:SLOPe POSitive | NEGative**

Sets or queries the slope of the external start arm signal used in external arming Phase measurements.

### Return

- A sequence of ASCII-encoded bytes. POS means Positive and NEG means Negative.

### Notes

- This will be set to Positive after the counter has been turned off or a remote interface reset.
- This command only applies when the command [:SENS]:PHAS:ARM[:STAR]:SOUR EXT is used.

### **[:SENSe]:PHASe:ARM[:STARt]:SOURce IMMEDIATE | EXTERNAL**

Sets or queries the start arm for Phase measurements.

### Return

- A sequence of ASCII-encoded bytes. IMM means Immediate and EXT means External.

### Note

- This will be set to Immediate after the counter has been turned off or a remote interface reset.

### **[:SENSe]:ROSCillator:EXTERNAL:FREQUENCY?**

Under the timeBase measurement, (Fno) will be shown on the counter display if there is no inputted frequency, or (Fxx) will be shown on the counter and "Not a number" on the PC side if the inputted frequency is an invalid value. On the other hand, the command ROSCillator:SOURce will reply "Not a number" under the INTERNAL condition, and "1.00000E+007" under the EXTERNAL condition.

### Return

- Numeric data transferred as ASCII bytes in <NR3> format with six significant digits.

### Note

- If the current reference timebase is internal or if the current reference timebase is external, but the frequency is not known, Not A Number 9.91E37 will be returned.

### **[:SENSe]:ROSCillator:SOURce INTERNAL|EXTERNAL**

Sets or queries the current reference timebase.

### Return

- A sequence of ASCII-encoded bytes. INT means that the timebase is internal

reference. EXT means that external.

### Notes

- Specifying the reference timebase automatically disables [:SENS]:ROSC:SOUR:AUTO ([:SENS]:ROSC:SOUR:AUTO OFF).
- When [:SENS]:ROSC:SOUR:AUTO ON, this query tells which timebase reference is used.
- Save/recall operation does not apply on this value.

### **[:SENSe]:ROSCillator:SOURce:AUTO <Boolean>**

Sets or queries the state of the auto-specifying reference timebase. With this on, the counter automatically choose the external reference signal as the reference timebase when a valid signal is present at the Ref In connector on the rear panel. When an invalid signal is present at this connector, the internal timebase is used.

### Return

- A single ASCII-encoded byte. 0 means Off and 1 means ON.

### Notes

- Specifying a reference oscillator with [:SENS]:ROSC:SOUR INT | EXT disables this auto-specifying.
- This will be set back to its default, which is ON, after the counter has been turned off or after a remote interface reset.

Sets or queries Gate for Risetime, Falltime, Duty Cycle, and Pulse Width functions measurements. For more information about the front panel gating settings and the interface command parameters, please refer to the Rise/Fall form in Chapter 5.4.

### **[:SENSe]:TINTerval:ARM:ESTART:LAYer2:SOURce IMMEDIATE | EXTERNAL**

Sets or queries the start arm for Risetime, Falltime, Duty Cycle, and Pulse Width functions measurements.

Query Response: A sequence of ASCII-encoded bytes: IMM or EXT

Comments: \*RST: IMMEDIATE

Related: Gate & ExtArm

### **[:SENSe]:TINTerval:ARM:ESTART:LAYer2:SLOPe POSITIVE | NEGATIVE**

Sets or queries the slope of the external start arm signal used in external arming Risetime, Falltime, Duty Cycle, and Pulse measurements.

Query Response: A sequence of ASCII-encoded bytes: POS or NEG

Comments: ● \*RST: POSitive

- Only applies when [:SENS]:TINT:ARM:ESTART:LAY2:SOUR EXT is selected.

Related: Gate & ExtArm

Sets or queries Gate for Time interval measurements. For more information about the front panel gating settings and the interface command parameters, please refer to the TINT table in Chapter 5.4.

#### **[:SENSe]:TINTerval:ARM:ESTART:LAYer2:SLOPe POSitive | NEGative**

Sets or queries the slope of the external start arm signal used in external arming Time interval measurements.

#### **Return**

- A sequence of ASCII-encoded bytes. POS means Positive and NEG means Negative.

#### **Notes**

- This will be set to Positive after the counter has been turned off or a remote interface reset.
- This command only applies when [:SENSe]:TINT:ARM:ESTART:LAY2:SOUR EXT is used.

#### **[:SENSe]:TINTerval:ARM:ESTART:LAYer2:SOURce IMMEDIATE | EXTERNAL**

Sets or queries the start arm for Time interval measurements.

#### **Return**

- A sequence of ASCII-encoded bytes. IMM means Immediate and EXT means External.

#### **Note**

- This will be set to Immediate after the counter has been turned off or a remote interface reset.

#### **[:SENSe]:TINTerval:ARM:ESTART[:LAYer[1]]:ECOunt <numeric value>**

Sets or queries the number of events used to delay the start arm for Time Interval measurements. The range is from 1 to 99,999,999. The resolution is 1.

#### **Return**

- Numeric data transferred as ASCII bytes in <NR1> format.

#### **Notes**

- This will be set to 1 after the counter has been turned off or a remote interface reset.
- This command only applies when [:SENSe]:TINT:ARM:ESTART[LAY[1]]:SOURCE Internal 1 is used.
- This command does not apply on Rise/Fall time, Duty cycle or Pulse width measurements.

**[:SENSe]:TINTerval:ARM:ESTART[:LAYer[1]]:SOURCE IMMEDIATE | TIMER | INTERNAL[1]**

Sets or queries the start arm delay fro Time Interval measurements.

#### **Return**

- A sequence of ASCII-encoded bytes. IMM means Immediate, TIM means Timer and INT means Internal.

#### **Note**

- This will be set to Immediate after the counter has been turned off or a remote interface reset.
- This command does not apply on Rise/Fall time, Pulse width or Duty Cycle measurements.

**[:SENSe]:TINTerval:ARM:ESTART[:Layer[1]]:TIMER <numeric value> [S]**

Sets or queries the delay time in start arm for Time Interval measurements.

#### **Return**

- Numeric data transferred as ASCII bytes in <NR1> format.

#### **Notes**

- This will be set to 100E-9 seconds after the counter has been turned off or a remote interface reset.
- This command only applies when [:SENSe]:TINT:ARM:ESTART[:LAYer[1]]:SOURCE TIM is used.



- This command does not apply on Rise/Fall time, Pulse width or Duty cycle measurements.

#### **[[:SENSe]:TINteRval:ARM:ESTOP:LAYer2:SLOPe POSitive | NEGative**

Sets or queries the slope of the external stop arm signal used in external arming Time interval measurements.

#### **Return**

- A sequence of ASCII-encoded bytes. POS means Positive edge and NEG means negative edge.

#### **Notes**

- This will be set to Positive after the counter has been turned off or a remote interface reset.
- This command only applies when [[:SENSe]:TINteRval:ARM:ESTOP:LAY2:SOUR EXT is used.

#### **[[:SENSe]:TINteRval:ARM:ESTOP:LAYer2:SLOPe IMMEDIATE | EXtERnal**

Sets or queries the stopping point of the arm for Time interval measurements.

#### **Return**

- A sequence of ASCII-encoded bytes. IMM means Immediate and EXT means External.

#### **Note**

- This will be set to Immediate after the counter has been turned off or a remote interface reset.

#### **[[:SENSe]:TINteRval:ARM:ESTOP[:LAYer[1]]:ECOunt <numeric value>**

Sets or queries the number of events used to delay the stop arm for Time Interval measurements. The range is from 1 to 99,999,999. The resolution is 1.

#### **Return**

- Numeric data transferred as ASCII bytes in <NR1> format.

#### **Notes**

- This will be set back to 1 after the counter has been turned off or a remote interface

reset.

- This command only applies when [:SENSe]:TINT:ARM:ESTOP[:LAYer[1]]:SOUR Internal2 is used.

**[:SENSe]:TINTerval:ARM:ESTOP[:LAYer[1]]:SOURce IMMEDIATE | TIMER | INTERNAL2**

Sets or queries the stopping point of the arm for Time Interval measurements.

**Return**

- A sequence of ASCII-encoded bytes. IMM means Immediate, INT means Internal2 and TIM means Timer.

**Note**

- This will be set to Immediate after the counter has been turned off or a remote interface reset.
- This command does not apply on Rise/Fall time, Pulse width or Duty cycle measurements.

**[:SENSe]:TINTerval:ARM:ESTop[:Layer[1]]:TIMER <numeric value> [S]**

Sets or queries the delay time used in stop arm for Time Interval measurements. The range is 100E-9 to 10.000 seconds and the resolution is 100E-9 seconds.

**Return**

- Numeric data transferred as ASCII bytes in <NR1> format.

**Notes**

- This will be set to 100E-9 seconds after the counter has been turned off or a remote interface reset.
- This command only applies when [:SENSe]:TINT:ARM:ESTOP[:LAY[1]]:SOUR TIM is used.
- This command does not apply on Rise/Fall Time, Pulse width or Duty cycle measurements.

Sets or queries Gate for Totalize measurements. For more information about the front panel gating settings and the interface command parameters, please refer to the TOT table in Chapter 5.4.

**[:SENSe]:TOTalize:ARM[:START]:SLOPe POSitive | NEGative**

Sets or queries the slope of the external start arm signal used in external arming Totalize measurements.

**Return**

- A sequence of ASCII-encoded bytes. POS means Positive and NEG means Negative.

**Notes**

- This will be set to Positive after the counter has been turned off or a remote interface reset.
- This command only applies when [:SENSe]:TOT:ARM[:STAR]:SOUR EXT is used.

**[:SENSe]:TOTAlize:ARM[:STARt]:SOURce IMMEDIATE | EXTERNAL**

Sets or queries the starting point of the arm for Totalize measurement.

**Return**

- A sequence of ASCII-encoded bytes. IMM means Immediate and EXT means External.

**Notes**

- This will be set to Immediate after the counter has been turned off or a remote interface reset.
- When the starting and the stopping points are both set to immediate, the :INIT[:IMM] command can be used to start totalizing and the :ABORt command can be used to end it. Before the "auto" totalize measurement is terminated, there is no valid totalize result.

**[:SENSe]:TOTAlize:ARM:STOP:SLOPe POSITIVE | NEGATIVE**

Sets or queries the slope of the external stop arm signal used in external arming Totalize measurements.

**Return**

- A sequence of ASCII-encoded bytes. POS means Positive and NEG means Negative.

**Notes**

- This will be set to Negative after the counter has been turned off or a remote interface reset.
- This command only applies when [:SENSe]:TOT:ARM:STOP:SOUR EXT is used.

### **[[:SENSe]:TOTAlize:ARM:STOP:SOURce IMMEDIATE | TIMer | EXTernal]**

Sets or queries the stopping point of the arm for Totalize measurements.

#### **Return**

- A sequence of ASCII-encoded bytes. IMM means Immediate, TIM means Timer and EXT means External.

#### **Notes**

- This will be set to Timer after the counter has been turned off or a remote interface reset.
- When the starting and the stopping points are both set to immediate, the command :INIT[:IMM] can be used to start totalizing and the command :ABORt can be used to end it. Before the "auto" totalize measurement is terminated, no totalize result will be available.

### **[[:SENSe]:TOTAlize:ARM:STOP:TIMer <numeric value> [S]**

Sets or queries the gate time in arming Totalize measurements. The range is 1E-3 to 1,000 seconds and the resolution is 0.01E-3 seconds.

#### **Return**

- Numeric data transferred as ASCII bytes in <NR3> format with six significant digits.

#### **Notes**

- This will be set to 100E-3 seconds after the counter has been turned off or a remote interface reset.
- This command only applies when [[:SENSe]:TOT:ARM:STOP:SOUR TIM] is used.

### **[[:SENSe]:VOLTage:MODE FAST | SLOW]**

To set or query "FAST" or "SLOW" under the Mode of Voltage Peak, the "FAST" is recommended if the input source is over 10 KHz, and the "SLOW" is recommended if the input source is over 100 Hz.

#### **Return**

A sequence of ASCII-encoded bytes, FAST or SLOW.

## **The Commands :SYSTEM**

These commands deal with the capabilities that have no direct effects on the counter's performance.

#### **:SYSTem:COMMunicate:SERial:SOURce USB**

Sets or queries the hardware pacing scheme. As the LIMIT PASS/FALL is set to USB, the output port will be via USB.

#### **Return**

- A USB message will be returned.

#### **Note**

- As the command :SYSTem:COMMunicate:SERial:SOURce USB is executed, users can't do the remote control via USB excluding LAN or GPIB.

#### **:SYSTem:COMMunicate:SERial:CONTRol:DTR OFF | LIMit**

Sets or queries the hardware pacing scheme. The parameter LIMit can be set by the command :SYSTem:COMMunicate:SERial:SOURce USB. As the command is set to OFF, users can't use the Output function of the Limit PASS/FALL.

#### **Return**

- A sequence of ASCII encoded bytes: OFF or LIM.

#### **Notes**

- This value is stored at non-volatile memory, so it does not change after the counter has been turned off or after a remote interface reset.
- The start and stop thresholds are not user configurable.

#### **:SYSTem:ERRor?**

Queries the first error in the error queue and removes it from the error queue. Refer to Chapter 6 for the error numbers and messages.

#### **Return**

- The error number and the error message are returned. The error number is an integer between -32767 and 32767. A "0" is returned if there is no error in the error queue.

#### **Notes**

- The error queue will be emptied after the counter has been turned off or after the last error in the queue has been read.

- When there are more than 30 errors, which causes the error queue overflows, the last error is replaced with error -350, "queue overflows". The most recent error will be discarded.
- This command removes the displayed error from the error queue.
- The \*RST command does not change the error queue.

**:SYSTem:KEY <numeric value>**

This command simulates the pressing of a front-panel key. The parameter <numeric value> is a key code number. The following table shows the keys and their corresponding number codes.

This command places an entry in the Key Queue just like the real pressing of a key on the front panel. The maximum capacity of the key queue is 500.

Key Code	Key	Key Code	Key
1	Freq & Ratio	20	F5
2	Time & Period	21	F6
3	Volt Peak	22	Number_0
4	Other Meas	23	Number_1
5	Utility	24	Number_2
6	Run	25	Number_3
7	Gate & ExtArm	26	Number_4
8	Limit Modes	27	Number_5
9	Scale & Offset	28	Number_6
10	Stats	29	Number_7
11	Save & Recall	30	Number_8
12	Stop/Single	31	Number_9
13	CH1	32	Number_.
14	CH2	33	Number_+/-
15	CH3(not support)	34	↑
16	F1	35	←
17	F2	36	→
18	F3	37	↓
19	F4	38	Preset

**Return**

- Numeric data transferred as ASCII bytes in <NR1> format. The number returned represents a key last pressed in the front panel. A "-1" is returned when this key queue is empty.

**Notes**

- The key queue will be cleared after the counter has been turned off or after a \*RST command.
- Save/recall operation does not apply on this value.
- Key commands are sequential, but only in terms of processing other key commands or getting into the key queue. The operation performed by the key command is not guaranteed to be complete before processing of the next non-key command. Be ware of this when intermixing key commands and non-key commands.

#### **:SYSTem:KEY:LOG?**

Queries all the entries in the Key Queue.

#### **Return**

- Numeric data transferred as ASCII bytes in <NR1> format. A "-1" is returned when the queue is empty. Each Key Code number is separated by a comma. The entries are in a last-in, first-out order.
- The maximum number of key codes is 500. Each key code has a range of 1 to 10.

#### **Note**

- The Key Queue will be empties after the counter has been turned off or after a \*RST command.
- Save/recall operation does not apply on this value.

#### **:SYSTem:VERSion?**

Queries the SCPI version number with which the counter complies.

#### **Return**

- Numeric data transferred in ASCII bytes in <NR2> format.
- The response is in the form of YYYY.V, where YYYY represents the year and V represents the approved version of that year.

#### **:SYSTem:COMMunicate:RLSTate LOCAL | REMote | RWLock**

Set or queries the remote/local state of the instrument.

LOCAL: Free the all panel keys.

REMote: Set I/O mode to remote and lock all of panel keys, but Preset/Local key not.

RWLock: To lock all of panel keys, instrument can only be controlled via the remote interface).

**SYSTem:BEEPer:STATe OFF | ON**

Set or queries the beeper enable mode when an error is generated from the Front panel or over the remote interface.

**:SYSTem:IDNStr <QUOTED STRING>**

Set the IDN String for I/O compatible mode. The setting string be queried by \*idn? when I/O mode is compatible.

**:SYSTem:UTILity:IO:MODE NATive | COMPatibility**

To set and query the IDN string, the NATive can be selected for default, and the COMPatibility can be selected for user definition.

**Return**

A sequence of ASCII-encoded bytes: NAT or COMP.

**Note**

As the command \*RST is executed, the NAT will be set.

**The Commands :TRACe**

These commands are used to specify and query the scale and offset values.

**:TRACe:CATalog?**

Queries the names of the constants the counter uses.

**Return**

- The strings "SCALE" and "OFFSET" are returned.

**:TRACe[:DATA] OFFSET, <numeric value> [HZ|S|DEG]**

Or

**:TRACe[:DATA] OFFSET, <arbitrary block>**

Sets the offset value. The range for offset value is from -9.9999990000E+12 to -1.0000000000E-13, 0.0000000000, and from +1.0000000000E-13 to +9.9999990000E+12. The resolution is 11 digits.

**Notes**

- The offset value will be set back to zero after the counter has been turned off or after



a remote interface reset.

- Specifying a new offset value will clear the limit counts (:CALC2:LIM:FCO, :CALC2:LIM:PCO).

#### **:TRACe[:DATA]? OFFSET**

Queries the offset value.

#### **Return**

- The format of the response is according to the specification made in :FORMat[:DATA] ASCii|REAL command.
- If using the ASCII format, the numeric data is transferred as ASCII bytes in <NR3> format with eleven significant digits.

#### **Note**

- If the display screen is not able to show all the significant digits, the displayed value is rounded so that it is different from the actual value, but press the softkey under ENTER while it is in the 11-digit display can change the actual offset value to the displayed value.

#### **:TRACe[:DATA] SCALE, <numeric value>**

Or

#### **:TRACe[:DATA] SCALE, <arbitrary block>**

Sets the scale value. The range for scale value is from -9.999999E+12 to -1.000000E-13, 0.0000000000, and from +1.000000E-13 to +9.999999E+12. The resolution is 7 digits.

#### **Notes**

- The offset value will be set back to 1.000000 after the counter has been turned off or after a remote interface reset.
- Specifying a new offset value will clear the limit counts (:CALC2:LIM:FCO, :CALC2:LIM:PCO).

#### **:TRACe[:DATA]? SCALE**

Queries the scale value.

#### **Return**

- The format of the response is according to the specification made in :FORMat[:DATA] ASCii|REAL command.
- If using the ASCII format, the numeric data is transferred as ASCII bytes in <NR3>

format with eleven significant digits.

#### **Note**

- If the display screen is not able to show all the significant digits, the displayed value is rounded so that it is different from the actual value, but press the softkey under ENTER while it is in display can change the actual offset value to the displayed value.

#### **:TRIGger:COUNt:AUTO <Boolean>**

Sets or queries the control over the number of measurements taken when :INITiate[:IMMEDIATE] command is sent.

With this OFF, the :INIT[:IMM] initiates one measurement. When :TRIG:COUN:AUTO is ON and [:SENS]:FUNC[:ON] is one of the Frequency, **Frequency ratio**, Voltage Peaks, Period, **Pulse Width and Duty cycle** measurements, then when statistic function is disabled(:CALC:AVER[:STAT] is OFF), :INIT[:IMM] initiates one measurement only, but when statistic function is enabled(:CALC:AVER[:STAT] is ON), :INIT[:IMM] initiates a specified(by :CALC3:AVER:COUN) number of measurements.

#### **Return**

- A single ASCII-encoded byte. 0 means OFF and 1 means ON.

#### **Note**

- This will be set back to OFF after the counter has been turned off or after a remote interface reset.

## **D.3 IEEE-488 Common Commands**

The SCPI commands used in the U6200A/220A are in conformance with the SCPI standard Version 1992.0. The common commands are listed here:

※ **Note: The U6220A doesn't support some of the IEEE-488 commands colored green.**

#### **\*CLS**

Clears all event registers summarized in the status byte, including Standard Event Status Register, Operation Event Status Register and Questionable Data

Event Status Register, and the error queue.

This command also place the counter in "Operation Complete Idle State" and "Operation Complete Query Idle State" (IEEE488.2) and disables any prior \*OPC command.

If \*CLS follows immediately a program message terminator, the output queue and the MAV bit are cleared because "any" new program message after a program message terminator clears the output queue.

### Notes

- This command does not clear saved settings or any data memories.
- This command will clear any displayed error messages.

### \*DDT<arbitrary block>

This is a Define Device Trigger command. It sets or queries the command that the device will execute when it receives the IEEE 488.1 Group Execute Trigger (GET) interface message or a \*TRG common command.

The counter takes only the commands :INITiate[:IMMediate], :READ? and :FETCh? or otherwise error -224 will be generated. When the parameter is a zero-length <arbitrary block>, the counter does not do anything when it receives a GET or a \*TRG command.

### Return

- #14INIT, #15FETC?, #15READ? Or #0 terminated with a new line and EOI.

### Notes

- It will be set back to #14INIT after the counter has been turned off or after a remoter interface reset.
- When defining the device trigger to :FETCh? Or :READ?, note that these definitions do not allow the specification of a particular function. This lack of a function specification results in each \*DDT using the function specified and used by the last command :CONFigure, :FETCh, :READ, or :MEASure, if possible.

### \*ESE<NRf>

Sets the Standard Event Status Enable Register. The parameter's range is from 0 to 255 and the resolution is 1. The parameter represents the bit values of the Standard Event Status Enable Register when it is rounded to an integer value and expressed in base 2(binary). The value of unused bits is zero when queried and ignored when set.

**Notes**

- The Standard Event Status Enable Register is cleared and set to "0" after the counter has been turned off.
- This value is unaffected by save/recall and \*RST.

**\*ESE?**

Queries the Standard Event Status Enable Register.

**Return**

- Numeric data transferred as ASCII bytes in <NR1> format.

**Notes**

- The Standard Event Status Enable Register is cleared and set to "0" after the counter has been turned off.
- This value is unaffected by save/recall and \*RST.

**\*ESR?**

Queries the Standard Event Status Register.

This event register captures changes in conditions, by having each event bit correspond to a specific condition in the instrument.

An event becomes TRUE when the associated condition makes the defined transition. The event bits cannot be cleared until they are read, even if they do not reflect the current status of a related condition.

**Return**

- Numeric data transferred as ASCII bytes in <NR1> format.
- The query response is an integer formed by the binary-weighting of the bits. The value of unused bit is zero.

**Notes**

- This register is cleared after the counter has been turned off or after \*CLS or \*ESR?. Note that the instrument's power-on sequence initially clears the register, but then records any subsequence events during the power-on sequence including setting the Power on bit.

**\*IDN?**

Queries the counter identification.

**\*OPC**

Enables the OPC bit (bit 0) in the Standard Event Status Register to be set upon the transition if the measurement cycle from measuring to idle.

**Note**

- This event command is "disabled" by \*CLS, \*RST, Device Clear, after the counter has been turned off or upon the transition of the measurement cycle from measuring to idle.

**\*OPC?**

A response is generated when the counter is placed in an idle state from a measuring state. This allows synchronization between a controller and the instrument using the MAV bit in the Status Byte Register or a read of the Output Queue.

Since this query will not respond until the measurement cycle transition from measuring to idle, the only way to cancel the query "holdoff" is by Device Clear or power-on.

**Return**

- A single ASCII-encoded byte, 1.

**Note**

- This query does not affect the OPC bit in the Standard Event Status Register.

**\*OPT?**

**Queries the instrument to identify any installed options.**

High stability oven oscillator: U6200-opt01 (for U6200A only)

250MHz-20GHz Input Channel: U6200-opt02 (for U6200A only)

Rear panel input module (CH1/CH2): U6200-opt04 (for U6200A only)

Rear pane input module (CH1/CH2/CH3): U6200-opt05 (for U6200A only). GPIB Card: M3500-opt05

**\*RCL<NRf>**

Restores the state of the counter from a copy stored in local non-volatile memory. Before the recall takes place, the current state of the instrument is automatically saved to

register 0. The parameter's range is from 0 to 20 and the resolution is 1.

**Note**

- This command does not affect the following commands or statuses:

\*ESE

\*OPC

\*OPC?

\*SRE

\*WAI

:CALibration:DATA

:CALibration:SECurity:CODE

:CALibration:SECurity:STATe

:CONFigure?

:DISPlay:ENABLE

:DISPlay:MENU[:STATe]

:DISPlay[:WINDow]:TEXT:RADix

[[:SENSe]:FREQuency:EXPeCted[1|2|3]

[[:SENSe]:FREQuency:EXPeCted[1|2|3]:AUTO

[[:SENSe]:ROSCillator:SOURCe

[[:SENSe]:ROSCillator:SOURCe:AUTO

:SYSTem:COMMunicate:SERial:CONTRol:DTR

:SYSTem:ERRor?

:SYSTem:KEY?

:SYSTem:KEY:LOG?

GP-IB address

**\*RST**

Reset the universal counter to its power-on configuration, disables macros, empties the Key queue and places the counter in "Operation Complete Idle State" and "Operation Complete Query Idle State".

This command does not change any calibration data, macros defined by \*DMC command, the Service Register Enable, the Standard Event Status Enable, the Output Queue, the IEEE488.1 address or the state of the IEEE488,1 interface.

**\*SAV<NRf>**

Saves the current state of the counter in local non-volatile memory.

The current state of the counter is saved in register 0 when \*RCL or front-panel

recall is executed. The parameter's range is from 1 to 20 and the resolution is 1.

**\*SRE<NRf>**

**Sets** the Service Request Enable Register.

The parameter value, when rounded to an integer value and expressed in base 2(binary), represents the bit values of the Service Request Enable Register.

This register is used to enable a single or inclusive OR group of Status Byte Register events to generate an SRQ. The parameter's range is to 255 and the resolution is 1.

**\*SRE?**

Queries the Service Request Enable Register.

**Return**

- Numeric data transferred as ASCII bytes in <NR1> format.
- The value of bit 6 and unused bits is zero when queries.

**Notes**

- This value is cleared and set back to zero after the counter has been turned off.
- This value is not affected by save/recall and \*RST command.

**\*STB?**

Queries the Status Byte Register. This query does not directly change the Status Byte Register (including the MSS/RQS bit) or anything related to the generation of SRQ. The response value when rounded to an integer value and expressed in base 2(binary), represents the bit values of the Status Byte Register.

**Return**

- Numeric data transferred as ASCII bytes in <NR1> format.
- Range is 0 to 255.
- The value of unused bits is zero when queried.
- The Master Summary Status, not the RQS message, is reported on bit 6. Master Summary Status indicates that the counter has at least one reason for requesting service. (The Master summary Status is not sent in response to a serial poll; the IEEE 488.1 RQS message is sent instead.) It is the inclusive OR of the bitwise combination (excluding bit6) of the Status Byte

Register and the Service Request Enable Register,

#### **\*TRG**

This command is the device-specific analog of the IEEE 488.1 group Execute Trigger (GET) interface message, and has exactly the same effect.

This command will perform the action defined by the \*DDT command.

#### **\*TST?**

Starts an internal self-test and returns a response indicating if there is any error found in the self-test.

#### **Return**

- Numeric data transferred as ASCII bytes in <NR1> format.
- A response value of zero indicates a complete self-test without any errors and a response value of non-zero value indicates either a complete test with errors or an unfinished self-test.
- If the self-test fails, error -330 will be generated.

#### **Note**

- The self-test includes the followings:  
CPU, ROM, RAM, EEPROM, QSPI, FPGA, Front End, Measurement hardware and Interpolator hardware.

#### **\*WAI**

This command prevents the instrument from executing any further commands or queries until the measurement cycle transitions from measuring to idle. The only way to cancel this "holdoff" is by device memory clearance or power-on.

#### **Note**

- This command is not affected by \*RST and \*CLS commands.

## **D.4 IEEE-488 Compliance Information**

This section encloses a list of commands that are device-specific to the U6200A/220A. These commands are designed with the SCPI format in mind and they follow all the syntax rules of the standard.



※ Note: The U6220A doesn't support some of the IEEE-488 compliance colored green.

```
:CALCulate[1]
  :DATA?
  :FEED "[:]SENSe[1]"
  :IMMediate
    :AUTO <Boolean>
  :MATH
    [:EXPRession]
    :CATalog?
    [:DEFine]?
    :NAME | :SElect SCALE_OFFSET
  :STATe <Boolean>
```

```
:CALCulate2
  :FEED "[:]CALCulate[1]"
  :IMMediate
    :AUTO <Boolean>
  :LIMit
    :STATe <Boolean>
    :DISPlay GRAPH | NUMBer
    :CLEar
      :AUTO <Boolean>
      [:IMMediate]
    :FAIL?
    :PCOunt
      [:TOTal]?
    :FCOunt
      :LOWer?
      :UPPer?
      [:TOTal]?
    :LOWer
      [:DATA] <numeric_value> [HZ | S | DEG]
    :UPPer
      [:DATA] <numeric_value> [HZ | S | DEG]
```

:CALCulate3

:DATA?

:FEED “[:]CALCulate[1]”

:PATH?

:AVERage

[:]STATe] <Boolean>

:ALL?

:CLEar

:COUNT <numeric\_value>

:CURRent?

:TYPE MAXimum | MINimum | SDEVIation | SCALar or MEAN | DELTa

:LFILter

:STATe <Boolean>

:LOWer

[:]DATA] <numeric value> [HZ | S | DEG]

:UPPer

[:]DATA] <numeric value> [HZ | S | DEG]

:CALibration

:DATA <arbitrary block>

:SECurity

:STATe <Boolean>,<Nrf>

:CODE <Nrf>

:RESet

:CONFigure[:SCALar]:<function>

:CONFigure?

:DISPlay

:ENABle <Boolean>

:MENU

[:]STATe] OFF

[:]WINDow]

:TEXT

:FEED “[:]CALCulate2” | “[:]CALCulate3”

:RADix COMMa | DPOint

:FETCh

:INITiate

:AUTO <Boolean>

:CONTinuous <Boolean>

[:IMMEDIATE]

:INPut[1|2]

:ATTenuation

:COUPling AC | DC

:FILTer

[:LPASs]

[:STATe] <Boolean>

:FREQuency?

:IMPedance <numeric\_value> [OHM]

:INPut3

:COUPling?

:IMPedance?

:MEASure[:SCALar]:<function>?

:READ[:SCALar]:<function>?

[:SENSe]

:DATA? [[:]SENSe[1]]

:EVENT[1|2]

:HYSTeresis

:RELative <numeric value> [PCT]

:LEVel

[:ABSolute] <numeric value> [V]

:AUTO <Boolean>

:RELative <numeric value> [PCT]

:SLOPe POSitive | NEGative

:EVENT2

:FEED "[:]INPut[1] | [:]INPut2"

:FREQuency

:ARM

[:START]

:SLOPe POSitive | NEGative

:SOURce IMMEDIATE | EXTernal

:STOP:DIGits<numeric value>

:SLOPe POSitive | NEGative

:SOURce IMMEDIATE | EXTernal | TIMer | DIGits

:TIMer <numeric value> [S]

:DIGits <numeric value>

:EXPeCted[1|2|3] <numeric value> [HZ]

:AUTO ON

:FUNction

[:ON] "[:]XNONe:]FREQuency [1|2|3]"  
"[:]XNONe:]FREQuency:RATio [1,2|1,3|2,1|3,1]"  
"[:]XNONe:]PERiod [1|2|3]"  
"[:]XNONe:]RISE:TIME [1]"  
"[:]XNONe:]RTIME [1]"  
"[:]XNONe:]FALL:TIME [1]"  
"[:]XNONe:]FTIME [1]"  
"[:]XNONe:]PWIDth [1]"  
"[:]XNONe:]NWIDth [1]"  
"[:]XNONe:]TINTerval [1,2]"  
"[:]XNONe:]VOLTagE:PTPeak [1|2]"  
"[:]XNONe:]VOLTagE:MAXimum [1|2]"  
"[:]XNONe:]VOLTagE: MINimum [1|2]"  
"[:]XNONe:]VOLTagE: CENTer [1|2]"  
"[:]XNONe:]PHASe [1,2]"  
"[:]XNONe:]DCYCLE [1]"  
"[:]XNONe:]PDUTycycle [1]"  
"[:]XNONe:]TOTalize [1]"

:PHASe  
:ARM  
[:START]  
:SLOPe POSitive | NEGative  
:SOURce IMMEDIATE | EXTERNAL

:ROSCillator  
:SOURce INTERNAL | EXTERNAL  
:AUTO <Boolean>  
:EXTERNAL  
:FREQUENCY?

:TINTERVAL  
:ARM  
:ESTART  
:LAYER2  
:SLOPe POSitive | NEGative  
:SOURce IMMEDIATE | EXTERNAL  
[:LAYER[1]]  
:ECOUNT <numeric\_value>  
:SOURce IMMEDIATE | TIMER | INTERNAL1  
:TIMER <numeric value> [S]  
:ESTOP  
:LAYER2  
:SLOPe POSitive | NEGative  
:SOURce IMMEDIATE | EXTERNAL  
[:LAYER[1]]  
:ECOUNT <numeric\_value>  
:SOURce IMMEDIATE | TIMER | INTERNAL2  
:TIMER <numeric\_value>  
[:START]  
:SLOPe POSitive | NEGative  
:SOURce IMMEDIATE | EXTERNAL  
:STOP  
:SOURce IMMEDIATE | TIMER  
:TIMER <numeric\_value>

:TOTAlize  
  :ARM  
    [:START]  
      :SLOPe POSitive | NEGative  
      :SOURce IMMEDIATE | EXTernal  
    :STOP  
      :SLOPe POSitive | NEGative  
      :SOURce IMMEDIATE | EXTernal | TIMer  
      :TIMer <numeric value> [S]

:SYSTem

  :COMMunicate  
    :SERial  
      :SOURce USB  
      :CONTrol  
        :DTR OFF | LIMit  
  :ERRor?  
  :KEY <numeric\_value>  
    :LOG?  
  :VERSion?

:TRACe

  :CATalog?  
  [:DATA] OFFSET, <numeric\_value> [HZ | S | DEG]  
  [:DATA] SCALE, <numeric\_value>  
  [:DATA]? OFFSET  
  [:DATA]? SCALE

:TRIGger

  :COUNT  
    :AUTO <Boolean>

---

## E. About Application Programs

This section provides a brief description for each U6200A/220A sample collection.

※ **Note:** The U6220A doesn't support some of the application programs colored green.

### Using CONFigure to Measurement

#### Example 1 Freq & Ratio measurement

```
// Freq_Ratio.cpp : Defines the entry point for the console application.
#include "stdafx.h"
#include "visa.h" //include visa32.lib first to the project.
#define MAX_COUNT 200
#include "stdio.h"

int main(int argc, char* argv[])
{
    ViStatus stat; /* For checking errors */
    ViSession defaultRM; /* Communication channels */
    ViSession sesn; /* Communication channel */
    ViChar rsrcName[VI_FIND_BUFLen]; /* Serial resource name */
    ViChar intfDesc[VI_FIND_BUFLen]; /* Port binding description */
    ViUInt32 ret; /* To hold number of resources */
    ViFindList flist; /* To hold list of resources */

    char readin[128]="";
    int tmo;

    printf("\n ##### Start C++ Example program. #####\n");
    printf(" We check the Counter on USB port and\n");
    printf(" identify the first connected device.\n\n");

    /* Begin by initializing the system */
    stat = viOpenDefaultRM(&defaultRM);
```

```

if (stat < VI_SUCCESS) {
    /* Error Initializing VISA...exiting */
    printf ("Error Initializing NI-VISA...");
    return 0;
}
stat = viFindRsrc (defaultRM, "USB[0-9]::0x164E::0x1838::?*INSTR",
&flist, &ret, rsrcName);

stat = viOpen (defaultRM, rsrcName, VI_NULL, VI_NULL, &sesn);
if (stat < VI_SUCCESS)
{
    printf ("Could not open %s, status = 0x%08IX\n",rsrcName, stat);
    return 0;
}
else
{
    stat = viGetAttribute (sesn, VI_ATTR_INTF_INST_NAME, intfDesc);
    printf ("Resource %s, Description %s\n", rsrcName, intfDesc);
}
stat = viFindNext (flist, rsrcName);

//Setting Process Visa Timeout
stat = viGetAttribute(sesn, VI_ATTR_TMO_VALUE, &tmo);
stat = viSetAttribute(sesn, VI_ATTR_TMO_VALUE, 30000);

//send reset command '*RST' -- reset U6200A
stat = viWrite(sesn, (unsigned char *)("*RST"), 4, &ret);

//send Clear command '*CLS'-- Clear U6200A status register
stat = viWrite(sesn, (unsigned char *)("*CLS"), 4, &ret);

//send reset command 'INIT:CONT ON' -- Initial U6200A
stat = viWrite(sesn, (unsigned char *)("INIT:CONT ON"), 12, &ret);

//Send commands befor measure (required)

```



```

/*----- CH1 Input Condition -----*/
    stat = viWrite(sesn, (unsigned char *)("INP1:IMP 1000000"), 16, &ret);
    stat = viWrite(sesn, (unsigned char *)("INP1:COUP AC"), 12, &ret);
    stat = viWrite(sesn, (unsigned char *)("INP1:ATT 1"), 10, &ret);
    stat = viWrite(sesn, (unsigned char *)("INP1:FILT OFF"), 13, &ret);
    stat = viWrite(sesn, (unsigned char *)("EVEN1:SLOP POS"), 14, &ret);
    stat = viWrite(sesn, (unsigned char *)("EVEN1:HYST:REL 50"), 17, &ret);
    stat = viWrite(sesn, (unsigned char *)("EVEN1:LEV:REL 50"), 16, &ret);
    stat = viWrite(sesn, (unsigned char *)("EVEN1:LEV:ABS:AUTO ON"), 21,
&ret);
/*----- CH2 x Input Condition -----*/
    stat = viWrite(sesn, (unsigned char *)("INP2:IMP 1000000"), 16, &ret);
    stat = viWrite(sesn, (unsigned char *)("INP2:COUP AC"), 12, &ret);
    stat = viWrite(sesn, (unsigned char *)("INP2:ATT 1"), 10, &ret);
    stat = viWrite(sesn, (unsigned char *)("INP2:FILT OFF"), 13, &ret);
    stat = viWrite(sesn, (unsigned char *)("EVEN2:SLOP POS"), 14, &ret);
    stat = viWrite(sesn, (unsigned char *)("EVEN2:HYST:REL 50"), 17, &ret);
    stat = viWrite(sesn, (unsigned char *)("EVEN2:LEV:REL 50"), 16, &ret);
    stat = viWrite(sesn, (unsigned char *)("EVEN2:LEV:ABS:AUTO ON"), 21,
&ret);
/*-----*/

/*----- Freq & Ratio measure -----*/
    stat = viWrite(sesn, (unsigned char *)("CONF:FREQ (@1)"), 14, &ret);
//    stat = viWrite(sesn, "CONF:FREQ (@2)", 14, &ret);
//    stat = viWrite(sesn, "CONF:FREQ (@3)", 14, &ret);
//    stat = viWrite(sesn, "CONF:FREQ:RAT (@1),(@2)", 23, &ret);
//    stat = viWrite(sesn, "CONF:FREQ:RAT (@1),(@3)", 23, &ret);
//    stat = viWrite(sesn, "CONF:FREQ:RAT (@2),(@1)", 23, &ret);
//    stat = viWrite(sesn, "CONF:FREQ:RAT (@3),(@1)", 23, &ret);
/*----- Gate Time -----*/
    stat = viWrite(sesn, (unsigned char *)("FREQ:ARM:SOUR IMM"), 17,
&ret);
    stat = viWrite(sesn, (unsigned char *)("FREQ:ARM:STOP:SOUR TIM"), 22,
&ret);
    stat = viWrite(sesn, (unsigned char *)("FREQ:ARM:STOP:TIM 1"), 19,
&ret);

```

```

/*----- Gate Ext -----*/
// stat = viWrite(sesn, "FREQ:ARM:SOUR Ext", 17, &ret);
// stat = viWrite(sesn, "FREQ:ARM:SLOP POS", 17, &ret);
// stat = viWrite(sesn, "FREQ:ARM:STOP:SOUR Ext", 22, &ret);
// stat = viWrite(sesn, "FREQ:ARM:STOP:SOUR TIM", 22, &ret);
// stat = viWrite(sesn, "FREQ:ARM:STOP:TIM 1", 19, &ret);
/*----- Gate Auto -----*/
// stat = viWrite(sesn, "FREQ:ARM:SOUR IMM", 17, &ret);
// stat = viWrite(sesn, "FREQ:ARM:STOP:SOUR IMM", 22, &ret);
/*----- Gate Digits -----*/
// stat = viWrite(sesn, "FREQ:ARM:SOUR IMM", 17, &ret);
// stat = viWrite(sesn, "FREQ:ARM:STOP:SOUR DIG", 22, &ret);
// stat = viWrite(sesn, "FREQ:ARM:STOP:DIG 5", 19, &ret);
/*-----*/

/*----- Read From Device -----*/
    stat = viWrite(sesn, (unsigned char *)("FETC?"), 5, &ret);
// stat = viWrite(sesn, "READ?", 5, &ret);
// stat = viWrite(sesn, "MEAS:FREQ?", 10, &ret);
// stat = viWrite(sesn, "SENS:DATA?", 10, &ret);
/*-----*/

    stat=viRead(sesn,(unsigned char *)readin,128,&ret);
    printf ("Read : %s",readin);
    stat = viSetAttribute(sesn, VI_ATTR_TMO_VALUE, tmo);
    stat = viGpibControlREN(sesn, VI_GPIB_REN_ADDRESS_GTL);
    viClose (flist);
    viClose (defaultRM);
    return 0;
}

```

## **Example 2** Time & Period measurement

```

// Time_Period.cpp : Defines the entry point for the console application.
#include "stdafx.h"
#include "visa.h"//include visa32.lib first to the probject.
#define MAX_COUNT 200
#include "stdio.h"

```

```

int main(int argc, char* argv[])
{
    ViStatus stat; /* For checking errors */
    ViSession defaultRM; /* Communication channels */
    ViSession sesn; /* Communication channel */
    ViChar rsrcName[VI_FIND_BUFLLEN]; /* Serial resource name */
    ViChar intfDesc[VI_FIND_BUFLLEN]; /* Port binding description */
    ViUInt32 ret; /* To hold number of resources */
    ViFindList flist; /* To hold list of resources */

    char readin[128]="";
    int tmo;

    printf("\n ##### Start C++ Example program. #####\n");
    printf(" We check the Counter on USB port and\n");
    printf(" identify the first connected device.\n\n");

    /* Begin by initializing the system */
    stat = viOpenDefaultRM(&defaultRM);

    if (stat < VI_SUCCESS) {
        /* Error Initializing VISA...exiting */
        printf ("Error Initializing NI-VISA...");
        return 0;
    }
    stat = viFindRsrc (defaultRM, "USB[0-9]::0x164E::0x1838::?*INSTR",
&flist, &ret, rsrcName);

    stat = viOpen (defaultRM, rsrcName, VI_NULL, VI_NULL, &sesn);
    if (stat < VI_SUCCESS)
    {
        printf ("Could not open %s, status = 0x%08IX\n",rsrcName, stat);
        return 0;
    }
    else
    {

```

```

        stat = viGetAttribute (sesn, VI_ATTR_INTF_INST_NAME, intfDesc);
        printf ("Resource %s, Description %s\n", rsrcName, intfDesc);
    }
    stat = viFindNext (flist, rsrcName);
    //Setting Process Timeout
    stat = viGetAttribute(sesn, VI_ATTR_TMO_VALUE, &tmo);
    stat = viSetAttribute(sesn, VI_ATTR_TMO_VALUE, 30000);

    //send reset command '*RST' -- reset U6200A
    stat = viWrite(sesn, (unsigned char *)("*RST"), 4, &ret);

    //send Clear command '*CLS'-- Clear U6200A status register
    stat = viWrite(sesn, (unsigned char *)("*CLS"), 4, &ret);

    //send reset command 'INIT:CONT ON' -- Initial U6200A
    stat = viWrite(sesn, (unsigned char *)("INIT:CONT ON"), 12, &ret);

    //Send commands befor measure (required)

    /*----- CH1 Input Condition -----*/
    stat = viWrite(sesn, (unsigned char *)("INP1:IMP 1000000"), 16, &ret);
    stat = viWrite(sesn, (unsigned char *)("INP1:COUP AC"), 12, &ret);
    stat = viWrite(sesn, (unsigned char *)("INP1:ATT 1"), 10, &ret);
    stat = viWrite(sesn, (unsigned char *)("INP1:FILT OFF"), 13, &ret);
    stat = viWrite(sesn, (unsigned char *)("EVEN1:SLOP POS"), 14, &ret);
    stat = viWrite(sesn, (unsigned char *)("EVEN1:HYST:REL 50"), 17, &ret);
    stat = viWrite(sesn, (unsigned char *)("EVEN1:LEV:REL 50"), 16, &ret);
    stat = viWrite(sesn, (unsigned char *)("EVEN1:LEV:ABS:AUTO ON"), 21,
&ret);
    /*----- CH2 Input Condition -----*/
    stat = viWrite(sesn, (unsigned char *)("INP2:IMP 1000000"), 16, &ret);
    stat = viWrite(sesn, (unsigned char *)("INP2:COUP AC"), 12, &ret);
    stat = viWrite(sesn, (unsigned char *)("INP2:ATT 1"), 10, &ret);
    stat = viWrite(sesn, (unsigned char *)("INP2:FILT OFF"), 13, &ret);
    stat = viWrite(sesn, (unsigned char *)("EVEN2:SLOP POS"), 14, &ret);
    stat = viWrite(sesn, (unsigned char *)("EVEN2:HYST:REL 50"), 17, &ret);
    stat = viWrite(sesn, (unsigned char *)("EVEN2:LEV:REL 50"), 16, &ret);

```

```

    stat = viWrite(sesn, (unsigned char *)("EVEN2:LEV:ABS:AUTO ON"), 21,
&ret);
/*-----*/

/*----- Period measure -----*/
    stat = viWrite(sesn, (unsigned char *)("CONF:PER (@1)"), 13, &ret);
//  stat = viWrite(sesn, "CONF:PER (@2)", 13, &ret);
//  stat = viWrite(sesn, "CONF:PER (@3)", 13, &ret);
/*----- Gate Time -----*/
    stat = viWrite(sesn, (unsigned char *)("FREQ:ARM:SOUR IMM"), 17,
&ret);
    stat = viWrite(sesn, (unsigned char *)("FREQ:ARM:STOP:SOUR TIM"), 22,
&ret);
    stat = viWrite(sesn, (unsigned char *)("FREQ:ARM:STOP:TIM 1"), 19,
&ret);
/*----- Gate Ext -----*/
//  stat = viWrite(sesn, "FREQ:ARM:SOUR Ext", 17, &ret);
//  stat = viWrite(sesn, "FREQ:ARM:SLOP POS", 17, &ret);
//  stat = viWrite(sesn, "FREQ:ARM:STOP:SOUR Ext", 22, &ret);
//  stat = viWrite(sesn, "FREQ:ARM:STOP:SOUR TIM", 22, &ret);
//  stat = viWrite(sesn, "FREQ:ARM:STOP:TIM 1", 18, &ret);
/*----- Gate Auto -----*/
//  stat = viWrite(sesn, "FREQ:ARM:SOUR IMM", 17, &ret);
//  stat = viWrite(sesn, "FREQ:ARM:STOP:SOUR IMM", 22, &ret);
/*----- Gate Digits -----*/
//  stat = viWrite(sesn, "FREQ:ARM:SOUR IMM", 17, &ret);
//  stat = viWrite(sesn, "FREQ:ARM:STOP:SOUR DIG", 17, &ret);
//  stat = viWrite(sesn, "FREQ:ARM:STOP:DIG 5", 17, &ret);
/*-----*/

/*----- Rise/Fall Time, POS/NEG Width measure -----*/
//  stat = viWrite(sesn, "CONF:RISE:Time", 14, &ret);
//  stat = viWrite(sesn, "CONF:FALL:TIME", 14, &ret);
//  stat = viWrite(sesn, "CONF:PWID:TIME", 14, &ret);
//  stat = viWrite(sesn, "CONF:NWID:TIME", 14, &ret);
/*----- Gate Ext -----*/
//  stat = viWrite(sesn, "TINT:ARM:ESTART:LAY2:SOUR IMM", 29, &ret);

```

```

//  stat = viWrite(sesn, "TINT:ARM:ESTART:LAY2:SOUR EXT", 29, &ret);
//  stat = viWrite(sesn, "TINT:ARM:ESTART:LAY2:SLOP POS", 29, &ret);
/*----- Gate Auto -----*/
//  stat = viWrite(sesn, "TINT:ARM:ESTART:LAY2:SOUR IMM", 29, &ret);
/*-----*/

/*----- Intval 1 to 2 measure -----*/
//  stat = viWrite(sesn, "CONF:TINT (@1),(@2)", 19, &ret)
/*----- ARM Ext -----*/
//  stat = viWrite(sesn, "TINT:ARM:ESTART:LAY2:SOUR EXT", 29, &ret);
//  stat = viWrite(sesn, "TINT:ARM:ESTART:LAY2:SLOP POS", 29, &ret);
//  stat = viWrite(sesn, "TINT:ARM:ESTART:LAY1:SOUR TIM", 29, &ret);
//  stat = viWrite(sesn, "TINT:ARM:ESTART:LAY1:TIM 1Ms", 29, &ret);
//  stat = viWrite(sesn, "TINT:ARM:ESTOP:LAY2:SOUR EXT", 29, &ret);
//  stat = viWrite(sesn, "TINT:ARM:ESTOP:LAY2:SLOP POS", 29, &ret);
//  stat = viWrite(sesn, "TINT:ARM:ESTOP:LAY1:SOUR TIM, ret);
//
//                                stat = viWrite(sesn,
"TINT:ARM:ESTOP:LAY1:TIM 1mS", 29, &ret);
/*----- ARM Auto -----*/
//  stat = viWrite(sesn, "TINT:ARM:ESTART:LAY2:SOUR IMM", 29, &ret);
//  stat = viWrite(sesn, "TINT:ARM:ESTOP:LAY2:SOUR IMM", 29, &ret);
//  stat = viWrite(sesn, "TINT:ARM:ESTOP:LAY1:SOUR IMM", 29, &ret);
//  stat = viWrite(sesn, "TINT:ARM:ESTOP:LAY1:SOUR TIM", 29, &ret);
//  stat = viWrite(sesn, "TINT:ARM:ESTOP:LAY1:TIM 1mS", 29, &ret);
/*-----*/

/*----- Read From Device -----*/
    stat = viWrite(sesn, (unsigned char *)("FETC?"), 5, &ret);
//  stat = viWrite(sesn, "READ?", 5, &ret);
//  stat = viWrite(sesn, "MEAS:FREQ?", 10, &ret);
//  stat = viWrite(sesn, "SENS:DATA?", 10, &ret);
/*-----*/

    stat=viRead(sesn,(unsigned char *)readin,128,&ret);
    printf ("Read : %s",readin);
    stat = viSetAttribute(sesn, VI_ATTR_TMO_VALUE, tmo);
    stat = viGpibControlREN(sesn, VI_GPIB_REN_ADDRESS_GTL);

```

```

viClose (flist);
viClose (defaultRM);
return 0;
}

```

### **Example 3** Volt Peak measurement

```

// Volt_Peak.cpp : Defines the entry point for the console application.
#include "stdafx.h"
#include "visa.h"//include visa32.lib first to the probject.
#define MAX_COUNT 200
#include "stdio.h"

int main(int argc, char* argv[])
{
    ViStatus stat; /* For checking errors */
    ViSession defaultRM; /* Communication channels */
    ViSession sesn; /* Communication channel */
    ViChar rsrcName[VI_FIND_BUFLLEN]; /* Serial resource name */
    ViChar intfDesc[VI_FIND_BUFLLEN]; /* Port binding description */
    ViUInt32 ret; /* To hold number of resources */
    ViFindList flist; /* To hold list of resources */

    char readin[128]="";
    int tmo;

    printf("\n ##### Start C++ Example program. #####\n");
    printf(" We check the Counter on USB port and\n");
    printf(" identify the first connected device.\n\n");

    /* Begin by initializing the system */
    stat = viOpenDefaultRM(&defaultRM);

    if (stat < VI_SUCCESS) {
        /* Error Initializing VISA...exiting */
        printf ("Error Initializing NI-VISA...");
        return 0;
    }
}

```

```

    stat = viFindRsrc (defaultRM, "USB[0-9]::0x164E::0x1838::?*INSTR",
&flist, &ret, rsrcName);
    stat = viOpen (defaultRM, rsrcName, VI_NULL, VI_NULL, &sesn);
    if (stat < VI_SUCCESS)
    {
        printf ("Could not open %s, status = 0x%08IX\n",rsrcName, stat);
        return 0;
    }
    else
    {
        stat = viGetAttribute (sesn, VI_ATTR_INTF_INST_NAME, intfDesc);
        printf ("Resource %s, Description %s\n", rsrcName, intfDesc);
    }
    stat = viFindNext (flist, rsrcName);

//Setting Process Timeout
stat = viGetAttribute(sesn, VI_ATTR_TMO_VALUE, &tmo);
stat = viSetAttribute(sesn, VI_ATTR_TMO_VALUE, 30000);

//send reset command '*RST' -- reset U6200A
stat = viWrite(sesn, (unsigned char *)("*RST"), 4, &ret);

//send Clear command '*CLS'-- Clear U6200A status register
stat = viWrite(sesn, (unsigned char *)("*CLS"), 4, &ret);

//send reset command 'INIT:CONT ON' -- Initial U6200A
stat = viWrite(sesn, (unsigned char *)("INIT:CONT ON"), 12, &ret);

//Send commands befor measure (required)

/*----- CH1 Input Condition -----*/
stat = viWrite(sesn, (unsigned char *)("INP1:IMP 1000000"), 16, &ret);
stat = viWrite(sesn, (unsigned char *)("INP1:COUP AC"), 12, &ret);
stat = viWrite(sesn, (unsigned char *)("INP1:ATT 1"), 10, &ret);
stat = viWrite(sesn, (unsigned char *)("INP1:FILT OFF"), 13, &ret);
stat = viWrite(sesn, (unsigned char *)("EVEN1:SLOP POS"), 14, &ret);
stat = viWrite(sesn, (unsigned char *)("EVEN1:HYST:REL 50"), 17, &ret);

```



```

stat = viWrite(sesn, (unsigned char *)("EVEN1:LEV:REL 50"), 16, &ret);
stat = viWrite(sesn, (unsigned char *)("EVEN1:LEV:ABS:AUTO ON"), 21,
&ret);
/*----- CH2 Input Condition -----*/
stat = viWrite(sesn, (unsigned char *)("INP2:IMP 1000000"), 16, &ret);
stat = viWrite(sesn, (unsigned char *)("INP2:COUP AC"), 12, &ret);
stat = viWrite(sesn, (unsigned char *)("INP2:ATT 1"), 10, &ret);
stat = viWrite(sesn, (unsigned char *)("INP2:FILT OFF"), 13, &ret);
stat = viWrite(sesn, (unsigned char *)("EVEN2:SLOP POS"), 14, &ret);
stat = viWrite(sesn, (unsigned char *)("EVEN2:HYST:REL 50"), 17, &ret);
stat = viWrite(sesn, (unsigned char *)("EVEN2:LEV:REL 50"), 16, &ret);
stat = viWrite(sesn, (unsigned char *)("EVEN2:LEV:ABS:AUTO ON"), 21,
&ret);
/*-----*/

/*----- Volt Peak measure -----*/
stat = viWrite(sesn, (unsigned char *)("CONF:VOLT:PTP (@1)"), 18, &ret);
// stat = viWrite(sesn, "CONF:VOLT:PTP (@2)", 18, &ret);
// stat = viWrite(sesn, "CONF:VOLT:MAX (@1)", 18, &ret);
// stat = viWrite(sesn, "CONF:VOLT:MAX (@2)", 18, &ret);
// stat = viWrite(sesn, "CONF:VOLT:MIN (@1)", 18, &ret);
// stat = viWrite(sesn, "CONF:VOLT:MIN (@2)", 18, &ret);
// stat = viWrite(sesn, "CONF:VOLT:CENT (@1)", 19, &ret);
// stat = viWrite(sesn, "CONF:VOLT:CENT (@2)", 19, &ret);
/*-----*/

/*----- Read From Device -----*/
stat = viWrite(sesn, (unsigned char *)("FETC?"), 5, &ret);
// stat = viWrite(sesn, "READ?", 5, &ret);
// stat = viWrite(sesn, "MEAS:FREQ?", 10, &ret);
// stat = viWrite(sesn, "SENS:DATA?", 10, &ret);
/*-----*/

stat=viRead(sesn,(unsigned char *)readin,128,&ret);
printf ("Read : %s",readin);
stat = viSetAttribute(sesn, VI_ATTR_TMO_VALUE, tmo);
stat = viGpibControlREN(sesn, VI_GPIB_REN_ADDRESS_GTL);

```

```

    viClose (flist);
    viClose (defaultRM);
    return 0;
}

```

#### **Example 4** Other Measurement

// OtherMeas.cpp : Defines the entry point for the console application.

```

#include "stdafx.h"
#include "visa.h"//include visa32.lib first to the project.
#define MAX_COUNT 200
#include "stdio.h"

int main(int argc, char* argv[])
{
    ViStatus stat; /* For checking errors */
    ViSession defaultRM; /* Communication channels */
    ViSession sesn; /* Communication channel */
    ViChar rsrcName[VI_FIND_BUFLen]; /* Serial resource name */
    ViChar intfDesc[VI_FIND_BUFLen]; /* Port binding description */
    ViUInt32 ret; /* To hold number of resources */
    ViFindList flist; /* To hold list of resources */

    char readin[128]="";
    int tmo;

    printf("\n ##### Start C++ Example program. #####\n");
    printf(" We check the Counter on USB port and\n");
    printf(" identify the first connected device.\n\n");

    /* Begin by initializing the system */
    stat = viOpenDefaultRM(&defaultRM);

    if (stat < VI_SUCCESS) {
        /* Error Initializing VISA...exiting */
        printf ("Error Initializing NI-VISA...");
        return 0;
    }
}

```

```

    stat = viFindRsrc (defaultRM, "USB[0-9]::0x164E::0x1838::?*INSTR",
&flist, &ret, rsrcName);

stat = viOpen (defaultRM, rsrcName, VI_NULL, VI_NULL, &sesn);
if (stat < VI_SUCCESS)
{
    printf ("Could not open %s, status = 0x%08IX\n",rsrcName, stat);
    return 0;
}
else
{
    stat = viGetAttribute (sesn, VI_ATTR_INTF_INST_NAME, intfDesc);
    printf ("Resource %s, Description %s\n", rsrcName, intfDesc);
}
stat = viFindNext (flist, rsrcName);

//Setting Process Timeout
stat = viGetAttribute(sesn, VI_ATTR_TMO_VALUE, &tmo);
stat = viSetAttribute(sesn, VI_ATTR_TMO_VALUE, 30000);

//send reset command '*RST' -- reset U6200A
stat = viWrite(sesn, (unsigned char *)("*RST"), 4, &ret);

//send Clear command '*CLS'-- Clear U6200A status register
stat = viWrite(sesn, (unsigned char *)("*CLS"), 4, &ret);

//send reset command 'INIT:CONT ON' -- Initial U6200A
stat = viWrite(sesn, (unsigned char *)("INIT:CONT ON"), 12, &ret);

//Send commands befor measure (required)

/*----- CH1 Input Condition -----*/
stat = viWrite(sesn, (unsigned char *)("INP1:IMP 1000000"), 16, &ret);
stat = viWrite(sesn, (unsigned char *)("INP1:COUP AC"), 12, &ret);
stat = viWrite(sesn, (unsigned char *)("INP1:ATT 1"), 10, &ret);
stat = viWrite(sesn, (unsigned char *)("INP1:FILT OFF"), 13, &ret);
stat = viWrite(sesn, (unsigned char *)("EVEN1:SLOP POS"), 14, &ret);

```

```

stat = viWrite(sesn, (unsigned char *)("EVEN1:HYST:REL 50"), 17, &ret);
stat = viWrite(sesn, (unsigned char *)("EVEN1:LEV:REL 50"), 16, &ret);
stat = viWrite(sesn, (unsigned char *)("EVEN1:LEV:ABS:AUTO ON"), 21,
&ret);
/*----- CH2 Input Condition -----*/
stat = viWrite(sesn, (unsigned char *)("INP2:IMP 1000000"), 16, &ret);
stat = viWrite(sesn, (unsigned char *)("INP2:COUP AC"), 12, &ret);
stat = viWrite(sesn, (unsigned char *)("INP2:ATT 1"), 10, &ret);
stat = viWrite(sesn, (unsigned char *)("INP2:FILT OFF"), 13, &ret);
stat = viWrite(sesn, (unsigned char *)("EVEN2:SLOP POS"), 14, &ret);
stat = viWrite(sesn, (unsigned char *)("EVEN2:HYST:REL 50"), 17, &ret);
stat = viWrite(sesn, (unsigned char *)("EVEN2:LEV:REL 50"), 16, &ret);
stat = viWrite(sesn, (unsigned char *)("EVEN2:LEV:ABS:AUTO ON"), 21,
&ret);
/*-----*/

/*----- Phase measure -----*/
stat = viWrite(sesn, (unsigned char *)("CONF:PHAS (@1),(@2)"), 19,
&ret);
/*----- Gate Ext -----*/
stat = viWrite(sesn, (unsigned char *)("PHAS:ARM:SOUR IMM"), 17,
&ret);
stat = viWrite(sesn, (unsigned char *)("PHAS:ARM:SOUR EXT"), 17, &ret);
stat = viWrite(sesn, (unsigned char *)("PHAS:ARM:SLOP POS"), 17, &ret);
/*----- Gate Auto -----*/
// stat = viWrite(sesn, "PHAS:ARM:SOUR EXT", 17, &ret);
// stat = viWrite(sesn, "PHAS:ARM:SLOP POS", 17, &ret);
/*-----*/

/*----- Duty Cycle measure -----*/
// stat = viWrite(sesn, "CONF:DCYC (@1),(@2)", 19, &ret);
/*----- Gate Ext -----*/
// stat = viWrite(sesn, "TINT:ARM:ESTART:LAY2:SOUR IMM", 29, &ret);
// stat = viWrite(sesn, "TINT:ARM:ESTART:LAY2:SOUR EXT", 29, &ret);
// stat = viWrite(sesn, "TINT:ARM:ESTART:LAY2:SLOP POS", 29, &ret);
/*----- Gate Auto -----*/
// stat = viWrite(sesn, "TINT:ARM:ESTART:LAY2:SOUR IMM", 29, &ret);

```

```

/*-----*/

/*----- Total CH1 measure -----*/
// stat = viWrite(sesn, "CONF:TOT:TIM (@1) ", 18, &ret);
/*----- Gate Ext -----*/
// stat = viWrite(sesn, "TOT:ARM:SOUR IMM", 16, &ret);
// stat = viWrite(sesn, "TOT:ARM:STOP:SOUR TIM", 21, &ret);
// stat = viWrite(sesn, "TOT:ARM:STOP:TIM 1", 18, &ret);
/*----- Gate Time -----*/
// stat = viWrite(sesn, "TOT:ARM:SOUR IMM", 16, &ret)
// stat = viWrite(sesn, "TOT:ARM:STOP:SOUR TIM", 21, &ret);
// stat = viWrite(sesn, "TOT:ARM:STOP:TIM 1", 18, &ret);
/*----- ARM Auto -----*/
// stat = viWrite(sesn, "TOT:ARM:SOUR IMM", 16, &ret)
// stat = viWrite(sesn, "TOT:ARM:STOP:SOUR IMM", 21, &ret);
/*-----*/

/*----- Read From Device -----*/
    stat = viWrite(sesn, (unsigned char *)("FETC?"), 5, &ret);
// stat = viWrite(sesn, "READ?", 5, &ret);
// stat = viWrite(sesn, "MEAS:FREQ?", 10, &ret);
// stat = viWrite(sesn, "SENS:DATA?", 10, &ret);
/*-----*/

    stat=viRead(sesn,(unsigned char *)readin,128,&ret);
    printf ("Read : %s",readin);
    stat = viSetAttribute(sesn, VI_ATTR_TMO_VALUE, tmo);
    stat = viGpibControlREN(sesn, VI_GPIB_REN_ADDRESS_GTL);
    viClose (flist);
    viClose (defaultRM);
    return 0;
}

```

## Using Scale & Offset to Measurement

### Example 5 Scale & Offset

```

// Scal_Offset.cpp : Defines the entry point for the console application.
#include "stdafx.h"

```

```

#include "visa.h">//include visa32.lib first to the probject.
#define MAX_COUNT 200
#include "stdio.h"

int main(int argc, char* argv[])
{
    ViStatus stat; /* For checking errors */
    ViSession defaultRM; /* Communication channels */
    ViSession sesn; /* Communication channel */
    ViChar rsrcName[VI_FIND_BUFLLEN]; /* Serial resource name */
    ViChar intfDesc[VI_FIND_BUFLLEN]; /* Port binding description */
    ViUInt32 ret; /* To hold number of resources */
    ViFindList flist; /* To hold list of resources */

    char readin[128]="";
    int tmo;

    printf("\n ##### Start C++ Example program. #####\n");
    printf(" We check the Counter on USB port and\n");
    printf(" identify the first connected device.\n\n");

    /* Begin by initializing the system */
    stat = viOpenDefaultRM(&defaultRM);

    if (stat < VI_SUCCESS) {
        /* Error Initializing VISA...exiting */
        printf ("Error Initializing NI-VISA...");
        return 0;
    }
    stat = viFindRsrc (defaultRM, "USB[0-9]::0x164E::0x1838::?*INSTR",
&flist, &ret, rsrcName);

    stat = viOpen (defaultRM, rsrcName, VI_NULL, VI_NULL, &sesn);
    if (stat < VI_SUCCESS)
    {
        printf ("Could not open %s, status = 0x%08IX\n",rsrcName, stat);
        return 0;
    }
}

```

```

}
else
{
    stat = viGetAttribute (sesn, VI_ATTR_INTF_INST_NAME, intfDesc);
    printf ("Resource %s, Description %s\n", rsrcName, intfDesc);
}
stat = viFindNext (flist, rsrcName);

//Setting Process Timeout
stat = viGetAttribute(sesn, VI_ATTR_TMO_VALUE, &tmo);
stat = viSetAttribute(sesn, VI_ATTR_TMO_VALUE, 30000);

//send reset command '*RST' -- reset U6200A
stat = viWrite(sesn, (unsigned char *)("*RST"), 4, &ret);

//send Clear command '*CLS'-- Clear U6200A status register
stat = viWrite(sesn, (unsigned char *)("*CLS"), 4, &ret);

//send reset command 'INIT:CONT ON' -- Initial U6200A
stat = viWrite(sesn, (unsigned char *)("INIT:CONT ON"), 12, &ret);

//Send commands befor measure (required)
/*----- CH1 Input Condition -----*/
stat = viWrite(sesn, (unsigned char *)("INP1:IMP 1000000"), 16, &ret);
stat = viWrite(sesn, (unsigned char *)("INP1:COUP AC"), 12, &ret);
stat = viWrite(sesn, (unsigned char *)("INP1:ATT 1"), 10, &ret);
stat = viWrite(sesn, (unsigned char *)("INP1:FILT OFF"), 13, &ret);
stat = viWrite(sesn, (unsigned char *)("EVEN1:SLOP POS"), 14, &ret);
stat = viWrite(sesn, (unsigned char *)("EVEN1:HYST:REL 50"), 17, &ret);
stat = viWrite(sesn, (unsigned char *)("EVEN1:LEV:REL 50"), 16, &ret);
stat = viWrite(sesn, (unsigned char *)("EVEN1:LEV:ABS:AUTO ON"), 21,
&ret);
/*----- CH2 Input Condition -----*/
stat = viWrite(sesn, (unsigned char *)("INP2:IMP 1000000"), 16, &ret);
stat = viWrite(sesn, (unsigned char *)("INP2:COUP AC"), 12, &ret);
stat = viWrite(sesn, (unsigned char *)("INP2:ATT 1"), 10, &ret);
stat = viWrite(sesn, (unsigned char *)("INP2:FILT OFF"), 13, &ret);

```

```

stat = viWrite(sesn, (unsigned char *)("EVEN2:SLOP POS"), 14, &ret);
stat = viWrite(sesn, (unsigned char *)("EVEN2:HYST:REL 50"), 17, &ret);
stat = viWrite(sesn, (unsigned char *)("EVEN2:LEV:REL 50"), 16, &ret);
stat = viWrite(sesn, (unsigned char *)("EVEN2:LEV:ABS:AUTO ON"), 21,
&ret);
/*-----*/

/*----- Freq & Ratio measure -----*/
stat = viWrite(sesn, (unsigned char *)("CONF:FREQ (@1)"), 14, &ret);
// stat = viWrite(sesn, "CONF:FREQ (@2)", 14, &ret);
// stat = viWrite(sesn, "CONF:FREQ (@3)", 14, &ret);
// stat = viWrite(sesn, "CONF:FREQ:RAT (@1),(@2)", 23, &ret);
// stat = viWrite(sesn, "CONF:FREQ:RAT (@1),(@3)", 23, &ret);
// stat = viWrite(sesn, "CONF:FREQ:RAT (@2),(@1)", 23, &ret);
// stat = viWrite(sesn, "CONF:FREQ:RAT (@3),(@1)", 23, &ret);
/*----- Gate Time -----*/
stat = viWrite(sesn, (unsigned char *)("FREQ:ARM:SOUR IMM"), 17,
&ret);
stat = viWrite(sesn, (unsigned char *)("FREQ:ARM:STOP:SOUR TIM"), 22,
&ret);
stat = viWrite(sesn, (unsigned char *)("FREQ:ARM:STOP:TIM 1"), 19,
&ret);
/*----- Gate Ext -----*/
// stat = viWrite(sesn, "FREQ:ARM:SOUR Ext", 17, &ret);
// stat = viWrite(sesn, "FREQ:ARM:SLOP POS", 17, &ret);
// stat = viWrite(sesn, "FREQ:ARM:STOP:SOUR Ext", 22, &ret);
// stat = viWrite(sesn, "FREQ:ARM:STOP:SOUR TIM", 22, &ret);
// stat = viWrite(sesn, "FREQ:ARM:STOP:TIM 1", 19, &ret);
/*----- Gate Auto -----*/
// stat = viWrite(sesn, "FREQ:ARM:SOUR IMM", 17, &ret);
// stat = viWrite(sesn, "FREQ:ARM:STOP:SOUR IMM", 22, &ret);
/*----- Gate Digits -----*/
// stat = viWrite(sesn, "FREQ:ARM:SOUR IMM", 17, &ret);
// stat = viWrite(sesn, "FREQ:ARM:STOP:SOUR DIG", 22, &ret);
// stat = viWrite(sesn, "FREQ:ARM:STOP:DIG 5", 19, &ret);
/*-----*/

```



```

/*----- Scale & Offset -----*/
    stat = viWrite(sesn, (unsigned char *)("TRAC:DATA SCALE,3"), 17, &ret);
    stat = viWrite(sesn, (unsigned char *)("TRAC:DATA OFFSET,5MHz"), 21,
&ret);
/*-----*/

/*----- Read From Device -----*/
    stat = viWrite(sesn, (unsigned char *)("FETC?"), 5, &ret);
//    stat = viWrite(sesn, "READ?", 5, &ret);
//    stat = viWrite(sesn, "MEAS:FREQ?", 10, &ret);
//    stat = viWrite(sesn, "SENS:DATA?", 10, &ret);
/*-----*/

    stat=viRead(sesn,(unsigned char *)readin,128,&ret);
    printf ("Read : %s",readin);
    stat = viSetAttribute(sesn, VI_ATTR_TMO_VALUE, tmo);
    stat = viGpibControlREN(sesn, VI_GPIB_REN_ADDRESS_GTL);
    viClose (flist);
    viClose (defaultRM);
    return 0;
}

```

## Using the Limit to Measurement

### Example 6 Limit Modes

// Limit.cpp : Defines the entry point for the console application.

```

#include "stdafx.h"
#include "visa.h"//include visa32.lib first to the project.
#define MAX_COUNT 200
#include "stdio.h"

int main(int argc, char* argv[])
{
    ViStatus stat; /* For checking errors */
    ViSession defaultRM; /* Communication channels */
    ViSession sesn; /* Communication channel */
    ViChar rsrcName[VI_FIND_BUFLen]; /* Serial resource name */

```

```

ViChar intfDesc[VI_FIND_BUFLLEN]; /* Port binding description */
ViUInt32 ret; /* To hold number of resources */
ViFindList flist; /* To hold list of resources */

char readin[128]="";
int tmo;

printf("\n ##### Start C++ Example program. #####\n");
printf(" We check the Counter on USB port and\n");
printf(" identify the first connected device.\n\n");

/* Begin by initializing the system */
stat = viOpenDefaultRM(&defaultRM);

if (stat < VI_SUCCESS) {
    /* Error Initializing VISA...exiting */
    printf ("Error Initializing NI-VISA...");
    return 0;
}
stat = viFindRsrc (defaultRM, "USB[0-9]::0x164E::0x1838::?*INSTR",
&flist, &ret, rsrcName);

stat = viOpen (defaultRM, rsrcName, VI_NULL, VI_NULL, &sesn);
if (stat < VI_SUCCESS)
{
    printf ("Could not open %s, status = 0x%08IX\n",rsrcName, stat);
    return 0;
}
else
{
    stat = viGetAttribute (sesn, VI_ATTR_INTF_INST_NAME, intfDesc);
    printf ("Resource %s, Description %s\n", rsrcName, intfDesc);
}
stat = viFindNext (flist, rsrcName);

//Setting Process Timeout
stat = viGetAttribute(sesn, VI_ATTR_TMO_VALUE, &tmo);

```

```

stat = viSetAttribute(sesn, VI_ATTR_TMO_VALUE, 30000);

//send reset command '*RST' -- reset U6200A
stat = viWrite(sesn, (unsigned char *)("*RST"), 4, &ret);

//send Clear command '*CLS'-- Clear U6200A status register
stat = viWrite(sesn, (unsigned char *)("*CLS"), 4, &ret);

//send reset command 'INIT:CONT ON' -- Initial U6200A
stat = viWrite(sesn, (unsigned char *)("INIT:CONT ON"), 12, &ret);

//Send commands before measure (required)
/*----- CH1 Input Condition -----*/
stat = viWrite(sesn, (unsigned char *)("INP1:IMP 1000000"), 16, &ret);
stat = viWrite(sesn, (unsigned char *)("INP1:COUP AC"), 12, &ret);
stat = viWrite(sesn, (unsigned char *)("INP1:ATT 1"), 10, &ret);
stat = viWrite(sesn, (unsigned char *)("INP1:FILT OFF"), 13, &ret);
stat = viWrite(sesn, (unsigned char *)("EVEN1:SLOP POS"), 14, &ret);
stat = viWrite(sesn, (unsigned char *)("EVEN1:HYST:REL 50"), 17, &ret);
stat = viWrite(sesn, (unsigned char *)("EVEN1:LEV:REL 50"), 16, &ret);
stat = viWrite(sesn, (unsigned char *)("EVEN1:LEV:ABS:AUTO ON"), 21,
&ret);
/*----- CH2 Input Condition -----*/
stat = viWrite(sesn, (unsigned char *)("INP2:IMP 1000000"), 16, &ret);
stat = viWrite(sesn, (unsigned char *)("INP2:COUP AC"), 12, &ret);
stat = viWrite(sesn, (unsigned char *)("INP2:ATT 1"), 10, &ret);
stat = viWrite(sesn, (unsigned char *)("INP2:FILT OFF"), 13, &ret);
stat = viWrite(sesn, (unsigned char *)("EVEN2:SLOP POS"), 14, &ret);
stat = viWrite(sesn, (unsigned char *)("EVEN2:HYST:REL 50"), 17, &ret);
stat = viWrite(sesn, (unsigned char *)("EVEN2:LEV:REL 50"), 16, &ret);
stat = viWrite(sesn, (unsigned char *)("EVEN2:LEV:ABS:AUTO ON"), 21,
&ret);
/*-----*/

/*----- Freq & Ratio measure -----*/
stat = viWrite(sesn, (unsigned char *)("CONF:FREQ (@1)"), 14, &ret);

```

```

//  stat = viWrite(sesn, "CONF:FREQ (@2)", 14, &ret);
//  stat = viWrite(sesn, "CONF:FREQ (@3)", 14, &ret);
//  stat = viWrite(sesn, "CONF:FREQ:RAT (@1),(@2)", 23, &ret);
//  stat = viWrite(sesn, "CONF:FREQ:RAT (@1),(@3)", 23, &ret);
//  stat = viWrite(sesn, "CONF:FREQ:RAT (@2),(@1)", 23, &ret);
//  stat = viWrite(sesn, "CONF:FREQ:RAT (@3),(@1)", 23, &ret);
/*-----*/

/*----- Gate Time -----*/
    stat = viWrite(sesn, (unsigned char *)("FREQ:ARM:SOUR IMM"), 17,
&ret);
    stat = viWrite(sesn, (unsigned char *)("FREQ:ARM:STOP:SOUR TIM"), 22,
&ret);
    stat = viWrite(sesn, (unsigned char *)("FREQ:ARM:STOP:TIM 1"), 19,
&ret);
/*----- Gate Ext -----*/
//  stat = viWrite(sesn, "FREQ:ARM:SOUR Ext", 17, &ret);
//  stat = viWrite(sesn, "FREQ:ARM:SLOP POS", 17, &ret);
//  stat = viWrite(sesn, "FREQ:ARM:STOP:SOUR Ext", 22, &ret);
//  stat = viWrite(sesn, "FREQ:ARM:STOP:SOUR TIM", 22, &ret);
//  stat = viWrite(sesn, "FREQ:ARM:STOP:TIM 1", 19, &ret);
/*----- Gate Auto -----*/
//  stat = viWrite(sesn, "FREQ:ARM:SOUR IMM", 17, &ret);
//  stat = viWrite(sesn, "FREQ:ARM:STOP:SOUR IMM", 22, &ret);
/*----- Gate Digits -----*/
//  stat = viWrite(sesn, "FREQ:ARM:SOUR IMM", 17, &ret);
//  stat = viWrite(sesn, "FREQ:ARM:STOP:SOUR DIG", 22, &ret);
//  stat = viWrite(sesn, "FREQ:ARM:STOP:DIG 5", 19, &ret);
/*-----*/

/*----- Scale & Offset -----*/
    stat = viWrite(sesn, (unsigned char *)("CALC2:LIM:STAT ON"), 17, &ret);
    stat = viWrite(sesn, (unsigned char *)("CALC2:LIM:UPP 11MHz"), 19,
&ret);
    stat = viWrite(sesn, (unsigned char *)("CALC2:LIM:LOW 9MHz"), 18,
&ret);
    stat = viWrite(sesn, (unsigned char *)("CALC2:IMM:AUTO ON"), 17, &ret);

```

```

    stat = viWrite(sesn, (unsigned char *)("INIT:AUTO OFF"), 13, &ret);
    stat = viWrite(sesn, (unsigned char *)("INIT:CONT ON"), 12, &ret);
/*-----*/

/*----- Read From Device -----*/
    stat = viWrite(sesn, (unsigned char *)("FETC?"), 5, &ret);
//  stat = viWrite(sesn, "READ?", 5, &ret);
//  stat = viWrite(sesn, "MEAS:FREQ?", 10, &ret);
//  stat = viWrite(sesn, "SENS:DATA?", 10, &ret);
/*-----*/

    stat=viRead(sesn,(unsigned char *)readin,128,&ret);
    printf ("Read : %s",readin);
    stat = viSetAttribute(sesn, VI_ATTR_TMO_VALUE, tmo);
    stat = viGpibControlREN(sesn, VI_GPIB_REN_ADDRESS_GTL);
    viClose (flist);
    viClose (defaultRM);
    return 0;
}

```

## Using the Stats to Measurement

### Example 7 Stats Modes

```

// Stats.cpp : Defines the entry point for the console application.
#include "stdafx.h"
#include "visa.h"//include visa32.lib first to the probject.
#define MAX_COUNT 200
#include "stdio.h"

int main(int argc, char* argv[])
{
    ViStatus stat; /* For checking errors */
    ViSession defaultRM; /* Communication channels */
    ViSession sesn; /* Communication channel */
    ViChar rsrcName[VI_FIND_BUFLen]; /* Serial resource name */
    ViChar intfDesc[VI_FIND_BUFLen]; /* Port binding description */
    ViUInt32 ret; /* To hold number of resources */
    ViFindList flist; /* To hold list of resources */

```

```

char readin[128]="";
int tmo;

printf("\n ##### Start C++ Example program. #####\n");
printf(" We check the Counter on USB port and\n");
printf(" identify the first connected device.\n\n");

/* Begin by initializing the system */
stat = viOpenDefaultRM(&defaultRM);

if (stat < VI_SUCCESS) {
    /* Error Initializing VISA...exiting */
    printf ("Error Initializing NI-VISA...");
    return 0;
}
stat = viFindRsrc (defaultRM, "USB[0-9]::0x164E::0x1838::?*INSTR",
&flist, &ret, rsrcName);

stat = viOpen (defaultRM, rsrcName, VI_NULL, VI_NULL, &sesn);
if (stat < VI_SUCCESS)
{
    printf ("Could not open %s, status = 0x%08IX\n",rsrcName, stat);
    return 0;
}
else
{
    stat = viGetAttribute (sesn, VI_ATTR_INTF_INST_NAME, intfDesc);
    printf ("Resource %s, Description %s\n", rsrcName, intfDesc);
}
stat = viFindNext (flist, rsrcName);

//Setting Process Timeout
stat = viGetAttribute(sesn, VI_ATTR_TMO_VALUE, &tmo);
stat = viSetAttribute(sesn, VI_ATTR_TMO_VALUE, 30000);

//send reset command '*RST' -- reset U6200A

```

```

stat = viWrite(sesn, (unsigned char *)("*RST"), 4, &ret);

//send Clear command '*CLS'-- Clear U6200A status register
stat = viWrite(sesn, (unsigned char *)("*CLS"), 4, &ret);

//send reset command 'INIT:CONT ON' -- Initial U6200A
stat = viWrite(sesn, (unsigned char *)("INIT:CONT ON"), 12, &ret);

//Send commands befor measure (required)
/*----- CH1 Input Condition -----*/
stat = viWrite(sesn, (unsigned char *)("INP1:IMP 1000000"), 16, &ret);
stat = viWrite(sesn, (unsigned char *)("INP1:COUP AC"), 12, &ret);
stat = viWrite(sesn, (unsigned char *)("INP1:ATT 1"), 10, &ret);
stat = viWrite(sesn, (unsigned char *)("INP1:FILT OFF"), 13, &ret);
stat = viWrite(sesn, (unsigned char *)("EVEN1:SLOP POS"), 14, &ret);
stat = viWrite(sesn, (unsigned char *)("EVEN1:HYST:REL 50"), 17, &ret);
stat = viWrite(sesn, (unsigned char *)("EVEN1:LEV:REL 50"), 16, &ret);
stat = viWrite(sesn, (unsigned char *)("EVEN1:LEV:ABS:AUTO ON"), 21,
&ret);
/*----- CH2 Input Condition -----*/
stat = viWrite(sesn, (unsigned char *)("INP2:IMP 1000000"), 16, &ret);
stat = viWrite(sesn, (unsigned char *)("INP2:COUP AC"), 12, &ret);
stat = viWrite(sesn, (unsigned char *)("INP2:ATT 1"), 10, &ret);
stat = viWrite(sesn, (unsigned char *)("INP2:FILT OFF"), 13, &ret);
stat = viWrite(sesn, (unsigned char *)("EVEN2:SLOP POS"), 14, &ret);
stat = viWrite(sesn, (unsigned char *)("EVEN2:HYST:REL 50"), 17, &ret);
stat = viWrite(sesn, (unsigned char *)("EVEN2:LEV:REL 50"), 16, &ret);
stat = viWrite(sesn, (unsigned char *)("EVEN2:LEV:ABS:AUTO ON"), 21,
&ret);
/*-----*/

/*----- Freq & Ratio measure -----*/
stat = viWrite(sesn, (unsigned char *)("CONF:FREQ (@1)"), 14, &ret);
// stat = viWrite(sesn, "CONF:FREQ (@2)", 14, &ret);
// stat = viWrite(sesn, "CONF:FREQ (@3)", 14, &ret);
// stat = viWrite(sesn, "CONF:FREQ:RAT (@1),(@2)", 23, &ret);
// stat = viWrite(sesn, "CONF:FREQ:RAT (@1),(@3)", 23, &ret);

```

```

// stat = viWrite(sesn, "CONF:FREQ:RAT (@2),(@1)", 23, &ret);
// stat = viWrite(sesn, "CONF:FREQ:RAT (@3),(@1)", 23, &ret);
/*-----*/

/*----- Gate Time -----*/
    stat = viWrite(sesn, (unsigned char *)("FREQ:ARM:SOUR IMM"), 17,
&ret);
    stat = viWrite(sesn, (unsigned char *)("FREQ:ARM:STOP:SOUR TIM"), 22,
&ret);
    stat = viWrite(sesn, (unsigned char *)("FREQ:ARM:STOP:TIM 1"), 19,
&ret);
/*----- Gate Ext -----*/
// stat = viWrite(sesn, "FREQ:ARM:SOUR Ext", 17, &ret);
// stat = viWrite(sesn, "FREQ:ARM:SLOP POS", 17, &ret);
// stat = viWrite(sesn, "FREQ:ARM:STOP:SOUR Ext", 22, &ret);
// stat = viWrite(sesn, "FREQ:ARM:STOP:SOUR TIM", 22, &ret);
// stat = viWrite(sesn, "FREQ:ARM:STOP:TIM 1", 19, &ret);
/*----- Gate Auto -----*/
// stat = viWrite(sesn, "FREQ:ARM:SOUR IMM", 17, &ret);
// stat = viWrite(sesn, "FREQ:ARM:STOP:SOUR IMM", 22, &ret);
/*----- Gate Digits -----*/
// stat = viWrite(sesn, "FREQ:ARM:SOUR IMM", 17, &ret);
// stat = viWrite(sesn, "FREQ:ARM:STOP:SOUR DIG", 22, &ret);
// stat = viWrite(sesn, "FREQ:ARM:STOP:DIG 5", 19, &ret);
/*-----*/

/*----- Scale & Offset -----*/
    stat = viWrite(sesn, (unsigned char *)("CALC3:AVER:STAT ON"), 18,
&ret);
    stat = viWrite(sesn, (unsigned char *)("CALC3:AVER:COUN 10"), 18,
&ret);
    stat = viWrite(sesn, (unsigned char *)("CALC3:LFIL:stat OFF"), 19, &ret);
    stat = viWrite(sesn, (unsigned char *)("CALC3:AVER:Type SDEV"), 20,
&ret);
    stat = viWrite(sesn, (unsigned char *)("TRIG:COUN:AUTO OFF"), 18,
&ret);
    stat = viWrite(sesn, (unsigned char *)("INIT:CONT ON"), 12, &ret);

```



```

/*-----*/

/*----- Read From Device -----*/
    stat = viWrite(sesn, (unsigned char *)("FETC?"), 5, &ret);
//  stat = viWrite(sesn, "READ?", 5, &ret);
//  stat = viWrite(sesn, "MEAS:FREQ?", 10, &ret);
//  stat = viWrite(sesn, "SENS:DATA?", 10, &ret);
/*-----*/

    stat=viRead(sesn,(unsigned char *)readin,128,&ret);
    printf ("Read : %s",readin);
    stat = viSetAttribute(sesn, VI_ATTR_TMO_VALUE, tmo);
    stat = viGpibControlREN(sesn, VI_GPIB_REN_ADDRESS_GTL);
    viClose (flist);
    viClose (defaultRM);
    return 0;
}

```