



User's Guide



<http://www.omega.com>
[e-mail: info@omega.com](mailto:info@omega.com)

OM-320



OMEGAnetSM On-Line Service http://www.omega.com	Internet e-mail info@omega.com
---	--

Servicing North America:

USA: One Omega Drive, Box 4047
ISO 9001 Certified Stamford, CT 06907-0047
Tel: (203) 359-1660 FAX: (203) 359-7700
e-mail: info@omega.com

Canada: 976 Berger
Laval (Quebec) H7L 5A1
Tel: (514) 856-6928 FAX: (514) 856-6886
e-mail: canada@omega.com

For immediate technical or application assistance:

USA and Canada: Sales Service: 1-800-826-6342 / 1-800-TC-OMEGASM
Customer Service: 1-800-622-2378 / 1-800-622-BESTSM
Engineering Service: 1-800-872-9436 / 1-800-USA-WHENSM
TELEX: 996404 EASYLINK: 62968934 CABLE: OMEGA

Mexico and Latin America: Tel: (95) 800-TC-OMEGASM FAX: (95) 203-359-7807
En Espanol: (95) 203-359-7803 e-mail: espanol@omega.com

Servicing Europe:

Benelux: Postbus 8034, 1180 LA Amstelveen, The Netherlands
Tel: (31) 20 6418405 FAX: (31) 20 6434643
Toll Free in Benelux: 06 0993344
e-mail: nl@omega.com

Czech Republic: ul. Rude armady 1868
733 01 Karvina-Hranice
Tel: 420 (69) 6311899 FAX: 420 (69) 6311114
e-mail: czech@omega.com

France: 9, rue Denis Papin, 78190 Trappes
Tel: (33) 130-621-400 FAX: (33) 130-699-120
Toll Free in France: 0800-4-06342
e-mail: france@omega.com

Germany/Austria: Daimlerstrasse 26, D-75392 Deckenpfronn, Germany
Tel: 49 (07056) 3017 FAX: 49 (07056) 8540
Toll Free in Germany: 0130 11 21 66
e-mail: germany@omega.com

United Kingdom: 25 Swannington Road, P.O. Box 7, Omega Drive,
ISO 9002 Certified Broughton Astley, Leicestershire, Irlam, Manchester,
LE9 6TU, England M44 5EX, England
Tel: 44 (1455) 285520 Tel: 44 (161) 777-6611
FAX: 44 (1455) 283912 FAX: 44 (161) 777-6622

Toll Free in England: 0800-488-488

e-mail: uk@omega.com

It is the policy of OMEGA to comply with all worldwide safety and EMC/EMI regulations that apply. OMEGA is constantly pursuing certification of its products to the European New Approach Directives. OMEGA will add the CE mark to every appropriate device upon certification.

The information contained in this document is believed to be correct but OMEGA Engineering, Inc. accepts no liability for any errors it contains, and reserves the right to alter specifications without notice.

WARNING: These products are not designed for use in, and should not be used for, patient connected applications.

1... INTRODUCTION

MANUAL OVERVIEW

This User's manual provides information relative to the use of the OM-320 Portable Data Logging System. The manual is organized into sections describing the main components of a OM-320 system, from the System Base through the various features within the provided software. The last section of the manual consists of the Appendices which give detailed specifications and information for general reference and advanced applications.

After following the instructions for the installation of the HyperWare software, much can be learned by exploring this manual, the software and the hardware in any order... without concern for damaging results. However, *it is HIGHLY RECOMMENDED that this User's manual be read in its entirety before deploying the OM-320 in a real application.*

A note on the keyboard / mouse convention used within this manual... Throughout the manual, instructions on PC keyboard entry or menu selections via mouse are specified by using italic print such as *ENTER* which refers to the 'Enter' Key on the keyboard or *FILE* which refers to the menu item titled 'FILE'.

OM-320 SYSTEM: 'THE BIG PICTURE'

The OM-320 is a battery powered portable data logging and control system. It can be left at a site to collect data from various analog and digital signal or sensor inputs. This data is mathematically processed by the OM-320 and stored in its internal memory while simultaneously performing basic onsite alarm and control functions. The collected data is then transferred to a PC running the supplied HyperWare software for data display and analysis.

OM-320 SYSTEM COMPONENTS

A OM-320 portable data logging system consists of a number of components... both hardware and software.

The main components are listed below and details follow:

- ◆ OM-320 System Base
- ◆ Interface Modules
- ◆ HyperWare, Windows based software
- ◆ Options such as modems, PCMCIA, etc

OM-320 System Base

The OM-320 System Base (See Figure 1... -1) refers to the main data logger unit housed in its weatherproof enclosure. The System Base houses the battery pack, the Terminal Strip Adapter, and the main OM-320 front panel with its associated plug-in ports for User installation of Interface Modules.

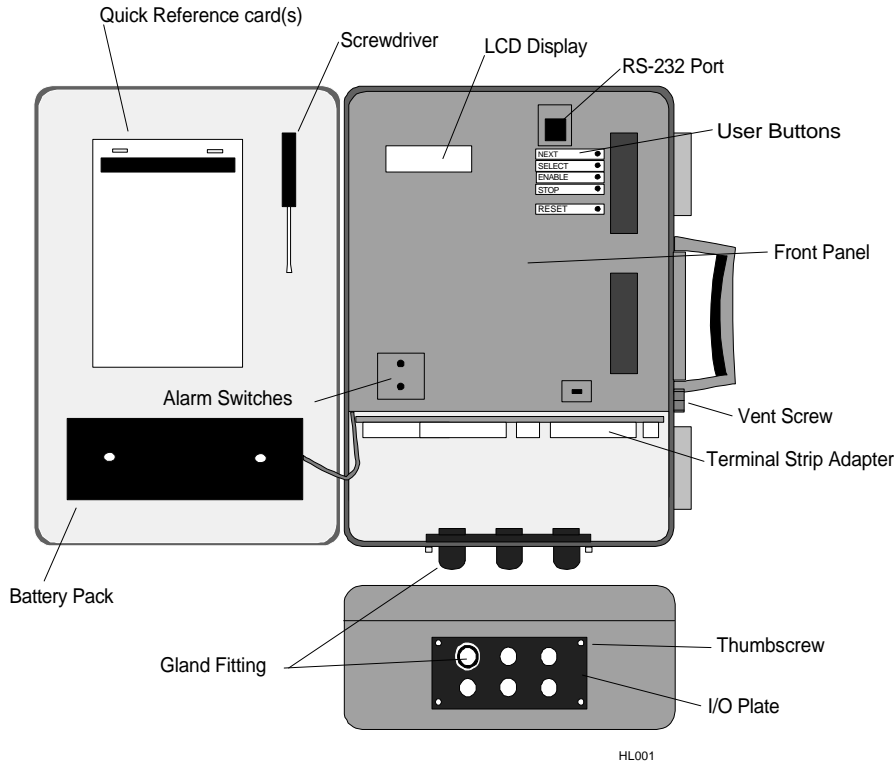

Interface Modules

Interface Modules (See Figure 1... -2) are plug-in circuit board assemblies that provide the interface to various types of inputs and output signals. The Interface Modules can be User installed into the System Base then configured for the specific type of signal or sensor to be connected to the OM-320. Interface Modules are configured via software and/or switch settings on the modules.

A family of Interface Modules is available for interface to various input signal types such as thermocouples, RTD's, voltage, current, frequency, event, etc. Additionally, Interface Modules are available with outputs for digital alarm and basic ON/OFF control functions.

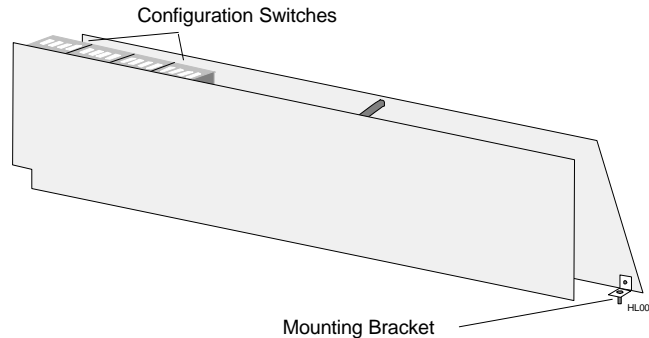

Figure 1... -2; Interface Module

HyperWare™ Software

Supplied with the OM-320 is a powerful Windows based software package called HyperWare. HyperWare, running on an IBM compatible PC under the Microsoft Windows environment provides a multitude of functions for setup of the OM-320 as well as analysis of collected data including:

- ◆ Serial Communications support between the PC and the OM-320 for RS-232 and telephone modem links
- ◆ Programming of the OM-320 using the powerful HyperNet™ visual icon based programming method
- ◆ Multi-channel, graphic data display of previously collected data using HyperPlot™
- ◆ Screen captures of HyperPlot graphs for seamless integration into other Windows based software applications such as wordprocessors, spreadsheets, or desk-top publishing packages
- ◆ Conversion of collected data files to ASCII text or Microsoft Excel file formats
- ◆ Powerful mathematical data manipulation of collected data during conversion to HyperPlot graphs, ASCII text files and Excel files
- ◆ HyperTrack™ real-time data display of OM-320 inputs and HyperNet nodes

Additional Components

Special function modules are available to provide:

Telephone Modem Interface - plug-in modules that contain integral low power 2400 Baud or 14.4 Kbaud telephone modems. These modules allow for direct connection to standard telephone lines for data transfer, reprogramming, and control...all from a remote PC running HyperWare.

PCMCIA Memory Card Interface - plug-in module provides a socket and interface circuitry for removable PCMCIA memory card support. When utilized, the OM-320 stores data to the credit card sized PCMCIA card. At any time, the card can be unplugged from its socket and carried or shipped to a another site where the data can be downloaded to a PC. Advantages of the PCMCIA card include massive data storage capability, easily transportable data, and field data collection by non-technical staff.

Special Serial Communications Interface - a variety of special serial communication types and protocols are available for serial signal interface. Contact Omega Engineering about your specific application requirement.

Included with each OM-320 portable data logging system are a number of other items including this manual, DB-9 and DB-25 to RJ-12 adapters, RS-232 cable, a plug-in power supply, and liquid-tight fittings.

FEATURES

Designed with the User in mind, the OM-320 portable data logging system has a multitude of integral features ranging from special hardware considerations to unlimited software programmability and data review. Key features include:

- ◆ Up to 24 channels of analog input or 48+ digital input/outputs
- ◆ Configurable Interface Modules accept a multitude of signal types and ranges *all on a single module*.
- ◆ Low power design allows for field logging up to 3 weeks from a set of commonly available D-Cells.
- ◆ Terminal Strip Adapter wiring system allows for quick connect and disconnect of the sensor and signal wiring harness. Using this feature, the OM-320 can readily be moved and connected up at different sites, with a minimum of setup time.
- ◆ Five integral alarm outputs including two relays
- ◆ True Microsoft Windows based HyperWare software... included with the OM-320.
- ◆ Powerful HyperPlot graphic data display software with seamless integration of plotted data into other Windows applications.
- ◆ HyperNet visual icon based programming provides unlimited flexibility in programming, *yet maintains simplicity with drag and drop icon configuration*. Set the OM-320 up without writing cryptic lines of code nor experiencing the rigors of excruciating two button menu tree nightmares.
- ◆ Intelligent logging methodologies include logging only upon change of an input (Delta-Logging), Conditional logging based on input levels, Conditional logging based on time of day or elapsed time, dual speed logging initiated by User programmed conditions, and more.
- ◆ Real-Time display (on integral liquid crystal display) of User defined node points... ranging from raw input signals to intermediate processed data to data logged to memory.
- ◆ User defined alarm messages
- ◆ Pager call-out upon User defined alarm conditions

SUMMARY OF STEPS IN UTILIZING THE OM-320

In a typical application of the OM-320 portable data logging system, the following sequence of steps would be involved. Details of each step are presented in later sections of this manual.

1. Install the required Interface Modules into the OM-320 System Base. Configure Interface Module hardware switches if applicable (eg enabling a front end divider for the +/-30VDC range on the HLIM-1)
2. Connect up to the OM-320 via a serial link from your PC. Start HyperWare and change to the HyperNet Development Screen.
3. Query the OM-320 for its current hardware configuration by clicking the NEW button.
4. Construct a Program Net for this logging session by dragging and dropping icons onto the HyperNet screen, then connecting signals between the icons. Save the Program Net to disk and print out a Terminal Strip Adapter wiring diagram for field reference.
5. Transfer the Program Net to OM-320 memory via the serial link and disconnect the serial link.
6. Install the OM-320 at the site and make the appropriate wiring connections to the Terminal Strip Adapter and modem (if used).
7. Enable the OM-320, then as a quick pre-departure check, check readings at various pre-programmed HyperProgram net nodes using the Next and Select buttons while viewing the OM-320 display.
8. Close the door on the OM-320 and collect data.
9. Later, connect up to the OM-320 via a serial link (RS-232 or modem) or retrieve the PCMCIA memory card and from within HyperWare, download the OM-320 memory to a file on the PC.
10. For a fast and immediate review of the collected data, double-click on the data icon and HyperPlot will automatically load and graphically display the collected data.
11. Save the desired HyperPlot graphic view as a Windows Bitmap file, then switch to your Windows based wordprocessor and seamlessly insert the saved graphic into your test report.
12. Optionally, use the HyperWare Post-Processing capability to configure a special data reduction/ conversion icon network. Then run the collected data file through the post processor and generate a text file, Excel Spreadsheet file or another HyperPlot file.

APPLICATIONS

Portable, self-contained, and of low-power design, the OM-320 can be deployed for data collection in multitudes of applications. Data collection, data reduction, intelligent logging, and alarming are all readily implemented with the flexibility of HyperNet programming. The rugged hardware coupled with powerful, yet simple to use, software allows for unlimited applications. Applications include:

- ◆ Vehicle testing
- ◆ Power monitoring and Energy audits
- ◆ Well pump down and slug testing
- ◆ Waste Water pump station performance and loading analysis
- ◆ Process monitoring with alarming upon 'out of condition' performance
- ◆ HVAC performance monitoring
- ◆ Laboratory experiment data collection
- ◆ Variable speed drive performance monitoring
- ◆ Oven profiling

2...OM-320 SYSTEM BASE

SYSTEM BASE OVERVIEW

The OM-320 main enclosure with its associated battery pack, front panel, wiring terminals, etc is called the System Base. The System Base contains the main microprocessor, memory, power supplies, analog to digital converter, and supporting circuitry. Additionally, the System Base contains connectors for plug-in of Interface Modules. The following major components of the System Base are detailed within this section.

- ◆ Enclosure
- ◆ System Power and Batteries
- ◆ Terminal Strip Adapter; I/O Wiring
- ◆ Interface Module Backplane
- ◆ Front Panel

ENCLOSURE

The OM-320 (Figure 2..-1) is housed in a durable plastic weatherproof enclosure that doubles as a carrying case. The enclosure has a gasketed door seal and with proper installation, the OM-320 can withstand most process and field conditons *with the exception of direct immersion*.

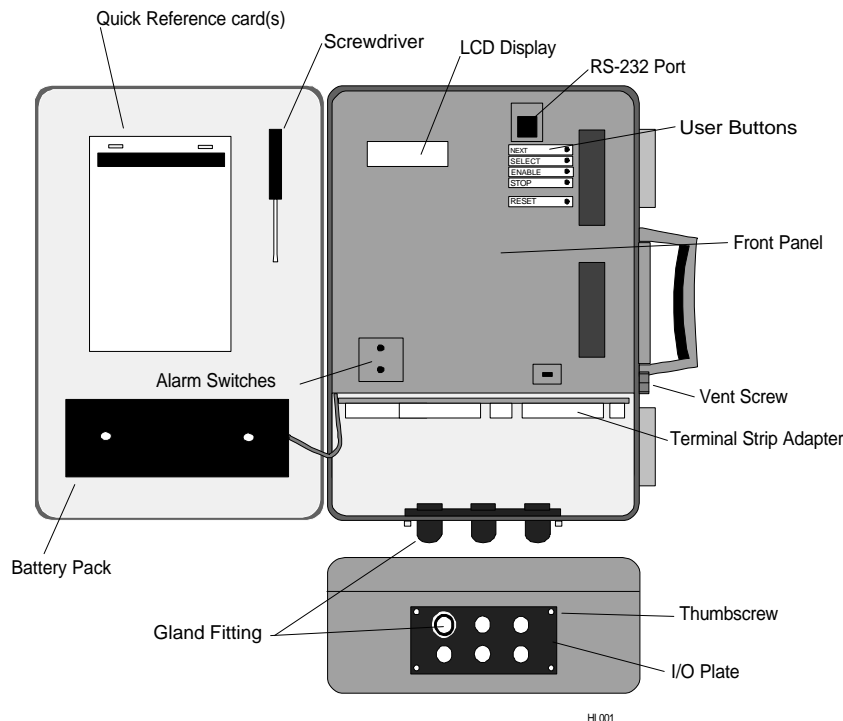

Figure 2..-1: OM-320 System Base Components

The hinged front door features two latches that are released by pulling outward on the molded tabs. For security, the top latch can be equipped with a padlock.

2... OM-320 SYSTEM BASE

VENT SCREW

A vent screw is provided (black knob by the carrying handle) for equalization of internal and external pressure during exposure to radically varying barometric conditions such as during transport via airplane or over extreme elevation changes. Loosening this knob a few turns will allow pressures to equalize and re-tightening the knob will seal the vent. In most applications, pressures will be equalized through minor leaks around the wiring egress fittings and use of the vent is not necessary.

INPUT / OUTPUT WIRING PLATE

At the bottom of the enclosure, four thumb-screws hold the I/O Wiring Plate in place. This plate has six holes sized for the supplied gland type sealing fittings. An integral gasket seals the plate to the enclosure. Use of jacketed wire for sensor wiring will result in an excellent seal to the fittings and maintain the integrity of the System Base.

TIP: For special customer applications, an I/O plate without fitting holes is available from Omega Engineering. This plate can be machined by the User for their particular I/O needs.

MOUNTING

The OM-320 can be wall mounted by attaching the supplied hanger to the back face of the OM-320 enclosure with the supplied machine screws. To attach the hanger refer to Figure 2..-2 and perform the following steps:

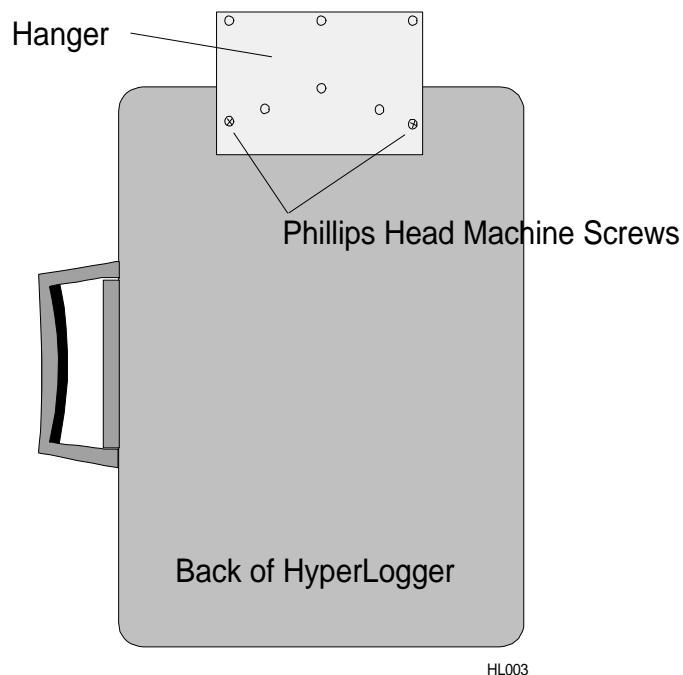

Figure 2..-2: System Base Hanger (back view)

1. Locate and remove the two phillips style flathead screws on the back (near the top) of the OM-320.

2. Align the supplied hanger with the mounting holes and reinstall the two flathead machine screws, tightening them securely.
3. In the event that the hanger is removed, the two flathead machine screws should be reinstalled into the back of the enclosure and tightened securely to reseal the mounting holes.

SYSTEM POWER

Main Batteries

The OM-320 is powered from six D-cells mounted in a battery pack on the lid (See Figure 2..-3). To access the batteries, remove the two thumbscrews and the black cover. The batteries can then be replaced by popping them out of the holders and reinstalling new batteries while observing polarity. Align the batteries with the positive terminal toward the holder end marked

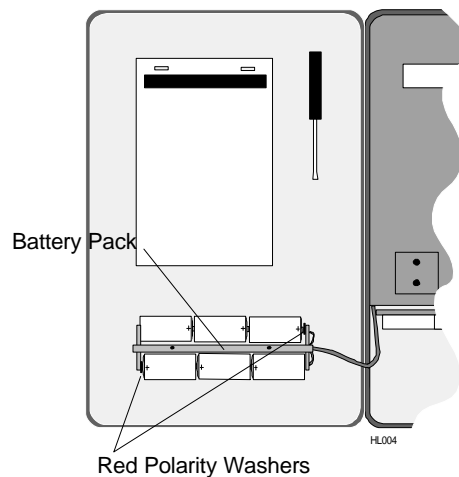

Figure 2..-3: OM-320 Battery Pack

with a red washer. The battery pack cover fits correctly only one way... if it doesn't fit, flip it over.

Alkaline D-cells are recommended as they contain significantly more energy than standard or 'heavy-duty' cells and will provide substantially longer recording capability. Depending on the Program Net within the OM-320, a fresh set of alkaline D-cells can power the OM-320 for up to 2 months of logging.

External Power

For long term and/or semi-permanent applications of the OM-320, an external power source may be used. If an external power supply is connected to the OM-320 via the Terminal Strip Adapter (page 2-4) and its supply voltage is greater than approximately 12 VDC, the OM-320 will operate from the external supply and the batteries will not be used. In the

2... OM-320 SYSTEM BASE

event that the external power fails, the OM-320 will automatically transfer to battery power and continue operation.

Memory and RTC Power

The OM-320 utilizes static ram for internal data storage which requires a constant power supply to maintain its memory. Similarly, the Real Time Clock (RTC) that keeps track of the date and time within the OM-320 runs continually whether the main power switch is ON or OFF.

When the main power is ON, the memory and RTC draw their power from the D-Cell batteries (or a connected external power supply). When the main power is switched OFF, power for memory and the RTC automatically switches to a small coin type lithium cell that is mounted on the main OM-320 circuit board.

This cell will provide power for the RTC and memory for approximately one year. Any time that the OM-320 main power is ON extends this lifetime. At any time, the approximate state of charge of the lithium cell can be displayed on the LCD under the SYSTEM STATUS / SUPPLY VOLTAGES menu or from a serially connected PC running HyperWare with the Status Query command. For lithium cell replacement procedure, refer to Appendix D.

TERMINAL STRIP ADAPTER; I/O WIRING

The Terminal Strip Adapter (TSA) is a removable assembly that provides a convenient method of connecting input and output (I/O) wiring to the OM-320 (see Figure 2..-4). By using the TSA, a large quantity of wires can be connected and disconnected with a minimum of effort. Wiring connections for power, sensor/signal inputs, CJC sensing, and alarm outputs are all handled through the Terminal Strip Adapter.

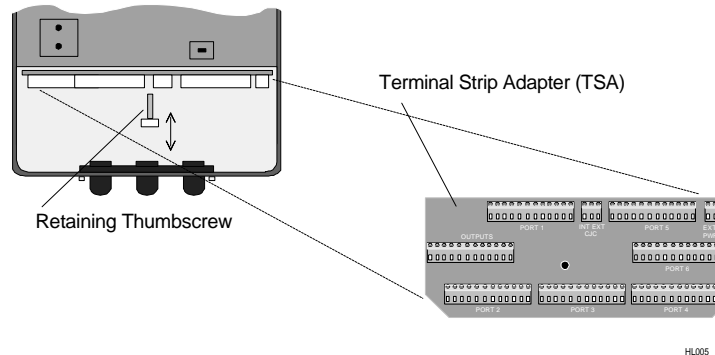

Figure 2..-4: Terminal Strip Adapter (TSA)

Making I/O Wiring Connections

The TSA is held in place with a thumbscrew located in the center of the board. To make wiring connections to the TSA, remove this thumbscrew and unplug the TSA. Wiring can then be routed through the fittings and I/O plate at the bottom of the OM-320 and secured into the various terminal locations on the TSA.

TIP: When constructing a Program Net from within HyperNet, one of the menu options will print out a TSA wiring connection list for use during field wiring of the OM-320. Details on generating this printout are covered in the HyperNet Chapter.

After making the desired connections, plug the TSA back into the OM-320 and organize the wiring within the compartment, sliding extra wire out through the the fittings. Reinstall the TSA retaining thumbscrew and tighten the fittings.

Terminal Strip Connections

The TSA has silkscreen markings indicating specific I/O wiring connections for the various terminal strips. Additional details for these connections follow:

Port 1 to 6

The terminal strips labeled with a port number refer to one of the Interface Module ports. When the Interface Module is installed, all interface wiring (signal input, control output, etc) required by the Interface Module is routed through the System Base and out to the TSA. Each Interface Module has unique input and output wiring requirements and is available on the Interface Module instruction sheet or can be reviewed onscreen or printed out from within HyperNet (Chapter 7).

CJC

Integral to the TSA is a cold junction compensation (CJC) sensor. This sensor is a 10 Kohm @25C (Fenwall curve 16) thermistor which is located by the long white DIN connector on the side opposite the terminal strips. The CJC sensor senses the temperature of the terminal strips (Internal Mode) which in turn, is used in thermocouple measurements. Additionally, the CJC sensor can be used within a Program Net to monitor the temperature inside the OM-320 enclosure.

INTERNAL CJC SENSING APPLICATIONS:

For OM-320 applications with thermocouple inputs to the TSA, a wire jumper must be installed across terminals 1 and 2 (marked INT for internal). The OM-320 is shipped from the factory with this jumper installed.

NOTE: If thermocouples are directly connected to the TSA, a wire jumper must be installed across the CJC terminal strip terminals marked INT or erroneous readings will occur..

EXTERNAL CJC SENSING APPLICATIONS:

If thermocouples are not being directly connected to the TSA, this CJC sensor can be used to measure temperatures (or limited range resistance) outside of the enclosure. A 10 Kohm thermistor (with the specified resistance curve) or a resistance type sensor can be connected across the terminals marked EXT

2... OM-320 SYSTEM BASE

on the CJC terminal strip. Refer to the CJC Icon in Appendix A for additional details.

For external sensing applications, copper lug potted thermistors with 10' leads are available from Omega Engineering.

EXT PWR

A two position terminal strip is provided for connection of an external low-voltage power source. A power source supplying 9-16 VDC or 10-20 VAC at 250mA can be connected to the terminals. Polarity is not critical. In normal operation, the OM-320 will only draw 3 to 30mA of current from this supply, however with relays, LEDs, modems, etc the current level can be higher.

If an external power supply is connected to the OM-320 via the Terminal Strip Adapter and its supply voltage is greater than the internal battery voltage by approximately 1.2 VDC, the OM-320 will operate from the external supply and the batteries will not be used. In the event that the external power drops, the OM-320 will automatically transfer to battery power and continue operation.

OUTPUTS

One 12 position TSA terminal strip is marked with OUTPUTS for the first 10 terminal positions and GPDI INPUT for positions 11 and 12. The Outputs follow:

R1

Wiring connections for Relay 1. The relay is a normally open device with contacts rated for 500 ma MAX at 32VDC MAX.

R2

Wiring connections for Relay 2. The relay is a normally open device with contacts rated for 500 ma MAX at 32VDC MAX.

DO1, DO2, AND DO3

Wiring connections for Digital Output 1, 2, and 3. A low current 5VDC rated digital output is available from each of these single terminals. These terminals are the outputs under control from the Digital Output icons within HyperNet. The output swings from 0 to 5VDC relative to the GND terminals (below) and is intended

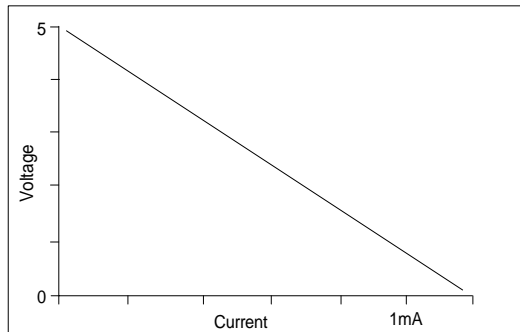

HL029

Figure 2..-5: System Base Digital Output Current Sourcing Characteristics

for sourcing and sinking *signal level loads only*. The output is current limited with an internal 4.3Kohm series resistor which results in varying output voltage levels as a function of load or sourced current as shown in Figure 2..-5. These Digital Outputs provide sufficient current for control of the Omega Engineering RPS-1, Rechargeable Power Supply which can be used for powering/ exciting higher current sensors such as 4-20mA transmitters (see Accessories in Appendix H).

GND

This pair of terminals serves as a common or ground connection for the Digital Outputs and for the +5V supply. It is connected directly to the OM-320 circuit ground.

+5V

This terminal provides a current limited +5 VDC supply for low level current applications.

Note: Heavy loading of the +5 output will significantly reduce battery life.

GPDI INPUT (+/-)

Two terminals are provided for signal input to the General Purpose Digital Input (GPDI). Integral to the System Base is this single digital input channel that can be configured under HyperNet as an Event or Counter type input. The GPDI input signal (either a contact closure or 0 to 15VDC max driven signal) is applied across these two terminals observing polarity.

The operation of the GPDI is configured during construction of the Program Net within HyperNet and programming and applications are described in the Master Icon Reference in Appendix A.

Field Disconnect Feature

Through the use of the TSA and the I/O Wiring Plate, a OM-320 can readily be disconnected from its I/O wiring and temporarily moved to a new location for another test or application. With the following method, it is not necessary to disconnect, then reconnect all of the discrete wiring each time the OM-320 is shared with another site or application.

To disconnect I/O wiring from the OM-320, refer to Figure 2..-6 and perform the following steps:

1. Switch OM-320 power OFF
2. Remove the TSA retaining thumbscrew
3. Loosen the liquid-tight fittings so the wiring is free to slide
4. Unplug the TSA and pull some additional wiring in through the fittings
5. Remove the four I/O plate retaining thumbscrews
6. Tilt the I/O Wiring Plate and the TSA and feed them out of the rectangular opening in the bottom of the OM-320 enclosure.

2... OM-320 SYSTEM BASE

1. The TSA and I/O Wiring Plate can then be left on site and the OM-320 moved to a new location. Additional I/O Wiring Plates and TSA's can be obtained from Omega Engineering.

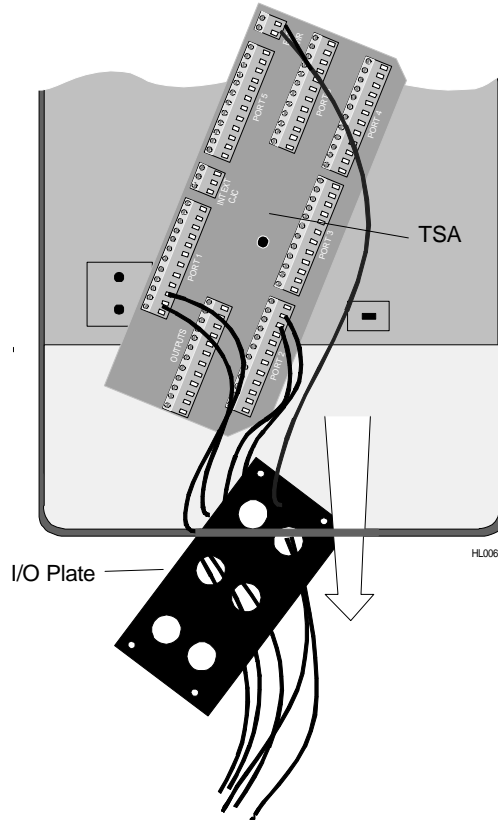

Figure 2..-6: Removal of TSA through I/O Wiring Opening

INTERFACE MODULE BACKPLANE

OM-320 Interface Modules plug into the System Base and provide various functions such as signal / sensor interface, modem and PCMCIA memory card support. The Interface Modules plug into a backplane that is located behind the front panel of the OM-320. Access is gained to this backplane as follows Refer to Figure 2..-7 and perform the following steps:

1. Remove the TSA retaining thumbscrew and unplug the TSA.
2. Remove the two thumbscrews at the top of the OM-320 enclosure.

1. Slowly, tug on the front panel handle (located near the top of the front panel) and the front panel will swing open on its hinge.

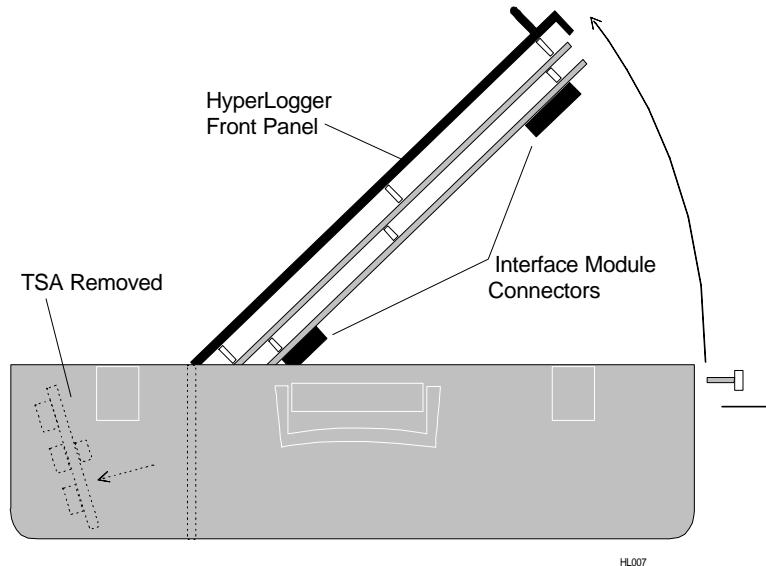

Figure 2..-7: Accessing the Backplane for Interface Module installation

When the front panel is open, black connectors on the backplane for the six numbered ports are available. Details on installation and configuration of the Interface Modules are contained in Chapter 3.

FRONT PANEL DETAILS

The OM-320 front panel (see Figure 2..-8) contains numerous User buttons, switches and the liquid crystal display. Details on these components follow:

System Power Switch

Power for the OM-320 is controlled with the System Power switch. When the power is off, the batteries and any connected external power source are disconnected.

The System Power does not affect data in memory or the Real Time Clock date and time as both have a separate lithium battery backup power source. This separate memory back-up battery will protect stored data for approximately one year at normal room temperatures. Cell replacement details are covered in Appendix D.

Power must be turned off to the System Base when installing Interface Modules, replacing the lithium cell, EPROM, and any time the front panel is opened. Additionally, to preserve battery life, turn the main power off whenever the OM-320 is not being used.

RS-232 Serial Communications Port

A female 6/6 RJ-12 modular phone type jack is provided on the front panel for RS-232 communications. A mating 6 conductor cable is supplied with the OM-320 for communication between the PC and the OM-320 via this port. *This port is not for direct connection of a telephone line.*

2... OM-320 SYSTEM BASE

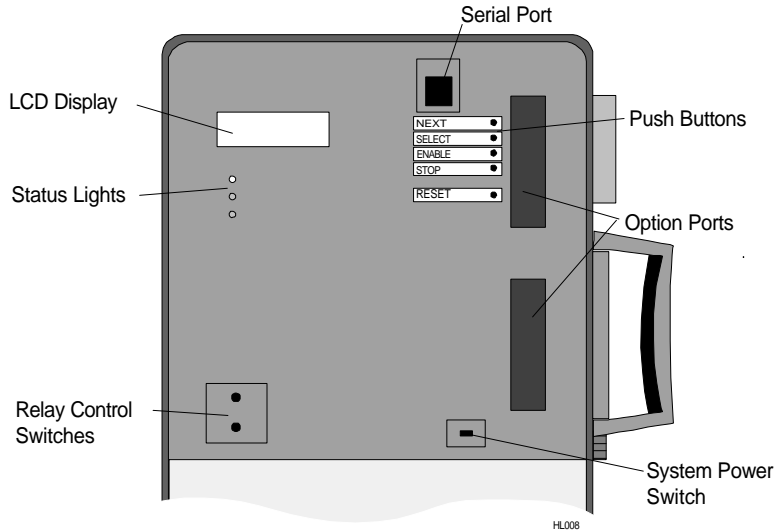

Figure 2..-8: OM-320 Front Panel

CAUTION

The RS-232 jack is only for connection of RS-232 type signals (via the supplied cable and adapters) and is not for direct connection of a telephone line.

For telephone modem communication with the OM-320, utilize the OM-320 Modem Interface Module.

Direct connection of a telephone line to this jack will result in permanent damage to the OM-320.

For longer communication distances, a longer cable can be used. Longer cables can be purchased from Omega Engineering or from stores handling standard phone supplies. If a cable is procured from a source other than Omega Engineering, insure that the cable is 6 conductor and has the plugs installed correctly. Refer to Appendix I for wiring details.

Although the RS-232 specification is only for communication distances up to 50', communication with the OM-320 via RS-232 at Baud rates up to 19.2 Kbaud has been successfully achieved with 100' of cable.

The OM-320 RS-232 communication circuitry powers up when a cable is plugged into the port and a connection is established from within the HyperWare Software. When the communication circuitry is powered up, an additional load of approximately 30 mA is put on the power supply resulting in shortened battery life.

For this reason, when not communicating with the OM-320, disconnect the RS-232 cable. For extended communication sessions battery life can be preserved by powering the OM-320 from an external power supply.

TIP: For relative reference, with the communication circuitry powered up, a new set of batteries will discharge in approximately 3 days.

Option Ports

Two Option Ports are provided on the OM-320 front panel. The port openings are available for installation of special Interface Modules such as a modem or PCMCIA socket. These ports are normally covered by rectangular covers unless one or more of the optional Interface Modules are installed (special bezels are provided with any of the Interface Modules using these ports).

Push Buttons

Located at the top right corner of the front panel are five momentary push buttons providing basic OM-320 operational control. Details on the button functions follow:

NEXT and SELECT

The NEXT and SELECT buttons are used for User control of the liquid crystal display (LCD) information displays. Pressing NEXT will advance the LCD display to the next menu item at the current menu level. Pressing the SELECT button selects that menu item and a new level of menus or results are displayed.

A detailed explanation of the operation of the NEXT and SELECT buttons is covered in a later section on the Display.

ENABLE

The ENABLE button initiates the execution of the current Program Net residing in OM-320 memory. Upon press of the ENABLE button, the LCD will change to display ENABLED on the second line. Note that operation of the ENABLE button may be inhibited if Rotary Memory Logging mode is set within the Global icon while building a Program Net. Refer to the Master Icon Reference in Appendix for details on the Global icon. Settings under the Global icon include:

LOG TO FULL MEMORY...

If the OM-320 is running in one of the *Log to Full Memory* modes, multiple logging sessions can be retained in memory before a download of data to a PC is required.

ROTARY MEMORY

If the OM-320 is programmed for the *Rotary Memory* mode, only one logging session can be retained in memory before a download is required. When the OM-320 has logged one session and stopped, the LCD will display *Memory Full*. Pressing ENABLE in this mode with a session already in memory will NOT ENABLE execution of the Program Net, memory must be downloaded or cleared before the OM-320 can be enabled.

2... OM-320 SYSTEM BASE

FYI: The label *ENABLE* was chosen rather than *START* for a subtle but important reason. When the *ENABLE* button is pressed, execution of the Program Net commences... but that does not necessarily mean that data logging to memory has started.

For example, a Program Net is developed and uploaded to the OM-320 that includes a setpoint function that controls logging to memory. For example log only when the kiln temperature exceeds 150F. Pressing the *ENABLE* button merely causes the OM-320 to take readings of the kiln temperature... but logging to memory **STARTS** when the temperature rises above the 150F threshold.

STOP

Pressing STOP at any time causes the OM-320 to finish sequencing through the currently executing Program Net, then stop executing. The LCD then updates to show *STOPPED*.

RESET

A hardware reset of the OM-320 microprocessor can be performed by depressing and releasing both the STOP and RESET buttons at the same time. This normally should not be required but in the event that a noise glitch or some other malfunction occurs, this manual Reset capability is provided for a User to force a reset of the microprocessor from the front panel.

WATCH-DOG TIMER RESET

A special automatic reset circuit is incorporated into the System Base to add additional reliability to the OM-320 system. This circuitry, called a Watch-Dog Timer will force the OM-320 microprocessor to reset and continue operation where it left off (within 2 seconds) in the event that an unforeseen hiccup or noise glitch (for example, from a nearby lightning strike) causes the microprocessor to lose its place or lock-up.

Although this circuit normally should not operate, it adds one more level of robustness to the OM-320 for handling unforeseen events.

Display

An extended temperature range 2-line by 16 character liquid crystal display (LCD) is provided. Information ranging from Operational Mode to System Status to Alarm Messages to signal readings can all be displayed on the LCD. The LCD is continually ON. Information to be displayed is controlled by a User via the SELECT and NEXT front panel buttons.

Additionally, alarm messages will be automatically displayed on the LCD when User pre-programmed conditions are met. These messages and conditions are defined by the User in the Program Net developed within HyperNet (Chapter 7) and loaded into OM-320 memory.

Display Operation

Information that can be displayed on the LCD is arranged in a hierarchical format and is accessed by a User via the NEXT and the SELECT buttons on the front panel of the OM-320. The menu structure is diagrammed in Figure 2..-9.

Pressing the NEXT button advances the display to the next available item in that menu level. Repetitive presses of the NEXT button will result in a circular sequencing through all of the available menu items on the current level and eventual repeat of the sequence.

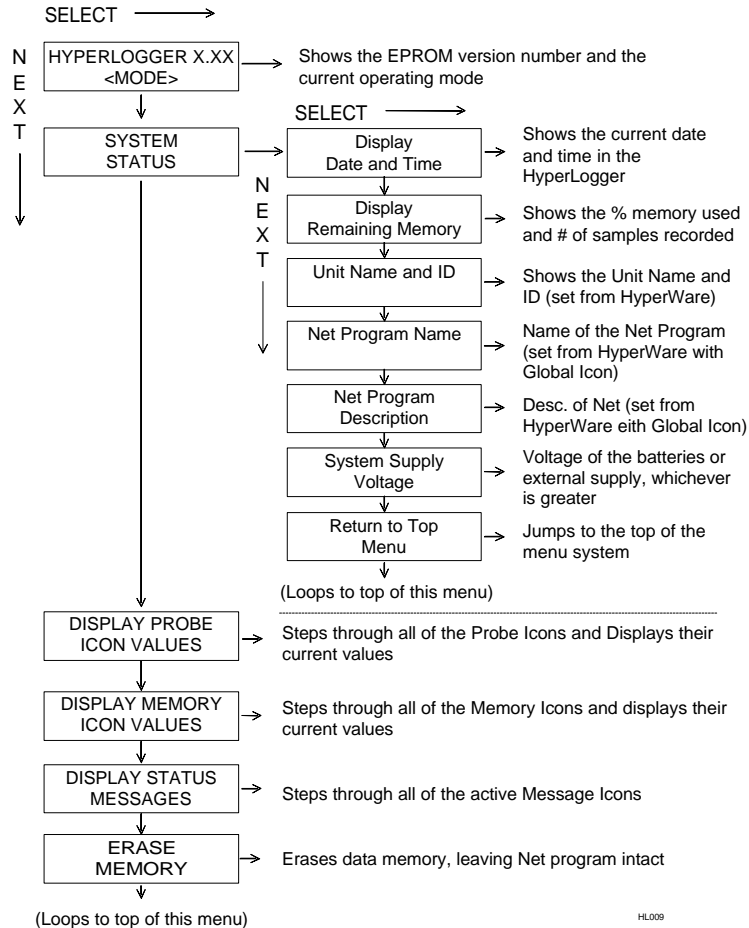

Figure 2..-9: LCD (display) Menu Structure

Pressing the SELECT button selects that menu item and a new level of menus or results are displayed. A detailed description of the various menu items and levels follow.

***TIP** - a good comprehension of this LCD menu structure can be achieved by close reading of this section... but better results may be achieved by just `diving in' and poking around with the NEXT and SELECT buttons to develop a feel for the structure. Then read through this section for the details.*

Display Menu Items

Following are descriptions of each of the display menu items identified in Figure 2..-9. Further details may be found in later sections detailing the functions described.

TOP MENU:

When the OM-320 is powered ON, the Top Menu is displayed in the LCD. The Top Menu indicates the OM-320 EPROM version on the top line of the LCD (software version residing in an EPROM memory chip within the OM-320) and on the bottom line, the current operational mode of the OM-320. Displayed Modes include:

ENABLED

Indicates the OM-320 is currently executing a Program Net that has been developed with HyperNet and transferred to the OM-320 memory.

STOPPED

The OM-320 is not executing a Program Net. Since the Net is not executing and updating the net, stepping through various Probe Points will result in values and states that will not be current.

MEMFULL STOPPED

Data memory within the OM-320 has filled and the execution of the Program Net has stopped. This message will also display if the Rotary Memory mode is utilized (See Global icon in Appendix A) and a logging session has been performed. In Rotary Memory mode, only one logging session can be maintained in the OM-320 memory.

MEMFULL ENABLED

Memory within the OM-320 has filled, however execution of the Program Net is continuing. This mode of operation may be User selected when alarming/control functions are to be monitored.... even after the OM-320 memory has filled. This display will only occur if the User has selected the memory utilization option *Log to Full Memory and Continue Processing* during setup of the Program Net within HyperNet (Global Icon option).

MEMFULL WRAPPING

Displays when the OM-320 Program Net is configured in the Rotary Memory mode. When memory fills, the OM-320 starts writing over the first collected data. Since the Program Net is still executing, alarms and control functions continue to be monitored. Rotary Memory mode is enabled during setup of the Program Net under the Global Icon.

RCV'ING NET

Displays momentarily during the actual serial upload of a Program Net to the OM-320.

NO PROGRAM NET

Displays upon first power up of the OM-320 after the Program Net has been lost. This should only occur after replacement (or initial installation) of the lithium cell used for Data Memory backup. The display indicates that a search for a valid Program Net stored within the OM-320 memory has failed.

In the event that this message displays, check (and replace if low) the Lithium Cell via the STATUS menu described below. Then reprogram the OM-320 with a new Program Net.

BAD PROGRAM NET

Displays if an illegal or corrupted Program Net is in memory. This message should only occur if memory containing the Program Net has been corrupted. In the event that this message displays, check (and replace if low) the Lithium Cell via the STATUS menu described below.

CARD ERROR: MISSING FILE

Displays upon power-up of the OM-320 with an improperly prepared PCMCIA card inserted. The card should be formatted and prepared for use within the OM-320 as described in Chapter 6.

BAD CONFIG

Displays if User selectable switch settings on the OM-320 Interface Module do not match the currently loaded Program Net. The message also identifies which Interface Module and channel or incompatible. If this message displays, modify the Program Net to match the hardware or open the OM-320 and examine the switch settings on the installed Interface Modules and correct the invalid setting(s).

SYSTEM STATUS

From the Top Menu, pressing the Next button once will advance the display to System Status. Pressing SELECT while System Status is displayed results in a new level of display. Menu selections available on this level include:

DATE AND TIME

Press SELECT to display the current Date and Time in the OM-320 Real Time Clock. This is the date and time to which collected data is referenced. The OM-320 date and time are set from within HyperComm (Chapter 5).

REMAINING MEMORY

Press SELECT to display the number of samples recorded and the percentage of memory used.

TIP: Depending on the User defined format for data storage and the actual time and values being stored, samples will require varying amounts of memory for storage. For this reason, use caution when extrapolating the remaining logging time.

2... OM-320 SYSTEM BASE

UNIT NAME & ID

Press SELECT to display the programmed OM-320 Name and ID. The OM-320 Unit name and ID can be User assigned through HyperWare (Chapter 5). This ID can be used for corporate tracking of multiple units, calibration schedules, etc.

PROGRAM NET NAME

Press SELECT to display the currently loaded Program Net name. This name is assigned during the development of a Program Net (Chapter 7).

PROGRAM NET DESCRIPTION

Press SELECT to display a previously programmed description of the Program Net (above).

SYSTEM SUPPLY VOLTAGE

Press SELECT to display the OM-320 supply voltage and the approximate state of charge of the memory / clock backup lithium cell. If internal batteries are installed in the OM-320 and an external power supply is also connected, the displayed *Supply Voltage* indicated refers to the greater of the two.

***FYI:** The displayed Supply Voltage is measured at an internal node on the power supply circuitry. Displayed battery voltage is the voltage of the internal batteries . External supply voltage will be approximately 1.2 volts higher than indicated.*

The state of charge display for the lithium cell (used for memory and clock backup) will display *GOOD* or *LOW*. If *LOW* is displayed, download any desired data memory, then replace the lithium cell per the instructions in Appendix D.

RETURN TO TOP MENU

Press SELECT to return to the Top Menu display. Press NEXT to cycle through this level's menu selections again.

DISPLAY PROBE ICON VALUES

During the construction of a Program Net within HyperNet, the User can opt to connect Probe Point icons to various nodes throughout the net. These Probe Point icons allow the User to view the current values on the nodes to which they are connected. (Program Net development is described in Chapter 7 and details on the Probe Point icon are included in Appendix A.) One of the ways that the Probe Point values can be viewed is via the OM-320 front panel LCD, as follows:

***FYI:** Probe Point is used for the icon name as connecting these icons to a node on a Net is somewhat analogous to putting a test meter probe on the Net nodes and reading a value.*

From the Top Menu, pressing the NEXT button twice will advance the LCD to *Display Probe Icon Values*. Pressing SELECT while *Display Probe icon Values* is on the LCD will shift the display to a level containing the actual Probe Point values. The top line of this display is the Probe icon Name assigned to the icon during construction of the net and the second line is the value and units.

Repetitively pressing NEXT will step the display through all of the Probe icons previously programmed into the Program Net. To return to the Top Menu, press SELECT when *Return to Top Menu* is displayed.

Displayed Probe icon values will be updated whenever the net node is updated. If the OM-320 is Stopped (ie not executing the net), the last calculated node value will be displayed.

TIP: *Displaying Probe icon Values while the OM-320 is enabled will slow down the execution of the net. For higher speed data logging applications (eg sub-second sampling rates), faster performance can be achieved by leaving the LCD in a mode where it is not displaying the time/date, battery state of charge, remaining memory, Probe icons, Memory Icons, or Net Values,*

DISPLAY MEMORY ICON VALUES

In addition to display of Probe icon values (previously described), the last value stored to any Memory icon within the executing Program Net can also be displayed on the LCD.

From the Top Menu, pressing the NEXT button three times will advance the LCD to *Display Memory Icon Values*. Pressing SELECT while *Display Memory Icon Values* is on the LCD will shift the display to a level containing the actual last logged values. The top line of this display is the Memory Icon Name assigned to the icon during construction of the net and the second line is the last logged value and units.

To return to the Top Menu, press SELECT when the *Return to Top Menu* message is displayed.

DISPLAY STATUS MESSAGES

Messages can be sent to the LCD due to OM-320 operational conditions or User programmed Program Net conditions. To view the active messages; from the Top Menu, press NEXT five times and then SELECT while the *Display Status Messages* menu is displayed. Step through the messages with the NEXT button and return to the Top Menu by pressing SELECT when *Return to Top Menu* is displayed.

Depending on the inputs and programmed conditions within the currently executing Program Net, User programmed messages may come and go as the conditions for display are met then not met over time.

During execution of a Program Net, if the conditions (either OM-320 operational or User defined Program Net) are met for a message display (eg an alarm condition occurs), the message will display on the LCD immediately... overwriting any current displays. Messages displayed on the LCD will not be cleared

2... OM-320 SYSTEM BASE

from the LCD when they become False, however they will be cleared from the internal display queue. Messages will only be cleared from the LCD if another message is displayed or if the User changes the LCD (via the Select/Next buttons) in any way. For additional information on message display capability from within a Program Net,, refer to the Message icon in Appendix A.

ERASE MEMORY

Data memory within the OM-320 and within an inserted PCMCIA card can be cleared via the SELECT and NEXT buttons. To clear memory, from the Top Menu, press NEXT six times until the message *Erase Memory* appears on the LCD. Then press SELECT a total of five times to clear the memory. Successful erasure of the memory is confirmed with a *Memory has been Erased* message.

Note that at any time during this sequence of SELECT button presses, pressing the NEXT button will abort the Memory Clear sequence and stored data will be preserved.

CAUTION!

All the King's horses and all the King's men can't reassemble erased OM-320 data again. Please be careful.

Internal OM-320 memory and PCMCIA card memory can also be cleared via a serial communication link. Refer to the Chapter 5 on HyperComm for details.

Relay Control Switches

The System Base contains two relays for use as low-voltage alarm or control outputs. Wiring connections to these two normally open contact relays is via the TSA.

CAUTION!

The two System Base relays are meant for low-voltage low-current control and alarm applications. Do not connect over 32 VDC potential or in excess of 250 mA of current through the relays.

In the lower left of the OM-320 front panel are two toggle switches labeled Relay 1 and Relay 2. The switches are three position and are provided for manual override of the relays. Description of operation in the three positions follows:

OFF: In the center position, the relays are disabled and can not be turned ON by the OM-320 Program Net.

TEST: When the switch is toggled to the right, the relay is forced into an ON state and the relay contacts are closed. This is a 'momentary' position and when the switch is released, it returns to the OFF position.

RUN: In the left position, the relay is under control of the OM-320 microprocessor. The relays will be switched ON and OFF per the logic contained within the Program Net.

NOTE: *If the relay alarm function is used within a Program Net, insure that the switches are set to RUN before leaving the site.*

Status Lights

Three light emitting diode (LED) lights are provided on the front panel, labeled STATUS, ALARM 1 and ALARM 2. The STATUS LED is merely a visual indicator provided for User specified application from within a Program Net. The ALARM LED's provide visual indication of the state of the two output relays (described above). When the ALARM LED is ON, the relay contacts are closed.

2... OM-320 SYSTEM BASE

NOTES:

3... INTERFACE MODULES

The OM-320 System Base includes six ports for plug-in installation of any of the family of OM-320 Interface Modules (see Figure 3... -1) . Interface Modules provide the interface between real world signals such as thermocouples, voltage, current, telephone lines, etc and the OM-320 System Base.

This section covers the installation, wiring, hardware configuration, and application considerations of the basic OM-320 family of Interface Modules. As additional modules are added, the instruction sheets should be added to this section for reference.

Utilization of the Interface Module channels within a HyperNet Program Net is covered within Chapter 7 and the reference Master Icon Listing contained in Appendix A.

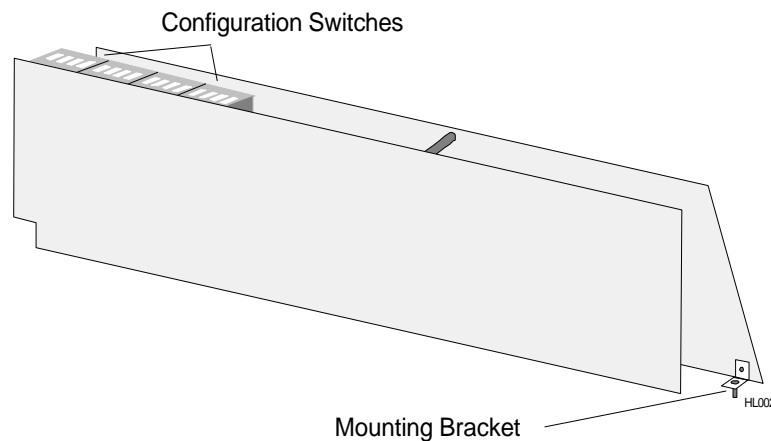

Figure 3... -1: Interface Module

-

HANDLING

As with all electronic systems, static electricity discharge can weaken or cause permanent damage to circuitry. Protective circuitry is integral to the OM-320 system including the Interface Modules, however when the Interface Modules are not installed in the System Base, the protective circuitry is not effective. Therefore, when handling Interface Modules, it is recommended that reasonable static control procedures be followed.

- ◆ Before touching the Interface Module, discharge static electricity built up in your body by touching a grounded point such as a water faucet, cover plate screw on a receptacle, metal surface of a grounded appliance or other earth ground.
- ◆ Do not wrap or store the Interface Module in static generating materials such as untreated styrofoam packing 'peanuts' or plastic bags. Anti-Static bags are available for storage of static sensitive components.

3... INTERFACE MODULES

INSTALLATION

When shipped, Interface Modules are provided with a Quick Reference Card, Instruction sheet, and any necessary accessories. Optionally, if ordered with a System Base, the Interface Modules are typically factory installed in the System Base before shipment.

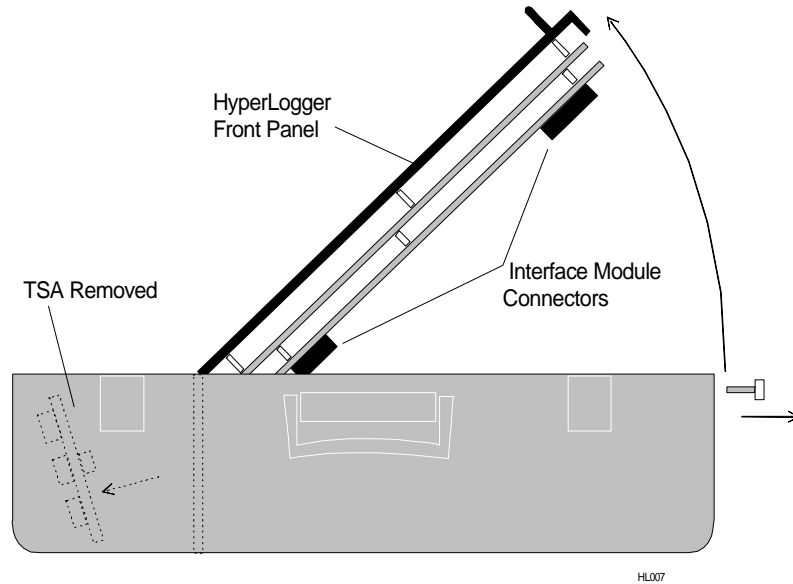
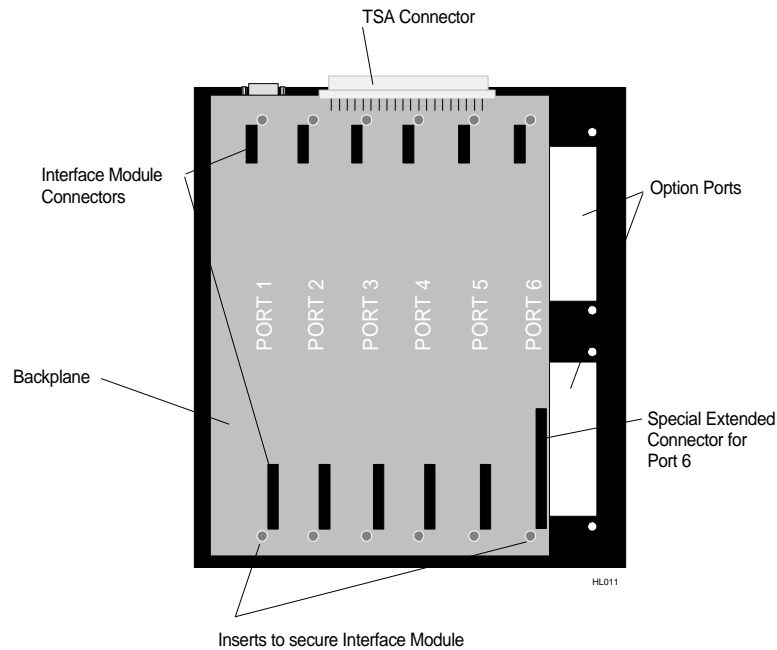

Figure 3... -2: Accessing the OM-320 System Base backplane

The Interface Modules plug into a backplane that is located behind the front panel of the OM-320. Access is gained to this backplane as follows (Figure 3... -2):

1. Remove the TSA retaining thumbscrew and unplug the TSA.
2. Remove the two thumbscrews at the top of the OM-320 enclosure.
3. Slowly, tug on the front panel handle (located near the top of the front panel) and the front panel will swing open on its hinge.

When the OM-320 is open, inspection of the exposed circuit board backplane (Figure 3... -3) will reveal the connectors and threaded inserts used in installation of



**Figure 3... -3: Backplane and Interface Module connectors
(view shown with OM-320 front panel open)**

a Interface Module. Note that Interface Module ports 1 through 5 are all identical, however Port 6 includes some additional connections (one of the Backplane socket connectors is longer) and also aligns with the Front Panel cutouts (labeled Option Port 1 and 2 on the Front Panel). Some Interface Modules such as the HLIM-5 must be installed in Port 6.

To install an Interface Module into the System Base Backplane Ports 1 to 5:

1. Review the Interface Module instructions and observe any special installation instructions.
2. Turn the OM-320 System Power switch OFF.
3. Remove the TSA retaining thumbscrew and unplug the TSA.
4. Remove the two thumbscrews at the top of the OM-320 enclosure.
5. Slowly, tug on the front panel handle (located near the top of the front panel) and the front panel will swing open on its hinge (Figure 3... -2).
6. Observe the gold connector pins on the long edge of the Interface Module. These pins will plug into a mating black socket mounted on the OM-320 System Base Backplane. Also, two phillips head screws in angle brackets are at each end of the Interface Module. These screws will mate with threaded inserts in the Backplane (Figure 3... -3).
7. Orient the Interface Module with the diagonally cut end toward the top of the Backplane.

3... INTERFACE MODULES

8. Tighten the retaining screws into their mating inserts while carefully observing the alignment of the mating connectors.

TIP: Start one screw into its mating insert, then align and start the other screw. Check that the connectors are aligned and then tighten both of the screws securing the Interface Module to the Backplane..

To install an Interface Module into System Base Backplane Port 6:

1. Review the Interface Module instructions. If the Interface Module uses either Front Panel Option Port 1 or 2, remove the two phillips head screws holding the Option Port cover(s) in place.
2. Follow the steps specified for installation of an Interface Module into Ports 1 to 5 above.
3. Install any special bezels (provided with the Interface Module) using the two phillips head screws removed in step 1.

INTERFACE MODULE OPERATIONAL INSTRUCTIONS:

Each Interface Module has specific characteristics and instructions for set-up and use that are unique to that particular module. These instructions are provided with the Interface Module at the time of purchase. As Interface Modules are added to a User's OM-320, the instruction sheets provided should be added to this section of the manual.

The instructions for most Interface Modules include both hardware and software details. Software instructions will commonly be referenced from other sections of this manual such as in the chapter on HyperComm for the modem modules and the chapter on HyperNet programming for analog and digital Interface Modules.

Instruction sheets for the following Interface Modules are currently included in this section:

- ◆ HLIM-1; Analog Interface Module
- ◆ HLIM-2; Event, Frequency, Count Interface Module
- ◆ HLIM-4; RTD, Thermistor, and Resistance Module
- ◆ HLIM-8; Digital Interface Module (8 channel digital I/O)
- ◆ HLIM-5 PCMCIA Memory Card Interface Module
- ◆ MM-2400 2400 Baud Modem option (for HLIM-5)
- ◆ MM-14.4 14.4kbaud Modem option (for HLIM-5)

3... INTERFACE MODULES

NOTES:

HLIM-1; FOUR CHANNEL ANALOG INTERFACE MODULE

OVERVIEW

Overview:

The HLIM-1 is a four channel Interface Module for use in conjunction with the OM-320 System Base. Each of the four channels can be individually programmed for any combination of the following signal types and input ranges with HyperWare software (via HyperNet) and hardware Configuration Switches (located on the Interface Module).

Thermocouple:

Type	Color (USA)	Range (F)	Range (C)
J	white/red	-60 to 1400F	-50 to 760C
K	yellow/red	32 to 2500F	0 to 1370C
E	purple/red	-150 to 1830F	-100 to 1000C
T	blue/red	-250 to 750F	-160 to 400C
R	black/red	32 to 1830F	0 to 1000C
S	black/red	32 to 3182F	0 to 1750C

Table 3... -1: Thermocouple input types and ranges

DC Voltage:

Full Scale (FS) ranges:

Icon	Full Scale Input Ranges				
VDC-LO	+/- 20mV	+/-40mV	+/-50mV	+/-60mV	+/-100mV
	+/-200mV	+/-1V	+/-2V		
VDC-MED	+/-5 V	+/- 10V			
VDC-HI	+/- 3V	+/-15V	+/-30V		

Table 3... -2: DC Voltage input ranges

Input Impedance for the 5V, 10V, and 30V ranges is >2.5Megohm. All other range's input impedance is > 10 Megohm.

DC Current:

Full Scale (FS) ranges:

Icon	Full Scale Input Ranges			
mA-LO	+/-200uA	+/-400uA	+/-500uA	+/-1.0mA
	+/-2.0mA	+/-11 mA	+/-22mA	

Table 3... -3: DC Current input ranges

Input resistance for all current ranges is a 100 ohm precision shunt.

3... INTERFACE MODULES

Module Installation:

Refer to page 3-2 for instruction on installation of the Interface Module into the OM-320 Backplane. No special considerations are required for installation of this module into the System Base.

Upon completion of installation, visually insure that all of the connector pins are mated in their respective sockets.

Port Requirements / Limitations:

This module can be installed in any of the six Backplane ports.

Hardware Configuration Switches:

Four sets of Configuration Switches are provided for each of the four channels (Figure 3... -4). Through the use of these switches, various types of signals can be directly fed into the OM-320 eliminating the need for User supplied external precision dividers, shunts and other circuitry.

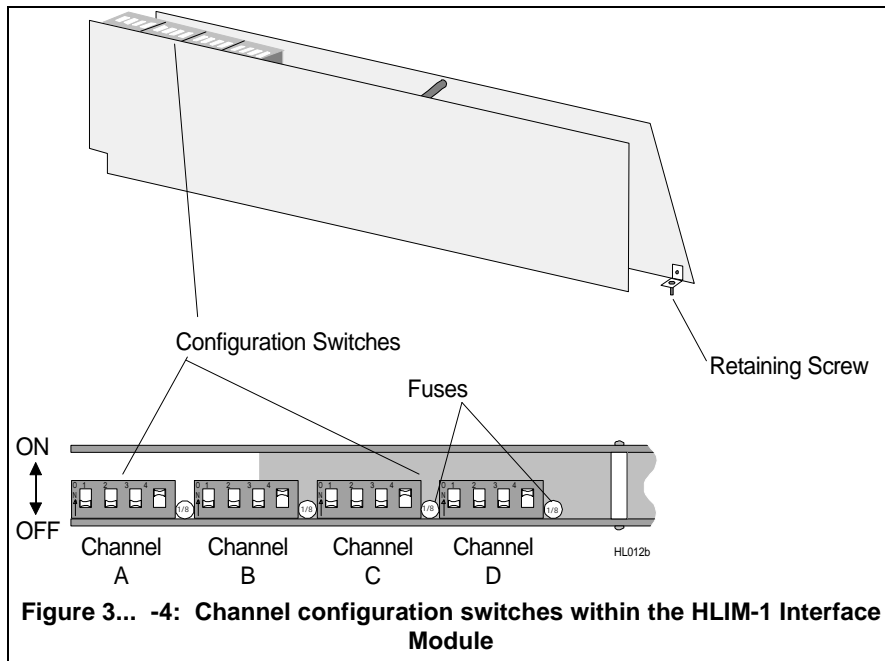

Although for most applications, an in-depth understanding of the function of these switches is not required, a simplified schematic of the input section of the HLIM-1 is provided in Figure 3... -5. As can be seen in this schematic, different combinations of the switches interject voltage dividers and shunts into the input stage of the

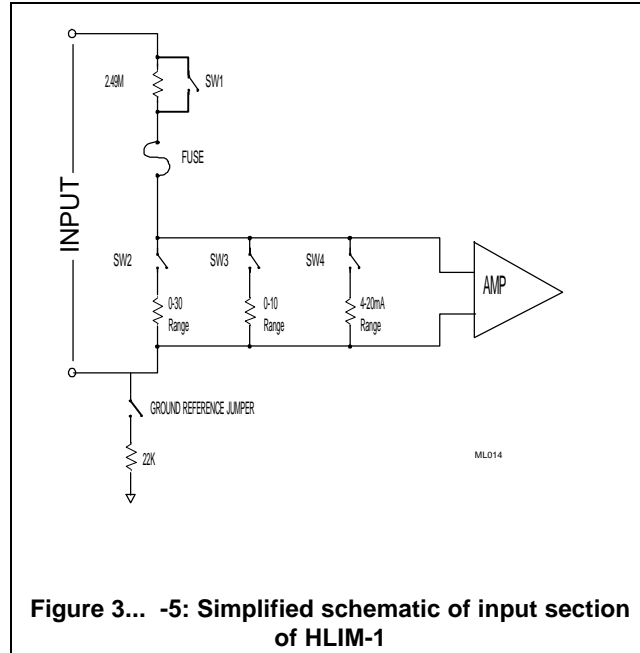

Figure 3... -5: Simplified schematic of input section of HLIM-1

Input Overcurrent Fuses:

Each channel is protected by a 125mA fuse as shown in Figure 3... -5 (circuit) and Figure 3-4 (physical location on module). This fuse will protect the module from overcurrent surges received from malfunctioning or improperly connected sensors and transmitters.

In the event that a channel on a module quits responding with proper values, it may be an indication that this protective fuse has blown. The fuse can be removed from the circuit and checked for continuity with an ohm-meter and/or replaced with a Littelfuse P/N: 273.125 fuse available from Omega Engineering Incorporated or many electronic distributors.

The following reference chart provides the necessary information for configuration of the switches. The switch settings are read by the OM-320 during a query of the hardware configuration (from within HyperNet) so the User is not burdened with keeping notes of the current OM-320 configuration. Improper setting of the switches will result in a 'Bad Configuration' message on the LCD upon power-up of the OM-320. In the event that this message displays, check the switch settings per Table 3... -4 and correct the conflict.

Input / Range	SW 1	SW2	SW3	SW4
Thermocouples	OFF	OFF	OFF	ON

3... INTERFACE MODULES

VDC up through +/-2 VDC				
VDC up through +/-10 VDC	OFF	OFF	ON	OFF
VDC up through +/-30 VDC	OFF	ON	OFF	OFF
All Current (mADC) Ranges	ON	OFF	OFF	ON

Table 3... -4: HLIM-1 configuration switch settings

HLIM-1 Channel Configuration via Software:

When a HLIM-1 channel is configured as a particular type of input via the module configuration switches, the configuration will be automatically detected during the development of a Program Net for the OM-320. Software configuration and utilization of the HLIM-1's channels in a Program Net is covered in Chapter 7 and within the Master Icon Listing in Appendix A.

HLIM-1; THERMOCOUPLE APPLICATION

Thermocouple Connection:

To utilize an HLIM-1 channel as a thermocouple input, configure that channel's Interface Module Configuration Switch per Table 3... -4. Channels configured as thermocouple inputs utilize three terminal strip connections per input; Positive lead, Negative lead, and Shield.

Connect the thermocouple positive and negative (red in USA) leads to the correct pair of terminals on the TSA PORTx terminal strip. Refer to Chapter 7 for steps to generate a TSA Wiring printout for use in making field wiring connections.

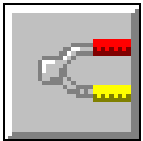

Thermocouple Icon

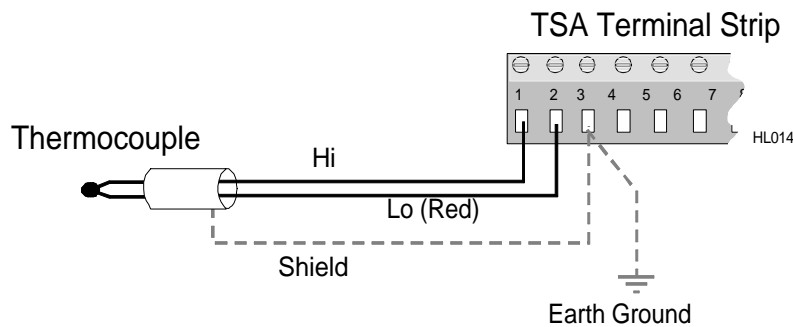

Figure 3... -6: Thermocouple (and optional Shield) terminal strip connection

Polarity is critical..

Shielded thermocouple wire is recommended in electrically noisy environments for optimum signal protection. If shielded wire is used, a ground wire should be run from one of the Shield terminals to an earth ground connection to conduct away noise picked up by the thermocouple shield (Figure 3... -6). Only one ground wire is required per 12 position terminal strip as terminals 3, 6, 9 and 12 are all interconnected within the TSA circuit board.

NOTE: Do not ground the shield wire at the sensor end away from the OM-320.

Thermocouple Application Notes:

Cold Junction Compensation (CJC): For thermocouple measurements, the temperature of the terminal strip connections is required in the voltage to temperature conversion equation used by the OM-320. This temperature is measured by the CJC sensor located on the back of the TSA. Any differential temperature from the metal terminal strip connections to the CJC sensor on the TSA circuit board will result in direct measurement errors.

The TSA is thermally designed to provide good CJC sensor vs terminal strip temperature tracking however, to minimize this potential error, avoid installations or effects that will induce extreme temperature differential. The most accurate readings will be achieved when the door to the OM-320 is closed and temperatures within the enclosure have stabilized.

DIFFERENTIAL POTENTIAL: to minimize current loop induced errors, use isolated type thermocouples or insure that all thermocouple junctions are at ground potential. Insure that input voltages do not exceed 3.0V above or below circuit ground (maximum common mode voltage).

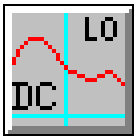
HLIM-1; DC VOLTAGE APPLICATION

**VDC- Lo
Range Icon**

The HLIM-1 can support three different major ranges (and a multitude of sub-ranges) of analog DC voltage input depending on the channel's hardware Configuration Switch setting (See Table 3... -4). To utilize an HLIM-1 channel as a DC Voltage input, set that channel's Configuration Switch per the Table for the desired input signal range.

As shown in Figure 3... -5, when DC-MED or DC-HI are selected with the hardware Configuration Switches, front-end divider circuitry is enabled. This circuitry attenuates the input signal to a range that can be handled by the HLIM-1 instrumentation amplifier section.

TIP: For best accuracy and absolute resolution, utilize the lowest range possible that will cover the input signal's dynamic range without over-ranging.

Signal Connection (all Ranges):

Interface Module channels configured as VDC inputs provide three terminal strip connections per input; Positive lead, Negative lead, and Shield.

Connect the VDC signal positive and negative leads to the correct pair of terminals on the TSA PORTx terminal strip (Figure 3... -7). Refer to Chapter 7 for steps to generate a TSA Wiring printout for use in making field wiring connections.

Observe polarity or the output signal will be reversed.

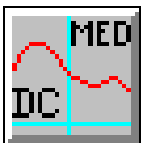

**VDC-
Medium
Range Icon**

3... INTERFACE MODULES

To minimize noise pickup on sensor wiring between the OM-320 and the end sensor or signal source, 18 to 22 AWG shielded, twisted pair wire is recommended.

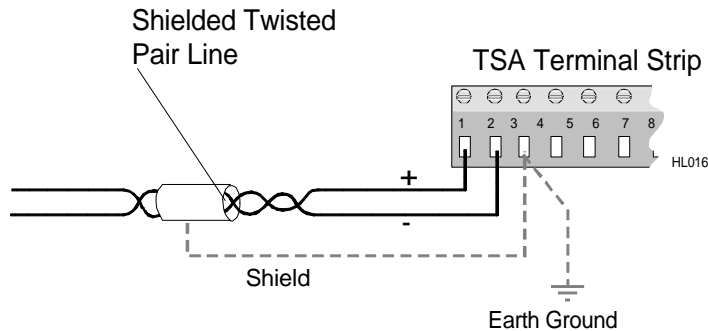
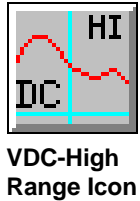

Figure 3... -7: VDC signal (and optional shield) terminal strip connection

FYI: Shielded wire minimizes the amount of noise picked up by the internal conductors carrying the signals by providing an `electrical shell' or Faraday cage around the internal conductors.

Twisted pair wiring exposes both conductors equally to the ambient electrical noise. This common-mode type noise is easier to reject by the Interface Modules input signal conditioning circuitry than un-balanced (or differential) noise.

Shielding and/or twisted pair wire is especially recommended in electrically noisy environments for optimum signal protection. If shielded wire is used, a ground wire should be run from one of the Shield terminals to an earth ground connection to conduct away noise picked up by the shield conductor. Only one ground wire is required per 12 position terminal strip as terminals 3, 6, 9 and 12 are all interconnected within the TSA circuit board. Multiple terminal strips on the TSA (multiple ports) can be daisy-chained to a common earth ground wire (Figure 3... -8).

NOTE: Do not ground the signal wiring shield conductor at the sensor end (the end away from the OM-320) as this can induce additional noise into the

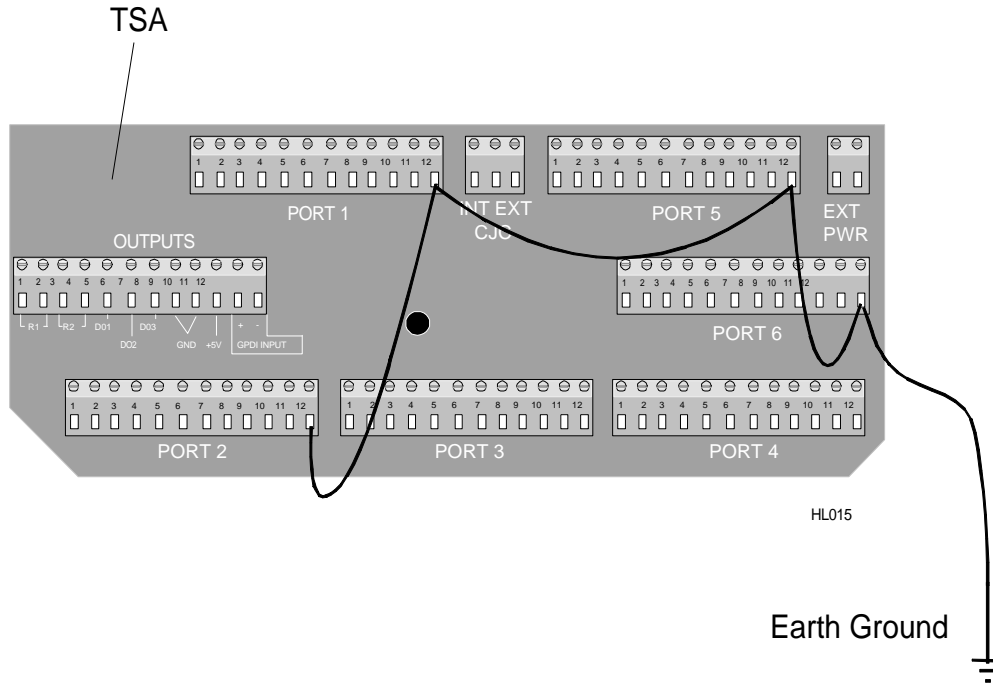

Figure 3... -8: Daisy-chained shield connections on TSA sensor wiring..

APPLICATION NOTES; DC Voltage Channels

Channel Isolation:

The negative terminal of HLIM-1 channels configured as DC Voltage inputs are isolated from the OM-320 circuit ground by a 22Kohm resistor (see Figure 3... -5).

Common Mode Input Range Considerations:

To prevent saturation of the input amplifier stages and erroneous readings, no voltages should be applied to any input terminals that are greater than 4.0V above or below circuit ground. If the signal being measured is not connected to the OM-320 circuit ground (ie `isolated' supplies are used), common mode input voltages up to 32 V can be accepted. Voltages above this level can be lethal and should not be applied to the OM-320. Supply isolation can be achieved by allowing the OM-320 to run from its internal batteries (rather than an external source).

Multiple Measurement Nodes on a Circuit:

When measuring different voltage points from a common circuit with multiple channels (of one or more Interface Modules), measurement errors from induced ground currents can exist. Single ended measurements may be required. Consult the factory for application assistance.

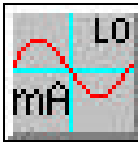

mA-Lo Icon

HLIM-1; DC CURRENT (mA-LO) APPLICATION

The HLIM-1 can accept DC Current within the ranges specified in Table 3... -3. To utilize an HLIM-1 channel as a DC Current input, set that channel's Configuration Switch per Table 3... -4 as a mA-LO Channel.

As shown in Figure 3... -5, when mA-DC is selected with the hardware Configuration Switches, a precision 100 ohm burden resistor is enabled. The input signal is measured as a voltage across the shunt resistor.

TIP: For best accuracy and absolute resolution, utilize the lowest range possible that will cover the input signal's dynamic range without over-ranging.

Signal Connection (all Current Ranges):

Interface Module channels configured as mA-LO inputs provide three terminal strip connections per input; Positive lead, Negative lead, and Shield.

Connect the mADC signal positive and negative leads to the correct pair of terminals on the TSA PORTx terminal strip (Figure 3... -8). Refer to Chapter 7; HyperNet Programming for steps to generate a TSA Wiring

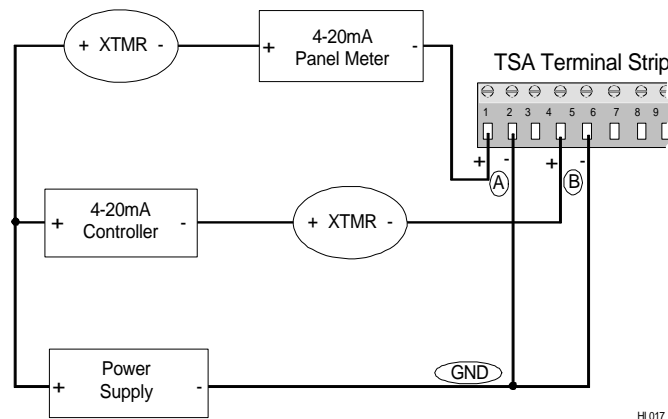

Figure 3... -8: Terminal strip connections for multiple 4-20mA inputs

printout for use in making field wiring connections.

Observe polarity or the output signal will be reversed.

To minimize noise pickup on sensor wiring between the OM-320 and the end sensor or signal source, 18 to 22 AWG shielded, twisted pair wire is recommended. At the low current levels interfacing to the HLIM-1, voltage

drop in signal wiring is not a concern, however for extremely long runs, a voltage drop analysis should be performed for the entire loop and if necessary larger gauge wire should be used.

FYI: Typically, with current signals (in contrast to low level voltage signals), noise pickup will be less due to the low impedances involved in the circuit. However, in real-world applications, one should attempt to minimize noise on signal wires whenever possible.

Shielded wire minimizes the amount of noise picked up by the internal conductors carrying the signals by providing an 'electrical shell' or Faraday cage around the internal conductors.

Twisted pair wiring exposes both conductors equally to the ambient electrical noise. This common-mode type noise is easier to reject by the Interface Modules input signal conditioning circuitry than un-balanced (or differential) noise.

Shielding and/or twisted pair wire is especially recommended in electrically noisy environments for optimum signal protection. If shielded wire is used, a ground wire should be run from one of the Shield terminals to an earth ground connection to conduct away noise picked up by the signal wire shield. Only one ground wire is required per 12 position terminal strip as terminals 3, 6, 9 and 12 are all interconnected within the TSA circuit board. Multiple terminal strips on the TSA (multiple ports) can be daisy-chained to a common earth ground wire (Figure 3... -8).

NOTE: Do not ground the signal wiring shield conductor at the sensor end (the end away from the OM-320) as this can induce additional noise into the sensor wiring..

APPLICATION NOTES; DC Current Channels

Channel Isolation:

The negative terminal of HLIM-1 channels configured as DC Current inputs are isolated from the OM-320 circuit ground by a 22Kohm resistor (see Figure 3... -5).

Common Mode Input Range Considerations:

To prevent saturation of the input amplifier stages and erroneous readings, no voltages should be applied to any input terminals that are greater than 4.0V above or below OM-320 circuit ground.

In wiring multiple 4-20mA transmitters to the OM-320 through an HLIM-1 channel, this 4.0V common mode level must not be exceeded. Figure 3... -8 shows an acceptable method to connect multiple transmitters running from a common power supply to

3... INTERFACE MODULES

several channels on an HLIM-1 Interface Module channel without exceeding this spec.

A simple method to comply with this spec is to insure that all negative inputs (-) on channels configured as mA-LO inputs are directly connected to the GROUND (-) terminal of the power supply used for excitation of the 4 to 20 mA loop (eg the Omega Engineering RPS-1, Rechargeable Power Supply). This will insure that the voltage developed across the 100 ohm resistor internal to the HLIM-1 mA-LO input channel will never exceed 2 VDC (ie $20\text{mA} \times 100\text{ ohms} = 2\text{ VDC}$) relative to any channel's (-) negative terminal. In Figure 3... -8, the voltage developed between node [A] to [GND] and node [B] to [GND] will never exceed 2VDC (in normal operation).

Multiple Measurement Nodes on a Circuit:

When measuring different voltage points from a common circuit with multiple channels (of one or more Interface Modules), measurement errors from induced ground currents can exist. Single ended measurements may be required. Consult the factory for application assistance.

NOTES:

HLIM-2; DIGITAL INTERFACE MODULE OVERVIEW

Overview:

The HLIM-2 Interface Module provides four input channels and four output channels on a single module. Each of the four input channels can be individually programmed for any combination of Event input, Count input, or Frequency input. The four output channels provide current limited nominal 5VDC output. Configuration of the module is done from within HyperNet in HyperWare.

Module Installation:

Refer to Chapter 3 for instruction on installation of the Interface Module into the OM-320 Backplane. No special considerations are required for installation of this module into the System Base. Upon completion of installation, visually insure that all of the connector pins are mated in their respective sockets.

Port Requirements / Limitations:

This module can be installed in any of the six Backplane ports.

Hardware Configuration Switches:

No hardware configuration switches are provided on the HLIM-2. All configuration is done via the HyperNet software.

Software Configuration of the HLIM-2:

The HLIM-2 module is completely configured on a channel by channel basis from within the HyperNet software. This software configuration and utilization of the various HLIM-2 channels in a Program Net is covered in Chapter 7 and within the Master Icon Listing in Appendix A.

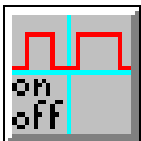

Figure 3... -9:
Event icon
(HLIM-2)

HLIM-2; EVENT INPUT APPLICATION

The Event function of the HLIM-2 allows for the recording of the state of an ON/OFF type input. Configured as an Event input, a channel will accept a powered input signal (ranging from 0 to a maximum of 15VDC) or a contact closure (dry contact) input.

- ◆ For powered input signals, the HLIM-2 Event function defines signals less than 1VDC as a Low level and greater than 4VDC (15VDC max) as a High level.
- ◆ For contact closure type inputs, power is automatically supplied from the HLIM-2 channel circuitry via a 100Kohm pull-up resistor (R1 in Figure 3... -13).

Channel input impedance is greater than 30K ohm.

A 40mS debounce circuit can be enabled via software which can be used to filter out 'contact bounce' (Refer to the Master Icon Listing in Appendix A for details).



Figure 3... -
10:
Counter
icon (HLIM-
2)

HLIM-2; COUNTER INPUT APPLICATION

The Counter function of the HLIM-2 provides an accumulating total of signal transitions received at its input.

Configured as a Counter type input, a channel will accept a powered input signal ranging from 0 to a maximum of 15VDC or a contact closure (dry contact) input.

- ◆ For powered input signals, the HLIM-2 Counter function defines signals less than 1VDC as a Low level and greater than 4VDC (15VDC max) as a High level.
- ◆ For contact closure type inputs, power is automatically supplied from the HLIM-2 channel circuitry.

In Counter mode, 16,777,216 transitions can be received before the counter will roll-over to 0 and begin counting up again. This may be a consideration during the implementation of a Counter channel within a Program Net and is covered in the Master Icon Listing, Appendix A.

Channel input impedance is greater than 30K ohm.

A 40mS debounce circuit can be enabled via software which can be used to filter out 'contact bounce' (see below).

Event / Counter Input Signal Connections:

To utilize an HLIM-2 channel as an Event or Counter input, connect the input signal positive lead to an *Input* terminal (Chan A, B, C, or D) and the negative lead to one of the four *Common* terminals on the TSA PORTx terminal strip (Figure 3... -11). Note that all of the four Common terminals are interconnected and connect directly to the OM-320 circuit ground. Refer to Chapter 7 for steps to generate a TSA Wiring printout for use in making field wiring connections.

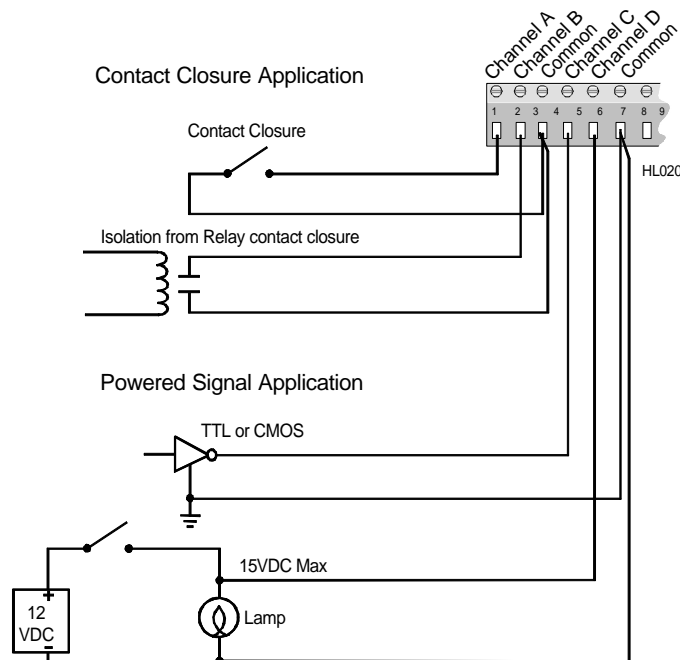

Figure 3... -11: Contact closure and Powered type Event or Counter signal input connections

CAUTION: Note that a direct connection exists between the common (-) terminal on all four channels of the HLIM-2 (Figure 3... -13). When connecting to multiple event or counter signal sources sharing a common ground or reference, insure that the source's ground or reference is connected to the terminal strip 'common' terminal to prevent shorting out of the source signal and possible damage to the HLIM-2 or TSA.

For most counter and event applications, shielding is not necessary due to the relatively low input impedance of the channel and the high noise immunity of the HLIM-2 channel input.

HLIM-2; FREQUENCY INPUT APPLICATION

An HLIM-2 channel configured as a Frequency type input can measure input frequencies ranging from approximately 5Hz to 20KHz. The channel will accurately measure frequencies of sine, square, or sine approximating input waveforms with peak to peak amplitudes of 300mVDC to 15VDC. Channel input impedance is greater than 30K ohm within the specified input range.

The HLIM-2 incorporates an AC coupled front-end amplifier for use with low amplitude signals (see AMP in Figure 3... -13).

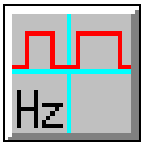

Figure 3... -12: Frequency icon (HLIM-2)

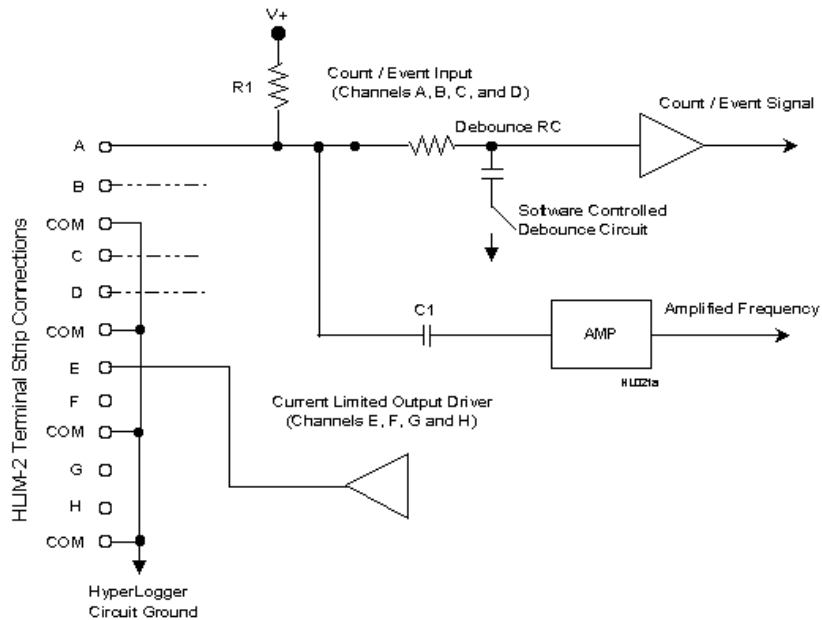

Figure 3... -13: Simplified schematic of HLIM-2 input channel (single channel shown)

Frequency Signal Connection:

To utilize an HLIM-2 channel as a Frequency input, connect the input signal positive lead to one of the four *Input* terminals (Chan A, B, C, or D) and the

negative lead to one of the four *Common* terminals on the TSA PORTx terminal strip (Figure 3... -14). Note that all of the four Common terminals are interconnected and connect directly to the OM-320 circuit ground.. Refer to Chapter 7 for steps to generate a TSA Wiring printout for use in making field wiring connections.

CAUTION: Note that a direct connection exists between the common (-) terminal on all four channels of the HLIM-2 (Figure 3... -13). When connecting to multiple frequency sources sharing a common ground or reference, insure that the source's ground or reference is connected to the terminal strip `common` terminal to prevent shorting out of the frequency signal and possible damage to the HLIM-2 or TSA.

For Frequency recording applications with small signal amplitude, high frequencies, long lead length and/or in noisy environments, twisted pair wire will provide extra noise immunity. In extremely noisy applications, shielded wire may be required. If shielded wire is used, the shield at the OM-320 end should be connected to an external earth ground (Figure 3... -14) or if available, a grounded Shield connection provided on another type installed interface module (such as the HLIM-1).

NOTE: Do not ground the shield wire at the end away from the OM-320.

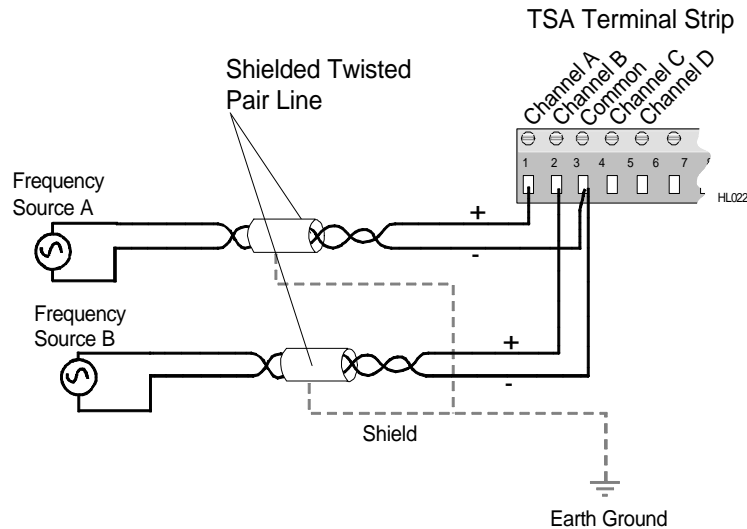

Figure 3... -14: Frequency input terminal strip connections (two inputs shown)

HLIM-2; DIGITAL OUTPUT APPLICATION



Digital Output icon (HLIM-2)

The HLIM-2 provides four channels dedicated as outputs. These channels can be configured for functions such as alarming. The output is a current limited voltage signal with the voltage/current characteristics shown in Figure 3... -15. As shown, with a light load, the output voltage maintains approximately 4+ VDC but as the

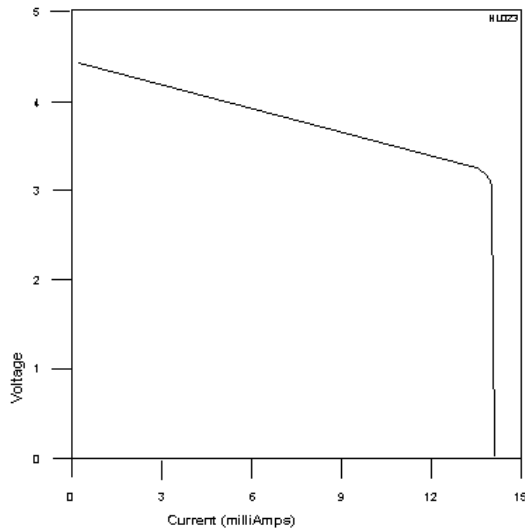

Figure 3... -15: HLIM-2 Digital output drive characteristics

current draw increases, current limiting occurs and the output voltage droops. The output can be short circuited continuously without damage to the output drive circuitry, but the OM-320 battery life will be drastically reduced.

Note that the when the Output is OFF, it is merely floating, ie it is not driven to a ground (or shorted to ground) potential. This may be a consideration when driving TTL or other type inputs. A pull-down resistor (eg 10K) can be added on the terminal strip connections from the output to the common to provide a low resistance OFF state if necessary. Keep in mind that this resistor will consume power when the Output is ON.

Digital Output Signal Connections:

To utilize an HLIM-2 Output channel, connect the load positive lead to an Output terminal (Chan E, F, G, or H) and the load negative lead to one of

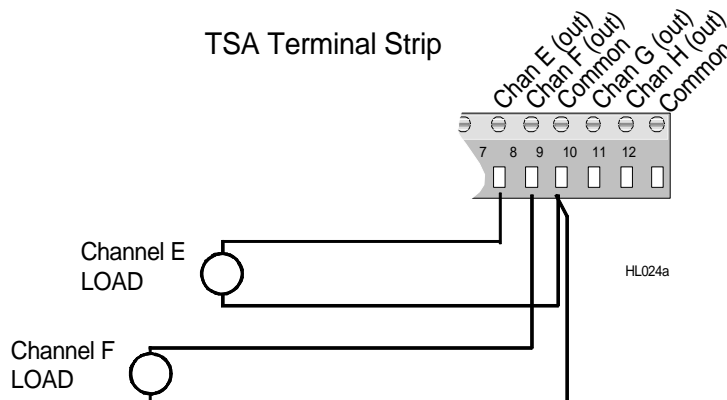

Figure 3... -16: HLIM-2 Digital output terminal strip

the four *Common* terminals on the TSA PORTx terminal strip (Figure 3... - 16). Note that all of the four Common terminals are interconnected and connect directly to the OM-320 circuit ground. Refer to Chapter 7 for steps to generate a TSA Wiring printout for use in making field wiring connections.

HLIM-4; RTD / RESISTANCE INTERFACE MODULE OVERVIEW

Overview

The HLIM-4 is a four channel Interface Module for use in the OM-320 System Base. Each of the four channels can be individually programmed for any combination of RTD (100 ohm or 1000 ohm), Resistance or Thermistor input via the HyperWare software (HyperNet).

Additionally, for RTD and resistance measurements, 2, 3, and 4-Wire configurations can be selected. With 3 and 4-wire configurations, the resistance due to the extension wires is minimized. With 3 or 4-wire configuration, two input channels are required.

Module Installation:

Refer to the OM-320 User's Manual Section 3 for instruction on installation of the Interface Module into the OM-320 Backplane. No special considerations are required for installation of this module into the System Base. Upon completion of installation, visually insure that all of the connector pins are mated in their respective sockets.

Port Requirements / Limitations:

This module can be installed in any of the six Backplane ports.

Hardware Configuration Switches:

No hardware configuration switches are provided on the HLIM-4. All configuration is done via the HyperNet software.

Software Configuration of the HLIM-4

The HLIM-4 module is completely configured on a channel by channel basis from within the HyperNet software. This software configuration and utilization of the various HLIM-4 channels in a Program Net is covered in overview in Chapter 6, within the Master Icon Listing in Appendix A, and with specific detail in this document.

When the HLIM-4 module is detected in a OM-320 after clicking on the New Program button from within HyperNet, four icons representing the HLIM-4 input channels will display on the screen. The icons will display as 2-wire RTD inputs as the default. These icons can be switched to Resistance or Thermistor inputs by double-clicking on the icon then on the Change button.

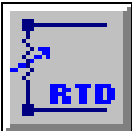

RTD Input

HLIM-4; RTD INPUT APPLICATION

The RTD function of the HLIM-4 allows for the input of Platinum RTD's with any of the following characteristics:

- ◆ 100 or 1000 ohm @ 0' C
- ◆ European (0.0385) or American (0.0392) alpha coefficient curve
- ◆ 2, 3, or 4-wire configuration

The actual temperature is calculated from the resistance and can be output in either degrees C or F. Two input temperature ranges are provided for maximizing span

and ultimate resolution of the readings. The RTD element resistance is measured using a constant current ratiometric technique which provides excellent stability over time and temperature.

Refer to the Excitation Current Table for current levels utilized in the excitation of the RTD elements.

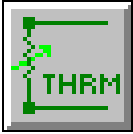

**Thermistor
Input**

HLIM-4; THERMISTOR INPUT APPLICATION

The Thermistor function of the HLIM-4 allows for the input of 10,000 ohm @ 25C NTC thermistors conforming to the Fenwall Curve 16 or equivalent RT curve.

The actual temperature is calculated from the resistance and can be output in either degrees C or F. Four input temperature ranges are provided for maximizing span and ultimate resolution of the readings. The Thermistor element resistance is measured using a constant current ratiometric technique which provides excellent stability over time and temperature. Due to the high resistance vs temperature ratio, only 2-wire configuration is provided (and required).

Refer to the Excitation Current Table for current levels utilized in the excitation of the Thermistor element under test.

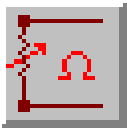

**Resistance
Input**

HLIM-4; RESISTANCE INPUT APPLICATION

The Resistance function of the HLIM-4 can measure resistances ranging from 200 ohm to 400,000 ohm full scale. 2, 3, or 4-wire configurations can be used depending on absolute accuracy requirements.

Twelve input resistance ranges are provided for maximizing span and ultimate resolution of the readings. The resistance is measured using a constant current ratiometric technique which provides excellent stability over time and temperature.

Refer to the Excitation Current Table for current levels utilized in the excitation of the resistance elements being measured.

HLIM-4; INPUT SIGNAL CONNECTION METHODS:

For all three signal types, RTD, thermistor, and resistance, a ratiometric resistance measurement technique is used. In the case of the RTD and thermistor measurements, a software conversion is then used to convert this resistance into temperature.

In measuring the resistance of a distant element with a conventional 2-wire connection configuration, the resistance of the lead wires running from the OM-320 TSA terminal to the actual sensing element itself will add resistance and corresponding error. The magnitude of these errors depends on the resistance of the lead wires which is a function of wire gauge, temperature, and any connection resistance. If the resistance is small relative to the resistance being measured, this additive lead wire resistance can be ignored (eg in thermistor or Kohm resistance measurements). However, in applications of RTDs or lower resistance ranges this lead wire resistance can add up to substantial measurement errors... especially if long runs or lighter gauge lead wire is used. For example, in a 100 ohm RTD, 0.4 ohms of lead wire resistance would translates to a reading error of 1 Deg C.

To minimize these lead wire induced errors, the HLIM-4 supports 3-wire and 4-wire connection methods. Connection diagrams and descriptions for each of the wiring methods follow.

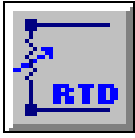

2-Wire Config

2-Wire Configuration

The 2-wire configuration is easiest to use and allows for utilization of all four input channels of the HLIM-4 as individual channels. All three input types, RTD, thermistor, and resistance can be measured with the 2-wire technique. For short runs, heavier gauge lead wires and/or higher resistance measurements, the 2-wire technique will provide excellent performance with minimal error.

Calculating Lead Wire Effects

To calculate resistance errors induced by lead wires in a 2-wire configuration:

1. Estimate the total length of the lead wire to be used.
2. Multiply this length by the resistance per foot of the wire to be used. Complete wire tables are available from wire manufacturers and in many electronic reference books. For general reference, an abbreviated table is included below.
Note that wire resistances are typically given per 1000 foot.
3. Assess the effects of this resistance on the required accuracy. For RTD applications, tables are available from the manufacturer that correlate RTD element resistance to degrees over the usable range. As a general guideline, a 100 ohm RTD will have a 1 Degree C change for every 0.36 ohms, a 1000 ohm RTD will have a 1 degree C change for every 3.6 ohms (hence the increasing popularity of the 1000 ohm RTD).

Wire Gauge	ohms per 1000 ft @ 25C (77F)	ohms per 1000 ft @ 65C (149F)
26	41.6	48
24	26.2	30.2
22	16.5	19.0
20	10.4	11.9
18	6.5	7.5
16	4.1	4.7

Table 5: Typical Copper Wire resistance

2-Wire TSA Connections:

For each Interface Module Port, a 12 position terminal strip is provided on the TSA. Each HLIM-4 input channel utilizes 3 of the 12 terminals (1-2-3, 4-5-6, 7-8-9, 10-11-12). Connect the input signal to the first two of the three input terminals (1-2, 4-5, 7-8, 10-11) on the TSA. A wire jumper must then be installed from the second to the third terminal (2-3, 5-6, 8-9, 11-12).

Refer to Chapter 6 for steps to generate a TSA Wiring printout after construction of a Program Net for use in making field wiring connections.

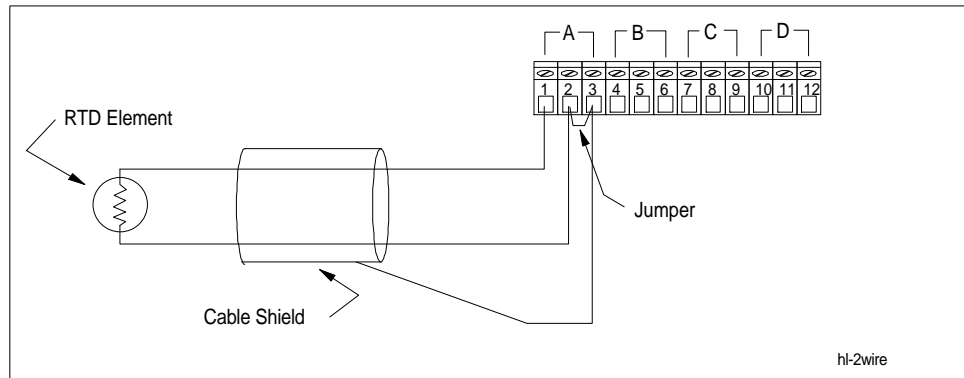

Figure 3... -17; 2-Wire Configuration

For long lead wire runs and in applications in electrically noisy environments, it is recommended that twisted pair and/or shielded wire be used. The extension wire shield can be connected to the 3rd terminal (ground) along with the jumper. If shielded wire is used, a ground wire should be run from one of the shield/ground (3rd) terminals on the TSA to an earth ground connection to conduct away noise picked up by the shield conductor. Terminals 3, 6, 9, and 12 are all internally connected so a single grounding wire will suffice. Refer to Figure 3-8 in the OM-320 Users Manual.



3-Wire
Config

3-Wire Configuration

The 3-wire configuration is used in applications where the lead wire effects calculated as above will have a significant error inducing effect on the resistance measurement. The 3-wire configuration requires two input channels (A and B or C and D) to implement. From within the HyperNet Window, double-clicking Channel A or C icons displays a dialog and allows for selection of 2, 3, or 4-wire connection. When 3-wire is selected, a second corresponding icon (Channel B or D) is removed as this second channel is required for the 3-wire measurement.

3-Wire Compensation Theory:

With a 3-wire configuration, the resistance of one of the lead wires is measured, doubled and then subtracted out of the measured total element plus lead wire circuit resistance. The 3-wire configuration, as the name implies, requires the use of three discrete wires from the TSA to the element. Two of the leads connect to one common end of the element and the other lead connects to the other end of the element. The 3-wire configuration provides nearly the same level of error compensation as the 4-wire configuration with one less wire.

3... INTERFACE MODULES

Due to the fact that only one of the lead wires resistance is actually measured and the other lead wire is assumed to match, in using the 3-wire configuration, it is important that both lead wires used for the excitation current (connected to terminals 1 & 2, or 7 & 8 and opposite ends of the element) are of the same approximate length, same gauge, and operating at the same temperature. The third lead (connected to terminal 4 or 10) can be of lighter gauge if desired as a very low current flows through it.

3-Wire TSA Connections:

As can be seen in the 3-Wire Wiring Diagram, each channel requires 6 of the 12 terminals. Channel A uses terminals 1 through 6, and Channel C uses terminals 7 through 12.

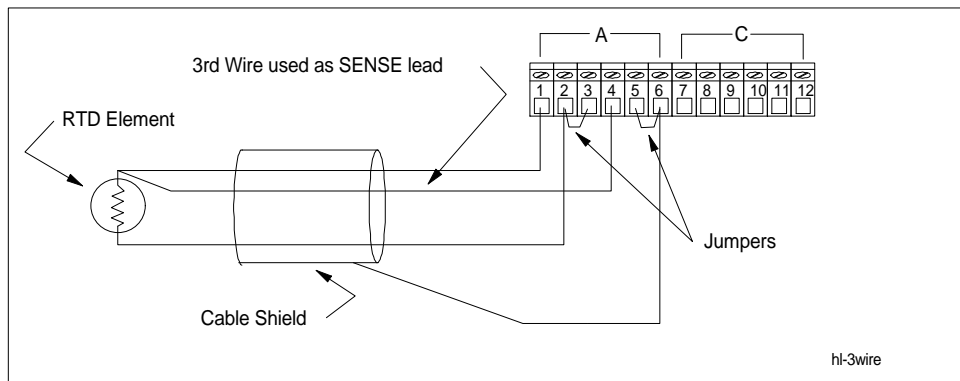

Figure 3... -18: 3-Wire Configuration

Two matching gauge Excitation wires should connect from opposite ends of the element and to terminals 1-2 or 7-8 on the TSA. A third Sense wire then connects from the element (sharing the connection with a lead from terminal 1 or 7 on the TSA) to terminal location 4 or 10. Two wire jumpers must then be installed connecting terminals 2-3 and 5-6 for Channel A and 8-9 and 11-12 for Channel C.

Refer to Chapter 6 for steps to generate a TSA Wiring printout after construction of a Program Net for use in making field wiring connections.

For long lead wire runs and in applications in electrically noisy environments, it is recommended that twisted pair and/or shielded wire be used. The extension wire shield can be connected to terminal 6 or 12 (ground). If shielded wire is used, a ground wire should be run from one of the ground terminals on the TSA to an earth ground connection to conduct away noise picked up by the shield conductor. Terminals 3, 6, 9, and 12 are all internally connected so a single grounding wire will suffice. Refer to Figure 3-8 in the OM-320 Users Manual.



4-Wire
Config

4-Wire Configuration

The 4-wire configuration is used in applications where the lead wire effects calculated as above will have a significant error inducing effect on the resistance measurement. The 4-wire configuration provides the best compensation for lead wire resistance at the expense of running a 4th lead. The 4-wire configuration requires two input channels (A and B or C and D) to implement. From within the HyperNet Window, double-clicking Channel A or C icons displays a dialog and allows for selection of 2, 3, or 4-wire connection. When 4-wire is selected, a second corresponding icon (Channel B or D) is removed as this second channel is required for the 4-wire measurement.

4-Wire Compensation Theory:

With a 4-wire configuration, the excitation current flows to and from the element through one pair of leads. The actual voltage developed across the element is then measured using a second pair of Sense leads that conduct a very small amount of current (hence adding negligible $I * R$ voltage measurement error) .

The 4-wire configuration, as the name implies, requires the use of four discrete wires from the TSA to the element. Two of the leads connect to one end of the element and the other two to the other end of the element.

Due to the fact that the excitation current flows through a separate pair of leads, wire gauge, temperature effects, and connection resistance has no effect on the accuracy of the readings. The Sense leads (connected to terminals 4-5 or 10-11) can be of lighter gauge if desired as a very low current flows through them.

4-Wire TSA Connections:

As can be seen in the 4-Wire Wiring Diagram, each channel requires 6 of the 12 terminals. Channel A uses terminals 1 through 6, and Channel C uses terminals 7 through 12.

The Excitation wires connect from opposite ends of the element and to terminals 1-2 or 7-8 on the TSA. A second pair of Sense wires then connects from opposite ends of the element to terminals 4-5 or 10-11. A wire jumper must then be installed connecting terminals 2-3 for Channel A and 8-9 for Channel C.

Refer to Chapter 6 for steps to generate a TSA Wiring printout after construction of a Program Net for use in making field wiring connections.

3... INTERFACE MODULES

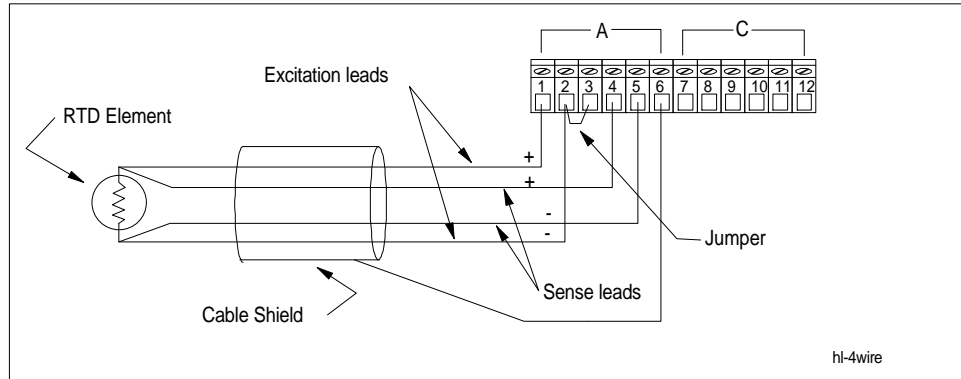

Figure 3... -19: 4-Wire Configuration

For long lead wire runs and in applications in electrically noisy environments, it is recommended that twisted pair and/or shielded wire be used. The extension wire shield can be connected to terminal 6 or 12 (ground). If shielded wire is used, a ground wire should be run from one of the ground terminals on the TSA to an earth ground connection to conduct away noise picked up by the shield conductor. Terminals 3, 6, 9, and 12 are all internally connected so a single grounding wire will suffice. Refer to Figure 3-8 in the OM-320 Users Manual.

Range	Excitation Current	Range	Excitation Current
Res 200 ohm	1 mA	Res 200,000 ohm	10 uA
Res 200 ohm	10 mA	Res 400,000 ohm	10 uA
Res 400 ohm	1 mA	RTD-100 ohm 300C	1 mA
Res 400 ohm	10 mA	RTD-100 ohm 850C	1 mA
Res 2000ohm	100 uA	RTD-1000 ohm 300C	100 uA
Res 4000 ohm	100 uA	RTD-1000 ohm 850C	100 uA
Res 10,000 ohm	100 uA	Therm -32 to 250C	10 uA
Res 20,000 ohm	100 uA	Therm -4 to 250C	10 uA
Res 40,000 ohm	10 uA	Therm +10 to 250C	10 uA
Res 100,000 ohm	10 uA	Therm +25 to 250C	100 uA

Excitation Currents used for HLIM-4 Ranges

NOTES:

HLIM-8; DIGITAL I/O INTERFACE MODULE OVERVIEW

Overview:

The HLIM-8 is an eight channel Interface Module for use in the OM-320 System Base. Each of the eight channels can be individually programmed for any combination of Event input or Digital output via the HyperWare software (HyperNet).

Module Installation:

Refer to Chapter 3 for instruction on installation of the Interface Module into the OM-320 Backplane. No special considerations are required for installation of this module into the System Base. Upon completion of installation, visually insure that all of the connector pins are mated in their respective sockets.

Port Requirements / Limitations:

This module can be installed in any of the six Backplane ports.

Hardware Configuration Switches:

No hardware configuration switches are provided on the HLIM-8. All configuration is done via the HyperNet software.

Software Configuration of the HLIM-8:

The HLIM-8 module is completely configured on a channel by channel basis from within the HyperNet software. This software configuration and utilization of the various HLIM-8 channels in a Program Net is covered in Chapter 7, within the Master Icon Listing in Appendix A, and within this document.

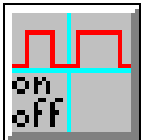

Event icon
(HLIM-8)

HLIM-8; EVENT INPUT APPLICATION

The Event function of the HLIM-8 allows for the recording of the state of an ON/OFF type input. Configured as an Event input, a channel will accept a powered input signal (ranging from 0 to a maximum of 26VDC) or a contact closure (dry contact) input.

- ◆ For powered input signals, the HLIM-8 Event function defines signals less than 1VDC as a Low level and greater than 4VDC (26VDC max) as a High level.
- ◆ For contact closure type inputs, power is automatically supplied from the HLIM-8 channel circuitry via a 100Kohm pull-up resistor (R1 in Figure 3... -20).

Channel input impedance is greater than 30K ohm.

A 40mS debounce circuit can be enabled via software which can be used to filter out 'contact bounce' (Refer to the Master Icon Listing in Appendix A for details).

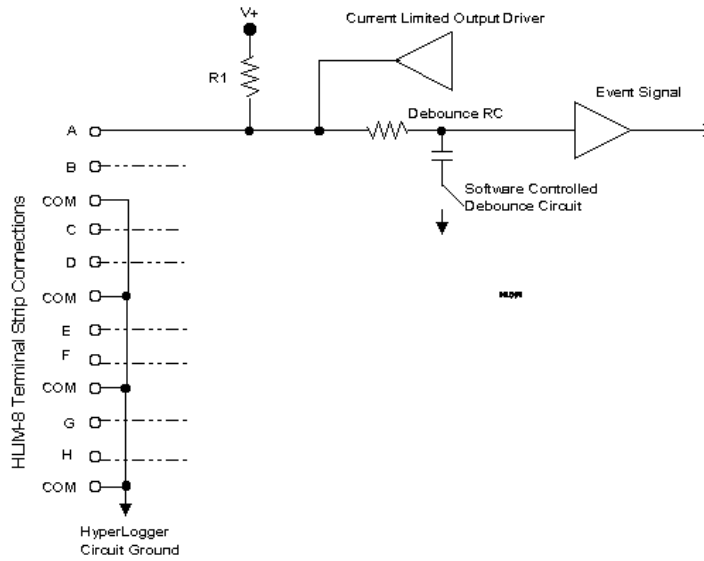

Figure 3... -20: Simplified schematic of HLIM-8 input/output channel (single channel shown)

Event Input Signal Connections:

To utilize an HLIM-8 channel as an Event input, connect the input signal positive lead to an *Input* terminal (Chan A, B, C, D, E, F, G, or H) and the negative lead to one of the four *Common* terminals on the TSA PORTx terminal strip (Figure 3... -21). Note that all of the four Common terminals on the terminal strip (3, 6, 9, 12) are interconnected and connect directly to the OM-320 circuit ground. Refer to Chapter 7 for steps to generate a TSA Wiring printout for use in making field wiring connections.

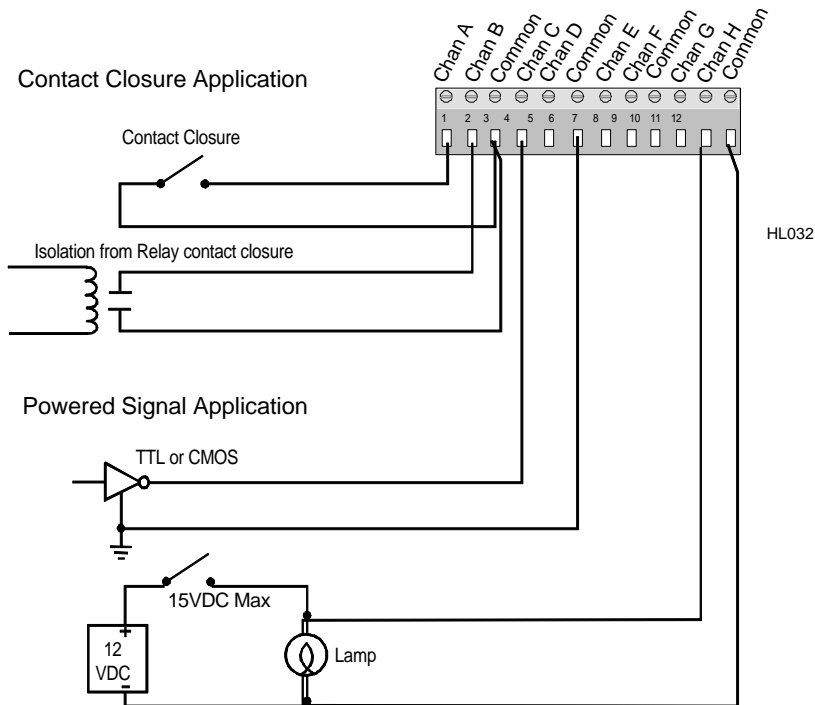

Figure 3... -21: Contact closure and Powered type Event signal input

3... INTERFACE MODULES

CAUTION: Note that a direct connection exists between the common (-) terminal on all eight channels of the HLIM-8. When connecting to multiple event signal sources sharing a common ground or reference, insure that the source's ground or reference is connected to the terminal strip 'common' terminal to prevent shorting out of the source signal and possible damage to the HLIM-8 or TSA.

For most event applications, shielding is not necessary due to the relatively low input impedance of the channel and the high noise immunity of the HLIM-8 channel input.

-

HLIM-8; DIGITAL OUTPUT APPLICATION

An HLIM-8 channel configured as a Digital Output can provide an ON/OFF voltage signal for alarming applications. The output is a current limited voltage signal with the approximate voltage/current characteristics shown in Figure 3... -22. As shown, with a light load, the output voltage maintains approximately 4+ VDC but as the



Digital Output icon (HLIM-8)

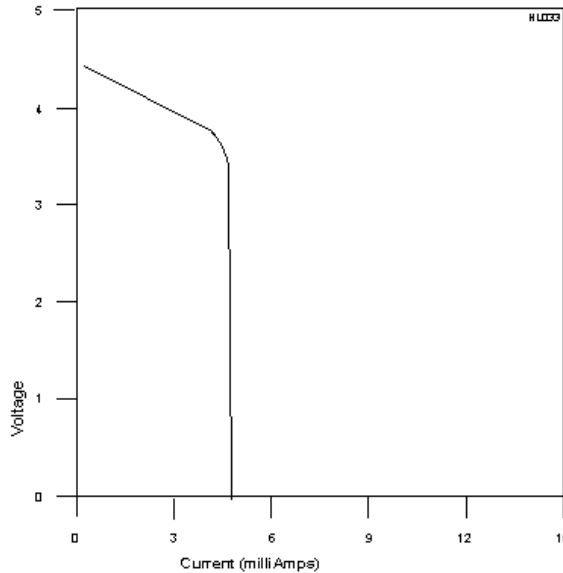

Figure 3... -22: HLIM-8 Digital output drive characteristics

current draw increases, current limiting occurs and the output voltage droops. The output can be short circuited continuously without damage to the output drive circuitry, but the OM-320 battery life will be correspondingly reduced.

Digital Output Signal Connections:

To utilize an HLIM-8 channel as a Digital Output, connect the load positive lead to an *Output* terminal (Chan A, B, C, D, E, F, G, or H) and the load negative lead to one of the four *Common* terminals on the TSA PORTx terminal strip (Figure 3... -23). Note that all of the four Common terminals are interconnected and connect directly to the OM-320 circuit ground (see Figure 3... -20). Refer to Chapter 7 for steps to generate a TSA Wiring printout for use in making field wiring connections.

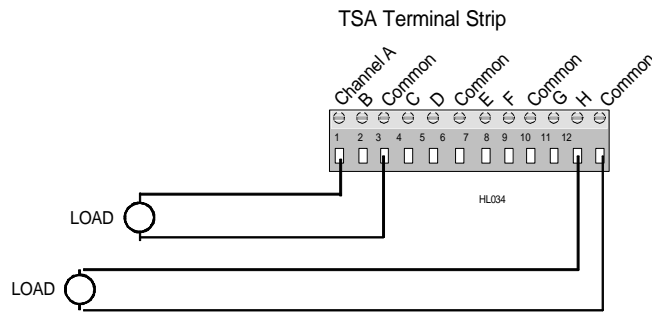

Figure 3... -23: HLIM-8 Digital output terminal strip connections

HLIM-5; PCMCIA MEMORY CARD MODULE

Overview:

The HLIM-5 is a special function Interface Module for use in the OM-320 System Base. The HLIM-5 provides capability to record data to a removable SRAM based memory card (Omega Engineering Part Numbers; MC-50, MC-100, MC-200) rather than to internal OM-320 memory. This memory card can then be read through a PD-1, PCMCIA Drive, installed (connected to) on a PC.

In addition to this function, the HLIM-5 provides support circuitry for the MM-14.4 and MM-2400 modems. These optional internal modems provide phone line based control and interrogation of the OM-320 as well as a Pager Alarm function. The modems plug directly into the HLIM-5 and can be field installed.

Module Installation:

Installation of the HLIM-5 into the OM-320 System Base is unique in that it has a memory card socket that projects through the front panel of the OM-320 (Figure 3... -24). For this reason, the HLIM-5 can only be installed into Backplane Port 6.

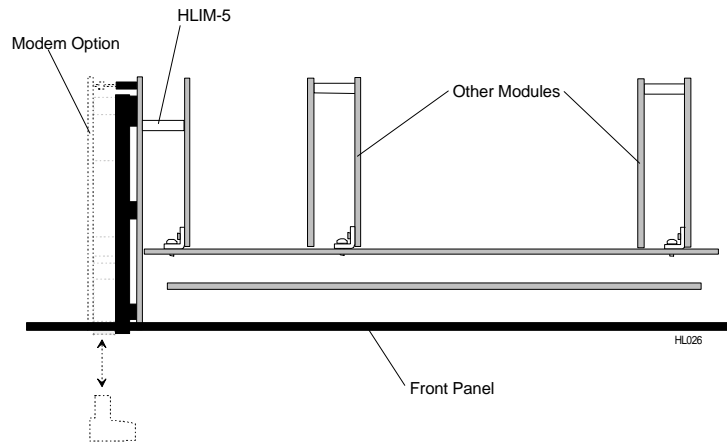

Figure 3... -24: HLIM-5 installation in Port 6

To install the HLIM-5 follow these steps:

1. Relocate any Interface Module already installed in Port 6. Refer to the Interface Module Installation, page 3-2 for general Interface Module installation and removal instructions.
2. On the OM-320 front panel, remove the two retaining screws and the cover over Option Port 2. Save the screws and cover.
3. Follow the instructions specified in the Interface Module Installation, page 3-2 to install the HLIM-5 into the OM-320 Backplane. Note that one circuit board of the HLIM-5 actually fits along the edge of the backplane and nearly touches the metal front panel of the OM-320 (Figure 3... -24). Upon completion of installation, visually insure that

all of the connector pins are mated in their respective sockets.

4. Carefully align and fasten in place the special HLIM-5 memory card socket bezel plate provided with the HLIM-5 module. Use the two machine screws removed in step 1.

Configuration of the HLIM-5:

The presence of a HLIM-5 is detected automatically by the OM-320 upon power-up. No additional software or hardware configuration of the module is necessary.

Operation of the HLIM-5 and PCMCIA Memory Card:

For full details on the configuration and use of the PCMCIA card, refer to Chapter 6.

NOTE

Numerous types of PCMCIA cards are currently available on the market utilizing various technologies. To insure compatibility with the HLIM-5, utilize only Omega Engineering supplied memory cards or verify alternate parts compatibility with Omega Engineering Technical Support prior to plugging into the OM-320.

MM-2400; 2400 BAUD INTERNAL MODEM MODULE

Overview:

The MM-2400 is a 1200/2400 Baud telephone modem module designed for installation internally in the OM-320 System Base. The MM-2400 provides direct connection between the OM-320 and a standard voice quality telephone line. This will allow the full complement of serial communications and control of the OM-320 from a remotely located PC equipped with a modem.

The MM-2400 is a low power modem, drawing approximately 50mA during operation (off-hook) and 0 mA while quiescent (on-hook). It installs on the HLIM-5 Interface Module.

Modem Module Installation:

The MM-2400 plugs into a HLIM-5 PCMCIA Interface Module, then into the OM-320 System Base backplane. The MM-2400 telephone line connectors project through the front panel of the OM-320 via Option Port 1. In installation, the MM-2400 is plugged into the HLIM-5 and fastened in place, then the entire assembly is installed into the OM-320 System Base. The HLIM-5 / MM-2400 assembly can only be installed into Backplane Port 6, as it utilizes the front panel Option Ports.

To install the MM-2400, follow these steps:

1. If an HLIM-5 (without the MM-2400 is currently installed in Port 6, remove it. If another Interface Module is installed in Port 6, relocate it to another Port. Refer to the Interface Module Installation section, page 3-2 for general Interface Module installation and removal instructions.
1. On the OM-320 front panel, remove the four retaining

Figure 3... -25: Modem module installation onto HLIM-5

- screws and the covers over Option Ports 1 and 2. Save the screws and cover.
2. After discharging any static electricity in your body (see Interface Module Handling precautions at the start of this chapter), remove the MM-2400 from its static proof bag. Unplug the terminal strip plug and set aside. Orient the MM-2400 module as shown in Figure 3... -25, and plug the gold pins on the modem module into the mating black connector on the HLIM-5. Visually check that the pins are all in the connector.
 3. Install the two machine screws provided with the MM-2400 through the HLIM-5 circuit board and into the two plastic standoffs on the MM-2400. Tighten the screws snugly.
 4. Unplug the two position terminal plug from the MM-2400 module.
 5. Follow the instructions specified in the Interface Module Installation Section, page 3-2 to install the HLIM-5 / MM-2400 assembly into the OM-320 Backplane. Upon completion of installation, visually insure that all of the connector pins are mated in their respective sockets.
 6. Carefully align and fasten in place the special HLIM-5 memory card socket bezel plate provided with the HLIM-5 module over Option Port 2 and the special bezel provided with the MM-2400 over Option Port 1. Use the machine screws removed in step 1.
 7. Plug in the terminal strip plug removed in step 3.

Telephone Line Connection:

A standard voice grade telephone line can be used with the MM-2400. The two phone conductors (tip and ring) can be connected to the MM-2400 via the provided plug-in terminal plug or a modular phone plug. Polarity is not critical for either connection method.

Terminal Plug method: Route the phone line through one of the strain reliefs at the bottom of the OM-320 enclosure. Strip back the phone lead insulation and connect the conductors to the terminal plug (polarity is not critical). The plug can then be plugged into the mating connector on the MM-2400 accessible through the OM-320 front panel Option Port 1.

Modular Phone Plug method: Plug a telephone cord equipped with a 6/2 modular phone plug (RJ-12 type) into the modular phone socket accessible through the OM-320 front panel Option Port 1. Insure that the phone conductors are installed into the center two locations of the plug (polarity is not critical).

Various length phone extension cords with the RJ-12 type modular phone plugs on each end are readily available from most phone supply stores. Insure that the `telephone base' type cord is used... not the `handset' cord as the handset plug is smaller and will not effect a good connection.

Plug the other end of the phone cord into the telephone wall jack.

3... INTERFACE MODULES

Hardware Configuration Switches:

No hardware configuration switches are provided on the HLIM-5 or the MM-2400. All configuration is done via the HyperWare software.

Operation of the MM-2400:

The presence of the installed HLIM-5 and MM-2400 is detected automatically by the OM-320 upon power-up. The MM-2400 is self-configuring with the exception of one parameter... the number of rings before the OM-320 answers an incoming call. This parameter is set from within HyperNet (the Global icon) and is thoroughly explained within the Master Icon Listing in Appendix A under the Global icon section.

Additional information on the setup and configuration of the modem located at the PC is provided in Appendix K.

MM-14.4; 14.4KBAUD INTERNAL MODEM MODULE

Overview:

The MM-14.4 is a 1200, 2400, 4800, 9600, 14,400 Baud telephone modem module designed for internal installation in the OM-320 System Base. The MM-14.4 provides direct connection between the OM-320 and a standard voice quality telephone line. It allows the full complement of serial communications and control of the OM-320 from a remotely located modem equipped PC.

The MM-14.4 is a low power modem, drawing approximately 125mA during operation (off-hook) and 0 mA while quiescent (on-hook). It installs on the HLIM-5 Interface Module.

Installation / Operation:

The MM-14.4 is installed and configured identically to the MM-2400. Refer to the MM-2400 installation and configuration instructions in the previous section for details.

Additional information on the setup and configuration of the modem located at the PC is provided in Appendix K.

4... HYPERWARE™ SOFTWARE INTRODUCTION

SOFTWARE OVERVIEW

Included with the OM-320 System is HyperWare™, a multi-functioned Windows™ based software package. HyperWare is an integrated program that works with the OM-320 to provide communications, programming and collected data display. Integrated in the HyperWare program are the following windows / environments:

- ◆ **HyperComm™** - supports serial communications between the OM-320, the PC, and the PCMCIA drive *graphically*. Via HyperComm, Status inquiries can be made, data is downloaded, and Program Nets are transferred between the PC, the PCMCIA drive and/or the OM-320,
- ◆ **HyperNet™** - a visual programming environment for developing Program Nets via Icons and connections. The developed Net is then transferred to the OM-320 memory where it provides operating instructions for the logging session.
- ◆ **Post Processing (including HyperPlot™)** - for graphing and data conversion of OM-320 collected data.
- ◆ **HyperTrack™** - providing *real-time* data display of Program Net nodes as they are processed by the OM-320.

Figure 4... -1: Organization of HyperWare software

Each of the above HyperWare windows is covered in a separate chapter within this manual. In a typical data collection session with the OM-320, all of the above functions will be used.

PC REQUIREMENTS

To install and use HyperWare, the following minimum equipment is required:

4... HYPERWARE™ SOFTWARE INTRODUCTION

- ◆ 386 or higher IBM PC compatible
- ◆ 4 Meg (minimum) of RAM memory
- ◆ Mouse or other pointing device
- ◆ Serial port for OM-320 connection (via Modem or RS-232 link)
- ◆ Microsoft Windows 3.1
- ◆ VGA display
- ◆ 5 Meg of Hard disk space
- ◆ Windows supported / installed printer (optional)

HYPERWARE INSTALLATION

To install the HyperWare program onto your PC hard disk follow these steps:

1. Start Microsoft Windows.
2. Insert the HyperWare Program disk #1 into your floppy drive.
3. From the Program Manager's *File* menu, select *Run*, then type **a:install** (or **b:install**) then <ENTER>
4. Follow the on screen directions for installing the software. Dialogs prompting for User input will display during the installation providing the opportunity to customize the installation. For most Users, selecting the *default* responses to the prompts will provide a fool-proof installation.
5. After installation, double-click on the new HyperWare icon (from within the Program Manager) to launch the HyperWare application.

UPGRADING HYPERWARE TO A NEW VERSION:

Instructions for upgrading HyperWare from a previous release are supplied with the new upgrade diskette.

HYPERWARE PROGRAM TOPOLOGY

Upon launch of the HyperWare program, the HyperComm window will be displayed. From the HyperComm window, switching to other windows (HyperNet, HyperTrack, and Post-Processing) is performed by clicking on the buttons displayed on the button bar at the top of the HyperComm window. HyperWare can be visualized as shown in Figure 4... -1. From the other windows, return to the HyperComm window by clicking on the HyperComm button at the left end of the button-bar.

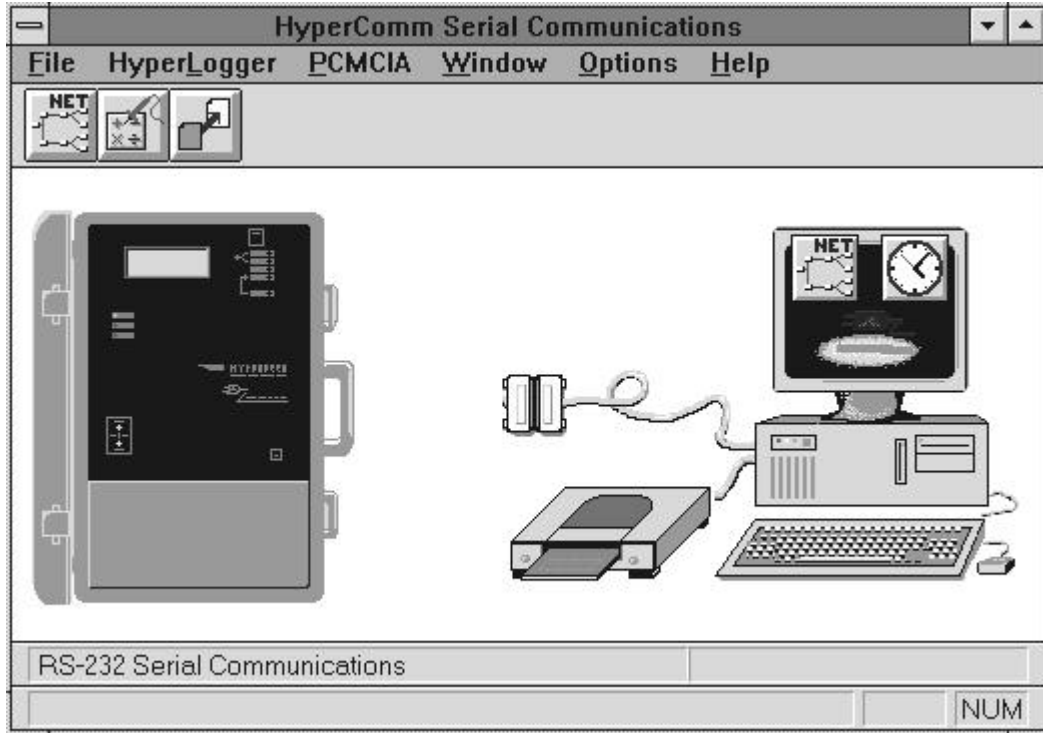

Figure 4... -2: The Opening HyperComm Window

USER INTERFACE

HyperWare complies with the conventional keyboard and mouse commands that are used in most Windows applications. Some commands require double-clicking (such as the Enable and Stop commands via serial communications) and others utilize a visual click and drag of icons (as in construction of Program Nets and for icon based serial communications).

In the HyperComm window and throughout HyperWare, passing the cursor over icons and buttons results in a short descriptor display on the Status Message Bar in the lower left corner of the screen.

HyperWare features on-line help using the conventional Windows help format. Press the <F1> key at any time or utilize the Help menu to select options for HyperWare help.

4... HYPERWARE™ SOFTWARE INTRODUCTION

NOTES:

5... HYPERCOMM™ SERIAL COMMUNICATIONS

OVERVIEW

Upon launching HyperWare, the *HYPERCOMM* window (Figure 5... -1) will appear with graphic images of a PC with a connected PCMCIA card drive (optional) and a OM-320. From within this window, communications between the PC and the OM-320 as well as communications between the PC and the PCMCIA card drive are initiated and handled.

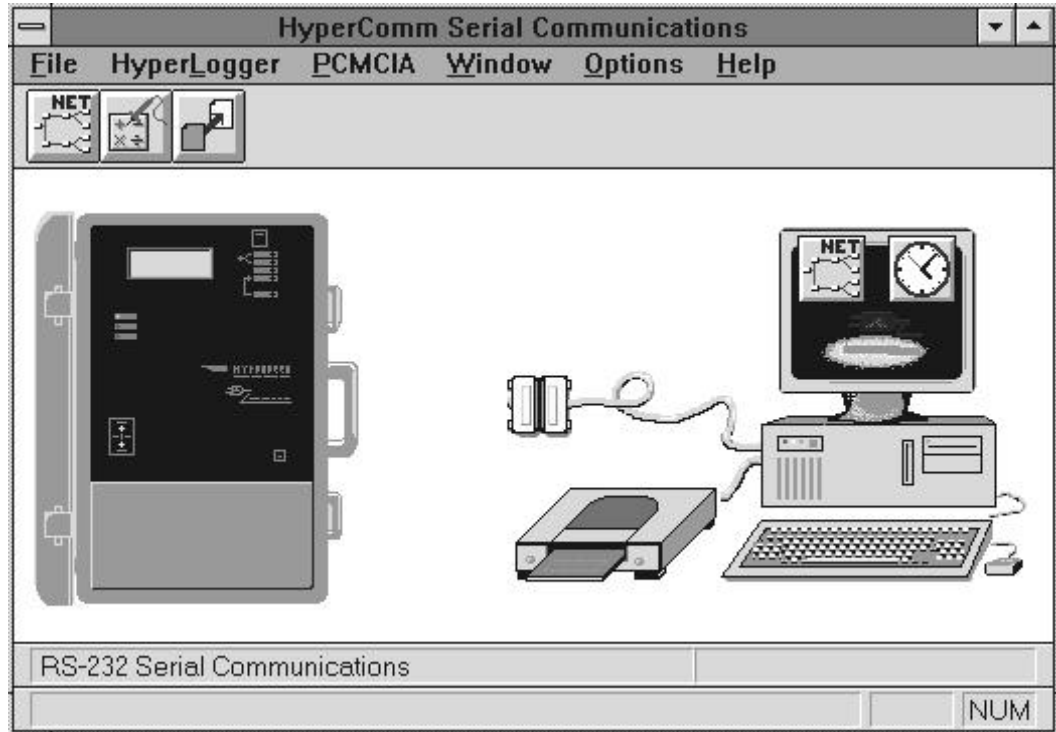

Figure 5... -1: HyperComm serial communications window (no serial connection)

The external PCMCIA card drive is an optional system item. Data and Program Net information is transferred between the PC and the PCMCIA card drive by simply dragging and dropping the appropriate icons overlaying the PC and the drive. Chapter 6 contains details on the setup and use of the PCMCIA card feature.

In serial communication between the OM-320 and the PC, both RS-232 and telephone modem communications are supported. A simple dialog box is provided for the communication link setup, thereafter all communications are handled by dragging icons (representing information) between the graphic PC and OM-320.

Communications between the PC and a connected OM-320 are required for a multitude of functions including download of OM-320 collected data, programming of the OM-320, and real-time data display.

From the HyperComm window, access to the *HYPERNET*, *HYPERTRACK*, and *POST-PROCESSING* windows is achieved by clicking on one of the three buttons on the Button Toolbar.

ESTABLISHING AN RS-232 LINK

RS-232 Hardware Connection:

Select and plug in one of the provided DB-9 to RJ-12 adapters to fit the PC serial port desired for OM-320 communications. A 9-pin and a 25-pin adapter are provided with the OM-320. Plug one end of the provided RS-232 cable (CAR-4) into the adapter modular jack and the other into the Serial Port jack on the front of the OM-320 and turn OM-320 System Power ON.

HyperComm Connection via RS-232:

After launching HyperWare and display of the opening screen, the *HYPERCOMM* window will be displayed. Move the cursor over the graphic DB-25 type connector (center of the screen on the cable) and double-click to bring up the *SERIAL COMMUNICATIONS* dialog box (Figure 5... -2).

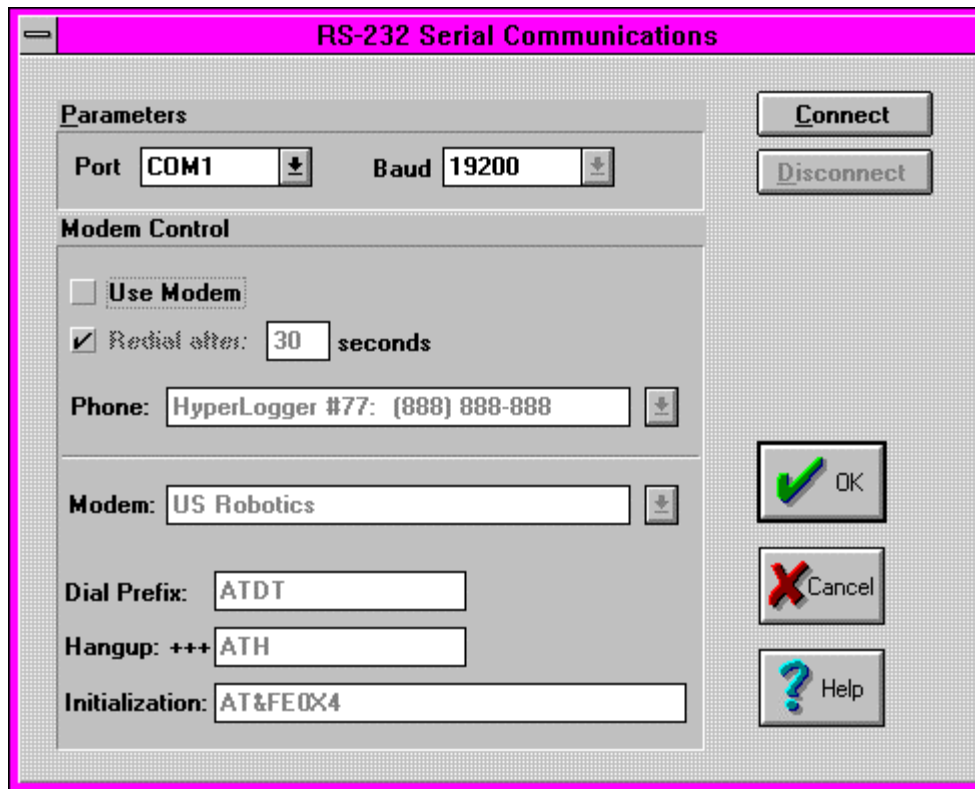

Figure 5... -2: Serial Communications setup dialog box (RS-232 mode)

For RS-232 communication, insure that the *USE MODEM* check box in the *MODEM CONTROL* section is not checked.

Select the *PORT* using the pull-down list boxes under the *PORT PARAMETER SECTION*. Select the port to which the RS-232 adapter is connected. For RS-232 communications 19,200 Baud is automatically selected and will provide the fastest data transfers..

TIP: *If the port number is unknown, select one of the ports then attempt to connect (see following). If unsuccessful, change the selected Port and try again.*

After selecting the port, click on the *CONNECT* button to initiate communication with the OM-320. At this time, HyperWare will attempt to communicate with the OM-320. Close the *SERIAL COMMUNICATIONS* dialog box by clicking the OK button and HyperWare will return to the *HYPERCOMM* window ready for communication.

If the link fails, check the following:

- ◆ Is the cable connected?
- ◆ Is the **Omega Engineering supplied** adapter used?
- ◆ Insure that the adapter used is the one that was supplied with the OM-320. (other Omega Engineering products use other similar looking but functionally different adapters)

NOTE: *LBI supplied adapters are wired for proper compatibility between the OM-320 and the PC. If an alternatively sourced adapter is used, insure that it complies with the wiring specified in Appendix I.*

Also, adapters that convert DB-25 to DB-9 (and vis-a-versa) commonly cause problems. Utilize the proper adapter supplied with the OM-320 (both DB-9 and DB-25 are supplied).

- ◆ Is the OM-320 power ON?
- ◆ Select another serial port from within the *SERIAL COMMUNICATIONS* dialog box and retry.

ESTABLISHING A TELEPHONE MODEM LINK

Modem Hardware Configuration:

Before attempting a link to a OM-320 via telephone modem, insure the following equipment requirements are met:

- P The OM-320 must have a MM-14.4 or MM-2400 Modem Option installed. *This modem is referred to as the remote modem in this manual.*
- P The PC must have a Hayes compatible modem installed or connected and powered. *This modem is referred to as the local modem in this manual.*
- P Info on the PC modem capabilities must be on hand (ie Baud rate capabilities, installed port, etc)

HyperComm Connection via Modem:

Launch HyperWare and after the opening screen, the *HYPERCOMM* window will be displayed. Move the cursor over the graphic DB-25 type connector (center of the screen on the cable) and double-click to bring up the *SERIAL COMMUNICATIONS* dialog box (Figure 5... -2).

Click on the *USE MODEM* check box under *MODEM CONTROL* and the dialog will change slightly (Figure 5... -3) to enable editing of parameters in the *MODEM CONTROL* section. Edit the various parameters within the *MODEM SERIAL COMMUNICATIONS* dialog box per the following guidelines:

Port:

Specify the *PORT* using the pull-down list box under the *PORT PARAMETER SECTION*. Select the port to which the modem is connected.

TIP: *If the port number to which the modem is connected is unknown, select one of the ports then attempt to connect (see following). If unsuccessful, change the selected Port and try again.*

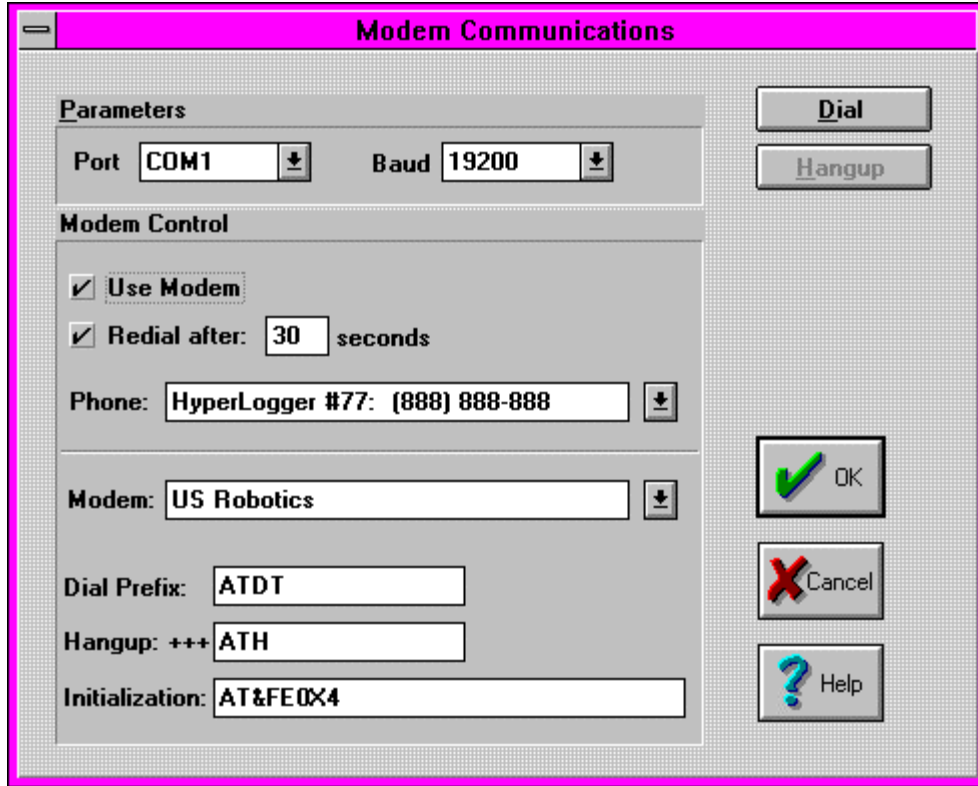

Figure 5... -3: Serial Communications setup dialog box (Modem mode)

Baud:

Specify the baud rate rate that will be used to communicate between the PC and the local modem. Set this baud rate per the following

Local Modem Capability	Set Dialog Box Baud To:
1200 baud	1200 baud
2400 baud	2400 baud
9600 or faster baud	19,200 baud

Table 5... -1: Local modem settings

table:

***FYI:** The remote modem (at the OM-320) will automatically adapt to the baud rate of the calling modem.*

Redial:

If this box is checked, HyperWare will automatically make another attempt to call the OM-320 if the first attempt fails for any reason. The time specified in the edit box is a delay time to wait before attempting the next call.

Phone:

A short dialing directory of frequently called OM-320 numbers can be maintained using the List Box provided.

ADDING A NEW DIRECTORY ENTRY:

To add a directory entry, use conventional text editing commands to highlight then type over an existing entry. The entry will not be lost and a new entry will be added.

The format for the directory entry consists of text followed by a colon, then the phone number.

USER TEXT:619-555-1212

The phone number may contain numbers, hyphens, parenthesis and commas with the following action:

- ◆ Numbers - digits 0 through 9 are dialed
- ◆ Hyphens and parenthesis - ignored during dialing
- ◆ Commas - insert a two second delay during dialing. Delays may be required for accessing an outside line on some phone systems.

EDITING AN EXISTING DIRECTORY ENTRY

Select the entry to be edited via the drop down list box. Using the mouse, highlight the text to be edited and type in corrections.

REMOVING DIRECTORY ENTRIES

The phone list is maintained within the hyperlog.ini file. This file is located in the Windows directory and can be edited with any text editor. Before editing this file, close the HyperWare application and make a backup copy of the hyperlog.ini file in case it needs to be restored. Two lines in the hyperlog.ini file need to be deleted to properly remove a phone directory entry. Follow these steps to remove the directory entry:

1. Close the HyperWare application.
2. Locate the hyperlog.ini file in the windows directory and make a copy of it (eg hyperlog.bak)
3. Using Notepad, open hyperlog.ini
4. Locate the section titled [Modems]
5. Locate the line starting with *PhoneX=* where X is a number and the entry to the right of the equal sign is the entry to be removed.
6. Make a note of the value of X. Then delete the entire line starting with *PhoneX =*
7. Locate and delete a second line with the same value of X that starts with *ModemX=* which will be located in the same section.
8. Save and Exit the editor. Re-launch HyperWare and check that all is well.

Modem:

HyperComm includes the standard configurations for three major modem brands, Hayes Compatible, US Robotics, and Zoom. Refer

to the modem's manual for the command set used by the modem installed at the PC. Note that most modems (although not necessarily manufactured by Hayes, US Robotics, or Zoom) can utilize one of these three configurations.

Clicking on the Modem list box and selecting the desired modem will automatically configure the various modem parameters to meet most User's needs.

If a modem with a command set different from the supplied three is used, a custom Modem Type entry can be added to the Modem list box. To enter a custom Modem Type, the Dial Prefix, Hangup command, and Initialization strings need to be added. Refer to the User's manual supplied with your modem and follow these steps to add a custom Modem Type entry:

1. Click on the Modem list box arrow and enter a new Modem configuration name.
2. Edit the Dial Prefix text box with the command required by your modem. Upon commencing of dialing, this Prefix string is sent immediately before the phone number. For most modems this will be ATDT (if touch-tone dialing is supported by the phone line) or ATDP (for pulse dialing on phone lines not supporting touch-tones)
3. Edit the Hangup text box for the requirements of your modem. Most modems will use ATH. The Hangup string is transmitted to the modem when the User clicks on the Hangup button from within the Modem Communications dialog.
4. Edit the Initialization text box for your modem's requirements. A multitude of variations are possible for this initialization string and the modem User's manual should be referenced carefully. The initialization string is sent to the modem immediately after clicking on the Dial button within the Modem Communication dialog. Key parameters to specify in the modem initialization string include:
 - P Verbal Response codes ENABLED
 - P Full Response code set ENABLED (eg Busy, Connect 14400/ARQ, etc)
 - P Echo DISABLED (off)
5. Clicking on the OK button saves the three strings to the Modem Type name specified in the Modem list box.

After configuring all modem parameters, click on DIAL and the modem connection sequence will commence. After a short dialing and communication protocol negotiation between the modems, a dialog box will show indicating success or failure in making the link.

If successful, click OK . Close the *SERIAL COMMUNICATIONS* dialog box with another OK and HyperWare will return to the *HYPERCOMM* window ready for communication.

If the link fails, check the following points:

- ◆ Is the PC to modem cable connected? (external modems only)

5... HYPERCOMM™ COMMUNICATIONS

- ◆ Is the modem power ON? (external modems only)
- ◆ Is the local modem port selected correctly? If in doubt, select another serial port from within the *SERIAL COMMUNICATIONS* dialog box and retry.
- ◆ Is the selected baud rate correct for the modem?
- ◆ Is a working telephone line connected to the modem?
- ◆ Is there another device using the telephone line (i.e. a fax machine)
- ◆ Does the modem work with other communication programs? If not, this may indicate that the modem port is conflicting with another serial port.

Additional modem configuration and troubleshooting information is supplied within Appendix K.

VISUAL COMMUNICATIONS VIA HYPERCOMM™

Once the serial link (via RS-232 or modem) is established, a complete cable will show between the OM-320 and the PC and additional icons will overlay the OM-320 graphic (Figure 5... -4). Depending on the type of link established, a modem or DB-25 connector will display in the middle of the cable. At this time, control and interrogation commands can be sent to the OM-320.

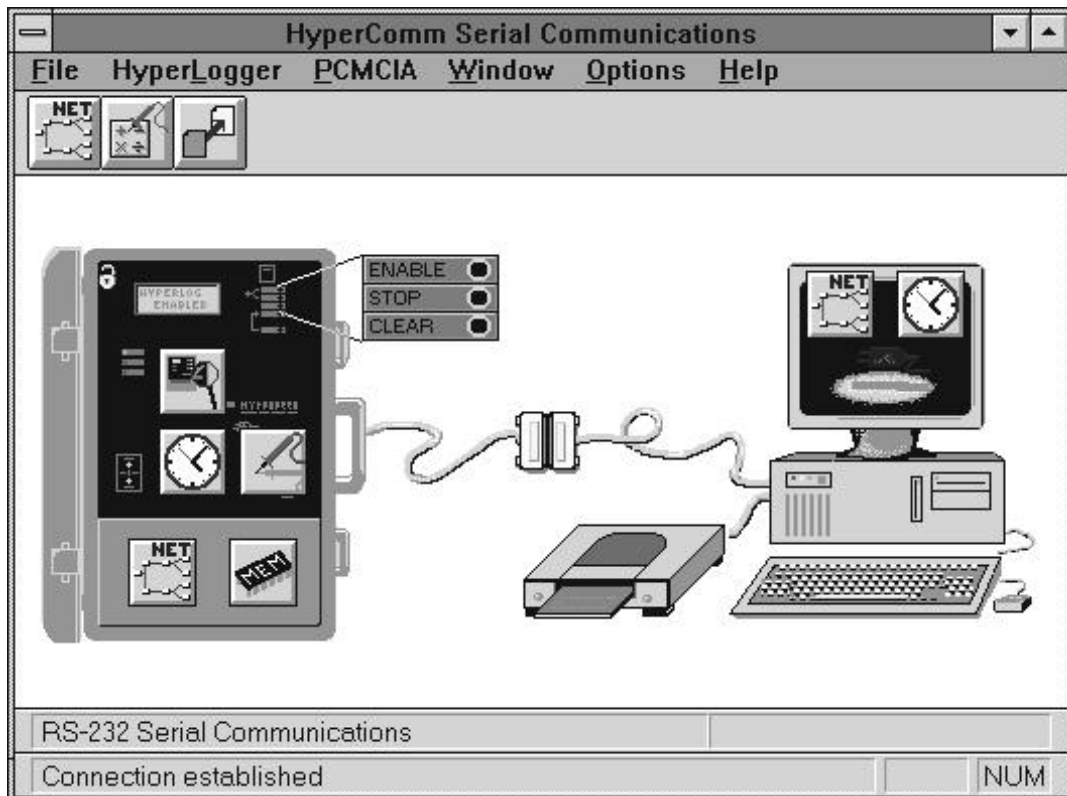

Figure 5... -4: HyperComm serial communication window (connection established)

Communication Techniques

Visual communication has been designed into the HyperComm Window allowing for intuitive mouse driven communication. Two methods are used for communicating commands between the PC and the OM-320:

Drag and Drop of Icons: Icons representing various types of information are overlaid on the PC and OM-320 graphics. By dragging and dropping these icons between the PC and the OM-320, data communication is implemented.

For example, to set the OM-320 Clock to the current PC time, merely click and hold on the Clock Icon overlaying the PC, drag it over the the OM-320 and release it. A confirmation dialog will display to insure your actions.

Double-Clicking Icons: Immediate commands can be executed by double-clicking on many of the icons. For example, to Enable the OM-320, position the cursor over the Enable Button and double-click and a confirmation dialog will display to insure your actions.

TIP: Some of the icons can be double-clicked on as a short-cut command. For example, double-clicking on the Clock Icon overlaying the OM-320 allows for directly setting the clock via text entry.

Communication Icons and their Functions

Enable Button Icon

Double-clicking on this button performs the same function as pressing the Enable button on the front of the OM-320. After double-clicking, a dialog will appear to confirm the action. If any error conditions exist (eg the Program Net is incompatible with the hardware) a warning dialog will display and the OM-320 may not be Enabled. Operational Status can always be confirmed with the Status Query command (below).

If the OM-320 is Rotary Memory mode, and data has been stored to memory, the memory will have to be cleared before Enabling is allowed.

Stop Button Icon

Double-clicking on this button performs the same function as pressing the Stop button on the front of the OM-320. After double-clicking, a dialog will appear to confirm the action. Operational Status can always be confirmed with the Status Query command (below).

Clear Button Icon (OM-320 Clear not PCMCIA Clear)

When the OM-320 is not Enabled, double-clicking on this button results in a clearing of memory (after confirmation). After double-clicking, a dialog will appear to confirm the action. Memory Status can always be confirmed with the Status Query command (below).

The OM-320 memory can be cleared while the OM-320 is Enabled. However, If the OM-320 is Enabled, only memory containing data that has been downloaded will be cleared. This allows for OM-320 use in long duration continuous acquisition and download periods without missed data.

Unit Name and ID Query

Each OM-320 can be assigned an ID and short Name. The ID and NAME are retained in OM-320 memory until changed via the following procedure and are not cleared with power down or Memory Clear commands. Both entries can be displayed on the OM-320

LCD under the STATUS menu and are also available via a OM-320 Status Query from the PC (following).

To program the OM-320 ID and NAME, move the cursor over the LCD on the OM-320 and double-click. A dialog will open for editing. OK will reprogram the OM-320 to the new ID and NAME.

Status Query

At any time, the OM-320 can be interrogated for its operational Status.

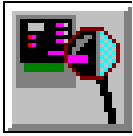

Figure 5...
-5: Status
icon

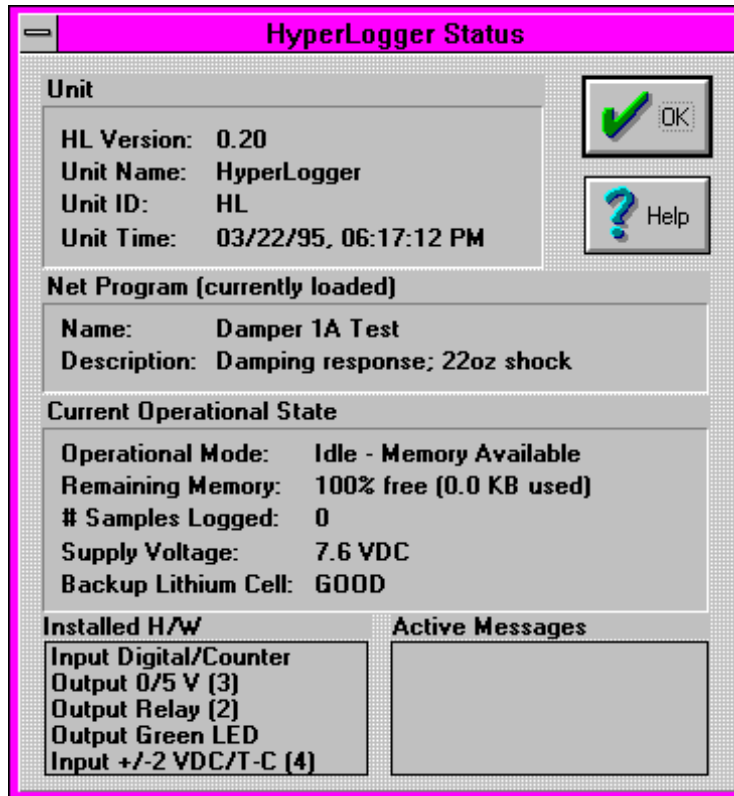

Figure 5... -6: OM-320 Status report dialog

Drag and drop the Status Icon from the OM-320 to the PC and release it. The OM-320 Status dialog (Figure 5... -6) will open detailing operational information.

Reported information includes:

UNIT INFORMATION:

OM-320 VERSION:

Specifies the OM-320 version number.

UNIT NAME AND UNIT ID:

User programmable information for tracking of equipment (see procedure for setting described above).

UNIT TIME:

The current date and time on the OM-320 internal real time clock.

PROGRAM NET INFORMATION:

NAME AND DESCRIPTION:

Information that has been User programmed in the Global Icon from within HyperNet.

CURRENT OPERATIONAL STATE:

OPERATIONAL MODE:

Indicates if the unit is Enabled, Stopped, Idle, etc.

REMAINING MEMORY:

Specifies the percentage and Kilobytes of data memory still available. When using this number for estimating available logging time consideration must be made for varying sampling rates and data storage formats.

OF SAMPLES LOGGED:

Specifies the number of samples recorded to memory.

SYSTEM SUPPLY VOLTAGE

Displays the OM-320 supply voltage. If internal batteries are installed in the OM-320 and an external power supply is also connected, the displayed *Supply Voltage* refers to the greater of the two.

FYI: The displayed Supply Voltage is measured at an internal node on the power supply circuitry. Displayed battery voltage will be the voltage of the internal batteries. External supply voltage will be approximately 1.2 volts higher than indicated.

BACKUP LITHIUM CELL:

The state of charge display for the lithium cell (used for data memory and clock backup) will display *GOOD* or *LOW*. If *LOW* is displayed, download any desired data memory, then replace the lithium cell (See Appendix D).

INSTALLED H/W (HARDWARE)

This box lists the standard (eg relays, GPDI, etc) and installed hardware (eg Interface Modules, modems, etc.)

ACTIVE MESSAGES

Displays any messages that have been generated due to abnormal operating conditions (such as a power failure) or as a result of a Message Icon being activated from within a Program Net (Chapter 7).

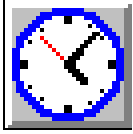

Figure 5...
-7: Time
Set icon

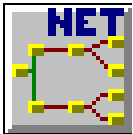

Figure 5...
-8: Net
icon

Time Set

The OM-320 real-time-clock can be set in two different ways.

Synchronized with PC Time: By dragging the Clock Icon from the PC to the OM-320 and releasing, the PC system time is programmed into the OM-320.

Set Absolute Time: Double-clicking on the Clock Icon overlaying the OM-320 graphic will display a Time Set dialog. Edit the dialog and select OK to program the OM-320 clock to the displayed date and time. This method is handy when communicating via modem with OM-320s located in different time zones.

Program Net Transfer

Refer to Chapter 7 for details on the transfer of Program Net to and from the PCMCIA card.

After the serial link is established, a Net icon will display overlaying both the OM-320 and the PC in the HyperComm window. The Program Net icon overlaying the OM-320 represents the Program Net currently loaded into OM-320 memory. The Program Net overlaying the PC represents the last Program Net edited from within the HyperNet (Chapter 7) development window or the last Program Net downloaded from a serially connected OM-320.

Program Nets can be transferred in both directions:

- ◆ Downloaded from the OM-320 to the PC to review/edit the Program Net currently loaded into OM-320 memory.
- ◆ Uploaded from the PC to the OM-320 to reprogram the OM-320

At any time, the Program Net currently loaded in the OM-320 memory can be downloaded to the PC. Click and drag the Program Net Icon overlaying the OM-320 to the PC and release it. This Program Net can then be edited, saved, and/or uploaded back to the OM-320.

To reprogram the OM-320 with a new Program Net, click and drag the Net Icon overlaying the PC to the OM-320 and release it. *The Net icon on the PC represents the last Program Net (*.NET) file edited from within the HyperNet (Chapter 7) window or the last Program Net downloaded from a serially connected OM-320.*

If a different Program Net is to be transferred, open the desired Program Net from within HyperNet, then return to the HyperComm window and drag the icon to the OM-320.

NOTE: *If the target OM-320 memory contains collected data, the User will be prompted to download or clear the data prior to reprogramming. Upon upload of the new Program Net, **data in the OM-320 memory will be lost.***

NOTE: During the upload of a Program Net to the OM-320, several integrity tests are performed. One of the tests checks the size of the Program Net to insure that it will fit into the available OM-320 memory. In the event that the Program Net is too large, reduce the number of icons and retry. Refer to the README file supplied with the HyperWare for an approximate maximum number of icons that can be included in a Program Net for that version of software.



Figure 5...
-9:
Memory
icon

Data Download

Refer to Chapter 6 for details on the Download of Data from the PCMCIA card.

To transfer data from the OM-320 memory to a file on the PC disk, click and drag the Memory icon overlaying the OM-320 to the PC and release it. After a prompt dialog, the data will be downloaded. Upon completion of the serial data transfer, a filename will be requested by a pop-up dialog.

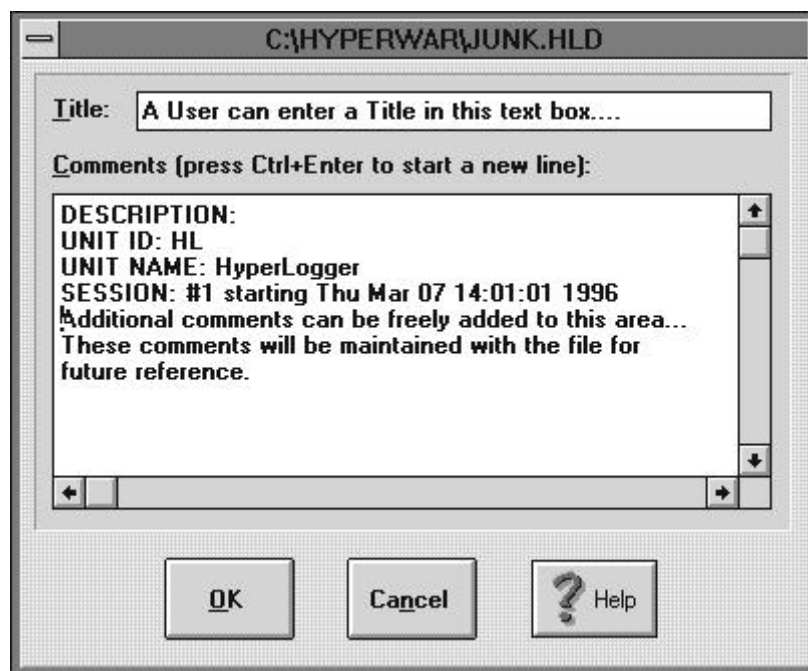

Figure 5... -10: File Information comments entry dialog

After entry of the filename, a dialog will display for the User to enter additional File Information to be stored with the file (Figure 5... -10). This information includes a short single line Title as well as room for extensive comments. The File Information can be accessed at a later time from within the Post-Processing window and HyperPlot. Upon closing of this dialog, the Download file will then be processed and stored to disk as an ascii file with the extension *.HLD.

Data downloads can be performed while the OM-320 is Enabled and executing a Program Net that uses either of the Log to Full modes (see the Global Icon in Appendix A). If the OM-320 is in the Rotary

Memory mode, the unit must be Stopped before data can be downloaded.

Probe Point Query

During the construction of a Program Net within HyperNet™, the User can opt to connect Probe Point icons to various nodes throughout the net. These Probe Point icons allow the User to view the current values on the nodes to which they are connected. One of the ways that the Probe Point values can be viewed is by clicking and dragging the Probe Point icon overlaying the OM-320 to the PC and releasing it. The *last updated value at the Probe Point node* is then displayed on the PC. Optionally, by clicking on the *Resample Periodically* check box, readings will be communicated to the display dialog as the node is updated.

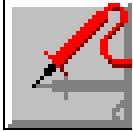

**Figure 5...
-11: Probe
Point icon**

FYI: *Probe Point is used for the icon name as connecting these icons to a node on a Net is somewhat analogous to putting a test meter probe on the Net nodes and reading a value.*

If a Program Net that contains Probe Point icons is currently loaded into PC memory, then a Probe Point icon will display overlaying the PC.

Password

The logger contains a multi-level password system that can be used to foil unauthorized access via telephone modem or RS-232 connection. The logger password system allows for five passwords, a Master and four User passwords.

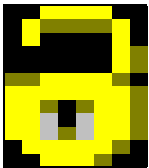

**Figure 5... -
12:
Password
lock**

MASTER PASSWORD

The Master password allows access to all logger functions, including the ability to manage the User passwords. To enable or change the Master password, double-click on the Password icon (small lock graphic) in the upper left corner of the logger graphic in the HyperComm Window . A dialog will appear which allows the Master password to be changed, and the User passwords to be configured.

USER PASSWORDS

Up to four User passwords can be set. These passwords allow for specific control of access to individual logger functions. Access to the User password configuration dialog requires the Master password. To configure User passwords, double-click on the Password icon, enter the Master password, and click on the Configure button. A dialog will open allowing the User passwords to be configured. Enter user passwords in the four text boxes at the top of the dialog. Specific logger functions can then be checked to allow access to that function for that password.

CAUTION

Keep track of Passwords as they can not be disabled via a serial link without knowing the Master password.

PASSWORD PROTECTED FUNCTIONS

Access to the following functions can be granted/denied via

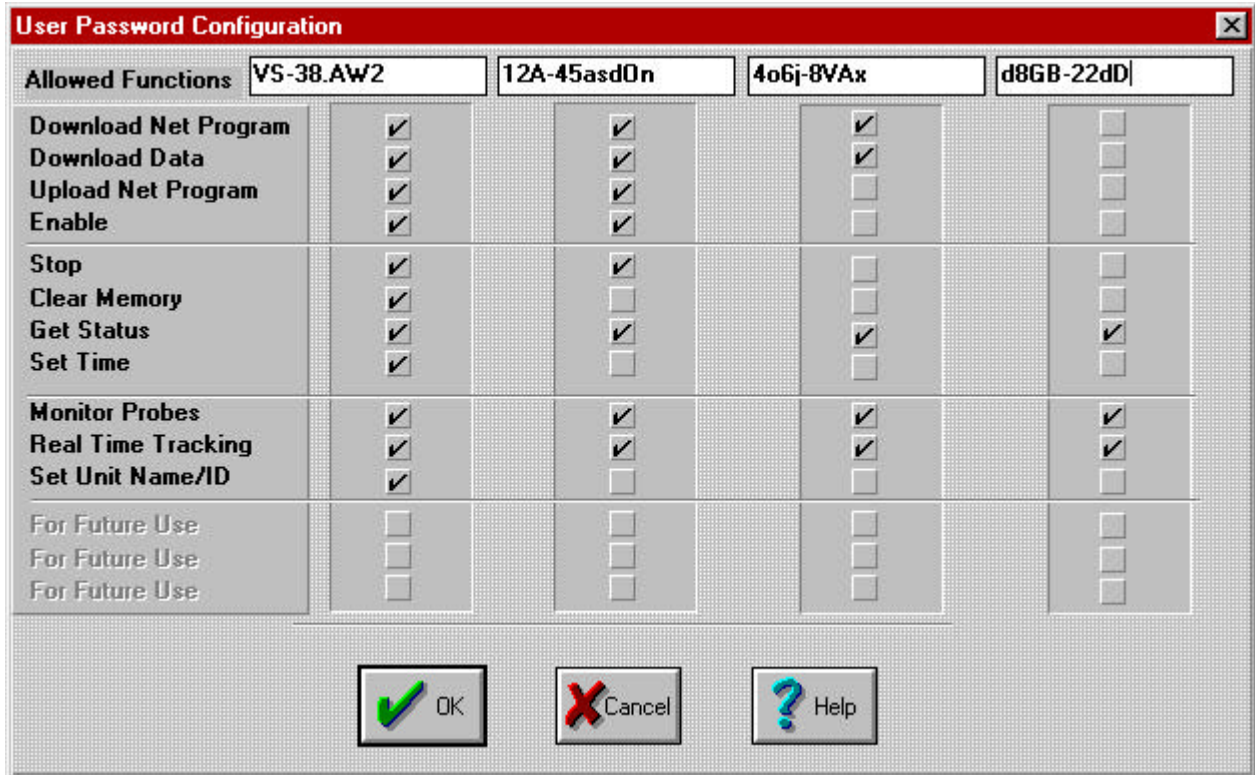

Figure 5... -13: Password Configuration Dialog

the User password configuration dialog. A checked box indicates that access is granted to the corresponding function.

- ◆ Download Net Program
- ◆ Download Data
- ◆ Upload Net Program
- ◆ Enable
- ◆ Stop
- ◆ Clear Memory
- ◆ Get Status
- ◆ Set Time
- ◆ Monitor Probes

- ◆ Real Time Tracking
- ◆ Set Unit Name/ID

DOWNLOAD NET - A SPECIAL CASE

In order to Download Data or run a Real Time Tracking session, the Program Net that is running in the logger must also be loaded into HyperWare. Because of this, HyperWare automatically Downloads the Net from the logger prior to executing either function. Since this is required, any time that either the Download Data or Real Time Tracking boxes are checked, the Download Net box is automatically checked.

DISABLING PASSWORDS

To disable the logger Password feature, the Master Password is required. Double-click on the Password (lock) icon, enter the Master password when prompted and select Change Master Password. Click the OK button *without entering any text in the New Password or Confirm text boxes*. This will clear the Master password and allow access to all logger functions without a password.

5... HYPERCOMM™ COMMUNICATIONS

NOTES:

6... PCMCIA CARD CONFIGURATION AND USE

OVERVIEW:

The OM-320 utilizes the optional PCMCIA Card System to provide expanded data storage capacity within the OM-320 and/or to provide storage to a removable memory card that can be removed and transported to another location where the data is read from the card and saved into a file on the a PC.

For expanded memory capability, the OM-320 requires the HLIM-5 Interface Module which includes the PCMCIA card socket and one or more PCMCIA cards. If the memory card is to be used in a transportable mode, an external PCMCIA drive (PD-1 or also referred to as TMD-650) is required at the PC location.

With PCMCIA memory card system the following features are available:

- ◆ Expanded memory... OM-320 memory storage increase from the standard 40,000 readings to in excess of 250,000 readings.
- ◆ Transportable data... the memory card can be removed from the OM-320 and transported to a PC location where the data can be read from the card
- ◆ Field reprogramming of the OM-320... a Program Net can be built in the office through HyperWare, then loaded onto the PCMCIA card for transport to the OM-320 location

PCMCIA CARD SYSTEM COMPONENTS:

The PCMCIA card system consists of the following components:

- ◆ **HLIM-5 Interface Module:** the HLIM-5 interface module installs into the OM-320 System Base and contains the socket into which the memory card inserts.

NOTE

This socket is not PCMCIA spec compliant. For this reason, do not plug any products into this socket that have not been provided or approved by Omega Engineering Incorporated.

- ◆ **Memory Card:** with varying capacity from 50,000 samples to in excess of 250,000 samples, this is the transportable SRAM memory onto which data and Program Nets are stored.
- ◆ **PD-1 (also referred to as the TMD-650) PCMCIA Drive:** this external drive connects to the PC parallel (printer) port and provides read/write capability between the PC (running HyperWare software) and the PCMCIA card.
- ◆ **PD-1 Software Drivers:** a set of software drivers (CardTalk) provided with the PD-1 that are installed to hard disk and provide the necessary software interface between the PD-1 drive and HyperWare. Also included are a number of utilities for use in formatting, copying etc on the PCMCIA card.

PCMCIA CARD - EXPANDED MEMORY CAPACITY APPLICATION

Hardware Configuration

For applications using the PCMCIA card only for expanded memory capacity within the OM-320, the only components required are the HLIM-5 and one or more memory cards (formatted for use with the OM-320 PCMCIA card system). The HLIM-5 module should be installed per the Interface Module instructions in Chapter 3. Memory cards for use in this system are supplied pre-formatted from Omega Engineering Incorporated.

Software Configuration

No special software configuration is required. When the HLIM-5 is installed in the OM-320, the OM-320 will auto-detect the presence of the module.

Operation of the HLIM-5 and PCMCIA Memory Card:

To use the PCMCIA card for data storage...

1. STOP the OM-320. Cycle the OM-320 power to OFF.
2. Visually inspect the formatted and prepared (as supplied from Omega Engineering Incorporated) PCMCIA card connector for any debris in any of the connector holes and clean if necessary.
The Write Protect switch located on the end of the card opposite the connector should be slid away from the WP position to enable writing of data to the memory card (Refer to Figure 6... -1).
3. Orient the card with the top label facing toward the right side of the OM-320 and slide the card fully into the card slot in Option Port 2. Upon full insertion, the Eject button next to the slot will be fully extended.
4. Turn the OM-320 Power ON. Press the ENABLE button.
5. The PCMCIA card will be automatically detected and the LCD will display ENABLED - PCMCIA. All logged data will be stored in the PCMCIA card.
 - ◆ If the OM-320 displays STOPPED after Enabling, the Write Protect switch on the PCMCIA card is in the PROTECT position. Correct and reinsert the card. Press ENABLE and observe the display.
 - ◆ If the PCMCIA card does not contain the proper format and support files (as supplied from Omega Engineering Incorporated) a message on the display will indicate CARD ERROR. The card must be reformatted and the support files rewritten before use.

CAUTION:

If the memory card does not easily insert fully into the socket, double-check the orientation. The socket is designed to prevent full insertion with reversed orientation.

For data storage on the memory card, the Write Protect switch must be in the disabled position (ie slid away from the WP mark)

NOTE

Numerous types of PCMCIA cards are currently available on the market utilizing various technologies. To insure compatibility with the HLIM-5, utilize only Omega Engineering supplied memory cards or verify alternate parts compatibility with Omega Engineering Technical Support prior to plugging into the OM-320.

PCMCIA CARD - TRANSPORTABLE DATA APPLICATION

For applications of the PCMCIA card for transportable data, the OM-320 must be configured with the HLIM-5 Interface Module and an the external PCMCIA drive (PD-1) must be connected to the PC and interface drivers installed. The correct PCMCIA drive letter must then be specified within HyperWare.

OM-320 Configuration

The HLIM-5 module should be installed per the Interface Module instructions in Chapter 3. Memory cards for use in this system are supplied pre-formatted from Omega Engineering Incorporated.

PC / External PCMCIA Drive Configuration

The following steps must be performed to configure the PC and the PD-1 external PCMCIA card drive. The procedure for connecting the PD-1 (also known as TMD-650) drive and configuring the software drivers is contained within the User's Guide supplied with the PD-1 drive. Additional comments and suggestions are provided below.

Connecting the PD-1 Drive:

Follow the instruction detailed in the User's Guide supplied with the drive.

Installing the CardTalk Drivers:

Follow the detailed instructions in the User's Guide supplied with the drive. The installation process creates a directory called CardTalk and copies a number of files into it. It then modifies the AUTOEXEC.BAT and CONFIG.SYS files. A few additional comments on this installation process:

- ◆ Insure that the installation is done from DOS as specified
- ◆ Either the Express or the Custom Installation can be used.
- ◆ For use with HyperWare, only the SRAM card drivers are required. (ie at the prompt, do not select to install the FFS2 drivers for Microsoft Flash File system as they are not required)
- ◆ Two different types of parallel port are available on PC's today, the EPP (enhanced parallel port) and Standard. All installations will run with the Standard port type selected. If a EPP port is available, selecting this type will provide slightly faster data read/write performance. During the installation, if EPP is selected but is not detected, a message will display and the CardTalk software will not be installed. If this occurs, repeat the installation choosing Standard.
- ◆ Specify the correct printer port to use during installation (the default is LPT1)

Near the end of the installation process, changes will be made to the PC AUTOEXEC.BAT and CONFIG.SYS files. Three lines are added to the CONFIG.SYS file:

```
DEVICEHIGH=C:\CARDTALK\SSPPORT.SYS /lpt:1
DEVICEHIGH=C:\CARDTALK\CTALKCS.EXE
DEVICEHIGH=C:\CARDTALK\CARDTALK.SYS /A /MEMW
/IOW
```

In the AUTOEXEC.BAT file, the CARDTALK directory is added to the PATH.

TIP: These drivers are fairly large and will be loaded into memory at reboot. For Users running DOS 6.0 or later with the Multiple Configuration boot options, it may be desirable to set up an optional load of these drivers. Refer to the DOS Help and/or manual for details on how to set up the Multiple Configuration boot.

TIP: Upon boot of the PC with the standard drivers installed, the PD-1 will be assigned the next consecutive drive letter. For User's requiring specific assignment of a drive letter to the PD-1 drive, the CONFIG.SYS file can be modified to force the PD-1 drive to be assigned to a particular drive letter. Refer to the Technical Support FAQ (frequently asked questions) sheet supplied with the drive for details.

TIP: For user's that do not require control of the specific drive letter assigned to the PD-1 and want to minimize the size of the loaded PD-1 interface drivers, an older version of the CardTalk drivers (V2.16 for the TMD-550) is available. This version requires only 24K of memory and will support only the SRAM cards used in the OM-320 system. Additionally, this version of drivers does not allow for a User assigned drive letter... it will automatically use the next drive letter in the system. If used, these drivers install into a directory called DATABOOK instead of the directory called CARDTALK referred to within this chapter.

NOTE:

The OM-320 and HyperWare PCMCIA card system has been designed to be implemented using the external PD-1 PCMCIA drive. Users with PC's equipped with integral PCMCIA drives may be able to utilize drivers supplied with their PC's for read/write from DOS formatted SRAM PCMCIA cards. However due to the variability in PCMCIA card spec compliance and system configurations, considerable cautious experimentation may be required to implement the system.

Quick Test of the PCMCIA Drive Configuration

After installation of the drivers, reboot the PC and the drivers will be loaded into memory. The drive letter that the PCMCIA drive is installed as will be displayed briefly in the on-screen messages displayed during the system boot. Note this letter for future use.

If the system does not correctly identify the drive, error messages will display. Refer to the PCMCIA drive User's Guide for instructions on troubleshooting drive configuration problems.

After a successful configuration, the drive installation can be simply tested as follows:

CAUTION

Before inserting a PCMCIA card into the drive, touch the case of the PC or some other ground to discharge any static body charge. This step minimizes the chance of damaging the card by discharging your body static charge through the PCMCIA card connector.

1. Insert a formatted and prepared (as supplied by Omega Engineering Incorporated) PCMCIA card into the drive. Be sure that a card is inserted fully into the drive before testing.
2. Use the conventional DOS command DIR X: where X represents the drive letter assigned to the PCMCIA drive to read the files on the card. Three files should be listed on the card:
FORMAT.MEM
NET.MEM
DATA.MEM

HyperWare Software Configuration

After the PD-1 drive has been connected, the drivers installed, an installed drive letter determined, and access to the drive has been tested through DOS, HyperWare must be configured.

Launch the HyperWare program under Windows and select the *Options/Paths* menu from the HyperComm Window Menu Bar.

1. In the PCMCIA Format Command Text Box specify the drive and path where the CardTalk drivers are located followed by the command TCFORMAT. In most installations, this will be `C:\CARDTALK\TCFORMAT.EXE`.

The command TCFORMAT is a special command supplied with the CardTalk drivers that is used for formatting PCMCIA cards in the PD-1 drive. The resulting card format is DOS compatible.

2. In the PCMCIA drive Text Box, specify the drive letter that is used to access the PCMCIA drive. This letter was determined and tested in previous steps.
3. Select OK to save the changes and close the dialog.
4. Double-click on the PC drive graphic and HyperWare will scan the PCMCIA card installed in the drive checking for proper format and the presence of the three support files.

PCMCIA Card Usage with HyperWare

The PCMCIA card, in a transportable memory application is typically used to transfer collected data from a remotely located OM-320 to the PC and/or to transfer a new Program Net from the PC to a remotely located OM-320.

Transferring Data from the OM-320 to the PC

After data has been stored on a PCMCIA card in the OM-320, the card can be transported back to the PC location where the collected data is transferred from the card to a Download File on the PC. The following steps detail this procedure:

1. Press STOP on the OM-320 front panel and cycle the OM-320 power OFF. Remove the PCMCIA card with the Eject button.
2. At this time, a new formatted and prepared card can be inserted into the PCMCIA card socket and the OM-320 can be powered up and the ENABLE button pressed. Observe the LCD for any error messages before leaving the site.
NOTE: review the tips and cautionary measures to be used in handling and insertion of the PCMCIA card in the section above titled *PCMCIA Card - Expanded Memory Application*
3. Transport the PCMCIA card to the PC location and insert the card into the PCMCIA drive.
4. Double-click on the PCMCIA drive graphic within the HyperComm Window and the PCMCIA card will automatically be scanned. After a short delay, a Program Net and Data icon will be displayed overlaying the PCMCIA drive graphic.
5. Drag the Data icon from the PCMCIA drive to the PC and the data transfer will commence. Refer to Chapter 6 for details on entering comments, etc during the data transfer process.
6. The PCMCIA card can be cleared by double-clicking on the CLEAR button located by the PD-1 graphic.

Transferring a Program Net from the PC to the OM-320

A OM-320 at a remote location can be reprogrammed by writing a Program Net on a PCMCIA card at the PC location, then plugging the PCMCIA card into the OM-320. The following steps will implement the programming:

1. Develop the new Program Net at the PC location (see Chapter 7 on HyperNet Programming for details).
NOTE: it is imperative that the developed Program Net is compatible with the remotely located OM-320. Great inconvenience can result if an incompatible Program Net is developed, transported to the OM-320, and attempted to be run. Methods to insure this are discussed in Chapter 7.

6... PCMCIA CARD CONFIGURATION AND USE

2. Insert a PCMCIA card into the PD-1 drive
3. Drag the Program Net icon from the PC to the PD-1 graphic. A dialog will display stating that any data currently on the PCMCIA card will be erased. Select OK and the program is transferred.
4. Transport the card to the OM-320 location. Stop the OM-320 and cycle the power OFF. Insert the PCMCIA card.
5. Turn the power ON and press ENABLE. Upon Enabling, if a Program Net is detected on the card, the OM-320 will automatically be reprogrammed with this Program Net and start logging data to the card.
6. Proper execution can be confirmed via the LCD Status display(s).

PCMCIA - MISCELLANEOUS

Formatting PCMCIA cards

Before a PCMCIA card can be used in the OM-320 system, it must be properly formatted and prepared. As supplied from Omega Engineering Incorporated, PCMCIA cards are already formatted and prepared however, this procedure is fully supported under HyperWare.

To format and prepare a new card, insert it into the PC-1 drive and double-click on the PD-1 graphic. HyperWare will detect that the card has not been formatted nor prepared and a dialog will respond accordingly. Selecting YES at the request will automatically format the card using the TCFORMAT.EXE utility from the CardTalk directory, then the 3 required files (FORMAT.MEM, DATA.MEM, and NET.MEM) will be copied onto the PCMCIA card.

Windows 95 - Special PCMCIA Card Considerations

In systems running Windows 95, HyperWare cannot format the card by calling the TCFORMAT command. To format the card, exit Windows 95 and manually run the TCFORMAT command with the following syntax:

TCFORMAT X: where X is the PD-1 drive letter

After the card has been tformatted, the copying of the three support files can be completed from within HyperWare. Launch HyperWare and double-click on the drive, then follow the ensuing dialogs.

MEMORY CARD HANDLING / MAINTENANCE

The MC series memory cards are packaged in a protective metal case, however reasonable care should be exercised in the handling and use of the cards. The card should not be exposed to water, extremely high or low temperatures (eg on the dash of a car on a sunny day), or dirt/mud... especially on the connector end.

The MC-XX memory cards utilize an internal lithium cell (Panasonic BR-2325, 3V or equivalent) for power when not installed in the OM-320 or the PD-1 drive at the PC location. This lithium cell should be replaced yearly for maximum data integrity. Data in memory will be maintained for up to 2 hours with the battery removed from

the compartment, *however it is highly recommended that any valuable data in the card be downloaded before replacing the battery.*

To replace the cell:

1. Locate a clean area to work.
2. Visually locate the battery access door and lock located on the end of the memory card opposite the connector end.
1. Using a paper clip or other small probe, slide the Lock pin away from the embossed LOCK mark.

Figure 6... -1: Memory Card lithium cell access and Write Protect Switch

2. Swing open and remove the battery compartment door . The lithium cell can then be removed.
3. Slide the new cell into the compartment *insuring the positive (+) side of the cell is toward the top of the card.*
4. Carefully insert the battery door and swing it closed.
5. Slide the Lock pin to the LOCK position.

6... PCMCIA CARD CONFIGURATION AND USE

NOTES:

7... HYPERNET™ ICON BASED PROGRAMMING

OVERVIEW

The OM-320 operates in the field based on a program loaded into its memory called a Program Net (Figure 7... -1). The Program Net provides instructions for the OM-320 including which channels to sample, when to sample, how to process the incoming signals, when to output alarms, and much more.

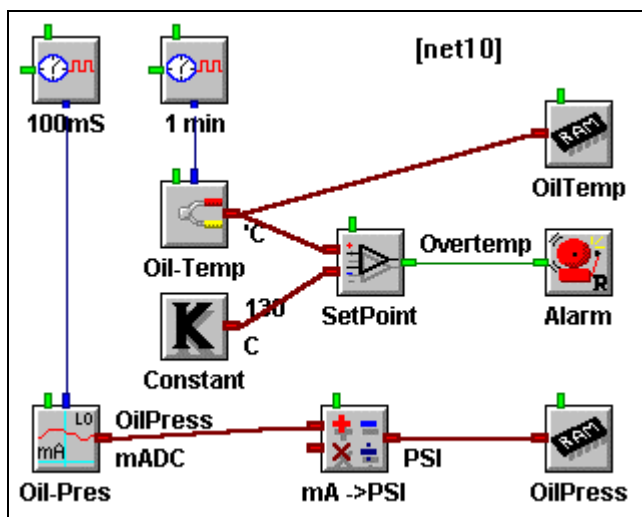

Figure 7... -1: Example Program Net

Development of a Program Net is done on a PC running HyperWare. After development, the Program Net is uploaded directly to the OM-320 memory via a serial communication link or indirectly via upload to a PCMCIA card. The PCMCIA card can then be plugged into the OM-320. Actual development of the Program Net is performed in the *HYPERNET WINDOW* and the serial transfer of the Program Net from the PC to the OM-320 (or to the PCMCIA card) is performed from within the *HYPERCOMM WINDOW*.

Program Nets are developed through the following sequence of steps:

- ◆ Create a new Program Net file for the connected OM-320 (which automatically determines the installed hardware in the connected OM-320)
- ◆ Add desired functions to the Program Net by dragging various icons onto the HyperNet workspace
- ◆ Add connections between icon terminals indicating signal flow
- ◆ Configure the various icon options (eg Celcius or Fahrenheit, type of thermocouple, filtering, equations, etc)
- ◆ Configure the Global icon
- ◆ Save the Program Net and/or transfer it to a connected OM-320 for execution.

This chapter describes the HyperNet development environment and provides detailed instruction on constructing Program Nets. Detailed icon configuration information is provided in the Master Icon Reference in Appendix A. For the

7... HYPERNET™ ICON BASED PROGRAMMING

technically curious, additional information on the theory of operation of Program Nets is available in Appendix G.

AN EXAMPLE PROGRAM NET

A simple Program Net is shown in Figure 7... -2. In this Program Net, two thermocouple inputs (represented by the two matching icons near the left of the workspace) are sampled periodically (based on the Sample Rate Clock connected to the top of each of the Thermocouple icons) and their values are stored in OM-320 memory (RAM chip icons). Additionally, the difference between the two thermocouple channels is calculated (by the Math icon) and stored in memory.

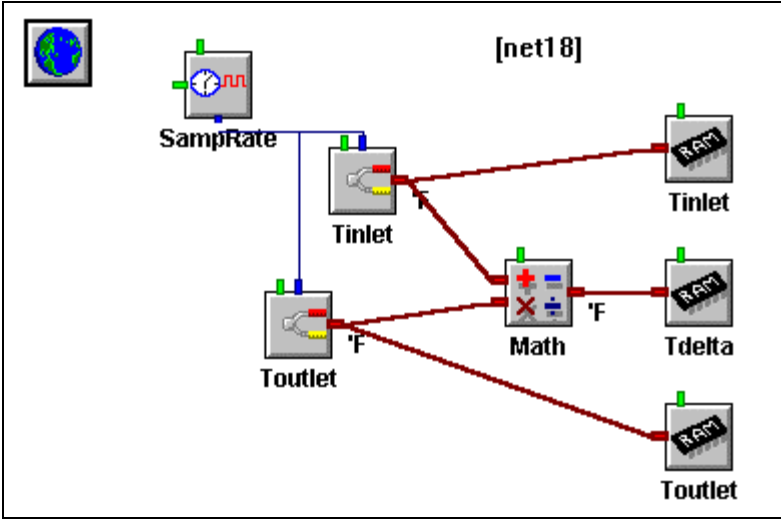

Figure 7... -2: Temperature sampling Program Net

HYPERNET DEVELOPMENT WINDOW FEATURES AND TOOLS

Accessing the HyperNet Window

To enter the *HYPERNET WINDOW* from within the *HYPERCOMM WINDOW*, click on the *HYPERNET* button on the toolbar. The HyperNet Window will open

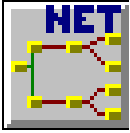

Figure 7...
-3:
HyperNet
window
button

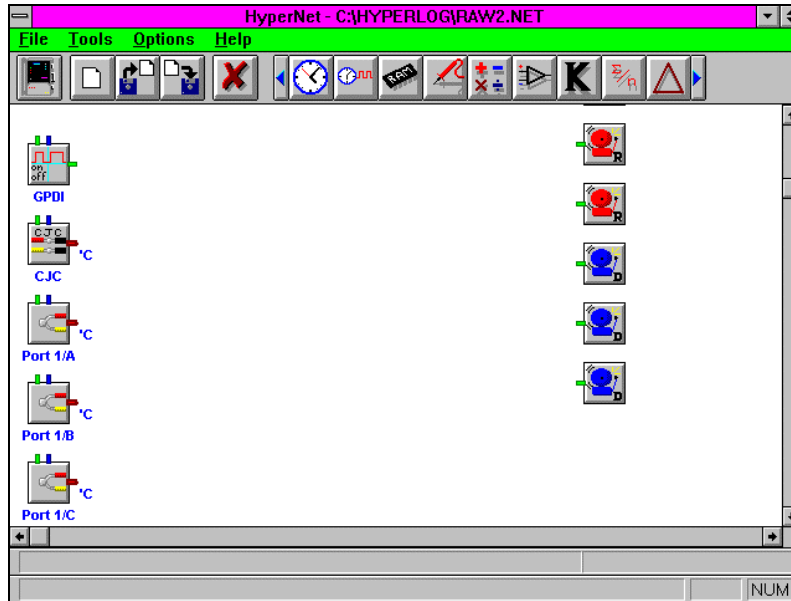

Figure 7... -4: HyperNet, Program Net development window

(Figure 7... -4) displaying the default Net or the last edited Net.

Returning to the HyperComm Window

From within the HyperNet Window, to return to the HyperComm Window, click on the HyperComm button (small OM-320 graphic) at the left end of toolbar.

HyperNet Window Topology

When the HyperNet Window opens, a default Net or the last edited Net will be displayed on the workspace (Figure 7... -4). Use the slide bars at the right edge and bottom of the workspace to shift the display.

At the top of the window is a Menu Bar and below that, an Button / Icon Tool Bar. Passing the cursor over the various icons results in a short descriptor display on the Status Bar at the lower left corner of the window.

Descriptions of the main button / icon groups follow:

HyperComm Access

A single click returns the screen to the HyperComm Window. If the Program Net currently displayed in the workspace has been changed, a dialog will open prompting the User with an option to save the edited Program Net.

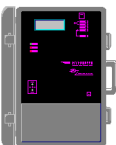

Figure 7... -5:
Return to
HyperComm
button

Create New Net

Clicking on New Net will automatically query the OM-320, then update the workspace display showing icons for the connected OM-320's hardware configuration including any User installed modules and options. This requires a serial connection between the OM-320 and the PC. To have a serial connection, the OM-320 and the PC must be linked via RS-232 or Modem *and* the connection must be established from within the HyperComm Window (Chapter 5).

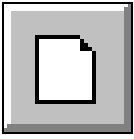

Figure 7...
-6: New Net button

Open Net and Save Net

Clicking on the Open Net button (or selecting *File/Open Net* from the menu bar) results in the opening of the standard File Open dialog box with the default file sort set to *.NET. Previously saved Program Nets can be retrieved.

The Save Net button will save the currently displayed Program Net to disk under the current Program Net filename with the extension *.NET. If a filename has not been assigned, the standard File Save As dialog box will open, allowing for User input of a Program Net filename.

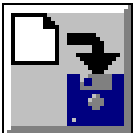
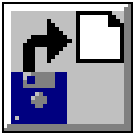

Figure 7...
-7: Open and Save Nets

TIP: Use the drop down menu selection 'File / Save Net As' to save Nets with a different filename.

Delete Icon or Connection (Link)

To delete a connection (link) between icons, click on the Delete icon (the Status Bar will display *Select Object to Delete* and the cursor will change shape) then on one of the ends of the connection to be deleted. (To select the end, the cursor must be over the icon terminal). To delete another connection, repeat the procedure. If multiple connections originate at an icon terminal, they will all be deleted.

To delete an icon, click on the Delete button and then on the icon to be deleted. If an icon is deleted, all connections into and out of the icon will also be deleted.

If the Delete function has been selected and no items are to be deleted, clicking on any open space in the workspace will disable the Delete function.

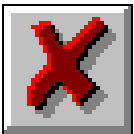

Figure 7...
-8: Delete Button

Program Net Icon Selection Bar

Included in the Program Net Icon Bar is a collection of various icons to be used in the development of Program Nets. Clicking on the arrows at the left and right edge of the bar will scroll the bar left or right displaying additional icons.



Figure 7... -9: Icon assortment (with scroll arrows at each end)

PROGRAM NET CONSTRUCTION

Program Nets are developed in HyperNet and saved as files with the filename extension *.NET.

Program Nets must be developed to match the existing hardware installed in the target OM-320. For example a Program Net that uses a modem function will only work in a OM-320 that has a modem installed.

Configuration details that must match include:

- ◆ Interface Modules - Program Nets must match the OM-320 installed Interface Module types.
- ◆ Port - The Port used in the Program Net and the Port used for an Interface Module in the OM-320 must match.
- ◆ Channel Configurations - Interface Modules equipped with hardware configuration switches must have their switches set to match the Program Net on a channel by channel basis.

For Example: If an HLIM-1 is installed in Port 3 and has the Channel B configured (via the Channel B hardware configuration switch) for VDC-HI, then any Program Net loaded into the OM-320 must have Channel 3B used as a VDC-HI channel (or optionally, not used).

If a Program Net that does not match the target OM-320 hardware configuration is uploaded to the OM-320 memory, a configuration mismatch error will display and the upload will not occur. This checking of compatibility is handled automatically within HyperWare during the upload process and insures that hardware and software compatibility exists.

TIP: *Users that have a number of OM-320s in use may find it convenient to create a subdirectory in their HyperWare directory for each of the OM-320s with which they work. The subdirectory names may correlate to the OM-320 ID or Unit Name which are User programmed (See HyperNet Programming in Chapter 7). As Program Nets are developed for each OM-320 or configuration, they can then be saved into the corresponding subdirectory.*

To Develop a New Program Net...

To develop a new Program Net, the target OM-320 hardware configuration must be known. After configuring the OM-320 hardware as required for the data logging application (ie installing modules, setting channel configuration switches, etc), establish a serial connection to the OM-320 from the HyperComm Window.

7... HYPERNET™ ICON BASED PROGRAMMING

Switch to the HyperNet Window and click on the CreateNew Net button *and the connected OM-320 will be automatically polled for its hardware configuration.* The workspace will update and show icons representing the standard System Base hardware and any User installed hardware.

Before editing of the workspace begins, this unconnected Program Net should be saved to disk by clicking on the File Save button or using the `File / Save Net As' selection from the menu. This unconnected Program Net can then be used as a starting Net for development of varying Program Nets based on the same OM-320 configuration.

As Program Nets are developed, they should be saved with a filename different from this basic Program Net. Use the `File / Save Net As' drop-down menu to save Nets with different filenames.

To Open an Existing Net for Editing...

If a previously developed Program Net is to be edited, open the Program Net file by clicking on the Open File button and selecting the desired file.

Icon Placement

To add an icon from the Tool Bar to the workspace, click on the desired icon and while holding the mouse button down, drag the icon onto the workspace. Release the button when the icon is positioned in the approximate desired location. Icons can be relocated within the workspace by the same technique... even after connections have been made.

The Icon Toolbar contains more icons than are visually displayed at the top of the window. To see additional icons, click on the left and right arrows at the ends of the toolbar to spin to additional icons.

The HyperNet workspace utilizes dynamic panning. As an icon (or connection) is dragged near the edge of the screen, the workspace will pan.

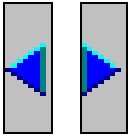

Using Grids

If desired, a grid structure can be enabled on the workspace that provides a visual grid and/or `snap to grid' function. Select `Options / Grid' and select the desired operation.

The Snap function is merely an aid to align icons neatly within the workspace.

Changing Fonts

Labeling text surrounds icons as they are placed. The font, size, color and effects used for this text can be changed through the drop-down menu `Options / Font' and its corresponding dialog.

Icons

Icons are the main building blocks used in the development of a Program Net. Icons within a Program Net graphically represent different items ranging from hardware input channels to intermediate processing functions to hardware outputs and more. A partial listing of available HyperNet icons is in Table 7... -1.

NOTE: A complete icon listing with detailed setup and application information is supplied for reference in Appendix A.

Input Icons	Output Icons	Processing Icons	Special Icons
VDC-LO	Relay Output	Math	Sample Rate Clock
CJC	Pager Alarm	Delta Function	Global Settings
Thermocouple	LCD Message	Average Function	Warm-Up Timer
Event	Digital Output	Count Accumulator	Probe Point
Frequency		Comparator	
Count	Memory	Logical AND	
Start/Stop Clock		Integral Function	

Table 7... -1: Partial listing of icon functions available for Program Net construction

Icon Topology

Icons share many similar features including their graphic appearance (input and output terminals, etc) and configuration techniques. Figure 7... -10 shows the topology of an icon with its

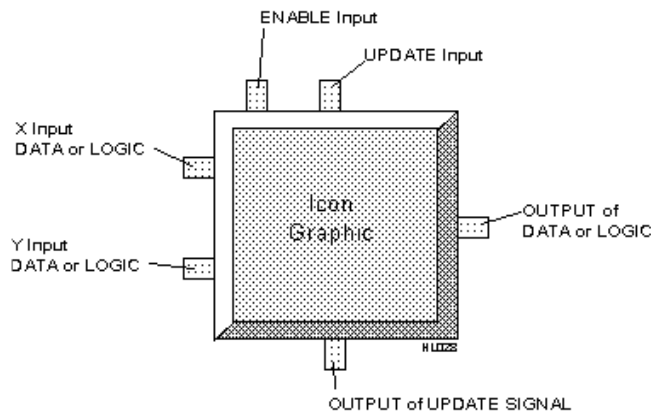

Figure 7... -10: Icon topology and terminal types various terminals.

TERMINALS

All icons (except the Global Icon) have terminals for the addition of signal connections. An explanation for the various types of terminals follows:

LOGIC / DATA INPUT TERMINALS

On the left side of the icon are typically one or two inputs for Logic or Data signal types. Data enters the icon for processing through these Input terminals. Some two input icons (eg Math) do not require signals to be connected to both Input terminals for operation.

LOGIC / DATA OUTPUT TERMINAL

On the right side of the icon is a single Output terminal. After processing of an input signal(s) is completed, the output is updated. Depending on the type of icon and the User configuration, this Output terminal may or may not be updated every time the Update and/or an Input terminal is updated. The Enable input (description follows), the type of processing that the icon performs, and User specified parameters within the Configuration dialog all effect when the Output terminal is updated.

For example, when using an Average icon, the Output terminal will only be updated with a new value after a User specified number of inputs have been averaged.

ENABLE INPUT TERMINAL

Many icons have an Enable input terminal located near their top left corner that will accept a Logic input (True/False). Depending on the state of the input signal, the icon is enabled or disabled for processing.

NOTE: if the Enable input is not connected, it defaults to the Enabled state.

A simple application of the Enable input might be in an engine temperature recording application. A Thermocouple icon may be enabled / disabled by a Logic signal that is True when the engine ignition is ON. With this configuration, temperature recording will only occur when the engine is running.

The Enable input can also be used for optimizing the speed of Program Nets and/or minimizing the amount of data collected as the processing normally done by an icon in a Program Net is not performed if the Enable input is False. For example, a Program Net may be built that has several input temperatures that are scanned on a fairly high speed basis. By use of the Enable terminal, the data flow to OM-320 memory may be disabled during normal operating conditions and enabled when abnormal temperature readings are detected.

UPDATE INPUT TERMINAL

The Input signal icons (Thermocouple, VDC, GPDI, etc) are all equipped with an Update input terminal located in the center top of the graphic. Whenever this Update terminal receives an Update command, it proceeds to update its output terminal value (assuming that its Enable terminal is True or not connected).

UPDATE OUTPUT TERMINAL

The Sample Rate Clock and the Warm-up icon have a special output terminal located at the bottom center of the graphic called an Update output terminal. This terminal sends a command to the connected icon to Update its output (eg take a sample, process an equation, etc).

Details on the Sample Rate Clock and the Warmup icon are covered in the Master Icon Reference in Appendix A .

Configuring Icons

Most of the icons within HyperWare must be configured before they can be used. User configuration entails selection of various icon operational parameters such as names, input ranges, sampling rates, etc and is simply done through dialog boxes associated with each icon.

To configure an icon that has been placed on the workspace, double-click on the graphic and an Icon Configuration dialog box will appear. Each icon has a unique dialog box with programmable parameters to meets its needs. However, many parameters are common to the different types of icons. A Thermocouple Input icon Configuration Dialog is shown in Figure 7... -11 and a description of configuration parameters typically seen in a configuration dialog box follow.

Various standard Windows techniques are used to select the different parameters within the dialog box from text entry and editing to selection via radio buttons.

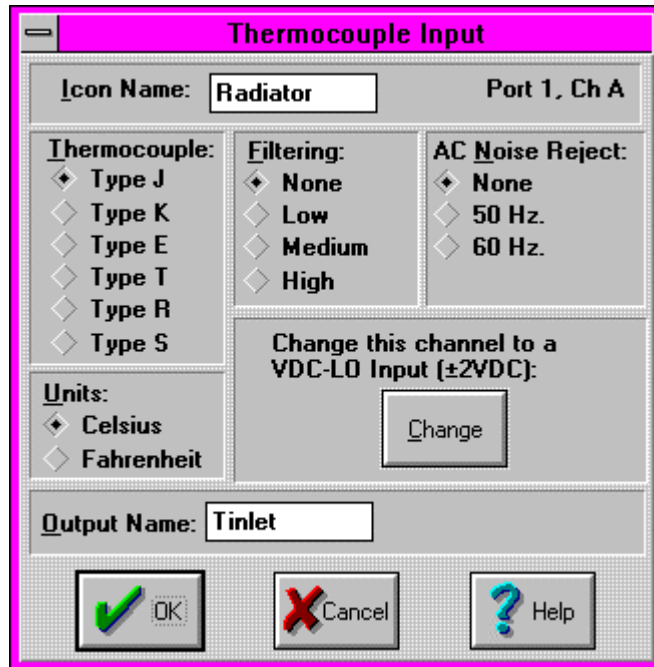

Figure 7... -11: Thermocouple input icon configuration dialog box

ICON NAME

Each icon can have an 8 character name assigned that displays on the workspace under the icon.

OUTPUT NAME

The output signal can be assigned an 8 character name which displays above the Output Terminal of the icon. This name is

commonly referenced by icons connected to this Output terminal. For example, if this Thermocouple icon were connected to one of a Math icon's input terminals, the name Tinlet would be referenced within the Math icon as an Input terminal name.

UNITS

Many of the icons can output their signals with various units such as Degrees C or F, V or mV, Degrees or Ohms, etc. Radio buttons are typically used to select one of the Unit types.

SIGNAL TYPE OR RANGE

This Thermocouple icon supports 6 different types of thermocouple. Similarly, other icons have User configurable ranges or types.

OTHER PARAMETERS

Most of the icons have additional parameters such as filtering, equations, data types, etc that are all User programmable.

Icon Assortment

A complete reference listing of all of the icons available within HyperWare is included in the Master Icon Listing in Appendix A. Details on Configuration, applications, and proper usage are described.

Global Icon

One special icon that is included in every Program Net is called the Global icon. Within the Global icon's Configuration dialog are options for various global Program Net options. These options include Program Net Name, memory utilization mode, clock resolution, and modem parameters. The operation of this icon should be reviewed in the Master Icon Reference in Appendix A before attempting to construct a Program Net.

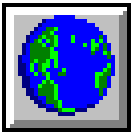

Figure 7... -
12: Global
icon

Making Connections Between Icons

Lines are used within a Program Net to indicate the flow of signals between icons. (See Figure 7... -1)

Signal Types

Three types of signals can be communicated between icons in a Program Net. The three signal types are differentiated by color and their different functions follow:

DATA (RED)

Numerical values are transmitted from icon to icon via Data type signal connections. HyperNet allows Data connections to be made **ONLY** between Data terminals on icons to preclude mismatching of signal types.

SIGNALS COMMUNICATED VIA DATA TYPE CONNECTIONS	EXAMPLE ICONS WITH DATA TYPE TERMINALS
TEMPERATURE	OUTPUTS FROM THERMOCOUPLE ICONS
VOLTAGE	OUTPUTS FROM VOLTAGE ICONS
PRESSURE	MATH (INPUTS AND OUTPUTS)
FLOW	INPUTS TO COMPARATORS
	OUTPUTS FROM COUNTERS

Table 7... -2: Example Data type signals and Icons

LOGIC (GREEN)

True / False values are transmitted from icon to icon via Logic type signal connections. Logic signals have only two states. As with the other signal types, HyperNet only allows Logic signals to be connected to Logic type terminals on icons.

SIGNALS COMMUNICATED VIA LOGIC TYPE CONNECTIONS	EXAMPLE ICONS WITH LOGIC TYPE TERMINALS
TRUE OR FALSE CONDITIONS	INPUTS TO RELAY ALARM ICONS
	OUTPUTS FROM COMPARATORS
	ENABLE INPUTS TO SAMPLE RATE CLOCKS
	INPUT TO MESSAGE ICON
	OUTPUT FROM START/STOP CLOCK
	INPUTS TO COUNTERS

Table 7... -3: Example Logic type signals and icons

UPDATE (BLUE)

Update commands are a special type of signal that is generated ONLY by Sample Rate Clock icons. This signal is connected to the Update input on icons and commands them to update their outputs. As with the other signal types, HyperNet only allows Update signals to be connected to Update type terminals on icons.

SIGNALS COMMUNICATED VIA UPDATE TYPE CONNECTIONS	EXAMPLE ICONS WITH UPDATE TYPE TERMINALS
THE UPDATE COMMAND GENERATED BY THE SAMPLE RATE CLOCK ICON	INPUT ICONS HAVE AN UPDATE TERMINAL

Table 7... -4: Example Update signals and icons

Adding Signal Connections Between Icons

Connections between two icons are drawn by locating the mouse cursor over the first icon's terminal (note how the cursor changes when properly located over a terminal), clicking and holding the button down, then dragging a connection line to the second icon's terminal and releasing the button.

The direction that signal connections can be dragged on the workspace is limited to minimize potential problems with feedback and/or race conditions. Connections can only be drawn from the left to the right on the workspace.

During the connection process, HyperNet checks and disallows recognized illegal connections such as:

- ◆ Differing terminal types cannot be interconnected. For example, a Data terminal cannot be connected to a Logic terminal.
- ◆ Output terminals can only connect to Input or Enable terminals.
- ◆ Connections cannot be made between terminals on the same icon
- ◆ Multiple connections to a single Input terminal.

During the construction of Program Nets, it is common for multiple connection lines to originate at an Output terminal, however most icons can only have one or two inputs. Some icons such as the Scroll Tracking and Destination File icons (used in the Post-Processing and HyperTrack Windows) allow for more than two inputs and will automatically add input terminals as connection lines are added.

Saving the Net

After development of the Program Net, the program can be saved to a file by clicking on the Save to Disk icon in the Toolbar.

NET PERFORMANCE

After construction of a Program Net a quick review should be done to insure that the Net's performance in the OM-320 will meet the User's goal. This check should include proper implementation and for higher speed applications, a processing (execution) speed review.

Program Net Checklist

- ◆ Has the Global Icon been configured? Has a Program Name and Description been assigned?
- ◆ Have connections been added between icons?
- ◆ Have desired measurement units (eg C, F, ohms, etc) been selected?
- ◆ Does each icon have a name and output name? Names are not necessary for the icons to function, however, if they are used consistently during the construction of a Program Net, the presence of a User defined name (vs the default name) becomes an indicator that the icon has been configured. Additionally, the added annotation makes comprehension of the net by other Users and/or at a later date even easier.
- ◆ Do the Memory icons have names assigned? If omitted, it may be more difficult to identify data during plotting and further post-processing.

Program Net Execution Speed

NOTE: The information presented in this section is provided for Users that are attempting to collect data at faster rates (such as Samples per Second).

Users utilizing the OM-320 for data collection at slower rates (eg Samples per Minute) may opt to skip this section and refer to it later when faster rates are required.

Due to the nearly unlimited flexibility and potential variations of Program Net designs, it is difficult to specify the actual speed performance of Program Nets. In an attempt to relate to the OM-320 User a feel for the Program Net processing speeds to be expected, the following guidelines are presented. Additionally, a number of example Program Nets are provided in Appendix B with their approximate execution speeds. From this information, a feel for the speed of execution of most Program Nets can be developed.

Program Net Performance Guidelines

The time required for a Program Net to execute within the OM-320 is a function of a number of variables including:

- ◆ **Total number of icons in the Program Net** - with a greater number of icons to process each time the Program Net loops, more time is required.
- ◆ **Type of icons** - different types of icons require various amounts of time to process. For example, a Thermocouple input icon requires a considerable amount of processing time to perform the analog to digital conversions, CJC measurements, and the associated math. On the other end of the speed spectrum, a Data Memory icon merely stores data into a memory location... an operation which can be performed very quickly.

- ◆ **Program Net design** - Program Nets can be developed that have varying execution times that are a function of inputs or values within the Net. A simple example of this is a Program Net that scans a single digital input (eg switch state) and only enables the logging of 10 thermocouple input channels when the switch is closed. In this example, the digital input could be scanned very fast when open, but when it closes, extra processing time is required for the 10 thermocouple channels.

An Empirical Answer...

After optimization of a Program Net with consideration of the above guidelines, the best way to determine the speed performance of a Net is to upload it to a OM-320 and run it. If maximum speed is the goal, the driving Sample Rate Clock rate can be set to a minimum (eg 1mS) and the program can be tested. Review of the data and actual sample times will result in a very accurate execution rate value.

Following are three benchmark Program Net execution times that can be used to gain a relative feel for the sampling rates achievable with the OM-320. The times were empirically determined with a single channel (as specified) storing directly to memory. In each case, the Program Net consists of one Sample Rate Clock icon, one input channel icon, and one memory icon. No filtering was enabled.

Input Icon Type	Samples per Second (one channel)
VDC-LO	150
Thermocouple Type J	30
Counter (GPDI)	320

Figure 7... -13: Approximate throughput rates for various types of signals / Program Nets

Nets that utilize conditional logging strategies will have varying execution rates. A feel for these Net execution rates can be developed by constructing and running Program Nets that represent each conditonal branch of the Net, then summing the execution times for branches that can could execute simultaneously.

Miscellaneous Program Net Performance Considerations

MISSED SAMPLES

Although it is possible to set Sample Rate Clock rates faster than a Program Net can actually execute, the Program Nets will attempt to run. In these conditions, if a Sample Rate Clock sends the Update command before the Net has been fully executed, the OM-320 will finish the Net execution then immediately start processing the Net again.

The fact that an Update command has been processed late is accessible to the User via the Warning icon. One of the options within the Warning icon is to provide a logic output if a *Sample is Missed*. Details on the Warning icon are provided in the Master Icon Reference in Appendix A.

It must be noted that in this situation, although the actual data has not been sampled at the programmed rate, *all collected data will include the actual date/time that the Net executed.*

TIP: *To achieve maximum speed of a Program Net, the Sample Rate Clock(s) used in the Net can be set to a rate faster than the Net can possibly process.*

OTHER DETRIMENTS TO SPEED

Any additional processing that is performed during execution of a Program Net such as serial communication (eg HyperTrack operation, Status Queries, etc) and/or display of readings through the OM-320 front panel LCD will have detrimental effects on the rate at which a Program Net can execute. For optimum speed, the LCD should not be displaying updating information (eg Probe Points, battery voltage, etc).

PROGRAM NET DOCUMENTATION

Two features are provided within the HyperNet Window to assist in documenting and the ensuing field wiring of the OM-320.

HyperNet Printout

The actual Program Net display can be printed by selecting *Print Net* from the *File* menu.

NOTE: *The PC must be set to 256 color mode in order to properly print the Net.*

TSA Wiring Printout

A Terminal Strip Adapter (TSA) I/O Listing can be generated and printed for the Program Net. This listing can then be used during the field wiring of the various I/O signals to the TSA.

Upon completion of the Program Net, select *Save TSA I/O List* from the *File* menu, enter a filename, and the file will be generated and saved as an ASCII text file. A text editor will automatically open the file. The listing can then be printed from within the editor and carried with the OM-320 to the installation site.

The TSA Listing includes the connections for each of the I/O channels that is used in the Program Net as well as standard connections for External Power, the Digital Port and the CJC connector. Names assigned to Input and Output icons in the Program Net are used for channel identification.

At the bottom of the TSA I/O Listing are various notes relative to other connections such as modem. These notes are imported from a file called NOTES.TXT which is supplied in HyperWare. Reminders and special installation comments can be added by the User to the NOTES.TXT file by editing the file with any text editor (such as Notepad). After editing, the

7... HYPERNET™ ICON BASED PROGRAMMING

revisions will appear on the TSA Listing each time a listing is generated from within HyperNet.

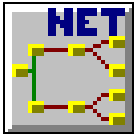

PROGRAM NET UPLOAD TO THE OM-320

After the Program Net has been checked and saved, clicking on the HyperComm Window button will return HyperWare to the HyperComm Window. The Program Net icon displayed on the PC graphic represents the last edited Program Net. Drag and drop the Program Net icon from the PC to the serially connected OM-320 or to the PCMCIA card drive to upload the new Program Net.

Refer to Chapter 5, HyperComm Serial Communications for details of the Program Net serial link uploading procedure or to Chapter 6 for details on using the PCMCIA card.

NOTES:

8... POST-PROCESSING OF COLLECTED DATA

OVERVIEW

Once data has been collected by the OM-320 and downloaded to a OM-320 Download file on the PC, a number of powerful data analysis and viewing options are available from within HyperWare. (See HyperComm, Chapter 5 for details on downloading data from the OM-320).

The Post-Processing window within HyperWare provides the capability to 'post-process' (ie process after collection) data in the following ways:

- ◆ Graphically plot collected data using HyperPlot
- ◆ Merge data from separate logging sessions into a single file for *Before* and *After* type performance comparisons
- ◆ Save HyperPlot graphs to bitmap (*.BMP) files allowing seamless inclusion into other Windows applications such as wordprocessors and spreadsheets
- ◆ Convert collected data into an Excel Version 4 (*.XLS) file
- ◆ Convert collected data into a date/time annotated ASCII (*.TXT) file
- ◆ Algebraically manipulate collected data and save to a new OM-320 Download, Excel, or text file.

HyperPlot is a powerful graphing module included in HyperWare that can be used for immediate plotting of collected data.

File conversions and algebraic manipulation of collected data are handled by constructing a Post-Processing Net which converts downloaded data from a OM-320 Download file to another User defined file/format.

POST-PROCESSING NETS

Post-Processing Nets provide a means to convert OM-320 Download files to various formats and, if desired, perform additional algebraic processing of collected data as it is converted to the new file format.

8... POST-PROCESSING OF COLLECTED DATA

A Post-Processing Net is constructed much the same way as a Program Net is developed within HyperNet. The main difference is that a Program Net running in a

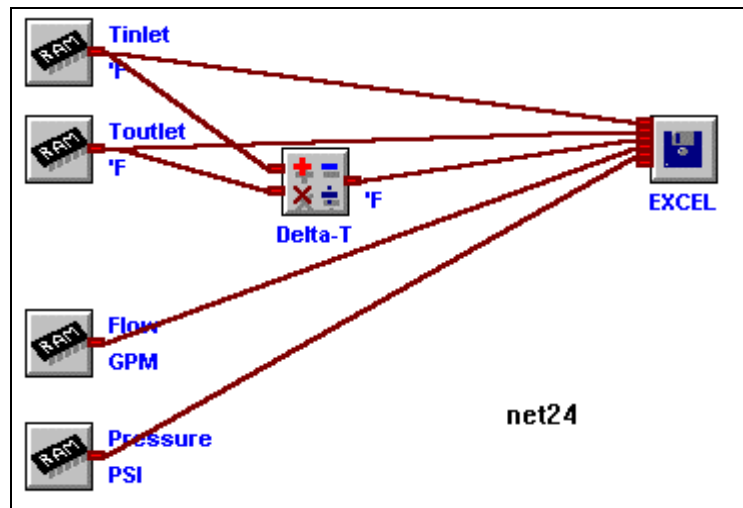

Figure 8... -1: Example Post-Processing Net

OM-320 receives its data from various hardware channels such as thermocouples, then saves the collected data to OM-320 memory. In contrast, Post-Processing Net receives its data from a OM-320 Download file, processes the data, then saves the data in a destination file format. Figure 8... -1 shows a completed Post-Processing Net.

To perform a file conversion and view / analyze the collected data, the following steps are required:

- ◆ Switch to the Post-Processing window
- ◆ Open a OM-320 Download file and construct a Post-Processing Net with icons and connections
- ◆ Specify the destination file format(s)
- ◆ Start the Post-Processing (ie run the Post-Processing Net)
- ◆ Launch the desired data review/analysis application (eg HyperPlot, Excel, Notepad, etc)

Entering the Post-Processing window

From within the HyperComm Window, click on the Post-Processing button and HyperWare will change to the Post-Processing window, Figure 8... -3.

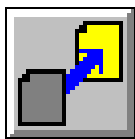

Figure 8...
-2: Post-Processing
button

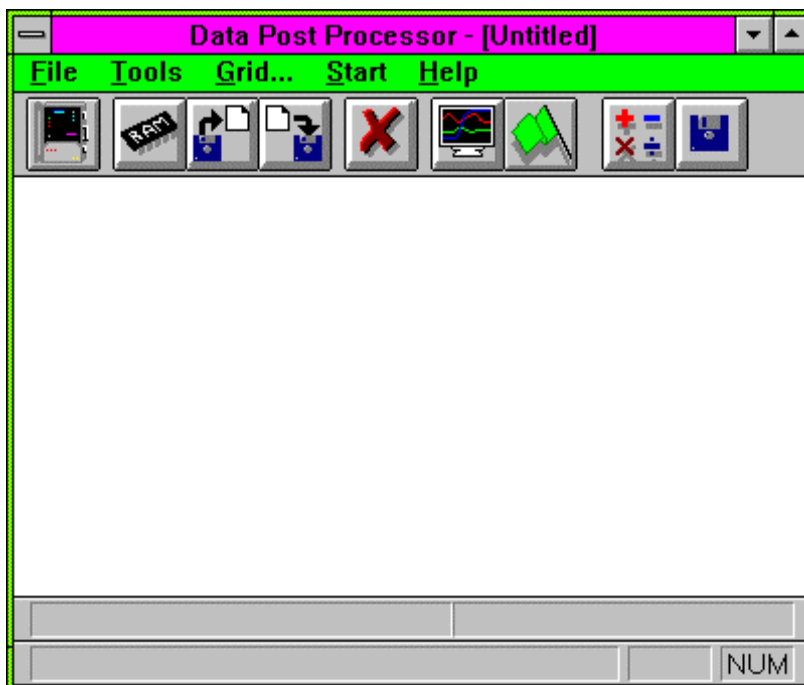

Figure 8... -3: Post-Processing window

Constructing a Post-Processing Net

Post-Processing Net construction utilizes similar icon placement and connection techniques as used during construction of a OM-320 Program Net (Chapter 7) or a HyperTrack Net (Chapter 10).

Opening a OM-320 Download File (*.HLD)

The first step in Post-Processing of a OM-320 Download file is to open the file to be processed. A source OM-320 Download file containing the OM-320 collected data is opened by clicking on the Open OM-320 Download File button on the toolbar. Selecting the desired file will result in a display of Memory icons on the left side of the Post-Processing workspace. Each of the icons represents a channel of logged data contained within the OM-320 Download file.



Figure 8...
-4: Open
Download
File button

Reviewing File Information

After a Download file has been opened, the File Information entered at the time of Download can be reviewed. To see the Title and comments entered, select *File/Data File Information* from the menu. The comments are read-only and cannot be edited from within this window, however comments can be highlighted and copied/pasted to other documents.

Adding Icons

Two icons are available on the Icon Toolbar for use in construction of the Post-Processing Net; a Math icon and a File icon.

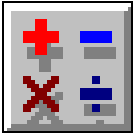

Figure 8...
-5: Math
icon

MATH ICON

The Math icon provides algebraic processing of data as it passes from input to output. In Figure 8... -1, the Math icon is providing a differential temperature calculation and generating a third data channel, *Delta-T*, which is then stored to the destination file.

Double-click on the icon to open its configuration dialog box. See the Master Icon Listing in Appendix A for configuration details.

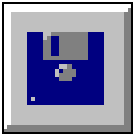

Figure 8... -
6:
Destination
File icon

DESTINATION FILE ICON

The Destination File icon represents storage to file of all signals connected to its inputs. Up to 36 inputs can be connected to the File icon when it is used as an Excel file or 24 when used as an ASCII file. Each time a User adds a connection, an additional input terminal appears.

Double-clicking on the icon opens its Configuration dialog box. With the dialog box, the destination file data format can be specified as ASCII (*.TXT), OM-320 Download (*.HLD), or Version 4.0 Excel spreadsheet (*.XLS) format. See the Master Icon Listing in Appendix A for configuration details.

Multiple File icons can be connected in a net for simultaneous storage of different signals and/or multiple file formats.

Connecting Icons

Icons are connected using the standard drag and drop connection method as used for construction of HyperNet Program Nets. The order of connections made to the Destination File icon determines their sequence in the resulting file.

Unconnected Memory icons will not be processed nor included in the Destination File.

Other Post-Processing Net Development Options

As in the development of a Program Net from within HyperNet, various tools such as Grid, Snap, and Print Net options are available from the Menu Bar.

Saving the Post-Processing Net

Upon completion of the Net, it can be saved for later use with the menu selection *File/Save Net As* or with the Save Net button. The saved Post-Processing Net can then be opened at a later time for conversion of additional OM-320 Download files *that have the same channel configuration and filename*.

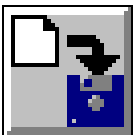

Figure 8...
-7: Save
Net button

An Example: Every day, a OM-320 is downloaded and the data is run through the same Post-Processing Net which converts the data to an Excel spreadsheet. A Post-Processing Net could be constructed once and saved with the filename CONVERT.PST.

Each day, when the data is downloaded from the OM-320, a new filename is given to the OM-320 Download file (eg Monday.hld, Tuesday.hld, Wednesday.hld, ...).

From within the Post-Processing window, the Post-Processing Net CONVERT.PST can then be opened, the Excel destination filename changed, then run. The Post-Processing Net will automatically check for compatibility, then connect to the open OM-320 Download file and process the data into the new Excel destination file..

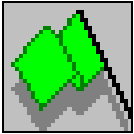

Figure 8...
-8: Start
Processing

STARTING A POST-PROCESSING SESSION

To start the conversion, click on the Green Start button and a Post-Processing status dialog will display as the file conversion proceeds.

VIEWING THE CONVERTED DATA

After the processing of the Net is complete, the converted data file can be viewed immediately by double-clicking on the Destination File icon. The application program (eg Excel, HyperPlot, Notepad, etc) associated with the Destination File type will be launched as specified under the *Options/Paths* menu within the HyperComm window and the converted file will be loaded automatically.

Options / Paths

Selecting the *Options / Paths* menu from the menu-bar in the HyperComm window displays a dialog for User specification of the directory paths and program filenames to use during the viewing of files from within the Post-Processing window. A text window is provided for User entry of the default path and program name for a spreadsheet program (eg Excel for viewing *.XLS destinations files) and for a text editor (eg Notepad for viewing *.txt destination files). Note that the Window Notepad application is for viewing text files smaller than 50K in size. For viewing larger data files, change the text editor to the DOS "EDIT.COM" or another text editor with large file capabilities.

If the Destination File icon has been configured for a OM-320 Download file format (*.HLD), double-clicking on the icon will launch HyperPlot.

If the destination/converted file has been configured for either an Excel or an ASCII text file, it can also be opened without the use of HyperWare from within the respective application's normal Open file commands

A SHORTCUT TO HYPERPLOT...

For immediate graphic review of the first seven channels of data in a OM-320 Download file, HyperPlot can be used without construction of a Post-Processing Net. Switch to the Post-Processing window, and immediately click on the HyperPlot button in the Tool Bar. The OM-320 Download file to be viewed can then be selected via the *FILE/Open View* menu.

Detailed use of HyperPlot is explained in Chapter 9.



Figure 8...
-9:
HyperPlot
button

MERGING OF DOWNLOAD FILES

Through a special function in the Post-Processing Window, two Download files can be merged into a single Destination file. This is a powerful feature that can be used for generating *Before* and *After* type performance plots with HyperPlot.

For example, a pressure and temperature data logging session could be run on a process prior to process improvements being made. After the improvements have been made, the logging session could be repeated (using the same Program Net for comparison consistency). The data from the *Before* and *After* sessions could then be combined into a single file. This resulting file can then be plotted using HyperPlot. From within HyperPlot, individual plots times can be shifted, allowing for registration and comparison of the *Before* and *After* performance data.

The File Merge Process...

Two Download files can be opened and combined (merged) in the Post-Processing window as follows:

1. Open the first Download file in the usual manner by double-clicking on the Open Download File button (or selecting *File/Open Download Data File* from the menu bar).
File Information can be viewed by selecting the File/Data File Information choice from the Menu Bar.
2. Open the second Download file by selecting *File/Open Secondary Data File* from the drop-down Menu Bar. A second group of Memory icons will display within the window.
File Information on this second Source file can be viewed by selecting the File/Data File Information choice from the Menu Bar and clicking on *NO*.
3. Drag and drop a Destination File icon onto the workspace and add connections from the Memory icons (to be included in the Destination File) to the Destination File icon.
Double-click on the Destination File icon and specify a filename and type of file.
4. Click on the Start Post-Processing (green flag) button and the files will be merged into one Destination File.

Merged File Characteristics

After a Merge of two Download files, the resulting file will contain data and Channel Names from both the First and the Second source files. However, additional File Information such as Starting Time/Date, comments, etc. will be pulled from ONLY the first source file. Additionally, both file's channel data will adjusted to start at the same date/time.

9... HYPERPLOT™ GRAPHIC DATA DISPLAY

OVERVIEW

HyperPlot is an integral sub-program of HyperWare that provides graphic data display of 1 to 7 channels of OM-320 collected data versus time (Figure 9... -1). Autoscaling, zoom/unzoom, data analysis, and bitmap file (*.BMP) generation are all provided features of HyperPlot. HyperPlot displays data from the standard OM-320 Download file format (*.HLD).

Presented in this chapter is information on launching the HyperPlot program, details on using the various display options, and methods used for outputting graphed data for inclusion into reports or printing.

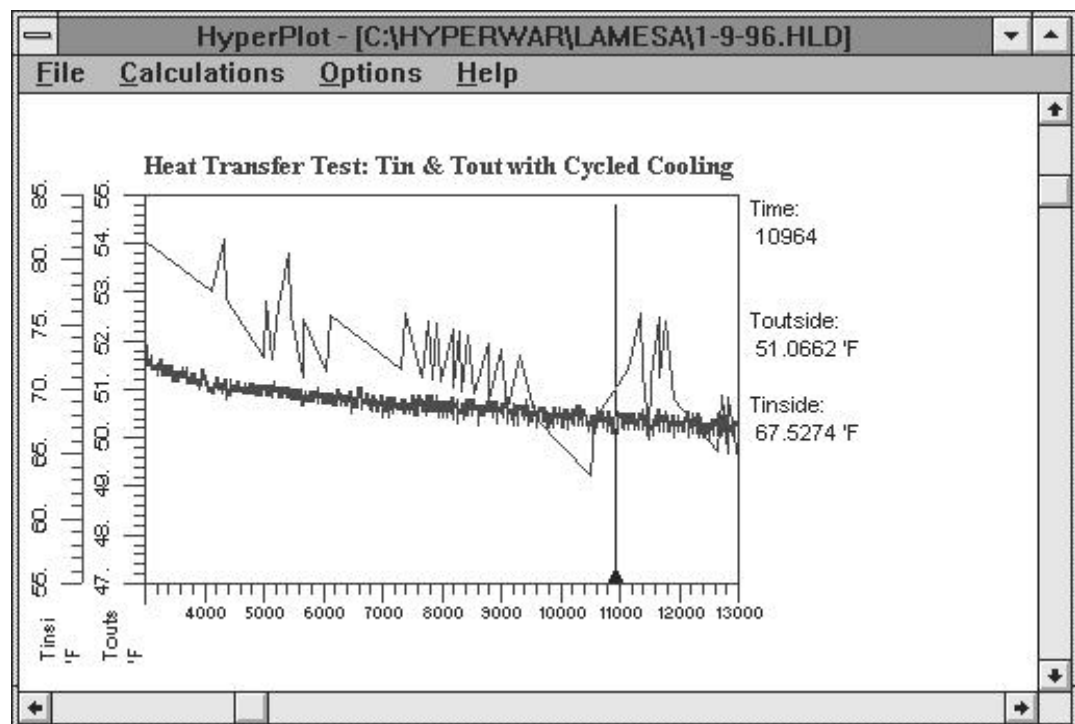

Figure 9... -1: HyperPlot graphic data display

LAUNCHING HYPERPLOT

The HyperPlot program can be launched in a number of different ways:

- ◆ Directly from the HyperComm Window for an immediate review of data just downloaded from the OM-320.
- ◆ From the Post-Processing window for general use.
- ◆ After processing of data through a Post-Processing Net

From HyperComm...

After data has been downloaded from a OM-320 to a OM-320 Download file (*.HLD) on the PC, the data can be immediately viewed with HyperPlot. After the Download file has been saved to PC disk, a Memory icon will display overlaying the PC graphic in the HyperComm Window. Double-clicking on this Memory icon will immediately launch HyperPlot. The *first seven channels of data* contained within the just Downloaded file will be automatically plotted with auto-scaled time and magnitude axis.



Figure 9...
-2: Launch
HyperPlot
button

From Post-Processing Window

For general use, HyperPlot can be launched from the Post-Processing window of HyperWare. Click on the Post-Processing button from the HyperComm Window and HyperWare will change to the Post-Processing window.

Clicking on the Launch HyperPlot button opens the HyperPlot window, at which time a OM-320 Download file can be opened (details follow).

From a Post-Processing Net

If a Post-Processing Net is constructed that utilizes a Destination File icon with a *.HLD format, HyperPlot can be launched by double-clicking on the Destination File icon immediately after running the net. HyperPlot will start and the first seven channels of data contained within the Destination File will auto-scaled and plotted.

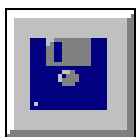

Figure 9... -
3:
Destination
File icon

HYPERPLOT WINDOW OVERVIEW

When HyperPlot starts, the window shown in Figure 9... -1 displays (with or without data graphed). Details on the various components of the HyperPlot window follow.

Time Axis

A horizontal axis is used for display of time. The time can be displayed in elapsed or absolute modes with either linear or logarithmic scaling.

Data Axis

Up to seven vertical axes can be displayed on a single plot, each with unique scaling. At the bottom of each axis is the data channel name and units assigned during construction of the net (to the Memory icon). Upon initial display, the axes are auto-scaled to allow the data to fit on the workspace. If required, scaling may be expressed with scientific notation (engineering format) and the multiplier will appear near the top of the appropriate axis.

Slide Bars

Slide bars are displayed at the right side and the bottom of the window which can be used for panning vertically and horizontally. Drag the slide button or click on the arrows at each end of the slide bars to pan the display.

Zooming

Areas of a plot can be enlarged via the HyperPlot Zooming feature. To zoom into an area of interest, a rectangular outline can be drawn around a region using the mouse and the display will change to fill the window with the outlined plot... auto-scaling time and channel data axes as necessary.

To zoom into a region:

1. Locate the mouse on one corner of the rectangular area to be defined.
2. While holding the left mouse button down, drag a rectangular box around the region to be enlarged.
3. Release the mouse button and the outlined area will fill the screen.

To zoom out, use the *Zoom All* or *Zoom Last* commands under the *Calculations* menu (see following Menu bar details).

Menu Bar

The Menu bar along the top edge of the HyperPlot window provides User control of the plotting features within HyperPlot.

HYPERPLOT MENU BAR

The conventional Windows menu bar techniques are used to load files for plotting, modify plotting parameters, and output plots. Descriptions of the features within each menu follow:

File

Open View

Loads a new OM-320 Download file for plotting.

Save as Bitmap

Outputs the *currently displayed screen view* as a Windows bitmap file. The bitmap file format is readily integrated into other software applications. When selected, a filename is requested and the file extension *.BMP is appended.

Print View

Outputs the *currently displayed screen view* to the Windows default printer.

Data File Information

Displays the Title and comments entered into the Download file at the time of Download from the OM-320 or PCMCIA card. From this window, the Title displayed at the top of Plots can be edited.

Calculations

Zoom All

Returns the view to show all of the data file.

Zoom Last

Returns the view to show the last level of zoom

Cursor

Brings a vertical cursor onto the view. The cursor shows on the left edge of the screen with a small triangle displaying just above the time axis. The cursor can be moved by locating the mouse cursor over the vertical line (the cursor will change to a double-ended arrow) then clicking the left mouse button and dragging the cursor left and right.

At the right edge of the view, the time and channel values intersected by the cursor will be displayed.

NOTE: When zoomed into a sufficient level that individual data points can be discerned on the screen, the cursor will appear to hop from data point to data point.

If mismatched sampling rates were used during data collection, displayed cursor values not on actual data points will utilize linear interpolation for the value.

Analyze View

Analyze View provides a quick display of the average, minimum value, maximum value, and the time integral for each data channel for the currently displayed view. This dialog can be copied to the Windows clipboard (hit <alt> P while the dialog is displayed) and then pasted into another application.

Options

X-Axis

The Time (X-Axis) axis can be displayed in a number of different formats at the User's discretion. Selecting the X-Axis menu results in a dialog box allowing for User specification of the following options.

TIME FORMAT

Selection of the appropriate radio buttons

- ◆ **HH:MM:SS** or **Seconds** Time Base; specifies the time display format for Hours, Minutes and Seconds, or in Seconds only.
- ◆ **Elapsed** or **Absolute** Time display; With **Elapsed** mode, the time display starts with Time 0 as the time of the first data sample. With **Absolute** mode, the time and date when the OM-320 stored the sample is used.
- ◆ **Linear** or **Logarithmic**; The X-axis is scaled linearly or on a base 10 log scale.

TIME INTERVAL

Using the provided **Time Interval** text box, the time base (essentially a manual time base zoom function) can be manually

specified. The entered value in units (approximate) will be used for the time window displayed in a single view. For example, if the value is entered as 60, the HyperPlot view will be time zoomed to display approximately 60 units (seconds, hours, etc) in a single full screen view.

TIME SHIFT

Individual channel plots can be shifted in time from milliseconds to days. Following the example format, in a Channel's text box, enter in the time to shift that plot.

The Time Shift capability can be very convenient for time registering (aligning) plots of data within a *Before / After Merged* file for easy graphic comparison. Refer to Chapter 8 for details on generating a Merged file.

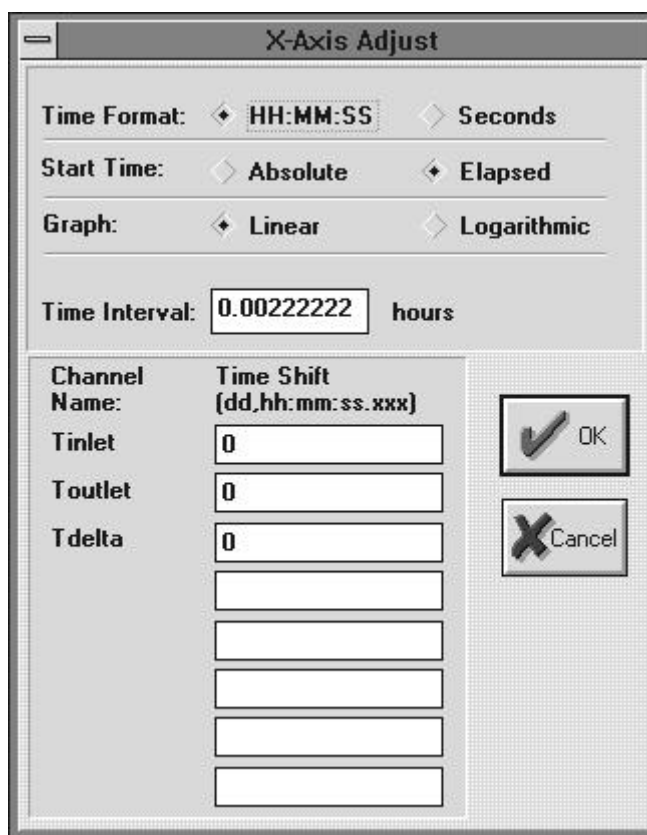

Figure 9... -4: HyperPlot Options / X-axis

Y-Axis

The Y-Axis dialog (Figure 9... -5) provides User control over grids, scaling and symbols used during the plotting of data. Descriptions of User selectable options follow:

CHANNEL NAME

The individual data channel names from the OM-320 Download file are listed. The names are assigned when developing a HyperNet and/or Post-Processing Net.

DISPLAY CHANNEL

Checking a data channel's checkbox results in that channel being plotted.

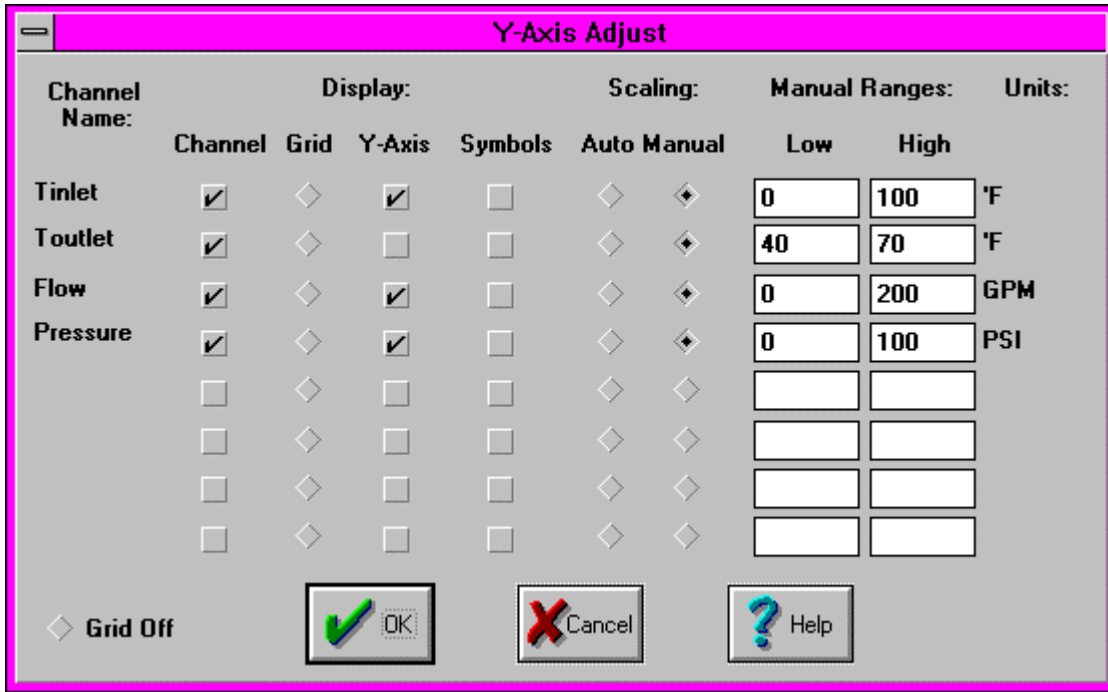

Figure 9... -5: Y-Axis configuration dialog

DISPLAY GRID

A row of radio buttons specifies to which channel's Y-axis the horizontal grid should be connected.

DISPLAY Y-AXIS

Checking a data channel's Y-Axis checkbox results in that channels Y-Axis being displayed. In many plots, it may only be necessary to display a single Y-axis if the scaling is the same for all channels. For example if four channels of temperature data are being plotted and they all are scaled from 0 to 100F, only a single Y-Axis is required, allowing more area for data display.

DISPLAY SYMBOLS

Check boxes are provided for the enabling of symbols for each displayed channel.

SCALING AUTO / MANUAL

When a OM-320 Download file is first plotted, all channels are autoscaled to fit on the screen. This auto-scaling feature can be disabled by the User and a manual range specified by clicking the Manual checkbox and entering a High and Low limit in the **Manual Ranges** text boxes. (As a short-cut, editing of the Manual Range text boxes automatically switches the Auto / Manual checkbox to Manual).

To return to the Auto-scaling mode, merely click on the Auto checkbox and the range will automatically be rescaled to fit the screen.

UNITS

The individual data channel units from the OM-320 Download file are listed. The units are assigned when developing a HyperNet and/or a Post-Processing Net.

Help

The Help menu provides access to the Help information through the standard Windows techniques.

PLOTTING LARGE FILES WITH HYPERPLOT

If a OM-320 Download file contains a channel with greater than 20,000 samples, the plot must be broken into two or more pages for plotting. If a file of this size is plotted, an information dialog box will display asking if the User wants to advance to the next page before plotting.

When a page of data (beyond the first page) is selected for plotting, the X-axis will display the time from the start of the file, however data will only be plotted in the right half of the screen. Plotted data can then be expanded to full screen using the conventional Zooming method.

INTEGRATING HYPERPLOTS INTO OTHER SOFTWARE APPLICATIONS***Via Bitmap Files***

Through the *File/Save File as Bitmap* menu choice (explained previously) HyperPlots can be saved to a bitmap file format (*.BMP) which can then be utilized in a multitude of other Windows applications.

From within other applications, menu commands are available that allow User's to specify a location and the bitmap file to be integrated. For example, from within Microsoft's Word for Windows, using the Insert Frame and insert Picture commands results in a seamless integration of the plot into a document. Other applications have similar procedures for integrating plots.

HyperPlot bitmap files can also be annotated and/or edited further from within graphic editing applications such as Windows Paintbrush.

Via the Windows Clipboard

For quick and simple integration of plots into other applications, the plot can be captured to the Windows clipboard, then pasted into another document. To perform this procedure, display the plot on the screen, then save the screen to the clipboard by pressing <ALT> and <Print Screen>. Change to the other application and utilize the Paste command to integrate it into the document.

NOTES:

10... HYPERTRACK™ REAL-TIME DATA DISPLAY

OVERVIEW

The OM-320 in conjunction with a PC running HyperWare is capable of operating in a real-time mode called HyperTrack or tracking. HyperTrack provides a real-time graphic trending and/or scrolling numerical display on the connected PC screen of values received from a serially connected OM-320. Figure 10... -1 shows real-time tracking in the HyperTrack window. The HyperTrack display occurs concurrently while the OM-320 is executing its Program Net and logging data.

Graphic trending and Scrolling can be run simultaneously and multiple windows of each function can be open.

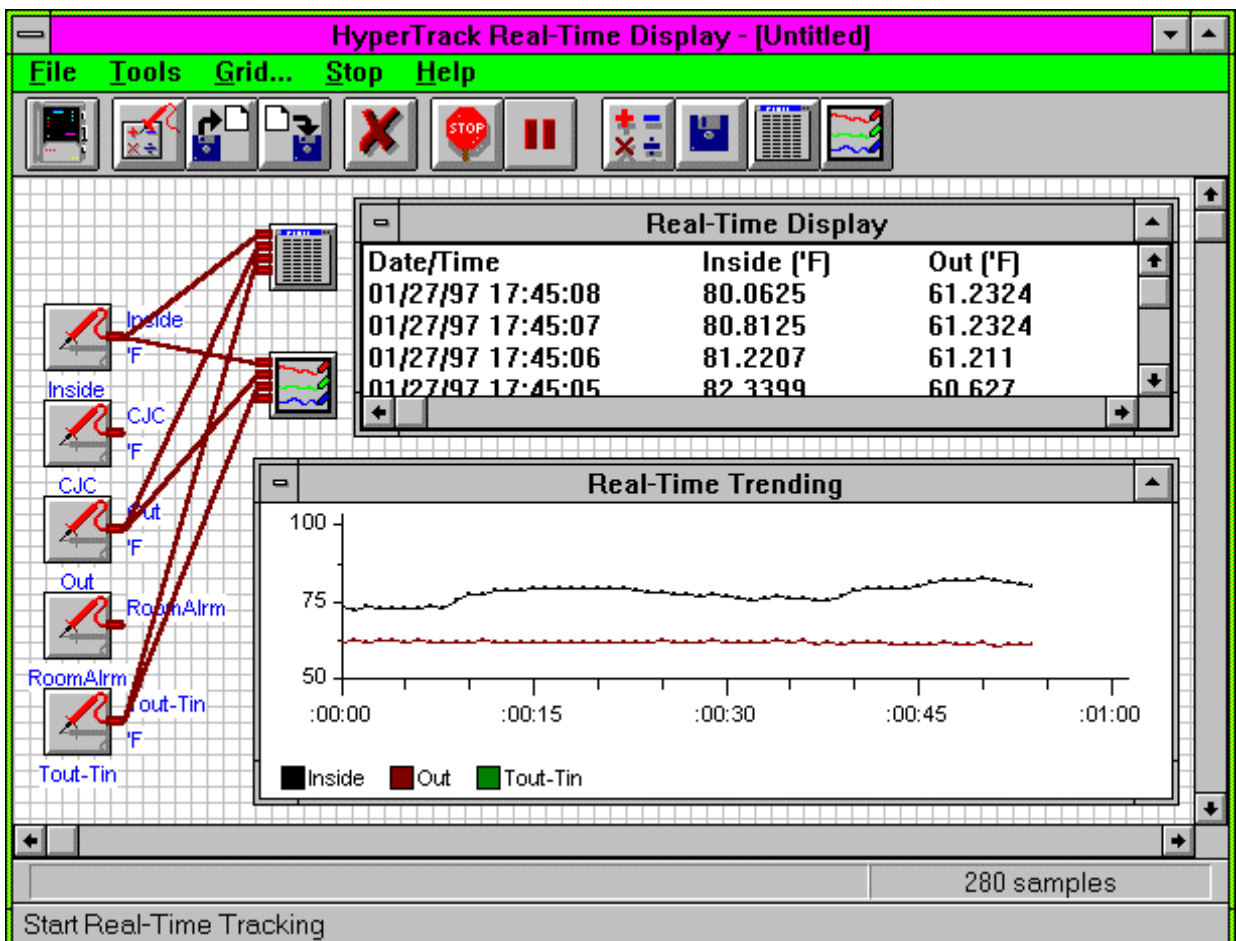

Figure 10... -1: Real-time tracking of data within the HyperTrack window

HyperTrack can operate via RS-232 or modem serial connections, allowing for the real-time monitoring of actual Program Net values from a remotely located OM-320.

To utilize the HyperTrack feature within HyperWare, the following steps are performed:

1. Develop and upload to the OM-320 a Program Net which includes Probe Point icons at the Net nodes to be monitored.

10... HYPERTRACK™ REAL-TIME DATA DISPLAY

2. From within HyperTrack, construct a real-time HyperTrack Net.
(Note that this is a different Net than the Program Net uploaded into the OM-320 memory. The HyperTrack Net runs on the PC)
3. Establish the serial connection between the PC and the OM-320
4. Enable real-time tracking

CONSTRUCTING A OM-320 PROGRAM NET FOR HYPERTRACK



Figure 10... -
2: Probe
Point icon

A OM-320 that is to be used in the real-time tracking mode must be programmed with a Program Net that incorporates Probe Point icons. The Probe Point icons are connected to nodes within the Program Net that the User may want to monitor through HyperTrack. Not all nodes with Probe Point icons must be displayed on the PC during HyperTrack, however any node to be monitored must have a Probe Point icon.

Probe Point icons can be given a Name via the conventional icon configuration dialog box. This name is used as a column heading during real-time tracking (see the Master Icon Reference in Appendix A).

Figure 10... -3 shows a simple two thermocouple Program Net that has Probe Point icons to allow HyperTrack display of the two temperatures, Tinlet and Toutlet, and the cooling fan status FanStat.

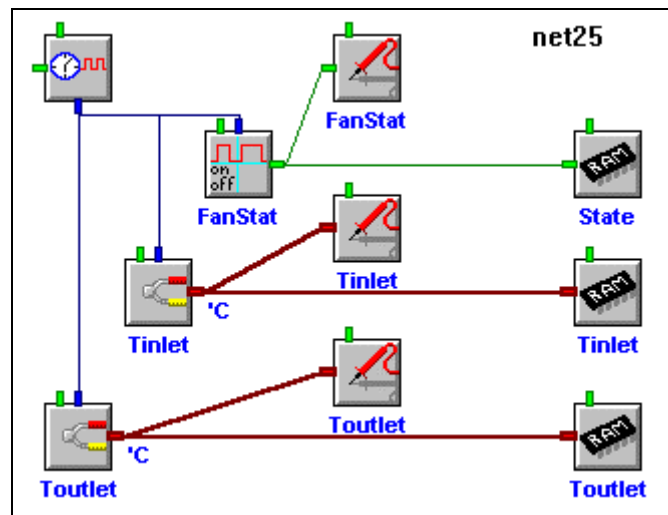

Figure 10... -3: Example Program Net with Probe Point icons connected for tracking (built in HyperNet window)

Nodes within the Program Net to which Probe Point icons are connected can also be displayed on the OM-320 front-panel LCD real-time. Refer to Chapter 2 for real-time LCD display of Probe Point icons.

After completion of the Program Net, upload it to the OM-320 memory. Refer to Chapter 7 for Program Net development and uploading procedures.

CONSTRUCTING A HYPERTRACK NET

During a real-time tracking session, the OM-320 transmits values of the Probe Point icons to the PC via the serial link. These values are then processed through a HyperTrack Net running on the PC (in the HyperTrack window) and displayed.

HyperTrack Nets provide a means to perform additional processing of values from Probe Point icons before they are displayed. HyperTrack Nets can also provide storage of Probe Point icon values to a file on the PC while the real-time data is being received.

The HyperTrack Net is constructed much the same way as a Program Net is developed within HyperNet. The main difference is that a Program Net running in a OM-320 receives its data from various hardware channels such as thermocouples whereas the HyperTrack Net receives its data from the Probe Point icons contained in the Program Net in an Enabled OM-320. Figure 10... -4 shows a completed HyperTrack Net.

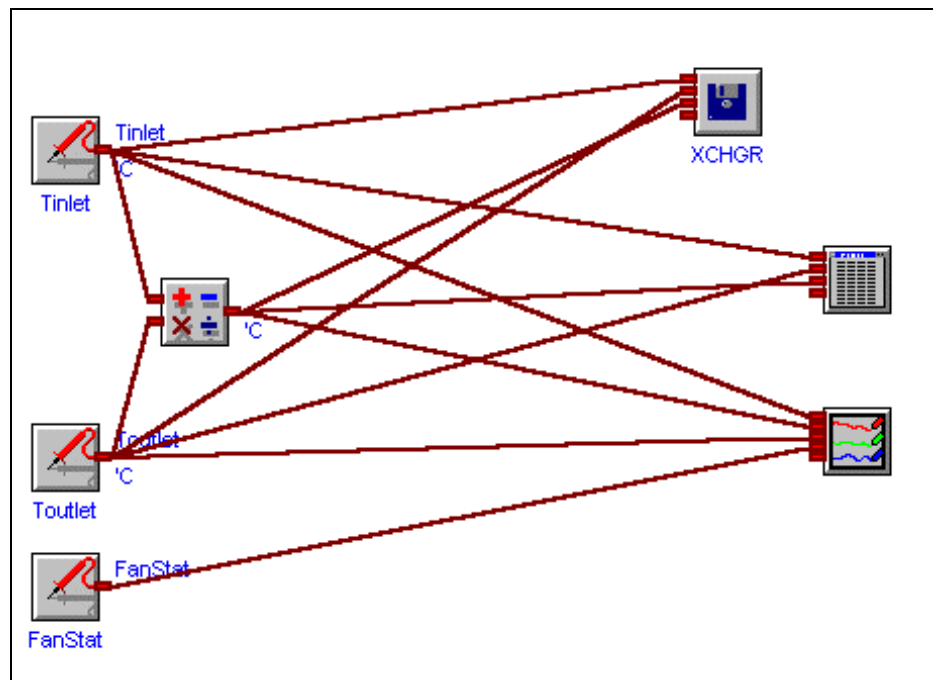

Figure 10... -4: Example HyperTrack Net (developed within the HyperTrack window)

Determining OM-320 Program Net Probes Information

Before a HyperTrack Net can be developed, the Probe Point icons contained within the associated OM-320 Program Net must be known. This information can be gained by downloading the Program Net from a serially connected OM-320 or by opening the Program Net from disk (assuming it was saved after development).

Receiving Probe Point Icons from a serially connected OM-320):

1. Establish a serial connection with the OM-320 to be used during the HyperTrack session. At this time, the OM-320 has already been programmed with a Program

10... HYPERTRACK™ REAL-TIME DATA DISPLAY

Net that contains the desired Probe Point icons. The OM-320 may be in either the Enabled or Stopped mode.

2. From the HyperComm Window, click and drag the Program Net icon on the OM-320 to the PC and release it. The Program Net and Probe Point icon information will be automatically downloaded to the PC *and a Probe Point icon will display overlaying the image of the PC.* NOTE: If the Probe Point icon does not display on the PC, then the transferred Program Net does not contain Probe Point icon(s) and this Program Net can not be used for tracking. (In this case, develop a new Program Net containing Probe Point icons and upload it to the OM-320.)
1. From within the HyperComm Window, click on the HyperTrack button (or double click on the Probe Point icon overlaying the PC) and the HyperTrack window will appear with Probe Point icon(s) displayed on the left edge of the workspace (Figure 10... -5). These icons represent the Probe Point icons detected in the Program Net that was just downloaded to the PC (and which is

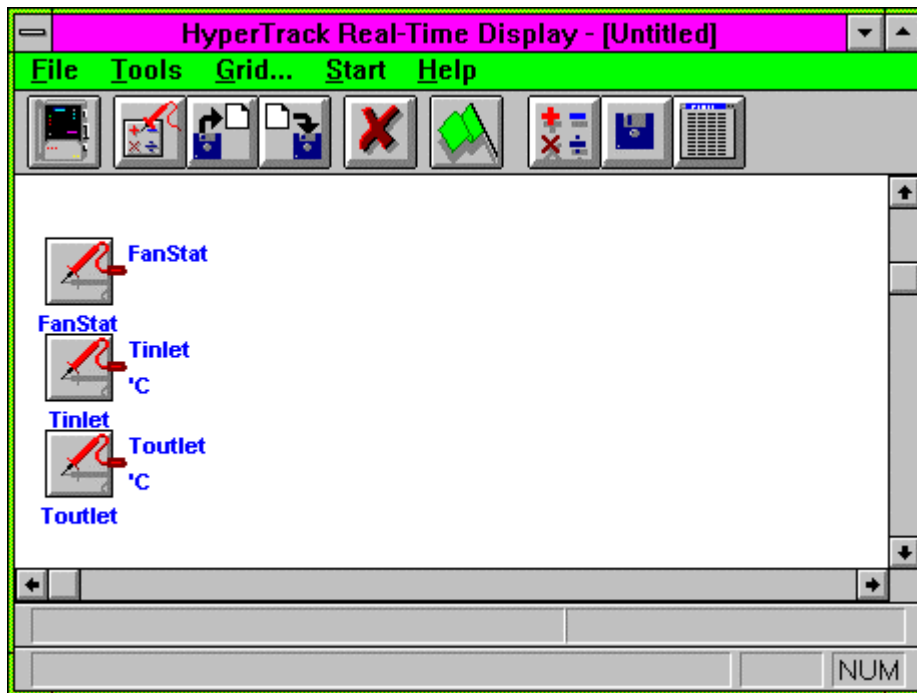

Figure 10... -5: Probe Points detected in the currently loaded Net Program

currently programmed in the OM-320's memory).

2. Once this Probe Point icon information is displayed on the workspace, it can be saved to a HyperTrack Net file (the filename extension *.PRB will be appended) by using the *File/Save As* drop-down menu selection. This file can then be used as a starting point for development of additional nets based on the same Program Net.

3. The OM-320 connection can then be disconnected (eg to save long distance charges if connected via modem) while the HyperTrack Net is developed.

Reading Probe Point icons from a Program Net on disk:

If a copy of the Program Net that will be running in the OM-320 during tracking is available on disk, this Program Net can be opened from disk and the Probe Point icon information will be available for HyperTrack Net development.

This method does not require establishing a serial link with the OM-320.

1. Switch to the HyperNet Window by clicking on the HyperNet button.
 2. Open the Program Net file
 3. Switch to the HyperComm Window by clicking on the HyperComm button, and a Probe Points icon should be overlaid on the PC. (If the Probe Point icon is not displayed, the Program Net selected does not contain any Probe Point icons and a new Program Net should be selected/developed.)
1. From within the HyperComm Window, click on the HyperTrack button (or double click on the Probe Point icon overlaying the PC) and the HyperTrack window will appear with Probe Point icons displayed on the left edge of the workspace. These icons represent the Probe Point icons in the Program Net currently programmed in the OM-320's memory.
 2. Once this Probe Point icon information is displayed on the workspace, it can be saved to a HyperTrack Net file (the filename extension *.PRB will be appended) by using the *File/Save As* drop-down menu selection. This file can then be used as a starting point for development of additional nets based on the same Program Net.

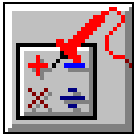

**Figure 10...
-6:
HyperTrack
button**

Note: The Program Net icon overlaying the PC in the HyperComm Window represents the last Program Net loaded from disk (in the HyperNet Window) or the last Program Net downloaded from a serially connected OM-320. If the Program Net currently residing in the PC contains Probe Point icons, then that icon will also show overlaying the PC.

Building the HyperTrack Net

Icons

Three icons are available on the Icon Toolbar for use in construction of the HyperTrack Net, a Math icon, a File icon, and the Real-Time Scrolling Display icon.

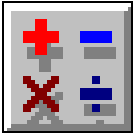

Figure 10... -
7: Math icon

MATH ICON

The Math icon provides algebraic processing of data as it passes from input to output. In Figure 10... -3 above, the Math icon is providing a differential temperature calculation and generating a third data channel, *Tdelta* which is then displayed as well as stored to file.

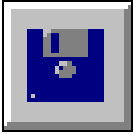

Figure 10... -
8: File icon

FILE ICON

The File icon represents storage to file of all signals connected to its inputs. Multiple inputs can be connected to the File icon and through its configuration dialog box, the data can be stored in an ASCII (*.TXT), OM-320 Download (*.HLD), or Excel Spreadsheet (*.XLS) format.

Multiple File icons can be connected in a net for simultaneous storage of different signals and/or multiple file formats.

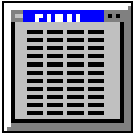

Figure 10... -
9: Real-time
Scroll icon

REAL-TIME SCROLLING DISPLAY ICON

Signals connected to the Scrolling Display icon will be displayed in a scrolling columnar format on the Workspace when tracking is enabled. Up to 8 inputs can be connected to this icon. No configuration dialog is available for this icon, double-clicking on it opens the scrolling display window.

Multiple Scrolling Display icons can be connected in a net allowing multiple HyperTrack windows to be displayed simultaneously for greater channel capability.

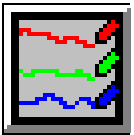

Fig 10... -
10: Real-
time Trend
icon

REAL-TIME GRAPHIC TRENDING DISPLAY ICON REAL-TIME GRAPHIC TRENDING DISPLAY

Signals connected to the Trending Display icon will be displayed in a multi-trace horizontal line graph format within the Workspace when tracking is enabled. Up to 8 inputs can be connected to this icon. No configuration dialog is available for this icon, double-clicking on it opens the scrolling display window.

Multiple Scrolling Display icons can be connected in a net allowing multiple HyperTrack windows to be displayed simultaneously for greater channel capability.

Connecting Icons

Icons are connected using the standard drag and drop connection method used for construction of Program Nets.

Unconnected Probe Point icons will not display.

Other HyperTrack Net Development Options

As in the development of a Program Net from within HyperNet, various tools such as Grid, Snap, and Print Net options are available from the Menu Bar.

Saving the HyperTrack Net

Upon completion of the Net, it can be saved for later use with the menu selection *File/Save Net As* or with the *Save Net* button.

Saved HyperTrack Nets should only be used for real-time tracking with OM-320s configured with Program Nets that contain matching Probe Point icons. If mismatched nets are used, channels may be incorrectly titled and displayed in incorrect sequence.

For example: A HyperTrack Net is developed and saved for use with a OM-320 Program Net that includes 3 Probe Point icons labeled A, B, and C. Accidentally, the HyperTrack Net is used with a OM-320 running a Program Net that contains only 2 Probe Point icons labeled X and Y. The resulting HyperTrack Net data display will result in two channels labeled A (displaying X data) and B (displaying Y data) and a third channel labeled C that just displays 0.

To avoid this confusion, check the correlation between the HyperTrack Net and the OM-320 Program Net before Tracking.

STARTING A HYPERTRACK SESSION

Initiation of a HyperTrack session is handled from within the HyperTrack window. Before starting a session, the following conditions must be met:

- ◆ The OM-320 must be programmed with a Program Net including Probe Point icons
- ◆ A serial connection between the OM-320 and the PC must be established
- ◆ A compatible HyperTrack Net must be loaded and displayed on the HyperTrack window of HyperWare
- ◆ All File icons included within the HyperTrack Net must have filenames provided
- ◆ The OM-320 must be Enabled

To start tracking, click on the Green Start button. Clicking on this button commands the connected OM-320 to start sending out the Probe Point icon values, which are in turn processed by the HyperTrack Net on the PC. The Scrolling Display window(s) will automatically open and begin displaying data. Any Destination File icons will create the specified filenames and begin recording to that file.

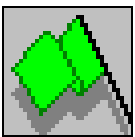

Figure 10... -
11: Start
Tracking
button

HyperTrack Scrolling Display Window

During real-time tracking, data from the signals connected to the Scrolling Display icon is displayed in a columnar format in the pop-up Scrolling Display window.

Channel Display Order

The order of display (left to right) of inputs is set by the order of connection of signals to the Scrolling Display icon. The top connection is displayed on the left and the bottom connection is displayed on the right.

Up to 8 channels can be displayed in the Scrolling Display window. Utilize the slide bar at the bottom of the window to view channels that are out of the window to the left or right.

Data Buffer

As new data is collected, older data will be scrolled down one line. Older data is still accessible after it has scrolled out of the window by clicking on the scroll bar buttons on the right side of the window.

HyperTrack Trending Display Window

During real-time tracking, data from the signals connected to the Trending Display icon is displayed in a multi-pen horizontal format in the pop-up Trending Display window. Time is plotted horizontally and input data amplitude is plotted vertically on a single axis.

As time progresses, track data is buffered, scrolls off the left edge of the window, and is eventually deleted from the buffer (FIFO) as a function of the User defined settings explained below.

NOTE:

In cases where the OM-320 is set for very fast sampling rates , the Trending function will put heavy video demands on the connected PC and PC's video card. In some cases, the PC will be unable to handle the high speed incoming data stream and the Trending display will not perform or will update very slowly. If this is the case, decrease the OM-320 sampling rate or run HyperWare and the Trending function on a faster PC platform.

Trending Configuration Dialog

By double-clicking anywhere on the Trending Display Window, a Configuration Dialog is displayed (Figure 10... -12). This dialog allows for various User settings for the data display.

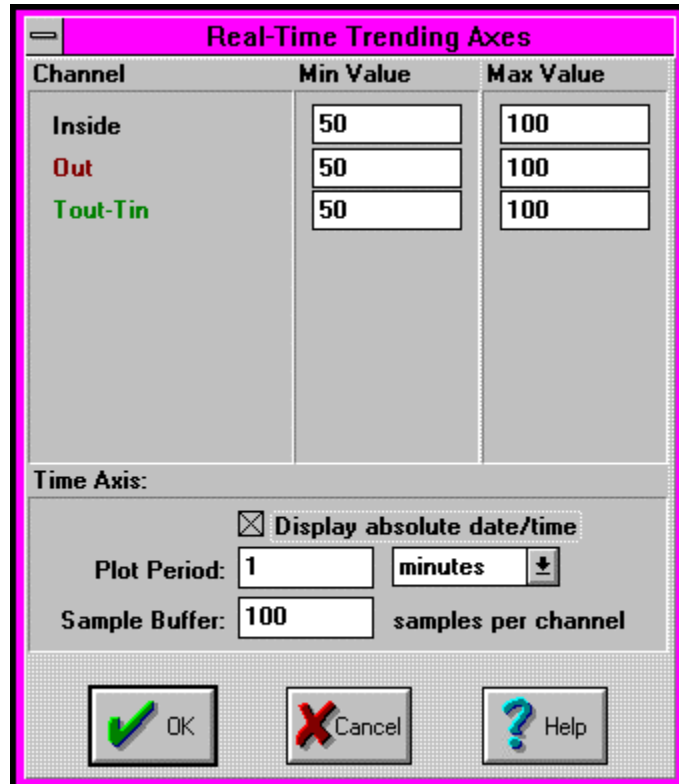

The dialog box is titled "Real-Time Trending Axes" and contains the following settings:

Channel	Min Value	Max Value
Inside	50	100
Out	50	100
Tout-Tin	50	100

Time Axis:

Display absolute date/time

Plot Period: 1 minutes

Sample Buffer: 100 samples per channel

Buttons: OK (Green Checkmark), Cancel (Red X), Help (Blue Question Mark)

Figure 10... -12: Real Time Trending Configuration dialog

NOTE: After changing any of the following settings, the Tracking session must be Stopped (click on the Stop Sign Button) and restarted (Green Flag). Changing any of the following settings during a Tracking session will result in a refresh of the display and clearing of buffered data.

Time Display Formats

Time is displayed on the horizontal axis and can be set for either Elapsed time since the start of the Track session (the default), or Absolute, in which the absolute calendar date and time is displayed. To select Absolute, click on the Display Absolute Date/Time check-box.

Channel Ranges

The data channels are scaled and plotted per a single amplitude axis on the left edge of the plot. Upon start of a Trend Tracking session, the range for all channels defaults to +/-1000.

A Min. and Max. value for each channel can be set by editing the appropriate text boxes. If all of the channels have the same Min/Max values, then the vertical axis will reflect this range. For example if 4 channels of room temperature are being logged, all of the 4 channels could be set for 50 to 70 and the vertical axis would reflect this approximate range.

If the Channels have different Min/Max settings, the vertical axis will default to display as 0 to 100% of the range specified.

Data Buffer

As data is received by the Trending icon, it is buffered temporarily in PC memory. Eventually, the buffer fills and the oldest data is deleted as new data is added (FIFO). The amount of data that is buffered in the PC is set in the Trending Configuration dialog by editing the Sample Buffer text box.

Plot Period

The amount of data that is displayed in the Trending Window is set by editing the Plot Period setting in the Configuration Dialog. Older data (that has not rolled out of the buffer... see above) is still accessible after it has scrolled out of the window by clicking on the scroll bar buttons on the lower edge of the window.

NOTE: Stopping, then restarting a HyperTrack session using a net containing File icons will cause the file information to be overwritten with new data. To save data from consecutive HyperTrack sessions, rename any connected File icon before restarting the HyperTrack session.

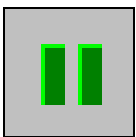

Figure 10... -
13: Pause
button

PAUSING A HYPERTRACK SESSION

By clicking on the Pause button on the toolbar, a HyperTrack session can be temporarily stopped if the data being received is of no concern. Any connected Destination File icons will stop writing to their files, *but will not close*.

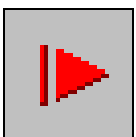

Figure 10... -
14: Resume
button

RESUMING AFTER PAUSE

When in Pause mode, the Pause button will change into a Resume button. Clicking this button will resume normal Tracking operation and resume writing to any Destination File icons.

STOPPING A HYPERTRACK SESSION

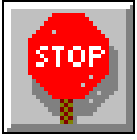

Figure 10... -
15: Stop
Tracking
button

To stop a real-time tracking session, click on the Stop button. Stopping a tracking session does not stop execution of the Program Net within the OM-320, it merely commands the OM-320 to stop sending Probe Point values to the PC.

When a HyperTrack session is stopped, the files associated with any connected File icons are closed and the update of data to the Scrolling Display window stops.

NOTE: Stopping, then restarting a HyperTrack session using a net containing File icons will cause the file information to be overwritten with new data. To save data from consecutive HyperTrack sessions, rename any connected File icon before restarting the HyperTrack session.

10... HYPERTRACK™ REAL-TIME DATA DISPLAY

NOTES:

10... HYPERTRACK™ REAL-TIME DATA DISPLAY

11... APPENDICES

11... APPENDICES

NOTES:

APPENDIX A: MASTER ICON REFERENCE

SUPPLY VOLTAGE (VBATT) INPUT ICON

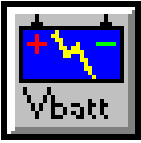

FUNCTION:

Used to take readings of the OM-320 Supply Voltage. If internal batteries are installed in the OM-320 and an external power supply is also connected, the output value will be the higher of the two.

INPUTS:

- Hardware:** No signal input shown on Net for Program Net connections.
- Update Clock:** Output is updated with new reading upon each Update Clock pulse when Enable input is unconnected or HI.
- Enable:** Processing of icon is allowed when Enable pin is unconnected or connected and Enable signal is TRUE.

OUTPUTS:

- Output Signal:** Data type signal. The Units of the output are Volts

ICON CONFIGURATION DIALOG BOX:

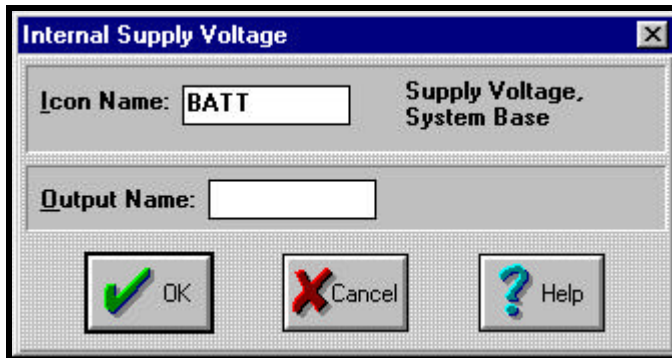

CONFIGURATION OPTIONS:

- Icon Name:** Specify the label for the icon. This name will show directly under the icon within the Program Net.
- Output Name:** Specify the label for the Output. This name will show directly under the Output terminal within the Program Net.

THERMOCOUPLE INPUT ICON:

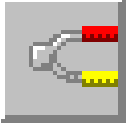

FUNCTION:

Performs the thermocouple channel selection, amplification, cold junction compensation and A-D conversion for a thermocouple hardware input from an HLIM-1 Interface Module. The CJC reading is taken from the integral thermistor on the TSA (terminal strip adapter).

INPUTS:

- Hardware:** No signal input shown on Net for Program Net connections.
- Update Clock:** Output is updated with new reading upon each Update Clock pulse when Enable input is unconnected or Hi.
- Enable:** Processing of icon is allowed when Enable pin is unconnected or connected and Enable signal is TRUE.

OUTPUTS:

- Output Signal:** Data type signal. The Units of the output are degrees C or F, selectable from the icon configuration dialog box.

ICON CONFIGURATION DIALOG BOX:

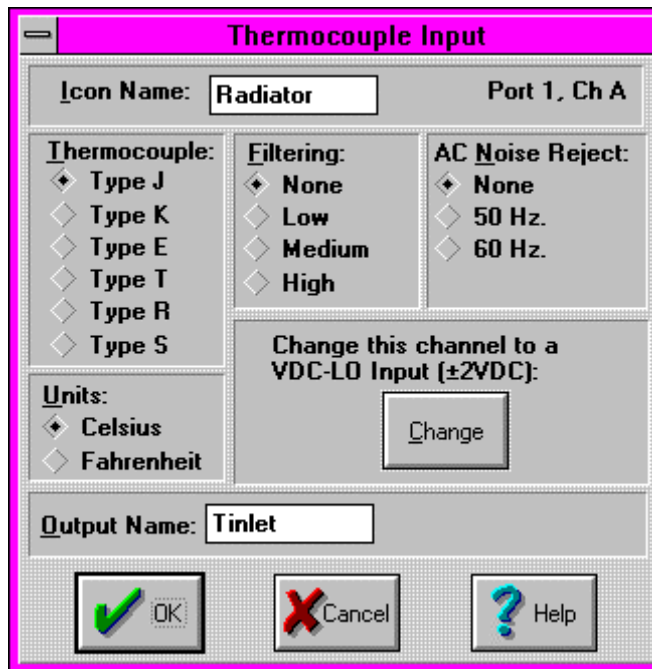

CONFIGURATION OPTIONS:

- Icon Name:** Specify the name for the channel. This name will show directly under the icon within the Program Net. If no name is User provided, the Backplane Port (1 to 6) and Channel (A to D) where the actual Interface Module channel is installed will be used for the name.
- Output Name:** Specify a name for the Output signal from this icon. This Output Name will be referenced by other icons downstream in the Program Net.
- Use This Channel for Voltage:** Both the Thermocouple Icon and the VDC-2V Icon utilize the same Interface Module hardware Configuration Switch setting. Because of this capability, a Thermocouple Icon can be changed into a VDC-LO Icon by simply clicking on the CHANGE button.

- Thermocouple Type:** Specify the type of thermocouple to be connected to this channel.
- Units:** Specifies the temperature scale units that will be output from this icon. Celcius and Fahrenheit are directly supported, however, conversion to other units can be performed within a Program Net by adding a Math Icon onto this icon's output.
- AC Noise Reject:** Enables software filtering of 50Hz or 60Hz noise on inputs. See Appendix for an explanation of the 50/60 Hz filtering technique.
- Filtering:** Three levels of first order noise filtering can be enabled during thermocouple channel reading. First order filtering reduces high frequency noise that may be picked up by sensor wiring with the cost that it slows down the rate at which a channel can be sampled. See Appendix for discussion on use of filtering.

CJC (COLD JUNCTION COMPENSATION) INPUT ICON:

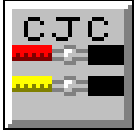

FUNCTION:

Performs the Cold Junction Compensation (CJC) channel selection, amplification, and A-D conversion for a thermistor hardware input from a sensor mounted on the Terminal Strip Adapter (TSA).

Alternatively, the CJC icon can be used to take a resistance reading or measure the temperature of an external thermistor (10Kohm at 25C, Fenwall curve 16 or equivalent). A wire jumper on the TSA can be removed and external wiring added if this optional use is desired. Due to the optimization of the CJC circuit for temperature sensing, the resistance measurement capability of this circuit does not provide consistent linearity over the full range. The normal resistance measuring range for a thermistor is 200 ohms to 70,000 ohms.

NOTE: If Thermocouple icons are used in the Program Net, the external sensing function described above must not be used as the temperature of the TSA is critical in the calculation of thermocouple temperatures.

INPUTS:

Hardware: No signal input shown on Net for Program Net connections.

Update Clock: Output is updated with new reading upon each Update Clock pulse when Enable input is unconnected or Hi.

Enable: Processing of icon is allowed when Enable pin is unconnected or connected and Enable signal is TRUE.

OUTPUTS:

Output Signal: Data type signal. The Units of the output are degrees C, degrees F, or Ohms. This is software selectable from the icon configuration dialog box.

ICON CONFIGURATION DIALOG BOX:

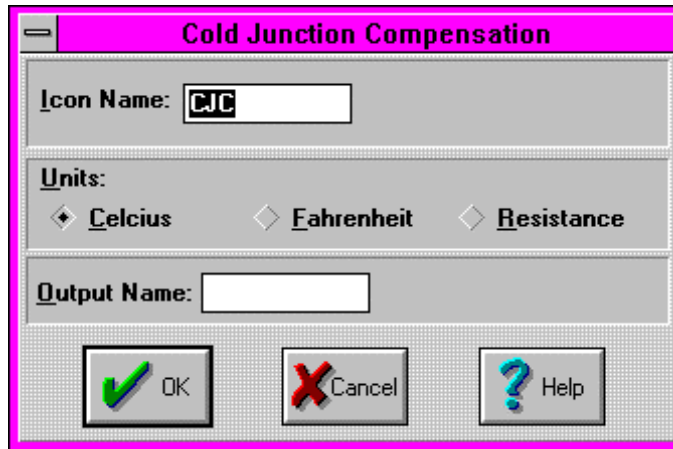

CONFIGURATION OPTIONS:

Icon Name: Specify the name for the channel. This name will show directly under the icon within the Program Net.

Output Name: Specify a name for the Output signal from this icon. This Output Name will be referenced by other icons downstream in the Program Net.

Units: Specifies the temperature scale units that will be output from this icon. Celcius, Fahrenheit, and Ohms are directly supported.

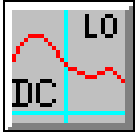

DC-LO; +/- 2VDC FULL SCALE VOLTAGE INPUT ICON

FUNCTION:

Performs the analog channel selection, amplification, and A-D conversion for a DC voltage input within the range of +/-2V from an HLIM-1 Interface Module.

INPUTS:

Hardware: No signal input shown on Net for Program Net connections.

Update Clock: Output is updated with new reading upon each Update Clock pulse when Enable input is unconnected or Hi.

Enable: Processing of icon is allowed when Enable pin is unconnected or connected and Enable signal is TRUE.

OUTPUTS:

Output Signal: Data type signal. The Units of the output are Volts

ICON CONFIGURATION DIALOG BOX:

CONFIGURATION OPTIONS:

Icon Name: Specify the name for the channel. This name will show directly under the icon within the Program Net. If no name is User provided, the Backplane Port (1 to 6) and Channel (A to D) where the actual Interface Module channel is installed will be used for the name.

Output Name: Specify a name for the Output signal from this icon. This Output Name will be referenced by other icons downstream in the Program Net.

Change this channel to a thermocouple input: Both the Thermocouple Icon and the DC-LO Icon utilize the same Interface Module hardware Configuration Switch setting. Because of this capability, a DC-LO Icon can be changed into a Thermocouple Icon by simply clicking on the CHANGE button.

11.. . APPENDIX A: MASTER ICON FILE REFERENCE

- Range:** Specify the input range to be used for this channel. Select the range so that anticipated input signal fluctuations will not exceed this Full Scale range. If the input exceeds the selected range, an over-range value will be logged.
- AC Noise Reject:** Enables software filtering of 50Hz or 60Hz noise on inputs. See Appendix for an explanation of the 50/60 Hz filtering technique.
- Filtering:** Three levels of first order noise filtering can be enabled during channel reading. First order filtering reduces high frequency noise that may be picked up by sensor wiring with the cost that it slows down the rate at which a channel can be sampled. See Appendix for discussion on use of filtering.

DC-MED; +/- 10 VDC FULL SCALE VOLTAGE INPUT ICON

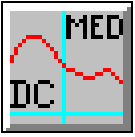

FUNCTION:

Performs the analog channel selection, amplification, and A-D conversion for a DC voltage input within the range of +/-10VDC from an HLIM-1 Interface Module.

INPUTS:

Hardware: No signal input shown on Net for Program Net connections.

Update Clock: Output is updated with new reading upon each Update Clock pulse when Enable input is unconnected or Hi.

Enable: Processing of icon is allowed when Enable pin is unconnected or connected and Enable signal is TRUE.

OUTPUTS:

Output Signal: Data type signal. The Units of the output are Volts

ICON CONFIGURATION DIALOG BOX:

CONFIGURATION OPTIONS:

Icon Name: Specify the name for the channel. This name will show directly under the icon within the Program Net. If no name is User provided, the Backplane Port (1 to 6) and Channel (A to D) where the actual Interface Module channel is installed will be used for the name.

Output Name: Specify a name for the Output signal from this icon. This Output Name will be referenced by other icons downstream in the Program Net.

Range: Specify the input range to be used for this channel. Select the range so that anticipated input signal fluctuations will not exceed this Full Scale range. If the input exceeds the selected range, an over-range value will be logged.

AC Noise Reject: Enables software filtering of 50Hz or 60Hz noise on inputs. See Appendix for an explanation of the 50/60 Hz filtering technique.

Filtering: Three levels of first order noise filtering can be enabled during channel reading. First order filtering reduces high frequency noise that may be picked up by sensor wiring with the cost that it slows down the rate at which a channel can be sampled. See Appendix for discussion on use of filtering.

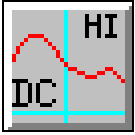
DC-HI; +/- 30 VDC FULL SCALE VOLTAGE INPUT ICON**FUNCTION:**

Performs the analog channel selection, amplification, and A-D conversion for a DC voltage input within the range of +/-30VDC from an HLIM-1 Interface Module.

INPUTS:

Hardware: No signal input shown on Net for Program Net connections.

Update Clock: Output is updated with new reading upon each Update Clock pulse when Enable input is unconnected or Hi.

Enable: Processing of icon is allowed when Enable pin is unconnected or connected and Enable signal is TRUE.

OUTPUTS:

Output Signal: Data type signal. The Units of the output are Volts.

ICON CONFIGURATION DIALOG BOX:
CONFIGURATION OPTIONS:

Icon Name: Specify the name for the channel. This name will show directly under the icon within the Program Net. If no name is User provided, the Backplane Port (1 to 6) and Channel (A to D) where the actual Interface Module channel is installed will be used for the name.

Output Name: Specify a name for the Output signal from this icon. This Output Name will be referenced by other icons downstream in the Program Net.

Range: Specify the input range to be used for this channel. Select the range so that anticipated input signal fluctuations will not exceed this Full Scale range. If the input exceeds the selected range, an over-range value will be logged.

AC Noise Reject: Enables software filtering of 50Hz or 60Hz noise on inputs. See Appendix for an explanation of the 50/60 Hz filtering technique.

Filtering: Three levels of first order noise filtering can be enabled during channel reading. First order filtering reduces high frequency noise that may be picked up by sensor wiring with the cost that it slows down the rate at which a channel can be sampled. See Appendix for discussion on use of filtering.

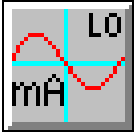
MA-LO; +/- 20 MADC FULL SCALE CURRENT INPUT ICON**FUNCTION:**

Performs the analog channel selection, amplification, and A-D conversion for a DC current input within the range of +/-20mADC from an HLIM-1 Interface Module.

INPUTS:

Hardware: No signal input shown on Net for Program Net connections.

Update Clock: Output is updated with new reading upon each Update Clock pulse when Enable input is unconnected or Hi.

Enable: Processing of icon is allowed when Enable pin is unconnected or connected and Enable signal is TRUE.

OUTPUTS:

Output Signal: Data type signal. The Units of the output are Milliamps.

ICON CONFIGURATION DIALOG BOX:
CONFIGURATION OPTIONS:

Icon Name: Specify the name for the channel. This name will show directly under the icon within the Program Net. If no name is User provided, the Backplane Port (1 to 6) and Channel (A to D) where the actual Interface Module channel is installed will be used for the name.

Output Name: Specify a name for the Output signal from this icon. This Output Name will be referenced by other icons downstream in the Program Net.

Range: Specify the input range to be used for this channel. Select the range so that anticipated input signal fluctuations will not exceed this Full Scale range. If the input exceeds the selected range, an over-range value will be logged.

AC Noise Reject: Enables software filtering of 50Hz or 60Hz noise on inputs. See Appendix for an explanation of the 50/60 Hz filtering technique.

Filtering: Three levels of first order noise filtering can be enabled during channel reading. First order filtering reduces high frequency noise that may be picked up by

11.. . APPENDIX A: MASTER ICON FILE REFERENCE

sensor wiring with the cost that it slows down the rate at which a channel can be sampled. See Appendix for discussion on use of filtering.

RTD INPUT ICON (HLIM-4)

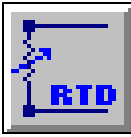

FUNCTION:

RTD, resistance, and thermistor signal inputs can all be handled with the HLIM-4. With the HLIM-4 installed in a OM-320, these respective function icons become available for use in Program Nets.

As an RTD input, the icon samples the resistance of the connected RTD, converts it to temperature and passes it along to the next icon. 2, 3, and 4-wire configurations are all supported.

This channel/icon can be changed to a thermistor or resistance input channel by selecting the **Change button**.

INPUTS:

Hardware: No signal input shown on icon for Program Net connections.

Update: The input is sampled every time an Update command is received on the Update input and the Enable terminal is True.

Enable: Processing of the icon is allowed when Enable pin is unconnected or connected *and* the Enable signal is TRUE.

OUTPUTS:

Output Signal: Data type signal. The Units of the output are degrees C, degrees F, or Ohms. This is software selectable from the icon configuration dialog box.

ICON CONFIGURATION DIALOG BOX:

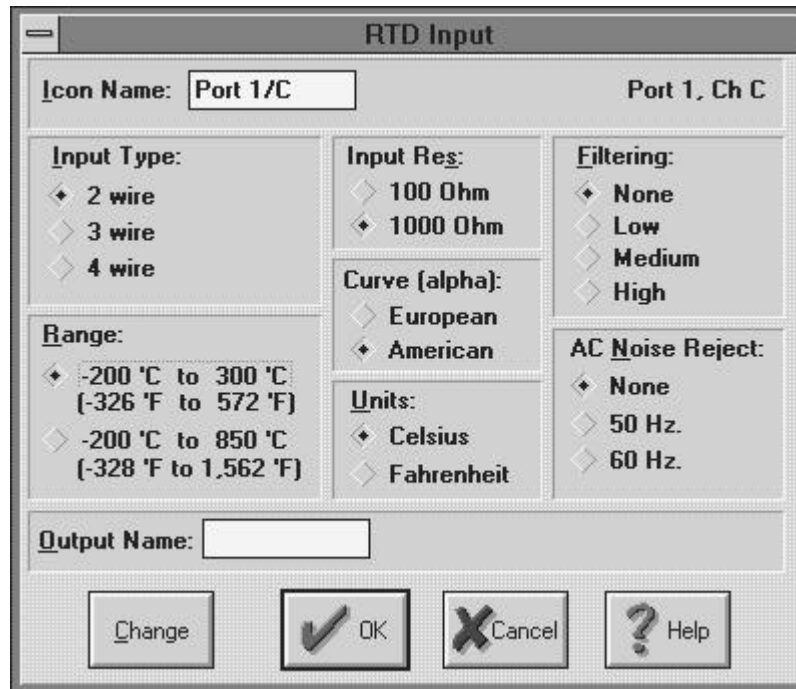

CONFIGURATION OPTIONS:

Icon Name: Specify the name for the channel. This name will show directly under the icon within the Program Net. If no name is User provided, the Backplane Port (1 to 6) and Channel (A to H) where the actual Interface Module channel is installed will be used for the name.

Output Name: Specify a name for the Output signal from this icon. This Output Name will be referenced by other icons downstream in the Program Net.

Input Type: Specifies the wiring configuration to be used.
2-Wire is typically used for measurements of higher resistance values or with short lead wire runs where the resistance of the lead wires induces negligible error. With 2-wire configuration, all four input channels can be used.
3 and 4-Wire configurations are used where the lead wires to the element are longer and/or premium measurement accuracy is required. Both 3 and 4-wire configurations compensate for the lead wire resistance. 3-wire provides nearly the same performance as 4-wire using only 3 wires instead of 4.
If 3 or 4-wire configuration is selected, the input requires two input channels. From within the A and C channel icons, selecting 3 or 4-wire will result in a displayed message that a second channel will be deleted (B or D).

Range: Specify the input range to be used for this channel. For optimum resolution, choose the narrowest range that will meet the signal fluctuation without exceeding the Full Scale Range. If the input exceeds the selected range, an over-range value will be logged.

Input Res: Specify the RTD 0°C resistance value. Both 100 and 1000 ohm devices are supported.

Curve (alpha): Specify the alpha coefficient for your type of RTD. This coefficient is used in the conversion equation of resistance to temperature. If unknown, contact the RTD supplier for input. European (most common) = 0.00385 and American = 0.00392.

Units: Select Degrees C or F

Filtering: Three levels of first order noise filtering can be enabled during channel reading. First order filtering reduces high frequency noise that may be picked up by sensor wiring with the cost that it slows down the rate at which a channel can be sampled. See the OM-320 User's Manual Appendix for discussion on use of filtering.

AC Noise Reject: Enables software filtering of 50Hz or 60Hz noise on inputs. See the OM-320 User's Manual Appendix for an explanation of the 50/60 Hz filtering technique.

Change: Click on CHANGE to switch the icon / dialog box between thermistor, resistance, or RTD type input.

THERMISTOR INPUT ICON (HLIM-4)

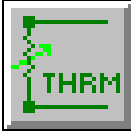

FUNCTION:

RTD, resistance, and thermistor signal inputs can all be handled with the HLIM-4. With the HLIM-4 installed in a OM-320, these respective function icons become available for use in Program Nets.

As a thermistor input, the icon samples the resistance of the connected thermistor, converts it to temperature and passes it along to the next icon. As thermistors have high ohm/C ratios, lead wire error is negligible and only the 2-wire configuration is supported. This channel/icon can be changed to an RTD or resistance input channel by selecting the **Change** button.

INPUTS:

- Hardware:** No signal input shown on icon for Program Net connections.
- Update:** The input is sampled every time an Update command is received on the Update input and the Enable terminal is True.
- Enable:** Processing of the icon is allowed when Enable pin is unconnected or connected *and* the Enable signal is TRUE.

OUTPUTS:

- Output Signal:** Data type signal. The Units of the output are degrees C, degrees F, or Ohms. This is software selectable from the icon configuration dialog box.

ICON CONFIGURATION DIALOG BOX:

Thermistor Input

Icon Name: Port 1, Ch C

Units:

- Celsius
- Fahrenheit

Range:

- 32 °C to 250 °C (-26 °F to 480 °F)
- 4 °C to 250 °C (25 °F to 480 °F)
- +10 °C to 250 °C (50 °F to 480 °F)
- +25 °C to 250 °C (77 °F to 480 °F)

Filtering:

- None
- Low
- Medium
- High

AC Noise Reject:

- None
- 50 Hz.
- 60 Hz.

Output Name:

Change OK Cancel Help

CONFIGURATION OPTIONS:

Icon Name: Specify the name for the channel. This name will show directly under the icon within the Program Net. If no name is User provided, the Backplane Port (1 to 6) and Channel (A to H) where the actual Interface Module channel is installed will be used for the name.

Output Name: Specify a name for the Output signal from this icon. This Output Name will be referenced by other icons downstream in the Program Net.

Range: Specify the input range to be used for this channel. For optimum resolution, choose the narrowest range that will meet the signal fluctuation without exceeding the Full Scale Range. If the input exceeds the selected range, an over-range value will be logged.

Units: Select Degrees C or F

Filtering: Three levels of first order noise filtering can be enabled during channel reading. First order filtering reduces high frequency noise that may be picked up by sensor wiring with the cost that it slows down the rate at which a channel can be sampled. See the OM-320 User's Manual Appendix for discussion on use of filtering.

AC Noise Reject: Enables software filtering of 50Hz or 60Hz noise on inputs. See the OM-320 User's Manual Appendix for an explanation of the 50/60 Hz filtering technique.

Change: Click on CHANGE to switch the icon / dialog box between thermistor, resistance, or RTD type input.

RESISTANCE INPUT ICON (HLIM-4)

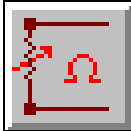

FUNCTION:

RTD, resistance, and thermistor signal inputs can all be handled with the HLIM-4. With the HLIM-4 installed in a OM-320, these respective function icons become available for use in Program Nets.

As a Resistance input, the icon samples the resistance connected to its input, and passes it along to the next icon. 2, 3, and 4-wire configurations are all supported.

This channel/icon can be changed to a thermistor or RTD input channel by selecting the **Change button**.

INPUTS:

- Hardware:** No signal input shown on icon for Program Net connections.
- Update:** The input is sampled every time an Update command is received on the Update input and the Enable terminal is True.
- Enable:** Processing of the icon is allowed when Enable pin is unconnected or connected *and* the Enable signal is TRUE.

OUTPUTS:

Output Signal: Data type signal. The Units of the output are Ohms.

ICON CONFIGURATION DIALOG BOX:

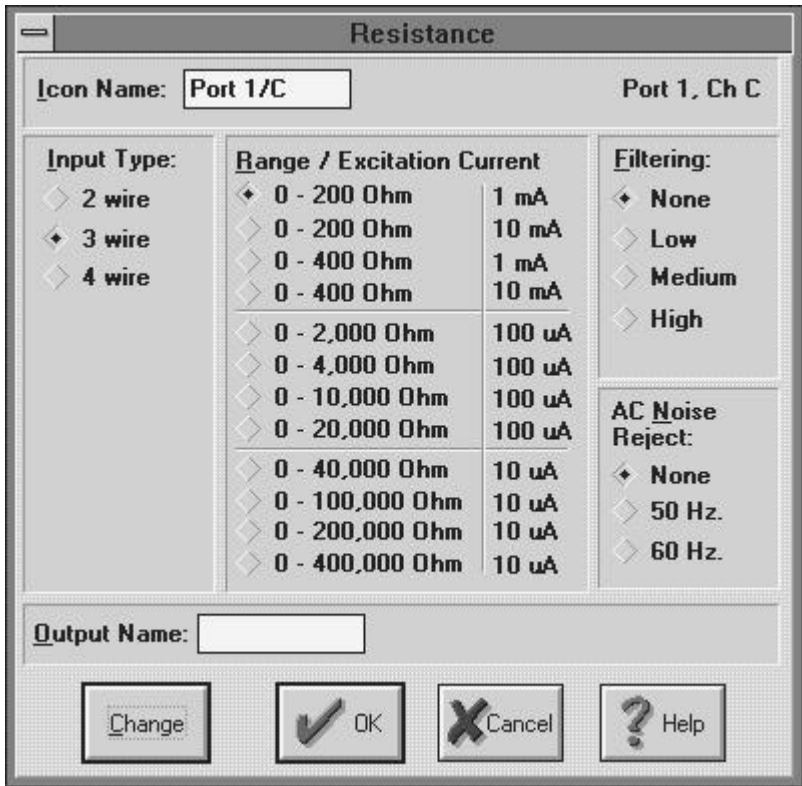

CONFIGURATION OPTIONS:

Icon Name: Specify the name for the channel. This name will show directly under the icon within the Program Net. If no name is User provided, the Backplane Port (1 to 6) and Channel (A to H) where the actual Interface Module channel is installed will be used for the name.

Output Name: Specify a name for the Output signal from this icon. This Output Name will be referenced by other icons downstream in the Program Net.

Input Type: Specifies the wiring configuration to be used.
2-Wire is typically used for measurements of higher resistance values or with short lead wire runs where the resistance of the lead wires induces negligible error. With 2-wire configuration, all four input channels can be used.
3 and 4-Wire configurations are used where the lead wires to the element are longer and/or premium measurement accuracy is required. Both 3 and 4-wire configurations compensate for the lead wire resistance. 3-wire provides nearly the same performance as 4-wire using only 3 wires instead of 4.
If 3 or 4-wire configuration is selected, the input requires two input channels. From within the A and C channel icons, selecting 3 or 4-wire will result in a displayed message that a second channel will be deleted (B or D).

Range: Specify the input range to be used for this channel. For optimum resolution, choose the narrowest range that will meet the signal fluctuation without exceeding the Full Scale Range. If the input exceeds the selected range, an over-range value will be logged.
For reference, the excitation currents used on the various ranges are documented. In cases where two identical ranges are provided, use the range with the higher current... unless self-heating or other ancillary effects are of concern.

Filtering: Three levels of first order noise filtering can be enabled during channel reading. First order filtering reduces high frequency noise that may be picked up by sensor wiring with the cost that it slows down the rate at which a channel can be sampled. See the OM-320 User's Manual Appendix for discussion on use of filtering.

AC Noise Reject: Enables software filtering of 50Hz or 60Hz noise on inputs. See the OM-320 User's Manual Appendix for an explanation of the 50/60 Hz filtering technique.

Change: Click on CHANGE to switch the icon / dialog box between thermistor, resistance, or RTD type input.

EVENT INPUT ICON (GPDI)

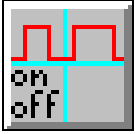

FUNCTION:

The GPDI (General Purpose Digital Input) is a hardware digital input for Event and Counter applications. It is incorporated into every OM-320 System Base.

As an EVENT input, it samples the input signal state (High or Low) per the sampling rate set on the Update input. It updates its output only when the input changes state.

INPUTS:

Hardware: No signal input shown on Net for Program Net connections.

Update: The input is sampled every time an Update command is received on the Update input. If the input state has changed since the last Update command was received, the Output is updated with the new state. The absolute time resolution of the state change is determined by the frequency of the Update signal. For example, if an Update command is received every second, the state change will be recorded with one second resolution.

Enable: Processing of the icon is allowed when Enable pin is unconnected or connected *and* the Enable signal is TRUE.

OUTPUTS:

Output Signal: Logic type signal

ICON CONFIGURATION DIALOG BOX:

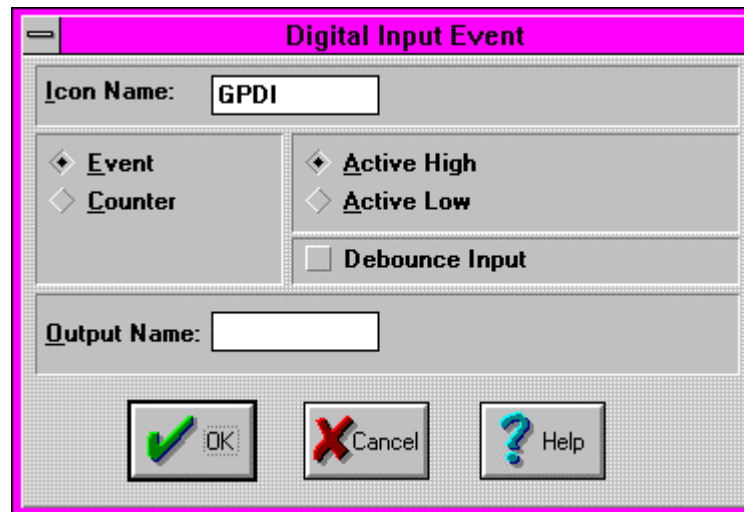

CONFIGURATION OPTIONS:

Icon Name: Specify the name for the channel. This name will show directly under the icon within the Program Net. If no name is User provided, the Backplane Port (1 to 6) and Channel (A to D) where the actual Interface Module channel is installed will be used for the name.

Output Name: Specify a name for the Output signal from this icon. This Output Name will be referenced by other icons downstream in the Program Net.

Event / Counter Select EVENT for the Event function.

Debounce: Enables a hardware filter circuit that prevents short duration transitions from passing into the icon. Debounce can be used to filter out contact bounce from mechanical switches. The GPDI Debounce has a time

11.. . APPENDIX A: MASTER ICON FILE REFERENCE

constant of approximately 50mS. Note that the use of Debounce will delay the actual input to output time by 50 to 200 mS.

FYI: *Contact bounce is a phenomenon that occurs when a mechanical switch opens or closes. During switching, the physical electrical contacts inside the switch bounce against each other a number of times before they settle to their final state.*

Depending on the duty cycle of the contact bounce, the OM-320 may count these bounces as events or transitions (count mode) resulting in technically accurate but undesired data. By enabling the debounce function, typical short duration contact bounce will be filtered out.

Output True when input is LOW / HIGH: Specify what the state of the input signal is for the icon Output to be True. For example, if a switch is connected to the Event icon input, the User can then specify which state the switch should be in for a TRUE Output from the Event icon. *Output True when input is LOW* will result in an icon Output that is TRUE when the switch is closed. *Output True when input is TRUE* will result in an icon Output that is True when the switch is open.

COUNTER INPUT ICON (GPDI)

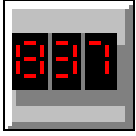

FUNCTION:

The GPDI (General Purpose Digital Input) is a hardware digital input for Event and Counter applications and is incorporated into every OM-320 System Base.

As a COUNTER input, it accumulates counts from a User connected hardware signal input, then outputs the count when it receives an Update command. When the count is output, the counter is automatically set back to 0 and counting resumes.

The GPDI Counter (in contrast to the HLIM-2 Counter) is very fast and can count pulses received at input rates up to 10 KHZ. However, when using the GPDI Counter with high speed inputs, it is imperative that the Counter receive an Update command before it counts up to 65,535 or a counter roll-over condition will occur and count data will be lost.

INPUTS:

Hardware: No signal input shown on Net for Program Net connections.

Update: The accumulated count is output every time an Update command is received on the Update input. To preclude the loss of data, this Update command should be received before the icon counts to 65,535 or the counter will roll-over to 0 and continue counting, resulting in lost counts.

Enable: Processing of the icon is allowed when Enable pin is unconnected or connected *and* the Enable signal is TRUE.

OUTPUTS:

Output Signal: Data type signal (ie Count totals)

ICON CONFIGURATION DIALOG BOX:

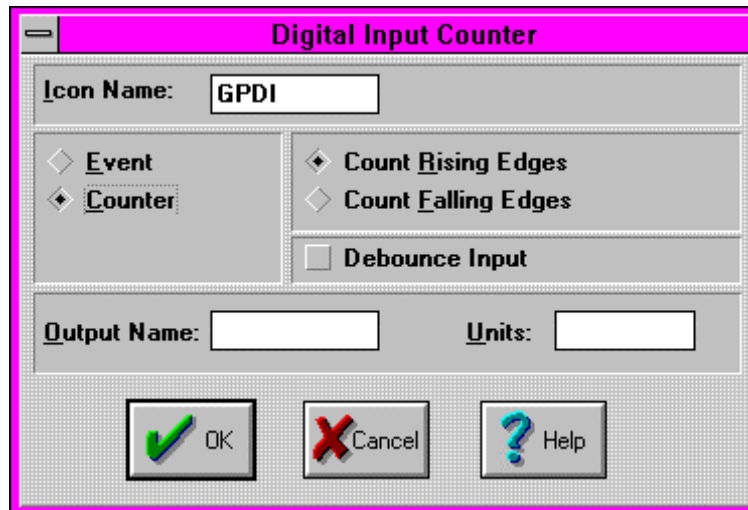

CONFIGURATION OPTIONS:

Icon Name: Specify the name for the channel. This name will show directly under the icon within the Program Net. If no name is User provided, the Backplane Port (1 to 6) and Channel (A to D) where the actual Interface Module channel is installed will be used for the name.

Output Name: Specify a name for the Output signal from this icon. This Output Name will be referenced by other icons downstream in the Program Net.

Event / Counter Select COUNTER for the Counter function.

11.. . APPENDIX A: MASTER ICON FILE REFERENCE

Debounce: Enables a hardware filter circuit that prevents short duration transitions from passing into the icon. Debounce can be used to filter out contact bounce from mechanical switches. The GPDI Debounce has a time constant of approximately 50mS. Debounce should not be used when counting signals of frequency higher than 10Hz or signals with On or Off durations shorter than approximately 100mS.

***FYI:** Contact bounce is a phenomenon that occurs when a mechanical switch opens or closes. During switching, the physical electrical contacts inside the switch bounce against each other a number of times before they settle to their final state.*

Depending on the duty cycle of the contact bounce, the OM-320 may count these bounces as events or transitions (count mode) resulting in technically accurate but undesired data. By enabling the debounce function, typical short duration contact bounce will be filtered out.

Count Rising / Falling Edges: The GPDI increments its accumulated count when its input changes state from hi to lo or lo to hi. The User can specify which transition (edge) is to be counted Rising (lo to hi) or Falling (hi to lo). For example if a switch is connected to the input, the User can specify that the count increment when the switch closes (Falling Edge) or when it opens (Rising Edge).

EVENT INPUT ICON (DIGITAL I/O WITH HLIM-2)

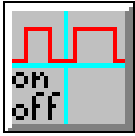

FUNCTION:

An Event / Counter / Frequency input and Digital output functions are all provided with the HLIM-2. Four channels can be configured on an individual basis as Frequency, Event, or Counter type Inputs and four separate channels are available for Digital Output. With the HLIM-2 installed in a OM-320, these respective function icons become available for use in Program Nets.

As an EVENT input, the icon samples the state of the User connected hardware input signal (HI or LO) each time an Update command is received. The icon output state is updated when the input state changes.

The same dialog is used to configure the channel for Event, Frequency, and Counter functions.

INPUTS:

Hardware: No signal input shown on icon for Program Net connections.

Update: The input is sampled every time an Update command is received on the Update input. If the input state has changed since the last Update command was received, the Output is updated with the new state. The absolute time resolution of the state change is determined by the frequency of the Update command. For example, if an Update command is received every second, the state change will be recorded with one second resolution.

Enable: Processing of the icon is allowed when Enable pin is unconnected or connected *and* the Enable signal is TRUE.

OUTPUTS:

Output Signal: Logic type signal

ICON CONFIGURATION DIALOG BOX:

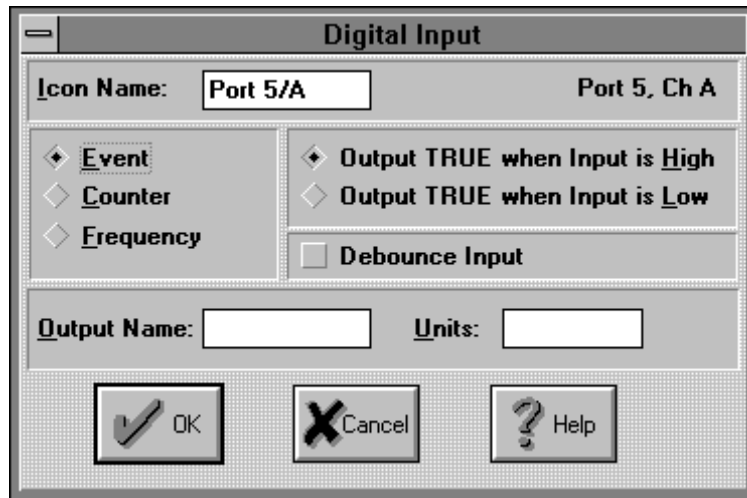

CONFIGURATION OPTIONS:

Icon Name: Specify the name for the channel. This name will show directly under the icon within the Program Net. If no name is User provided, the Backplane Port (1 to 6) and Channel (A to D) where the actual Interface Module channel is installed will be used for the name.

11.. . APPENDIX A: MASTER ICON FILE REFERENCE

Output Name: Specify a name for the Output signal from this icon. This Output Name will be referenced by other icons downstream in the Program Net.

Units: Provides a text box for User entry of a units label that will be shown at the output from this icon. Conversion to other units can be performed within a Program Net by adding a Math Icon onto this icon's output.

Event / Counter / Frequency Select EVENT for the Event function.

Debounce: Enables a hardware filter circuit that prevents short duration transitions from passing into the icon. Debounce can be used to filter out contact bounce from mechanical switches. The HLIM-2 Debounce has a time constant of approximately 50mS. Note that the use of Debounce will delay the actual input to output transition time by 50 to 200 mS.

***FYI:** Contact bounce is a phenomenon that occurs when a mechanical switch opens or closes. During switching, the physical electrical contacts inside the switch bounce against each other a number of times before they settle to their final state.*

Depending on the duty cycle of the contact bounce, the OM-320 may count these bounces as events or transitions (count mode) resulting in technically accurate but undesired data. By enabling the debounce function, typical short duration contact bounce will be filtered out.

Output TRUE when Input is HIGH / LOW: Allows logical reversal of the Output with respect to the input state.

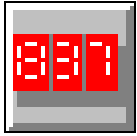

COUNTER INPUT ICON (DIGITAL I/O WITH HLIM-2)

FUNCTION:

Event / Counter / Frequency input and Digital output functions are all provided with the HLIM-2. With the HLIM-2 installed in a OM-320, these respective function icons become available for use in Program Nets.

The same dialog is used to configure the four input channels for Event, Frequency, and Counter functions.

As a COUNTER input, the HLIM-2 channel accumulates counts from a User connected hardware signal input, then outputs the count to the net when it receives an Update command. When the count is output, the counter is automatically set back to 0 and counting resumes.

The HLIM-2 Counter can count pulses received at input rates up to apx 20 Khz. However, at higher frequencies, the net must be configured to read the counter before it overflows or the counter will overflow and return to 0 and continue incrementing.

INPUTS:

Hardware: No signal input shown on Net for Program Net connections. The HLIM-2 Counter function increments its count on received rising or falling edges of the input signal.

Update: The accumulated count is output every time an Update command is received on the Update input. To preclude the loss of data, this Update command (from a connected Sample Rate Clock) should be received before the icon counts to 16,777,216 or the counter will roll-over to 0 and continue counting, resulting in lost counts.

Enable: Processing of the icon is allowed when Enable pin is unconnected or connected *and* the Enable signal is TRUE.

OUTPUTS:

Output Signal: Data type signal (ie Count totals)

ICON CONFIGURATION DIALOG BOX:

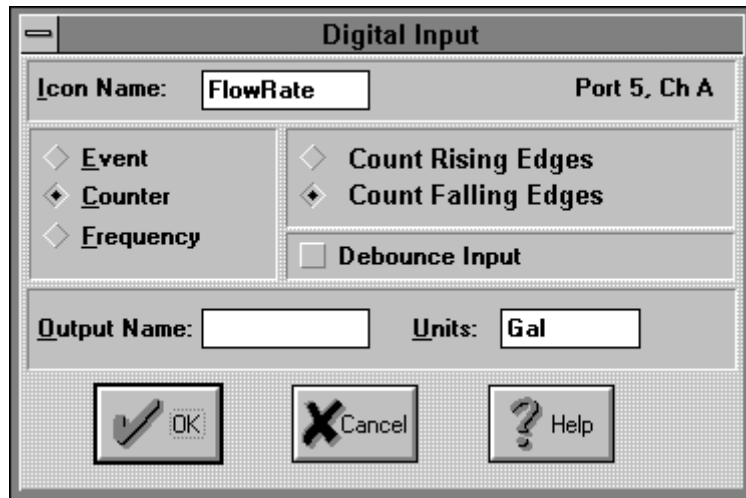

CONFIGURATION OPTIONS:

Icon Name: Specify the name for the channel. This name will show directly under the icon within the Program Net. If no name is User provided, the Backplane

11.. . APPENDIX A: MASTER ICON FILE REFERENCE

Port (1 to 6) and Channel (A to D) where the actual Interface Module channel is installed will be used for the name.

Output Name: Specify a name for the Output signal from this icon. This Output Name will be referenced by other icons downstream in the Program Net.

Units: Provides a text box for User entry of a units label that will be shown at the output from this icon. Conversion to other units can be performed within a Program Net by adding a Math Icon onto this icon's output.

Event / Counter / Frequency Select COUNTER for the Counter function.

Debounce: Enables a hardware filter circuit that prevents short duration transitions from passing into the icon. Debounce can be used to filter out contact bounce from mechanical switches. The HLIM-2 Debounce has a time constant of approximately 50mS. Note that the use of Debounce will delay the actual input to output transition time by 50 to 200 mS.

***FYI:** Contact bounce is a phenomenon that occurs when a mechanical switch opens or closes. During switching, the physical electrical contacts inside the switch bounce against each other a number of times before they settle to their final state.*

Depending on the duty cycle of the contact bounce, the OM-320 may count these bounces as events or transitions (count mode) resulting in technically accurate but undesired data. By enabling the debounce function, typical short duration contact bounce will be filtered out.

Count Rising / Falling edges: Specify which edge of the input signal is to be used to increment the counter (eg when a device being monitored turns ON or OFF).

FREQUENCY INPUT ICON (DIGITAL I/O WITH HLIM-2)

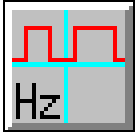

FUNCTION:

Event / Counter / Frequency input and Digital output functions are all provided with the HLIM-2. With the HLIM-2 installed in a OM-320, these respective function icons become available for use in Program Nets.

The same dialog is used to configure the channel for Event, Frequency, and Counter functions.

As a FREQUENCY input, the HLIM-2 channel samples the incoming waveform and outputs the measured frequency to the net.

Calculation of the input signal frequency requires longer for lower frequencies. Due to this effect, the speed of execution of a Program Net may be reduced when reading low frequency inputs. (eg 10Hz inputs will require approximately 100mS to read, whereas a 100Hz input will require only 10mS)

NOTE: Due to the advanced signal processing utilized in the frequency mode, unbalanced duty-cycle inputs are measured with the same accuracy as balanced duty-cycle inputs.

INPUTS:

Hardware: No signal input shown on Net for Program Net connections.

Update: The measured frequency is output every time an Update command is received on the Update input.

Enable: Processing of the icon is allowed when Enable pin is unconnected or connected *and* the Enable signal is TRUE.

OUTPUTS:

Output Signal: Data type signal, Frequency in Hz.

ICON CONFIGURATION DIALOG BOX:

CONFIGURATION OPTIONS:

Icon Name: Specify the name for the channel. This name will show directly under the icon within the Program Net. If no name is User provided, the Backplane Port (1 to 6) and Channel (A to D) where the actual Interface Module channel is installed will be used for the name.

Output Name: Specify a name for the Output signal from this icon. This Output Name will be referenced by other icons downstream in the Program Net.

11.. . APPENDIX A: MASTER ICON FILE REFERENCE

- Units:** Provides a text box for User entry of a units label that will be shown at the output from this icon. Conversion to other units can be performed within a Program Net by adding a Math Icon onto this icon's output.
- Event / Counter / Frequency** Select FREQUENCY for the Frequency function.

EVENT INPUT ICON (DIGITAL I/O WITH HLIM-8)

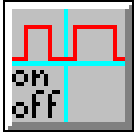

FUNCTION:

Event input and Digital output functions are all provided with the HLIM-8. With the HLIM-8 installed in a OM-320, these respective function icons become available for use in Program Nets.

As an EVENT input, the icon samples the state of the User connected hardware input signal (HI or LO) each time an Update command is received. The icon output state is updated when the input state changes.

This channel/icon can be changed to a Digital Output channel by selecting the Change this channel to an Output button.

INPUTS:

Hardware: No signal input shown on icon for Program Net connections.

Update: The input is sampled every time an Update command is received on the Update input. If the input state has changed since the last Update command was received, the Output is updated with the new state. The absolute time resolution of the state change is determined by the frequency of the Update command. For example, if an Update command is received every second, the state change will be recorded with one second resolution.

Enable: Processing of the icon is allowed when Enable pin is unconnected or connected *and* the Enable signal is TRUE.

OUTPUTS:

Output Signal: Logic type signal

ICON CONFIGURATION DIALOG BOX:

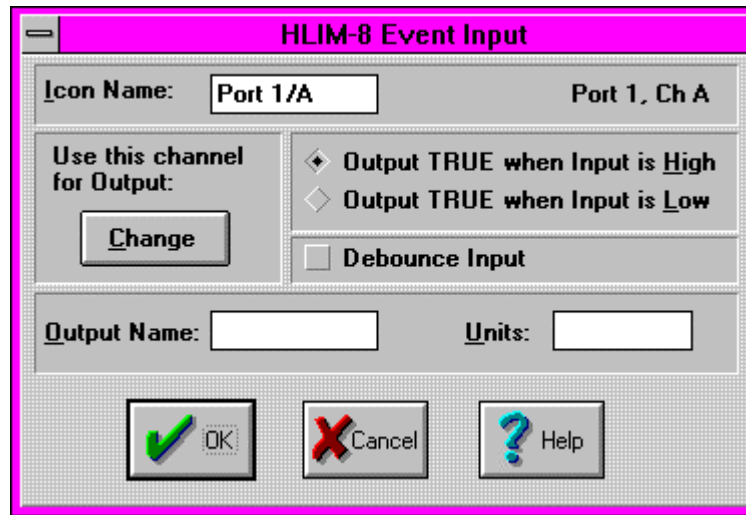

CONFIGURATION OPTIONS:

Icon Name: Specify the name for the channel. This name will show directly under the icon within the Program Net. If no name is User provided, the Backplane Port (1 to 6) and Channel (A to H) where the actual Interface Module channel is installed will be used for the name.

11.. . APPENDIX A: MASTER ICON FILE REFERENCE

- Output Name:** Specify a name for the Output signal from this icon. This Output Name will be referenced by other icons downstream in the Program Net.
- Units:** Provides a text box for User entry of a units label that will be shown at the output from this icon. Conversion to other units can be performed within a Program Net by adding a Math Icon onto this icon's output.
- Debounce:** Enables a hardware filter circuit that prevents short duration transitions from passing into the icon. Debounce can be used to filter out contact bounce from mechanical switches. The HLIM-8 Debounce has a time constant of approximately 50mS. Note that the use of Debounce will delay the actual input to output transition time by 50 to 100 mS.

***FYI:** Contact bounce is a phenomenon that occurs when a mechanical switch opens or closes. During switching, the physical electrical contacts inside the switch bounce against each other a number of times before they settle to their final state.*

Depending on the duty cycle of the contact bounce, the OM-320 may count these bounces as events resulting in technically accurate but undesired data. By enabling the debounce function, typical short duration contact bounce will be filtered out.

- Change This Channel to an Output:** Not applicable when using this channel as an Event input. To change this channel to an Output, click on the Change button.

DIGITAL OUTPUT ICON (HLIM-8)

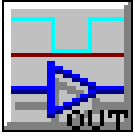

FUNCTION:

Eight channels of Digital output or Event input are all provided with the HLIM-8. With the HLIM-8 installed in a OM-320, these respective function icons become available for use in Program Nets. (Click on the CHANGE button within the Event dialog to switch the channel's icon function to a Digital Output).

The Digital Output icons provide software access to these digital outputs.

This channel/icon can be changed from a Digital Output to an Event Input channel by clicking on the CHANGE button.

INPUTS:

Data/Logic Signal: Logic type. True input turns hardware output ON. False input turns output OFF. Optionally, use the Latch icon in front of the Digital Output icon to latch the Output True upon receipt of a momentary True input.

Update Clock: None

Enable: Processing of icon is allowed when Enable pin is unconnected or connected *and* Enable signal is TRUE.

OUTPUTS:

Output Signal: Hardware output only. No output terminal shown on icon for Program Net connections.

ICON CONFIGURATION DIALOG BOX:

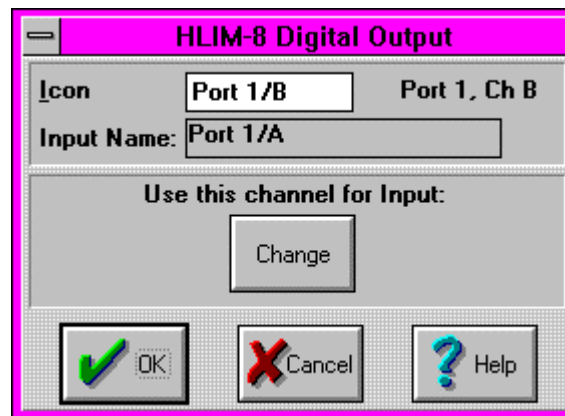

CONFIGURATION OPTIONS:

Icon Name: Specify the name for the channel. This name will show directly under the icon within the Program Net. If no name is User provided, the Backplane Port (1 to 6) and Channel (A to D) where the actual Interface Module channel is installed will be used for the name.

Input Name: In this box, HyperNet displays the Output Name of the icon connected to this icon's Input. The Output Name can be changed in the other icon's dialog.

Use this channel for Input: Select CHANGE to switch this icon into an Event type Input icon.

DIGITAL ALARM OUTPUT ICON

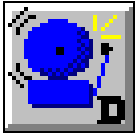

FUNCTION:

Three Digital Alarm outputs are provided as an integral part of the OM-320 System Base. The Digital Alarm icons provide software access to these alarm outputs.

INPUTS:

Data/Logic Signal: Logic type. True input turns Alarm ON. LOW input turns Alarm OFF. Optionally, use the Latch icon in front of the icon to latch the Alarm ON with a momentary True input.

Update Clock: None

Enable: None

OUTPUTS:

Output Signal: Hardware output only. No output terminal shown on icon for Program Net connections.

ICON CONFIGURATION DIALOG BOX:

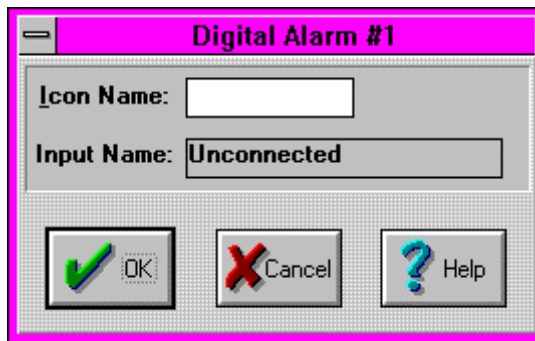

CONFIGURATION OPTIONS:

Icon Name: Specify the label for the icon. This name will show directly under the icon within the Program Net.

Input Name: In this box, HyperNet displays the Output Name of the icon connected to this icon's Input. The Output Name can be changed in the other icon's dialog.

RELAY ALARM OUTPUT ICON

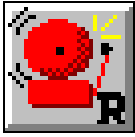

FUNCTION:

Two Relay Alarm outputs are provided as an integral part of the OM-320 System Base. The Relay Alarm icons provide software access to these alarm outputs.

INPUTS:

Input Signal: Logic type. True input turns Alarm ON. False input turns Alarm OFF. Optionally, use the Latch icon in front of the icon to latch the Alarm ON with a momentary True input.

Update Clock: None

Enable: None

OUTPUTS:

Output Signal: Hardware output only. No output terminal shown on icon for Program Net connections.

ICON CONFIGURATION DIALOG BOX:

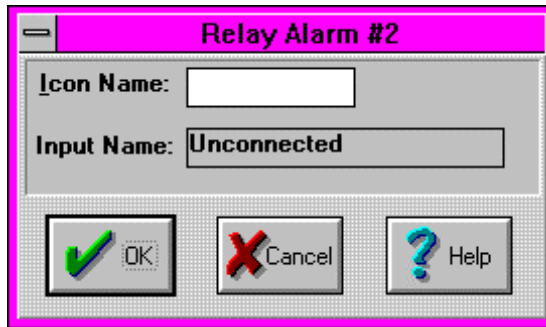

CONFIGURATION OPTIONS:

Icon Name: Specify the label for the icon. This name will show directly under the icon within the Program Net.

Input Name: In this box, HyperNet displays the Output Name of the icon connected to this icon's Input. The Output Name can be changed in the other icon's dialog.

GREEN LED STATUS OUTPUT ICON

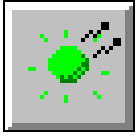

FUNCTION:

A Green LED (light emitting diode) is provided as an integral part of the OM-320 System Base and displays on the front panel of the OM-320. The Green LED icon provides software access to this Status output.

INPUTS:

Data/Logic Signal: Logic type. True input turns LED ON. False input turns LED OFF. Optionally, use the Latch icon in front of the icon to latch the LED ON with a momentary True input.

Update Clock: None

Enable: None

OUTPUTS:

Output Signal: Hardware output (LED) only. No output terminal shown on icon for Program Net connections.

ICON CONFIGURATION DIALOG BOX:

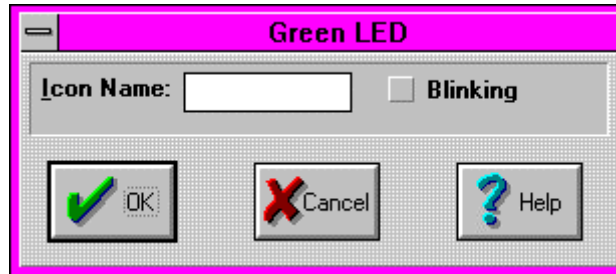

CONFIGURATION OPTIONS:

Icon Name: Specify the label for the icon. This name will show directly under the icon within the Program Net.

Blinking: If the Blinking check box is checked, the LED will blink at a rate of 1 second ON, 1 second OFF when the input is True. If not checked, the LED will be ON continuously when the input is True.

LCD MESSAGE OUTPUT ICON

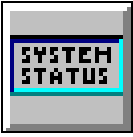

FUNCTION:

User programmed messages can be displayed on the LCD (liquid crystal display) on the front panel of the OM-320 System Base. The LCD Message icon provides for User entry of a two-line message for display when the icon input is TRUE.

INPUTS:

Data/Logic Signal: Logic type. True input turns message ON. False input turns message display OFF. Optionally, use the Latch icon in front of the LCD Message icon to latch the message ON upon receipt of a momentary True input.

Update Clock: None

Enable: Processing of icon is allowed when Enable pin is unconnected or when connected *and* Enable signal is TRUE.

OUTPUTS:

Output Signal: Hardware output (to LCD display) only. No output terminal shown on icon for Program Net connections.

ICON CONFIGURATION DIALOG BOX:

CONFIGURATION OPTIONS:

Icon Name: Specify the label for the icon. This name will show directly under the icon within the Program Net.

First / Second Line Output: Two text boxes are provided for User entry of text to be displayed on the LCD when the Input is TRUE. Up to 16 characters can be entered on each line.

APPLICATION CONSIDERATIONS:

When the LCD icon is activated (ie its input is TRUE), the programmed message is displayed on the OM-320 LCD. If a second (different) message is activated the second message will be displayed on the LCD and the first message will be maintained on a queue of active messages. This queue of messages can be reviewed via the OM-320 front panel Next / Select buttons menu *Display Status Messages* or via a *Status Query* from within the HyperComm Window.

DIGITAL OUTPUT ICON (HLIM-2)

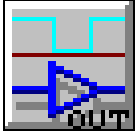

FUNCTION:

Four channels of Digital output are provided (along with 4 channels of Event / Counter/ and Frequency input) with the HLIM-2. With the HLIM-2 installed in a OM-320, these respective function icons become available for use in Program Nets.

The Digital Output icons provide software access to these digital outputs.

Refer to the Frequency, Counter and/or Event applications of the HLIM-2 for further information on those functions.

INPUTS:

Data/Logic Signal: Logic type. True input turns hardware output ON. False input turns output OFF. Optionally, use the Latch icon in front of the Digital Output icon to latch the Output True upon receipt of a momentary True input.

Update Clock: None

Enable: Processing of icon is allowed when Enable pin is unconnected or connected *and* Enable signal is TRUE.

OUTPUTS:

Output Signal: Hardware output only. No output terminal shown on icon for Program Net connections.

ICON CONFIGURATION DIALOG BOX:

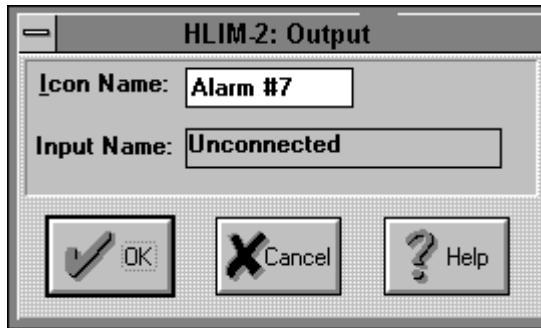

CONFIGURATION OPTIONS:

Icon Name: Specify the name for the channel. This name will show directly under the icon within the Program Net. If no name is User provided, the Backplane Port (1 to 6) and Channel (A to D) where the actual Interface Module channel is installed will be used for the name.

Input Name: In this box, HyperNet displays the Output Name of the icon connected to this icon's Input. The Output Name can be changed in the other icon's dialog.

PAGER CALL-OUT ICON

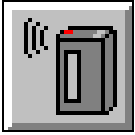

FUNCTION:

In OM-320s equipped with a telephone modem option, the Pager Call-Out icon can be used to dial a pager phone number, wait a User defined period of time (for the Paging service tone), then transmit a User assigned code number. This code number can be User assigned to represent a site and/or particular warning or status indication.

INPUTS:

Data/Logic Signal: Logic type. A FALSE to TRUE transition on the icon input initiates the Pager call. The Page will complete even if the input signal returns LOW.

Update Clock: None

Enable: Processing of icon is allowed when Enable pin is unconnected or connected *and* Enable signal is TRUE.

OUTPUTS:

Output Signal: Hardware output to installed modem. No output terminal shown on icon for Program Net connections.

ICON CONFIGURATION DIALOG BOX:

CONFIGURATION OPTIONS:

Icon Name: Specify the name for the channel. This name will show directly under the icon within the Program Net.

Input Name: In this box, HyperNet displays the Output Name of the icon connected to this icon's Input. The Output Name can be changed in the other icon's dialog.

Pager Phone Number: Enter the telephone number to dial to gain access to the pager; optionally followed by a number of commas (each which represents a 2 second delay) followed by the code number to be sent to the pager display.

For example: **(619) 555-1212,,,,,9999** entered in this text box will result in:

1. When the Pager icon is activated, the OM-320 will dial the phone number (619)555-1212. Parenthesis and hyphens are ignored.
2. Wait for a 10 second delay (5 commas @ 2 seconds each)

11.. . APPENDIX A: MASTER ICON FILE REFERENCE

3. The code number 9999 will be sent to the pager
4. The OM-320 modem will disconnect.

The commas are entered to insert a delay between the dialing of the pager and the sending of the code. The delay time should be determined by the User to meet the subscribed pager system timing requirements. This delay can be determined empirically by calling the pager with a telephone and manually timing the delay between the last number dial and the tone indicating when a pager code should be entered. To allow for variations in this delay time, a few extra seconds (one or two commas) can be added to insure that the tone is received before the pager code is sent.

NOTE: The OM-320 does not detect a busy line or pager tone, it merely executes the sequence of numbers and commas defined in this text box. The Pager call-out function and associated timing should be tested prior to field application.

Number of times to repeat page: If a number other than 0 is entered in this box, the Pager icon will will repeat the dialing sequence the specified number of times.

Number of seconds between retries: Enter the time to wait(in seconds) before a repeat call is placed.

APPLICATION CONSIDERATIONS:

Multiple Pager icons can be used in a Program Net, each connected to a different status or warning function. Different pager phone numbers and/or codes can then be assigned to indicate different status or warning conditons.



PROBE POINT OUTPUT ICON

FUNCTION:

Probe Point Icons mark and provide access to nodes within a Program Net for:

1. The OM-320 front panel display while the Net is executing. Values at the nodes can be accessed through the **Display Probe Icon Values** LCD menu selection
2. Use during real-time HyperTrack sessions. Nodes marked with Probe Point icons are accessible via the serial link.

The units displayed by a Probe Point icon is inherited from the output to which it is connected. These units will appear on the LCD display as well as when the Probe Point is used in a HyperTrack Net.

INPUTS:

Data/Logic Signal: Data or Logic type. The terminal will accept either signal type.

Update Clock: None

Enable: Processing of icon is allowed when Enable pin is unconnected or when connected *and* Enable signal is TRUE.

OUTPUTS:

Output Signal: Hardware output (to LCD display and/or serial link) only. No output terminal shown on icon for Program Net connections.

ICON CONFIGURATION DIALOG BOX:

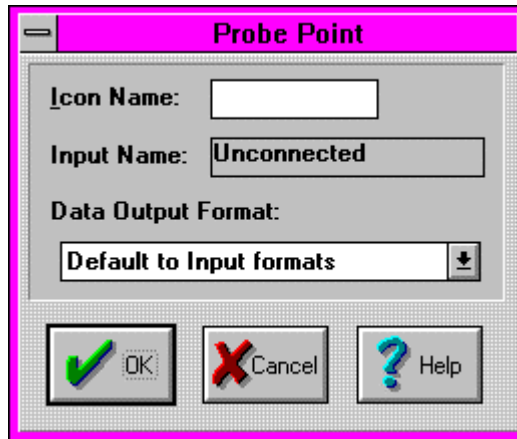

CONFIGURATION OPTIONS:

Icon Name: Specify the label for the icon. This name will show directly under the icon within the Program Net.

Input Name: In this box, HyperNet displays the Output Name of the icon connected to this icon's Input. The Output Name can be changed in the other icon's dialog.

Data Output Format: The User can specify the data format that will be used in Output of the signal. In certain applications, additional processing speed may be realized through a judicious selection of the format.

Default to Input Formats - the default format. The data will be output using the same data format (Floating Point or Long Integer) as the Inputs use. This selection can be used consistently with good speed performance and no loss of precision.

11.. . APPENDIX A: MASTER ICON FILE REFERENCE

Long Integer - The Input data will be converted to signed integer format, then output. Signed Integer format includes only the digits to the left of the decimal (XXXXX.)

The advantage of using Long Integer format is that this format will generally consist of a fewer number of bytes, hence serial transmission of the data for HyperTrack will be slightly faster. The number of bytes will dynamically size, from 1 to 4 bytes, according to the magnitude of the Output.

The disadvantage of Long Integer format is that numerical precision will be lost if incoming data is in floating point format. Precision will be lost in the conversion to integer format (eg 26.3 becomes 26). If large numbers are processed, this loss of precision may be negligible (eg 36785.2 becomes 36785).

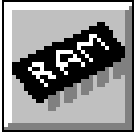

MEMORY (OM-320) ICON

FUNCTION:

The Memory icon represents data memory within the OM-320 System Base (either internal or a PCMCIA memory card if installed).

The Units associated with the icon Output connected to the Memory icon Input will be stored with the recorded values.

INPUTS:

Data/Logic Signal: Data or Logic type. The terminal will accept either signal type.

Update Clock: None

Enable: Processing of icon is allowed when Enable pin is unconnected or when connected *and* Enable signal is TRUE.

OUTPUTS:

Output Signal: Hardware output to memory only. No output terminal shown on icon for Program Net connections.

ICON CONFIGURATION DIALOG BOX:

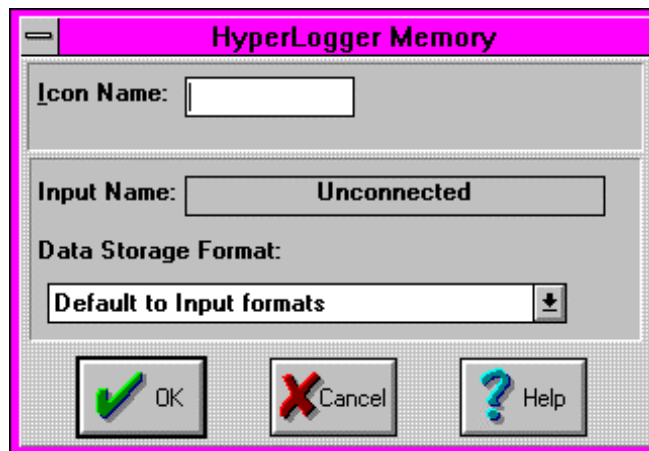

CONFIGURATION OPTIONS:

Icon Name: Specify the label for the icon. This name will show directly under the icon within the Program Net.

Input Name: In this box, HyperNet displays the Output Name of the icon connected to this icon's Input. The Output Name can be changed in the other icon's dialog.

Data Storage Format: The User can specify the data format that will be used to store the data in memory. In certain applications, additional processing speed and/or less memory per stored sample can be realized through a judicious selection of the format.

Default to Input Formats - the default format. The data will be stored using the same data format (Floating Point or Long Integer) as the Inputs use. This selection can be used consistently with good speed performance and no loss of precision.

Long Integer - The Input data will be converted to integer format, then the data will be stored to memory in a signed Integer format. Signed Integer format includes only the digits to the left of the decimal (XXXXX.)

11.. . APPENDIX A: MASTER ICON FILE REFERENCE

The advantage of using Long Integer format is that this format will generally utilize a fewer number of memory bytes for data storage. The number of bytes will dynamically size, from 1 to 4 bytes, according to the magnitude of the Output.

The disadvantage of Long Integer format is that numerical precision will be lost if incoming data is in floating point format. Precision will be lost in the conversion to integer format (eg 26.3 becomes 26). If large numbers are processed, this loss of precision may be negligible (eg 36785.2 becomes 36785).

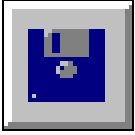

DESTINATION FILE ICON

FUNCTION:

The Destination File icon represents a file on disk within the PC. This icon can be used as a destination file for data processed through a HyperTrack session and for file to file conversions from within the Post-Processing window.

The Units associated with the Output terminal of the icon which is connected to the Destination File icon Input will be stored with the recorded values.

INPUTS:

Data/Logic Signal: Data or Logic type. The terminal will accept either signal type.

Update Clock: None

Enable: None

OUTPUTS:

Output Signal: Hardware output to file on disk only. No output terminal shown on icon for Program Net connections.

ICON CONFIGURATION DIALOG BOX:

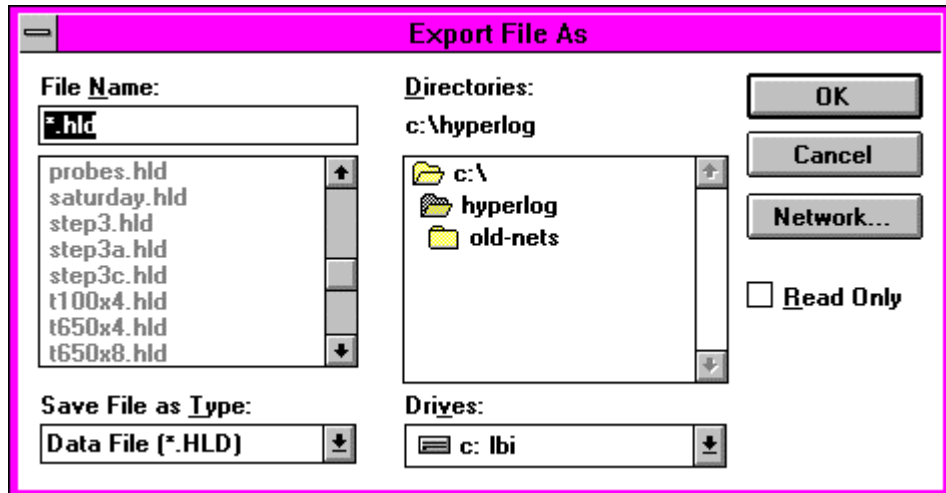

CONFIGURATION OPTIONS:

The standard Windows File Save dialog box format is used during the configuration of the Destination File icon. Conventional Windows commands are used to specify the destination path and filename.

Save File as Type: Specify the file type (and extension) to be used. Three file types are supported as follows:

*.**HLD** - This format is the standard OM-320 Download file format. HyperPlot uses this file format.

*.**TXT** - An ASCII file format that can be viewed with any text type editor or wordprocessor such as Notepad (for smaller files).

*.**XLS** - The Excel spreadsheet file format.

REAL-TIME SCROLLING DISPLAY Icon

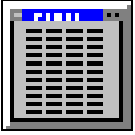

FUNCTION:

The Real-Time Scrolling Display icon represents the HyperTrack Scrolling Display Window in which real-time data values from a OM-320 are displayed. The Real-Time Scrolling Display icon is used from within the HyperTrack Window during construction of a HyperTrack Net.

The Units associated with the Output terminal of the icon which is connected to the Data File icon Input will be stored with the recorded values.

Double clicking on the icon opens the HyperTrack Scrolling Display Window.

INPUTS:

Data/Logic Signal: Up to eight Data or Logic type. The terminal will accept either signal type. As connections are added to the icon, additional terminals appear, up to a total of 8 channels.

Update Clock: None

Enable: None

OUTPUTS:

Output Signal: No output terminal shown on icon for Program Net connections.

ICON CONFIGURATION DIALOG BOX:

No Icon Configuration Dialog is available for this icon. Double clicking on the icon opens the HyperTrack Scrolling Display Window.

CONFIGURATION OPTIONS:

No Configuration Options are available.

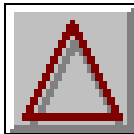

DELTA FUNCTION ICON

FUNCTION:

The Delta icon provides a special data processing function that can be used in a Program Net to drastically reduce the number of data samples required to profile an analog signal. The Delta icon only passes data from input to output when the input signal differs from the last passed sample by more than a User defined amount, ie the 'delta' value.

When logging data that has periods of relatively stable values mixed with occassional dynamic fluctuations, the Delta icon can reduce the amount of data samples required to profile the curve with a minimum of accuracy compromise.

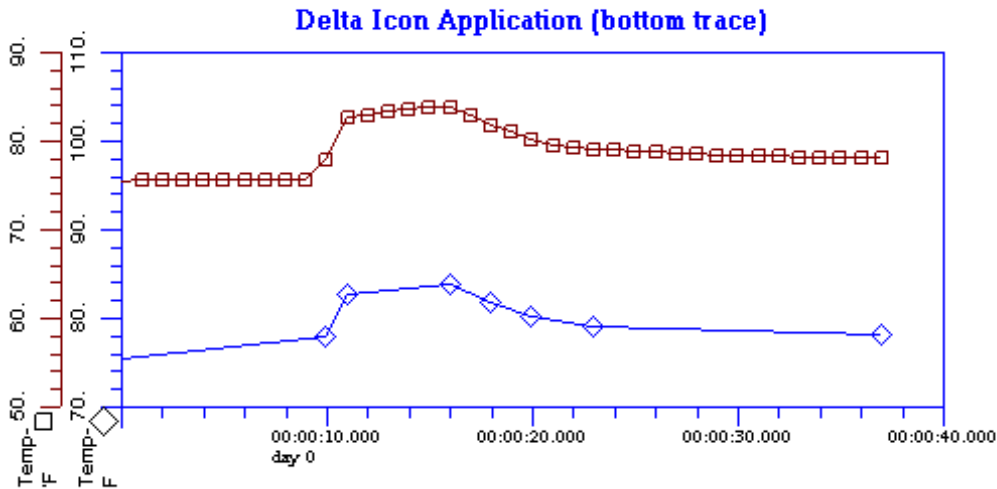

The data plotted above demonstrates the reduction of data points that is possible with the Delta icon. The Program Net shown below was developed with a Delta icon programmed with a Delta value of 1 degree F. Temperature data was then collected over a few seconds while the temperature sensor was warmed and then allowed to cool. As can be seen, the curve profiles do reflect slight differences (1 degree F maximum deviation), however the number of data samples used is radically reduced with the Delta icon data. (Note that the curves are displayed with the same temperature scaling but are merely offset for viewing.)

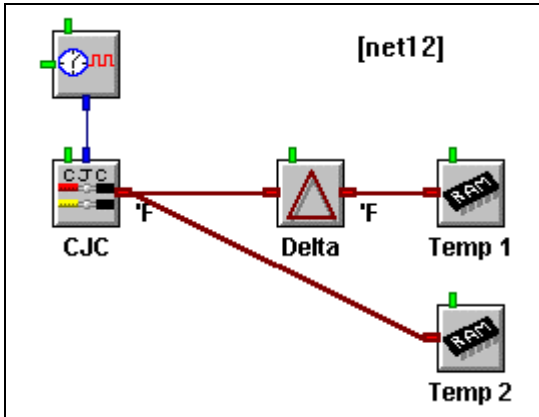

11.. . APPENDIX A: MASTER ICON FILE REFERENCE

INPUTS:

Data/Logic Signal: Data type.

Update Clock: None

Enable: Processing of icon is allowed when Enable pin is unconnected or when connected *and* Enable signal is TRUE.

OUTPUTS:

Output Signal: Data type. The Delta icon updates its output data when the updated input has changed in magnitude by a User defined 'delta' amount in comparison to the last passed sample.

ICON CONFIGURATION DIALOG BOX:

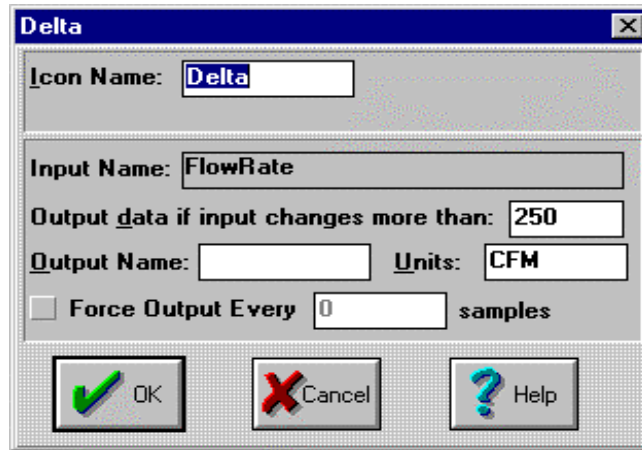

The image shows a dialog box titled "Delta" with a close button (X) in the top right corner. The dialog contains the following fields and controls:

- Icon Name:** A text box containing the word "Delta".
- Input Name:** A text box containing "FlowRate".
- Output data if input changes more than:** A text box containing "250".
- Output Name:** An empty text box.
- Units:** A text box containing "CFM".
- Force Output Every:** A checkbox that is currently unchecked, followed by a text box containing "0" and the label "samples".
- Buttons:** Three buttons at the bottom: "OK" with a green checkmark icon, "Cancel" with a red X icon, and "Help" with a blue question mark icon.

CONFIGURATION OPTIONS:

Icon Name: Specify the label for the icon. This name will show directly under the icon within the Program Net.

Input Name: In this box, HyperNet displays the Output Name of the icon connected to this icon's Input. The Output Name can be changed in the other icon's dialog.

Output data if input changes by more than: Enter the 'delta' value. For example if the data is to be passed if it changes by more than +/-2 degrees then enter the value of 2.

Units: Provides a text box for User entry of a units label that will be shown at the output from this icon.

Force Output Every: If this box is checked, a value will output periodically regardless of whether or not the delta value has been exceeded.

AVERAGE FUNCTION ICON

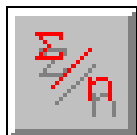

FUNCTION:

Averages data passing through the icon. The Average icon will accumulate a User specified number of input samples, then calculate and output the average. The Average icon can be used in either of two different modes: *Conventional*, or *Sliding*. These two

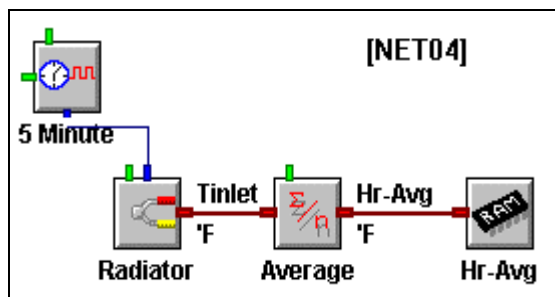

modes are described below.

Conventional: For example, if a User wants to take temperature readings every 5 minutes and calculate and store hourly averages, a Program Net as shown could be used. The Thermocouple icon is set to sample every 5 minutes per its attached Sample Rate Clock and the Average icon is configured to average 12 readings (ie 12 readings x 5 minutes = 1 hour) then output.

Sliding: The sliding average can be used to smooth noisy signals. When configured as a sliding average, every time the icon receives an updated input, a new average is calculated and output. The average will be calculated by dropping the oldest value, adding the new value then dividing by the Number of Samples Per Average. The following graph shows two plots of the same noisy input signal. The highly varying trace depicts the raw input which was logged straight to memory. The second, smoother trace was fed through a Sliding Average icon set for 10 samples. The smoothing effect is apparent.

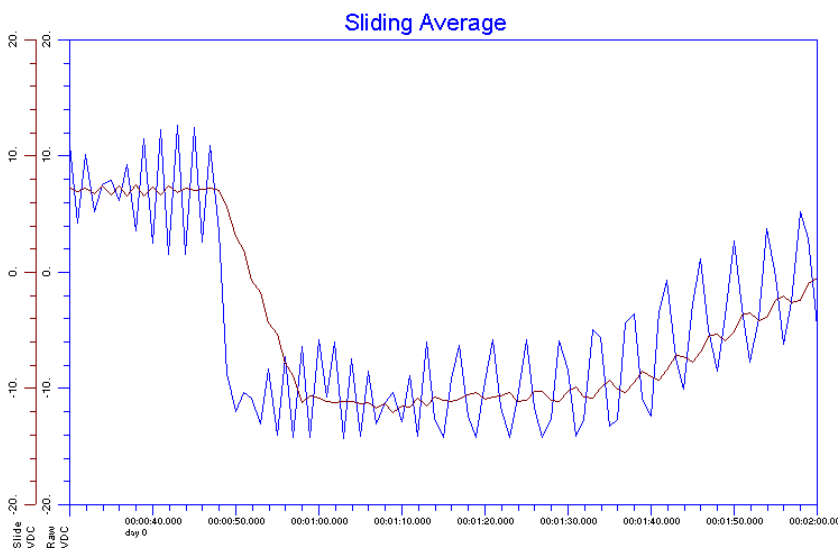

11.. . APPENDIX A: MASTER ICON FILE REFERENCE

INPUTS:

Data/Logic Signal: Data type.

Update Clock: None

Enable: Processing of icon is allowed when Enable pin is unconnected or when connected *and* Enable signal is TRUE.

OUTPUTS:

Output Signal: Data type. The Average icon updates its output after receiving and averaging the User specified number of readings.

ICON CONFIGURATION DIALOG BOX:

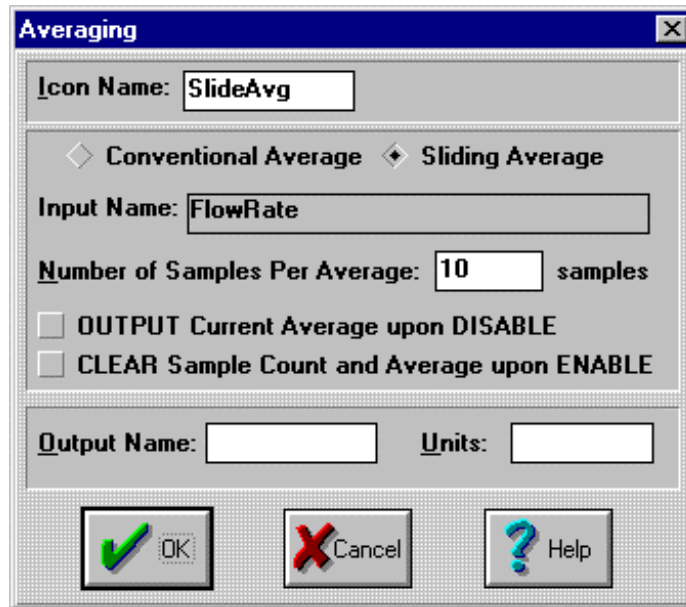

CONFIGURATION OPTIONS:

Icon Name: Specify the label for the icon. This name will show directly under the icon within the Program Net.

Input Name: In this box, HyperNet displays the Output Name of the icon connected to this icon's Input. The Output Name can be changed in the other icon's dialog.

Conventional/Sliding: Select type of Averaging function to perform.

Number of Samples per Average: Specify the number of input readings to average before outputting.

Output current Average upon disable: Check this box to force an output of the in-process average calculation at any time that the icon is disabled. If this box is not checked, upon receipt of a disable signal, the Average calculation will be momentarily suspended until the icon is re-enabled and no in-process value will be output.

For example, if an average is to be calculated over 10 samples but only 7 have been averaged and the icon is disabled, the 7 sample average will be output and the Average calculation will be suspended until re-enabled.

Upon re-enable, the calculation will continue and after 3 more samples are received, the 10 sample average will be output (unless the following check box is checked)

Clear Sample Count and Average upon Enable: Check this box to force a reset of the Average calculation as well as the Sample count used used for the calculation upon receipt of an Enable signal. If this box is not checked, upon receipt of an Enable signal, the Average calculation will proceed from its suspended state (that it entered when it was disabled).

Units: Provides a text box for User entry of a units label that will be shown at the output from this icon.

Output Name: Specify the label for the Output. This name will show directly under the Output terminal within the Program Net.

MINIMUM FUNCTION ICON

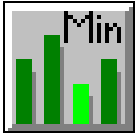

FUNCTION:

Detects the minimum data value passing through the icon. The Minimum icon will accumulate a User specified number of input samples, then calculate and output the minimum value received.

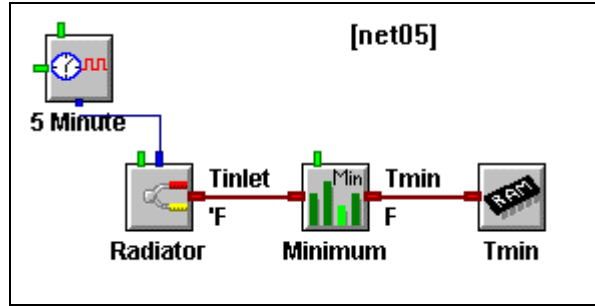

For example, if a User wants to take temperature readings every 5 minutes and calculate and store hourly minimums, a Program Net as shown could be used. The Thermocouple icon is set to sample every 5 minutes per its attached Sample Rate Clock and the Minimum icon is configured to analyze 12 readings (ie 12 readings x 5 minutes = 1 hour) then output the minimum.

INPUTS:

Data/Logic Signal: Data type.

Update Clock: None

Enable: Processing of icon is allowed when Enable pin is unconnected or when connected *and* Enable signal is TRUE.

OUTPUTS:

Output Signal: Data type. The Minimum icon updates its output with the minimum value after receiving and analyzing the User specified number of readings.

Minimum Value

Icon Name:

Input Name:

Output after **samples**

OUTPUT Current Value upon DISABLE

CLEAR Sample Count and Value upon ENABLE

Output Name: **Units:**

ICON CONFIGURATION DIALOG BOX:**CONFIGURATION OPTIONS:**

Icon Name: Specify the label for the icon. This name will show directly under the icon within the Program Net.

Input Name: In this box, HyperNet displays the Output Name of the icon connected to this icon's Input. The Output Name can be changed in the other icon's dialog.

Output after __ Samples: Specify the number of input readings to analyze before outputting the minimum value in the group.

Output current Value upon disable: Check this box to force an output of the current Minimum Value at any time that the icon is disabled. If this box is not checked, upon receipt of a disable signal, the Minimum calculation will be momentarily suspended until the icon is re-enabled and no in-process value will be output.

For example, if a Minimum is to be calculated over 10 samples but only 7 have been analyzed and the icon is disabled, the 7 sample Minimum Value will be output and the Minimum Value detection will be suspended until re-enabled. Upon re-enable, the detection will continue and after 3 more samples are received, the 10 sample Minimum will be output (unless the following check box is checked)

Clear Sample Count and Value upon Enable: Check this box to force a reset of the Minimum Value as well as the Sample count used used for the calculation upon receipt of an Enable signal.

If this box is not checked, upon receipt of an Enable signal, the Minimum analysis will proceed from its suspended state (that it entered when it was disabled).

Units: Provides a text box for User entry of a units label that will be shown at the output from this icon.

Output Name: Specify the label for the Output. This name will show directly under the Output terminal within the Program Net.

MAXIMUM FUNCTION ICON

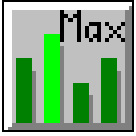

FUNCTION:

Detects the maximum data value passing through the icon. The Maximum icon will accumulate a User specified number of input samples, then calculate and output the maximum value of this set of received input values.

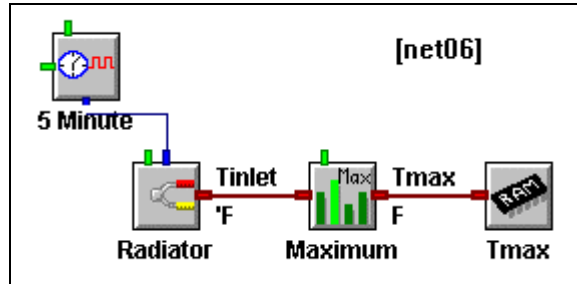

For example, if a User wants to take temperature readings every 5 minutes and calculate and store hourly maximums, a Program Net as shown could be used. The Thermocouple icon is set to sample every 5 minutes per its attached Sample Rate Clock and the Maximum icon is configured to analyze 12 readings (ie 12 readings x 5 minutes = 1 hour) then output the maximum value received in this set of 12 readings.

INPUTS:

Data/Logic Signal: Data type.

Update Clock: None

Enable: Processing of icon is allowed when Enable pin is unconnected or when connected *and* Enable signal is TRUE.

OUTPUTS:

Output Signal: Data type. The Maximum icon updates its output with the maximum value after receiving and analyzing the User specified number of readings.

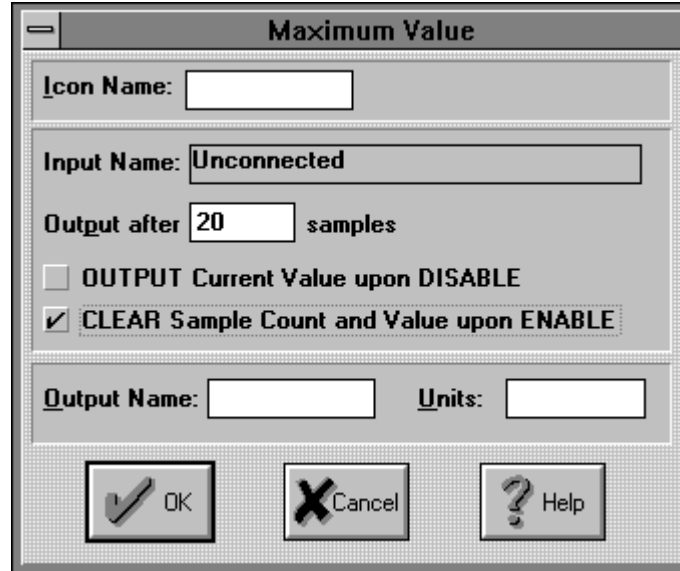

ICON CONFIGURATION DIALOG BOX:

CONFIGURATION OPTIONS:

Icon Name: Specify the label for the icon. This name will show directly under the icon within the Program Net.

Input Name: In this box, HyperNet displays the Output Name of the icon connected to this icon's Input. The Output Name can be changed in the other icon's dialog.

Output after __ Samples: Specify the number of input readings to analyze before outputting the maximum value in the group.

Output current Value upon disable: Check this box to force an output of the current Maximum Value at any time that the icon is disabled. If this box is not checked, upon receipt of a disable signal, the Maximum calculation will be momentarily suspended until the icon is re-enabled and no in-process value will be output.

For example, if a Maximum is to be calculated over 10 samples but only 7 have been analyzed and the icon is disabled, the 7 sample Maximum Value will be output and the Maximum Value detection will be suspended until re-enabled. Upon re-enable, the detection will continue and after 3 more samples are received, the 10 sample Maximum will be output (unless the following check box is checked)

Clear Sample Count and Value upon Enable: Check this box to force a reset of the Maximum Value as well as the Sample count used used for the calculation upon receipt of an Enable signal.

If this box is not checked, upon receipt of an Enable signal, the Maximum analysis will proceed from its suspended state (that it entered when it was disabled).

Units: Provides a text box for User entry of a units label that will be shown at the output from this icon.

Output Name: Specify the label for the Output. This name will show directly under the Output terminal within the Program Net.

SUM FUNCTION ICON

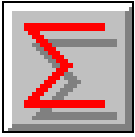

FUNCTION:

Sums the input values received for a User specified number of input updates. The Sum icon will accumulate a User specified number of input samples, then calculate and output the arithmetic sum of this set of received input values.

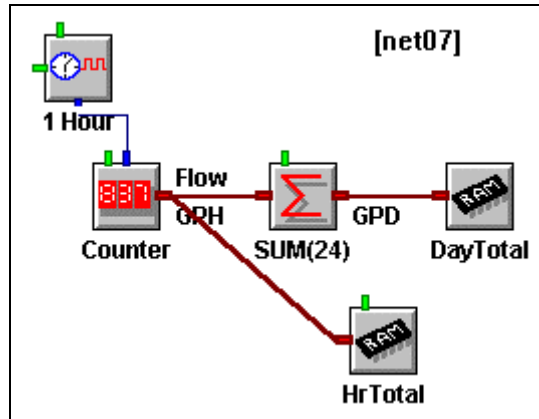

For example, if a User wants to record the daily and hourly flow totals from a pulse output flow meter, the above net could be used. Assuming each pulse from the flow meter equals 1 gallon, then the Counter can be set to accumulate pulses for an hour, then output these hourly totals. These hourly totals are stored in memory (Hr-Total) and also fed into the Summing icon. This Sum icon is configured to totalize (sum) 24 inputs, then output the daily sum to memory (the sum of 24, 1 hour totals equals one days total).

INPUTS:

Data/Logic Signal: Data type.

Update Clock: None

Enable: Processing of icon is allowed when Enable pin is unconnected or when connected *and* Enable signal is TRUE.

OUTPUTS:

Output Signal: Data type. The Sum icon updates its output with the arithmetic sum of the User specified number of input readings.

ICON CONFIGURATION DIALOG BOX:

CONFIGURATION OPTIONS:

- Icon Name:** Specify the label for the icon. This name will show directly under the icon within the Program Net.
- Input Name:** In this box, HyperNet displays the Output Name of the icon connected to this icon's Input. The Output Name can be changed in the other icon's dialog.
- Output after __ Samples:** Specify the number of input readings to totalize before outputting the sum of the input readings.
- Output current Value upon disable:** Check this box to force an output of the current Sum Value at any time that the icon is disabled. If this box is not checked, upon receipt of a disable signal, the Summation calculation will be momentarily suspended until the icon is re-enabled and no in-process value will be output.
For example, if a Sum is to be calculated over 10 samples but only 7 have been analyzed and the icon is disabled, the 7 sample Summation Value will be output and the Summing calculation will be suspended until re-enabled. Upon re-enable, the summing will continue and after 3 more samples are received, the 10 sample Summation Value will be output (unless the following check box is checked)
- Clear Sample Count and Sum upon Enable:** Check this box to force a reset of the Summation Value as well as the Sample count used for the calculation upon receipt of an Enable signal.
If this box is not checked, upon receipt of an Enable signal, the Summation calculation will proceed from its suspended state (that it entered when it was disabled).
- Clear Sum after Output:** Check this box to force the Sum Value to be reset to 0 after Output. If this box is not checked, the icon will perform as a totalizer
- Units:** Provides a text box for User entry of a units label that will be shown at the output from this icon.
- Output Name:** Specify the label for the Output. This name will show directly under the Output terminal within the Program Net.

DUTY-CYCLE FUNCTION ICON

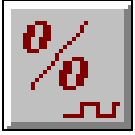

FUNCTION:

Calculates the amount of time per a User defined time period, that the input signal is True (on) or False (off). Connected to the LOGIC output of an upstream icon (eg an Event icon) the Duty Cycle icon will determine the accumulated ON or OFF (True/False) time over a User defined time period and output that data value at the end of each period. It is to be used with Logic input signals.

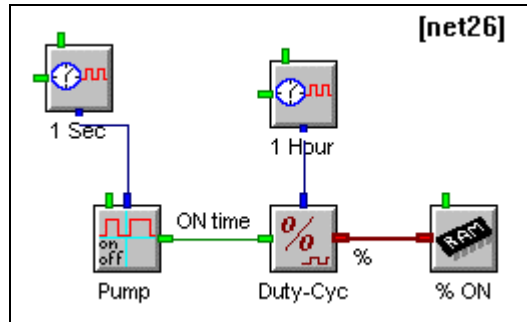

NOTE: For integration of DATA type signals refer to the Integral icon.

For example, to determine the ON time (duty cycle) per hour of a pump in a water supply lift station. The pump power is sensed by an Event input channel which is sampling the pump status (on/off) every second. The Event icon output is connected to the Duty cycle icon input and an Update Clock is connected to the Duty cycle icon Update terminal. The Duty cycle icon Update Clock is set for 1 Hour. The Duty cycle icon then samples its input at a 1 second rate and calculates and outputs the ON (OFF) duty cycle of the input signal upon receipt of an Update Clock pulse (ie every hour).

INPUTS:

Data/Logic Signal: Logic type (true/false).

Update Clock: Yes, specifies the time period over which the duty-cycle is calculated

Enable: None

OUTPUTS:

Output Signal: Data type. The Duty-cycle icon updates its output after receiving an Update Command from the connected Update Clock. The Output will be in Percent (ie a number from 0 to 100) or a decimal format (ie a number from 0.0 to 1.0) depending on the User specified Report format within the Configuration Dialog.

ICON CONFIGURATION DIALOG BOX:

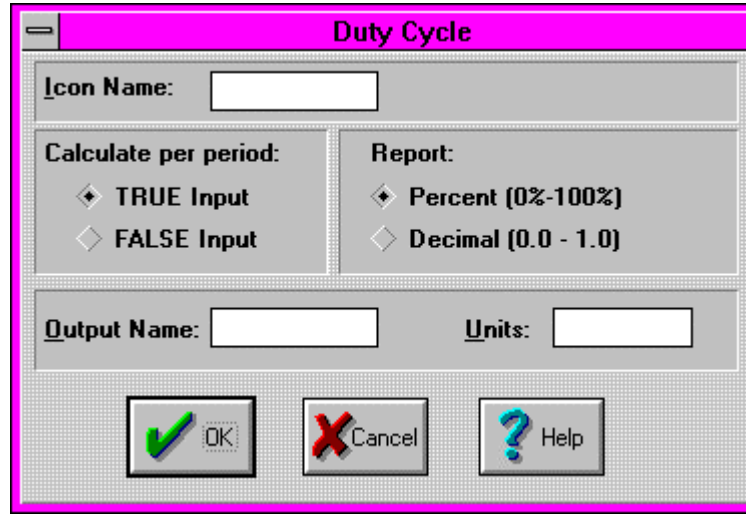

Duty Cycle

Icon Name:

Calculate per period:

◆ TRUE Input



◇ FALSE Input

Report:

◆ Percent (0%-100%)

◇ Decimal (0.0 - 1.0)

Output Name: Units:

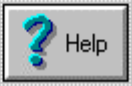
CONFIGURATION OPTIONS:

- Icon Name:** Specify the label for the icon. This name will show directly under the icon within the Program Net.
- Calculate Per Period:** Specify whether True (ON) or False (OFF) time per Period is to be accumulated.
- Units:** Provides a text box for User entry of a units label that will be shown at the output from this icon.
- Report:** Specify if the output value is to be in Percent or in a Decimal format.
- Output Name:** Specify the label for the Output. This name will show directly under the Output terminal within the Program Net.

RATE OF CHANGE FUNCTION ICON

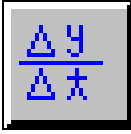

FUNCTION:

The Rate of Change icon calculates and outputs the rate of change of a signal for a user specified number of samples. A “sliding” calculation is performed each time the input is updated. For example, if the user-entered number of samples is 5, after the 5th sample is taken, the 1st and 5th samples are used for the calculation. The next time sample is taken, the 2nd and 6th are used and so on.

INPUTS:

Data/Logic Signal: Data type.

OUTPUTS:

Output Signal: Data type. The Rate of Change icon updates its output after receiving the user specified number of samples and calculation the Rate of Chnge.

ICON CONFIGURATION DIALOG BOX:

CONFIGURATION OPTIONS:

Icon Name: Specify the label for the icon. This name will show directly under the icon within the Program Net.

Input Rate Time Base: Specifies time base of the output. For example if Seconds is selected and the input is temperature, the output would be the rate of change of the input in degrees per second.

Number of Samples: Specifies the number of samples that defines the time interval used for the calculation.(dtm samples/intervals???)

Output Name:Specify the label for the Output. This name will show directly under the Output terminal within the Program Net.

Units: Provides a text box for user entry of a units label that will be shown at the output from this icon

TIME INTEGRATION FUNCTION ICON

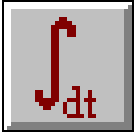

FUNCTION:

Calculates the time integral of data type input over a User defined integration period. The Time Integral icon can only be used with DATA type inputs.

NOTE: For LOGIC type input time integration, refer to the Duty-Cycle icon.

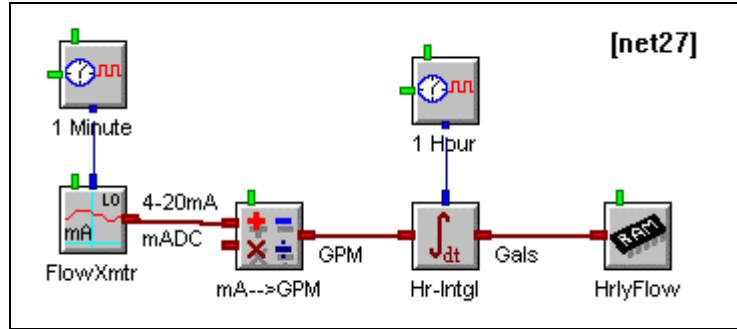

For example, the Integral icon can be used in a Net (see above) to determine the hourly flow total of oil through a pipe. The oil flow RATE is sampled every minute by a 4-20mA flow transmitter and the signal is converted to GPM via a Math icon. This flow rate is then connected to the Integral icon which calculates the hourly volume flow by integrating the flow rate over time. The Sample Rate Clock connected to the Integral icon Update terminal determines the integration period.

INPUTS:

Data/Logic Signal: Data

Update Clock: Yes, specifies the time period over which the input signal is integrated

Enable: None

OUTPUTS:

Output Signal: Data type. The Integral icon updates its output with the new integral value after receiving an Update Command from the connected Update Clock.

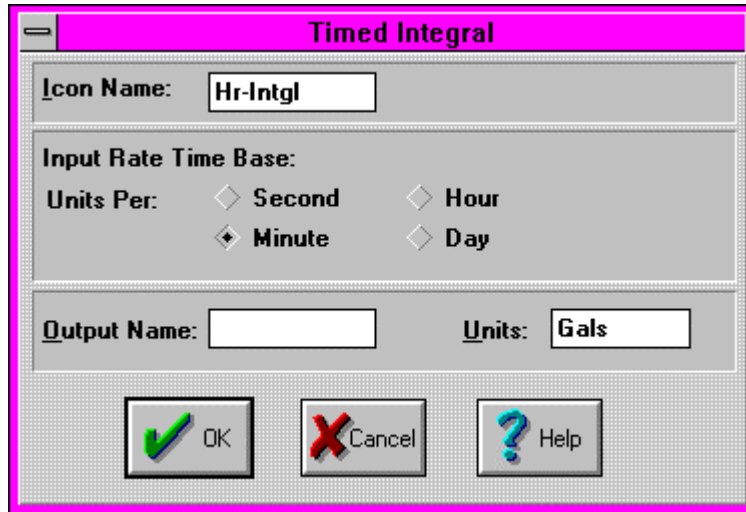
ICON CONFIGURATION DIALOG BOX:

Timed Integral

Icon Name: Hr-Intgl

Input Rate Time Base:

Units Per: Second Hour
 Minute Day

Output Name: **Units:** Gals

OK Cancel Help

CONFIGURATION OPTIONS:

Icon Name: Specify the label for the icon. This name will show directly under the icon within the Program Net.

Input Rate Timebase: Units per...

Specify the timebase (ie units per second, per minute, etc) for which the input signal rate is specified. By providing this information, the Net will automatically calculate the correct unit volume output based on the integration period. In the above example, the flow rate was in GPM. With a 1 hour integration period specified (by the User connected Rate Clock), the Net will automatically generate the correct volume output.

If a timebase other than seconds, minutes, hours, or days is used, the rate (Integral icon input) can be scaled by a math icon prior to connection to the Integral icon to bring the timebase within the possible timebase selections.

Units: Provides a text box for User entry of a units label that will be shown at the output from this icon.

Output Name: Specify the label for the Output. This name will show directly under the Output terminal within the Program Net.

HISTOGRAM FUNCTION ICON

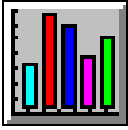

FUNCTION:

The Histogram icon compares its input value with a user specified range. If the input value falls within the range, its internal counter is incremented. When a user specified number of inputs have been compared, the icon outputs its count.

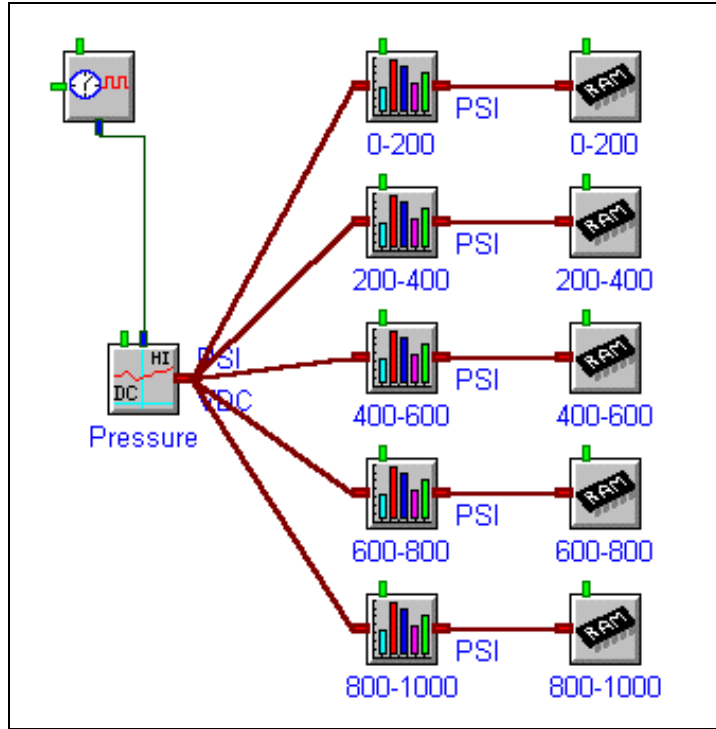

For example, in the net shown above, five different Histogram icons are being used to monitor how often the pressure input falls within five different ranges. Each icon is set to compare the same number of samples before outputting its count.

INPUTS:

Data/Logic Signal: Data type.

OUTPUTS:

Output Signal: Data type. The Histogram icon outputs its count after receiving the user specified number of samples.

ICON CONFIGURATION DIALOG BOX:

Histogram Icon [X]

Icon Name:

Input Name:

Output Totals After Samples

Output Totals upon Disable

Clear Sample Count and Totals upon Enable

Clear Totals after Output

Units:

Count incremented when the input satisfies the following condition:

<= Input Value <

OK Cancel Help

CONFIGURATION OPTIONS:

- Icon Name:** Specify the label for the icon. This name will show directly under the icon within the Program Net.
- Input Name:** In this box, HyperNet displays the Output Name of the icon connected to this icon's input. The Output Name can be changed in the other icon's dialog.
- Output Totals After ___ Samples:** When the number of samples specified have been received and compared, the icon will output the count of how many samples fell within the specified range.
- Clear Sample Count and Totals upon Enable:** The icon keeps track of how many samples it has compared, as well as how many fell into the specified range. Check this box to force a reset of both counts upon receipt of an enable signal.
- Clear Totals After Output:** Check this box to force the icon to clear the count after it is output.
- Units:** Provides a text box for User entry of a units label that will be shown at the output from this icon.
- Count incremented when the input satisfies the following conditions:** Specifies the range that the input must fall within in order to increment the icon's counter.

REMOTE CONTROL FUNCTION ICON

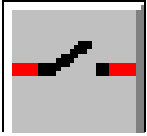

FUNCTION:

The Remote Control icon has a logic output that can be controlled real-time by the user. This output can be connected to the logic input of any other icon.

INPUTS:

Update Clock: Output is updated to the last user selected state upon each Update clock pulse. For example, if the connected Update clock is set for 60 sec., and the output state is changed by the user via HyperWare (described below), the actual state of the output will not update until the icon receives an Update pulse which may be up to 60 seconds later.

OUTPUTS:

Output Signal: Logic type. The Remote Control icon updates its output after receiving a user generated command to do so from HyperWare.

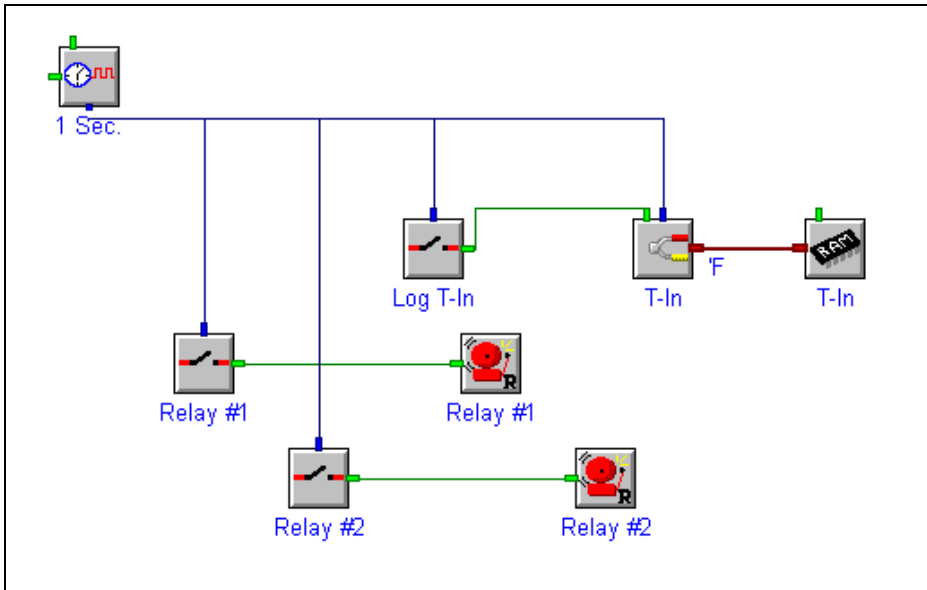

For example, the portion of a net program depicted above shows possible uses for the Remote Control icon. The Remote Control icons labeled "Relay #1" and "Relay #2" are connected to the logger's relay output icons. This would enable the user to control the state of the logger's hardware relay outputs real-time. The Remote Control icon labeled "Log T-In" is connected to the Enable input on a Thermocouple icon which is set to log data to memory. Whenever the Thermocouple's enable input is ON, the channel will sample. Conversely, if its Enable input is OFF, it will not sample. This setup allows the user to turn on different portions of a net program at will

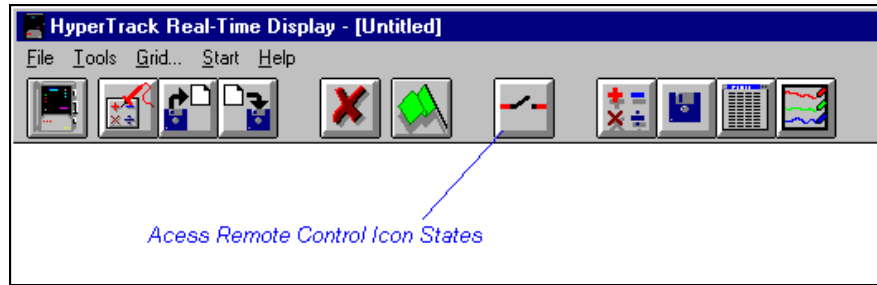

Remote Control icons can be accessed from the HyperTrack Real Time Display window. The button used to monitor/change the states of Remote Control icons is shown above. Clicking this button will cause HyperWare to query the logger for the names and corresponding states of its Remote Control icons. HyperWare will then display the following dialog box.

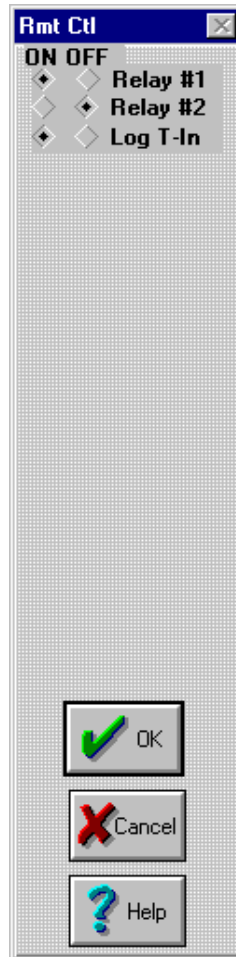

The states of each icon can then be selected. Clicking "OK" will cause HyperWare to send the appropriate commands to the logger, telling it to update the Remote Control Icons accordingly.

ICON CONFIGURATION DIALOG BOX:

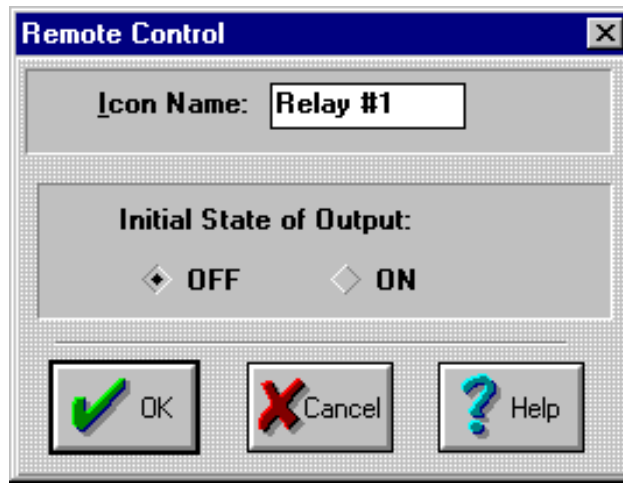

CONFIGURATION OPTIONS:

Icon Name: Specify the label for the icon. This name will show directly under the icon within the Program Net.

Initial State: This is the state of the icon's output upon enabling

HAP FUNCTION ICON

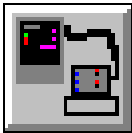

FUNCTION:

The HAP icon is used in conjunction with the Omega Engineering HyperWare Automation Program (HAP) application. Hap is a stand-alone application separate from HyperWare, that automates most of HyperWare’s communication functions. .. When the HAP icon’s input goes TRUE, the icon will initiate communication with a PC that is running the HAP application. The icon will tell HAP which functions to perform. based on the information entered in the configuration dialog. HAP will then proceed to perform those functions.

INPUTS:

Data/Logic Signal: Data type.

OUTPUTS:

Output Signal: Data type(Optional). The HAP icon turns on its output if it was unable to connect to HAP. The output will remain ON untill the next time the HAP icon fires off

ICON CONFIGURATION DIALOG BOX:

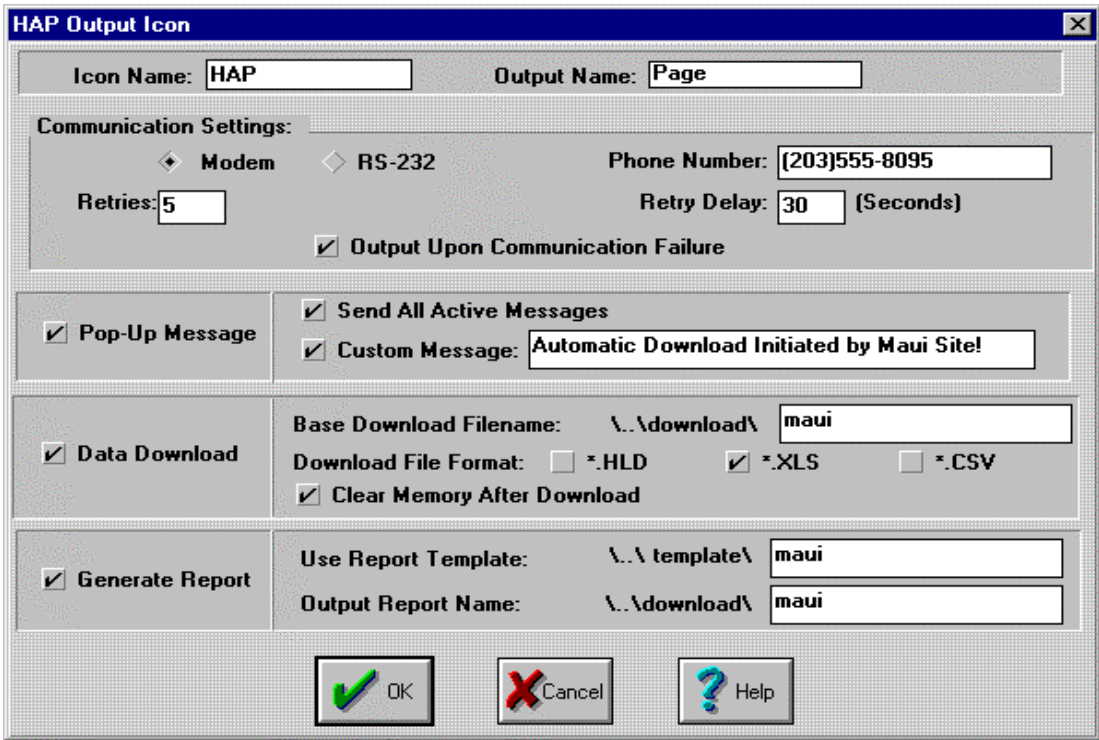

CONFIGURATION OPTIONS:

Icon Name: Specify the label for the icon. This name will show directly under the icon within the Program Net.

11.. . APPENDIX A: MASTER ICON FILE REFERENCE

Output Name: Specify the label for the Output. This name will show directly under the Output terminal within the Program Net.

Modem/RS-232: Specifies the type of communication

Phone Number: This is the phone number that will be called if telephone modem communication is selected.

Retries: If a call is unsuccessful, the dialing sequence will be repeated the specified number of times.

Retry Delay: If a call is unsuccessful, the logger will wait the specified time before attempting again.

Output Upon Communication Failure: Checking this box will cause an output to appear. This output goes TRUE if a the logger fails to connect to the PC.

Pop-Up Message: Causes a pop-up message. to be displayed on the PC running HAP. This message will contain some basic header information as well as the following if selected.

Send All Active Messages: If this box is checked, the Pop-up message will contain all active system messages.

Custom Message: If this box is checked a custom message can be entered.

Data Download: Check this box to perform a download of logger memory.

Base Download Filename: Specifies the first few characters of the downloaded filename. HAP will append the base filename with “__last”. If a file with that name already exists, hap will rename the older file to the base filename appended with __X where X is a number

Data Download File Format, *HLD/*XLS/*CSV: Specify the output file type.

Clear Memory After Download: Check this box to clear memory after the data is downloaded.

Generate Report: Check this box to generate an Excel report.

Use Report Template Name: Specify the report template to use. This template must be generated using HAP

Output Report Name: Name of the report file

.

TEXT NOTE ICON

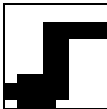

FUNCTION:

The Text Note icon provides a means to add user comments to a specific portion of a net program. The Text Note icon is located at the right-hand end of the signnable toolbar as depicted below.

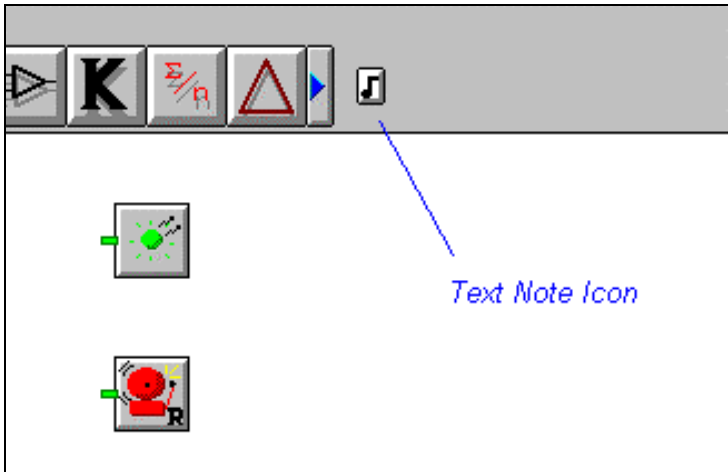

The Text Note is not the same as other icons in that it doesn't actually process any data. It only displays text within the net program. Although the icon does not perform any function when the net program is run, it is an integral part of the net and remains intact when uploaded/downloaded to the logger. An example of a net that contains Text Note icons is shown below.

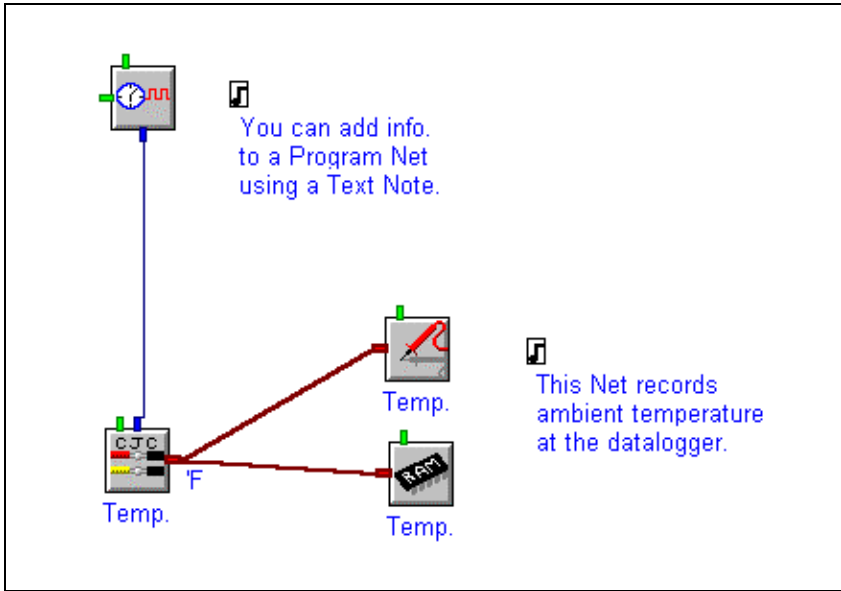

11.. . APPENDIX A: MASTER ICON FILE REFERENCE

INPUTS:

None

OUTPUTS:

None.

ICON CONFIGURATION DIALOG BOX:

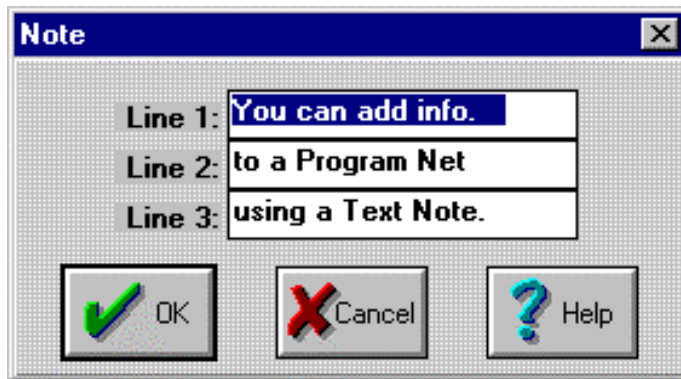

CONFIGURATION OPTIONS:

Lines 1,2 & 3: Simply enter the text that is to be displayed into the three boxes.

MATH FUNCTION ICON

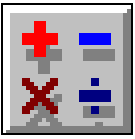

FUNCTION:

The Math icon accepts one or two input signals, performs a User defined mathematical calculation, then outputs the result. Equations are entered by the User and optionally saved to a User-Defined math library. A Pre-Defined library of special equations is also provided.

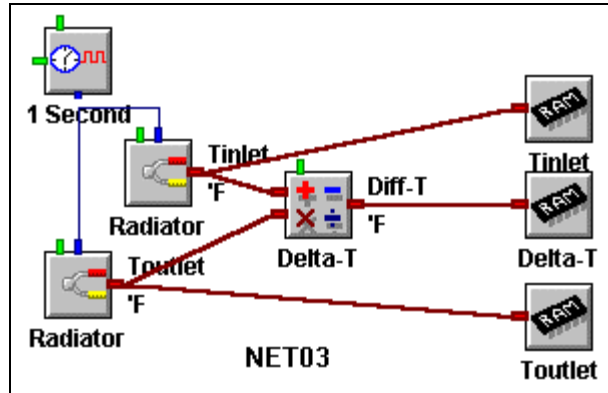

For example, if a User wants to calculate the temperature differential across a heat exchanger radiator and store this `math channel' to memory, a Net as shown above might be used.

INPUTS:

Data/Logic Signal: One or Two Data type. If only one input is used, the other input should be left unconnected.

Update Clock: None

Enable: Processing of icon is allowed when Enable pin is unconnected or when connected *and* Enable signal is TRUE.

OUTPUTS:

Output Signal: Data type. The Math calculation result.

ICON CONFIGURATION DIALOG BOX:

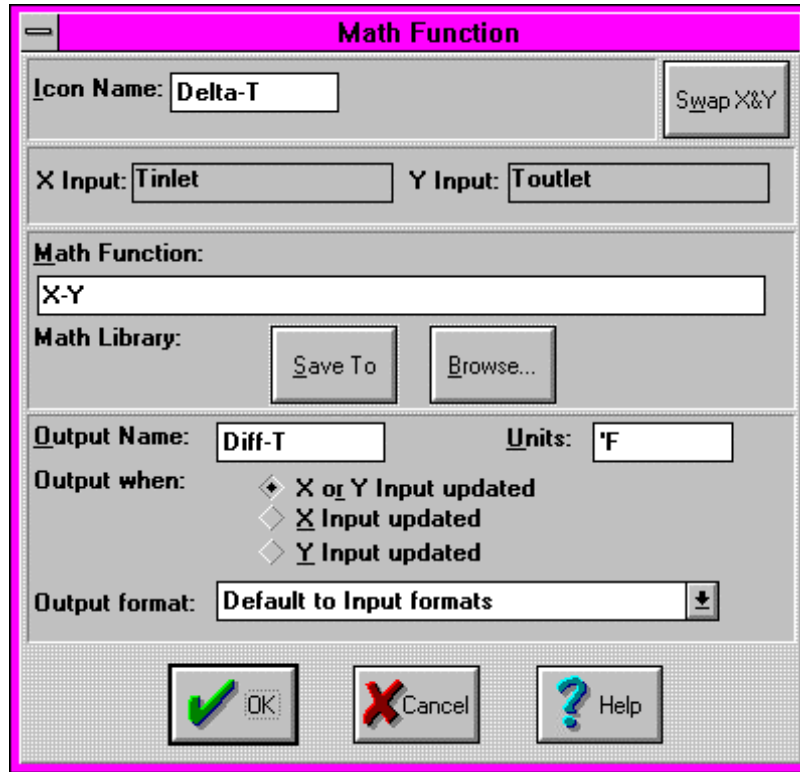

CONFIGURATION OPTIONS:

Icon Name: Specify the label for the icon. This name will show directly under the icon within the Program Net.

X and Y Input Name: In this box, HyperNet displays the Output Names of the icons connected to this icon's Inputs. The Output Names can be changed in the other icons' dialogs.

Swap X and Y: Clicking on the SWAP button swaps the X and Y input connections. The change is reflected in the X and Y Input Name boxes as well as in the actual Program Net where the connections are redrawn.

Math Function: A text box is provided for entry of the equation to be calculated. In the equation, use X and Y to represent the values at the X and Y inputs. Supported math functions, their Syntax, and Explanations are provided in the following table:

FUNCTION	SYNTAX	EXPLANATION
Addition	X+7	Adds 7 to Input X
Subtraction	X-20	Subtracts 20 from Input X
Multiplication	X*1.2	Multiplies X times 1.2
Division	X/2	Divides X by 2
Exponentiation	X^3	X cubed
Exponential	EXP(X)	e to Xth power
Parenthesis	2*(X-Y)	2 times the difference of the X Input minus the Y Input
Square	SQR(Y)	Y squared
Square Root	SQRT(X)	Square root of X

Absolute Value	ABS(Y)	Absolute value of Y
Zeroize	ZERO(X)	Zero if X is negative, X otherwise
Natural Log	LOG(Y)	Natural log of Y
Log Base 10	LOG10(X)	Base 10 log of X
Sine	SIN(Y)	Sine of Y
Cosine	COS(X)	Cosine of X
Tangent	TAN(Y)	Tangent of Y
ArcCosine	ACOS(X)	ArcCosine of X
ArcSine	ASIN(X)	ArcSine of X
ArcTangent	ATAN(X)	ArcTangent of X
ArcTangent2	ATAN2(Y)	ArcTangent2 is accurate for values of X very close to and equal to 0
TC converter ¹	TC_J(X,Y)	Temperature calculation using type J thermocouple input in mV (X) and CJC input in ohms(Y)
TC converter	TC_K(X,Y)	Same as above for type K
TC converter	TC_E(X,Y)	Same as above for type E
TC converter	TC_T(X,Y)	Same as above for type T
TC converter	TC_R(X,Y)	Same as above for type R
TC converter	TC_S(X,Y)	Same as above for type S

Math Library: A math function library is provided for storing User defined equations that may be used frequently.

To save a function, enter the equation in the Math Function text box, then select *Save To*. A dialog will open allowing for User entry of a short comment about the function to be saved. After entry of the comment, selecting OK saves the function to the User Function Library for future recall.

To retrieve a function for use, select *Browse* and a dialog will open allowing access to the Pre-Defined Library equations (provided with HyperWare and not editable by the User) as well as the User-Defined Library where User added equations are retained. Highlight the equation and click on *Use* and the function will be loaded into the Math Function text box.

Functions can be deleted by highlighting, then clicking on the *Remove* button.

Units: Provides a text box for User entry of a units label that will be shown at the output from this icon.

Output Name: Specify the label for the Output. This name will show directly under the Output terminal within the Program Net.

Output When: Defines when the Output is updated. If inputs to the icon are updated at different times/rates (asynchronously), the User can specify when the Output should be updated.

X or Y Updated - The Output is updated if either the X or the Y inputs are Updated.

¹ See Example Nets in Appendix xxx for application ideas on use of the TC Converter functions.

11.. . APPENDIX A: MASTER ICON FILE REFERENCE

X input Updated - The Output is updated only when the X input is Updated. If a calculation is performed that uses the Y input, the last Y input value will be used in the calculation and the Output will be updated.

Y input Updated - The Output is updated only when the Y input is Updated. If a calculation is performed that uses the X input, the last X input value will be used in the calculation and the Output will be updated.

Output Format: The User can specify the data format for the Output from the icon. In certain applications, additional processing speed and/or less memory per stored sample can be realized.

Default to Input Formats - the default format. The data will be passed using the same data format as the Inputs use. Note that if inputs are received as integers, operations resulting in a decimal component (eg division) will be output as integers with corresponding loss of precision (truncation of decimal). If this is of concern, utilize the Floating Point format.

Floating Point - The Output data will be of Floating point format. Floating Point format includes both the integer and decimal components (XXX.XXX) of the calculation result.

Advantages of Floating Point mode:

1. This format will result in outputs that have no loss in precision.

Disadvantages of Floating Point mode:

1. Calculations will perform slower than Long Integer mode. The calculation speed may be 10x slower per operation than using Long Integer mode.
2. If the Output is connected to a Memory icon, Floating Point mode will always use 4 bytes for data storage.

Long Integer - The Input data will be converted to integer format, then the calculation will be performed and output in signed Integer format. Signed Integer format includes only the digits to the left of the decimal (XXXXX.)

Advantages of Long Integer mode:

1. Calculations will perform faster. Processing throughput rates may be up to 10 times faster (per operation) than the equivalent calculation using floating point math.
2. If the Output is connected to a Memory icon, Long Integer mode will generally utilize a fewer number of bytes for data storage. The number of bytes will dynamically size, from 1 to 4 bytes, according to the magnitude of the Output.

Disadvantages of Long Integer mode:

1. Input numerical precision will be lost if incoming data is in floating point format. Precision will be lost in the conversion to integer format (eg 26.3 becomes 26). If large numbers are processed, this loss of precision may be negligible (eg 36785.2 becomes 36785).
2. Calculation results will be truncated to integers, hence any decimal components will be lost (eg $10/3=3.33333$ but will be output as the integer 3). If large numbers are processed and/or operations are performed that will not have decimal results (addition, subtraction, multiplication, etc), this loss may be negligible.

COMPARATOR (SETPOINT) FUNCTION ICON

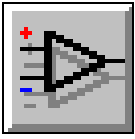

FUNCTION:

The Comparator icon performs a comparison between its X and Y inputs and Outputs a Logic (True/False) signal depending on the result of the comparison. If the X input is greater than the Y input, the Output is True. If the X input is less then the Y input, the Output is False.

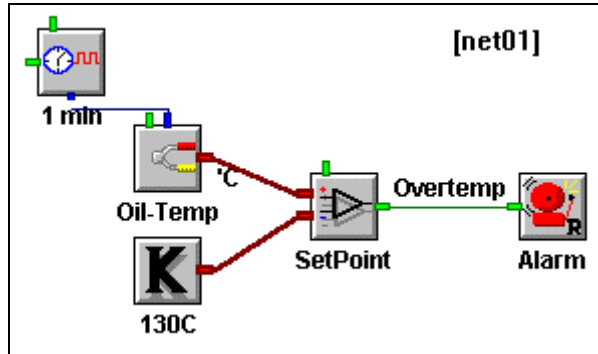

In the above net, when the temperature of the engine oil exceeds 130C, the relay output will be energized. The Comparator has been configured with hysteresis of 10 degrees. When the temperature drops to below 120C (130-10), the alarm will be turned off.

NOTE: Optionally utilize the Latch icon between the Comparator and the Alarm to latch the Alarm ON once it turns on.

INPUTS:

Data/Logic Signal: Two Data type inputs are required for operation.

Update Clock: None

Enable: Processing of icon is allowed when Enable pin is unconnected or when connected *and* Enable signal is TRUE.

OUTPUTS:

Output Signal: Logic type.

ICON CONFIGURATION DIALOG BOX:

Comparator

Icon Name:

X Input: Y Input:

Use Hysteresis
 Output ON when: X >= Y
 Output OFF when: X < Y -

Output Name:

Output when:
 X or Y Input updated
 X Input updated
 Y Input updated

CONFIGURATION OPTIONS:

Icon Name: Specify the label for the icon. This name will show directly under the icon within the Program Net.

X and Y Input Name: In this box, HyperNet displays the Output Names of the icons connected to this icon's Inputs. The Output Names can be changed in the other icons' dialogs.

Swap X and Y: Clicking on the SWAP button swaps the X and Y input connections. The change is reflected in the X and Y Input Name boxes as well as in the actual Program Net where the connections are redrawn.

Comparator Function: When the configuration dialog appears, the comparator is configured to perform a simple comparison between X and Y, if X is greater than or equal to Y, the Output is ON.

If the Hysteresis box is checked, an additional line is displayed with a text box for entry of hysteresis (ie deadband) which is then included in the comparison function. As shown, a Hysteresis of 10 degrees has been specified. In this case, when the oil temperature rises to equal or greater than 130C, the Output will turn ON. When the temperature of the oil drops to less than 120C, the output will turn OFF.

Hysteresis is commonly used to prevent short cycling due to quick dynamic system response and/or signal fluctuations and noise/jitter.

Output Name: Specify the label for the Output. This name will show directly under the Output terminal within the Program Net.

Output When: Defines when the Output is updated. If inputs to the icon are updated at different times/rates (asynchronously), the User can specify when the Output should be updated.

X or Y Updated - The Output is updated if either the X or the Y inputs are Updated.

X input Updated - The Output is updated only when the X input is Updated. If a calculation is performed that uses the Y input, the last Y input value will be used in the calculation and the Output will be updated.

Y input Updated - The Output is updated only when the Y input is Updated. If a calculation is performed that uses the X input, the last X input value will be used in the calculation and the Output will be updated.

CONSTANT FUNCTION ICON

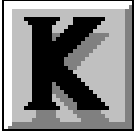

FUNCTION:

The Constant icon represents a fixed User defined value. A typical application for the Constant is as a threshold for use with the Comparator icon as shown below.

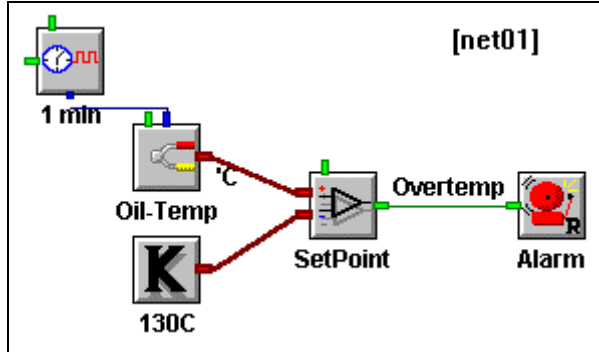

In the above net, when the temperature of the engine oil exceeds 130C, the relay output will be energized.

INPUTS:

Data/Logic Signal: None.

Update Clock: None

Enable: None

OUTPUTS:

Output Signal: Data type, fixed value of User definition.

ICON CONFIGURATION DIALOG BOX:

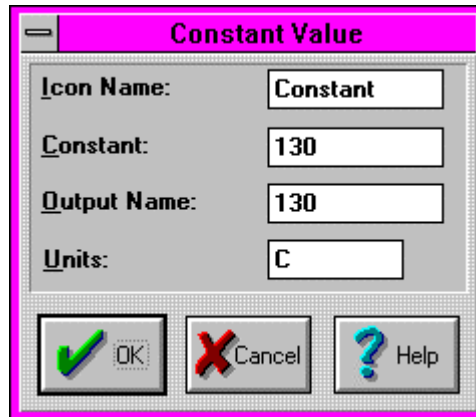

CONFIGURATION OPTIONS:

Icon Name: Specify the label for the icon. This name will show directly under the icon within the Program Net.

Constant: Enter the constant value in this text box.

Output Name: Specify the label for the Output. This name will show directly under the Output terminal within the Program Net.

Units: Provides a text box for User entry of a units label that will be shown at the output from this icon.

LATCH FUNCTION ICON

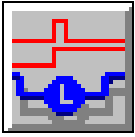

FUNCTION:

The Output turns ON and stays ON when the Input transitions from OFF to ON. The Latch icon is commonly used in front of an Alarm output icon to force the Alarm to stay ON once it is turned ON (see following Net).

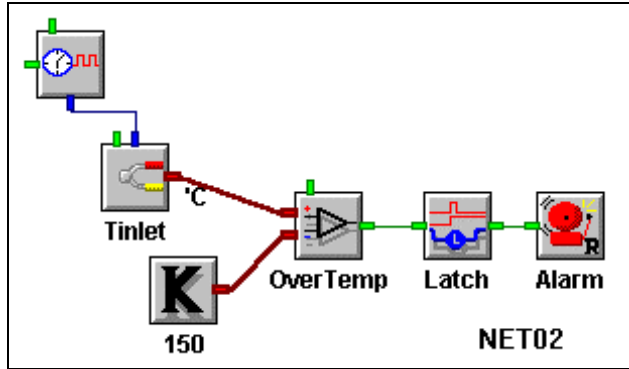

INPUTS:

Data/Logic Signal: Logic (True/False) type.
Update Clock: None

OUTPUTS:

Output Signal: Logic type.

ICON CONFIGURATION DIALOG BOX:

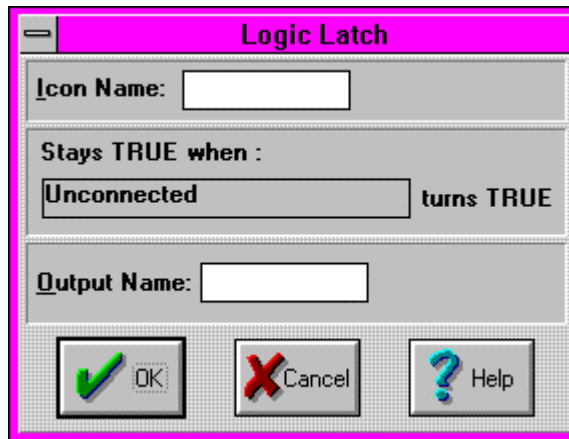

CONFIGURATION OPTIONS:

Icon Name: Specify the label for the icon. This name will show directly under the icon within the Program Net.

Stays TRUE when _____ turns TRUE: The Output name of the icon connected to the Latch icon input is displayed in this function statement.

Output Name: Specify the label for the Output. This name will show directly under the Output terminal within the Program Net.

AND LOGIC FUNCTION ICON

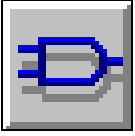

FUNCTION:

The Output turns TRUE *ONLY* when both of the Inputs are TRUE. If either or both of the Inputs are FALSE, the Output is FALSE.

INPUTS:

Data/Logic Signal: Two Logic (TRUE/FALSE) type.
Update Clock: None
Enable: None

OUTPUTS:

Output Signal: Logic type.

ICON CONFIGURATION DIALOG BOX:

CONFIGURATION OPTIONS:

Icon Name: Specify the label for the icon. This name will show directly under the icon within the Program Net.

Output TRUEwhen: _____ AND _____ are TRUE: HyperNet completes this functional statement using the names of the Outputs from the icons that are connected to this AND icon's Inputs.

Output Name: Specify the label for the Output. This name will show directly under the Output terminal within the Program Net.

OR LOGIC FUNCTION ICON



FUNCTION:

The Output turns TRUE when either of the Inputs are TRUE. If both of the Inputs are OFF, the Output is OFF.

INPUTS:

- Data/Logic Signal:** Two Logic (True/False) type.
- Update Clock:** None
- Enable:** None

OUTPUTS:

- Output Signal:** Logic type.

ICON CONFIGURATION DIALOG BOX:

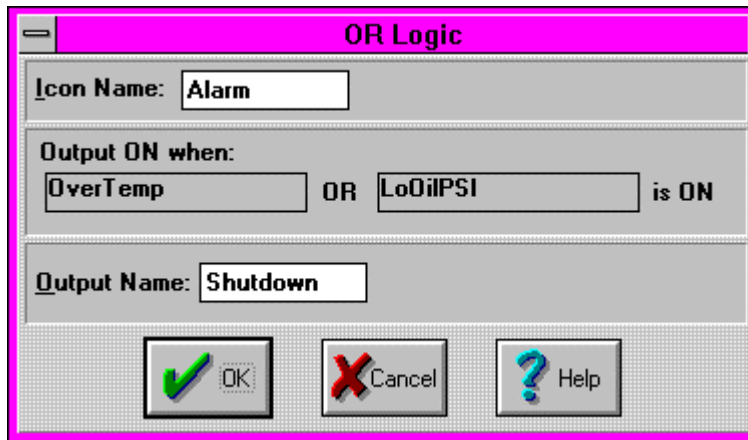

CONFIGURATION OPTIONS:

Icon Name: Specify the label for the icon. This name will show directly under the icon within the Program Net.

Output TRUEwhen: _____ OR _____ is TRUE: HyperNet completes this functional statement using the names of the Outputs from the icons that are connected to this OR icon's Inputs.

Output Name: Specify the label for the Output. This name will show directly under the Output terminal within the Program Net.

XOR (EXCLUSIVE OR) LOGIC FUNCTION ICON



FUNCTION:

The Output turns TRUE when the state of the two Inputs are different, ie *ONLY ONE* of the Inputs is TRUE. If neither or both of the Inputs are TRUE, the Output is FALSE.

INPUTS:

Data/Logic Signal: Two Logic (True/False) type.
Update Clock: None
Enable: None

OUTPUTS:

Output Signal: Logic type.

ICON CONFIGURATION DIALOG BOX:

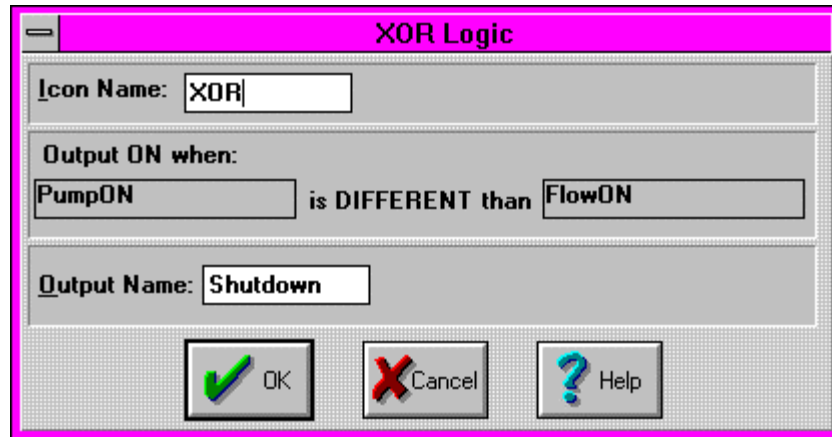

CONFIGURATION OPTIONS:

Icon Name: Specify the label for the icon. This name will show directly under the icon within the Program Net.

Output TRUE when: _____ is DIFFERENT than _____: HyperNet completes this functional statement using the names of the Outputs from the icons that are connected to this XOR icon's Inputs.

Output Name: Specify the label for the Output. This name will show directly under the Output terminal within the Program Net.

NOT (INVERTER) LOGIC FUNCTION ICON

The NOT icon inverts the signal as it passes through. When the Input is True the Output is False. When the Input is False, the Output is True.

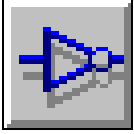

INPUTS:

Data/Logic Signal: Logic (True/False) type.

Update Clock: None

Enable: None

OUTPUTS:

Output Signal: Logic type.

ICON CONFIGURATION DIALOG BOX:

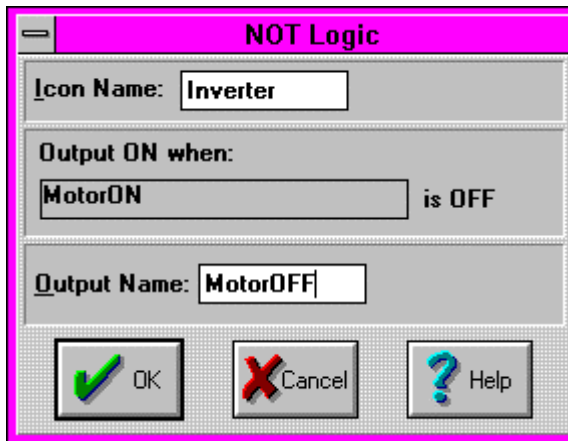

CONFIGURATION OPTIONS:

Icon Name: Specify the label for the icon. This name will show directly under the icon within the Program Net.

Output True when _____ is False: HyperNet completes this functional statement using the name of the Output from the icon that is connected to this NOT (inverting) icon's Inputs.

Output Name: Specify the label for the Output. This name will show directly under the Output terminal within the Program Net.

TIMED COUNTER FUNCTION ICON

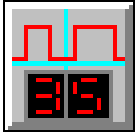

The Timed Counter is a software counter that can be used within a Net for accumulating transitions over a fixed period of time(for example: counting pulses received per hour). In concept, this icon performs a similar function as a hardware counter input such as the GPD1 in the Counter mode. However, the difference is that the Timed Counter is a software version that can be used to count transitions received from other software icons such as the Comparator.

The icon is has an Update Clock input that specifies the time period over which it is to accumulate the transitions received on its Input. The Net shown below counts the number of times per hour a temperature exceeds the 1400F threshold and stores this *OverTemps per hour* value in memory.

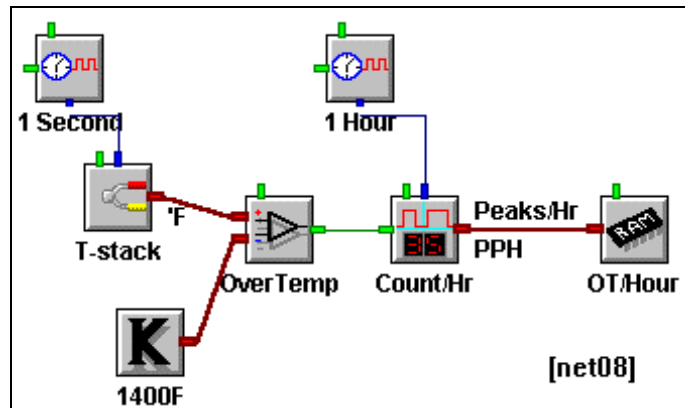

INPUTS:

Data/Logic Signal: Logic (True/False) type.

Update Clock: Specifies the period of time over which the count is accumulated. When an Update command is received, the current count is output and counting resumes (optionally it can be reset to 0 before counting resumes)

Enable: Processing of icon is allowed when Enable pin is unconnected or when connected *and* Enable signal is TRUE.

OUTPUTS:

Output Signal: Data type. The accumulated count is output.

ICON CONFIGURATION DIALOG BOX:

CONFIGURATION OPTIONS:

Icon Name: Specify the label for the icon. This name will show directly under the icon within the Program Net.

When _____ Update pulse is received, output the _____ count total: HyperNet completes this functional statement using the names of the Outputs from the icons that are connected to this Counter icon's Enable and Signal Inputs.

Clear Counter on Output: If this check box is checked, after the accumulated count total is passed to the Output, the total will be cleared and counting will restart from 0. If the box is not checked, counting will be cumulative, adding on to the current total.

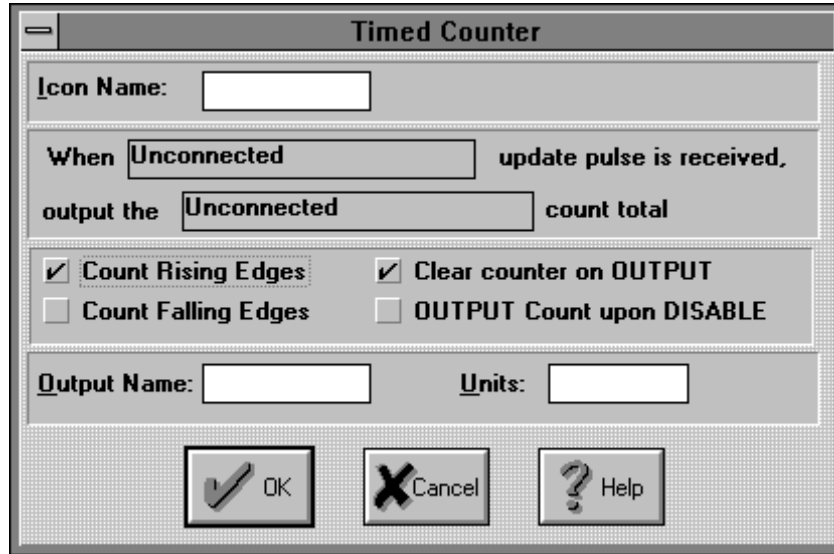

Count Rising / Falling Edges: The Up Counter increments its accumulated count when its input changes state. The User can use this option to specify whether Rising (False to True) or Falling (True to False) transitions (edges) are to be counted.

Output Count upon disable: Check this box to force an output of the accumulated Count at any time that the icon is disabled. If this box is not checked, upon receipt of a disable signal, the Counting function will be momentarily suspended until the icon is re-enabled and no in-process value will be output.

For example, if a Count is to be output when a one hour Update Pulse has been received but only 20 minutes have gone by and the icon is disabled, the 20 minute sample Count total will be output and the counting function will be suspended until re-enabled. Upon re-enable, counting will continue and after 40 more minutes, the hourly Count Total will be output (unless the following check box is checked)

Count Rising / Falling Edges: The Timed Counter increments its accumulated count when its input changes state. The User can use this option to specify whether Rising (False to True) or Falling (True to False) transitions (edges) are to be counted.

Units: Provides a text box for User entry of a units label that will be shown at the output from this icon. Conversion to other units can be performed within a Program Net by adding a Math Icon onto this icon's output.

Output Name: Specify the label for the Output. This name will show directly under the Output terminal within the Program Net.

UP COUNTER FUNCTION ICON

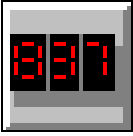

The Up Counter is a software counter that can be used within a Net to count up to a User defined count value, then output the count. After outputting the count, the Up Counter clears the counter and starts counting up again.

An example application follows:

An input signal (logic) is generated every time a widget is produced on a production line. The User wants to log the time to produce 100 widgets. With the Up Counter programmed to 100, every time 100 event inputs are accumulated, the icon will output the value 100 to memory.

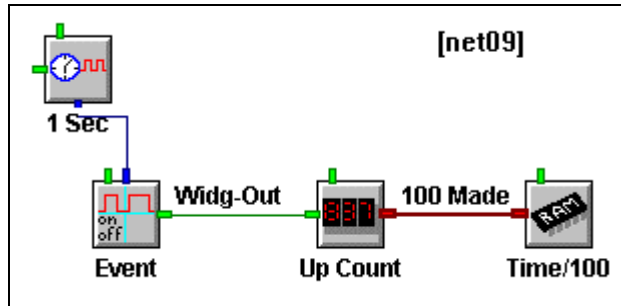

INPUTS:

Data/Logic Signal: Logic (True/False) type.

Enable: Processing of icon is allowed when Enable pin is unconnected or when connected *and* Enable signal is TRUE.

OUTPUTS:

Output Signal: Data type. The accumulated count is output.

ICON CONFIGURATION DIALOG BOX:

Up Counter

Icon Name:

Input Name:

Output Count after **input transitions received**

CLEAR Transition and Input Counts upon ENABLE
 Count Rising Edges Clear counter on OUTPUT
 Count Falling Edges OUTPUT Count upon DISABLE

Output Name: **Units:**

CONFIGURATION OPTIONS:

Icon Name: Specify the label for the icon. This name will show directly under the icon within the Program Net.

Input Name: In this box, HyperNet displays the Output Name of the icon connected to this icon's Input. The Output Name can be changed in the other icon's dialog.

Output Count after ____ input transitions received: When the number of transitions received on the Up Counter's Input equals this User supplied value, the value is passed to the Output and the count resumes again at 0.

Count Rising / Falling Edges: The Up Counter increments its accumulated count when its input changes state. The User can use this option to specify whether Rising (False to True) or Falling (True to False) transitions (edges) are to be counted.

Output Count upon disable: Check this box to force an output of the accumulated Count at any time that the icon is disabled. If this box is not checked, upon receipt of a disable signal, the Counting function will be momentarily suspended until the icon is re-enabled and no in-process value will be output.

For example, if a Count is to be output after 100 samples have been received but only 60 have been received and the icon is disabled, the 60 sample Count total will be output and the counting function will be suspended until re-enabled. Upon re-enable, counting will continue and after 40 more samples are received, the 100 sample Count Total will be output (unless the following check box is checked)

Clear Transition and Input Counts upon Enable: Check this box to force a reset of the accumulated Count Total as well as the Sample count used for the calculation upon receipt of an Enable signal.

If this box is not checked, upon receipt of an Enable signal, counting calculation will proceed from its suspended state (that it entered when it was disabled).

Clear Counter on Output: Check this box to force the Count Value to be reset to 0 after Output. If this box is not checked, the icon will perform as a counting totalizer

Units: Provides a text box for User entry of a units label that will be shown at the output from this icon. Conversion to other units can be performed within a Program Net by adding a Math Icon onto this icon's output.

Output Name: Specify the label for the Output. This name will show directly under the Output terminal within the Program Net.

SAMPLE RATE CLOCK FUNCTION ICON

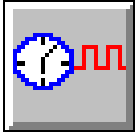

The Sample Rate Clock icon generates the Update signal/command used throughout Nets to set Sampling Rates of the different input type icons. (The icon derives its clock rate from a OM-320 internal clock.)

When the Sample Rate Clock generates an Update command, it causes the connected icons to read their inputs, process the signal accordingly, then Update their Outputs. Sample Rate Clocks within a Net set the pace at which the various branches of the Program Net sequence.

Multiple Sample Rate Clocks can be used within a single Program Net to provide different sampling rates.

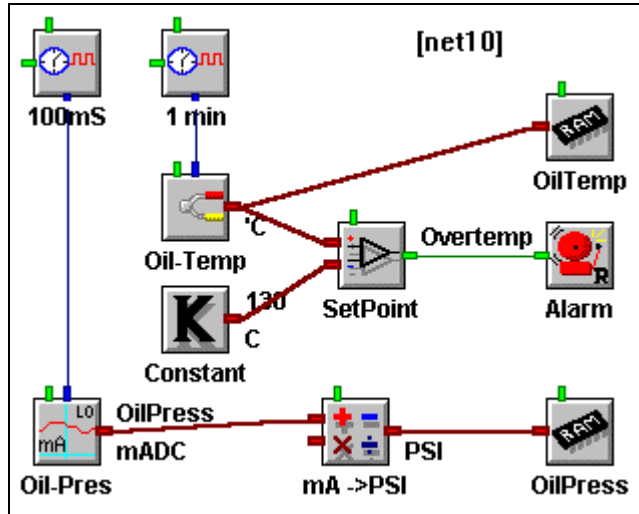

INPUTS:

Alternate Rate Input: Logic type input. The Sample Rate Clock has a Logic Input terminal that is used to control which of two clock rates will be output (see Sample Rate Clock Configuration Dialog below) .

If the Alternate Rate Input is left unconnected, Update pulses will be output at the standard rate. If connected to a Logic type (True/False) Output from another icon (as shown in the Net below), the state of this signal will determine which of two rates will be used. When the Input is LOW, the Standard Update rate will be output. When the Input is TRUE (in the Net below, when an overtemp condition occurs) , the Alternate faster Clock Update rate will be output.

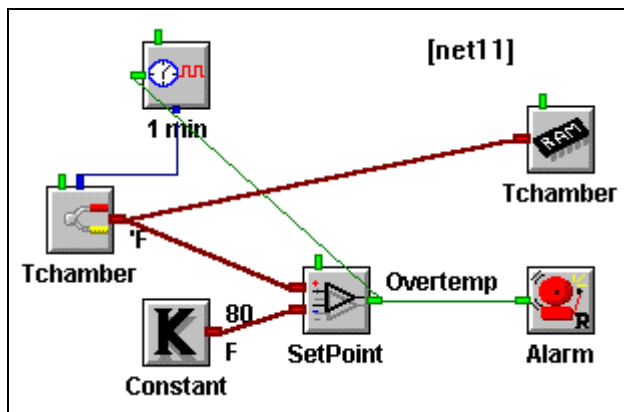

NOTE: The link (connection to the Alternate Rate Input on the Sample Rate Clock is unique in that it feeds back from an Output terminal to an Input terminal that is to the left on the screen. This is the only link that can be connected this way. *To make the connection, drag the link from the Sample Rate Clock Input terminal to the Output terminal (left to right).*

Enable: Processing of icon is allowed when Enable pin is unconnected or when connected *and* Enable signal is TRUE.

The Enable terminal can be left unconnected, connected to a Start/Stop Clock icon, or connected to any other logic signal. This could control the generation of Update signals as a condition of some other parameter.

OUTPUTS:

Output Signal: Update type. The Sample Rate Clock icon is the only icon that can generate an Update command/signal. (The Warm-up icon does not actually generate an Update signal, it just passes it through).

ICON CONFIGURATION DIALOG BOX:

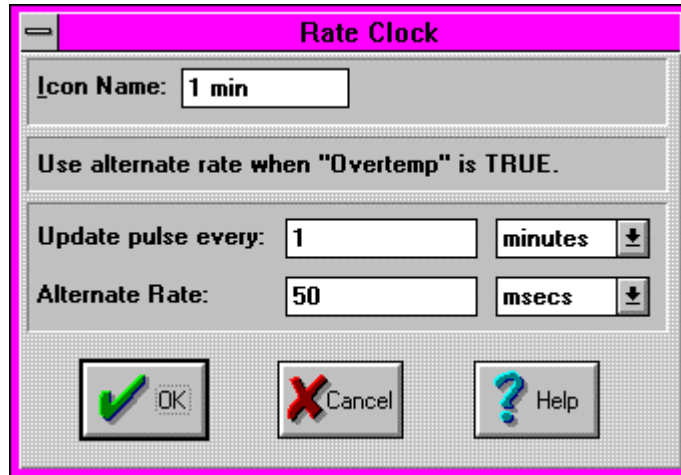

CONFIGURATION OPTIONS:

Icon Name: Specify the label for the icon. This name will show directly under the icon within the Program Net.

Never use Alternate Rate / Use Alternate Rate when _____ is True: If the Alternate Rate Input is left unconnected, **Never use Alternate Rate** will be displayed.

When a link is made to the Alternate Rate Input, **Use Alternate Rate when `_____` is True** is displayed. In quotes, HyperNet displays the Output Name of the icon connected to the Alternate Rate Input terminal. The displayed Output Name can be changed in the other icon's dialog.

Update pulse every: A text box is provided for User entry of a number. The units (seconds, minutes, hours, days) can be specified via the list box.

NOTE: To specify Update signal rates faster than 1 second, set the **Sample Rate Clock Resolution** to **milliseconds** from within the Global icon Configuration dialog. Use of the millisecond setting will result in higher power consumption as the OM-320 microprocessor is continually running during this mode. In the **Seconds** mode, the microprocessor is put to a low power `sleep` mode during times of inactivity.

NOTE: In MILLISECOND Mode, logging sessions must be limited to a maximum length of 2 weeks. This limitation holds for both Rotary and Log to Full Memory modes.

11.. . APPENDIX A: MASTER ICON FILE REFERENCE

This 2 week limit is due to a maximum time count that the OM-320 can internally store at the faster clock rate. For sessions longer than 2 weeks, utilize the SECOND mode. Refer to Global icon listing for additional information.

Alternate Rate: If a Logic link is connected to the Alternate Rate Input terminal, the Alternate Rate setting is enabled. Enter the Update pulse rate to be used when the Alternate Rate Input connection is True.

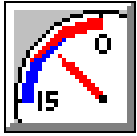

WARM-UP FUNCTION ICON

The Warm-up icon is a special two Output terminal icon. It immediately outputs a logic signal on one terminal upon receipt of an Update signal, then after a User programmed delay, passes the Update signal to its second Output.

The typical application for the Warm-Up icon is to provide control of a power supply for excitation of a sensor or transmitter and a short delay until the sensor/transmitter is read. The following example Net illustrates that application. Upon receipt of the Update command from the Sample Rate Clock, the Warm-up icon immediately cycles its Logic Output terminal True which turns on the connected Relay Alarm icon to power up a 24VDC power supply for the 4-20mA loop excitation. The icon then waits for a User defined period of time, then passes the Update command to the connected mA-Lo (4-20ma) Input icon which then takes a sample. The next time the Net is executed, the power supply is turned OFF.

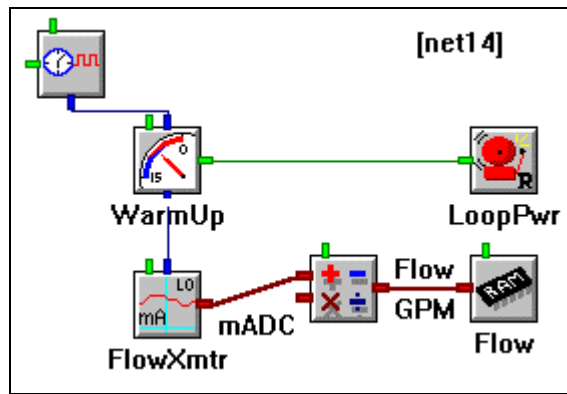

INPUTS:

Update: The icon immediately turns its Logic Output True when an Update command is received. The Output stays True until the User provided time expires.

Enable: Processing of the icon is allowed when the Enable pin is unconnected or when connected *and* Enable signal is TRUE.

OUTPUTS:

Output Signal 1: Logic type. The Logic Output turns True and stays True immediately after receipt of an Update command.

Output Signal 2: Update type. The Update command is passed through the icon after a User defined delay (warm-up time).

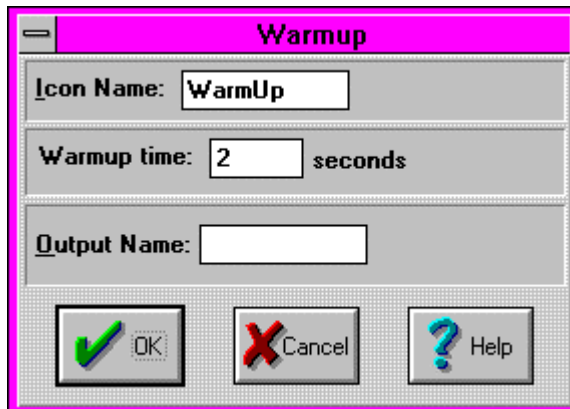

ICON CONFIGURATION DIALOG BOX:

CONFIGURATION OPTIONS:

Icon Name: Specify the label for the icon. This name will show directly under the icon within the Program Net.

WarmUp Time A text box is provided for User specification of the desired warmup time delay between the Logic Output turnTrue and the pass through of the Update command. The time is in seconds.

Output Name: Specify the label for the Output. This name will show directly under the Output terminal within the Program Net.

PERIODIC OUTPUT FUNCTION ICON

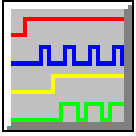

FUNCTION:

The Periodic Output Icon generates a Square Wave/Pulse output based upon time values entered by the user in the configuration dialog box. When the icon's Enable pin goes HI, the output remains LOW for a specified period. The output then goes HI for a user defined period before going back to a LOW state. This cycle is then repeated a specified number of times or continuously. There are two modes of operation that define the icon's behavior when its Enable pin returns LOW, Reset Upon Disable, and Suspend While Disabled.

Reset Upon Enable: In this mode, whenever the Enable input goes from HI to LOW, the operation is reset. The next time the Enable pin goes HI, the cycle starts from the beginning.

Suspend While Disabled: In this mode, whenever the Enable input goes from HI to LOW, the operation is suspended. All timers are put on hold while the Enable is LOW. The next time the Enable goes HI, operation continues where it left off.

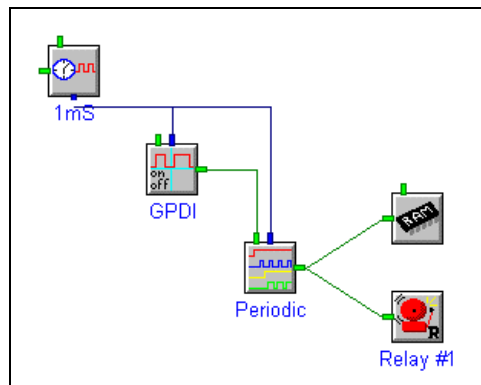

The above net displays a typical application. The Periodic Output Icon is used to cycle a OM-320 Relay Output On and Off at regular intervals, whenever the GPMI input is ON. Another possible application is to insert a time delay into an Event (Logic Type) signal branch.

NOTE: At least one Sample Rate Clock icon is required in every net program. This icon must always be enabled (Enable pin disconnected or ON).

INPUTS:

Enable: Processing of icon is allowed when Enable pin is connected or when connected and Enable signal is TRUE.

OUTPUTS:

Output Signal: Logic Type. The output is TRUE during user defined time windows.

ICON CONFIGURATION DIALOG BOX:

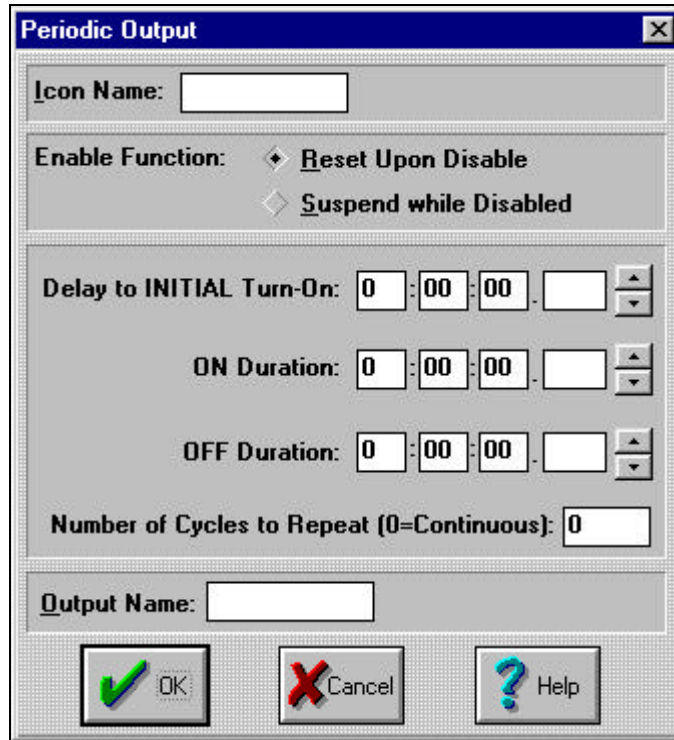

CONFIGURATION OPTIONS:

Icon Name: Specify the label for the icon. This name will show directly under the icon within the Program Net.

Reset Upon Enable/Suspend While Enabled: Specifies the mode of operation..

Delay to Initial Turn-On: Amount of time after the Enable input goes HI, that the output remains LOW. If the Enable pin is not connected, it is HI. In this case, the Delay is the time delay after enabling the OM-320 itself.

On Duration:.. Amount of time the output remains HI.

Off Duration:..Amount of time the output remains LOW.

Number of Cycles to Repeat: Number of times that the specified cycle will repeat. Entering zero will cause the cycle to repeat continuously.

NOTE: The Delay to Initial Turn-On time is not repeated.

Output Name:Specify the label for the Output. This name will show directly under the Output terminal within the Program Net.

NOTE: The millisecond entry box is disabled if the mS mode is not selected in the Global icon.

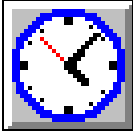

START/STOP CLOCK FUNCTION ICON

The Start/Stop Clock icon generates a Logic output that is a function of a User defined time. Two different modes of operation are available, Absolute Start/Stop and Delayed Start/Stop.

Absolute Start/Stop Mode: In this mode, the icon output is True for a User defined window of time. The User can specify the Start and Stop dates and times.

Delayed Start/Stop Mode: The icon output goes True at a User specified elapsed time after the OM-320 is Enabled, then stays True for a User specified length of time before returning False.

NOTE: In both modes, after the Start/Stop clock `stops`, the OM-320 will continue to be Enabled. However, any icons in the Net that are controlled by the Start/Stop icon will not update. Alarms will remain in the state they are in when the Stop occurs.

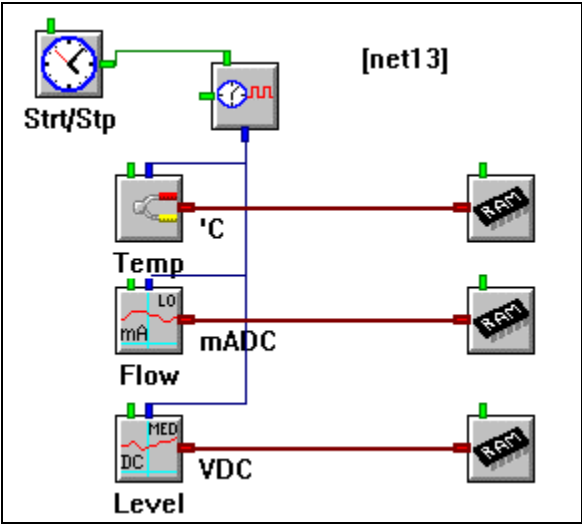

A typical application of this icon is to enable an unattended OM-320 at some particular future time, then disable after a period of time. The following Net illustrates that application:

INPUTS:

Enable: Processing of icon is allowed when Enable pin is unconnected or when connected *and* Enable signal is TRUE.

OUTPUTS:

Output Signal: Logic type. The Output is True during User defined time windows.

ICON CONFIGURATION DIALOG BOX (ABSOLUTE START/STOP MODE):

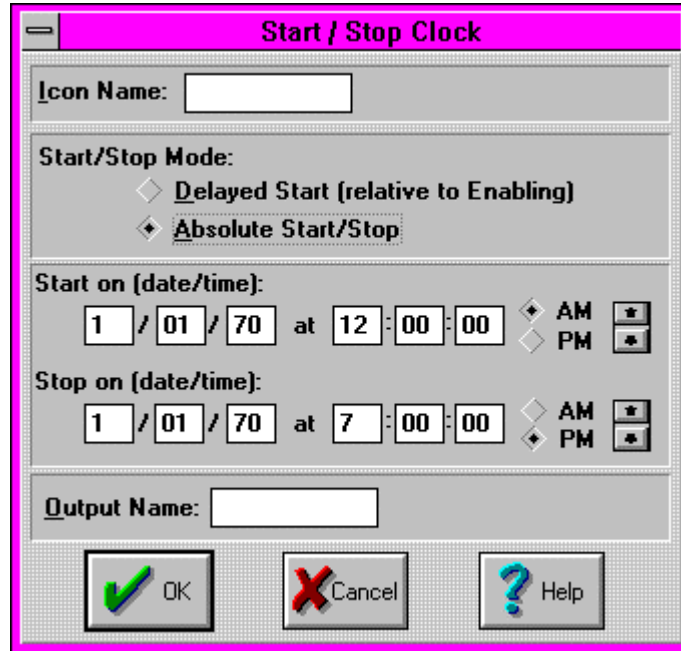

CONFIGURATION OPTIONS (ABSOLUTE START/STOP MODE):

Icon Name: Specify the label for the icon. This name will show directly under the icon within the Program Net.

Absolute Start / Stop or Delayed Start Mode: Specifies the mode of operation. The time setting boxes will change accordingly.

Start On: A text box is provided for User entry of the date and time to turn the OutputTrue.

Stop On: A text box is provided for User entry of the date and time to turn the Output OFF.

Output Name: Specify a name for the Output signal from this icon. This Output Name will be referenced by other icons downstream in the Program Net.

ICON CONFIGURATION DIALOG BOX (DELAYED START/STOP MODE):



Start / Stop Clock

Icon Name:

Start/Stop Mode:

- Delayed Start (relative to Enabling)
- Absolute Start/Stop

Start after (elapsed hh:mm:ss): : :

Stay on for (hh:mm:ss): : :

Output Name:

OK Cancel Help

CONFIGURATION OPTIONS (ABSOLUTE START/STOP MODE):

Icon Name: Specify the label for the icon. This name will show directly under the icon within the Program Net.

Absolute Start / Stop or Delayed Start Mode: Specifies the mode of operation. The time setting boxes will change accordingly.

Start After (elapsed HH:MM:SS): A text box is provided for User entry of the time to delay before starting (turning the Output True).

Stay ON for: A text box is provided for User entry of the time to leave the Output True.

Output Name: Specify a name for the Output signal from this icon. This Output Name will be referenced by other icons downstream in the Program Net.



STOP LOGGING FUNCTION ICON

When the Stop Logging icon receives a Logic True input, it stops the OM-320 execution of the Program Net. The function is the same as if the front panel STOP button were pressed.

In the following example Net, if the flow ever drops to less than 10GPH, the OM-320 will stop logging. In this Net, logging will not restart, even if the flow increases to over 10GPH again.

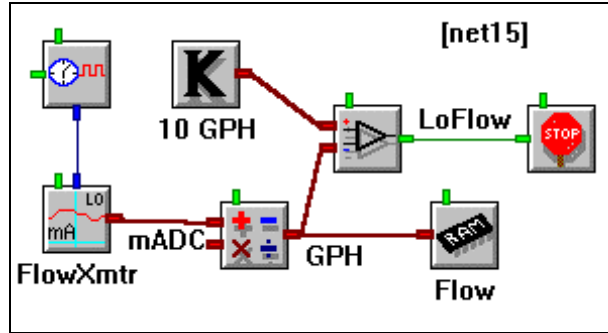

INPUTS:

Data/Logic Signal: Logic type (True/False). A True signal on this input Stops execution of the OM-320 Program Net..

Enable: Processing of the icon is allowed when the Enable pin is unconnected or when connected *and* Enable signal is TRUE.

OUTPUTS:

Output Signal: Internal system control output only. No output terminal shown on icon for Program Net connections.

ICON CONFIGURATION DIALOG BOX:

No Configuration Dialog is provided.

WARNING FUNCTION ICON

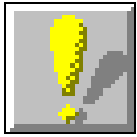

The Warning icon outputs a True Logic signal while any of five User selected system conditions are true. Multiple Warning icons can be used in a Program Net to initiate alarming or other action upon different conditions. The following example illustrates activation of a Page (and front panel LED) if the OM-320 memory fills to 90%.

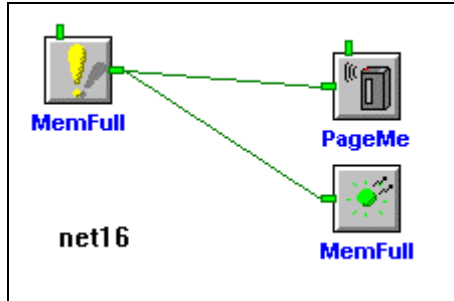

INPUTS:

Data/Logic Signal: None, internal system status only. No terminals shown for icon connections in Net.

Enable: Processing of the icon is allowed when the Enable pin is unconnected or when connected *and* Enable signal is TRUE.

OUTPUTS:

Output Signal: Logic (True/False). Output is TRUE only while any of the five conditions are true. A Latch icon can be connected to the Output of this icon if a latching function is desired.

ICON CONFIGURATION DIALOG BOX:

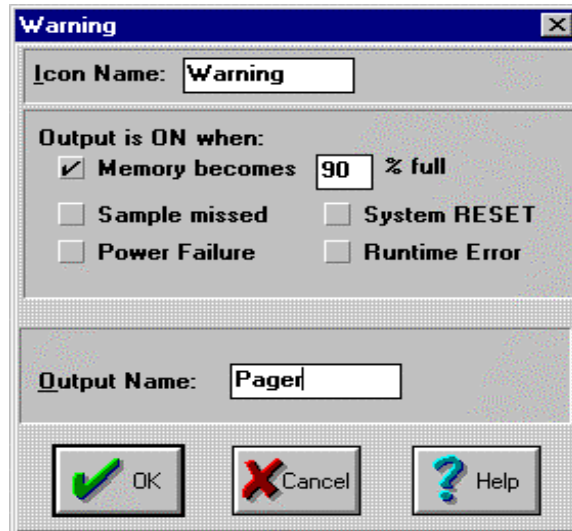

CONFIGURATION OPTIONS:

Icon Name: Specify the label for the icon. This name will show directly under the icon within the Program Net.

Output is True when: Check boxes are provided for User selection of up to five conditions, *any of which* will cause the icon Output to go True. Note that the Output will only stay TRUE while the condition is true. The five conditions are:

1. **Memory Becomes ___%Full** - Output latches TRUE if OM-320 memory is filled to the specified percentage. Output goes LOW when Memory is cleared (unless some other condition is true, forcing the Warning icon Output TRUE).
2. **Sample Missed** - Output latches TRUE if a sample is missed (ie not taken at the Sample Rate Clock commanded time) during execution of a Program Net. This can occur if a Net requires more time to process than the User has specified via Sample Rate Clock Update rates. Note that missing a sample does not cause the Program Net to stop. The Output is reset LOW when the Program Net is Stopped.
3. **Power Failure** - a Power Failure occurs when the OM-320 power supply voltage falls below a useable level. If this occurs, the OM-320 stops execution of the Program Net, preserves data memory, and sets a memory marker (flag) that indicates that a Power Failure has occurred. When the power to the OM-320 returns, the Warning icon Output latches TRUE indicating that a Power Failure has occurred, and the OM-320 will automatically resume execution of the Program Net however the icon Output will remain TRUE. The Output is set LOW when the Program Net is stopped. This condition is mainly used to indicate to a User that a Power Failure occurred at some time. For warning of impending power failure, use the Power Low condition (above).
4. **System RESET** - if a System RESET occurs, the Output latches TRUE. The Watch-Dog Timer or a front panel RESET can cause a System RESET to occur. The Output is set LOW when the Program Net is stopped.
5. **Runtime Error** - if a Runtime Error occurs, the Output latches TRUE. Runtime errors should normally not occur, but could be caused by a corrupted Program Net in the OM-320's memory. A Runtime error could also be caused by incompatible OM-320 and HyperWare versions. The Output is set LOW when the Program Net is stopped.

Output Name: Specify a name for the Output signal from this icon. This Output Name will be referenced by other icons downstream in the Program Net.

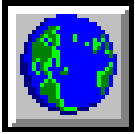

GLOBAL FUNCTION ICON

The Global icon provides for User specification of various OM-320 system settings that may be used during the execution of a Program Net. No Input or Output terminals are available on the icon.

INPUTS:

- Data/Logic Signal:** None.
- Enable:** None. Icon is always enabled.

OUTPUTS:

- Output Signal:** None

ICON CONFIGURATION DIALOG BOX:

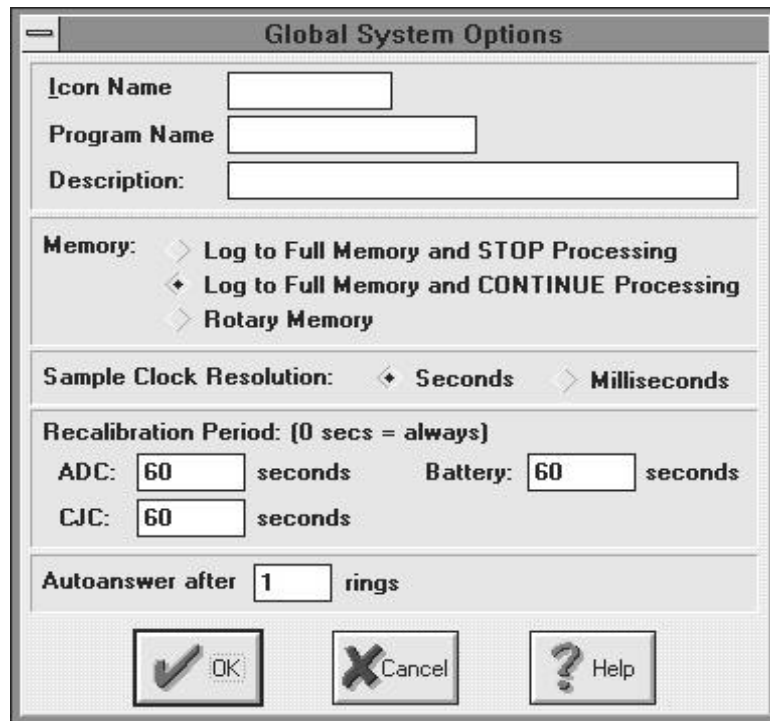

CONFIGURATION OPTIONS:

- Icon Name:** Specify a label for the icon. This label will appear directly below the icon. A suggested use for this name is to enter the filename for the Program Net... allowing for quick future reference.
- Program Name:** A short (16 characters maximum) Program Net name can be entered via this text box. This name can be accessed on the OM-320 front panel LCD as well as through a Status Query serial communication command.
- Program Description:** A short (32 characters maximum) Program Net description can be entered via this text box. This name can be accessed on the OM-320 front panel LCD as well as through a Status Query serial communication command.

11.. . APPENDIX A: MASTER ICON FILE REFERENCE

Memory: Three selections are available for utilization of the OM-320 memory:

Log to Full Memory and STOP Processing - if selected, the OM-320 will log data until memory is filled, then stop execution of the Program Net and go into a low power sleep mode.

NOTE: If MILLISECOND Sample Clock Resolution is selected (see below) logging sessions must be limited to a maximum length of 40 days.

Log to Full Memory and CONTINUE Processing - if selected, the OM-320 will log data until memory is filled, then continue the execution of the Program Net excluding the storage of data to memory. This mode allows all of the non-Memory icons in the Program Net to continue operation providing continued Alarm, Probe Point, etc access.

NOTE: If MILLISECOND Sample Clock Resolution is selected (see below) memory must be filled before a maximum of 40 days after Enabling the OM-320 . Processing will continue after the 40 day limitation.

Rotary Memory - if selected, the OM-320 will log data until the memory is filled, then begin overwriting the oldest sample in memory. Processing of the complete Program Net will continue as normal.

NOTE: If MILLISECOND Sample Clock Resolution is selected (see below) logging sessions must be limited to a maximum length of 40 days.

Sample Clock Resolution: Two options are available for selecting the time resolution of the OM-320.

SECONDS - This mode should be used for all Program Nets that have Sample Rate Clocks set at 1 second or slower. In this mode, the OM-320 `sleeps' in a low-power mode during times of inactivity, providing extended battery life. Sample Rate Clocks can be set as fast as 1 second.

MILLISECONDS - This mode must be used if any Sample Rate Clocks will be set at faster than 1 second rates. In this mode, the OM-320 can resolve time increments as small as 1/1000 of a second. **NOTE:** Use of the millisecond mode will result in higher power consumption as the OM-320 microprocessor is continually operating. Depending on the Program Net, the energy consumption in this mode may be approximately 10 to 15 times higher than in the SECOND mode.

NOTE: In MILLISECOND Mode, logging sessions must be limited to a maximum length of 40 days. This limitation holds for both Rotary and Log to Full Memory modes. This 40 day limit is due to a maximum time count that the OM-320 can internally store at the faster clock rate. For sessions longer than 40 days, utilize the SECOND mode.

Recalibration Period: The OM-320 performs various self-calibrations during execution of a Program Net. The User can specify the frequency of these calibrations. If a 0 is entered for the period, a recalibration will be performed at the start of each Program Net execution. If speed is not of concern, entering 0 for each of the recalibration periods will result in optimum performance.

ADC - the analog to digital converter used within the OM-320 and much of the analog circuitry incorporated into Interface Modules can drift over time and temperature fluctuations. By performing a recalibration, most of this drift can be nulled. Specify the period in seconds between recalibrations.

CJC - a Cold Junction Compensation sensor is mounted on the TSA. The temperature it measures on the TSA is used during thermocouple millivolt to temperature conversions (HLIM-1). This CJC Recalibration Period

specifies how frequently the CJC temperature is checked and updated in the thermocouple calculation equation. Any temperature error in the measurement of the TSA will result in a nearly equal error in the thermocouple reading.

TIP: If a short duration test is being performed where maximum speed of thermocouple readings is required, sufficient accuracy may be achieved by setting the Recalibration Period fairly long. In this way, a CJC recalibration will be done before the first pass through the Program Net, then the high speed readings will be taken, then another CJC recalibration. During the test, the TSA thermal mass will keep the CJC temperature fairly constant.

Battery - the internal power supply voltage is checked periodically based on the User specified Recalibration Period. This Battery voltage is used by the Warning icon for detection of a Power Low condition and for update of the OM-320 front panel LCD *System Supply Voltage* display. For most applications of OM-320s this period can be set fairly long (eg 3600 seconds) as battery voltage droops slowly. If additional loads are being powered such as modems, outputs, etc shorten this value accordingly.

If the Warning icon is not being used and battery voltage will not be checked via the LCD or through a serial communication Status Query, this Recalibration Period can be set very long.

Auto-answer after ___ ring: If a OM-320 is equipped with a modem, the number of rings to wait before answering the call can be User defined. Enter the number in the provided text box.

APPENDIX B: EXAMPLE PROGRAM NETS

Following are some example Program Nets with descriptions of their operation.

Engine Oil Cooler Performance Test:

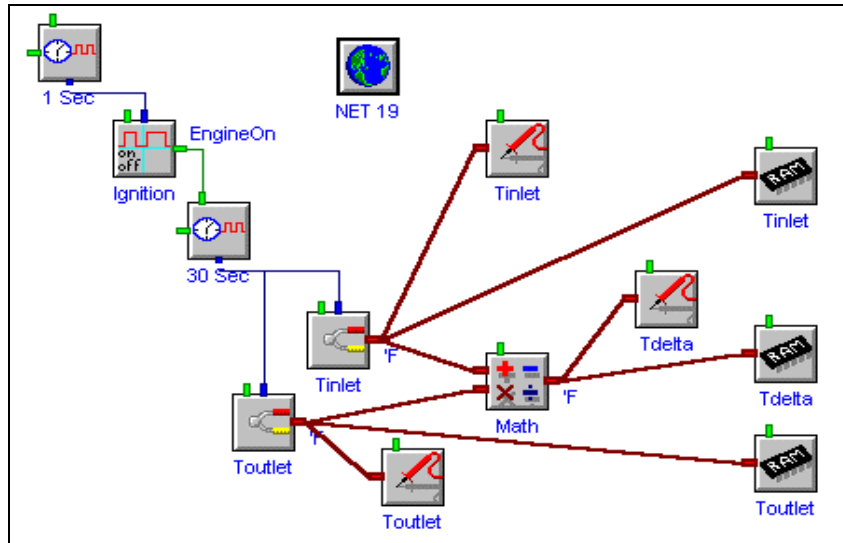

Two thermocouples are configured to sample inlet and outlet oil temperatures every 30 seconds on a heat exchanger. Logging of data only occurs when the engine ignition is ON. A delta-T calculation is performed and the inlet, outlet, and differential temperature is stored to memory. Probe icons are available for display of all three temperatures from the LCD and/or via a serial link.

Hydraulic Pump Performance Test

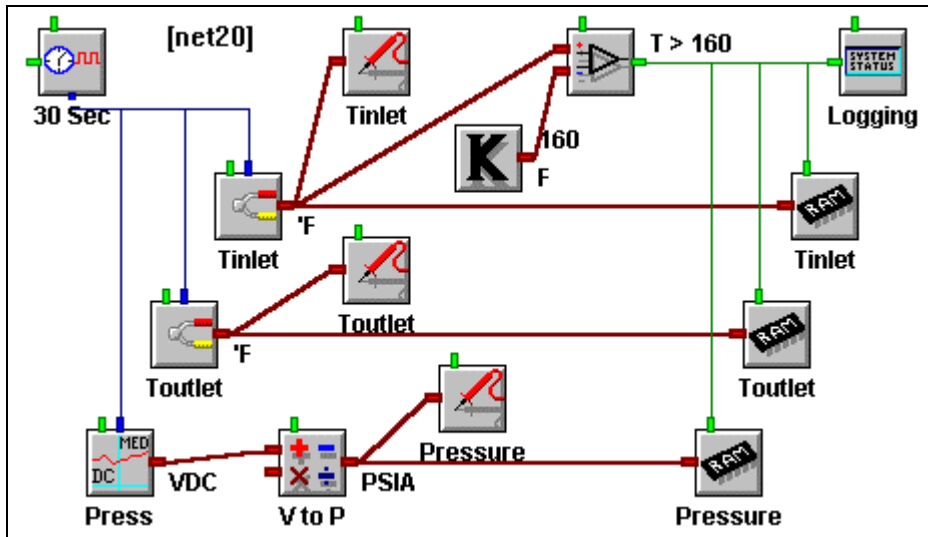

The above Net is designed for collecting data from a hydraulic pump on a vehicle during periods of high fluid temperature operation only. Two thermocouple channels and a continually powered pressure transducer are sources of input signals.

After Enabling the Net, the inputs are sampled every 30 seconds. When the Tinlet temperature exceeds 160F (Comparator and Constant icons), data storage to memory is Enabled for all three parameters and the OM-320 front panel LCD displays a message stating that the temperature currently exceeds 160F and data is being logged to memory.

The DC voltage from the pressure transducer is converted to PSI via the Math icon. Instantaneous values for the two temperatures and pressure are accessible on the OM-320 LCD and/or through a serial connection via the Probe icons.

Tank Level / Inventory Profiling Data Collection with Alarming:

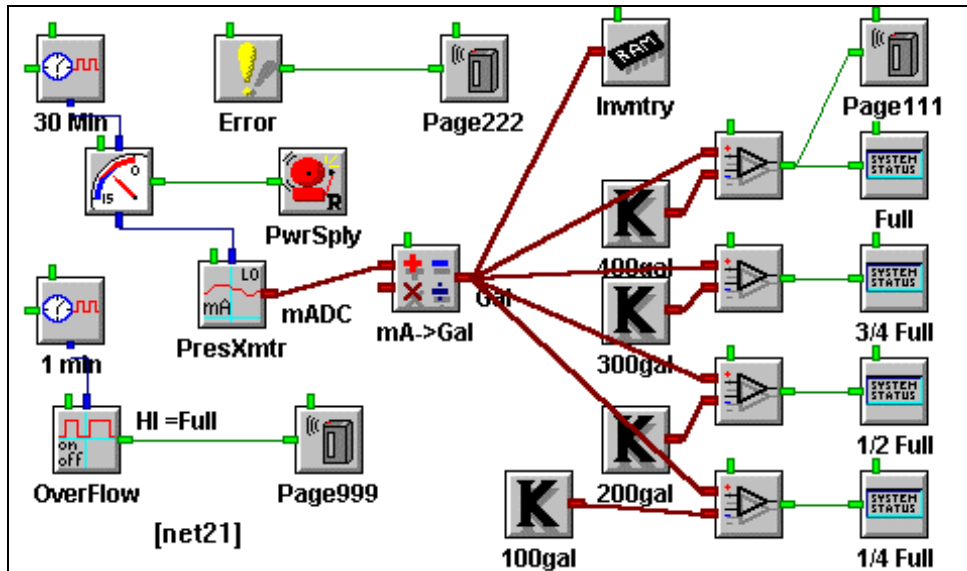

A remote site liquid tank has a constantly varying inventory as liquid is added and removed over time. Profiling of the inventory over time, onsite display of the inventory amount, and overflow telephone pager alarming are all desired.

Using a single 4-20mA pressure transmitter input and a Math icon, the inventory can be calculated in gallons. The pressure transmitter is powered from a battery which is cycled ON 10 seconds prior to reading, then OFF with the Relay icon and the Warmup icon.

Every 30 minutes, the inventory is logged to memory as well as compared (Comparator icon) to four different thresholds, 100, 200, 300, and 400 thousand gallons. The current level is displayed on the OM-320 front panel LCD.

In the event that the top threshold (full) is met, a Page is sent with a code of `111`.

Additionally, every minute, a float type level switch is read via the GPDI icon in the Event mode. When the tank gets too close to overflowing, the switch closes. This signal is then sent to the Pager icon and a Page of `999` is sent.

A separate Program Net branch is added to initiate a Page of `222` if the OM-320 memory fills or a Run-time error occurs.

High Speed Thermocouple Application:

In some applications, maximum speed of thermocouple measurement is desired. The Thermocouple icon is one of the slowest to process in a Program Net due to the intensive math associated with each sample. A Cold Junction Compensation reading is required as well as the thermocouple reading, then the two are combined through curve approximating polynomials... heavy math for the OM-320.

A method to improve on the throughput rate of thermocouple inputs exists. If the thermocouple inputs are read as mV signals (which are processed very quickly) and the CJC is read as a resistance (which is lots faster than temperature), the net will process many times faster. The mV readings from the Thermocouple icon and the resistance reading from the CJC icon are then merged in a Post-Processing Net and the results (in degrees) are put into a destination *.HLD file for plotting.

The following Program Net represents an application of this method of high speed thermocouple temperature data collection. Temperature rise data on components within an automobile brake is desired. Thermocouples are installed and connected to OM-320 input channels configured as mV inputs. The TSA CJC input is sent to memory in units of OHMS.

A unique triggering scheme is implemented with the Event icon and three Sample Rate Clocks. One Sample Rate Clock causes the Event icon to sample the status of a switch connected to the brake pedal every 10mS. When the switch is open (ie brakes NOT activated) the CJC icon is enabled and the Sample Rate Clock sends a reading to memory every second. Additionally, the 50mS Sample Rate Clock is sampling at its primary rate which is set to 1 second.

When the brake pedal is depressed, the CJC icon is disabled and the 50mS Sample Rate Clock driving the three Voltage icons (thermocouple inputs) switches to its Alternate rate, storing readings to memory every 50mS.

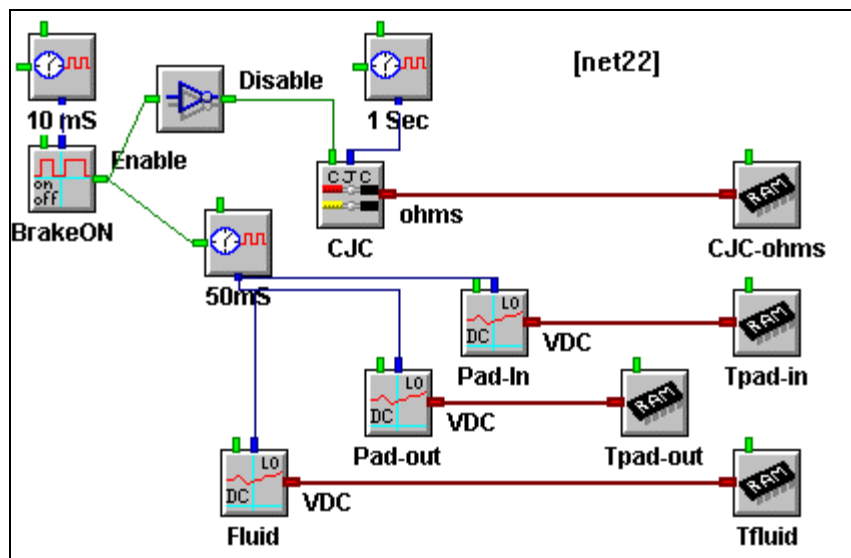

After the data has been collected and downloaded to the PC, a Post-Processing Net is constructed as shown in the following diagram.

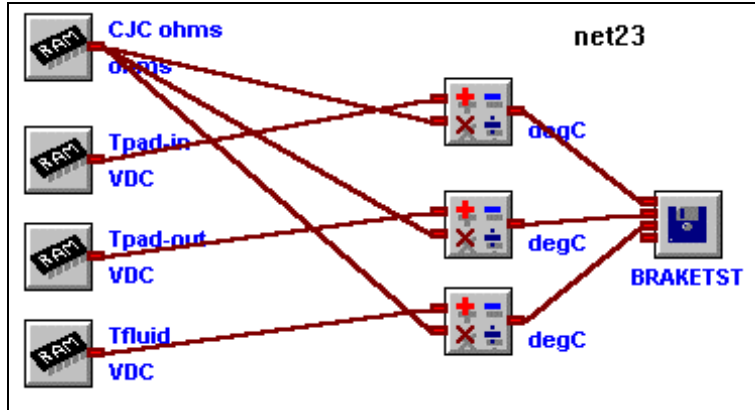

This Post-Processing Net combines the voltage data from the thermocouple input channels and the CJC readings (in ohms) to calculate the actual temperature of each of the three thermocouple channels and store the data in a new destination file called BRAKETST.HLD. This special calculation is done using the function TC_J(X,Y) in each of the three Math icons.

11.. . APPENDIX B: EXAMPLE PROGRAM NETS

NOTES:

APPENDIX C: HYPERWARE FILE LISTING

During the installation of the HyperWare package, the following files and directories are created on the PC hard disk. The file listing uses the default sub-directory names offered during the installation process. If different names were chosen by the User during installation, the files will be installed in those respective directories.

To uninstall the HyperWare software, locate and delete all of the listed files from the hard drive. Note that no modifications are done to the Windows system or configuration files during the installation process.

HyperWare installation generated files:

Path and File	Description
\HYPERWAR\HYPERLOG.EXE	Main HyperWare program
\HYPERWAR\WAVE.EXE	HyperPlot graphing program
\HYPERWAR\BC402RTL.DLL	program library
\HYPERWAR\BIDS402.DLL	program library
\HYPERWAR\OWL202.DLL	program library
\HYPERWAR\DBWIN.DLL	program library
\HYPERWAR\DIBAPI.DLL	program library
\HYPERWAR\CLIB.DLL	program library
\HYPERWAR\HYPERWAR.HLP	Help file
\HYPERWAR\nOTES.TXT	TSA I/O Listing comments
\HYPERWAR\DATAx.HLD	Example download files
\HYPERWAR\DEMO_X.NET	Example Program Net files
\HYPERWAR\TEST.PST	Example Post-Processing Net
\HYPERWAR\TEST.PRB	Example HyperTrack Net
\HYPERWAR\TEST.NET	Example OM-320 Program Net
\HYPERWAR\TEST.HLD	Example OM-320 Download file
\HYPERWAR\README.TXT	Late breaking notes and comments
\WINDOWS\MATH.LIB	Math function library
\WINDOWS\HYPERLOG.INI	Program configuration file

NOTE: During the HyperWare installation process, a file called BWCC.DLL is installed into the Windows directory (if it does not already exist in that directory). This file is common to many different software applications and should not be removed as it may be required by these other applications.

11.. . APPENDIX C: HYPERWARE FILE LISTING

NOTES:

APPENDIX D: CHANGING THE CLOCK / MEMORY BACKUP BATTERY

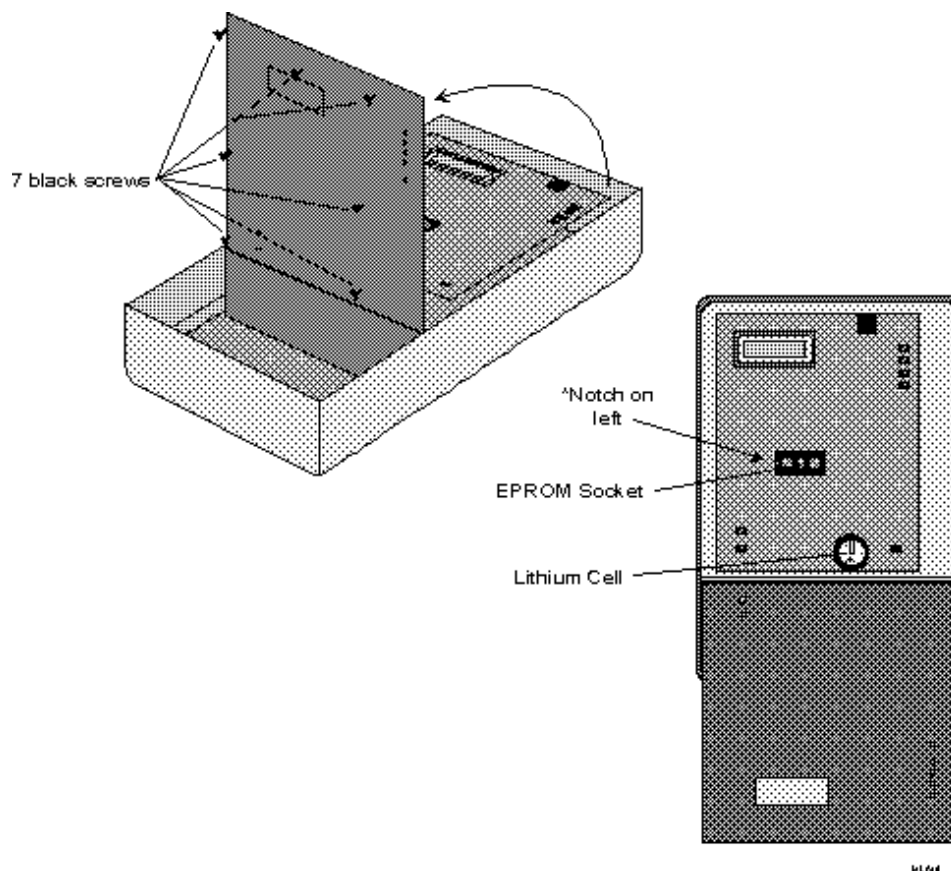

The OM-320 internal memory and real-time clock are powered from a Panasonic BR2325 (or equivalent) lithium cell when the OM-320 Main Power switch is OFF. The cell is mounted in a socket located on the main microprocessor circuit board which is located directly under the OM-320 front panel.

To change the lithium cell:

1. Download any valuable data retained in OM-320 memory.
2. Turn off the OM-320 power
3. Remove the retaining screw holding the TSA in place, then unplug the TSA.
4. Remove the 7 black machine screws located on the OM-320 front panel. These screws hold the OM-320 circuit board assembly to the front panel.
5. Remove the two thumbscrews at the top of the OM-320 enclosure and carefully swing the OM-320 front panel open.
6. The lithium cell is located in the socket at the lower right corner of the exposed circuit board.
7. Gently pry the cell to be replaced out of its holder with a small, blunt, non-metallic tool being careful not to puncture the cell or

11.. . APPENDIX D: CHANGING THE CLOCK / MEMORY BACKUP BATTERY

damage any surrounding circuitry. Insulated tweezers may assist in pulling the cell out of the holder. Use care during this step so that the spring loaded contact is not bent up excessively.

8. Slide a new cell (Panasonic BR2323 or equivalent) into the holder with the positive terminal UP. A properly installed cell will seat approximately flush with the top of the socket.
9. Slowly swing the OM-320 front panel back in place over the circuit board assembly while aligning and guiding the switches, buttons, and RS-232 jack through the front panel holes.
10. Install the 7 black screws and tighten slowly while insuring that all of the switches, buttons and other components project through their respective openings.
11. Reinstall the TSA and power up the OM-320. Clear the unit memory and upon loading of a new Program Net, the unit is ready to deploy.

CAUTION

Use care in handling lithium cells. Currently manufactured cells such as the BR2325 are very stable and safe parts, however, DO NOT TEMPT FATE! Do not puncture, short, or dispose of in fire as explosions could occur.

NOTES:

APPENDIX E: CHANGING THE OM-320 EPROM

The EPROM (Eraseable /Programmable Read Only Memory) contains the software code which controls the function of the OM-320. Updates to add features and/or improve performance are sometimes performed on the OM-320 by changing the EPROM to a later version. If desired, contact Omega Engineering, Inc Service/Repair Dept. about performing the upgrade. When a replacement EPROM is received, use the following procedure to remove and replace the EPROMs.

CAUTION

The EPROM chip is especially sensitive to damage from static discharge. Discharge body static before working with the OM-320 and EPROM by touching a grounded surface. Call with any questions!

To change the EPROM chip:

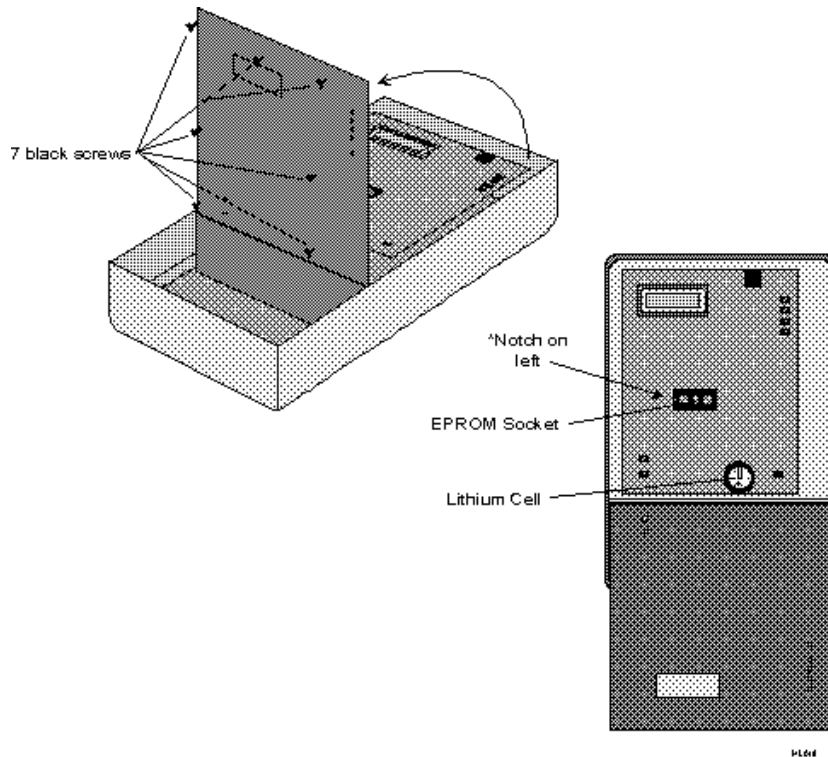

1. Download any valuable data retained in OM-320 memory.
2. Turn off the OM-320 power
3. Remove the retaining screw holding the TSA in place, then unplug the TSA.
4. Remove the 7 black machine screws located on the OM-320 front panel. These screws hold the OM-320 circuit board assembly to the front panel.

11.. . APPENDIX E: CHANGING THE OM-320 EPROM

5. Remove the two thumbscrews at the top of the OM-320 enclosure and carefully swing the OM-320 front panel open.
6. The EPROM is located in a socket near the center of the exposed circuit board.
7. Gently pry the EPROM to be replaced out of its socket with a small screwdriver or other instrument. Pry at one end then the other until the EPROM is free from its socket. Be careful so that surrounding circuitry is not damaged.
8. Align the new EPROM in its socket with the small notch located to the left while making sure that each of the EPROM's legs are aligned with the mating holes in the socket.
9. Press slowly to seat the EPROM in its socket. Visually examine the installation to insure that all of the EPROM legs are inserted in their holes.
10. Slowly swing the OM-320 front panel back in place over the circuit board assembly while aligning and guiding the switches, buttons, and RS-232 jack through the front panel holes.
11. Install the 7 black screws and tighten slowly while insuring that all of the switches, buttons and other components project through their respective openings.
12. Reinstall the TSA and power up the logger. The LCD should display some verbage (which indicates that the EPROM is correctly installed). **Perform a 3-button initialization at this time with the following procedure:**
 - A. Depress and hold the NEXT button down on the front panel.
 - B. Momentarily, depress the STOP and RESET buttons.
 - C. After a second or so, release the NEXT button.

This sequence will result in a complete initialization of the unit. After a short sequence of display messages on the LCD, a *SYSTEM INITIALIZED* message should display momentarily indicating that the logger was properly initialized. If this message does not display, repeat the procedure.

13. After initialization, reprogram the logger with a new Net Program and the unit is ready to deploy

NOTES:

APPENDIX F: FILTERING OPTIONS

Many of the Interface Modules can be configured with filtering options for reducing the noise picked up on sensor or input signal wiring. A short discussion of two of the filtering methods that are available to the User through icon configuration dialog boxes follow:

ADC Input Filtering

Three levels of first order noise filtering (None, Low, Medium, High) can be enabled during many of the analog input icon configuration dialog boxes. First order filtering reduces High frequency noise that may be picked up by sensor wiring. *However*, filtering slows down the rate at which a channel can be sampled as it adds additional settling time to the total time required for a reading.

Additional settling time required for each of the three levels is specified in the table below.

If speed of execution of the Program Net is not of concern, utilize the High level of filtering for best noise rejection.

Filter Level	Additional Settling Time
None	0
Low	3 ms
Med	4.5 mS
High	12 mS

50Hz / 60Hz Software Filtering

Noise radiated from utility power lines (including house and building wiring, appliances and extension cords) and picked up by sensors and associated wiring is one of the most common sources of data acquisition error.

The OM-320 has additional software based filtering capability designed to remove 50 Hz or 60Hz power line sourced noise from incoming signals. This filtering capability is especially helpful in applications with sensors and/or wiring which is in close proximity to utility wiring.

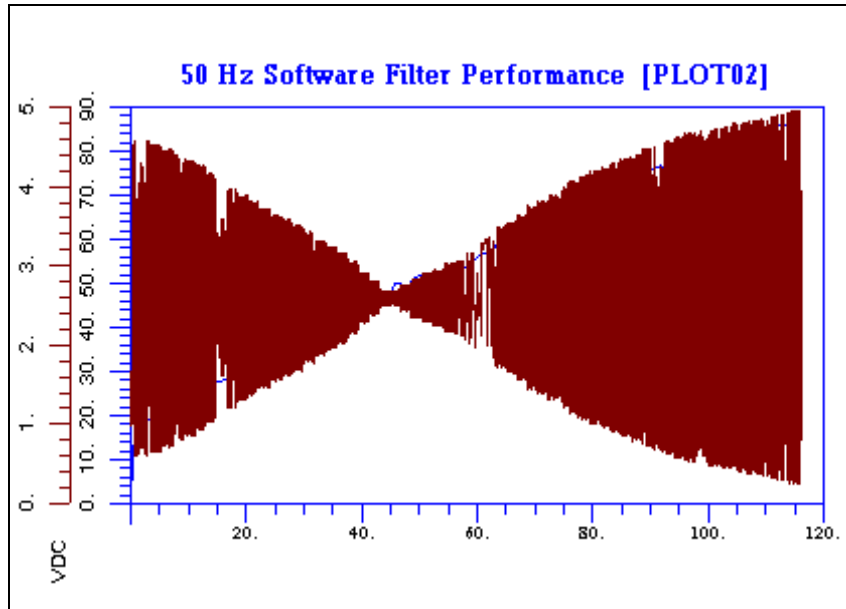

The above plot demonstrates the performance of the 50Hz software filtering. The plot is from actual data collected by a OM-320 during the development and testing of the software filtering feature. A 5Vp-p AC swept frequency was super-imposed on a 2.5VDC and input into a OM-320 equipped with an HLIM-1. The input channel was configured with the 50 Hz filtering enabled. As can be seen from the plot, at 50 Hz, the amplitude of the noise is radically reduced.

As with all filtering, a compromise is involved. Line Rejection filtering adds approximately 8.5 mS for 60 Hz rejection (10mS for 50Hz) to the measurement and processing time required for a reading.

If the desired sampling rate allows, enable Line Reject filtering by selecting 50 or 60 Hz depending on the power line frequency used in the installation locale. In the USA, 60 Hz should be selected.

APPENDIX G: HYPERNET THEORY OF OPERATION

A Program Net is a graphical representation of a sequence of commands. In the process of transferring the Program Net to the OM-320, the Program Net is converted over to a sequence of commands. When Enabled, the OM-320 microprocessor follows this sequence of commands to perform the desired functions.

During execution, the microprocessor steps through each of the commands, completing the command if possible, then moving on to the next command. This stepping through of commands can be visualized fairly accurately as propagating through connections between icons in a Program Net.

In execution of a Program Net by the OM-320 microprocessor, an order of operations is followed. The Program Net executes in approximately this order:

1. When a Sample Rate Clocks internal counter counts up to the User specified sampling period (ie the Update pulse set within the icon configuration dialog) the Sample Rate Clocks send out their Update command to any connected icons.
2. Icons connected to the Sample Rate Clock(s) then update their Outputs (eg taking a thermocouple temperature reading and presenting the value on the Output)
3. Icons connected to these Outputs then receive the new signal and process the signal and present it on their Output. This processing then progresses through the remaining icons in the Program Net from left to right.
4. When the processing has progressed completely through the Program Net the OM-320 then waits (if any time remains), waiting for the next Sample Rate Clock to generate an Update command. If the Program Net specifies Seconds resolution mode (Global Icon), the OM-320 goes into a low power sleep mode to extend battery life.
5. When the Sample Rate Clock generates the Update command, processing begins sequencing through the Program Net again.

During the execution of the Program Net, some parts of the Net may be skipped for a number of reasons. Execution will then jump to the next part of the Net and continue sequencing. Reasons that this might occur include:

- ◆ The sequence may run into an icon that is not Enabled.
- ◆ An icon may be encountered that has two inputs, where only one input was recently processed, and the User has specified that the Output is to be updated only upon Update of both inputs.

This explains why Program Nets will execute at different speeds if they contain conditional statements. For example, a Program Net may be developed that monitors a contact closure input (which can be done 100's of times per second). When the contact closes, 10 more channels may be enabled, storing data to memory. The Program Net will slow accordingly. Also, different branches of a Program Net may execute at different times if they are driven by Sample Rate Clocks that have asynchronous (ie not synchronized) Update pulse rates specified by the User.

NOTES:

APPENDIX H: ACCESSORIES

Accessory items for the OM-320 portable data logging system include:

- ◆ **Interface Modules** - the OM-320 family of products is continuing to expand with powerful plug-modules and accessories
- ◆ **OM-420** - an integrated data logging system that includes an RPS-1 rechargeable power supply and the OM-320 all ruggedly packaged in a NEMA 4X rated enclosure. With this system, higher current sensor excitation (eg 4-20mA transmitters) is simply configured. Under control of the OM-320 Program Net, the power to various sensor loops can be cycled for optimization of battery life.
The internal batteries can be recharged from photovoltaics or other low-voltage AC or DC source.
- ◆ **Photovoltaic Power Generation Systems** - for long term unattended data logging
- ◆ **RPS-1 Rechargeable Power Supply** - for higher current sensor excitation or output drive (alarm) applications
- ◆ **OEM Systems** - contact Omega Engineering about low cost "no frills" systems for integration into your manufactured equipment

Contact Omega Engineering Inc for additional information and pricing on these accessories.

NOTES:

APPENDIX I:RS-232 CABLE, PORT AND ADAPTER

PIN	Description
1	+5VDC (current limited source from OM-320)
2	Ground
3	Transmit (OM-320 output)
4	Receive (OM-320 input)
5	Not Used
6	DTR (OM-320 input; computer asserts HI to wake up the OM-320 serial port)

11.. . APPENDIX I: RS-232 CABLE, PORT AND ADAPTER

NOTES:

APPENDIX J: TROUBLESHOOTING TIPS

Refer to any README.TXT files that may be provided in the HyperWare software directory after installation for additional comments and troubleshooting tips.

TROUBLESHOOTING PROGRAM NETS:

Probe Point Diagnostics:

If operation of a Program Net is not what was expected, the judicious insertion of Probe Point icons can be a valuable troubleshooting method. This insertion of Probe Point icons at various points throughout the net allows for the real-time display of the values and/or states of various nodes in the net.

To implement this method of troubleshooting, drag additional Probe Point icons onto the screen and connect them to various outputs in the net. Transfer the net to the OM-320 and Enable the unit. Via the front panel LCD or through HyperTrack, the status of each of the Probe Point icons can be observed. These values will commonly lead you to the crux of the problem.

Incompatible Net Warning dialog:

This message normally displays during an attempted download and enable of a Program Net that does not match the current OM-320 configuration. For example if a Program Net uses channels on an Interface Module that is not currently installed in the OM-320, or if configuration switches on a module are not set correctly, the OM-320 will catch this incompatibility.

In OM-320s running at higher speeds, this message may display if a Program Net upload is attempted while the OM-320 is Enabled. If this occurs, stop the OM-320 and retry the upload.

Bad Program Net warning dialog:

If the OM-320 currently does not have a valid Program Net in memory, this message will display upon enabling.

Correct by uploading a new Program Net.

SYSTEM ERRORS:

No Display on the OM-320 LCD:

Upon power-up of the OM-320, numerous internal checks are performed. In the event that the LCD never displays the standard "OM-320" message, a number of problems could exist.

The main batteries may be discharged: a volt meter can be used to check the voltage across the batteries (remove cover and probe where the wires are soldered to the battery holders.) If no critical loads are connected to the Output Relay(s), a load can be put onto the batteries by holding one of the Relay switches in the TEST position while observing the voltage. New batteries will read approximately 9 VDC and batteries below apx 7 volts are essentially dead.

OR... apply an external supply to the EXT power terminals on the TSA.

The OM-320 may have a corrupted Program Net: A special total system initialization can be performed by simultaneously holding the front panel NEXT and STOP buttons down while momentarily tapping the RESET

11.. . APPENDIX J: TROUBLESHOOTING TIPS

button. After initialization, the LCD will display *System Initialized*. Press any front panel button to enter into normal mode.

NOTE: This 3 button reset will erase all internal data as well as the currently loaded Program Net. **Use with caution.**

SERIAL COMMUNICATION PROBLEMS:

Cannot establish an RS-232 link:

Insure that **only Omega Engineering OM-320 adapters and cables** are used. Also, insure that no gender or pinout adapters (eg 9 pin to 25 pin) are used. Pinout is critical and must be correct for communication to work. Pinout details are provided in Appendix I.

Check the Port number and that the port is actually working with another serial package and device (eg a modem).

Refer to additional considerations in the HyperComm Serial Communications chapter.

Modem Communication Problems:

Refer to Appendix K for modem configuration details.

Refer to the HyperComm Serial Communications chapter.

HYPERPLOT :

No Data Displays upon loading of File:

Data may actually be loaded but compressed. Select the Calculations\Zoom All menu choice to view.

ANALOG READINGS:

Incorrect readings on HLIM-1 Channels:

Ensure that the fuse for the particular channel is not blown.

APPENDIX K: MODEM CONFIGURATION SUPPLEMENT

As modem initialization is never as easy as it should be, this appendix was written to provide additional assistance in the configuration of modems for communication between the PC (equipped with the **LOCAL** modem) and the OM-320 (equipped with the **REMOTE** modem). Four different configurations with 2400 baud and 14.4 Kbaud modems are provided for general reference (also see modem material covered in Chapter 5).

Obviously, other combinations will exist, however, it is hoped that some understanding of the setups can be gleaned from the following examples and explanations to make life easier. Intelligent experimentation is commonly the best method for modem configuration... however, after experimentation, if a reliable connection can't be implemented, please call our technical support group for additional assistance.

Modem commands beyond the basics are not standardized and have evolved over the years as different manufacturers have implemented more advanced features. Hence, standard commands can't be supplied for the plethora of modems available on the market today. The following short list of commands is fairly consistent between modems:

AT	Attention command
&F0	Use factory defaults settings 0 (common usage)
&F1	Use factory defaults settings 1 (also common)
E0	Turn off local Echo of commands
Q0	Enable Result Codes
V1	Use Verbal Result Codes

Local 2400 to Remote 2400 (MDM-2400 Modem Option)

Within the HyperWare Modem Communication Dialog Box, set:

Baud Rate: 2400

Initialization String: AT&F0E0Q0V1 or AT&F1E0Q0V1.

This sets the local modem to its factory defaults (F0 or F1) and then turns Echo Off and enables Verbal Result Codes. (No error correction or compression is used in 2400 Baud modems so no additional settings are required to configure those features in the **Initialization String** box).

Local 2400 to Remote 14.4 (MDM-14.4 Modem Option)

Within the HyperWare Modem Communication Dialog Box, set:

Baud Rate: 2400

Initialization String: AT&F0E0Q0V1 or AT&F1E0Q0V1.

This sets the local modem to its factory defaults (F0 or F1) and then turns Echo Off and enables Verbal Result Codes (usually two commands, one to Enable Result Codes and one to select Verbal rather than numeric). (No error correction or compression is used in

11.. . APPENDIX K: MODEM CONFIGURATION

2400 Baud modems so no additional settings are required to configure those features in the **Initialization String** box).

Local 14.4 to Remote 2400

Within the HyperWare Modem Communication Dialog Box, set:

Baud Rate: 2400

Initialization String: Set to disable Error Correction, disable Data Compression, Echo Off and enable Verbal Result Codes (usually two commands, one to Enable Result Codes and one to select Verbal rather than numeric). The commands to disable the Correction and Compression functions will vary with manufacturer, so a bit of research may be required in the Modem Manual supplied with the local 14.4 modem.

Examples of functional strings for two different modems follow:

US Robotics 14.4:	AT&F1E0X4&M0
Pract Periphs 14.4:	AT&F1Q0E0V1&M0

Local 14.4 to Remote 14.4 (MDM-14.4 Modem Option)

Within the HyperWare Modem Communication Dialog Box, set:

Baud Rate: 19,200

Initialization String: Set the local modem to its factory defaults (F0 or F1) and then turn Echo Off and enable Verbal Result Codes (usually two commands, one to Enable Result Codes and one to select Verbal rather than numeric). Error correction can be enabled and will automatically be negotiated between the modems upon connection. Data Compression may be enabled on the local modem, but it will be ignored by the remote modem.

Examples of functional strings for two different modems follow:

US Robotics 14.4:	AT&F1E0X4
Pract Periphs 14.4:	AT&F1Q0E0V1