



RAEGuard 2 PID



User's Guide



RAEGuard 2 PID User's Guide

Contents

Section 1: RAEGuard 2 PID User's Guide

1	General Information	2
2	General Specifications	4
	2.1 RAEGuard 2 PID Specifications	4
	2.2 Proper Product Disposal At End Of Life	5
3	Operation	6
4	Physical Description	7
5	Physical Dimensions	7
6	Installation And Access Instructions	8
	6.1 Mounting	8
	6.2 Instrument Disassembly	10
	6.3 Electrical Wiring	11
	6.4 Wiring Procedure	12
	6.5 Earth Grounding Instructions	13
	6.5.1 External Earth Grounding	13
	6.5.2 Internal Earth Grounding	13
	6.5.3 Finished Grounding Wires	14
	6.6 Alarm Contact Setup	14
7	Display And User Interface	16
	7.1 User Interface	16
	7.2 Magnet Key	16
	7.3 Using The Magnet Key	17
	7.4 System Initialization	17
	7.5 Reading Display	17
	7.6 Instrument Status Display	18
8	Navigating Settings	19
9	Programming Menus	23
	Zero/Fresh Calibration	23
	Meas. Unit*	23
	High Alarm	23
	Temp. Unit	23
	Span Calibration	23
	Meas. Range*	23
	Low Alarm	23
	Language	23

RAEGuard 2 PID User's Guide

	Set Span Value	23
	Meas. Gas*	23
	Ext. Alarm Delay*	23
	Pump Duty (%)*	23
	Calibration Gas*	23
	Pump Cycle(s)*	23
	Pump Status*	23
	Bus Baudrate	23
	Analogout 4mA	23
	Analogout 20mA.....	23
	Unit ID.....	23
	LCD Contrast.....	23
	LCD Backlight.....	23
	Change Password*.....	23
	9.1 Entering Programming Mode	24
	9.2 Calibration	25
	9.3 Measurement (Advanced Mode)	27
	9.4 Alarm Setting.....	31
	9.5 Monitor Setup.....	33
10	Calibration	39
	10.1 Zero Calibration.....	40
	10.2 Span Calibration	42
11	Alarm Signal Summary	44
12	Maintenance	45
13	Troubleshooting.....	45
14	Appendix A: Range, Sensor and Related Configuration.....	46
15	ModBus/RS-485 Information.....	46
16	Appendix B: Controlled Section	48
	16.1 Scope	48
	16.2 Contents.....	48
	16.3 Scope	50
	16.4 Responsibility	50
	16.5 Contents.....	50

RAEGuard 2 PID User's Guide

Section 2: DigiPID User's Guide

Safety Instructions	57
17 Read Before Operating	58
17.1 DigiPID Marking	59
17.2 Operation Area and Conditions	60
17.2.1 Hazardous Areas classified by Zones	60
Hazardous Areas classified by Divisions	60
17.3 Instruction For Safe Use	60
17.4 Use In Hazardous Areas	61
17.5 Year of manufacture	61
17.6 Specifications	62
18 General Information	63
19 Grounding (Earth Connection)	64
20 Physical Description	65
21 Sensor Parts And Dimensions	66
22 Operating the Sensor Module	67
22.1 Preparing The Sensor For Use	67
23 Using The Sensor Module	68
23.1 Gas Flow Routing Connection	68
23.2 Sensor Module Calibration	69
23.3 Maintenance And Calibration	70
23.4 Replacing the Lamp And Filter	70
24 Replacing The Sensor's Teflon UV Shield	72
25 Sensor & Lamp Cleaning/Replacement	75
25.1 Cleaning The PID Sensor	75
25.2 Cleaning The Lamp Housing Or Changing The Lamp	76
25.3 Cleaning The Instrument	77
25.4 Ordering Replacement Parts	77
25.5 Special Servicing Note	77
26 Electronic Waste Disposal	78
27 Technical Support	79
28 RAE Systems Contacts	79

RAEGuard 2 PID User's Guide

RAEGuard 2 PID User's Guide

Section 1: RAEGuard 2 PID User's Guide



RAEGuard 2 PID User's Guide

1 General Information

The RAEGuard 2 PID is a fixed photoionization detector (PID) that measures a broad range of volatile organic compounds (VOCs). It operates on 10 to 28 VDC and provides an analog (4-20mA) three-wire signal output, and RS-485 Modbus digital signal output.

RAEGuard 2 PID uses an intelligent processing platform and digital sensor technology, supports multiple ranges and resolutions, and can perform off-line calibration and environmental self-adaptation.

RAEGuard 2 PID has a graphic display and local sound alarm and light status indicator. A magnetic key interface enables the detector to be calibrated and operational parameters adjusted with the explosion-proof enclosure in place. In addition, the PID module can be easily removed in hazardous locations for calibration or maintenance.

Key features:

- Digital Smart Sensor Technology
- Three wires, supports 4-20mA analog output
- Can operate with diffusion and flow-through modes and can be used in most environments
- RS-485 digital communication in ModBus protocol
- Explosion-proof stainless-steel enclosure for hazardous environment applications
- Magnetic-key interface eliminates the need to open the explosion-proof housing when adjusting parameters.
- Matrix LCD of 128x64 supports graphic display
- Three-level switch signal outputs, normally closed/normally open optional (30V load voltage, 2A)
- LED alarms when High or Low alarm point is reached
- Operation at 10 to 28 VDC
- Three dry contacts (<30V, 2A) normally open (or normally closed), one for High and Low alarm, another for Fault alarm

RAEGuard 2 PID User's Guide

Applications:

- Refineries, petrochemical and natural gas plants
- Metallurgical
- Chemical, medication
- Environmental protection
- Electricity, communications
- Fire protection
- Utilities
- Pulp and paper, printing
- Storage
- Sewage disposal
- Food, brewing
- Scientific research, education, homeland security

Hazardous Location Classification:

ATEX	II 2G Ex d ia II CT4 Gb
UL/CSA	Class I, Div. 1, Groups A B C D T4
IECEX	Ex d ia IIC T4 Gb

RAEGuard 2 PID User's Guide

2 General Specifications

2.1 RAEGuard 2 PID Specifications

Basic Parameters	
Principle	PID (photoionization detector)
Sensor	Digital Smart Sensor
Sampling	Internal diaphragm pump
Working Current	DC 10 to 28V, 210mA at 24V
Power	<5W
Output	<ul style="list-style-type: none">• 4-20mA• Three-level programmable alarm relays (30 VDC, 2A)• RS-485 (Supports Modbus)
IP Rating	IP-65
Mechanical Interface	3/4" NPT Male
Installation	2" pipe-holding or wall mounting
User Interface	Three-key magnetic bar adjustment
Calibration	Two points
Environmental Parameters	
Temperature	-20° C to +55° C (-4° F to 131° F)
Humidity	0 to 95% relative humidity, non-condensing
Pressure	90 to 110kPa
Display	
Display	128x64 matrix backlit LCD, supports graphic display

RAEGuard 2 PID User's Guide

RAEGuard 2 PID Specifications (continued)

Physical Parameters	
Dimensions, L x W x H	257 x 201 x 107 mm (10.1" x 7.9" x 4.2")
Material	Stainless steel
Weight	3.5 kg (7.7 lbs)
Certification	
ATEX	II 2G Ex d ia II CT4 Gb
UL/CSA	Class I, Div. 1, Groups A B C D T4
IECEX	Ex d ia IIC T4 Gb
Ex Entity Parameters	Um: 28VDC (input supply)

2.2 Proper Product Disposal At End Of Life



This symbol (crossed-out wheeled bin) indicates separate collection of waste electrical and electronic equipment in the EU countries. This product may contain one or more Nickel-metal hydride (NiMH), Lithium-ion, or Alkaline batteries. Specific battery information is given in this user guide.

RAEGuard 2 PID User's Guide

3 Operation

The calibration of all newly purchased RAE Systems instruments should be tested by exposing the sensor to a known concentration calibration gas before the instrument is used or put into service. Prior to factory shipment, the RAEGuard 2 PID is calibrated and tested. However, the user should calibrate the instrument before the first use.

Kit Accessories include: RAEGuard 2 Magnet Key, and User's Guide.

RAEGuard 2 PID User's Guide

4 Physical Description

The RAEGuard 2 PID can be easily installed and integrated with various control systems. It is designed with flexible pipe-holding/wall-mounting options and standard connection terminals.

5 Physical Dimensions

The physical dimensions are as shown:

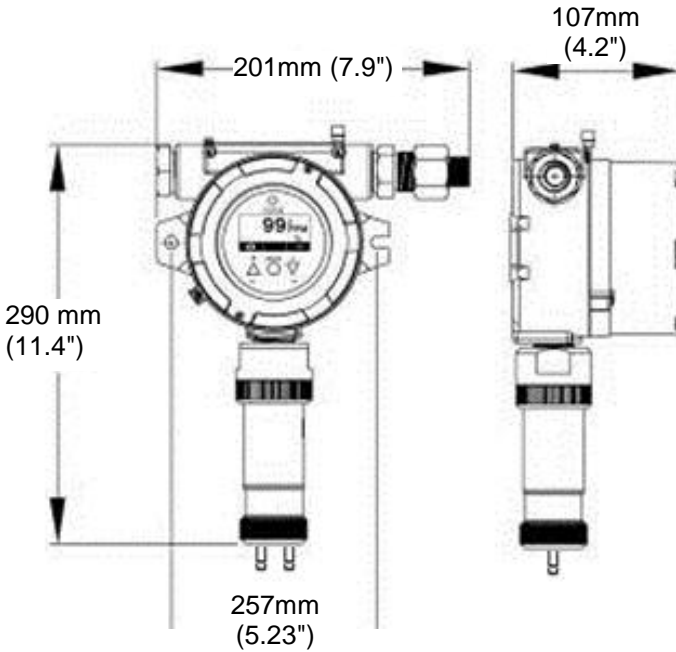

6 Installation And Access Instructions

WARNING

1. To prevent ignition of hazardous atmospheres, area must be free of flammable vapors and supply circuit must be disconnected before removing cover.
2. For European application, the installation must comply with the requirements of EN 60079-14.

6.1 Mounting

First, decide where the transmitter will be mounted. (Refer to installation drawing, below.) Drill two holes in mounting surface, with the center of the holes 5.25" (133mm) apart.

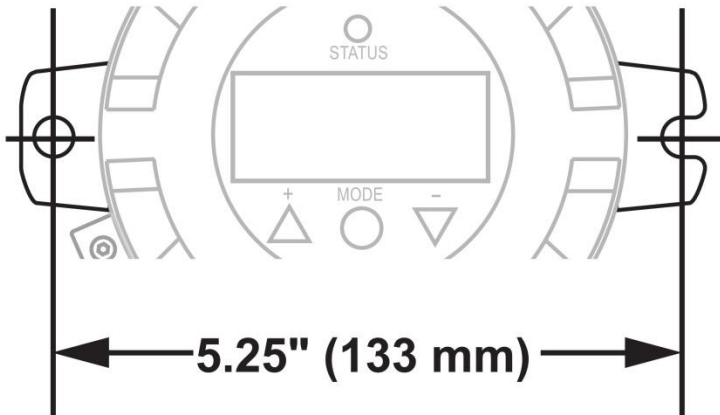

Besides directly mounting the RAEGuard 2 PID to a wall, it can be mounted on a pipe.

RAEGuard 2 PID User's Guide

Note: When installing the RAEGuard 2 PID, make sure the sensor is vertically oriented (pointing straight down). Also, make sure the water-trap filter is connected to the gas inlet labeled “IN” (the longer of the two inlets).

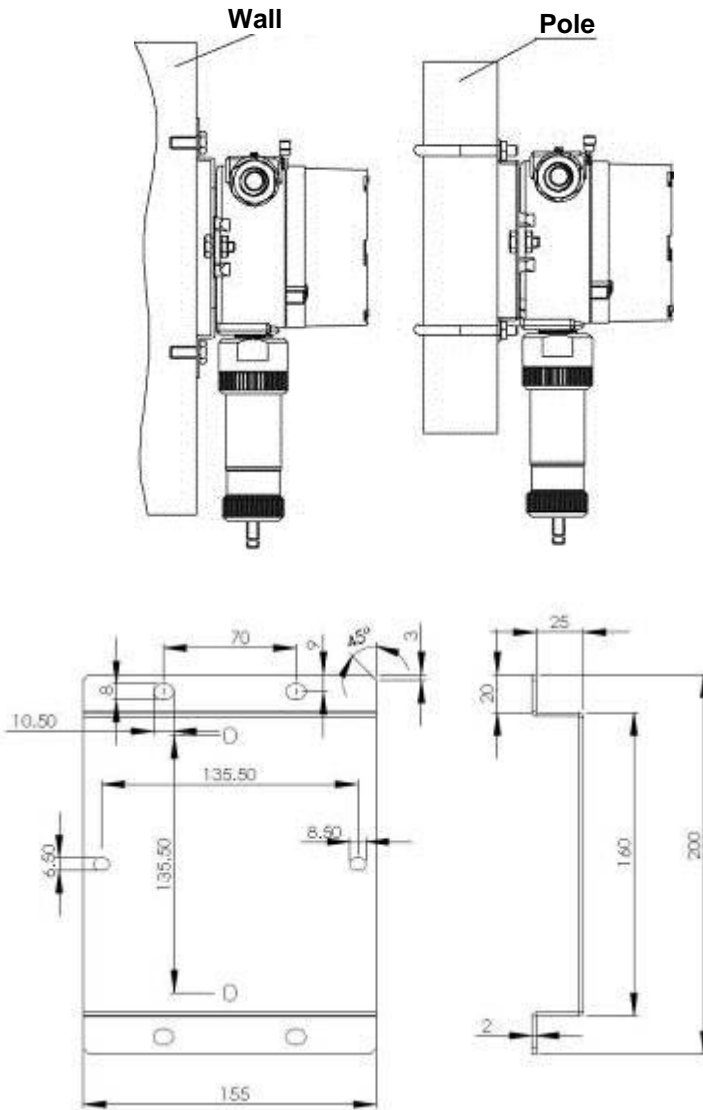

RAEGuard 2 PID User's Guide

6.2 Instrument Disassembly



Prior to service: Make sure power is OFF. Observe all Hazardous Location Safety procedures.



1. Loosen the fastening bolt before unscrewing the housing lid. Unscrew the housing lid from the housing body by rotating it counterclockwise. (As shipped, one of the conduit holes is covered by the provided hex-head plug. The other conduit is for wire connections.)



2. Pull off the retaining clip to release the instrument assembly.



3. Tilt the instrument assembly 90°.
4. Unlock the 24-pin connector on the ribbon cable.
5. Lift the entire instrument assembly out of the housing.
6. Unscrew the sensor by turning it counterclockwise.



Disassembled instrument.

RAEGuard 2 PID User's Guide

To reassemble the instrument:

- 1 Reconnect the 24-pin connector of the ribbon cable and lock it in place.
- 2 Fasten the cable to the board.
- 3 Mate the board with the clip on the left side and tilt it over.
- 4 Click the board into place.
- 5 Screw on the sensor, making sure not to block the gas inlet hole and connectors.
- 6 Screw on the housing top.
- 7 Screw down the fastening bolt.

6.3 Electrical Wiring

The detector connects to peripheral equipment via three terminal blocks. These blocks accept 12AWG to 24AWG wire (0.2 to 4.0 mm²).

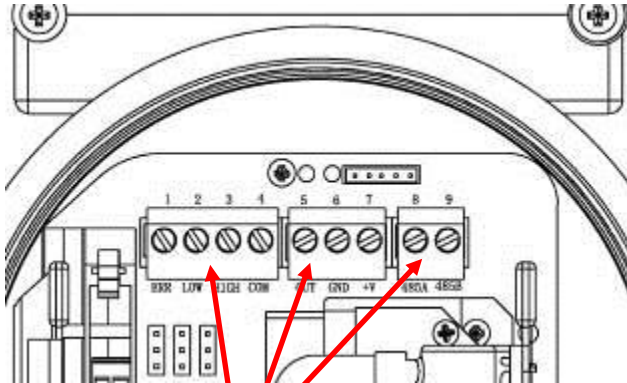

Terminal blocks

RAEGuard 2 PID User's Guide

6.4 Wiring Procedure

1. Inside the housing bottom, unplug the two green terminal block plugs from the terminal block on the PC boards.

Note: The terminal block plugs accept 12 AWG to 24 AWG wire.

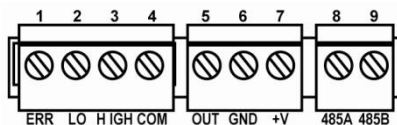

2. Lace the wires through the RAEGuard 2 PID's wire hole(s) and connect wires to the corresponding pin numbers of the terminal blocks:

Terminal	Terminal Definition	Terminal description	No.
Block 1	Failure Alarm Contact	ERR	1
	Low Level Alarm Contact	LOW	2
	High Level Alarm Contact	HIGH	3
	Switch signal Common Contact	COM	4
Block 2	4-20 mA Output	OUT	5
	Power Supply Negative	GND	6
	Power Supply Positive	+V	7
Block 3	RS485A terminal	485A	8
	RS485B terminal	485B	9

RAEGuard 2 PID User's Guide

6.5 Earth Grounding Instructions

6.5.1 External Earth Grounding

Fasten the crimped ground wire with hardware as illustrated below. The wire should have a minimum cross-section area of 4mm^2 for its conductor.

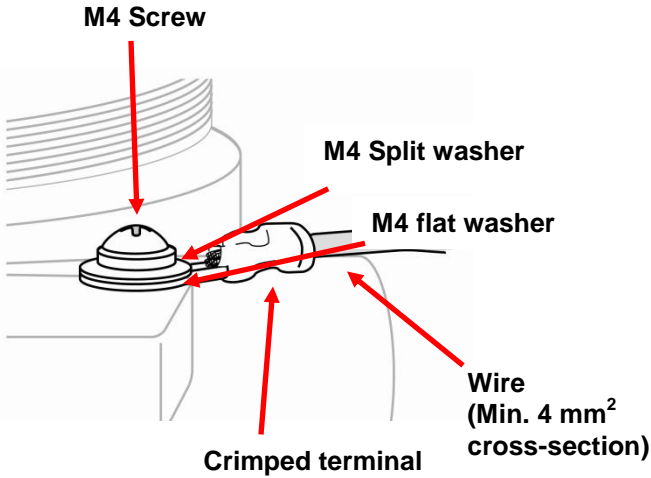

6.5.2 Internal Earth Grounding

Use the same hardware as shown in the illustration of external earth grounding. The wire should be no less than the size of the power lines. Signal grounding can connect to a cable's shielding layer if shielded cable is used. If a separate wire is used for grounding, its cross section should be greater than that of the power line.

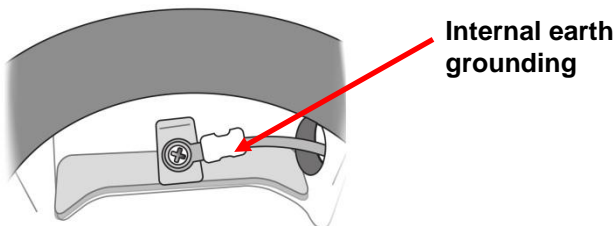

RAEGuard 2 PID User's Guide

6.5.3 Finished Grounding Wires

Internal and external grounding are shown here, as well as an alternate external grounding point. Always follow local electrical guidelines.

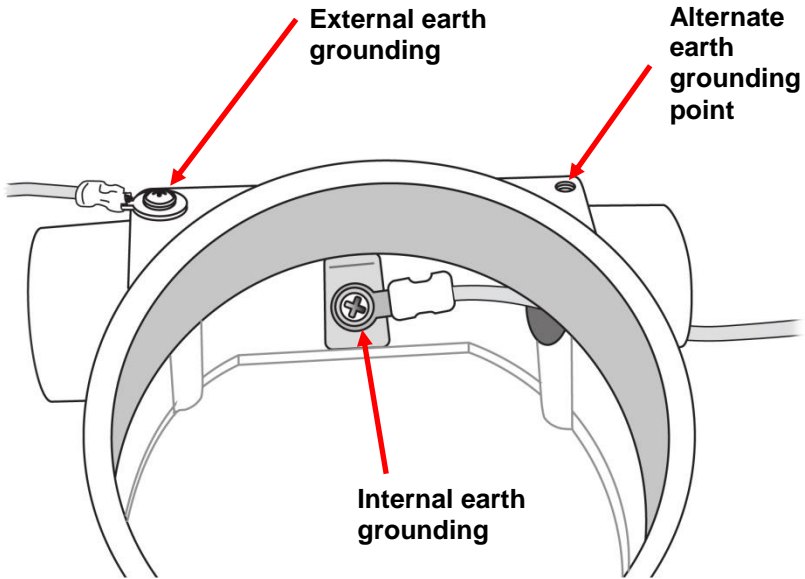

6.6 Alarm Contact Setup

The alarm contacts can drive external alarms such as a light or buzzer. By default, the three relays are set for normally open (NO) operation, meaning that contact is closed when in alarm.

You can separately change each relay from normally open to normally closed (NC) operation by changing the position of the jumpers on the internal printed circuit board.

RAEGuard 2 PID User's Guide

Three jumper blocks are located below the three green terminal blocks. They are labeled (from left to right): J4, J3, and J1. Here are their functions:

Jumper	Function
J1	High
J3	Low
J4	Error

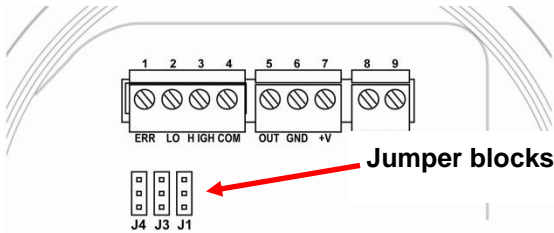

Lift off the jumper for each one that you want to change and slide it back on, either connecting the middle and top points or middle and bottom points.

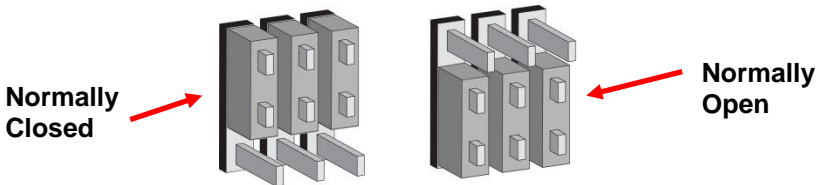

Important!

Once the system is operational, test the functionality of all three relays.

RAEGuard 2 PID User's Guide

7 Display And User Interface

7.1 User Interface

The RAEGuard 2 PID's user interface consists of a status LED, an LCD display, and three keys, [+], [MODE], and [-]. The three keys are operated by using the Magnet Key.

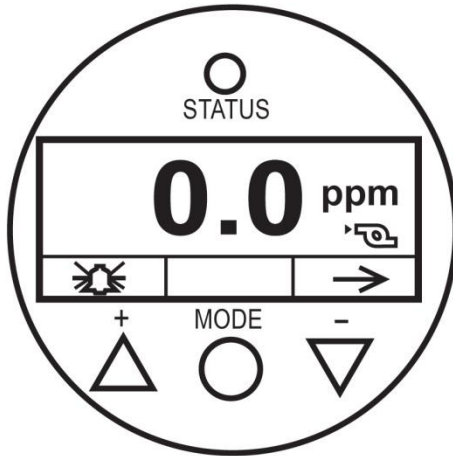

RAEGuard 2 PID user interface.

7.2 Magnet Key

The RAEGuard 2 PID has no external switches, but instead uses the magnetic end of the RAEGuard Magnet Key (p/n 033-3032-000) to activate switches built into the unit.

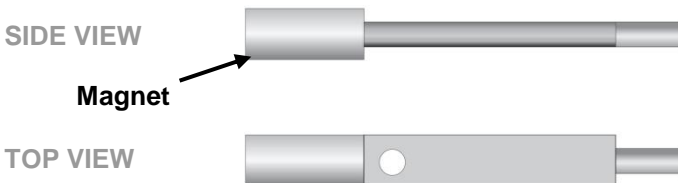

RAEGuard 2 PID User's Guide

7.3 Using The Magnet Key

Using the magnet end of the Magnet Key, briefly touch the glass above the MODE circle or the triangles labeled [+] and [-]. Then remove the key straight out and away from the RAEGuard 2 PID.

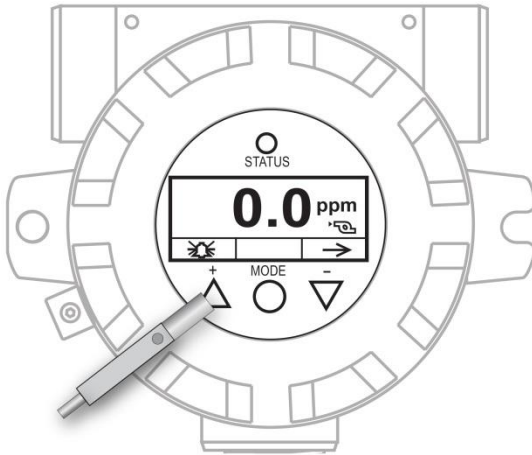

RAEGuard Magnet Key touching glass above the [+] triangle.

Important! Never drag the key sideways, or two functions may be activated.

7.4 System Initialization

When the RAEGuard 2 PID's system power is turned on, it initializes and a RAE Systems logo appears on the display. As the transmitter is warming up, each component is checked. The countdown timer appears on the screen for the warm-up.

7.5 Reading Display

As the transmitter enters the Reading Display, it automatically starts testing for errors and goes through a cycle of checking each alarm

RAEGuard 2 PID User's Guide





condition. If there are no errors or alarm conditions, the green “OK” LED is lit and the gas concentration is displayed.

If there is an error, the “Fault” LED blinks and an error message blinks. Each alarm condition has a corresponding LED that blinks an amber color when the readings are outside a specified range or limit.

7.6 Instrument Status Display

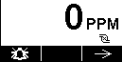
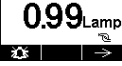
After warm-up, the detector enters the Status Display. It automatically starts testing for errors and goes through a cycle of checking each alarm condition. If there is no error message or alarm condition, gas concentration is displayed and LED flashes green.

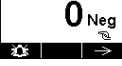
If there is an error or alarm, a corresponding message shows on the screen, and the LED indicates different statuses:

Status	External Alarm	LED	LCD	Output Current
Normal	-	Green	Reading	Reading
Low alarm	LOW	Red flashing, 2 Hz	Reading	Reading
High alarm	HIGH	Red flashing, 3 Hz	Reading	Reading
Over Range	HIGH	Red flashing, 3 Hz		22mA
Pump Error	ERR	Yellow flashing, 1 Hz		2mA
Lamp Error	ERR	Yellow flashing, 1 Hz		2mA
Max Alarm	--	Red flashing, 3 Hz		--
Sensor Drift	--	Yellow flashing, 1 Hz		--
Calibration Fault	ERR	Yellow flashing, 1 Hz		2mA
Humidity Sensor Fault	ERR	Green, 1 Hz		Reading

RAEGuard 2 PID User's Guide

8 Navigating Settings

You can view the basic settings, clear the Peak and Minimum readings, and perform a test of the Analog system without entering Programming Mode.

At the main reading screen, hold the magnetic key over [-] for two seconds. The RAEGuard 2 screen changes to show the current peak value in memory:

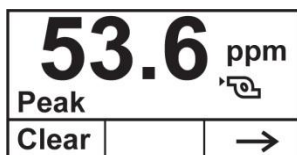

- If you do not want to clear the peak value, press [-].
- To clear the peak value (reset it), press [+].

This screen appears:

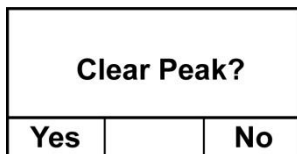

- If you do not want to clear the peak value, press [-]. The screen advances to Min. Clear.
- To confirm that you want to clear the peak value (reset it), press [+]. The value is cleared, and this screen is shown:

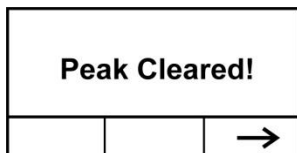

Advance to the next screen, Min value, by pressing [-].

RAEGuard 2 PID User's Guide

0.0 ppm		
Min		
Clear		→

- If you do not want to clear the minimum value, press [-].
- To clear the minimum value (reset it), press [+].

Clear Min?		
Yes		No

- If you do not want to clear the minimum value, press [-]. The screen advances to Min. Clear.
- To confirm that you want to clear the minimum value (reset it), press [+]. The value is cleared, and this screen is shown:

Min Cleared!		
		→

Press [-] to advance to the screen showing the measurement gas, calibration gas, correction factor (CF), and molecular weight (MW) of the gas:

M.Gas: Isobutylene		
C.Gas: Isobutylene		
CF=1.0 MW=56.1		
		→

RAEGuard 2 PID User's Guide

Press [-] to advance to the screen showing the measurement range (M.Range) and high alarm (H.Alarm) and low alarm (L.Alarm) values:

M.Range: 1000ppm		
H.Alarm: 100.0ppm		
L.Alarm: 50.0ppm		
		→

Press [-] to advance to the screen showing the firmware version and build time and date, and the serial number of the instrument:

Firmware: V1.02		
Built: 15:49:45		
Feb 2 2012		
SN: 0123456789		
		→

Press [-] to advance to the Analog Output Test screen.

The analog output test is primarily used when commissioning a system. It ensures that the mA output at the sensor location is the same as the input received on the system controller. Run the analog test to make sure that the readings on the detector match the readings on the controller.

The analog test uses a timed step function to output specific mA values in sequence. The test starts at 4 mA, which typically corresponds to 0 ppm output. The analog test then progresses in increments of 2 mA (4, 6, 8, etc., all the way up to 20mA). The corresponding sensor reading in ppm is shown on the unit's LCD display.

RAEGuard 2 PID User's Guide

For example, if you have a sensor range of 0 to 1000 ppm, the detector LCD displays in sequence 0, 125, 250, 375...all the way up to 1000 ppm. These are the ppm equivalent values of 4,6, 8, 10, etc., all the way up to 20mA.

Analog Output Test?		
Start		→

Note: You can stop the test and exit at any time by pressing [-].

0.0 ppm		
Analog Output		
		→



500.0 ppm		
Analog Output		
		→

RAEGuard 2 PID User's Guide

9 Programming Menus

Programming allows anyone with the password to change the instrument's settings, calibrate the instrument, etc. Depending on whether you use the Basic or Advanced Mode, both of which have different passwords, you can access different menus and submenus.

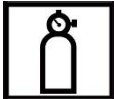
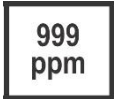
This table shows the menus (and their icons) and submenus. Items marked with an asterisk (*) are only available in Advanced Mode. They are not available in Basic Mode.

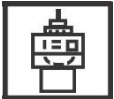
			
Calibration	Measurement*	Alarm Setting	Monitor Setup
Zero/Fresh Calibration	Meas. Unit*	High Alarm	Temp. Unit
Span Calibration	Meas. Range*	Low Alarm	Language
Set Span Value	Meas. Gas*	Ext. Alarm Delay*	Pump Duty (%)*
Calibration Gas*			Pump Cycle(s)*
			Pump Status*
			Bus Baudrate
			Analogout 4mA
			Analogout 20mA
			Unit ID
			LCD Contrast
			LCD Backlight
			Change Password*

RAEGuard 2 PID User's Guide

9.1 Entering Programming Mode

Enter Programming Mode by using the magnetic key to press these buttons in sequence:

1. Press [+].
2. Press [-].
3. Press [MODE].

The password screen appears, with the cursor on the first digit:

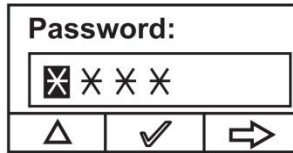

Input the 4-digit password:

- Increase the number from 0 through 9 by pressing [+].
- Step from digit to digit using [-].
- Press [MODE] when you are done.

If you make a mistake, you can cycle through the digits by pressing [-] and then using [+] to change the number in each position.

Note: The default password for Basic Mode is 1111.
The default password for Advanced Mode is 1250.

Once you enter Programming Mode, the LCD displays the first menu, Calibration. Each subsequent menu is accessed by pressing [-] repeatedly until the desired menu is displayed. To enter a submenu of a menu, press [+].

The Calibration label is shown and its icon is highlighted, but you can press [-] to step from one programming menu to the next, with the name of the menu shown at the top of the display and the corresponding icon highlighted.

RAEGuard 2 PID User's Guide

As you repeatedly press [-], the selection moves from left to right, and you see these screens in sequence:

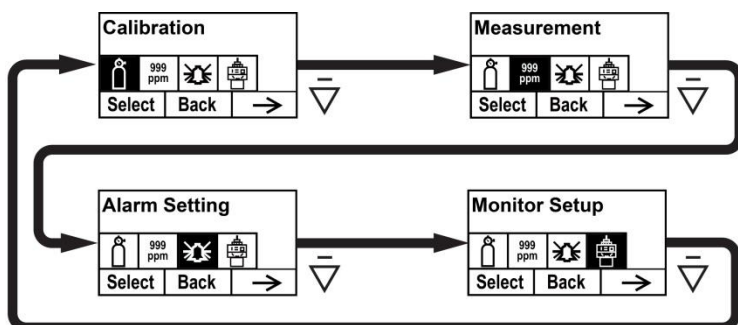

9.2 Calibration

Two types of calibration are available: Zero (fresh air) and Span.

Note: Complete calibration procedures are detailed on page 39.

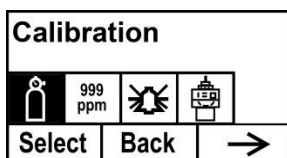

Press [+] to select Calibration. Otherwise, press [MODE] to go back, or press [-] to advance to the next menu.

The Calibration screen is shown:

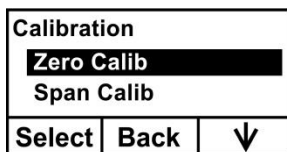

Select Zero or Span Calibration by pressing [-]. Once your choice is highlighted, press [+].

RAEGuard 2 PID User's Guide

Zero/Fresh Calibration

Your options are indicated along the bottom of the screen:



- Press [+] to start.
- Press [MODE] to quit and return to the menu.

If you choose to start zero/fresh air calibration, you see this message:

Please apply zero gas...

Connect the zero gas, start its flow, and then press [+]. There is a countdown as calibration is performed.

Span Calibration

Your options are indicated along the bottom of the screen:



- Press [+] to start.
- Press [MODE] to quit and return to the menu.

If you choose to start span calibration, you see this message:

Please apply gas...

Connect the calibration gas, start its flow, and then press [+]. There is a countdown as calibration is performed.

Calibration Gas (Advanced Mode)

You can set the gas that you want as your calibration gas. Calibration gases are organized in two lists:

- **Last Ten** is a list of the last ten gases used by your instrument. The list is built automatically and is only updated if the gas selected from the Gas Library is not already in the Last Ten. This ensures that there is no repetition.

RAEGuard 2 PID User's Guide

- **Gas Library** is a library that consists of all the gases found in RAE Systems' Technical Note TN-106 (available online at www.raesystems.com).
 - Press [-] to step between the two options.
 - Press [MODE] to go back to the menu level above it.
 - Press [+] to select your choice and advance to its submenu.

Then follow the steps for the type of selection group you have chosen:

Last Ten

1. Step through the list's gases by pressing [-].
2. Register your selection by pressing [+].
3. Save your choice by pressing [MODE].

Gas Library

1. Step through the list's gases by pressing [-].
2. Register your selection by pressing [+].
3. Save your choice by pressing [MODE].

Note: Whenever you change the calibration gas type, you must set the span value.

9.3 Measurement (Advanced Mode)

Measurement settings allow you to set measurement units, range, gas, and other parameters.

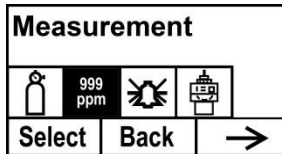

Meas. Unit (Advanced Mode)

Standard available measurement units include:

Abbreviation	Unit
ppm	parts per million
mg/m3	milligrams per cubic meter

RAEGuard 2 PID User's Guide

1. Press [-] to move the cursor from “ppm” to “mg/m3” or cycle through them.
2. Press [+] to register your choice.
3. Press [MODE] to save the selection.
4. Press [+] to save the Measurement Unit, [MODE] to return to editing it, and [-] to cancel the change.

The new Measurement Unit is saved, and the RAEGuard 2 PID exits back to the “Monitor Setup” menu.

Meas. Range (Advanced Mode)

Each sensor head has a maximum range for its sensor (for instance, 100 ppm). However, if you want to increase sensitivity in a lower range, it is possible to change the measurement range (from the preset 100 ppm to 60 ppm, for example).

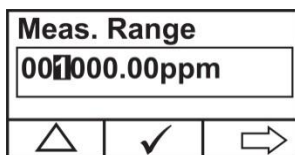

1. Press [+] to increase the number from 0 to 9 (it wraps around to 0 again after 9).
2. Press [-] to step through digits.
3. Press [MODE] to save the new value.

If you have set a value that is within range, then you see this screen:



- Press [+] to save the new value.
- Press [MODE] to go back and edit it again.
- Press [-] to exit without making a change.

If the value is within the sensor's range when you press [+], the value is saved and “Saved!” is displayed.

RAEGuard 2 PID User's Guide

If you have set a value that is outside the sensor's range, you see this, along with a message that says, "Invalid Input!":



You have two options:

- Press [-] to exit without making a change.
- Press [+] to go back to change the value.

Meas. Gas (Advanced Mode)

PIDs can be calibrated to a reference gas, yet display the concentration readings in equivalent units of the target gas. Isobutylene is typically used as the calibration gas because it is inexpensive, readily available, has immediate sensitivity, and has very low toxicity. The RAEGuard PID can display concentrations of over 200 gases using the built-in library of correction factors. Refer to RAE Systems Technical Note TN-106, available online at www.raesystems.com, for further details.

Measurement gases are organized in two lists:

- **Last Ten** is a list of the last ten gases used by your instrument. The list is built automatically and is only updated if the gas selected from the Gas Library is not already in the Last Ten. This ensures that there is no repetition.
 - **Gas Library** is a library that consists of all the gases found in RAE Systems' Technical Note TN-106 (available online at www.raesystems.com).
- Press [-] to step between the two options.
 - Press [MODE] to go back to the menu level above it.
 - Press [+] to select your choice and advance to its submenu.

RAEGuard 2 PID User's Guide

Then follow the steps for the type of selection group you have chosen:

Last Ten

1. Step through the list's gases by pressing [-].
2. Register your selection by pressing [+].
3. Save your choice by pressing [MODE].

Gas Library

1. Step through the list's gases by pressing [-].
2. Register your selection by pressing [+].
3. Save your choice by pressing [MODE].

RAEGuard 2 PID User's Guide

9.4 Alarm Setting

During each measurement period, the gas concentration is compared with the programmed high and low gas concentration alarm limits. If the concentration exceeds any of the preset limits, the alarms (and relays) are activated immediately to warn of the alarm condition.

An alarm signal summary is shown in the Instrument Status Display table on page 44.

In this menu, you can change the High and Low alarm limits. Press [Y/+] to enter the Alarm Setting menu.

Note: All settings are shown in ppm (parts per million).

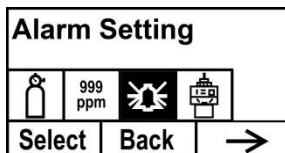

1. Select High or Low Alarm by pressing [-].
2. Press [+] to select edit that alarm's setting. The display shows a flashing cursor on the left-most digit of the previously stored alarm setting.
3. Press [+] to increase each digit's value.
4. Press [-] to advance to the next digit.
5. Again, use [+] to increase the number.

Repeat this process until all numbers are entered.

Press [MODE] when you are done.

Note: If you set an invalid input value, then it says "Invalid input!" and this set of buttons is shown along the bottom of the display:



- Press [MODE] to go back and input a valid value.
- Press [-] to exit back to the main menu without making a change.

RAEGuard 2 PID User's Guide

Ext. Alarm Delay (Advanced Mode)

In order to prevent false alarms, you can set a delay time between when an alarm event occurs and when the RAEGuard 2 sends out the alarm signal, up to 60 seconds. If the alarm duration is less than the alarm delay setting, then no relays will be triggered.

1. Press [+] repeatedly to select a desired number. Numbers increase from 0 to 9. Once 9 is reached, pressing [+] again “wraps” around back to 0.
2. Press [-] to advance to the next digit.

Repeat this process until all digits of the new value are entered.

3. Press [MODE] to register the Ext Alarm Delay value.
4. Press [+] to save the value, [MODE] to go back and edit the value, or [-] to cancel and return to the menu.

Note: If you set an invalid input value, then it says “Invalid input!” and this set of buttons is shown along the bottom of the display:



- Press [MODE] to go back and input a valid value.
- Press [-] to exit back to the main menu without making a change.

RAEGuard 2 PID User's Guide

9.5 Monitor Setup

This menu has sub-menus for setting the date, time, and other parameters.

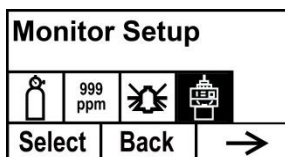

Temp. unit

Set the temperature units to either Fahrenheit or Celsius.

1. Press [-] to place the cursor on the temperature unit you want.
2. Press [+] to make the selection.
3. Press [+] to save your selection, exit the Temp. unit submenu and return to the Monitor Setup menu.

Note: If you do not want to save the change and want to make further changes, press [MODE]. Press [-] to exit without saving the changes.

Language

Choose from English or Chinese.

1. Press [-] to place the cursor on the language you want.
2. Press [+] to make the selection.
3. Press [MODE] to save your selection, exit the Language submenu and return to the Monitor Setup menu.

Pump Duty (%) (Advanced Mode)

The pump's duty cycle is the ratio of its on time to off time. The duty cycle ranges from 50% to 100% (always on), and the period is 10 seconds. Therefore, a duty cycle of 60% means that the pump is on for 6 seconds and off for four seconds. RAE Systems' patented duty cycling is employed by the instrument to clean the PID. A lower duty cycle has a greater effect on keeping the PID clean than a higher duty cycle.

Important! Pump duty cycling is interrupted when the instrument senses a gas. The pump's duty cycle is disabled when the

RAEGuard 2 PID User's Guide

measurement is greater than the 2ppm threshold and is re-enabled when the reading falls below 90% of the threshold (1.8 ppm).

1. Press [+] repeatedly to select a desired number. Numbers increase from 0 to 9. Once 9 is reached, pressing [+] again “wraps” around back to 0.
2. Press [-] to advance to the next digit.

Repeat this process until all digits of the new value are entered.

3. Press [MODE] to register the Pump Duty value.
4. Press [+] to save the value, [MODE] to go back and edit the value, or [-] to cancel and return to the menu.

Note: If you set an invalid input value, then it says “Invalid input!” and this set of buttons is shown along the bottom of the display:



- Press [MODE] to go back and input a valid value.
- Press [-] to exit back to the main menu without making a change.

RAEGuard 2 PID User's Guide

Pump Cycle(s) (Advanced Mode)

This sets the length of time for one cycle of the pump running.

1. Press [+] repeatedly to select a desired number. Numbers increase from 0 to 9. Once 9 is reached, pressing [+] again “wraps” around back to 0.
2. Press [-] to advance to the next digit.

Repeat this process until all digits of the new value are entered.

3. Press [MODE] to register the Pump Cycle(s) value.
4. Press [+] to save the value, [MODE] to go back and edit the value, or [-] to cancel and return to the menu.

Note: If you set an invalid input value, then it says “Invalid input!” and this set of buttons is shown along the bottom of the display:



- Press [MODE] to go back and input a valid value.
- Press [-] to exit back to the main menu without making a change.

Pump Status (Advanced Mode)

This tells you whether the pump should be on or off, and allows you to set whether the pump is on or off.

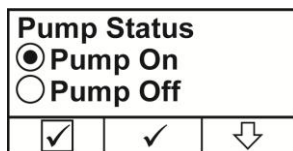

- Press [-] to select On or Off (the black dot in the circle indicates the selection).
- Press [+] to make the change to your selection.
- Press [MODE] if you want to exit without making a change.

RAEGuard 2 PID User's Guide

Bus Baudrate

Choose from three different baud rates for Modbus data transmission: 4800, 9600, or 19200.

1. Press [-] to place the cursor on the baud rate you want.
2. Press [+] to make the selection.
3. Press [MODE] to save your selection.
4. Press [+] to store the selection and exit the submenu and return to the Monitor Setup menu.

Note: If you do not want to save the change and want to make further changes, press [MODE]. Press [-] to exit without saving the changes.

Analogout 4mA

This feature sets the analog output to 4mA for system setup and troubleshooting.

1. Press [+] repeatedly to select a desired number. Numbers increase from 0 to 9. Once 9 is reached, pressing [+] again “wraps” around back to 0.
2. Press [-] to advance to the next digit.

Repeat this process until all three digits of the new value are entered.

3. Press [MODE] to save the 4mA analog output value.

Analogout 20mA

This feature sets the analog output to 20mA for system setup and troubleshooting.

1. Press [+] repeatedly to select a desired number. Numbers increase from 0 to 9. Once 9 is reached, pressing [+] again “wraps” around back to 0.
2. Press [-] to advance to the next digit.

Repeat this process until all four digits of the new value are entered.

3. Press [MODE] to save the 20mA analog output value.

RAEGuard 2 PID User's Guide

Unit ID

When using Modbus communication, you can give each RAEGuard 2 PID on a network a unique Unit ID that helps identify it.

1. Press [+] repeatedly to select a desired number. Numbers increase from 0 to 9. Once 9 is reached, pressing [+] again “wraps” around back to 0.
2. Press [-] to advance to the next digit.

Repeat this process until both digits of the new value are entered.

3. Press [MODE] to save the 20mA analog output value.

LCD Contrast

The display's contrast can be increased or decreased from its default setting. You may never need to change the default setting, but sometimes you can optimize the display to suit extreme temperature and ambient brightness/darkness conditions.

1. Press [+] to step through the contrast levels. The range is 1 to 99. Once 99 is reached, pressing [+] again "wraps" around back to 10.
2. When you have completed your selection, press [MODE].
3. Press [+] to save your selection, and exit LCD Contrast.

Note: If you want to make further changes, press [MODE] to return to the adjustment screen. Press [-] to exit without saving the changes.

LCD Backlight

The backlight glows whenever you press a button with the magnetic key. In addition, you can set the backlight to be either always on or only on when an event (alarm) occurs.

1. Press [-] to place the cursor on the setting you want.
2. Press [+] to make the selection.
3. Press [MODE] to save your selection, exit the LCD Backlight submenu and return to the Monitor Setup menu.

RAEGuard 2 PID User's Guide

Change Password (Advanced Mode)

You can change the four-digit password for accessing Basic Mode.

The default basic password is: 1111

The advanced password is: 1250

Note: You cannot change the password for accessing Advanced Mode.

1. Press [+] to step through all 10 numerals (0 to 9).
2. Press [-] to advance to the next digit. The next digit to the right flashes.

Repeat this process until all four digits of the new password are entered.

3. Press [MODE] to register the selection.
4. Press [+] to save the new password, [MODE] to return to editing the password, and [-] to cancel the change.

The new password is saved, and the RAEGuard 2 PID exits back to the "Monitor Setup" menu.

RAEGuard 2 PID User's Guide

10 Calibration

WARNING

The calibration of all newly purchased RAE Systems instruments should be tested by exposing the sensor(s) to a known concentration calibration gas before the instrument is used or put into service. For maximum safety, the accuracy of the RAEGuard 2 PID should be checked by exposing the sensor to a known concentration calibration gas.

The RAEGuard 2 PID is calibrated using a two-point calibration process. First, use a “zero gas.” Then use a “span gas” containing a known concentration of a standard reference gas, to set the second point of reference.

Note: Zero calibration must be performed before span calibration.

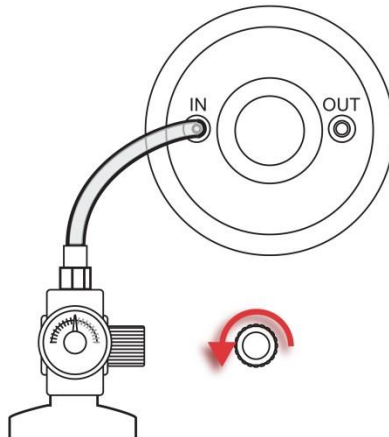

RAEGuard2 PID connected to gas bottle.

To perform a calibration, you need a cylinder of zero gas and a cylinder of span gas.

RAEGuard 2 PID User's Guide

10.1 Zero Calibration

1. Connect the zero gas cylinder to the gas inlet (“IN”) port on the RAEGuard2 PID.
2. In measurement mode, use the magnet key to press [+], [-], and then [MODE] in sequence.
3. Input your password, followed by [-].

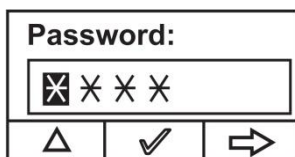

The instrument enters the calibration menu.

4. Press [+] to enter the Calibration menu.

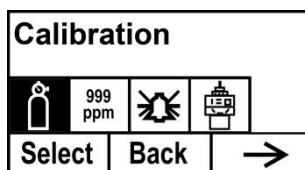

5. Press [-] until “Zero/Fresh calibration” is highlighted.

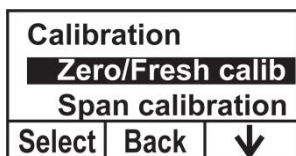

Press [+], and this screen appears:

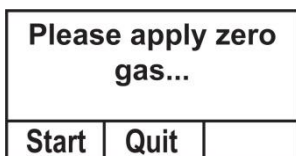

6. Start the gas flow.

RAEGuard 2 PID User's Guide

7. Press [+]. A countdown screen is shown as the calibration is performed:

Zeroing... 30		
		Abort

Note: You may abort the calibration during the countdown by pressing [-]. If you stop the calibration, the process stops and this screen is displayed before the menu screen is shown:

Zero aborted!		

8. Once the calibration is complete, this screen is shown:

Zero is done! Reading=0.0ppm		
		Abort

9. If the calibration is not successful, and you see the “Zero Calibration Failed” message, check that the inlet is not blocked and that there are no other problems before retrying.

RAEGuard 2 PID User's Guide

10.2 Span Calibration

1. Connect the calibration gas cylinder to the gas inlet (“IN”) port on the RAEGuard2 PID.

Note: Make sure the labeled concentration of calibration gas matches the value that is set in the RAEGuard 2 PID.

2. If the RAEGuard 2 PID is not already in Programming Mode, use the magnet key to press [+], [-], and then [MODE] in sequence.
3. Input your password, followed by [-].

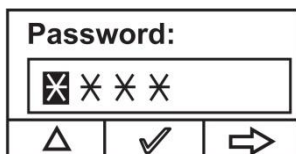

The instrument enters the calibration menu.

4. Press [+] to enter the Calibration menu.

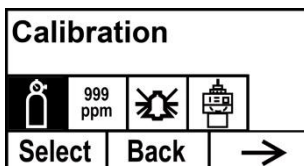

5. Press [-] until “Span calibration” is highlighted.

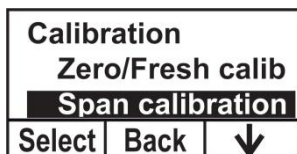

RAEGuard 2 PID User's Guide

6. Press [+], and this screen appears:

C.Gas=Isobutene		
Span=100.0ppm		
Please apply gas1		
Start	Quit	

7. Start the gas flow.
8. Press [+]. A countdown screen is shown as the calibration is performed:

C.Gas=...		
Span=100.0ppm		
Calibration... 30		
		Abort

Note: You may abort the calibration during the countdown by pressing [-]. If you stop the calibration, the process stops and this screen is displayed before the menu screen is shown:

Span Low aborted!		

9. Once the calibration is complete, this screen is shown:







Span Low is done!		
Reading=100.0ppm		
		Abort

10. If the calibration is not successful, and you see the “Span Low Failed!” message, check that the inlet is not blocked, the sensor or lamp are not fouled or damaged, and there are no other problems before retrying.

RAEGuard 2 PID User's Guide

11 Alarm Signal Summary

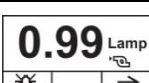
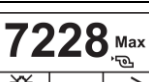
The following are reading-related alarms.

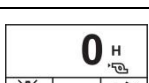
Status	LCD	LED Indication	Relay Status	Analog Output
Normal		Green	Failure: Disable Low alarm: Disable High alarm: Disable	According to Reading Value
Low Alarm		Red (2 flashes per second)	Failure: Disable Low alarm: Enable High alarm: Enable	According to Reading Value
High Alarm		Red (3 flashes per second)	Failure: Disable Low alarm: Disable High alarm: Enable	According to Reading Value
Over Range		Red (3 flashes per second)	Failure: Disable Low alarm: Disable High alarm: Enable	22mA
Pump Error		Yellow (1 flash per second)	Failure: Enable Low alarm: Disable High alarm: Disable	2mA
Lamp Error		Yellow (1 flash per second)	Failure: Enable Low alarm: Disable High alarm: Disable	2mA
Max Alarm		Red (3 flashes per second)	Failure: Disable Low alarm: Disable High alarm: Enable	2mA
Sensor Negative Drift		Yellow (1 flash per second)	Failure: Enable Low alarm: Disable High alarm: Disable	2mA
Calibration Failure Error		Yellow (1 flash per second)	Failure: Enable Low alarm: Disable High alarm: Disable	2mA
Humidity Sensor Error		Green	Failure: Disable Low alarm: Disable High alarm: Disable	According to Reading Value





RAEGuard 2 PID User's Guide

12 Maintenance

As a guide, it is recommended to regularly “bump test” a RAEGuard 2 PID unit with a known percentage gas. Also, periodically check the sensor inlet and outlet to make sure they are clean and unobstructed.

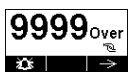
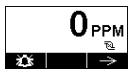
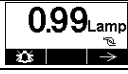
13 Troubleshooting

Note: Before attempting to diagnose measurement problems, perform zero and span calibrations.

Message	Reason and Solution
	Reason: Instrument over range. Solution: Confirm the level of gas concentration. Check sensor.
	Reason: Pump failure. Solution: Make sure that the air path is not blocked. Check pump.
	Reason: Lamp failure. Solution: Check Sensor.
	Reason: Sensor drift. Solution: Check sensor and/or perform zero and span calibration.
	Reason: Calibration fails. Solution: Check calibration operation. Change sensor or contact RAE Systems Customer Service.
	Reason: Humidity sensor failure. Solution: Check the humidity in the area. Make sure that the air path is not blocked. Contact RAE Systems Customer Service.

RAEGuard 2 PID User's Guide

14 Appendix A: Range, Sensor and Related Configuration

The following table shows the measurement range and related configurations for four different DigiPID sensor modules:

Sensor (ppm)	Resolution (ppm)	Span Gas Setup Default Value	Default Alarm Setup (ppm)	
			Low Alarm	High Alarm
0-100	0.01	10	10	20
0-1000	1	100	10	100

15 ModBus/RS-485 Information

The RAEGuard s communicates by means of MODBUS RTU. All monitors provide a 4-byte register value. **Note:** Gas concentration is the only value that can be retrieved.

For example, 34 hex = 52 decimal

Overview

This document describes the modbus protocol used in RAEGuard 2 PID products.

1. Communication Setting

Communication Mode: RTU

Controller: PC or Controller

Client: RAEGuard 2 PID

Baud Rate: 4800, 9600, 19200

Client ID: 1 to 99 (0x0001 to 0x0064)

RAEGuard 2 PID User's Guide

2. Data Structure/Communication Steps

RAEGuard 2 PID only supports Function Code 0x03 (read-only registers). The detector only supports value reading.

0x03: Read-Only Register

Requesting Message:

Device Address	Function Code	Register Address High Byte	Register Address Low Byte	Quantity of Registers High Byte	Quantity of Registers Low Byte	CRC Low Byte	CRC High Byte
Client ID	03	00	08	00	02	CRC	CRC

Answering Message:

Device Address	Function Code	Byte Count	Register Value				CRC Low Byte	CRC High Byte
Client ID	03	04	Reading Highest Byte	Reading Higher Byte	Reading High Byte	Reading Low Byte	CRC	CRC

Note: The length of data from the detector is 4 bytes.

Example:

Request: 01 03 00 08 00 02 45 C9
Answer: 01 03 04 00 00 00 D1 3A 6F

Note: The maximum communication distance should be less than 1 km when using a 1.5 mm² cable.

RAEGuard 2 PID User's Guide

16 Appendix B: Controlled Section

RAEGuard 2 And DigiPID

16.1 Scope

The scope of this document is to describe the system aspects for use of the RAEGuard 2 PID by connection of the RAEGuard2 and DigiPID according to EN60079-25; UL913 and CAN/CSA-C22.2 No. 157-92 in hazardous locations.

16.2 Contents

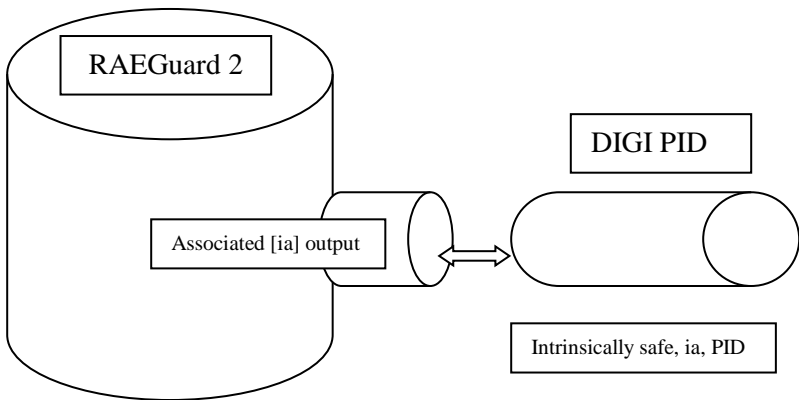

RAEGuard2 certification	DIGI PID certification	Comment to integration
ATEX/IECEX certification for zones		
ITS 11ATEX17231X	KEMA10ATEX0059	-
IECEX ITS 11.0005X	IECEX KEM 10.0005	-
Ex d [ia Ga]IIC T4 Gb	Ex ia IIC T4 Ga	-
Gb	Ga	Gb < Ga
UL/CSA certification for Divisions		

RAEGuard 2 PID User's Guide

CID1	CID1	same
	$-40^{\circ}\text{C} < T_{amb} < +55^{\circ}\text{C}$	-
Um: 28VDC	-	-
Uo: 5.91V	Ui: 6.13V	Uo < Ui; OK
Io: 0.8A	Ii: 1.5A	Io < Ii; OK
Po: 1.16W	Pi: 1.225W	Po < Pi; OK
Co: 30 μ F	Ci: 20.2 μ F	Ci < Co; OK
Lo: 55 μ H	Li: 1 μ H	Li < Lo; OK

As demonstrated in the table above, RAEGuard 2 and DigiPID have matching entity parameters, which allows the two devices to be connected to form a single piece of equipment: RAEGuard 2 PID, with the resulting Ex specification given below, suitable for installation in hazardous areas defined by zones as Ex d ia IIC T4 Gb.

Resulting RAEGuard2 PID Ex specification
Ex d ia IIC T4 Gb
$-20^{\circ}\text{C} < T_{amb} < +55^{\circ}\text{C}$

The marking is found on each of the two connected devices.

RAEGuard 2 PID User's Guide

RAEGuard 2

16.3 Scope

The scope of this document is to identify the section of the RAEGuard2 controlled part of manual.

16.4 Responsibility

The included sections cannot be changed without prior approval from the Notified Body.

16.5 Contents

Below are the sections controlled by the Notified Body, including all safety-related information in the manual.

Controlled sections are:

1. Warnings and directive information
2. Marking of RAEGuard2
3. Hazardous Location Classifications
4. Instructions for Safe Use
5. Connections and Ratings
6. Maintenance
7. Physical dimensions

RAEGuard 2 PID User's Guide

1. Warnings And Directive Information

- READ BEFORE OPERATING -

This manual must be carefully read by all individuals who have or will have the responsibility of using, maintaining, or servicing this product. The product will perform as designed only if it is used, maintained, and serviced in accordance with the manufacturer's instructions.

CAUTION!





To reduce the risk of electric shock, turn the power off before removing the instrument cover. Disconnect the power before removing the sensor module for service. Never operate the instrument when the cover is removed. Remove instrument cover and sensor module only in an area known to be non-hazardous.

RAEGuard 2 PID User's Guide

2. Marking Of RAEGuard 2

The RAEGuard 2 is certified according to ATEX and the IECEx schemes as protected by a flameproof enclosure provided one or two associated equipment output port protected as intrinsically safe [ia], one of which can include a set of flame arrestors for gas sampling. The product is marked with the following information:

RAE Systems Inc.
3775 N. 1st. St.
San Jose, CA95134 USA
Serial number: XXXXXXXXXXXX
RAEGuard 2, FGM-2XXX

IECE _x	ATEX
IECE _x ITS 11.0005X	ITS 11ATEX17231X
Ex d [ia Ga] IIC T4, Gb	 0575  II 2(1)G, Ex d [ia Ga] IIC T4 Gb

-20°C < Tamb < +55°C

Um: 28VDC; Uo: 5.91V; Co: 30µF; Lo: 55uH; Io: 0.8A; Po: 1.16W

Year of manufacture: XXXX

**WARNING: DO NOT OPEN WHEN AN EXPLOSIVE
ATMOSPHERE MAY BE PRESENT.
REFER TO USER MANUAL FOR ENTRY TYPE AND SIZE**

RATING: < 5W. 10 ~28VDC

4. Hazardous Location Classification

Hazardous Areas Classified By Zones

RAEGuard 2 are intended to be used in hazardous areas classified for zone 1 or zone 2, within the temperature range of -20°C to +55°C, Where gases of explosion groups IIA, IIB or IIC and T4 may be present.

RAEGuard 2 PID User's Guide

5. Instructions For Safe Use

It must be ensured that the supply voltage for RAEGuard 2 comply with the Um input entity parameter. The 8-pin output interface connector facilitates connection to intrinsically safe equipment, e.g. sensors or modems. The connected devices must be protected by intrinsically safety, ia, ib or ic for gases in group IIA, IIB or IIC.

The connected device must have entity parameters that comply with general fitting rules for entity parameters with the output entity parameters of the RAEGuard 2 interface. The DigiPID sensor can be mounted on the on the RAEGuard 2 interface inside hazardous area in powered condition. This constellation is called RAEGuard 2 PID.

6. Connections And Ratings

Outline drawing of the interface:

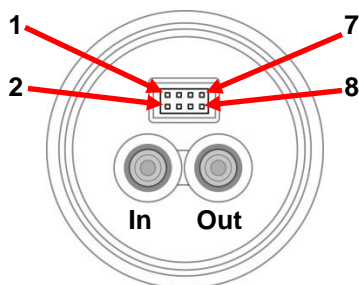

Figure1

Output interface port definition:

The pin definition of the 8-pin output connector is given in the table below:

Pin No.	1	2	3	4	5	6	7	8
Definition	Power Out	CS	Analog Single	RXD	Open Drain	GND	Cn	TXD

RAEGuard 2 PID User's Guide

Input/output entity parameters

The rated RAEGuard2 input/output parameters are as follows:

Input: U_m : 28VDC

Output: U_o : 5.91V

C_o : 30 μ F

L_o : 55uH

I_o : 0.8A

P_o : 1.16W

Cable Entry type and Size

RAEGuard2 is provided with three female 3/4" - 14 NPT cable entry holes tapped into its side walls. One or two of these three cable entries are mounted with safety adapter interface type ISA-100/ ISA-101.

7. Maintenance

Calibration

The monitor should be calibrated for no less than every 6 months depending on use and exposure to gas and contamination.

- **Calibration interval may vary due to national legislation**
- **RAE Systems recommend the use of RAE Systems calibration gas**

Installation and Access Instructions

- When used in North America, conduit runs must have a sealing fitting connected within 18" (457mm) of the enclosure. CSA requires seals in conduit exceeding 5' (1.524 m) in Group C atmospheres.
- The appropriate regulations for installation, service and repair must be properly observed during such activities. Installation in ATEX/IECEx area must be done as outlined in EN/IEC 60079-14.
- To prevent ignition of hazardous atmospheres, area must be free of flammable vapors and supply circuit must be disconnected before removing cover.

RAEGuard 2 PID User's Guide

8. EARTH GROUNDING INSTRUCTIONS

External Earth Grounding

Fasten the crimped ground wire with hardware as illustrated below. The wire should have a minimum cross-section area of 4mm^2 for its conductor.

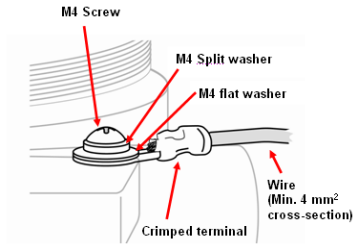

Internal Earth Grounding

Use the same hardware as shown in the illustration of external earth grounding. The wire should be no less than the size of the power lines.

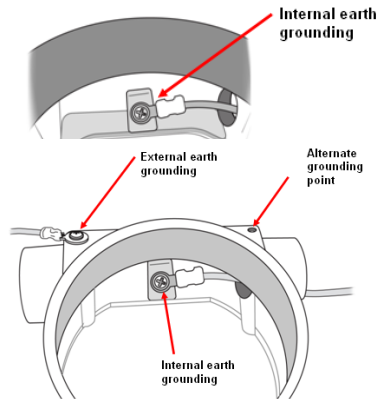

Finished Grounding Wires

Internal and external grounding are shown here, as well as an alternate external grounding point. Always follow local electrical guidelines.

 Sensors are not interchangeable; use only RAE Systems sensors, and use only the sensor type specified for your RAEGuard2 monitor. Use of non-RAE Systems components will void the warranty and can compromise the safe performance of this product.

RAEGuard 2 PID User's Guide

9. Physical Dimensions

RAEGuard 2 can be easily installed and integrated with various control systems with its flexible pipe-holding/wall-mounting options and standard connection terminals. The physical dimensions are as follows:

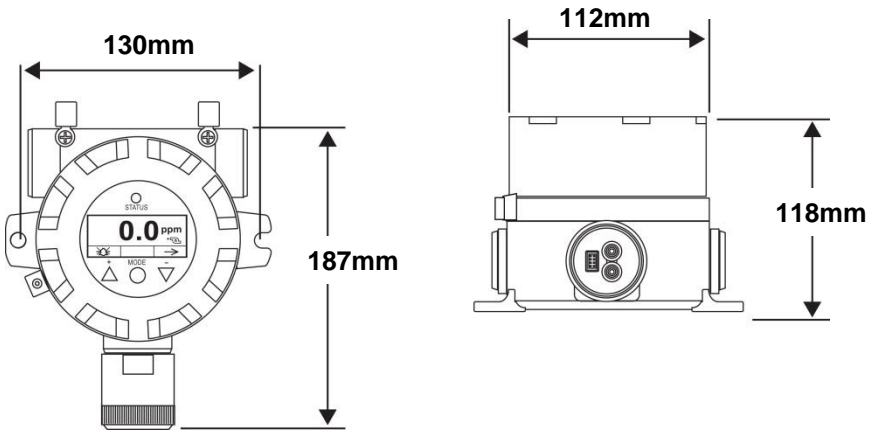

RAEGuard 2 PID User's Guide

SECTION 2: DigiPID User's Guide

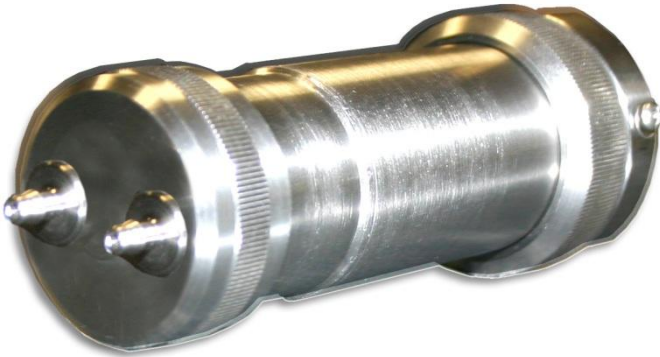

RAEGuard 2 PID User's Guide

SAFETY INSTRUCTIONS

17 Read Before Operating

This manual must be carefully read by all individuals who have or will have the responsibility of using, maintaining, or servicing this product. The product will perform as designed only if it is used, maintained, and serviced in accordance with the manufacturer's instructions. The user should understand how to set the correct parameters and interpret the obtained results.

CAUTION!

Sensor interface connector pins cannot be interchanged for multiple applications. Apply the sensor in accordance with connector definitions described in the datasheet and in accordance with the general fitting rules for the applied intrinsically safe entity parameters. Use only RAE Systems lamps and the sensor detector type specified for your module. Maintain by using only RAE Systems accessories, including a Teflon filter or UV shield. Use of non-RAE Systems components will void the warranty and can compromise the safe performance of this product.

RAEGuard 2 PID User's Guide

17.1 DigiPID Marking

The DigiPID is certified according to the IECEx scheme, ATEX and CSA for US and Canada as protected by intrinsic safety.

The product is marked with the following information:

RAE SYSTEMS



3775 N. 1st. St., San Jose

CA 95134, USA

DIGI PID

Type DS100/DS101/DS102

Serial No/barcode: XXX-XXXX-000

<p>IECEX KEM 10.0005 Ex ia IIC T4 Ga Ex ia I</p>	<p> 0575  IM1/II 1G Ex ia IIC T4 Ex ia I KEMA10ATEX0059</p>	<p> Class I, Gr. A,B,C,D T4 Only as to intrinsic safety for use in hazardous loc. Intrinsically safe/ Securite Intrinseque/Exia</p>
------------------------------------------------------------------	-----------------------------------------------------------------------------------------------------------------------------------------------------------------------------------------------------------------------------------------------	------------------------------------------------------------------------------------------------------------------------------------------------------------------------------------------------------------------------------------------

Pi: 1.225W; Vi: 6.13V; Ci: 20.2 μ F; Ii: 1.5A; Li: 1 μ H.

-40° C < Tamb < +55° C

Warning: Read User's Manual for Intrinsic Safety Precautions

RAEGuard 2 PID User's Guide

17.2 Operation Area and Conditions

17.2.1 Hazardous Areas classified by Zones

DIGI PID is intended to be used in hazardous areas or mines susceptible to fredamp classified zone 0, zone 1 or zone 2, within the temperature range of -40°C to $+55^{\circ}\text{C}$, where gases of explosion groups IIA, IIB or IIC and T4 may be present.

Hazardous Areas classified by Divisions

DIGI PID is intended to be used in hazardous areas classified for Class I Div. 1 or 2, within the temperature range of -40°C to $+55^{\circ}\text{C}$, where gases of explosion groups A, B, C or D and temperature class T4 may be present.

17.3 Instruction For Safe Use

Strictly follow the instructions for safe use. Application of the DigiPID requires full understanding and strict observation of the instructions.

The DigiPID can be connected to Ex-certified equipment for use in hazardous areas, when it is secured that the connection is complying with the intrinsically safe input entity parameters for the two units, and the intended function area corresponds to the certified area.

The DigiPID sensor can be connected and disconnected inside the hazardous area.

RAEGuard 2 PID User's Guide

17.4 Use In Hazardous Areas

Equipment which is intended for use in explosive atmospheres and which has been assessed and certified according to international regulations may be used only under specified conditions. The components may not be modified in any way.

The appropriate regulations for service and repair must be properly observed during such activities.

17.5 Year of manufacture

To identify the year of manufacture, refer to the serial number of the instrument.

The second to last digit in the serial number indicates the year of manufacture. For example, "H" indicates the manufacturing year is 2008.

First digit	Year
J	2008
K	2009
M	2010
N	2011
P	2012
Q	2013
R	2014
S	2015
T	2016
U	2017
V	2018
W	2019

RAEGuard 2 PID User's Guide

17.6 Specifications

Power Supply	5V \pm 0.25V DC
Current	110 mA max
Power Consumption	< 0.6W
Measuring Range	0 to 100 ppm, 1 to 1000 ppm
Resolution	10 ppb, 100 ppb, 1 ppm (depends on model)
Response Time	Diffusion (T_{90}): 30 s Pumped (T_{90}): 5 s
Calibration	Two-point off-line and field calibration
Accuracy	\pm 2% for calibration point
Zero Drift	\pm 10% FSS/Month
Span Drift	\pm 10% FSS/Month
Analog Output	0.5 - 2.5V ($r_o=1.0k$)
Digital Interface	Serial Interface (UART) Transmit (Tx): 3.3V TTL Receive (Rx): 3.3V TTL
Sensor Lifetime	2 years
Operating Temperature	-20° C to +55° C (-4° F to +131° F)
Humidity	0 to 95% RH non-condensing
EMI/RFI	Highly resistant to EMI/RFI Compliant with EMC Directive 2004/108/EC
Package	Rugged case for 1.2m drop test Spray watertight for IP65 rating Dust membrane for sensor front protection
Size (DxL)	49mm x 150.8mm (1.92" x 5.94")
Weight	< 550g (19.4 oz)
Ex entity parameters	Pi: 1.225W; Vi: 6.13V; Ci: 20.2 μ F; Ii: 1.5A; Li: 1 μ H

RAEGuard 2 PID User's Guide

18 General Information

The DigiPID Sensor is a self-contained intelligent sensor module with built-in photoionization detector (PID) sensor processor, lamp driver, and analog and digital interface circuits. It is designed to detect volatile organic compounds (VOC) and has a standard external interface. This sensor module can be easily integrated into a wired or wireless communication system for remote, wide-area, and pervasive monitoring applications. The sensor module can be powered by a 5V ± 0.25 V DC power supply. It is housed in a weatherproof enclosure with a standard 8-pin interface connector. The chart below details the functions of the eight pins:

Pin Number	1	2	3	4	5	6	7	8
Definition	Power In	CS	Analog Signal Out	RXD	Open Drain	GND	Control Signal (optional)	TXD

Notes:

Power in: Power supply input connector for the sensor module. The input voltage range is DC 5V ± 0.25 V at 200mA.

CS: Communication Select. Select (falling edge) to start communication, deselect (rising edge) to stop communication.

Analog Signal Out: Analog signal output with 1k Ω output resistance for the sensor module. The output signal range is between 0.5V and 2.5V.

RXD & TXD: Serial interface poles (receive and transmit) for UART mode with 3.3V TTL level.

Open drain: Switching signal output pole. It can deliver low or high level to external equipment according to customer requirements.

GND: Power and signal ground.

RAEGuard 2 PID User's Guide

Control signal: This optional pole only delivers a high (3.3V) or low (0V) signal level.

Caution: 6.2V is the maximum input voltage for all of the sensor module's input poles.

19 Grounding (Earth Connection)

DigiPID includes a grounding connection via pin 6 of the 8-pin connector. If the complete installation must be grounded, ensure that the thread on which DigiPID is mounted is correctly grounded. Check local ordinances regarding further requirements.

20 Physical Description

The DigiPID is a pumped sensor. The pump is in this version intended to pump the sample gas in through one of the DigiPID gas tubes and return it through the other.



RAEGuard 2 PID User's Guide

21 Sensor Parts And Dimensions

DigiPID sensor shown with optional mounting adaptor

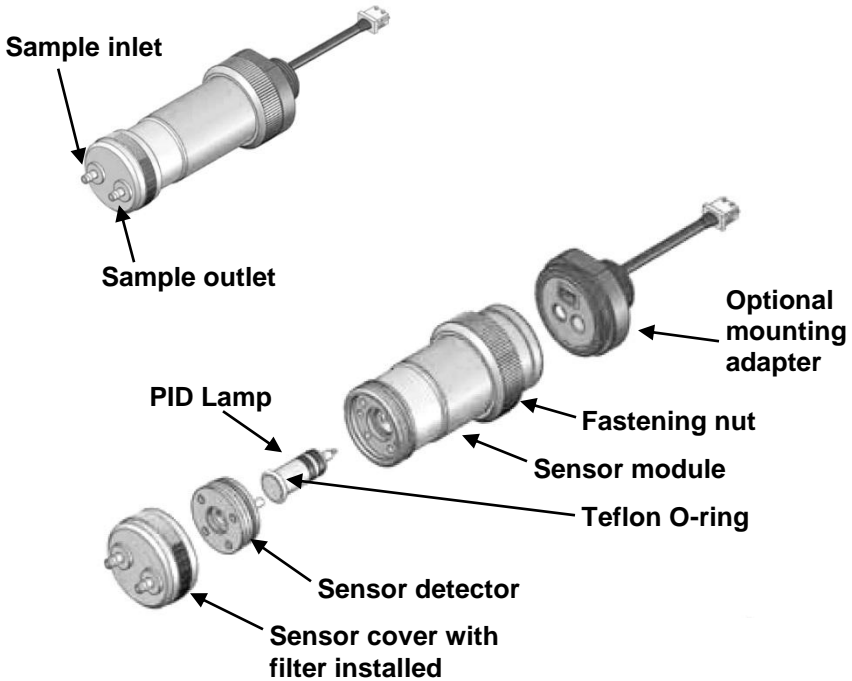
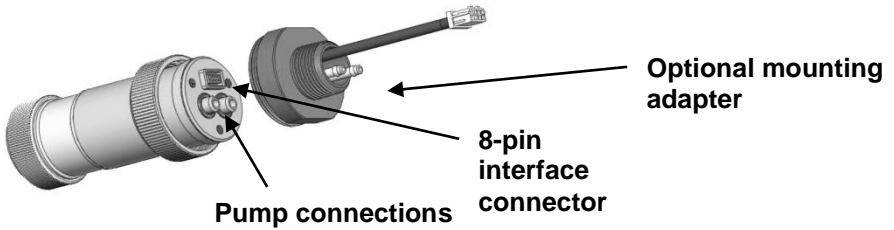
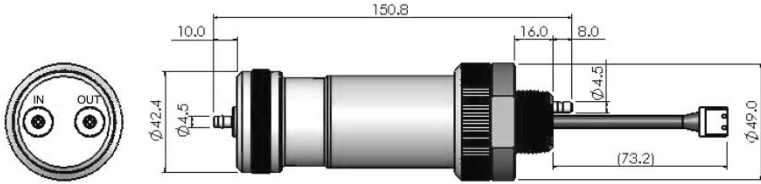

22 Operating the Sensor Module

22.1 Preparing The Sensor For Use

Make sure the 8-pole input of the external intrinsically safe equipment matches the interface connector pinout configuration of the DigiPID. Make sure the input power supply range is between 4.75V and 5.25V DC, and the input current is about 200mA when the sensor module is operated. The following mechanical drawing includes the sensor module interface connector's pinout. The Ex entity parameter of the equipment connected to the DigiPID must fit the entity parameters of DigiPID according to intrinsically safe fitting rules.

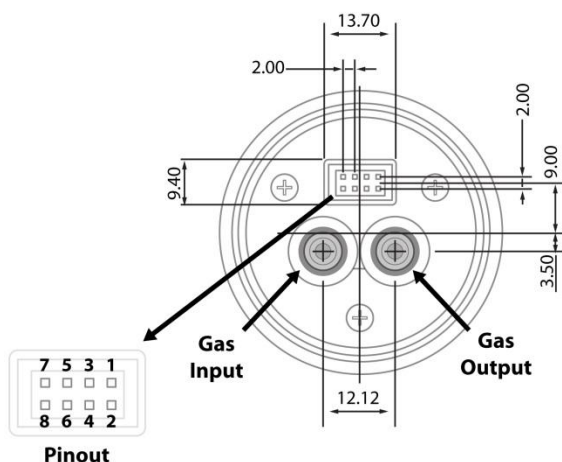

8-pin connector pinout configuration:

- 1: Power in
- 2: CS (Communication Select). Select (falling edge) to start communication, deselect (rising edge) to stop communication.
- 3: Analog Signal Output
- 4: RXD
- 5: Open Drain
- 6: GND
- 7: Control Signal (Optional)
- 8: TXD

Note: Some external equipment requires no connection to pins 5 and 7.

23 Using The Sensor Module

23.1 Gas Flow Routing Connection

The DigiPID has an “IN” and “OUT” port for sampling gas. Make sure that the in and out sample tubes are properly oriented.

After making all gas connections and ensuring connection to the 8-pin connector, turn on the power supply and warm up the sensor module.

Note: A two-hour warm-up time is recommended before making measurements.

Firmly affix the sensor module to external equipment and make sure the 8-pole interface connector makes a reliable, tight connection with other equipment.

When you begin measurement, the sensor provides data to external equipment, showing the current concentration of the specified gas. Data is output digitally via the UART port or as an analog signal (0.5V to 2.5V) from pin 3 of the interface connector. The sensor module can be calibrated for different operations and gases.

If the DigiPID sensor is connected to RAE Systems equipment, you can affix the sensor module directly to the equipment and then turn on the instrument's power supply. The sensor module runs normally. If the other external equipment is not a RAE Systems product, additional firmware and software support is necessary. RAE Systems can provide essential information such as the handshaking protocol, port setting, flow rating, etc.

RAEGuard 2 PID User's Guide

23.2 Sensor Module Calibration

The sensor module is calibrated before it leaves the factory. However, you can also calibrate the sensor module. Allow it to warm up for two hours before calibrating it. Calibration should be performed using external equipment, using a two-point calibration for the 100 and 1000 ppm VOC sensor.

100 ppm and 1000 ppm range sensor module calibration. First perform a zero gas calibration by applying fresh air to the sensor module. If the module is configured for use with a pump, the fresh air's flow rate must be greater than the pump's draw rate. A calibration time of 1 minute is recommended. The other calibration point requires exposure of the sensor to span gas. The span gas concentration should be 10 ppm (for 100 ppm range) or 100 ppm (for 1000 ppm range) isobutylene, and calibration time is also 1 minute.

IMPORTANT!

Whenever you change the sensor head while the instrument is in operation, follow this procedure:

Press and hold [+] until the screen says:

Change Sensor

Press [+]. The RAEGuard 2 performs a full startup.

If you leave the sensor head detached from the RAEGuard 2 for more than 60 seconds, it goes into alarm and displays this message:

Sensor Fail:0

Replace the sensor head and follow the procedure above for restarting it.

RAEGuard 2 PID User's Guide

23.3 Maintenance And Calibration

The sensor module should be calibrated if it does not pass a bump test, but no less than every 6 months, depending on use and exposure to gas and contamination.

23.4 Replacing the Lamp And Filter

The sensor module is shipped with the lamp, sensor, and stainless-filter installed. Periodically check the filter for dirt and contamination, which can impact the reading and response time.

Note: Always turn off power to the DigiPID before checking and servicing any parts. After inspection and/or replacement of parts, recalibrate the instrument.



The lamp and sensor are not interchangeable with parts from other manufacturers; use only RAE Systems replacements. Use of non-RAE Systems components will void the warranty and can compromise the safe performance of this product.

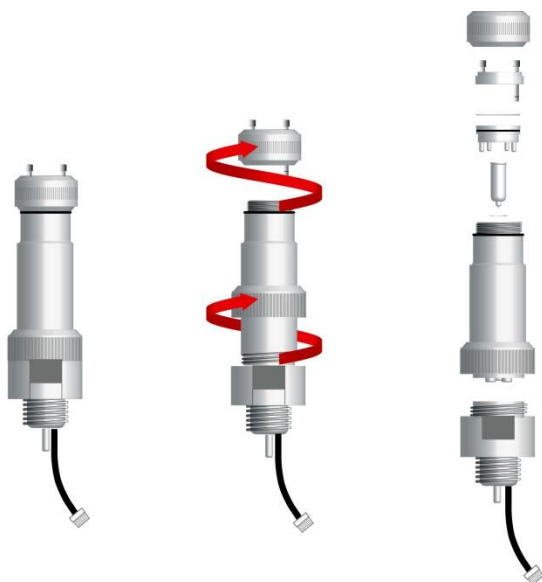

Loosening the fastening nut allows the DigiPID to be easily detached from a base.

RAEGuard 2 PID User's Guide



Attachment ring



Inlet/Outlet



Filter



Sensor Module



PID Lamp



Teflon O-ring



Housing



IMPORTANT!
Align hole in filter with hole in top of PID sensor to ensure unobstructed sample flow

IMPORTANT!
Only handle lamp by holding sides of end. Do not touch flat surface.

24 Replacing The Sensor's Teflon UV Shield

On the underside of the sensor module is a Teflon UV Shield that should be replaced every 90 days, in order to ensure sensor accuracy.

1. Dismantle the DigiPID as shown on page 70, and remove the Sensor Module. **Note:** Be careful to not touch the PID lamp's surface.

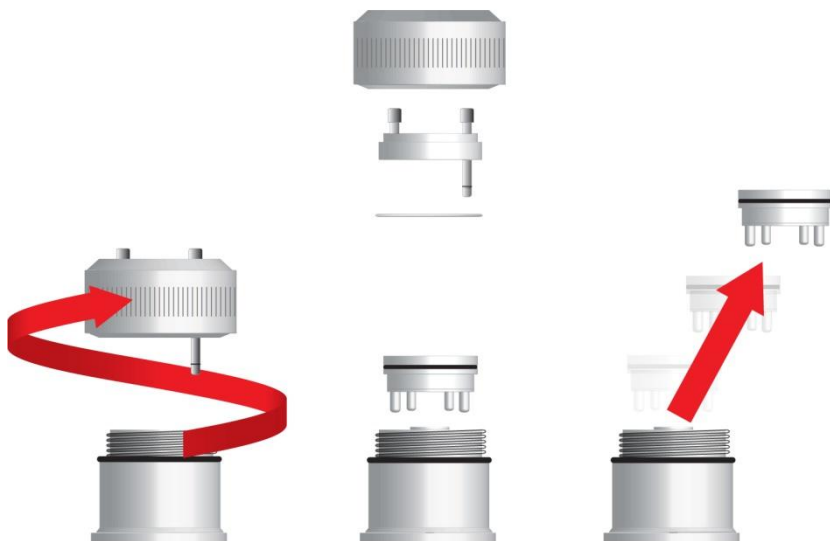

2. Remove the Sensor Module, and replace it with a new one (a spare Sensor Module is included with the unit).
3. Take the old Sensor Module to your shop/service center to perform the rest of the activities, which will refresh the Sensor Module and make it ready as a replacement spare.

Note: Teflon UV Shields are available from RAE Systems in packages of 10 (P/N: C01-2017-000).

RAEGuard 2 PID User's Guide

4. Unscrew and remove all four of the gold-plated contact “legs” from the Sensor Module.



5. Use a small flat-bladed screwdriver or similar tool to get between the Sensor Module and the Teflon UV Shield at the point nearest the shield's large “notch,” and gently pry it up.



6. Work the blade or tool around the bottom of the Sensor Module, lifting the Teflon UV Shield as you go around.

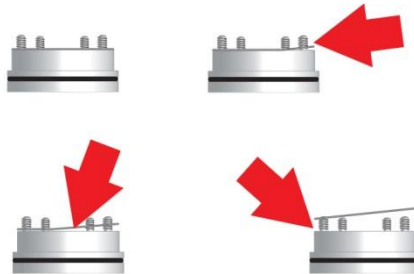

7. Once the Teflon UV Shield has been separated far enough from the Sensor Module to remove it, use your fingers to pull it over the four contact “legs” and discard it.

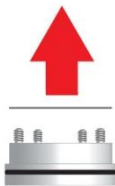

Sensor



**Discard the used
Teflon Shield**

RAEGuard 2 PID User's Guide

- Slide a new Teflon UV Shield over the contact “legs,” and gently press it down until it is snug against the surface of the Sensor Module.



- Use your fingers to screw on the four contact “legs.”

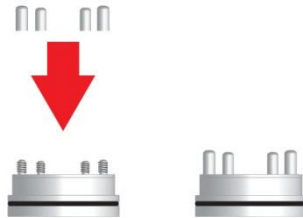

- Use a soft, clean cloth to wipe any finger oils from the surface of the contact “legs,” and set the Sensor Module aside.
- Inspect the surface of the PID lamp. Clean it with GC-Grade methanol on a swab, as outlined in the next section.

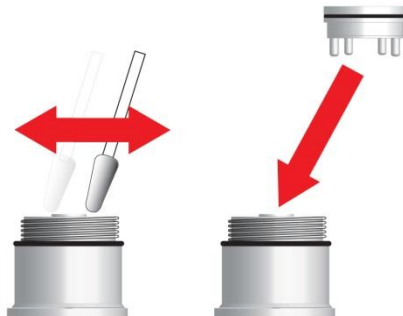

- After the surface of the PID lamp dries, reassemble the unit.

25 Sensor & Lamp Cleaning/Replacement

Clean the PID sensor module, the lamp and housing only if:

1. The reading is inaccurate even after calibration.
2. The reading is very sensitive to air moisture.
3. A liquid has been sucked into the unit and damaged the unit.

Use of the external filter helps to prevent contamination of the sensor.

To access the sensor components and lamp, gently unscrew the sensor cover. Then hold the PID sensor and pull it straight out. A slight, gentle rocking motion helps release the sensor.

25.1 Cleaning The PID Sensor

Place the entire PID Sensor Module into GC-grade methanol. It is highly recommended that an ultrasound bath to be used to clean the sensor for at least 15 minutes. Then dry the sensor thoroughly. Never touch the electrodes of the sensor by hand.

Also use a methanol-soaked cotton swab to wipe off the lamp housing where it contacts the sensor when the sensor is installed.

Turn over the sensor so that the pins point up and the sensor cavity is visible. Examine the sensor electrodes for any corrosion, damage, or bending out of alignment. The metal sensor electrode “fingers” should be flat and straight. If necessary, carefully bend the sensor fingers to ensure that they do not touch the Teflon portions and that they are parallel to each other. Make sure that the nuts on the sensor pins are snug but not overtight. If the sensor is corroded or otherwise damaged, it should be replaced.

25.2 Cleaning The Lamp Housing Or Changing The Lamp

If the lamp does not turn on, the instrument will display an error message to indicate replacement of the lamp may be required.

1. If the lamp is operational, clean the lamp window surface and the lamp housing by wiping it with GC grade methanol using a cotton swab using moderate pressure. After cleaning, hold the lamp up to the light at an angle to detect any remaining film. Repeat the process until the lamp window is clean. Never use water solutions to clean the lamp. Dry the lamp and the lamp housing thoroughly after cleaning.

CAUTION: Never touch the window surface with the fingers or anything else that may leave a film. Never use acetone or aqueous solutions.

2. If the lamp does not turn on, remove the lamp from the lamp housing. Place the lamp O-ring onto the new lamp. Insert the new lamp, avoiding contact with the flat window surface.
3. Reinstall the PID sensor module.
4. Tighten the sensor cover.

RAEGuard 2 PID User's Guide

25.3 Cleaning The Instrument

Occasional cleaning with a soft cloth is recommended. Do not use detergents or chemicals.

25.4 Ordering Replacement Parts

If you need replacement parts, contact your local RAE Systems distributor. A list is available online:

<http://www.raesystems.com>

In the U.S., you can order sensors, replacement batteries, and other accessories online at:

<http://istore.raesystems.com/>

25.5 Special Servicing Note

If the instrument needs to be serviced, contact either:

1. The RAE Systems distributor from whom the instrument was purchased; they will return the instrument on your behalf.

or

2. The RAE Systems Technical Service Department. Before returning the instrument for service or repair, obtain a Returned Material Authorization (RMA) number for proper tracking of your equipment. This number needs to be on all documentation and posted on the outside of the box in which the instrument is returned for service or upgrade. Packages without RMA Numbers will be refused at the factory.

RAEGuard 2 PID User's Guide

26 Electronic Waste Disposal



At the end of its life, this product must undergo separate collection and recycling from general or household waste.



RAEGuard 2 PID User's Guide

27 Technical Support

To contact RAE Systems Technical Support:

Monday through Friday, 7:00AM to 5:00PM Pacific (US) Time

Phone (toll-free): +1 888-723-4800

Phone: +1 408-952-8461

Email: tech@raesystems.com

Life-critical after-hours support is available:

+1 408-952-8200 select option 9

28 RAE Systems Contacts

RAE Systems

World Headquarters

3775 N. First St.

San Jose, CA 95134-1708 USA

Phone: +1 408.952.8200

Fax: +1 408.952.8480

E-mail: customerserv@raesystems.com

Web Site: www.raesystems.com

RAE Systems Technical Support

Monday through Friday, 7:00AM to 5:00PM Pacific Time

Phone: +1.408.952.8461

Email: tech@raesystems.com

Life-critical after-hours support is available

+1.408.952.8200 select option 9

RAEGuard 2 PID User's Guide

RAE Systems Europe ApS

Kirstinehøj 23 A
DK-2770 Kastrup
Denmark

Phone: +45 86 52 51 55

Fax: +45 86 52 51 77

orders@raeeurope.com

sales@raeeurope.com

service@raeeurope.com

Web: www.raesystems.eu

RAE Systems UK Ltd

D5 Culham Innovation Centre
Culham Science Centre
Abingdon, Oxon OX14 3DB
United Kingdom

Phone: +44 1865408368

Fax: +44 1235531119

Mobile: +44 7841362693

Email: raeuk@raeeurope.com

RAE Systems France

336, rue de la fée des eaux
69390 Vernaison
France

Phone: +33 4 78 46 16 65

Fax: +33 4 78 46 25 98

Email: info-france@raeeurope.com

Web: www.raesystems.fr

RAEGuard 2 PID User's Guide

RAE BeNeLux BV

Rijndal 20
2904 DC Capelle a/d IJssel
Phone: +31 10 4426149
Fax: +31 10 4426148
Email: info@rae.nl
Web: www.rae.nl

RAE Systems Spain, s.l.

Av. Remolar, 31
08820 El Prat de Llobregat
Spain
Phone: +34 933 788 352
Fax: +34 933 788 353
Mobile: +34 687 491 106
Email: mdelgado@raespain.com
Web: www.raespain.com

RAE Systems Middle East

LOB 7, Ground Floor, Office 19,
Jebel Ali Free Zone
Dubai, United Arab Emirates
Phone: +971.4.887.5562
Email: mesales@raesystems.com

RAE Systems (Hong Kong) Ltd.

Room 8, 6/F, Hong Leong Plaza
33 Lok Yip Road
Fanling, N.T, Hong Kong
Phone: +852.2669.0828
Fax: +852.2669.0803
Email: hksales@raesystems.com

RAEGuard 2 PID User's Guide

RAE Systems Japan

Marunouchi Nakadori Bldg 6F-617-B,
2-3, Marunouchi 2-Chome, Chiyoda-ku,
Tokyo, 100-0005 Japan

Phone: +81-3-6269-9646

Fax: +81-3-6269-9647

Email: jpsales@raesystems.com

RAE Systems Korea

#1010, DaeMyungAnsVill First,
Sang-Dong 412-2, Wonmi-Gu, Bucheon,
Kyungki-Do, Korea

Phone: 82-32-328-7123

Fax: 82-32-328-7127

Email: krsales@raesystems.com



RAE Systems
World Headquarters
3775 N. First St.
San Jose, CA 95134-1708 USA
Phone: 408.952.8200
Toll-Free: 888.723.4800
Fax: 408.952.8480

E-mail (sales support): raesales@raesystems.com
Web Site: www.raesystems.com

Technical Support

Phone: 408.952.8461 (Mon-Fri, 7AM-5PM, PST)
Email: tech@raesystems.com

Product Registration

www.raesystems.com/support/product-registration

RAE Systems Europe

Kirstinehøj 23A, DK-2770 Kastrup • Denmark
Tel: +45.8652.5155 • Fax: +45.8652.5177
Web: www.raesystems.eu • Email: sales@raeeurope.com

RAE Systems (Hong Kong) Ltd.

Units 1516-18, 15/F, Delta House, 3 On Yiu Street
Shatin, N.T. Hong Kong
Web: www.raesystems.hk • Email: asiasales@raesystems.com
Phone: +852.2669.0828

RAE Systems Middle East

LOB 7, Ground Floor, Office 19, Jebel Ali Free Zone
Dubai, United Arab Emirates
Email: mesales@raesystems.com • Phone: +971.4.887.5562