



3Z9097

Rev. A

INSTRUCTIONS – 使用説明 説明 – 지시사항

SG3-E, SG3-A Airless Spray Guns

SG3-E 及 SG3-A 無空氣噴槍

SG3-E, SG3-A 에어レス噴霧 Guns

SG3-E, SG3-A 무공 스프레이건

3600 psi (248 bar, 24.8 MPa) Maximum Working Pressure

3600 psi (248 bar, 24.8 MPa) 最大工作壓力

3600 psi (248 bar, 24.8 MPa) 最大動作圧

3600 psi (248 bar, 24.8 MPa) 최대 허용 압력

SG3-E

243238, A

Reversible Tip Guard, 515 Tip

可逆向噴頭防護罩, 515 噴頭

리버시블先端ガード, 515 先端

변환가능 팁 가드, 515 Tip

SG3-A

243382, A

Reversible Tip Guard, 515 Tip

可逆向噴頭防護罩, 515 噴頭

리버시블先端ガード, 515 先端

변환가능 팁 가드, 515 Tip

All models not available in all countries

并非所有國家都有全部的型號

い全モデルがすべての国で使用できるわけではありません。

국가에 따라 구입할 수 없는 모델이 있을 수도 있습니다.

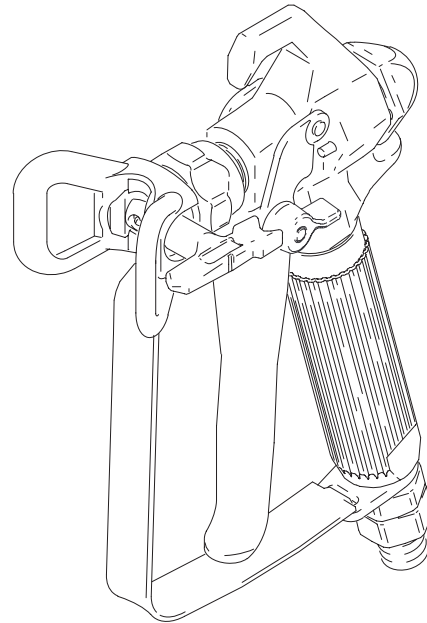

TI0103

243012

GRACO INC. P.O. BOX 1441 MINNEAPOLIS, MN 55440-1441

Graco Inc. is registered to I.S. EN ISO 9001

Graco Inc.は I.S. EN ISO 9001に登録されています。

Graco 公司獲 I.S. EN ISO 9001 註冊認證

Graco사는 I.S. EN ISO 9001에 등록되어 있습니다.

⚠ WARNING

Fire and explosion hazard: Solvent and paint fumes can ignite or explode.

To help prevent a fire and explosion:

● **Use in an extremely well ventilated area.**

● Eliminate all ignition sources; such as pilot lights, cigarettes and static arcs from plastic drop cloths. Do not plug or unplug power cords or turn lights on or off in spray area.

● Ground Sprayer, object being sprayed, paint and solvent pails.

● Hold gun firmly to side of grounded pail when triggering into pail.

● Use only conductive airless paint hose.

● Do not use 1,1,1-trichloroethane, methylene chloride, other halogenated hydrocarbon solvents or fluids containing such solvents in pressurized aluminum equipment. Such use could result in a chemical reaction, with the possibility of explosion.



⚠ 警告

火災と爆発危険: 溶剤及塗料の蒸気會點燃或爆炸。為避免火災及爆炸:

● 在通風非常好的地方使用。

● 清除所有火源, 如引火火焰、煙頭及來自塑料罩單的靜電火花。不要在噴塗區域插拔電源插頭及開關電燈。

● 將噴塗器、所噴物體、塗料桶及溶劑桶接地。

● 朝桶內啟動扳機時, 要握緊噴槍靠在接地桶的邊上。

● 只能使用導電的無空氣塗料軟管。

● 不要在加壓的鋁材裝置中使用1,1,1-三氯乙烷、二氯甲烷、其它鹵代烴溶劑或含有這些溶劑的溶液。否則會導致化學反應, 并可能會引起爆炸。

Fluid injection and high pressure hazard: High pressure spray or leaks can inject fluid into the body.

To help prevent injection, always:

● Engage trigger safety latch when not spraying.

● Keep clear of nozzle and leaks.

● Never spray without a tip guard.

● Do **PRESSURE RELIEF** if you stop spraying or begin servicing sprayer.

● Do not use components rated less than sprayer *Maximum Working Pressure*.

● Never allow children to use this unit.

● Brace yourself; gun may recoil when triggered.

If high pressure fluid pierces your skin, the injury might look like "just a cut". But it is a serious wound! Get immediate medical attention.



射流注射和高壓危險: 高壓噴射或洩漏會造成液體注入體內。

為避免受注射, 總是:

● 不噴塗時鎖上扳機的安全鎖。

● 避開噴嘴及洩漏處。

● 切勿在未使用噴頭防護罩時進行噴塗。

● 停止噴塗或開始維修噴塗器時要將壓力釋放。

● 不要使用額定壓力小於噴塗器最大工作壓力的部件。

● 切勿讓兒童使用該設備。

● 當扳機啟動時噴槍可能有後坐力, 請支撐好您自己。

如果您的皮膚被高壓射流刺破, 傷勢看起來會象"只划了一小口"。但傷勢其實是嚴重的! 應即刻進行治療。

⚠ 警告

火災と爆発の危険: 溶剤および気化した塗料は引火または爆発する虞があります。

火災および爆発を避けるには:

● 通気性の極めて優れた場所でのみ使用する。

● 種火やタバコ、ビニール製のしずくよけ布からの静電アークなど、すべての発火元を除去します。電源コードのプラグを差したり抜いたり、あるいは噴霧場所でスイッチを入切しないで下さい。

● 噴霧器、噴霧対象物、塗料および溶剤入り容器は接地してください。

● 容器中に発射する場合、噴霧器を容器の接地側に向けてしっかりと持ってください。

● エアレス伝導性ホースを必ず使用してください。

● 1,1,1-トリクロロエタン、塩化メチレン、および他のハロゲン化された炭化水素溶剤または圧縮されたアルミニウム装置の溶媒を含む液体を使用しないでください。上記の液体を使用すると化学反応を引き起こし、爆発する可能性があります。



⚠ 경고

화재 및 폭발위험: 솔벤트와 페인트 가스는 발화되거나 폭발할 수 있습니다.

화재나 폭발을 방지하려면:

● 통기 상태가 최상인 지점에서만 사용하십시오.

● 점화용 보조 버너, 담배, 비닐 깔개로부터 발생하는 정전기 아크와 같은 모든 발화가능성이 있는 원인이 되는 것을 제거하십시오. 스프레이 지역에서 전원코드와 전등을 연결하거나 차단하지 마십시오.

● 분사기와 스프레이 대상 물건, 그리고 페인트와 솔벤트통을 접지하십시오.

● 솔벤트통에 스프레이건을 향할 때는 바닥에 놓인 통의 측면에 단단히 붙이세요.

● 전도성의 무공 페인트호스를 사용하십시오.

● 1,1,1-트리클로로에탄, 메칠렌클로라이드나, 이런 솔벤트를 포함한 다른 할로겐화 된 탄화수소 솔벤트나 용액을 고압 알루미늄 기계에 사용하지 마십시오. 이런 물질을 사용하는 경우에 화학반응을 일으켜 폭발이 발생할 소지가 있습니다.

液体の噴射および高圧の危険: 高圧の噴霧または漏れがあると、液体を体へ噴射してしまう危険性があります。

液体の噴射を避けるためには:

● 噴霧を行なわないときは、トリガの安全ラッチをかけてください。

● ノズルおよび漏れた液体を取り除きます。

● 先端のガードがない場合は絶対に噴霧しないでください。

● 噴霧を中止するか、または噴霧器の修理を開始する前には、圧力を抜いてください

● 最大動作圧以下のコンポーネントを使用しないでください。

● 本ユニットを絶対に小児に使用させないでください。

● 吹き付け器の引き金を引くと、反動で吹き付け器が動きます。注意してください。

高圧の液体が皮膚に接触すると、軽度の切り傷のようになりますが、傷を放置しておくとは非常に危険です。直ちに救急処置を行ってください。



용액의 인체 주입 및 고압 위험: 고압의 스프레이나 호스의 누출부분이 용액을 인체에 주입시킬 우려가 있습니다.

용액의 인체 주입을 방지하려면, 항상 다음을 명심하세요:

● 스프레이하지 않을 때는 안전장치 스위치를 사용하세요.

● 몸을 노즐과 누출부분과 어느 정도 간격을 유지하세요.

● 팁 가드를 부착하지 않은 상태에서는 절대로 스프레이 하지 마세요.

● 스프레이를 중단하거나 분사기를 수리할 경우에는 압력 배출을 실행하세요.

● 분사기 최대 허용압력 이하 등급의 부품을 사용하지 마세요.

● 절대로 이 장비를 어린이가 사용하도록 하지 마세요.

● 신체를 방어하세요. 방아쇠를 당기면 스프레이건이 튕길 수도 있습니다.

고압의 용액이 피부에 침투한 경우에, 상처가 "평범한 상처"로 보일 수도 있습니다. 그러나 이것은 중상입니다! 즉시 치료를 받으도록 하십시오.

CONTROLS / 控制 / 制御 / 제어기

Trigger Lock / 扳機鎖 / 트리거 록 / 안전 스위치

Needle Adjustment

針頭調整 / 針의調整 / 팁 가드

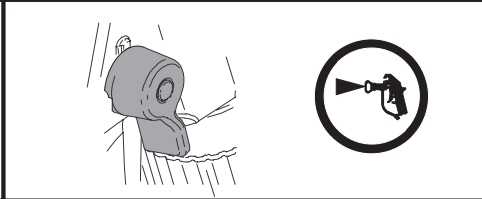
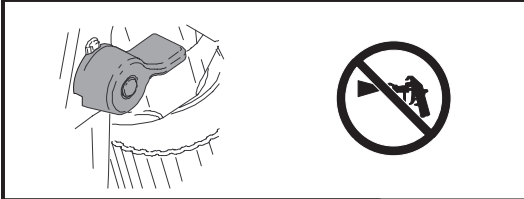

Tip Guard / 噴頭防護罩

先端ガード / 팁 가드

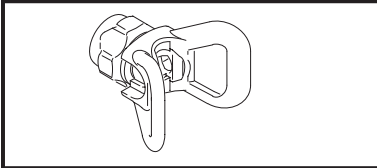

Trigger / 扳機 / 트리거 / 방아쇠

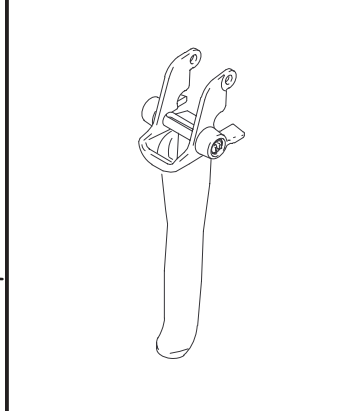

Tip / 噴頭 / 先端 / 팁

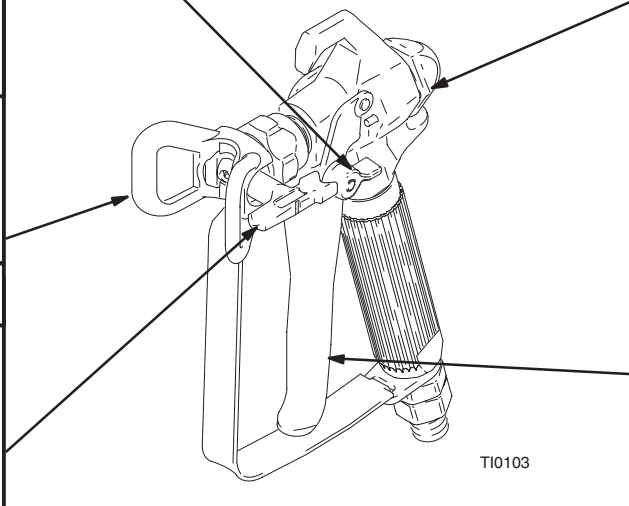
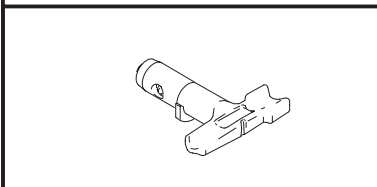

TI0103

PRESSURE RELIEF / 壓力釋放 / 圧力抜き / 압력 배출



Follow 1-5 when you stop spraying.

停止噴塗時按步驟 1-5 進行。

噴霧を停止した際、1-5のステップに従ってください。

스프레이를 중단할 15 단계를 따르시오.

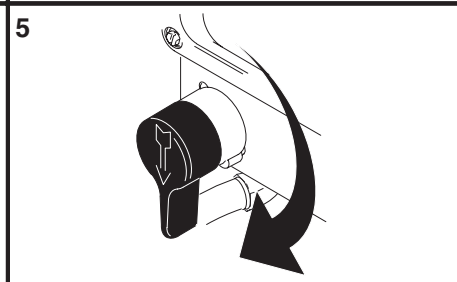
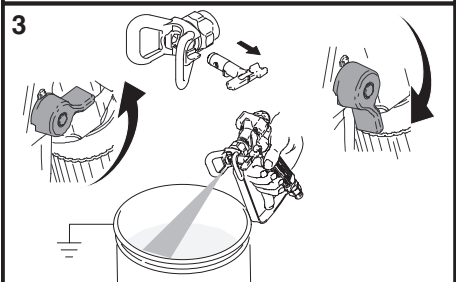
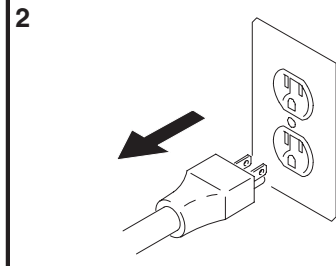
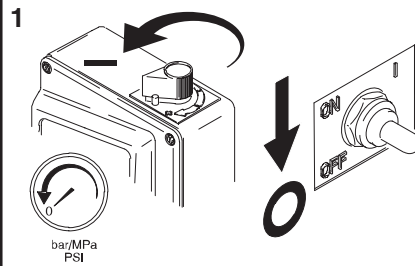

ALIGN SPRAY / 調整噴塗 / 噴霧의調節 / 스프레이 조정하기

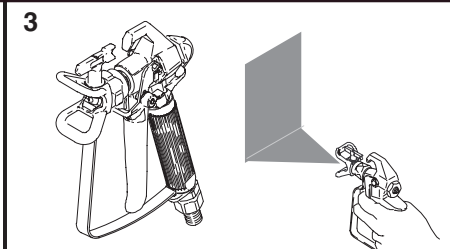
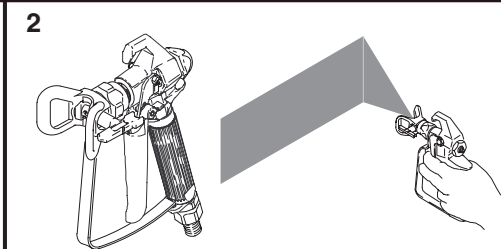
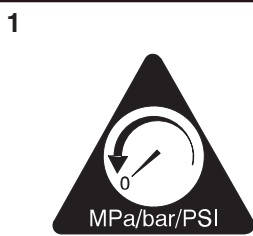

ADJUST SPRAY / 調整噴塗 / 噴霧の調整 / 스프레이 조정하기

<p>1</p> <p>WARNING 警告 警告 경고</p>	<p>2</p>	<p>3</p>	<p>4</p>
---	----------	----------	----------

CLEAR CLOG / 清除堵塞物 / 詰まりの清掃 / 막힘 제거

CAUTION / 告誡
注意 / 주의

<p>1</p> <p>WARNING 警告 警告 경고</p>	<p>2</p>	<p>3</p>	
---	----------	----------	--

REPLACE NEEDLE / 更換針頭 / 針の交換 / 니들 교체하기

<p>1</p>	<p>2</p>	<p>3</p>	<p>4</p> <p>OLD 舊的 旧 현 부품</p>
----------	----------	----------	---

<p>5</p> <p>CLEAN 清理 洗浄 닦아 주기</p>	<p>6</p> <p>SILICON 硅 シリコン 실리콘</p> <p>GREASE 上潤滑脂 注意グリース 윤활유 칠하기</p>	<p>7</p> <p>NEW 新的 新 새 부품</p>	<p>8</p> <p>LOOSE 松 緩める 느슨하게 된다</p>
--	--	--	--

9

Grease
上潤滑脂
注意グリース
윤활유 칠하기

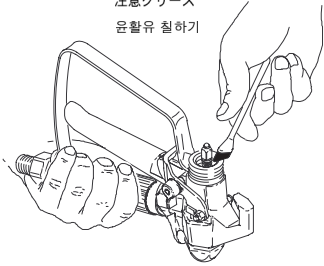

10

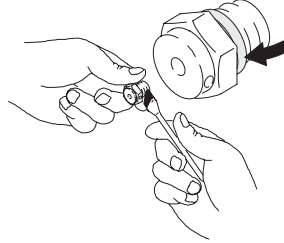

11

26-32 ft-lb (19-24 N.m)

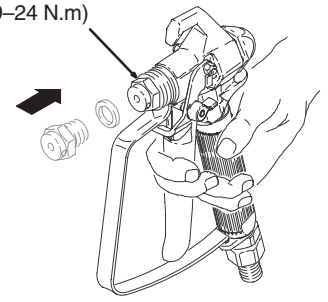

ADJUST NEEDLE / 調整針頭 / 針の調整 / 니들 조정하기

1

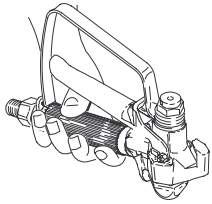

2

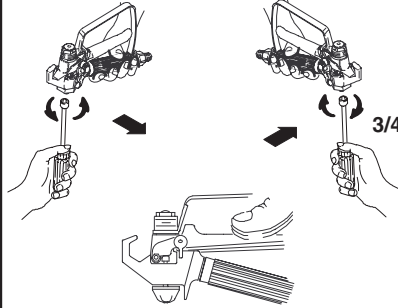

3

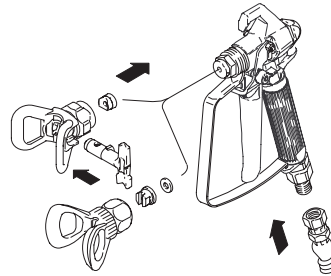

4

PRIME SPRAYER
給噴塗器注塗料
一次噴射機
분사기 프라임하기

5



6

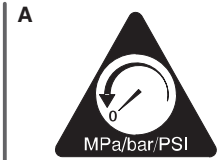

B
ADJUST NEEDLE
調整針頭
針の調整
니들 조정하기

7

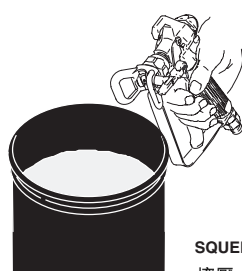
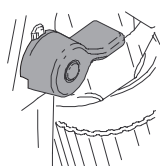

IF 若 IF 만약 이렇다면



THEN 則 THEN 이와 같이



B
ADJUST NEEDLE
調整針頭
針の調整
니들 조정하기

Parts Drawing / 部件圖

部品の取り出し / 부품 도면

243238, A
243382, A

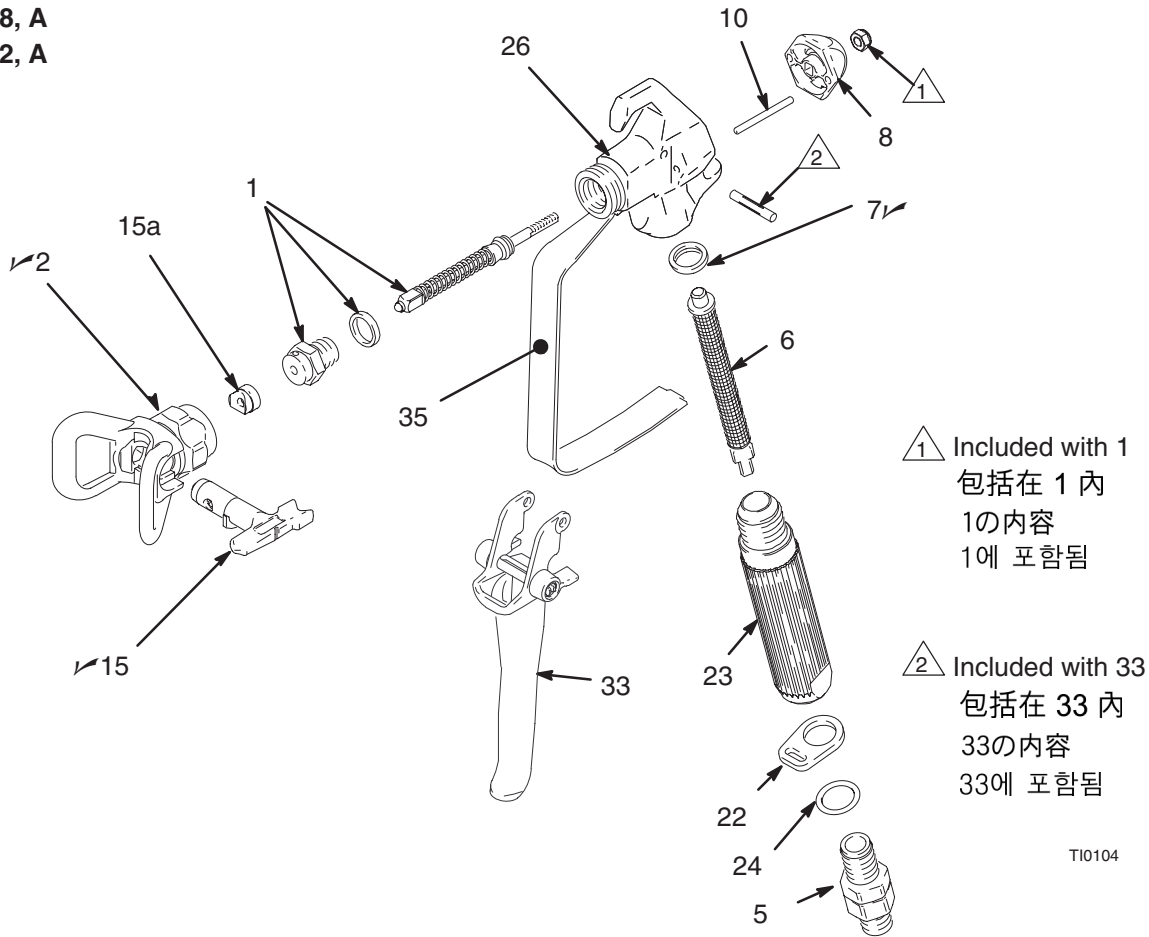

Parts List / 部件 清單 / 部品 リスト / 부품 목록

Ref. No.	Part No.	Description	Qty.	Ref. No.	Part No.	Description	Qty.
1	218070	KIT, repair, gun	1	33		Kit, replacement, trigger	
2✓	243161	GUARD, tip, RAC 5	1		243553	243382	1
4		GUARD, trigger			243639	243238	1
	195495	243238	1	34▲	222385	CARD, WARNING, not shown	1
	190975	243382	1	35▲	290230	LABEL, WARNING, 243382 only	1
5	238200	KIT, swivel	1				
6✓	218131	FILTER, gun	1				
7✓	179733	SEAL, sleeve	1				
8	195395	CAP, end	1				
10	115484	PIN, actuator	2				
15✓	286515	TIP, spray, cylinder; size 515, includes 15a	1				
15a	243281	SEAT, cylinder	1				
22	113409	RETAINER, guard	1				
23		HANDLE, gun					
	195788	243238	1				
	195920	243382	1				
24	115485	O-RING	1				
26	195390	HOUSING, fluid	1				

▲ Replacement Danger and Warning labels, tags and cards are available at no cost.

✓ Keep these spare parts on hand to reduce down time.

▲ 可免費提供各種危險和警告的標牌、標籤及卡片更換件。

✓ 手頭應備有這些零配件，以縮短停工時間。

▲ 交換用の危険、警告ラベル、

タグおよびカードは無料で入手できます。

✓ いつでも修理できるようスペア部品はお手元に保管

しておいてください。

▲ 위험 및 경고 라벨, 표지, 카드는 무료로 구할 수 있습니다.

✓ 이러한 여분의 부품들을 구비해서 고장으로 인한 비가동 시간을 줄이도록 하십시오.

Graco Standard Warranty

Graco 公司的標準擔保書

Graco標準保証

Graco 표준 하자보증

Graco warrants all equipment referenced in this document which is manufactured by Graco and bearing its name to be free from defects in material and workmanship on the date of sale by an authorized Graco distributor to the original purchaser for use. With the exception of any special, extended, or limited warranty published by Graco, Graco will, for a period of twelve months from the date of sale, repair or replace any part of the equipment determined by Graco to be defective. This warranty applies only when the equipment is installed, operated and maintained in accordance with Graco's written recommendations.

This warranty does not cover, and Graco shall not be liable for general wear and tear, or any malfunction, damage or wear caused by faulty installation, misapplication, abrasion, corrosion, inadequate or improper maintenance, negligence, accident, tampering, or substitution of non-Graco component parts. Nor shall Graco be liable for malfunction, damage or wear caused by the incompatibility of Graco equipment with structures, accessories, equipment or materials not supplied by Graco, or the improper design, manufacture, installation, operation or maintenance of structures, accessories, equipment or materials not supplied by Graco.

This warranty is conditioned upon the prepaid return of the equipment claimed to be defective to an authorized Graco distributor for verification of the claimed defect. If the claimed defect is verified, Graco will repair or replace free of charge any defective parts. The equipment will be returned to the original purchaser transportation prepaid. If inspection of the equipment does not disclose any defect in material or workmanship, repairs will be made at a reasonable charge, which charges may include the costs of parts, labor, and transportation.

THIS WARRANTY IS EXCLUSIVE, AND IS IN LIEU OF ANY OTHER WARRANTIES, EXPRESS OR IMPLIED, INCLUDING BUT NOT LIMITED TO WARRANTY OF MERCHANTABILITY OR WARRANTY OF FITNESS FOR A PARTICULAR PURPOSE.

Graco's sole obligation and buyer's sole remedy for any breach of warranty shall be as set forth above. The buyer agrees that no other remedy (including, but not limited to, incidental or consequential damages for lost profits, lost sales, injury to person or property, or any other incidental or consequential loss) shall be available. Any action for breach of warranty must be brought within two (2) years of the date of sale.

GRACO MAKES NO WARRANTY, AND DISCLAIMS ALL IMPLIED WARRANTIES OF MERCHANTABILITY AND FITNESS FOR A PARTICULAR PURPOSE, IN CONNECTION WITH ACCESSORIES, EQUIPMENT, MATERIALS OR COMPONENTS SOLD BUT NOT MANUFACTURED BY GRACO. These items sold, but not manufactured by Graco (such as electric motors, switches, hose, etc.), are subject to the warranty, if any, of their manufacturer. Graco will provide purchaser with reasonable assistance in making any claim for breach of these warranties.

In no event will Graco be liable for indirect, incidental, special or consequential damages resulting from Graco supplying equipment hereunder, or the furnishing, performance, or use of any products or other goods sold hereto, whether due to a breach of contract, breach of warranty, the negligence of Graco, or otherwise.

FOR GRACO CHINESE, JAPANESE AND KOREAN CUSTOMERS

The Parties acknowledge that they have required that the present document, as well as all documents, notices and legal proceedings entered into, given or instituted pursuant hereto or relating directly or indirectly hereto, be drawn up in English.

對於GRACO 公司的中國、日本和韓國用戶

各當事人承認他們已要求用英語制訂本文及所訂立、提出或制定的依此或直接或間接與此有關的所有文件、通知及訴訟。

GRACO中国および日本のお客様対象

中国および日本のお客様は、現在および将来のドキュメント、通知、および直接間接に締結または提供、されることに同意したものとみなされます。

한국 및 중국의 GRACO사 고객들께

계약 당사자들은 본 서류를 포함 이 구매계약과 직, 간접적으로 관련된 모든 서류, 통지 및 법적 절차는 영문으로 쓰기로 합의 했다는 것을 인정합니다.

ADDITIONAL WARRANTY COVERAGE

Graco does provide extended warranty and wear warranty for products described in the “Graco Contractor Equipment Warranty Program”.

額外擔保範圍

對於” Graco 承包商設備擔保方案” 中所描述的產品，Graco 公司確實提供延期擔保和磨損擔保。

追加保証の適用範圍

Gracoでは「Graco契約者向け装置保証プログラム」に記載の製品に関し、拡張保証および摩耗保証を提供しております。

추가 하자보증

Graco사는 “Graco Contractor Equipment Warranty Program ”에 설명되어 있는 제품들에 대해 추가 하자보증 및 보증을 제공합니다.

TO PLACE AN ORDER OR FOR SERVICE, contact your Graco distributor,
or call 1-800-690-2894 to identify the nearest distributor.

需要訂貨或服務，請與Graco 公司的經銷商聯系，
或打電話 1-800-690-2894 以確定離您最近的經銷商。

サービスのご注文は、Gracoディストリビュータにお問い合わせ頂くか、
または 1-800-690-2894に電話してお近くのディストリビューターをご
確認ください。

주문 또는 서비스 신청을 하려면, 구입한 Graco사 대리점에 연락하거나,
1-800-690-2894에 전화해 가까운 Graco사 대리점을 확인하십시오.

All written and visual data contained in this document reflects the latest product information available at the time of publication. Graco reserves the right to make changes at any time without notice.

本文所含的數據只反映其在出版時可提供的最新產品資料。Graco 公司保留無須通告隨時修改這些數據的權利。

本ドキュメント内の記載事項および図、グラフ等の資料は出版時に入手可能な製品の最新情報を反映しています。Gracoはいつでも予告無しに内容を変更する権利を有します。

본 설명서에 포함된 모든 문서상 도면상의 내용은 이 설명서 발행 당시의 가능한 가장 최근의 제품정보를 반영하는 것입니다. Graco사는 통보 없이 어느 시점에라도 제품에 변경을 가할 권리를 보유하고 있습니다

Sales Offices: Minneapolis, Detroit
Foreign Offices: Belgium, Korea, Hong Kong, Japan

銷售處: Minneapolis, Detroit
海外辦事處: 比利時、韓國、香港、日本

營業事務所: ミネアポリス、デトロイト
駐在事務所: ベルギー、韓国、香港、日本

GRACO INC. P.O. BOX 1441 MINNEAPOLIS, MN 55440-1441
<http://www.graco.com>

PRINTED IN USA 3Z9097 1/2000