

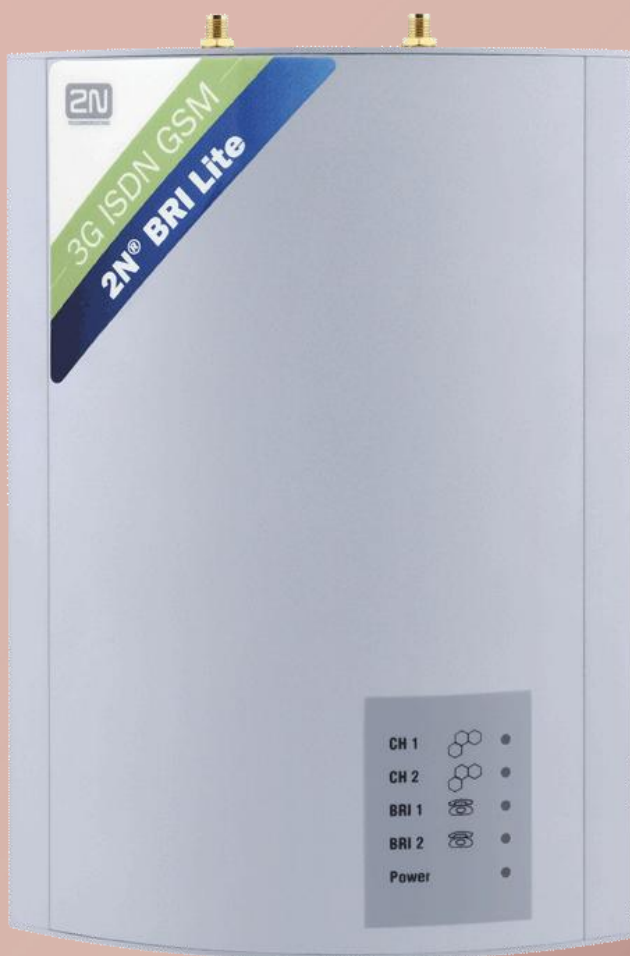

2N<sup>®</sup>

# BRI Lite



## User manual

Version 1.4

[www.2n.cz](http://www.2n.cz)

*Dear customer,*

let us congratulate you on having purchased the **2N<sup>®</sup> BRI Lite** system. This new product has been developed and produced in order to provide the maximum utility value, quality and reliability to the user. We hope you will be fully satisfied with the 2N<sup>®</sup> BRI Lite for a long time.



The manufacturer constantly improves the software contained in the product (the so-called firmware). The technology used therein helps you download the latest firmware version to the 2N<sup>®</sup> BRI Lite gateway using a common PC anytime. For the latest firmware version see [www.2n.cz](http://www.2n.cz). For necessary instructions refer to Section 7.2 hereof. We recommend you to apply the latest version to avoid problems that have already been eliminated.

Grey marked text of this User Guide specifies functions of the gateway, which will be supported in newer versions of firmware. You also find the latest version of the User Manual at [www.2n.cz](http://www.2n.cz)

Check your delivery for completeness according to the packing list and study this manual carefully before installing this product. The manufacturer shall not be responsible for damage caused by any use of this product in contradiction with the User Manual. The warranty terms and conditions do not apply to damage incurred as a result of gross handling and/or undue storing of the product or violation of the technical parameters included herein.

This manual is very much detailed and includes subsections that are irrelevant for the basic installation purposes as well as subsections referring to other BRI GSM gateway models.

## ■ Packing List

---

Please check your 2N<sup>®</sup> BRI Lite delivery for compliance with the following packing list.

Item	Pieces
2N 2N <sup>®</sup> BRI Lite – check the model type according to the order number, see the type label on the gateway back side	1
Mains adapter according to type	1 <sup>*</sup>
USB cable	1
ISDN 4-wire (RJ-45) cable	1
Antenna	1-2 <sup>**</sup>
Wall mounting holder	1
Dowels	2
Screws	2
This manual	1
Warranty certificate	1
Compliance certificate	1
2N product CD	1

---

\* none for rack version

\*\* according to the number of GSM modules



# ■ Contents

---

<b>SECTION 1 – PRODUCT PRESENTATION .....</b>	<b>1</b>
1.1. Purpose .....	2
1.2. How to Cut Telephone Costs .....	2
1.3. Other Advantages and Applications .....	3
<b>SECTION 2 – INSTALLATION .....</b>	<b>5</b>
2.1. Get Started.....	6
2.2. Brief Installation Guide.....	7
2.3. Proper Mounting.....	9
2.4. PC Connection .....	11
2.5. Antenna Connection .....	11
2.6. Gateway Power Supply .....	12
2.7. SIM Card Installation/Removal .....	13
2.8. NT or TE Connection .....	13
2.9. Status Indicators.....	15
2.10. Lithium Battery Replacement .....	18
2.11. Fuse Replacement.....	19
<b>SECTION 3 – ISDN BRI EXTENSION CONFIGURATION .....</b>	<b>20</b>
3.1. Point-to-Point Connection.....	21
3.2. Point-to-Multipoint Connection.....	21
<b>SECTION 4 – BRI GSM GATEWAY CONNECTION OPTIONS .....</b>	<b>22</b>
4.1. Connection of ISDN TE to 2N <sup>®</sup> BRI Lite.....	23
4.2. 2N <sup>®</sup> BRI Lite Point-to-Point Connection.....	23
<b>SECTION 5 – TELEPHONY VIA THE GSM GATEWAY .....</b>	<b>25</b>
5.1. Functions Supported by 2N <sup>®</sup> BRI Lite gateway.....	25
5.2. Call Routing Rules .....	26
5.3. LCR table .....	26
5.4. Routing of Outgoing GSM Calls .....	27
5.5. Routing of Incoming GSM Calls.....	29
5.6. DISA Message Recording.....	31

**SECTION 6 INTRODUCTION OF CONFIGURATION PROGRAM 34**

6.1. 2N<sup>®</sup> BRI Lite Program Installation .....35  
6.2. Running of BRI config program.....35  
6.3. Configuration Program Basic Menu .....38  
6.4. Button Bar .....47  
6.5. Topic List and Alphabetical Glossary .....47

**SECTION 7 CONFIGURATION .....49**

7.1. 2N<sup>®</sup> BRI Lite Gateway Communication Establishing .....51  
7.2. Firmware Version Identification .....51  
7.3. Gateway License.....51  
7.4. Load / Save Parameters.....52  
7.5. System Parameters .....52  
7.6. ISDN Parameters .....54  
7.7. ISDN port modes .....58  
7.8. GSM parameters - General .....59  
7.9. GSM outgoing calls.....63  
7.10. GSM incoming calls.....67  
7.11. Prefixes.....71  
7.12. LCR table .....72  
7.13. Autorouting Table .....74

**SECTION 8 – CONFIGURATION USING TERMINAL .....76**

8.1. USB Communication Settings .....77  
8.2. Terminal Communication .....77  
8.3. GSM Gateway Behaviour .....77  
8.4. List of Terminal AT Commands .....78  
8.5. Records on Operation (LOG) .....90  
8.6. Records on Calls.....92  
8.7. Statistics – Description.....93

**SECTION 9 – TECHNICAL PARAMETERS .....95**

SECTION 1

---

## **Product Presentation**

Here is a survey of what you will find in this section:

- Purpose
- How to Cut Telephone Costs
- Other Advantages and Applications
- RF Radiation Safety Precautions

## 1.1. Purpose

- The 2N<sup>®</sup> 2N<sup>®</sup> BRI Lite helps interconnect the ISDN and GSM networks. It can also be applied in direct ISDN PBX - GSM connections, in combination with an ISDN telephone set, analog telephone set or a coin-operated telephone connected through a terminal adapter, etc.
- The voice mode, i.e. an outgoing or incoming call, is the basic function of the system. The gateway is equipped with all functions necessary for such use and provides a very high comfort in this mode.
- In addition to voice transmission, 2N<sup>®</sup> **BRI Lite** can send and receive short text messages. This function along with other additional functions enhances the utility value of the product.
- No extra equipment (an external GSM telephone, etc.) is needed for normal operation. All programmable parameters are default-preset in such a manner that you can commence your telephone traffic the moment you connect the USB and supply cables, antenna and SIM card and set the ISDN and GSM parameters.

## 1.2. How to Cut Telephone Costs

- Once your 2N<sup>®</sup> **BRI Lite** gateway has been connected to your ISDN PBX, all calls going out to a mobile network are made directly. **This saves your PSTN - mobile network call costs.** All mobile telephone calls of your personnel in the field are cheaper too.
- You are advised to use the **most advantageous rate of your GSM provider** for your GSM gateway because all gateway user call accounts are added up for billing purposes.
- You can block groups of numbers in your gateway. **You shall pay nothing for the calls you have barred.**
- 2N<sup>®</sup> **BRI Lite** keeps detailed records on all calls. This helps you **find out easily why your bill is higher than it should be.**
- The Least Cost Router is flexible enough to help you set rules for **GSM calling at the lowest possible operation costs.**



- 
- **The intelligent CallBack function** enables your personnel to call at the cost of your GSM gateway SIM cards.

### 1.3. Other Advantages and Applications

- 2N<sup>®</sup> BRI Lite gateways integrate the best of their respective communication technologies.
- The **Intelligent Routing of Incoming Calls** function accelerates connecting of incoming calls and makes calling more comfortable.
- The DISA function with an easily recordable welcome message is available.
- You can use the conditioned or unconditioned call forwarding function.
- Unlike mobile telephones, this system does not expose you to the RF electromagnetic field while making calls.
- Password for configuration of the gateway on all ports
- CLIP and CLIR for incoming calls from GSM network
- ENBLOC / OVERLAP mode of sending called number to ISDN network
- Sending of SMS messages in case of missed call on GSM network side
- Remote GSM control for easy controlling your GSM gateway\*

\*optional

## RF Radiation Safety Precautions



It is prohibited to use any transmitters, including GSM gateways, in areas where explosives are used, such as quarries.

It is forbidden to use mobile phones and thus GSM gateways too at refuelling points.

A GSM gateway may affect sensitive life-saving devices in medical centres. So it is prohibited to use mobile phones and GSM gateways here.

In general, any restriction regarding mobile phones based on RF energy radiation applies to GSM gateways.

Where necessary, a GSM gateway may be installed at a safe distance (in the neighbouring building, e.g.) and a BRI ISDN connection cable may be carried from the GSM gateway to the original building.

Although GSM gateways are not intended for aircraft or cars, all relevant restrictions and regulations regarding mobile phones apply to them here.

## SECTION 2

---

# Installation

Here is a survey of what you will find in this section:

- Get Started
- Brief Installation Guide
- Proper Mounting
- PC Connection
- Antenna Connection
- Gateway Power Supply
- SIM Card Installation/Removal
- NT or TE Connection
- Status Indicators
- Lithium Battery Replacement<sup>1</sup>
- Fuse Replacement

<sup>1</sup>According to order number

## 2.1. Get Started

Before you start installing your 2N<sup>®</sup> BRI Lite gateway, get familiar with its physical structure, arrangement of connectors and status indicators, see Fig. 1, Fig. 2, and Fig. 12.

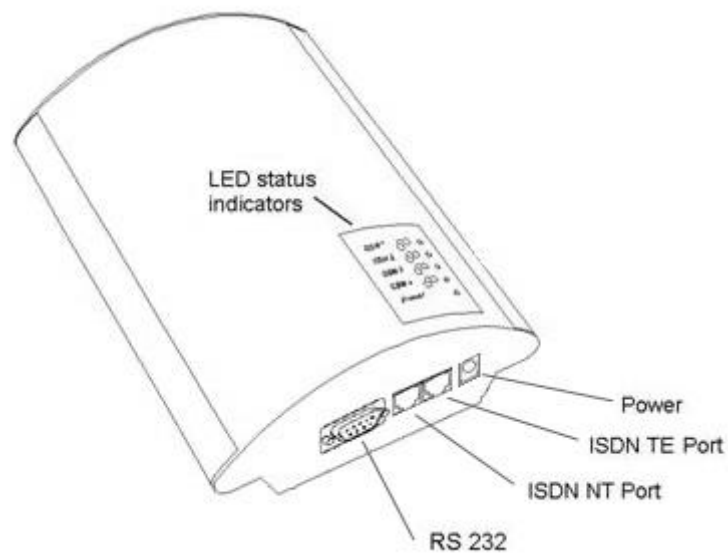

Fig. 1 – Bottom View

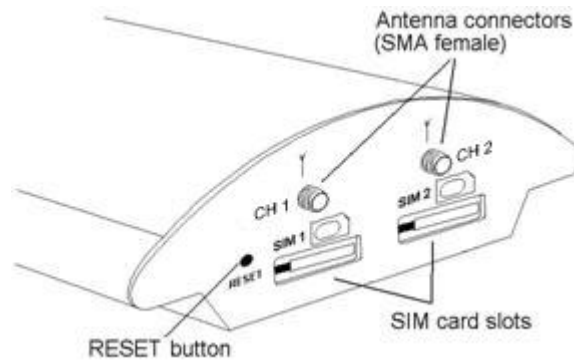

Fig. 2 – Top View

---

## 2.2. Brief Installation Guide

- **Proper mounting** – 2N<sup>®</sup> BRI Lite is designed for suspension on a vertical surface. Fit the holder included in the delivery on a wall and hang the gateway on it. For details on the prescribed working position and other recommendations refer to Subs. 2.3.
- **Cable connection** – connect the gateway using ISDN cable to your ISDN PBX (or any other ISDN terminals). For more details on proper wiring refer to Subs. 2.4.
- **Antenna connection** – connect an internal antenna or an external antenna cable into the SMA antenna connector. Place the external antenna on a place with a good GSM / UMTS signal (refer to Subs. 2.5).
- **Gateway power supply** – the delivery includes a mains adapter. Plug in the adapter connector into the gateway and the power adapter into a wall socket. The gateway turns on immediately (see Subs.2.6).
- **SIM card insertion** – SIM cards are inserted in holders on the gateway top. The SIM card holder is of the push/pull type, which means that all you have to do is insert a SIM card and press the holder gently until it snaps into position (see Subs.2.7). Secure the SIM card with a latch to avoid incidental removal. **!CAUTION! If you use SIM cards with active PIN protection, first set an identical PIN code for all SIM cards used in the GSM gateway, save it into the GSM gateway configuration and only then insert the SIM cards in the GSM gateway.**
- **PC connection** – the gateway parameters are normally set using the configuration software available on the CD included in the delivery. To interconnect your PC with the GSM ISDN gateway use the RS323 cable included in the delivery\*.
- **Configuration program installation** - run the installation file from the installation CD on a PC connected to the gateway and install the configuration software (refer to Subs. 6.1).

---

\* according to the order number

- **Configuration program** - run the configuration program installed and select a **COM port for your PC** to establish USB - gateway connection. Establish communication between your PC and the gateway (refer to Subs. 7.2).
- **2N<sup>®</sup> BRI Lite configuration** - now use the configuration software to set all necessary gateway parameters - ISDN parameters, basic GSM parameters and tariff metering/pricing parameters, routing, restrictions, rates, system parameters, and input and switch properties. Having set the required parameters, upload the configuration data to the gateway via a **serial link USB**. For more details on the configuration software see Section 7.

---

## 2.3. Proper Mounting

- The 2N<sup>®</sup> BRI Lite is designed for mounting on a vertical surface. For this purpose a wall-mounting holder is available. Just fit the holder with dowels and screws (Fig. 3) to the wall and hang the gateway as shown in Fig. 4.

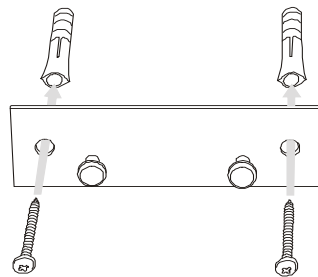

Fig. 3 – Gateway Holder Wall-Mounting

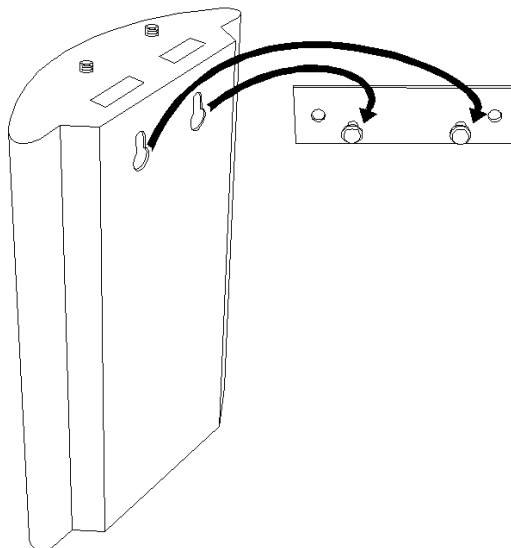

Fig. 4 – Gateway Hanging

- It is possible to operate the GSM gateway in another working position (e.g. on a desk) for a short time only, for example in servicing centres for quick testing purposes.

The allowed working temperature and relative humidity ranges are included in Section 9.

- Exceeding the recommended operating temperature values need not affect the gateway function immediately but may result in more rapid ageing and lower reliability.
- The gateway is intended for indoor use. It may not be exposed to rain, flowing water, condensed moisture, fog, or mist.
- The gateway may not be exposed to aggressive gas, acid vapours, solvents, etc. or aggressive liquids, during cover cleaning, for example.
- The GSM gateway is not designed for high-vibration environments, e.g. means of transport, machine rooms, etc.
- Free space has to be left under and over the gateway for cables and agitated air to remove operational heat.
- Install the gateway on a place with a good GSM signal.
- A misplacement of the GSM gateway or its antenna near television, broadcasting or similar RF-sensitive devices may evoke an adverse effect upon their function.
- Being a source of RF energy emission, the gateway antenna should not be located close to human bodies. The hazard is higher than with mobile telephones because the gateway is usually used by many people and thus employed more often.



---

## 2.4. PC Connection

The 2N<sup>®</sup> BRI Lite can be connected to a PC using a USB cable terminated with a USB-B connector. A direct connection of 2N<sup>®</sup> BRI Lite and a PC is necessary for the initial gateway configuration.

The gateway USB port default parameters are 921,600 bps, 8 data bits, no parity, 1 stop bit, no flow control. Set the same parameters for the communication program on the PC side.

## 2.5. Antenna Connection

The BRI GSM gateway has one SMA antenna connector for each GSM module, see Fig. 5. An external antenna cable is connected to these connectors. The external antenna should be installed vertically on a place with a good GSM signal. For the technical parameters of the antennas refer to Section 9.

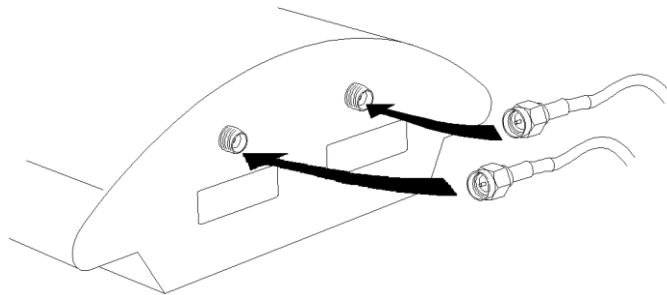

Fig. 5 – Antenna Connection

Tighten the antenna connector **gently with your hand**, never use a wrench!

## 2.6. Gateway Power Supply

- Be sure to use only the mains supply adapter that is included in the gateway delivery.
- Before plugging in the gateway, make sure that the mains voltage value meets the data given on the mains adapter label.
- Make sure that the antenna has been connected. If you connect the gateway to the power supply without an antenna, the GSM module transmitter might get damaged.
- Now plug the supply adapter into a mains socket and connect the adapter connector to the gateway, see Fig. 6. The status indicators indicate the proper operation. For their meanings refer to Subs. 2.9.

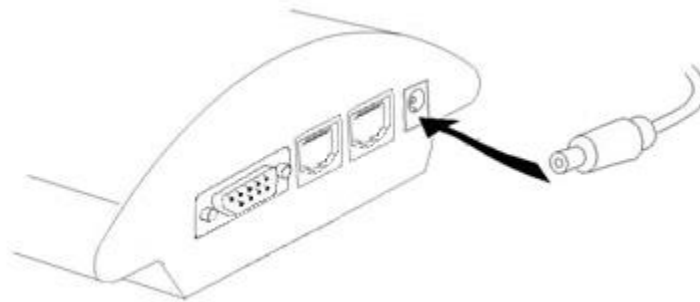

Fig. 6 – Supply Adapter Connection

---

## 2.7. SIM Card Installation/Removal

Insert the SIM card into the SIM card slots with your hand as shown in Fig. 7. Please make sure that the SIM card contact plates are on the side closer to the GSM gateway antenna connectors. Having inserted the SIM card, push the card gently until you hear a click signalling that the card has been snapped

by the push/pull holders. Secure the SIM card by shifting the latch to the right in order to avoid incidental removal of the SIM card.

To remove the SIM card take the opposite steps. You can replace a SIM card even with the gateway on.

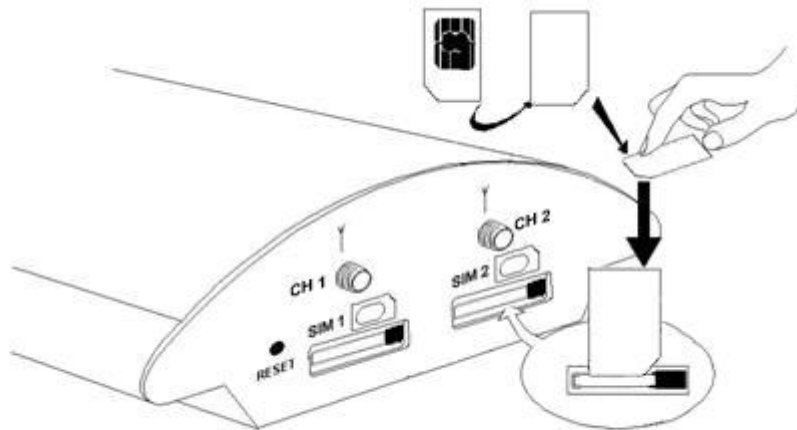

Fig. 7 – SIM Card Inserting Procedure

In case of SIM card replace is necessary to make restart of GSM module or whole gateway.

## 2.8. NT or TE Connection

ISDN terminals are connected to the NT and TE connectors depending on the configuration of your telecommunication equipment. They are connected using a 4-wire passive bus through RJ-45 connectors. For NT or TE connections see Fig. 9

and Fig. 10. The RJ-45 pins for TE and NT are shown in Fig. 8. Please keep in your mind, that 2N<sup>®</sup> BRI Lite gateway has only one BRI ISDN interface. So you can use only one RJ45 connector in one time (as NT or as TE according to configuration)!

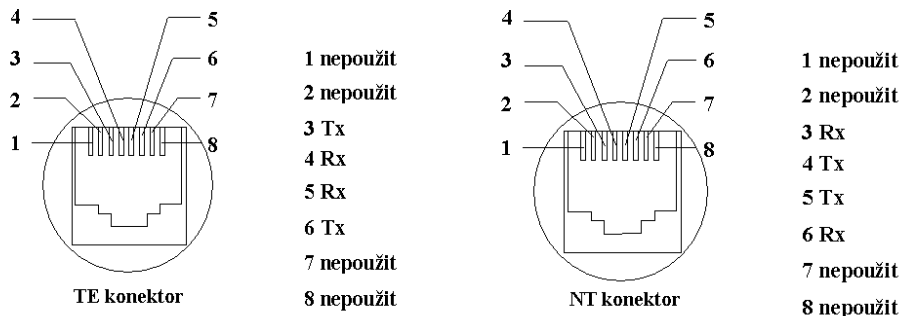

Fig. 8 - TE and NT Connector Pins

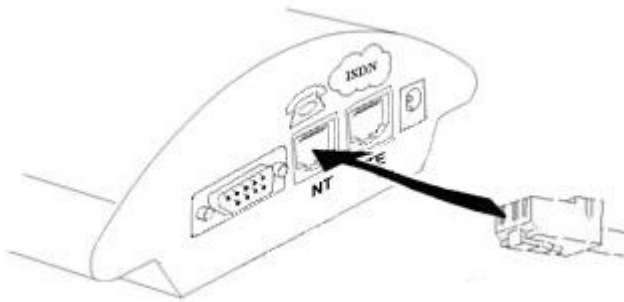

Fig. 9 - ISDN GSM Gateway Connected as Network Terminal (NT)

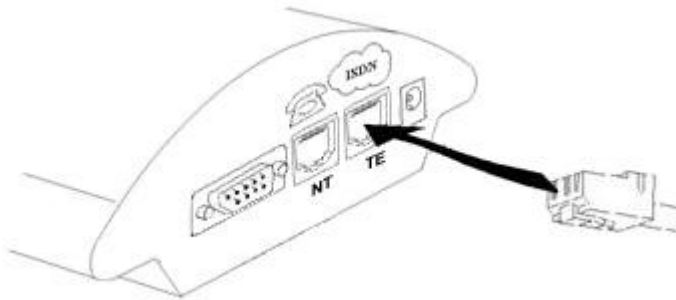
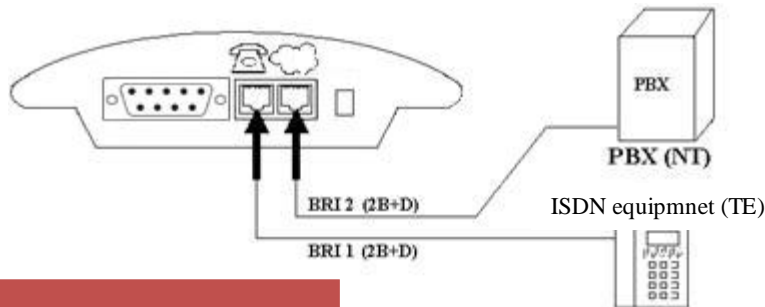

Fig. 10 - ISDN GSM Gateway Connected as ISDN Terminal (TE)



Note: BRI Lite contain only one BRI ISDN interface. You can connect only one type of opposite equipment (e.g. PBX or ISDN phone)

Fig. 11 - Basic ISDN GSM Gateway Wiring Diagram

Choose the specific wiring as shown in Section 4.

## 2.9. Status Indicators

There is a panel with five LEDs on the gateway upper cover for a quick GSM gateway status detection (see Fig. 12). The *Power* LED signals that the gateway as a whole is in operation. The *BRI 1* and *BRI 2* LEDs indicate the status of both the B channels of the basic ISDN extension, and the *GSM 1* and *GSM 2* LEDs indicate the status of the respective GSM modules.

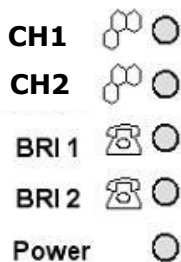

Fig. 12 - Signalling LEDs

Basic diagnostic tests and gateway initialisation are performed automatically whenever the gateway is connected to supply voltage. Each test step is signalled by a specific colour combination of the LEDs. If a test step fails, the indicator combination related to the failed test remains lighted. This provides a convenient troubleshooting tool to the technical support personnel.

## Power Indicator

The *Power* LED signals whether the BRI GSM gateway is supplied or not.

<b>Power Indicator (green)</b>	
<b>Power</b>	<b>LED colour/status</b>
No light	The system is not working. / Blown fuse.
Continuous light	The system is working.

Tab. 1 – Survey of Power Indicator Statuses

## BRI Indicators

The *BRI 1* and *BRI 2* LEDs signal the statuses of your ISDN extension B channels, each being assigned to one B-channel of ISDN interface. (TE or NT – according to configuration). *BRI 1* indicates the status of the first B channel between the GSM gateway and ISDN terminals/PBX, while *BRI 2* relates to the second B channels between the GSM gateway and ISDN terminals/PBX.

<b>BRI 1 / BRI 2 (green)</b>	
<b>BRI 1 / BRI 2</b>	<b>LED colour / status</b>
Channels are not occupied and physical and data link layers are activated	no light
TEI binded, link layer not activated	Orange / BRI 2 are shining
1. B-channel towards TE/NT is occupied	Green / BRI 1 is shining
2. B-channels towards TE/NT are occupied	Green / BRI 2 is shining
TE/NT not connected	Red / BRI 2 is shining
Physical layer activated	Red / BRI 2 are blinking

Tab. 2 – Survey of BRI 1 / BRI 2 Indicator Statuses

---

## GSM Indicators

The CH1 and CH2 indicators signal statuses of the respective GSM modules. Whenever the 2N<sup>®</sup> BRI Lite is started, detection of the GSM modules and SIM cards is carried out. This process is signalled by a red LED, which goes on a few seconds after voltage is supplied. The GSM module detection takes a few seconds. In case a GSM module or SIM card is absent, the red LED keeps shining. If a GSM module is not supplied, the respective GSM LED is blinking red. After a correct GSM module initialisation, the SIM card starts logging into the provider's network, which is indicated by a quickly blinking green colour. If the log-in has been successful, the LED goes out. If not, it shines red.

In normal operation, a slowly blinking green LED indicates establishing of an incoming or outgoing call and a permanently green LED means a successfully established connection within the respective GSM module.

A survey of GSM module status signalling is included in Tab. 3

GSM indicators	
GSM 1 or GSM 2	LED colour / status
The module is ready and logged-in	No light
Call establishing	Green / blinking slowly 1:1
Currently made call	Green / shining
SIM card initialisation	Green / blinking quickly 1:1
SIM card initialisation in progress	Shining red
GSM module / SIM card absent	Red / shining
GSM module not supplied	Red / blinking quickly

Tab. 3 - Survey of GSM Module Status Signalling

## 2.10. Lithium Battery Replacement<sup>1</sup>

Lithium battery contains only models with serial number 09-XXXX-XXXX!



**WARNING! An incorrect battery replacement may result in explosion.** For replacement, batteries of the same or equivalent type as recommended by the manufacturer may be used only. **The battery type is CR2032.**

**WARNING! Never use metal tools for battery replacement** to avoid short-circuit. Battery short-circuiting may result in battery destruction or explosion.

Keep the proper battery polarity.

Dispose of used batteries in accordance with applicable waste regulations, for example in waste recycling centres.

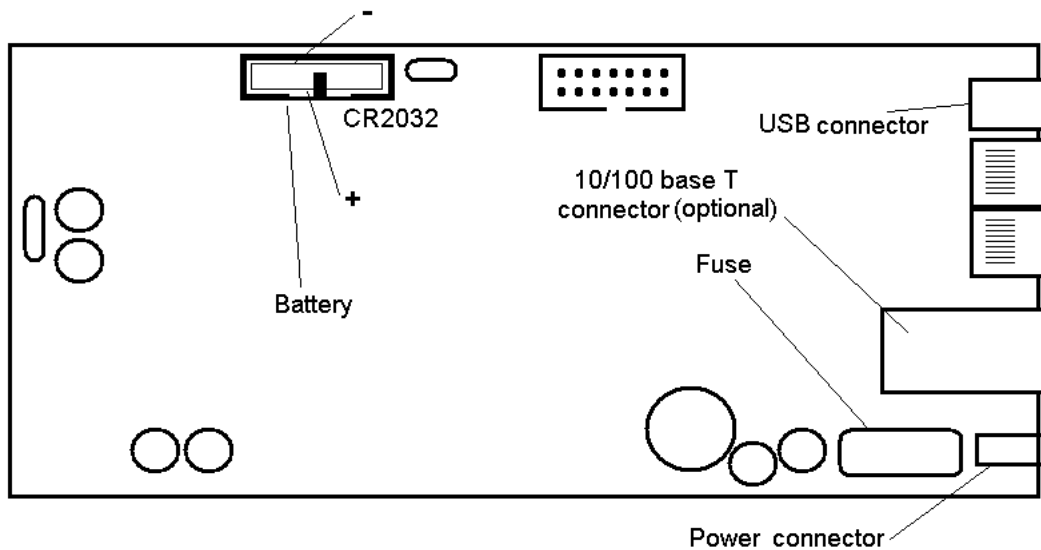

Fig. 13 – Motherboard Diagram

The lithium battery only supplies the real time internal clock in the 2N Lite gateway in the event of power failure. It is unnecessary for the gateway function. Its average service life is approximately 3 years. You are recommended to replace it after three years for preventive purposes or, at least, check the voltage with a

<sup>1</sup> depends on gateway order number.



---

voltmeter (the value should not drop below 2.9 V). A completely low battery results in the 2N<sup>®</sup> BRI Lite gateway losing the time and date information - false data appear also in the service log buffer listing.

Replacing the lithium battery, first disconnect your 2N<sup>®</sup> BRI Lite gateway from the mains and open the cover. Remove the old battery from the holder using a suitable tool and install a new one.

## 2.11. Fuse Replacement



**WARNING!** Use only a fuse of the same type.

Disconnect the adapter power while replacing the fuse.

Fuse can be replaced only by service which is personnel qualified to check such parameters as power consumption, DC voltage etc.

If fuse fails again, unit must be returned to manufacturer for repair

To exchange the fuse disconnect power adapter cable first. The location of the fuse on the main board is on the Fig. 13. Open the cover, remove the faulty fuse and check it. **Replace the fuse by a fuse of the same type only.** Close the cover and reconnect the power adapter cable.

## SECTION 3

---

# ISDN BRI Extension Configuration

To configure your 2N<sup>®</sup> BRI Lite properly, you have to know the type of connection of your ISDN terminals. This section helps you install your GSM gateway between already interconnected ISDN terminals.

For information on the ISDN type refer to your ISDN provider's registration form or check with your telephone network administrator.

This section includes:

- Point-to-Point Connection
- Point-to-Multipoint Connection

---

### 3.1. Point-to-Point Connection

The Point-to-Point (EuroISDN with DDI) configuration interconnects directly one ISDN terminal (TE) with a network terminal (NT) (see Fig. 14). This type is applied mainly where PBXs are connected to the ISDN.

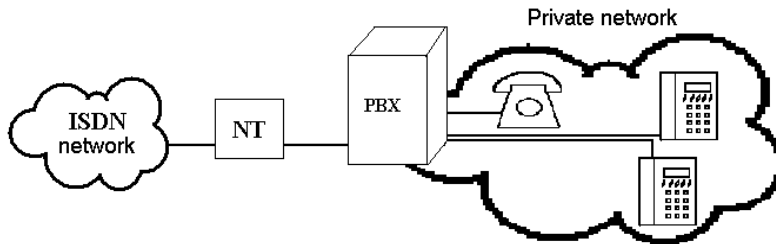

Fig. 14 - Point-to-Point Connection

### 3.2. Point-to-Multipoint Connection

Point-to-Multipoint (EuroISDN with MSN) is another type of ISDN terminal interconnection. Here the network terminal (NT) is interconnected with up to eight ISDN terminals through a 4-wire passive bus as shown in Fig. 15.

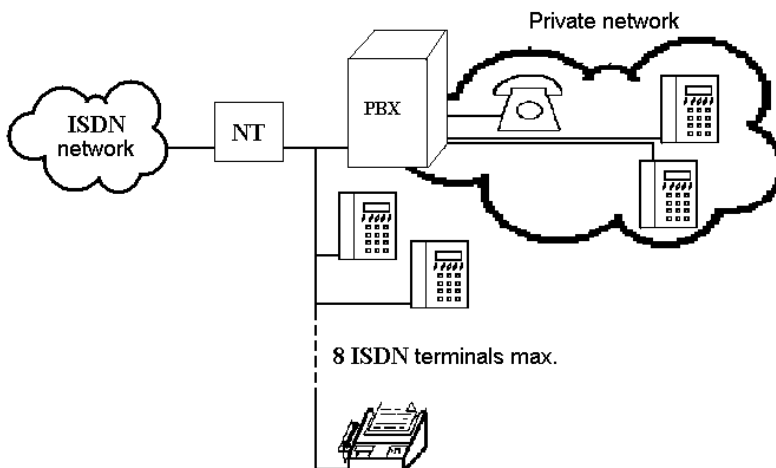

Fig. 15 - Point-to-Multipoint Connection

SECTION 4

---

## **BRI GSM Gateway Connection Options**

This section deals with the connection options of the 2N<sup>®</sup> BRI Lite to the ISDN Basic Rate extension.

This section includes:

- Connection of ISDN TE to
- 2N<sup>®</sup> BRI Lite Point-to-Point Connection

---

#### 4.1. Connection of ISDN TE to 2N<sup>®</sup> BRI Lite

The connection in Fig. 16 provides communication via a GSM gateway without PSTN connection. The ISDN telephone set is connected to the NT port of the GSM gateway, while a mains adapter simulating power supply from the public network is connected to the TE port. The adapter is available under the part No. 5020001.

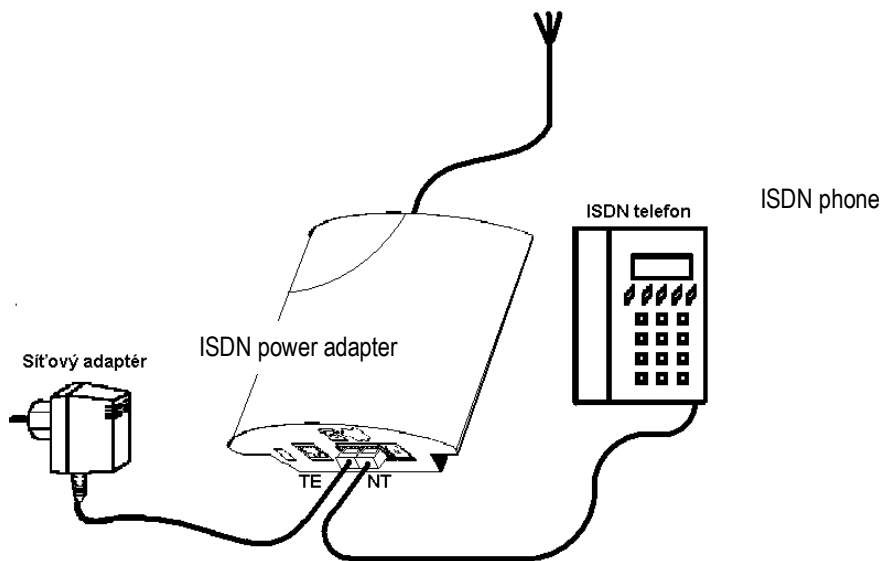

Fig. 16 - ISDN Telephone-Gateway Connection with Power Supply Simulation

#### 4.2. 2N<sup>®</sup> BRI Lite Point-to-Point Connection

This type of connection is especially suitable for direct calls from an ISDN branch network to a GSM network.

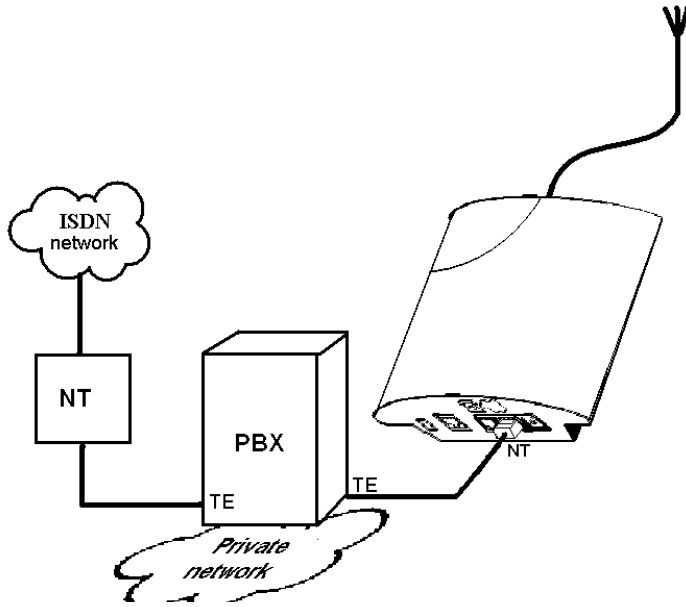

Fig. 17 - ISDN BRI GSM Point-to-Point Connection as ISDN NT

## SECTION 5

---

### Telephony via the GSM Gateway

This section contains information on routing calls through the GSM gateway. Gateway configurations are described that help you make the most of the gateway potential and minimise your telephone costs.

This section includes:

- Functions Supported by
- Call Routing Rules
- LCR table
- Routing of Outgoing GSM Calls
- Routing of Incoming GSM Calls
- DISA Message Recording

#### 5.1. Functions Supported by 2N<sup>®</sup> BRI Lite gateway

- Call routing according to time and called destination through the destination's operator;
- Auto CLIP routing;
- Outgoing call routing by time LCR (Least Cost Routing);
- DISA (tone dial-in);

- DISA to GSM (tone dial-in from ISDN ports to GSM networks);
- CallBack to GSM;
- SMS sending/receiving;
- SMS at no Answer;
- Password for configuration of the gateway on all ports
- CLIP and CLIR for incoming calls from GSM network
- ENBLOC / OVERLAP mode of sending called number to ISDN network
- Remote control over GSM (CSD)<sup>2</sup>

## 5.2. Call Routing Rules

The GSM gateway ports are logically divided into internal and external. While GSM ports are external only, ISDN port is internal. You can define whether your internal port calls should be routed to external ports, or to the operator, or according to the active DISA function (tone dial-in). Furthermore, you can route calls according to the CLIP, MSN (Multiple Subscriber Number) (for ISDN extensions), or direct GSM gateway dial-in (ISDN extension with DDI).

If an outgoing call is routed via a port that is busy, the remaining available ports are searched for (depending on the configuration) and if no allowed outgoing port is free, the outgoing call is rejected with defined (depending on the configuration) ISDN release cause.

The routing algorithm routes outgoing calls according to the outgoing call type, current time rate, day in a week, and GSM provider's free minutes if any (depending on the configuration).

## 5.3. LCR table

The LCR (Least Cost Routing) chart is the key telephone cost cutting factor. It helps you set the call routing rules according to the CLIP, daytime and day in a week. By entering public holidays into the LCR table you achieve even more remarkable cuts.

---

<sup>2</sup> Must be activated by proper licence code (TUN).



---

To make call routing to external ports based on prefixes and the LCR table work properly, enter the GSM provider prefix and the count of prefix-following digits into the GSM destination table.

## 5.4. Routing of Outgoing GSM Calls

If the GSM gateway is connected to your PBX internal line, enable the DISA function to the GSM network to make your GSM gateway answer every call routed to it by the PBX and wait for further dialling to GSM networks.

Routing of outgoing calls via the GSM gateway proceeds as follows:

- The calling subscriber dials a number.
- The GSM gateway waits for further digits to be dialled. This timeout results in a certain delay between the subscriber's dialling and the subsequent dialling by the GSM gateway. Therefore, select the *Default count of digits* for called destinations while configuring your GSM gateway. Then the GSM gateway initiates the outgoing call processing algorithm on receiving the last digit.
- The dialling prefix is first checked with the prefixes included on the first line of the LCR table + prefix list. If no match is found, the following line is used for comparison.
- If the prefix matches a LCR prefix, the call time is checked for match with the routing rule on the line. Again, if no match is found, the following LCR table line is searched.
- In case the prefix and call time comply with the routing rules, the call is routed according to the first routing rule included in *Groups* and *GSM outgoing callss* to the module corresponding to the particular *GSM outgoing calls*.
- If the selected GSM module is busy or has an insufficient credit, the preceding step is repeated for the following line of the *LCR table* section. If there is no record, the next LCR table line is searched.
- In case the selected GSM module is free and has a sufficiently high credit, the GSM gateway starts dialling a GSM number.
- If the calling subscriber number has an unknown prefix, or all routes are busy, the GSM gateway rejects the call request.

- An outgoing call is not billed until the called party answers the call.
- The GSM network signals the off-hook and the GSM gateway transfers this information to the PBX.

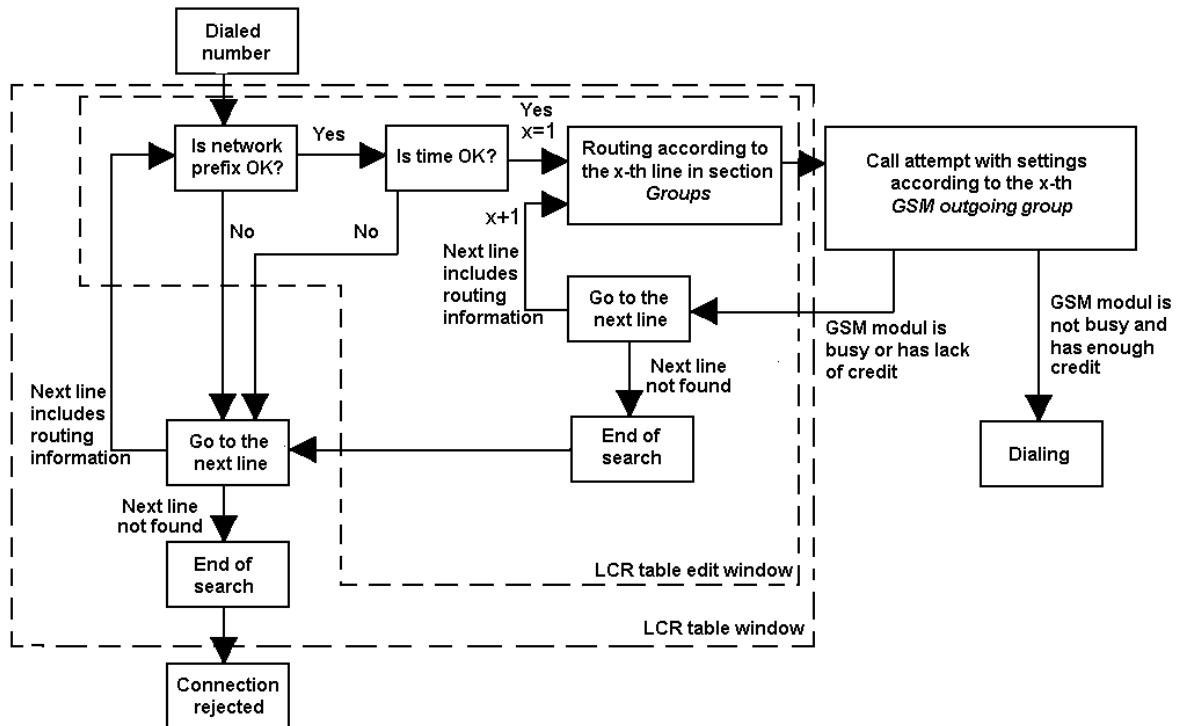

Fig. 18 - Routing of Outgoing Calls to GSM Network

---

## 5.5. Routing of Incoming GSM Calls

Incoming calls from the GSM network are subject to the algorithm described in Fig. 19 and the following steps:

Incoming calls are processed according to the *Mode* parameter in the *GSM incoming calls* chart. The following options are available:

- *Reject incoming calls* – all incoming calls are rejected.
- *Ignore incoming calls* – incoming calls are not routed to extensions. The call request is either rejected or ignored (the calling party hears the ringing tone) on the GSM network side.
- *Report to PC* – the information on an incoming call is sent to a PC equipped with the management software. The calling subscriber gets a voice message or check ringing tone. The management software then completes the call routing procedure.<sup>3</sup>
- *CallBack* – this function helps establish connection on the account of the SIM card inserted in the GSM gateway. The incoming call is either ignored or rejected. After the calling subscriber hangs up, the GSM gateway establishes connection to the defined extension. When the extension answers, the GSM gateway replays the CallBack message to the extension while establishing a connection to the previously calling subscriber in the GSM network. After the CallBack message, the GSM gateway interconnects the call.
- If neither of the above-mentioned options is selected, the AutoCLIP routing table is checked. If the calling number is found, the call is routed to the extension whose number is assigned to the calling number in the table.

---

<sup>3</sup> not available yet.

- In case the calling number is not included in the AutoCLIP routing chart, or the AutoCLIP routing function is disabled, the gateway receives the incoming call and either replays a voice message or transmits the dial tone to the calling party. Then the gateway awaits the count of digits necessary for call establishing. To define the minimum and maximum counts of DTMF digits use the *GSM incoming groups* menu.
- If the gateway does not receive the minimum required count of digits and no other digit comes from the GSM network within the timeout defined in *DTMF dialling delay*, the call is rerouted to the operator as the case is when the extension number dialled by the calling party is unknown.
- If the call rerouting to the operator is inactive, the incoming call is rejected.

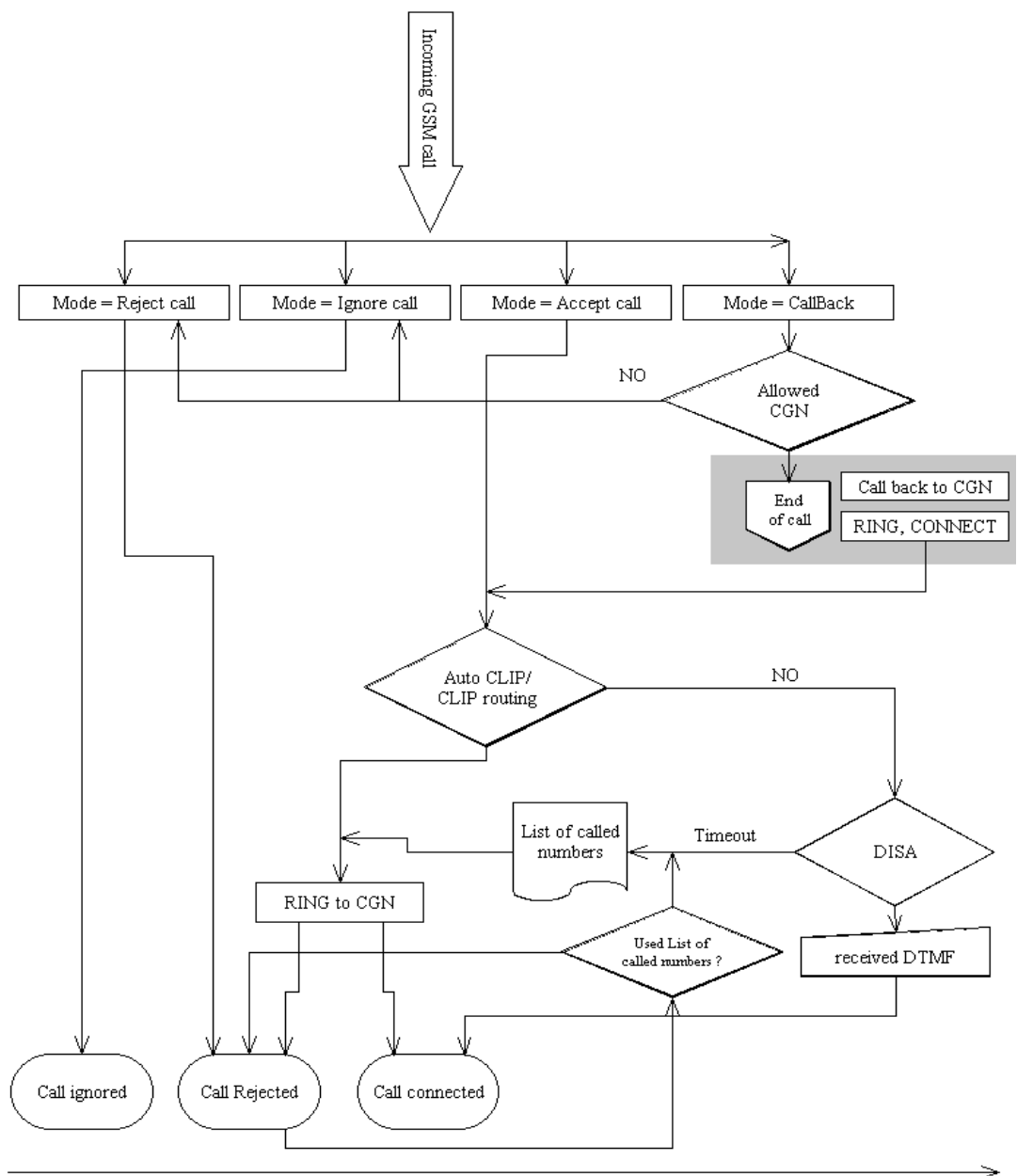

Fig. 19 - Incoming Call Processing Procedure

## 5.6. DISA Message Recording

If the DISA function is enabled and a welcome message recorded, this voice message is replayed to every incoming call whose number is not included in the

AutoCLIP routing table. After the message is replayed, the gateway waits for the first DTMF digit for a timeout defined in the *GSM incoming calls – Timeout while inputting DTMF digits [s]*: table. Having received the count of digits defined in *GSM incoming calls – Minimum digits in DTMF*, the gateway activates the PBX or telephone connection with the number received by the DTMF via the ISDN port. For more details on the gateway configuration refer to Section 7.

To establish connection with a lower count of digits than defined in *GSM incoming calls – Maximum digits in DTMF*, terminate the dialling with the '#' character. When the DISA does not receive the pre-programmed count of digits or the '#' character, the connection is not established. Therefore, enable the operator service while activating the DISA function (in the router mode only, no '#' is needed in the PBX mode).

There are three ways to program the DISA voice message into the gateway:

- Record DISA using configuration program
- Record the voice message from GSM telephone
- Record DISA into your PC and save the *wav* file into your gateway using the XMODEM protocol and defined AT commands.

---

## DISA Message Recording using terminal and GSM phone

Recording of DISA message

Open terminal window (see Subs 4).

- Establish connection with your GSM phone using AT command: *at!sg0=phone\_number\_of\_your\_GSM\_phone*
- Accept incoming call from your GSM gateway by GSM phone. (CLIP of SIM card plugged in SIM card holder 1)
- Enter AT command *at!m=record* in terminal window which results in recording of DISA message (60 s max)
- To stop recording of DISA message press *ENTER*
- Finish the phone call by hanging up or entering of AT command *at!d*

Erasing of DISA Message

To get an information on recorded DISA Message enter AT command *at!m=status*. To erase DISA message enter AT command *at!m=erase* in terminal window.

## Recording of DISA Message using terminal and PC

Recording the voice message into your PC keep the maximum length of 65 s, compression according to the ISDN A-law codec, mono, sampling frequency of 8 kHz. The voice message recording program is part of your GSM gateway software delivery. Summary of parameters the file must meet is in table Tab. 4 below. Name the file *Disa.wav* and upload it to 2N<sup>®</sup> BRI Lite using a terminal and the XMODEM transmission protocol.

DISA Voice File Parameters	
Sound format	Wav
Sampling frequency	8 kHz
Count of channels	1 mono
Codec	ISDN A-law

Tab. 4 DISA Message File Parameters

# 6

## SECTION 6

---

### **Introduction of Configuration Program**

This section introduces the 2N<sup>®</sup> BRI Lite configuration software, which is part of the installation CD supplied together with the gateway.

Here is what you will find in this section:

- 2N<sup>®</sup> BRI Lite Program Installation
- Running of BRI config program



---

When the installation has been completed, run the program by clicking on *BRI config program* in your PC software menu, or clicking on the desktop icon, or opening the *BRI config program.exe* file that you will find in the respective location installed by you using any explorer or file browser.

Note: BRI config program is designed for 2N<sup>®</sup> BRI Lite and BRI Enterprise GSM gateway type. Type of connected gateway is detected automatically – configurations windows are changed according gateway type or by selecting right template.

- Templates
- Configuration Program Basic Menu
- Button Bar
- Topic List and Alphabetical Glossary

## **6.1. 2N<sup>®</sup> BRI Lite Program Installation**

By inserting the installation CD in the CD-ROM drive you initiate installation automatically. If you have not enabled the CD autorun function, initiate installation by opening the *setup.exe* file of the BRI Enterprise software. Follow the installer instructions and wait until the installation has been completed. The guides and autoupdate program are installed together with the 2N<sup>®</sup> BRI Lite software.

## **6.2. Running of BRI config program**

When the installation has been completed, run the program by clicking on *BRI config program* in your PC software menu, or clicking on the desktop icon, or opening the *BRI config program.exe* file that you will find in the respective location installed by you using any explorer or file browser.

Note: BRI config program is designed for 2N<sup>®</sup> BRI Lite and BRI Enterprise GSM gateway type. Type of connected gateway is detected automatically – configurations windows are changed according gateway type or by selecting right template.

### 6.2.1. Templates

In case of not defined configuration file (first start of configuration tool), or by use icon , or by menu “File> Default configurations.

By using template you can load default configuration (basic settings) for your type of gateway and installation site type.

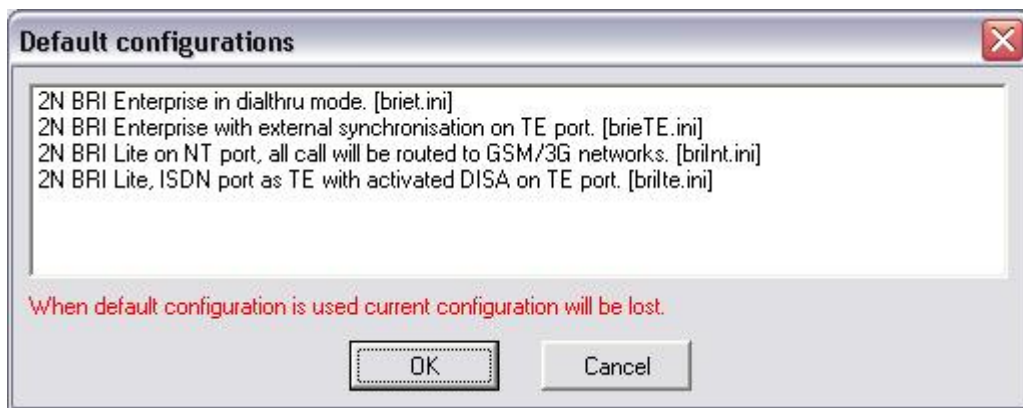

### 6.2.2. Gateway list

For administration of only one gateway is the following procedure not necessary. It is possible to operate with default configuration file, which name is *unnamed.cfg* and is saved in directory with configuration program. **Saving parameters to the configuration file is automatic by switching items in topic or alphabetical glossary tag.**

To facilitate the administration of more than one 2N<sup>®</sup> BRI Litegateway it is possible to use Gateway selection window. This window is located in menu “Gateway – Gateway list” (see sub. 1.3). Selection of this opens window shown at Fig. 20.



Fig. 20 – Gateway list Window

- *Add* - click on *Add* to open a window with some essential data necessary for the gateway identification (see Fig. 21). Enter the gateway name chosen by you into the *Gateway name* item. In case that gateway has activated secure access, it is recommended to complete the *Gateway address*, *Username* and *Password*. Eventually, complete the *File of gateway parameters* including the directory path and filename.

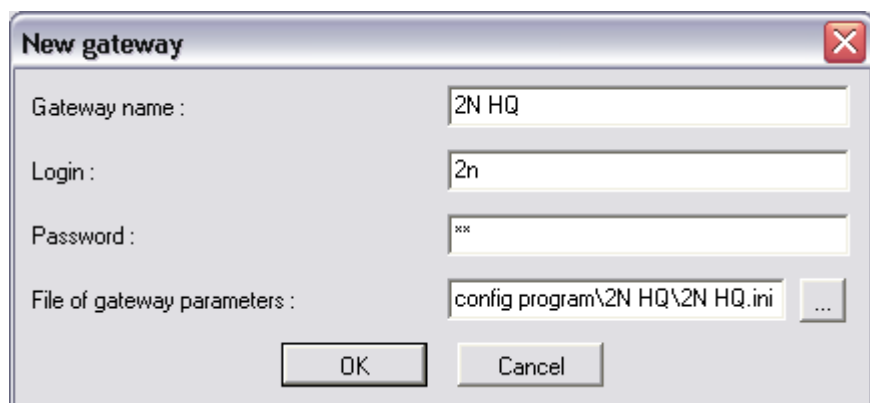

Fig. 21 – Gateway Editing Window

- *Edit* – used for editing identification data on the gateway entered. To edit the data, select the required gateway from the list of used gateways and click on *Edit*.
- *Remove* – used for removing a gateway from the list of gateways.
- *Remove all* – used for removing ALL gateways from the list.
- *Select!* – click on this button to select a GSM gateway and whose parameters can be set after *Close* is pressed.
- *Default* – by clicking on this button you start working with the default parameters.
- *Connect* – used for closing the *Gateway selection* window and opening the gateway configuration window.

### 6.3. Configuration Program Basic Menu

The following items are available in the main configuration program menu:

- *File* – for physical work with the configuration file, default configuration and templates.
- *Gateway* – contains items for connect and disconnect with gateway. Also contains item *Gateway list*.
- *Gateway control* – contains the *Gateway operation monitoring* functions, *Firmware*, *Licence*, and *Date and time* specifications, and functions for *Gateway reset* and uploading of *Factory settings*. All functions located in this sections requests on-line connected gateway!
- *Settings* – menu items for *Gateway selection*, gateway *Communication settings* and *Language* setting of the configuration software.
- *Help* – information on the *About application* of the configuration software together with contacts to the technical support personnel.

---

### 6.3.1.File

This menu is accessible under.

- *Load* – is used for loading of the configuration file of the selected gateway to the configuration program.
- *Save* – is used for saving of the configuration to the configuration file of the selected gateway.



- *Load* – is used for loading an external file to the configuration program. Structure of this file is same as of configuration file which was selected on gateway selection procedure, but the content is different
- *Save as* – is used for saving of configuration to an external file than the one selected on gateway selection procedure.
- *Default settings*- is used for loading default configuration
- *Default configurations* – is used for loading configuration template.
- *Close* - terminates the configuration program work.

### 6.3.2.Gateway

- *Connect* – is used for establishing connection with the gateway
- *Disconnect* – is used for disconnecting from connected gateway.
- *Gateway list* - is an item selecting the gateway to be configured. An introductory window gets displayed after you click on this item (Subs. 1.2).

### 6.3.3. Gateway control

This menu is available under.

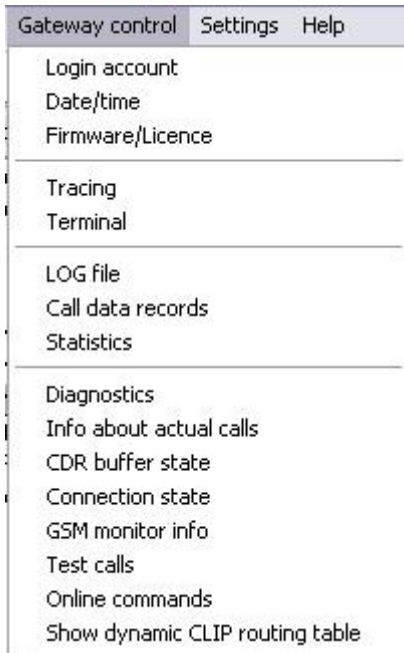
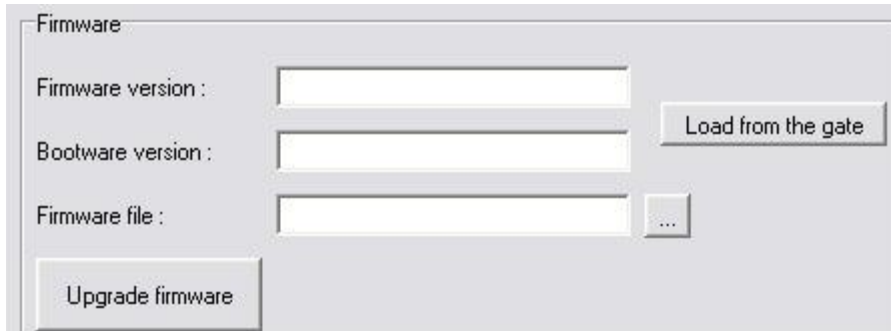



Fig. 22 – Gateway control Item of Main Menu

- *Login account* – item for change access username and password of the gateway.
- *Date / Time* – gateway date and time settings. You can synchronise the time data with your PC.
- *Firmware / Licence* – offers two windows. The *Firmware* window displays and helps upload the latest firmware version. To find the GSM gateway firmware version press the *Load from the gate*, which downloads information of the firmware and bootware versions from the GSM gateway.



To upload firmware:

- Establish communication with the gateway.
- Click on the  button and find the firmware file in your PC directory in the format of P2009-V-\*.hex. Press *Open* to get the file ready for uploading into the 2N- 2N<sup>®</sup> BRI Lite.
- Click on  to start the firmware uploading procedure.
- The program starts uploading the firmware automatically. The gateway is in the reset mode during the process. **Do not interrupt the firmware uploading process** to avoid firmware damage and gateway failure.
- Should the firmware uploading process get interrupted, reset the ISDN GSM gateway and try to upload the firmware again.
- **CAUTION!** Make sure that what you are going to upload is the original and undamaged file with the latest firmware version as available at our websites ([www.2n.cz](http://www.2n.cz)).

The *License* window helps to licence the GSM gateway. To identify the GSM gateway status click on *Load from the gate*. If you require additional license, please contact your sales person.

The screenshot shows two sections of a software interface. The top section, titled 'Information for gateway licence', contains four text input fields: 'Enabled protocols:', 'Gateway limitation:', 'Licence status:', and 'Networks:'. To the right of these fields is a button labeled 'Load from the gate'. The bottom section, titled 'Gateway unlock', contains a text input field labeled 'Licence key for gateway:' and a button labeled 'Set gateway licence'.

Enter the received licence into *Enter license* and press *Enter license!* button. Click on *Load from the gate!* to know whether the license has been accepted successfully.

**CAUTION!** By inserting an invalid license you may disable the GSM gateway functionality.

- *Tracing* – for analysis of the GSM gateway behaviour on each RM OSI model layer. Time stamps may be assigned to the records for better orientation in listings.

The screenshot shows the 'Tracing' window. It has a title bar 'Tracing'. Below the title bar are two main sections. The left section, 'Set details of tracing', contains five checkboxes: 'State of layers 3 and 5' (unchecked), 'Timestamp for each message' (checked), 'SMS Bus packets (CPU <-> AUX)' (unchecked), 'State of layer 2' (unchecked), and 'LCR routing and Sim select' (checked). The right section, 'Select tracing type', contains a dropdown menu 'Select tracing:' with 'GSM/ISDN Messages' selected, and three radio buttons: 'Layers 2, 3, 4' (selected), 'Layers 3, 4' (unchecked), and 'Layer 4' (unchecked). Below these sections is a large empty text area with scrollbars. At the bottom of the window are several buttons: 'Start', 'Default', 'Clear', a file path 'RI Lite\program\2N HQ\Tracing.txt', an ellipsis button, and a checked 'Save to file' checkbox.

Fig. 23 – Tracing Window



- *Terminal* – the terminal window helps configuring the gateway using AT commands.
- *Log file* – downloads all log records from connected gateway.
- *Call data records* – information on accomplished calls for telephone bill control and telephone cost logging per party if necessary.
- *Statistics* – helps download statistic data concerning the count of called minutes, incoming and outgoing calls, sent SMS, etc. from the GSM gateway to the PC including saving into a file.
- *Diagnostics* – shows information on GSM modules and plugged-in SIM cards.

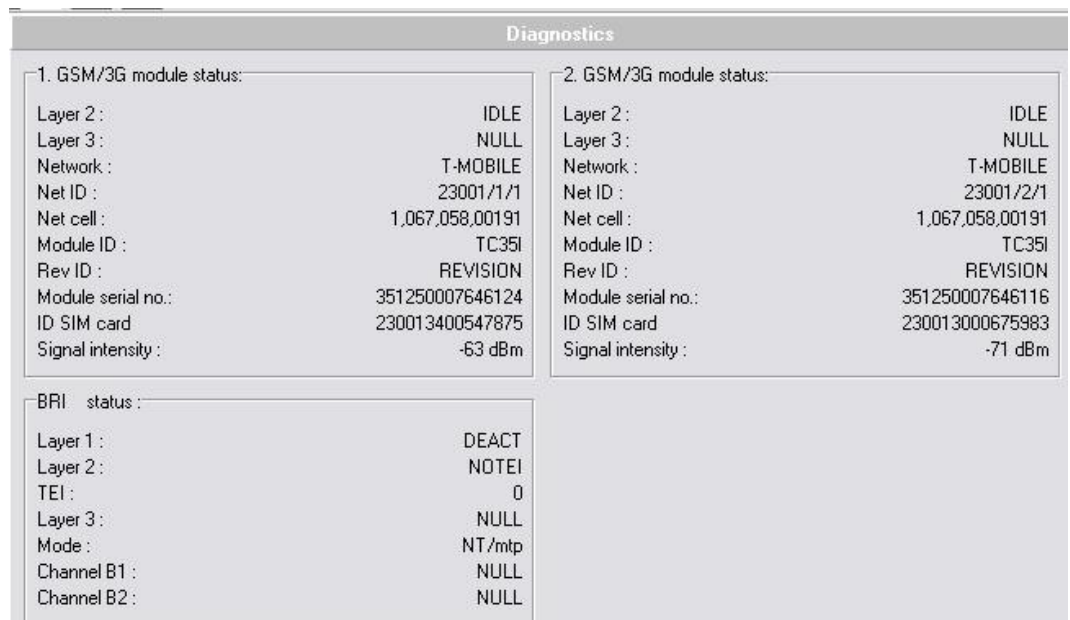

Fig. 24 – Modules diagnostics window

- *Info about actual calls* – information on currently made calls.
- *CDR buffer state* – informations about gateway's CPU and memory loads. Actual status of CDR memory is named: *Count of call data records: number\_of\_saved\_CDR of capacity*.
- *Connection state* – informations about gateway's configuration interfaces.

- *GSM monitor info* – downloads actual GSM network informations from selected GSM module (supported only TC35i module).

Description of response parameters from TC35i module:.

<b>Chann</b>	ARFCN (Absolute Frequency Channel Number) of the BCCH(THC) carrier. If chann is h BTS supports hopping during a connection
<b>Rs</b>	RSSI (Received signal strength) of the BCCH carrier from 0 to 63. The indicated value is composed of the measured value in dBm plus an offset. This is in accordance with a formula specified in 3GPP TS05.08
<b>dBm</b>	Receiving level of the BCCH carrier in dBm
<b>PLMN</b>	PLMN ID code
<b>LAC</b>	Location area code (HEX)
<b>Cell</b>	Cell ID code (HEX)
<b>NCC</b>	PLMN color mode
<b>BCC</b>	Base station color mode
<b>PWR</b>	Maximal power level used on RACH channel in dBm or current power level
<b>RXLv</b>	Minimal receiving level (in dBm) to allow registration
<b>C1</b>	Coeficient for base station selection
<b>TS</b>	Timeslot number
<b>timAdv</b>	Timing advance in bits
<b>Q</b>	Receiving quality (0-7)
<b>Chmod</b>	Channel mode (S_HR: Half rate, S_FR: full rate, S_EFR: Enhanced full rate)

- 
- *Test calls* – for make test calls (for check voice qualitz or right configuration). Test calls can be outgoing to GSM or ISDN interface, or incoming). In case of proceeding call the gateway automativally generates trace, which you can save for possible check in case of problems.
  - *Online commands* – for sending AT command directly to selected GSM module
  - *Show dynamic CLIP routing table* – downloads actual records of Dynamic CLIP routing function.
  - *Load parameters fro gateway* – downloads configuration of the gateway from the gateway to the configuration program.
  - *Save parameters to the gateway* – uploads configuration parameters form the program to the gateway.
  - *Gateway reset* – resets the gateway.
  - *Factory parameters reset* – restarts the gateway with company settings.

### 6.3.4. Setting

This menu is available under



- *Communication setting* - helps set the type of communication of the 2N<sup>®</sup> BRI Liteconfiguration software. By clicking on this item you open a configuration window (see Fig. 25). You can use a USB cable, or remote GSM (CSD) for communication with the GSM gateway.



Fig. 25 – Communication Setting Window

Types of communication:

*Serial communication* - used for GSM gateway configuration from your PC using a USB cable communicating via a virtual COM port at the rate of 921,600 bps, which is selected in the *Serial communication setting* item. The serial communication mode is suitable for the initial setup of the gateway. The configuration program offers available COM ports.

*GSM (CSD)* – used for GSM gateway configuration via GSM (CSD) modem. Be sure to set the correct gateway dialled number and activates licence before configuring.

LOG communication:

You can set whether and how the PC - GSM gateway communication should be saved into a file.

Having selected the type of communication, you select the transmission rate by clicking on *Find out speed*. Having found the transmission rate value, you establish connection between the PC and GSM gateway by pressing *Connect*. The *Disconnect* key cancels this connection. To confirm changes press *OK*.

- *Application language* - sets the language used for tag names.

### 6.3.5.Help

This menu is available under (Alt + h).

- *About* - opens a window providing information on the configuration software version together with contacts to the technical support personnel.

## 6.4. Button Bar

The button bar (

Fig. 26) displays the most frequently used commands that make the work with the GSM gateway easier and quicker.

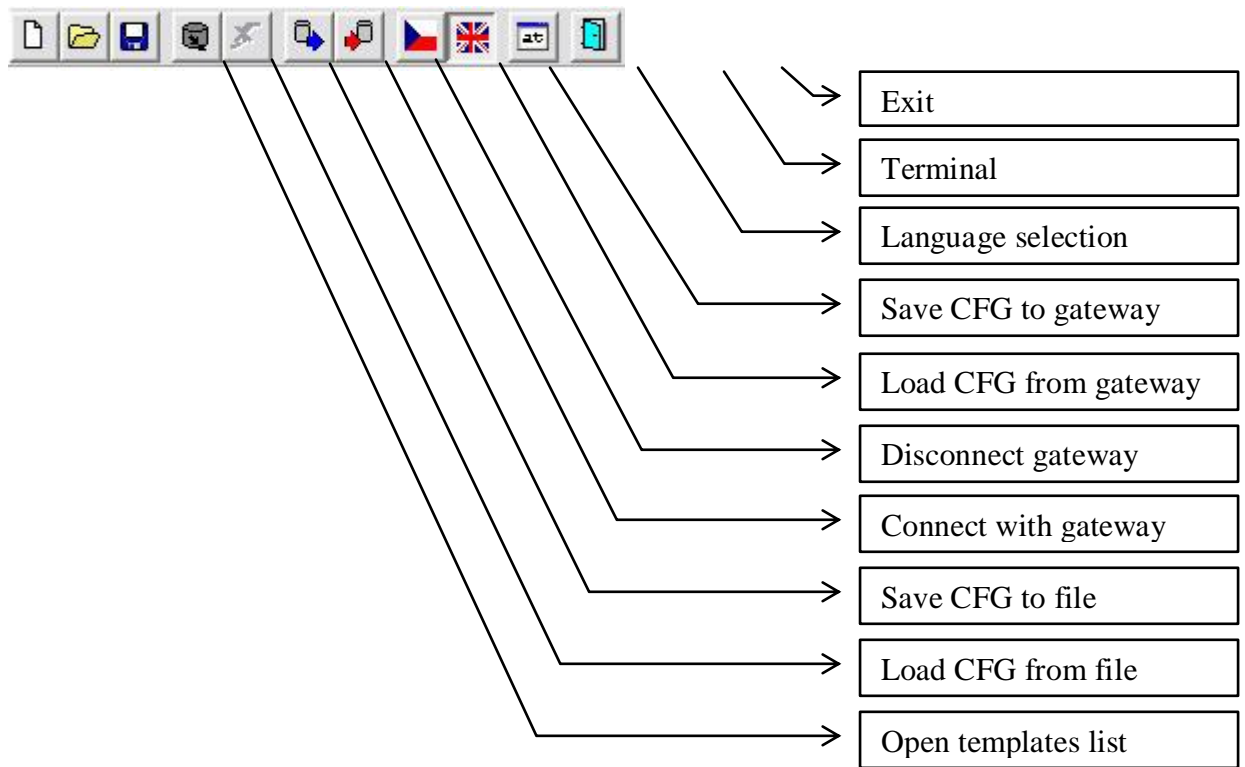

Fig. 26 – BRI config program Button Bar

## 6.5. Topic List and Alphabetical Glossary

Select the more convenient of the two arrangements of configuration program items (

Fig. 27). The topic menu is divided to two sections:

Gateway control: There are located items which are available only when gateway is connected:



The sections below are arranged according to the *Topic list*.

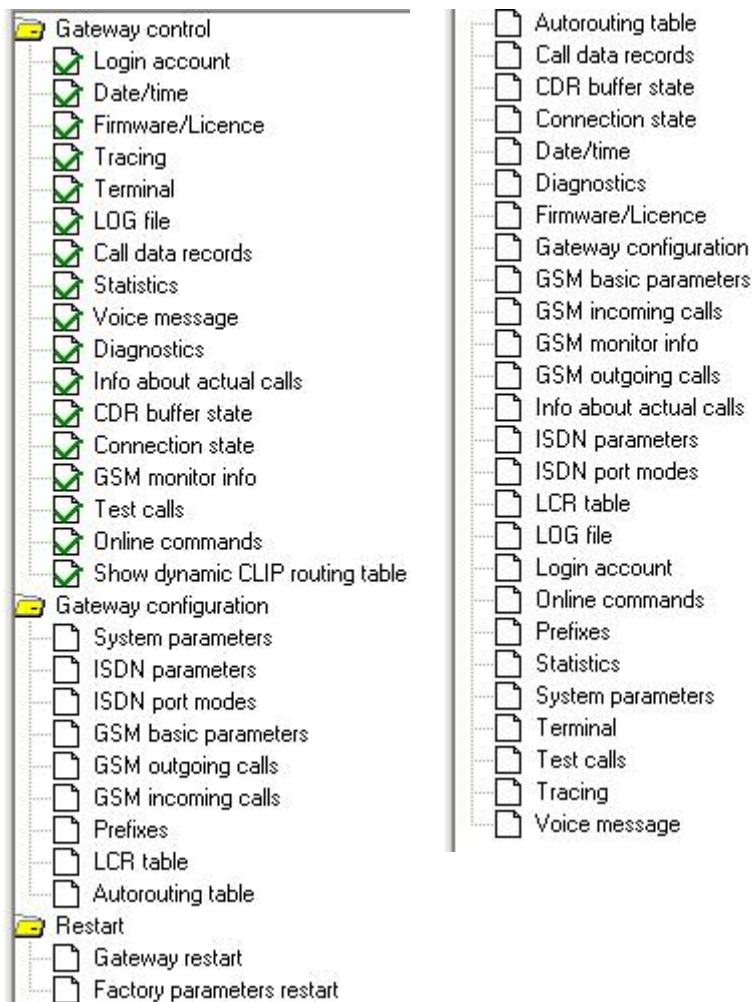

---

Fig. 27 – Topic List (left) and Alphabetical Glossary (right)

7

## SECTION 2

---

# Configuration

This section describes the 2N<sup>®</sup> BRI Lite setting using the GSM configuration software that is part of the installation CD supplied together with the gateway.

This section includes:

- 2N<sup>®</sup> BRI Lite Gateway Communication Establishing
- Firmware Version Identification
- Gateway License
- Load / Save Parameters
- System Parameters

- ISDN Parameters
- ISDN port modes

## 7.1. ISDN port modes

Major route settings for GSM and ISDN BRI ports.

- GSM parameters - General
-



---

GSM outgoing calls

- GSM incoming calls
- Prefixes
- LCR table
- Autorouting Table

## 7.2. 2N<sup>®</sup> BRI Lite Gateway Communication Establishing

Select the gateway to be configured from the list of gateways available in the *Main menu*, in the *Gateway list* tag.

Now select the type of GSM gateway connection in *Setting – Communication settings* (refer to Subs.1.3.4) in the *Main menu*.

Having selected the communication type click on *Connect gateway* to establish connection between the PC and GSM gateway.

With the GSM gateway communication type selected, connect the GSM gateway by clicking on *Connect gateway*  in the *Button bar*.

## 7.3. Firmware Version Identification

If you have connected the GSM gateway for the first time, please identify the current firmware version in the *Functions – Other functions – Firmware/License* menu and compare it with the one available on our websites ([www.2n.cz](http://www.2n.cz)), or on attached CD.

If your GSM gateway firmware version is older than that distributed by us, upload the latest firmware version to your GSM gateway. Please follow the instructions included in *Gateway control* in Subs.1.3.3. Please do not hesitate to contact out technical support personnel in the case of troubles.

Since the product is subject to innovations please check the latest firmware version on our websites regularly.

## 7.4. Gateway License

The operation of every new 2N<sup>®</sup> BRI Litecan be limited to 850 hours\*. Every gateway reset reduces the remaining gateway operation time by one hour. To identify the GSM gateway status use the *Functions – Firmware/License* menu, for the gateway unlocking procedure refer to *Functions* in Subs.1.3.3.

If you require additional license, please contact your sales person.

\*depends on gateway's order number

## 7.5. Load / Save Parameters

Use task bar or configuration program basic menu To download configuration file from the gateway. Upload of the configuration parameters to the gateway is possible by similar way.



The *Load from gate* item (“*Functions – Load parameters from gateway*”) helps download all configurable items from the gateway and save them into the file designated during the gateway selection (refer to Subs. 1.2).



The *Save to gate* button (“*Functions – Save parameters to gateway*”) helps upload all configurable items from the selected configuration file (refer to Subs. 1.2) to the gateway.



*Load from file* (“*File – Load*”) is used for loading an external file to the configuration program. Structure of this file is same as of configuration file, which was selected on gateway selection procedure, but he content is different



*Save to file* (“*File – Save*”) is used for saving of configuration to a file designated during the gateway selection procedure.

## 7.6. System Parameters

The screenshot shows a window titled "System parameters". Inside, there are several controls: a "Modes:" label above a dropdown menu set to "Successful outgoing"; a "Saving call data (CDR):" label above another dropdown menu also set to "Successful outgoing"; a "Gate ID:" label above a numeric input field containing "0" and the text "(0 = off)"; an "Enable system restart" checkbox which is currently unchecked; and a "Time of system restart [hh:mm]:" label above a time input field showing "00:00". At the bottom of the window, there are four buttons: "Save to the gate", "Load from the gate", "Default", and "Save to file".

Fig. 28 – System Parameter Editing Window

The *System parameters* card reveals settings for *CDR* (Call Detail Records), and unit ID.

- 
- *CDR mode* – defines calls on which records should be made. Data may be recorded on incoming, outgoing, successful or unsuccessful calls, or the CDR mode can be disabled.
  - *Unit ID* – used for designation of the selected GSM gateway in case there are more devices in the network that generate the CDR.
  - *System restarts* – Enables automatic restarts of the GSM gateway. For example: to prevent change PBX's primary synchronisation from PSTN to the GSM gateway (in cases of PSTN 2N<sup>®</sup> BRI Lite restarts)

## 7.7. ISDN Parameters

**ISDN parameters**

**ISDN BRI port settings**

Interface :

Mode :

TEI management :

MSN number :

DISA dial tone

**Tone signalling for calls to ISDN :**

Dial tone :

Ring tone :

**Generating busy tone**

To BRI for  seconds

**Progress elements numbers :**

Message SETUP\_ACKNOWLEDGE :  (0 = off)

Message SETUP\_PROGRESS :  (0 = off)

Message SETUP\_PROCEEDING :  (0 = off)

Message SETUP\_ALERTING :  (0 = off)

**Release causes to ISDN:**

Lack of digits in OVERLAP mode:

Restricted number prefix :

Selected module/GSM group is not ready :

No module/GSM group is ready :  ?

Receive dial number from Subaddress

Don't send Connect-ACK message in TE mode

Day of deleting statistics ISDN:

**Numbering plan settings :**

Called party number :

Calling party number :  ?

Save to the gate    Load from the gate    Default    Save to file

Fig. 29 – ISDN Parameter Editing Window

The *ISDN parameters* card is used for setting all ISDN port parameters. To set the gateway default values click on *Default*. Individual items are explained below according to their respective groups in the editing window.

---

### 7.7.1. ISDN BRI port settings

- *Interface* – adjusts the BRI interface of the gateway. This port operates as a network termination with respect to the other ISDN terminals on the given port. In addition to monitoring and diagnostic functions, the GSM gateway provides access to the D-channel and power supply to the other ISDN terminals connected in this mode.
- Port setting
  - *Interface* – NT (simulate PSTN NT) or TE (connection like ISDN terminal)
  - *Point-to-point* – when the gateway is connected to one device only (i.e. TE port of your PBX). It is possible to choose fixed TEI (Terminal Endpoint Identifier) assignment from range 0 to 63 (0 is mostly used for the point-to-point configuration) or dynamic TEI assignment TEI = 64 in case of point-to-point configuration. For dynamic TEI assignment TEI is assigned from range 64 to 126. TEI = 127 is used for broadcast messages.
  - *Point-to-multipoint* – if the gateway is connected to more terminals the dynamic TEI assignment must be selected.
  - *DISA dial tone* – Activated DISA DTMF dial tone for second dial (used for connection on PBX extension line)

### 7.7.2. Tone signalling for calls to ISDN

- *Dial tone* – with this function enabled, the GSM gateway sends the dialtone to the NT port if the SETUP message does not include the calling subscriber's number..
- *Ring tone* – selection of control ring tones which are to be played to the caller from the ISDN network

### 7.7.3. Generating busy tone

- *To BRI for X sec* – in case of activation this parameters, busy tone will be played for X seconds after call to GSM termination.

### 7.7.4. Progress elements

The purpose of progress elements is to describe the behaviour of terminals involved in a connection. You can set here which progress elements should be sent in the *SETUP\_ACKNOWLEDGE*, *CALL\_PROCEEDING*, *PROGRESS* and *ALERTING* messages. Please keep the configuration settings of your PBX or router to avoid false evaluation of the messages transmitted by your GSM gateway and thus connection establishing errors.

Number	Meaning
1	The connection is not of the end-to-end ISDN type, further progress messages will be sent in the voice band
2	The destination address is not of the ISDN type
3	The connection initiator address is not of the ISDN type
4	The connection returns to the ISDN
8	The communication of the interconnected systems led to a change of the telecommunication service (for the end-to-end ISDN mode only)
10	Delay due to call interface failure

Tab. 5 –ISDN Cause Meanings

### 7.7.5. Release causes to ISDN

Cause messages are sent to those terminals whose connection request has been rejected. They contain causes of rejection. For precise definitions of the messages refer to the ITU-T Q.931 recommendation. You can set the type of the message to be sent for any of the following events:

- *Lack of digits on OVERLAP mode* – the incoming call was rejected because the number of digits of the calling party's dialling was too low for successful connection (default = 102 – Recovery on Timer Expiry).
- *Restricted number prefix* – call rejection due to an unknown prefix. The prefix does not match any item in the routing tables (default = 21 – Call Rejected).
- *Selected module / GSM group is not ready* – call rejection due to the busy status of all modules that have been selected for routing calls to the particular destination (the module assigned to the B-channel group is not available) and no other GSM modules have been selected for the destination (default = 41 – Temporary Failure).

- 
- *No module / GSM group is ready* – call rejection due to the busy status of all modules that have been selected for routing calls to the particular destination and alternative GSM modules that have been selected routing calls to the particular destination in case of congestion (default = 42 – Switching Equipment Congestion).

*Complete list of available release cause you find under button “?”.*

### **7.7.6. Numbering plan settings**

These parameters are for set „numbering plan“ values for Called party (CDN) and calling party number (CGN).

### **7.7.7. Don't send „Connect ACK“ to BRI2 – TE**

Removal of the TE progress from confirmation message in ISDN communication. It is necessary to use this parameter with some of Alcatel PBXes (e.g. Alcatel 4400).

### **7.7.8. Receive dial also from “Subaddress” element**

Some ISDN terminal are sending letters “#” and “\*” as Keypad facility dial mode. With activate this parameter gateway will convert this dial to Called party number.

## 7.8. ISDN port modes

The screenshot shows a configuration window titled "ISDN port modes". It is divided into two main sections:

- ISDN BRI port:** This section contains two radio button options:
  - Reject all incoming calls
  - Use LCR table, then reject a callTo the right of these options is a text box that reads: "Incoming calls will be routed to GSM or opposite ISDN BRI port according to LCR table. If there will no be valid line, call will be rejected."
- GSM channels 1 and 2:** This section also contains two radio button options:
  - Reject all incoming calls
  - Route incoming calls to ISDN BRI interfaceTo the right is a text box that reads: "Incoming calls will be processed according to GSM incoming calls settings and routed to ISDN 2 interface if you set so."

At the bottom of the window, there are four buttons: "Save to the gate", "Load from the gate", "Default", and "Save to file".

Major route settings for GSM and ISDN BRI ports.



## 7.9. GSM parameters - General

**GSM basic parameters**

---

Number of digits dialed from ISDN

Min. numbers from ISDN :

Max. numbers from ISDN :

Wait for next digit [s] :

SIM cards PIN code number (>=4 numbers) :

---

Voice parameters of Wavecom modules :

Echo cancelling :

Transmission volume :

-6 -4 -2 0 +2 +4 +6

Reception volume :

-6 -4 -2 0 +2 +4 +6

Voice parameters of Siemens GSM modules :

Transmission volume :

-5 -2.5 0 +2.5 +5

Reception volume :

-5 -2.5 0 +2.5 +5

Enable Siemens's connection tone

---

Settings of Sierra Wireless modules:

Transmission volume :

-5 -2.5 0 +2.5 +5

Reception volume :

-5 -2.5 0 +2.5 +5

Type of used networks :

Searching priority :

Send AoC for calls BRI->GSM

Relax delay [s] :

DTMF Delay [1/100s] :

SIM card number :

Don't send CLIP for incoming calls GSM -> BRI

Received SMS will be saved to :

---

Signalling tone for calls to GSM :

Dial tone :

Ring tone :

Transfer to cause

---

Generate busy tone to GSM [s] :  (0 = off)

Fig. 30 – Basic GSM Parameter Editing Window

This section contains basic settings for routing calls to the external GSM ports of the gateway. The *Default* button sets the default values. The “Advanced” button offers possibility of advanced GSM general parameters configuration.

### 7.9.1. Number of figits dialed from ISDN

- *Min. numbers from ISDN* – minimal count of digits recieved on ISDN inteface needed for establishing of the call to the GSM network. If the count of digits is lower than the value in this field the connection to the GSM network will not proceed.
- *Max. numbers from ISDN* – maximal count of digits received on ISDN interface that will be accepted for establishing of the connection to the GSM network. If the count of digits is higher than the value in this field the connection to the GSM network will continue using first n digits, where n is the value in this field.
- *Wait for next digit [s]* – a timeout during which the GSM gateway waits for another digit of the subscriber dialling. After this timeout, if the count of received digits is sufficient, the gateway tries to make connection.

### 7.9.2. SIM cards PIN code number

- *SIM cards PIN number* – enter the PIN code to be entered automatically for new SIM cards. The PIN codes of all inserted SIM cards must be same.

### 7.9.3. GSM Module selection

There is possible to set the way of GSM modules to B-channels assignments for outgoing calls in this section. Use the menu to choose one of the following possibilities:

- *Cyclic* – GSM modules alternate after each call
- *Locked* – outgoing calls on B1 channel are routed through GSM1 module and outgoing calls on B2 channel are routed through GSM2 module.
- *Smart* – calls are routed through the module that has less called minutes in statistics.

---

#### 7.9.4. Signalling tones for calls to GSM

- *Dialtone to NT interface on empty SETUP* – this menu sets the type of dialling tone generated to the NT interface by GSM gateway on receiving SETUP message without called party number field
- *Ring tone* - in this menu is possible to select the type of ringing tone generated by the GSM gateway when calling to the GSM network

#### 7.9.5. Relax delay

Time delay between two calls to the GSM network. Establishing of new call to GSM network thru the same GSM module is possible after expiry of this timeout. The GSM module clears the call to GSM network during this time. The optimum value is about 2 s.

#### 7.9.6. DTMF Delay

*Delay [1/100 s]* – sensitivity of DTMF receiver from GSM network. Parameter “delay” means 10\*milliseconds which is added to default value 20ms. The total time is minimal delay between two DTMF chars. Example: DTMF number=30 delay=30\*10+20=320.

#### 7.9.7. SIM card number

In this section is possible to define which SIM card number should be used in the GSM gateway:

- *IMSI* – International Mobile Subscriber Identity
- *SCID* – SIM Card Identification Number<sup>\*\*</sup>

#### 7.9.8. Don't send CLIP

By enabling this function you deactivate transfer of calling party number (CLIP) from GSM to ISDN. In case, that this parameter will be switched off, CLIP from GSM will be forwarded to ISDN.

---

<sup>\*\*</sup> supported by Siemens GSM modules only

### 7.9.9. Modules settings

This section is dedicated for adjusting of GSM/3G modules only:

- |-> for audio signal from GSM/3G network amplification
- ->| for audio signal to GSM/3G network amplification
- *Allow Siemens tone* – this function allows to send tones generated by Siemens GSM module while establishing connection to GSM network
- *Use networks* – Select type of network which will be used after start of GSM/3G module.
- *Searching priority* – Select type of network which will module looking for after start.

## 7.10. GSM outgoing calls

GSM outgoing calls

GSM module 1
GSM module 2

GSM call statistics :

Max. number of called minutes : (0 = off)

'Minute' parameter :

SMS messages number :

Day of deleting stats :   
(0=off,32=every day)

SMS at no answer

Default delay before send SMS [s] (0 = off)

Text for "SMS at no answer" :  
  
(%N in the message will be replaced by calling party number)

GSM calls statistics settings :

Number of seconds after connect :

Nr. of seconds for next counting (0 = off)

Roaming enabled for network code

CLIR function :

Disconnect call :

AOC settings :

Pseudo tariff : (0 = off)

Messages to ISDN interface (outgoing calls to GSM) :

Delay before send CONNECT [s] :

Don't send ALERTING message

Send ALERTING message after dial from GSM

Delay before send ALERTING [s] :

Send CLIP from ISDN to GSM :

Attention! Must be supported by your GSM / 3G operator. In other case outgoing calls to GSM / 3G can be rejected!

Transfer CLIP to GSM    Separating char :

Time limitation of SIM card

From :  To :

Enable on weekends

Use whole weekend

Use the above set time

Use 2nd interval

From :  To :

Fig. 31 - Editing Window of GSM outgoing parameters

The 2N<sup>®</sup> BRI Liteallows you to setup both GSM modules for call to the GSM network independently. You can select different settings for each of them with respect to establishing connections, count of called minutes and sent messages

within a period. To set the default parameters use *Default*. For advanced settings use *Advanced* button. The meanings of the card items are as follows:

- *Same setting as GSM module 1*- this checkbox sets the same parameters for GSM module 2 as on the GSM module 1 fold

### 7.10.1. GSM calls statistics

- *Max. number of called minutes* – defines the maximum number of minutes called within a month through the given SIM card. This parameter is ignored if 0 is selected.
- *“Minute” parameter*- is used for setting up whether statistics are counted in minutes or in number of calls.
- *SMS messages number* – defines the maximum possible number of SMS messages sent within a month from the given SIM card. This parameter is ignored if 0 is selected.
- *Day of deleting stats.* – sets the day in a month on which the statistic data on *Max. number of called minutes* and *SMS messages number* are deleted. This parameter is ignored if 0 is selected. By setting this parameter to value „32“ enables daily deleting of statistics after midnight.

### 7.10.2. SMS at no answer

- *Default delay before send SMS [s]:* - time interval of timeout for sending SMS when the called party in GSM network doesn't answer the call. Value “0” disables SMS at no answer function. The timeout starts after receiving of ALERTING message.
- *Text for SMS at no answer* – enter text that will be send when the called party in GSM network doesn't answer the call. The string “%N” is replaced by the CLIP of SIM card.

### 7.10.3. GSM calls statistics settings

- *Number of seconds after connect* – the length of the first pulse after which pulses are counted according to the value included in the *Number of seconds for next counting* parameter.

- 
- *Nr. of seconds for next counting* – the number of seconds per pulse after the timeout defined in the *Number of seconds after connect* parameter.

Example:

If, from the viewpoint of the GSM provider, a call shorter than 60s is billed as a 60s call, set the *Number of seconds after connect* at 60s. If the GSM provider bills calls in seconds after the first 60s, set the *Number of seconds for next counting* at 1 s.

#### 7.10.4. Roaming

- *Roaming enabled for network* – an international identification code of the network for which roaming is enabled. It consists of two numbers:
  - MCC – Mobile Country Code – Czech Republic - 230)
  - MNC – Mobile Network Code – T-Mobile 01, Telefónica 02, Oskar 03

Thus, the T-Mobile International Identification Code is 23001.

To disable roaming leave this field blank.

Example:

- <empty> ...roaming restricted
- 2300 ...roaming restricted (minimum is five digits)
- 23002 ...roaming enabled only to network code 23002
- 230Xx ...roaming enabled to network codes from 23000 to 23099
- xX001...roaming enabled with codes which has last three digits = 001
- xXXxX...roaming enabled to ANY GSM/3G network code

### 7.10.5. CLIR function

- *CLIR* – This parameter defines whether or not the calling SIM card telephone number shall be displayed to the called party. It is not recommended to present the telephone number of the SIM card inserted in the GSM module to the called party to avoid problems with calling back. It is impossible for technical reasons to transmit telephone numbers of ISDN terminals to a GSM network. One of the following parameters can be set for each GSM group:
  - *Default* – default settings of the GSM provider.
  - *Disable (CLIP on)* – the SIM card telephone number is transmitted to the GSM network. Contact your GSM provider for activation of this service if it is not supported automatically.
  - *Enable (CLIP off)* – the SIM card telephone number is not transmitted to the GSM network.  
**CAUTION!** Some GSM providers do not support this function, which might lead to rejection of an outgoing call.

### 7.10.6. Disconnect call

- *Disconnect call* – the currently made call is disconnected in cases included in the pull-down menu.

### 7.10.7. Statistics

- *Day of deleting stats in group* – defines the day on which statistic data on disconnected calls are deleted.

### 7.10.8. Messages to ISDN

- *Delay before send CONNECT [s]* – a delay before sending information on a connected call after reception from the GSM network.
- *Delay for ALERTING [s]* – timeout for generating of ALERTING message by the GSM gateway in case the gateway does not receive ALERTING message from GSM network



### 7.10.9. Send CLIP from ISDN to GSM

Feature for forwarding CLIP from ISDN to GSM network. This feature MUST be supported by your GSM provider! In otherwise there can be reject of outgoing calls to GSM network!

### 7.10.10. Time limitation of SIM card

Interval of using SIM card.

## 7.11. GSM incoming calls

The screenshot shows a software interface for editing GSM settings. At the top, there are two tabs labeled 'GSM module 1' and 'GSM module 2'. The main area is divided into several sections. On the left, there is a 'Mode' section with a dropdown menu currently set to 'Reject incoming calls'. Below this is the 'DISA DTMF settings' section, which includes three spinners: 'Minimum digits in DTMF' (set to 3), 'Maximum digits in DTMF' (set to 3), and 'Timeout while inputing DTMF digits [s]' (set to 10). Further down is the 'Dynamic CLIP routing settings' section, featuring a spinner for 'Time to keep CLIP in table [hours]' (set to 0) and two checkboxes: 'Add new record only for unconnected call' and 'Delete record for connected answer'. At the bottom left is a spinner for 'Looping of voice mess [min] (0=1x)' (set to 0). On the right side, there is a 'List of called numbers' section with a large empty text area and three buttons: 'Add', 'Remove', and 'Remove all'. Below this is a spinner for 'Day of deleting stats' (set to 1). Further down is a field for 'CDN recognition in CLIP (Separating char)'. Below that is a field for 'CLIP (replace "+" by expression)' containing a '+' sign. At the bottom right is a field for 'Prefix before DISA preselection'.

Fig. 32 - Incoming GSM Group Editing Window

The 2N<sup>®</sup> BRI Lite allows you to setup both GSM modules for call from the GSM network independently. You can select different settings for each of them with respect to establishing incoming calls. To set the default parameters use *Default*. For advanced settings use *Advanced* button. The meanings of the card items are as follows:

- *Same setting as GSM module 1*- this checkbox sets the same parameters for GSM module 2 as on the GSM module 1 fold

### 7.11.1. Mode

Set the way the GSM gateway shall process incoming calls from the GSM network.

- *Reject incoming calls* – all incoming calls from the GSM network are rejected automatically.
- *Ignore incoming calls* – all incoming calls from the GSM network are ignored automatically. The calling subscriber hears the ringing tone.
- *Receive incoming calls + voice message* – incoming calls from the GSM network are received and, if defined so, the DTMF with a voice message is enabled for the incoming call.
- *Receive incoming calls + dialtone* – incoming GSM calls are received incoming calls from the GSM network are received and, if defined so, the DTMF with a simulated dialtone is enabled for the incoming call.
- *CallBack after ring / Reject* – in case the CLIP is included in the CallBack table, a CallBack is made. The GSM gateway rejects the incoming call and makes an automatic CallBack.
- *CallBack after ring / Ignore* – in case the CLIP is included in the CallBack chart, a CallBack is made. The incoming call is ignored. If the calling subscriber does not hang up within the defined timeout (default = 10s), the CallBack function is ignored and the call is processed normally (refer to Subs. 4.5).
- *Report to PC + voice message* – ~~the GSM gateway sends information on an incoming call to the PC equipped with the call routing software. The DTMF with a voice message may be enabled for the incoming call.~~

- 
- ~~Report to PC + dialtone —the GSM gateway sends information on an incoming call to the PC equipped with the call routing software. The DTMF with a simulated dialtone may be enabled for the incoming call.~~

### 7.11.2. DISA DTMF digits

- *Minimum digits in DTMF* - the minimum number of digits required by the gateway in the DTMF.
- *Maximum digits in DTMF* - the maximum number of digits accepted by the gateway in the DTMF.
- *Timeout while inputing DTMF digitst [s]* – a timeout during which the GSM gateway waits for the first / another DTMF digit. If 0 is selected, the incoming call is connected automatically to the numbers included in the *List of called numbers*.

### 7.11.3. CLIP

- *Replace “+” by expression* - the '+' character from the CLIP is replaced with a sequence of digits included in this field.

Example:

Calling party identification (CLIP) is +420602123456

- a) “Replace „+“ by expression“: {empty}  
CLIP sent to the PBX is: 420602123456
- b) “Replace „+“ by expression“: +  
CLIP sent to the PBX is: +420602123456
- c) “Replace „+“ by expression“: 00  
CLIP sent to the PBX is: 00420602123456

### 7.11.4. List of called numbers

The list of called numbers, which will be called to ISDN network in case that an incoming call from GSM network will not contain correct called party number or the timeout *Wait for next digit [s]* expires. Numbers are dialed down from top.

### 7.11.5. Dynamic CLIP routing settings

- *Record validity [h]:* - for time validity of record in dynamic CLIP routing table. Value “0” disables this function. Dynamic CLIP routing allows to route calls from GSM network directly to the extension, which was the last time connected with the GSM network user.
- *Create record for unconnected calls only* – sets saving of unconnected calls to the dynamic CLIP routing table. The record will be added in case the call was is not connected only
- *Erase record after using* – setting of this parameter enables deleting of the record from the dynamic CLIP routing table after the call connection.

### 7.11.6. Day of deleting statistics

Defines a day in a month on which statistical data on incoming calls are deleted. By setting this parameter at 0 you disable this function.

### 7.11.7. Prefix before DISA

- *Prefix before DISA* – a digital prefix to precede the DTMF automatically.

### 7.11.8. Looping of voice message

- *Voice message loop [min]:* - DISA for incoming calls is repeated for time interval filled in this field in minutes. Value “0” for playback DISA record only once.

### 7.11.9. Recognition CDN in CLIP

Specifics function for some GSM networks which support transfer of additional informations about in CLIP field.

## 7.12. Prefixes

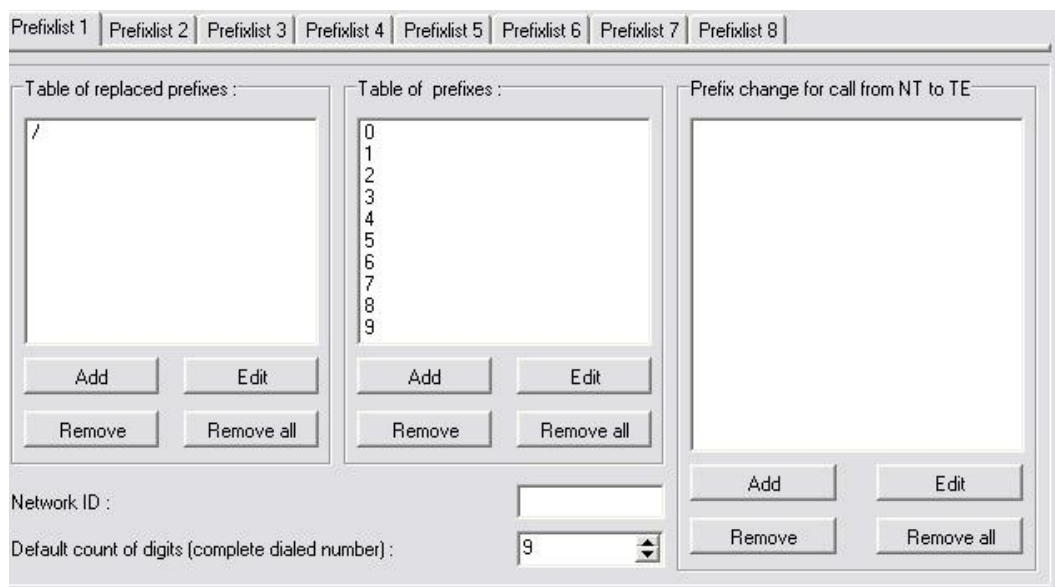

Fig. 33 - Network List Editing Window

The List of prefixes helps the gateway connect calls to various GSM networks. You can define call routing by prefixes in eight groups. *Default* sets the current list to default settings. *Default all* sets all prefixlists to default setting. You will find the following items in the editing window:

- *Table of replaced prefixes* – a table of prefixes to be replaced (e.g. '+420' with '0'). This change is made before the prefix table is checked.
- *Table of prefixes* – a table of called prefixes. You can define the dialling length too here. If you do not enter the dialling length, the *Default count of digits* will be used automatically.
- *GSM network ID* – a numerical identification code of the selected prefix table used for internal identification purposes only. It has no influence on call routing.
- *Default count of digits* – used for defining the count of digits to be considered if the count is not included in the prefix table.

### 7.13. LCR table

The LCR (Least Cost Routing) table helps define the call routing procedure according to the called subscriber's number depending on the day time and day in a week.

The LCR table setting using the GSM configuration software is discussed in this subsection.

Network	Using time	Groups	Limit	
1/	0:00/24:00	3	0	<input type="button" value="Add"/>
				<input type="button" value="Edit"/>
				<input type="button" value="Remove"/>
				<input type="button" value="Remove all"/>
				<input type="button" value="Load from the gate"/>
				<input type="button" value="Save to the gate"/>
				<input type="button" value="Save to file"/>
				<input type="button" value="Default"/>

Holiday list :

<input type="text"/>	Date to move to summer time [dd.mm] :	<input type="text" value="00.00"/>
<input type="text"/>	Date to move to winter time [dd.mm] :	<input type="text" value="00.00"/>
	<input type="button" value="Add"/>	
	<input type="button" value="Remove"/>	
	<input type="button" value="Remove all"/>	
	<input type="button" value="Default"/>	

Fig. 34 – LCR table

#### LCR Table

- *Add* – this button adds a record into the LCR table. By pressing it you open the editing window (see Fig. 35).

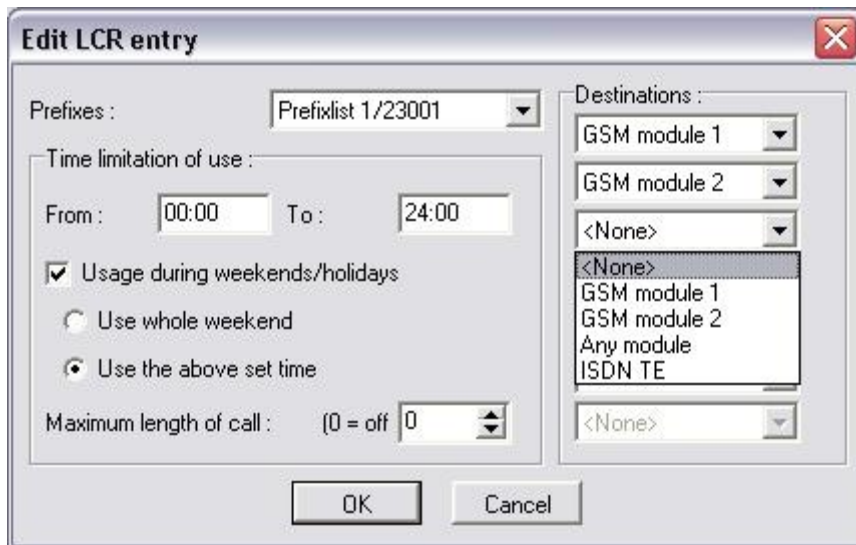

Fig. 35 – LCR table Data Entering

By completing the LCR data adding table you set one call routing rule.

- *Prefix list* – select one of the prefixlists from the “*GSM Parameters – Prefixes*” in the pull-down menu to which the routing rule should apply. The prefixlist settings are discussed in Subs. 1.12.
- *Outgoing interface* – this list is used for selecting of outgoing interface. All outgoing calls are routed to the respective interface according to the selected prefixlist. The routing priority is from top to bottom. Therefore, if the top parameter (GSM module 1) cannot be used, the call is routed according to the parameter under the first one (GSM module 2). Setting of routing according to *Any group/module* is required if the parameter *GSM parameters – General – GSM module selection* is set up to *Cyclic* or *Smart*. Use ISDN TE interface to set up routing of calls to TE port according to prefixes in *Prefixlist*.
- *Time limitation of use*– sets the time limit for the routing rule defined in this menu. The time validity *From – To* may include weekends too.

- *Max. length of call* – limits the call duration to the network selected in *Network number* through the GSM group selected in *Groups*. To disable the call duration limitation set the value at 0.
- *Edit* – you can edit a routing rule from the LCR table by pressing this button.
- *Remove* – deletes a routing rule selected from the LCR table list.

### **Holiday List**

- *Holidays list* – enter the public holidays to optimise your telephone costs with the LCR.
- *Date to move to summer time [dd:mm]* – enter the day on which winter time should be changed into summer time for LCR purposes.
- *Date to move to winter time [dd:mm]* – enter the day on which summer time should be changed into winter time for LCR purposes.

### **7.14. Autorouting Table**

Autorouting table is a tool for permanent routing of incoming calls from GSM network to respective extensions. Moreover the Autorouting table serves for managing of Callback function for incoming CLIPs from GSM network.



- 
- *Add* – this button is intended for adding of new record to the autorouting table. The window shown on the opens by clicking this button.
  - *GSM number (CLIP)* – field for the GSM number, for which will be autodial or autcallback function applied. CLIP must be entered in the same format as is presented by GSM network (the same as is for incoming calls shown on GSM phone display).
  - *Dial (to ISDN)* – incoming GSM calls will be routed to the ISDN extension number filled in this field
  - *Autodial* – selecting this item all incoming calls with CLIP filled in *GSM number (CLIP)* will be routed to the extension number filled in *Dial (to ISDN)* field.
  - *Autocallback* – selecting of this item activates Autocallback function. The autocallback routine is activated after the calling party in the GSM network hangs up. If the field *Dial (to ISDN)* is filled in, the BRI Enterprise establishes connection to the extension in the ISDN network while establishing of the call to the GSM network. If the *Dial (to ISDN)* field is empty, the BRI Enterprise establishes connection back to the GSM and after the accepting of the call plays back the dial tone or voice message and awaits DTMF digits.
  - *Limit* – setup the maximum length of call. Value “0” disables this function.
  - *Edit* – for editing of autorouting table records.
  - *Remove* – for removing of autorouting table records. Clicking this button removes selected record from the table.

SECTION 3

---

## Configuration Using Terminal

It is possible to communicate with the 2N<sup>®</sup> BRI Lite through a USB. The connection allows for a uniform way of gateway configuration using AT commands.

This section includes:

- USB Communication Settings

- Transmission rate: 921600 bps

Data bits: 8

Parity: none

Stop bits: 1

Flow control: none

- Terminal Communication

- Transmission rate: 921600 bps

Data bits: 8

Parity: none

Stop bits: 1

Flow control: none

- 
- Terminal Communication
  - List of Terminal AT Commands

## 8.1. USB Communication Settings

You can, e.g., use the *HyperTerminal* communication software for communication using a USB port connected as a virtual COM port. To set communication select the following parameters:

Transmission rate:	921600 bps
Data bits:	8
Parity:	none
Stop bits:	1
Flow control:	none

## 8.2. Terminal Communication

The terminal is also part of the GSM configuration software. To start the terminal use *Functions – Other functions – Terminal* from the main menu. Be sure to configure the GSM program properly for communication (refer to Subs. 1.3, *Functions*).

## 8.3. GSM Gateway Behaviour

The gateway behaves like an ANSI terminal with an echo. The commands are entered in the text format and the X-modem protocol is used for file transfer. The gateway responses with the “OK” message after the login to the gateway. If not, type: *at* and press <ENTER> key. In case the gateway is correctly connected, the gateway responses by the „OK“ message. There is possible to set username and password to ensure better security of the gateway. The gateway responses with the message shown in the Fig. 36 if the login name is required. After entering of your login name press <ENTER> and after that enter the password.

```
[ M115 ] B-02.52 BRI115 V-02.04.16 BL
Date/time: 1.1.2002/1:43:11.08
SNumber: M115-0800010001
```

```
BL login: _
```

Fig. 36 – Login message

## 8.4. List of Terminal AT Commands

All commands start with AT by default. (Note: Some of the below mentioned AT commands may not be available in the current firmware versions.)

Note: AT commands are same as for BRI Enterprise gateway. Commands which contains BRI1 (Pxx) settings are not used in 2N<sup>®</sup> BRI Lite gateway. 2N<sup>®</sup> BRI Lite gateways has only BRI2 (Exx) interface.

### Basic AT Commands

<b>A/</b>	...repeat last command (without AT)
<b>I3</b>	...copyright & firmware
<b>I4</b>	...serial number
<b>&amp;FRES</b>	...factory defaults & reset
<b>&amp;V</b>	...view active parameters (system)
<b>&amp;VI</b>	...view active parameters (isdn)
<b>&amp;V0</b>	...view active parameters (common)
<b>&amp;V#</b>	...view active parameters (modules 1..2)
<b>&amp;V9</b>	...view active parameters (inc. groups)
<b>&amp;VALL</b>	...view all group parameters
<b>&amp;P</b>	...view pseudo params
<b>&amp;N#</b>	...view network params (net 1..8)
<b>&amp;NALL</b>	...view all network params
<b>&amp;A</b>	...view autorouting table <SPACE...continue>
<b>&amp;R</b>	...view lcr-routing table <SPACE...continue>
<b>&amp;T</b>	...view bris + modules totals
<b>&amp;TMOD</b>	...view all modules totals
<b>&amp;G##=atcommand</b>	...send at command to module 0..1 (ended by OK from gsm)
<b>&amp;G##=xtcommand</b>	...send at command to module 0..1 (ended by <CR> from user)
<b>&amp;G##=cmd</b>	...cmd for module 0..1 (RESET,BLOCK,OFF,DOWN,ON), (ATBAUD)
<b>&amp;GALL=cmd</b>	...cmd for module 0..1 (RESET,BLOCK,OFF,DOWN,ON)
<b>&amp;S</b>	...view aux, bris, modules status
<b>&amp;S##</b>	...view aux, bris, one module status (ax,px,ex,0..1)
<b>&amp;S=info</b>	...view all modules selected info (by at&S##)
<b>&amp;Q##</b>	...view signal quality on module 0..1
<b>&amp;QALL</b>	...view signal quality on all modules
<b>&amp;L</b>	...view logfile from recent <SPACE...continue>
<b>&amp;C</b>	...view buffer (calls) from recent <SPACE...continue>
<b>&amp;CR</b>	...read buffer from the oldest <#...erase & continue>
<b>&amp;BSYS=cmd</b>	...cmd for system (RESET)
<b>&amp;XG</b>	...view conn table/gsm (call states)

---

<b>(&amp;XG##</b>	...view call details for gsm channel)
<b>&amp;M0</b>	...disable ansi colors
<b>&amp;M1</b>	...enable ansi colors
<b>&amp;M9</b>	...start matrix
<b>&amp;U</b>	...view logged users
<b>&amp;I##</b>	...view gsm moninfo (dBm = signal level when registering with BTS, RxLEV = minimum signal level required by BTS for registering of GSM module)

## Configuration AT Commands

### System Settings

<b>%S85=sms</b>	...no answer sms text (max 63 chars)
<b>%S90=mode</b>	...operating mode of GSM module allocation  (0=cyclic mode, 1=locked mode, 2=smart mode - according to already called minutes) (for 0 and 2 set LCR group = 3 (any))
<b>%S91=buf,id</b>	...cdr mode (b0=outg, b1=inc, b2=failed, b3=moninfo) unit id (0=off, 1..255)
<b>%S92=rep</b>	...report mode (b0=states, b1=tstamp, b2=smp, b3=lay2, b4=select)
<b>%S98=pin</b>	...sim pin (max 7 digits)
<b>%S99=dd.mm.yy.w/hh:mm:ss</b>	...set date/time (w=1..7 day of week)
<b>%X10=tsec</b>	...external routing tout in sec/10 (5..60,255)
<b>%X20=mmdd,mmdd</b>	...date of hour+1,hour-1 time change (0=off,0101..1231)
<b>%X22=hh:mm</b>	...0:01..23:59 - time of reset of GSM gateway, 0:00 - no reset
<b>%X80=login/pass</b>	...login name / password (max 15 chars all)

### System Control

<b>AT&amp;Gxx=RESET</b>	Reset of GSM module No xx
<b>AT&amp;Gxx=BLOCK</b>	Block of GSM module No xx
<b>AT&amp;Gxx=DOWN</b>	Transfer of GSM module into the sleep mode
<b>AT&amp;Gxx=ON</b>	Transfer of GSM module into the idle mode

### ISDN Settings

<b>%I00=xxx</b>	...BRI protocol mode = NT : as Network termination mode = TE/E : as TE mode with DTMF receiving (extension) = TE/T : as TE mode without DTMF receiving (trunk)
-----------------	---

**%I01=tei,mtp**                   tei,mtp = 0..63,0 ....fixed tei,ptp  
                                   tei,mtp = 64,0 ....dynamic tei,ptp  
                                   tei,mtp = 64,1 ....fixed tei,mtp

**%I05=c1,c2,c3,c4**               ...cause codes for failed calls  
                                   c1=dial timeout (TIMEOUT=120)  
                                   c2=dis.prefix (REJECT=21)  
                                   c3=req.mod/grp not ready (TEMPFAIL=41)  
                                   c4=pref grps not ready (CONGEST=42)

**%I06=sack,proc,prog,ale**       ...prog.elem (0=off,1..8) for isdn message

**%I07=opx/npx,...**           ...list of old/new prefixes (max 47 chars)

**%I08=dial,ring,disc**         ...dial (0 = off,1..255) dialtone to NT on empty SETUP, ring (0=off,1..255) ringtone to NT if no PROGRESS from PSTN  
                                   - 1=EU (dial = constantly 425Hz,       ring = 1000+4000msec 425Hz)  
                                   - 2=CZ (dial = 300/300/600/1200msec 425Hz,   ring = 1000+4000msec 425Hz)  
                                   - 3=HU (dial = constantly 425Hz,       ring = 1000+4000msec 425Hz)  
                                   - 4=GB (dial = constantly 425Hz,       ring = 400+200+400+2000msec 400+450Hz)

**%I09=day,bits,enb**           ...day (0=off,1..31) of clearing bri stat  
                                   ctrl bits (b0=not defined, b1=not defined ,b2=subaddr-recv, b4=don't send CONNECT\_ACK in TE mode)  
                                   enblock digits (0=overlap,1..20)

**%I127=msn**                    ...MSN number for TE mode

**GSM / Groups settings**

**%G02=mode,atms,afms**         ...tc35 mode (2,4)  
                                   atms/afms gain (+5dB=3,+2.5dB=1,0dB=0,-2.5dB=2,-5dB=4)

**%G05=delay**                   ...dtmf space delay (1..99 sec/100)

**%G06=mmdd,..mmdd**           ...holiday list (0101=1st jan, 1231=31st dec)

**%G07=mmdd,..mmdd**           ...holiday list2

**%G08=delay,min,max,tout**     ...gsm call delay (0..10 sec), dial min/max (0..20)  
                                   dial tout (0..20 sec)

**%G09=bits,dial,ring**         ...bit0=sim card number (0=imsi,1=scid)  
                                   bit1=siemens connecting tone,  
                                   bit2=don't send CLIP for calls BRI<-GSM  
                                   bit3=send AoC for calls BRI->GSM (functionless for FW>2.03.14 and lower)  
                                   dial (0=off,1..255) dialtone to GSM, ring(0=off,1..255) ringtone to GSM if no PROGRESS from PBX  
                                   - 1=EU (dial = constantly 425Hz,       ring = 1000+4000msec 425Hz)  
                                   - 2=CZ (dial = 300/300/600/1200msec 425Hz,   ring = 1000+4000msec 425Hz)  
                                   - 3=HU (dial = constantly 425Hz,       ring = 1000+4000msec 425Hz)  
                                   - 4=GB (dial = constantly 425Hz,       ring = 400+200+400+2000msec 400+450Hz)

**%G101=old/new,...**           ...gsm causes change table (0..8 causes)

---

**%G#1=netid,clir,min,sms,day,sec,sec2,pseudo**

...out.module 1..2, sim 1 params  
netid (7 chars), clir (0=netw,1=on,2=off)  
min (0=off,1..65535 minutes), sms (0=off,1..65535)  
day (0=off,1..31,32=everyday), sec/2 (1..250)  
pseudo (0=off,1..8)

**%G#9=ale,conn,disc,day,bits,nasms**

...alerting tout (0=off,1=send ALERTING on receiving +CIEV form GSM network,  
2..20sec after receiving PROCEEDING)  
conn delay (0..20sec),  
forced disc (bit0=sim limit, bit1=time limit, bit2=noale)  
day (0=off,1..31) of clearing group stat,  
bits 0..255, b0=(notused), b1=min-->calls, b2=(notused)  
b3=(notused),  
nasms tout (0=off, 1..20sec)

**%G9#=mode,min,max,tout,day,dial,clip**

...inc.module 1..2 params  
mode (0=reject,1=ignore,2=ok-message,3=ok-tone)  
mode (4..7=0..3 + autocalback, 6..7= + ext.callback)  
min(0..20), max(0..20) tout (0..20 sec) dtmf dial-in  
day (0=off,1..31) of clearing inc.group stat  
dial prefix (max 15 ch), clip prefix (max 7 ch)

**%G9#=xxx,xxx,...xxx**

...auto dials (max 63 chars) #=5..8 for inc.groups 1..4

**%G99=exp,bits**

...dynamic clip expire (0=off,1..240 hours)

**%G19#=mess**

bit0=add.conn, bit1=rem.anws  
...params #=1..4 for inc.groups 1..4  
mess duration (0=once, 1..99=repeated) minutes

**Pseudo paramaters**

**%P01=uuu/HH:MM,...**

...pseudo tarif 6x cents/until (cents=1..9999)  
(until=00:00...first item is all weekend)  
(until=24:00...last mandatory item)

**%P02=uuu/HH:MM,...**

...pseudo tarif extension

**%P03=uuu/HH:MM,...**

...pseudo tarif extension

**%P04=uuu/HH:MM,...**

...pseudo tarif extension

**%P05=uuu/HH:MM,...**

...pseudo tarif extension

**%P06=uuu/HH:MM,...**

...pseudo tarif extension

**%P07=uuu/HH:MM,...**

...pseudo tarif extension

**%P09=mode,sec**

...pseudo mode (0=off,1=cdr,2=cdr+isdn), isdn.sec (1..250)

**Networklist Parameters**

<b>%N#0=opx/npx,...</b>	...list of old/new main-prefixes (max 47 chars)
<b>%N#1=pref/dig,...</b>	...list of prefixes/digits-to-end (max 63 chars)
<b>%N#2=pref/dig,...</b>	...pref. list extension (max 63 chars)
<b>%N#3=pref/dig,...</b>	...pref. list extension (max 63 chars)
<b>%N#4=pref/dig,...</b>	...pref. list extension (max 63 chars)
<b>%N#5=pref/dig,...</b>	...pref. list extension (max 63 chars)
<b>%N#6=pref/dig,...</b>	...pref. list extension (max 63 chars)
<b>%N#7=pref/dig,...</b>	...pref. list extension (max 63 chars)
<b>%N#9=netid,max</b>	...network id (7 chars), default max digits (0..20)



## Routing Paramaters

<b>%A##=clip,dial,limit</b>	...set autorouting item (ix 0..95) clip (20), dial(20), limit(0=off,1..99 minutes)
<b>%R##=net,hh:mm/hh:mm/w+-,groups,lim ...set lcr-routing item (ix 0..63)</b>	net (1..8), groups = (max 7 chars=1..3,9), 3=any module, 9=bri2 call limit (0=off, 1..99min) last LCR table line must be empty
<b>; totals</b>	
<b>; first m,c,s</b>	...inc. minutes,calls,smses
<b>; second m,c,s</b>	...out. minutes,calls,smses
<b>; ri,ro</b>	...redirected inc,out calls
<b>%TB#=m,c,m,c</b>	...init minutes,calls in bri # (0..65535)
<b>%TBALL=m,c,m,c</b>	...init minutes,calls in all bris (0..65535)
<b>%TG#=m,c,ri,ro</b>	...init minutes,calls,rin,rout in group # (0..65535)
<b>%TGALL=m,c,ri,ro</b>	...init minutes,calls,rin,rout in all groups (0..65535)
<b>%TI#=m,c</b>	...init minutes,calls in inc.group # (0..65535)
<b>%TIALL=m,c</b>	...init minutes,calls in all inc.groups (0..65535)
<b>%T##=1,m,c,s,m,c,s</b>	...init minutes,calls,sms in mod ##, sim 1 (0..65535)
<b>%TALL=1,m,c,s,m,c,s</b>	...init minutes,calls,sms in all mods, sim 1 (0..65535)

## Tracing commands

<b>AT!RE</b>	Start tracing of error messages active interface.
<b>AT!Lx</b>	Start tracing of LAN & Telnet on layer x x=2 - Layers IP,TCP,Telnet x=3 - Layers TCP, Telnet x=4 - Layer Telnet
<b>AT!Rx</b>	Start tracing of ISDN BRI & GSM on layer x x=1 - Layers 1,2,3,4 x=2 - Layers 2,3,4 x=3 - Layers 3,4 x=4 - Layer 4
<b>AT!RR</b>	Start tracing (AT!R2) to COM interface
<b>AT!RX</b>	Stop tracing (AT!R2) to COM interface

## Work with SMS

### SMS sending and receiving commands

**AT!G=A6** Start low-level controlling for SMS (can run only on one port)  
**AT!G=55** Stop low-level controlling on used port

### Control SMS

**AT^SX=ch** ... (sms listing) request to list all SMS messages and status confirmations saved on SIM card. Possible answers: \*smserr (busy,list) or \*smsinc (ix=1..255) for each saved SMS or status SMS messages, end of list or empty SIM card - \*smsinc (ix=0).

**AT^SR=ch,ix** ... (sms read) request to read SMS or status SMS saved in SIM card. Possible answers: \*smserr (busy,read) or \*smspdu

**AT^SD=ch,ix** ... (sms delete) request to delete SMS message (or status SMS message). Possible answers: \*smserr (busy,delete) or \*smsdel

**AT^SM=ch,len,pdu,csum** ... (sms to module) request to send message via GSM module 0..31 or via any GSM module (ch=32). Possible answers: \*smserr (busy,write) or \*smsout

**AT^SG=grp,len,pdu,csum** ... (sms to group) request to send SMS message via GSM group 1..8. Possible answers: \*smserr (busy,write) or \*smsout

### Messages from BRI ISDN Gateway

**\*smsinc: ch,ix,sts** ... SMS message was received and saved into SIM card:  
Ch ... GSM module number 0..31  
Ix ... index number of saved SMS 0..255  
Sts ... SMS status

**\*smsrep: ch,ix** ... SMS status confirmation was received and saved to SIM card (this message is only for GSM modules TC35 and GM47)

**\*smsout: ch,ix,ref** ... SMS message was sent and was not saved into SIM card:  
Ref ... reference number of sent SMS 0..255 (will be used in SMS status confirmation message)

**\*smspdu:** ... content of SMS message or status confirmation:  
**ch,ix,sts,len,pdu,csum**  
Len ... SMS length (number of bytes in PDU)  
Pdu ... message content in PDU format  
Csum ... Checksum of all PDU bytes (2 hexa digits) calculated without carry

**\*smsdel: ch,ix** SMS message or status confirmation was deleted from position ix

**\*smserr: ch,ix,req,err** response to error command:  
Req ... required GSM module or GSM group  
Err ... error code (6=busy, 40=write, 41=read, 42=delete, 43=list)

---

## Status Messages

### ISDN Layer 1 Status Messages

ID	Name	Description
0	<b>DEACT</b>	Deactivation – no signal received
1	<b>ACTIVE</b>	Activation – full synchronisation achieved (frame,multiframe,crc)
2	<b>SIGNAL</b>	Signal received – no synchronisation
3	<b>SYNC</b>	Signal received – only partial synchronisation (frame)

### ISDN Layer 2 Status Messages

ID	Name	Name according to ITU-T Q.921
0	NOTEI	TEI Unassigned
1	AWTEI	Assigned Awaiting TEI
2	AWTEST	Establish Awaiting TEI
3	OKTEI	TEI Assigned
4	AWEST	Awaiting Establishment
5	AWREL	Awaiting Release
6	OKEST	Multiple Frame Established
7	TIMREC	Timer Recovery

### ISDN Layer 3 Status Messages

ID	Name	Name according to Q.931	Description on NT interface	Description on TE interface
0	NULL	Null	Rest status, ready for call	
1	CINIT	Call Initiated	Call from BRI indicated	Call to BRI started
2	OVSEND	Overlap Sending	Gradual dialling receiving	Gradual dialling sending
3	OPROC	Outgoing Call Proceeding	Dialling from BRI terminated	Dialling to BRI terminated
4	CDELIV	Call Delivered	Call from BRI ringing	Call to BRI ringing
6	CPRES	Call Present	Call to BRI started	Call from BRI indicated
7	CRECV	Call Received	Call to BRI ringing	Call from BRI ringing
8	CONREQ	Connect Request	Call to BRI answered	Call from BRI answered
9	IPROC	Incoming Call Proceeding	Dialling to BRI terminated	Dialling from BRI terminated
10	ACTIVE	Active	Connected call	
11	DISREQ	Disconnect Request	End of call from BRI	End of call to BRI
12	DISIND	Disconnect Indication	End of call to BRI	End of call from BRI
19	RELREQ	Release Request	Channel release request	
25	OVRECV	Overlap Receiving	Gradual dialling sending	Gradual dialling receiving
61	RSTREQ	Restart Request	Channel restart request sent	
62	RSTART	Restart	Channel restart request received	

### Management Status Messages

ID	Name	Description
0	<b>INIT</b>	Initialisation upon BRI reset
1	<b>IDLE</b>	Activation – rest status, necessary for layers 2 and 3
2	<b>DISC</b>	Deactivation

## GSM Layer Statuses

### GSM Layer 2 Status Messages

ID	Name	Description	Followed by
0	<b>INIT</b>	GSM module initialisation start	PINREQ
1	<b>SIM0</b>	Module switch to internal SIM card	INIT
2	<b>PINREQ</b>	Module PIN request	PINSET
3	<b>PINSET</b>	PIN value sending to module	INFO
4	<b>BLOCK</b>	Module blocked temporarily or permanently (see Layer 2 information)	INIT
5	<b>SETUP</b>	Module configuration running	IDLE
6	<b>SLEEP</b>	Module sleep running (transition to BLOCK status)	BLOCK
7	<b>NWAIT</b>	Awaiting GSM log-in	SETUP
8	<b>IDLE</b>	Rest status, can start/receive call, execute AT&G command	CALL/CMD
9	<b>CALL</b>	Call running (call establishing, connected call, call end)	IDLE
10	<b>CMD</b>	Communicating with module upon AT&G command	IDLE
13	<b>INFO</b>	Information loading from module and SIM card	NWAIT

### GSM Layer BLOCK Status Messages

ID	Name	Description
41	<b>(block)</b>	Blocked by AT&G command, terminated by module, board or system reset
42	<b>Netw-reg</b>	GSM log-in refused (not activated SIM), next attempt in 5..60 minutes
43	<b>Clir-err</b>	CLIR activation request refused, next attempt in 2..10 minutes
44	<b>Mod-err</b>	Defective or not connected GSM module, next attempt in 2 minutes
45	<b>Pin-err</b>	Wrong PIN, permanently in BLOCK status
46	<b>Sim-err</b>	Defective or not inserted SIM card, next attempt in 2 minutes
47	<b>Log-out</b>	Temporarily logged-out according to parameter X00
48	<b>Puk-req</b>	SIM card requires PUK
	<b>(undef)</b>	This position of SIM card wasn't checked by gateway

### GSM Layer 3 Status Messages

ID	Name	Description
0	NULL	Rest status, ready for call
1	CINIT	Call request to GSM (from Layer 4)
3	OPROC	Call to GSM is connected
4	CDELIV	Call to GSM is ringing
6	CPRES	Call indication from GSM (from Layer 2)
7	CRECV	Call from GSM is ringing on ISDN interface
9	IPROC	Call from GSM is processed by ISDN interface
10	ACTIVE	Connected call
11	DISREQ	Disconnection request (to Layer 2)
12	DISIND	Indication of disconnection (from Layer 2)
19	RELREQ	Module release for another call (to Layer 2)
25	OVRECV	Reading of DTMF dialling from GSM (from Layer 2)
38	RELIND	Indication of module release (from Layer2)

**Layer 4 Status Messages**

<b>ID</b>	<b>Name</b>	<b>Description</b>
0	NULL	Rest status, ready for call
1	MORE	Call request received from GSM or ISDN, awaiting further dialling or timeout
2	SETUP	Call request sent to opposite interface
3	PROC	Call request confirmed, awaiting call answer
4	ACTIVE	Connected call
5	DISC	Call disconnection in progress

---

## Command Shell Statuses

### Command Line Status Messages

ID	Name	Description
0	IDLE	Rest status, awaiting AT commands
1	REQUEST	Communication with GSM module upon AT&G command is displayed
2	REPORT	Active tracing
3	LOGFILE	Content of log file is being written out
4	CALLFILE	Content of call file is being written out
5	CALLREAD	Call file records are read
6	AUTOFILE	Content of incoming call autorouting chart is being written out
7	QUERY	(not used so far)
8	SCREEN	(not used so far)
9	MATRIX	Active matrix screensaver
10	FUNCFILE	Content of debug file is being written out
11	LCRFILE	(not used so far)

### Telnet Status Messages

ID	Name	Description
0	LOGOUT	User logged-out
1	LOGIN	User is entering name
2	PASSW	User is entering password
3	IDLE	User logged-in

## Records of Events and Calls

### Records on Events and Calls

ID	Name	Description
0	POWER	System power on, power off or reset
1	INIT	Initialisation of EEPROM (configuration) or flash (upgrade)
3	SYSEERR	System error (memory error, etc.)
8	L1-ERR	BRI port layer 1 error (ISDN1)
9	L2-ERR	BRI port layer 2 error (ISDN2)
10	L3-ERR	BRI port layer 3 error (ISDN3)
12	G2-ERR	GSM module layer 2 error (gate2)
13	G3-ERR	GSM module layer 3 error (gate3)
14	C4-ERR	Link layer error (call4)

### Types of Records in Call Record File

ID	Name	Description
0	I-FD	Not connected incoming call attempt
1	I-OK	Connected incoming call
8	O-FD	Not connected outgoing call attempt
9	O-OK	Connected outgoing call

## 8.5. Records on Operation (LOG)

Type	Text	Description
POWER	[Power on] [Power off] [Warm boot] [Watchdog] [BKPT code] [Stack error] [Divided by zero] [RETI code] [NMI intr] [VOID intr] [Upgrade reset] [Software reset]	System switched on System switched off Restart of system, unknown cause Restart of system by watchdog CPU error: break code detected CPU error: stack integrity failure CPU error: dividing by zero CPU error: illegal using of instruction reti CPU error: wrong interrupt CPU error: wrong interrupt Start of upgrade firmware procedure Reset by AT commands (at&fres...)
INIT	Eeprom Flash	Initialisation of eeprom (configuration) Initialisation of flash memory (firmware)
HW-ERR	Duart #####,RD/WR	(##...address of chip, RD...read value/WR...expected value) Error in initialisation of serial controller on GSM board
SYSERR	User stack error!	SW error: stack integrity failure
BRDIN	#08 TYP STS	the board inserted (number of gsm board, type, status)
BRDOUT	#08 TYP STS	the board disconnected
BRDRES	#08 TYP STS ALL GSM RESET CMD SYSTEM RESET CMD	Reset the board by AT command Reset of all GSM boards by AT command Reset of system by command at&bsys
L1-ERR		(reserved)
L2-ERR	A: unsol.RX(F) B: unsol.DM(F) C: unsol.UA(F) D: unsol.UA(-) E: unsol.DM(-) F: peer re-est G: repeated SABME H: repeated DM I: failed (TIMREC) J: N(R) error K: recv.FRMR L: undef.frame M: (I field) N: frame size O: N201 error	Error of 2. ISDN layer by Q.921 Received packed RR,RNR,REJ with unexpected bit F=1 Received packed DM with unexpected bit F=1 Received packed UA with unexpected bit F=1 Received packed UA with unexpected bit F=0 Received packed DM with unexpected bit F=0 Received packed SABME in status OKEST Repeated unsuccessful send of packet SABME Repeated unsuccessful send of packet DM Unsuccessful breaking-up of status TIMREC Received wrong value N(R) – numbering of packets Received packed FRMR (information about error) Received unknown type packed Received wrong I-packet (numbered packet) Received packed with wrong length Value N201 was exceeded (max. length of packet)
L3-ERR	tout sts # (p##)	Error of isdn layer 3: timeout in status # on channel p##



---

<b>Type</b>	<b>Text</b>	<b>Description</b>
G2-ERR	ATD/ERROR init (g##)	Error of isdn layer 2: restart of module g## after rejected command ATD by GSM network
	GSM Cause 150 (g##)	Error of isdn layer 2: restart of module g## after cause 150 was received (call barred by GSM network)
G3-ERR	tout sts # (g##)	Error of isdn layer 3: timeout in status # on module g##
C4-ERR	tout sts # (p##/g##)	Error of connecting layer 4: timeout in status # on call between channel p## and GSM module g##

## 8.6. Records on Calls

Example of a successfully connected call:

```
** 06.12.05/15:44:57 O-OK          CAU-016 p01/g01 GRP-3   0:18
      000:12          00000.00          737111074          112
1/230030102122930
```

- 1st column: \*\*
- 2nd column: call start date/time
- 3rd column: call type
  - call I-FD : Unconnected incoming call attempt (will be implemented in a higher firmware version)
  - I-OK : Successfully connected incoming call (will be implemented in a higher firmware version)
  - O-FD : Unconnected outgoing call attempt
  - O-OK : Successfully connected outgoing
- 4th column: CAUSE sent to ISDN
- 5th column: used B-channel number / used GSM module number
- 6th column: used GSM group (C= CallBack)
- 7th column: call establishing time
- 8th column: call duration mmm:ss (max. 255:59) or error cause for unconnected calls
- 9th column: call cost (will be implemented in a higher firmware version)
- 9th column : gateway id (optional)
- 10th column: called number
- 11th column: caller's MSN number
- 12th column: slot number / used SIM card IMSI or SCID (Siemens modules only)

## 8.7. Statistics – Description

Note: Format of statistics are same as in BRI Enterprise gateway. Lines which contains BRI1 (Pxx) settings are not used in 2N<sup>®</sup> BRI Lite gateway. 2N<sup>®</sup> BRI Lite gateways has only BRI2 (Exx) interface.

[ Total statistics ]

network	(reset)	minutes	hhhh:mm:ss	calls	reject	failed	c.off	errors
#bri1 inc	(0.00)	2	0:02:21	10	4	4	18	0
#bri2 inc	(0.00)	0	0:00:00	0	0	0	3	0

network	(reset)	minutes	hhhh:mm:ss	calls	reject	failed	red.in	redout
#bri1 out	(1.12)	0	0:00:07	3	0	0	0	0
#bri2 out	(1.12)	0	0:00:00	0	4	0	0	0

module	(reset)	minutes	hhhh:mm:ss	calls	reject	failed	c.off	smses
#mods inc	(0.00)	0	0:00:07	3	0	0	1	0
#mods out	(0.00)	2	0:02:32	11	0	4	9	0

[ End of Total statistics ]

[ Module statistics ]

module	(reset)	minutes	hhhh:mm:ss	calls	reject	failed	c.off	smses
#g00 inc	(0.00)	0	0:00:07	3	0	0	1	0
#g01 inc	(0.00)	0	0:00:00	0	0	0	0	0

module	(reset)	minutes	hhhh:mm:ss	calls	reject	failed	c.off	smses
#g00 out	(0.00)	1	0:01:24	6	0	0	4	0
#g01 out	(0.00)	1	0:01:08	5	0	4	5	0

End of Module statistics ]

[ End of stats record ]

- *Pri/grp* - call type
- *Reset* - Last statistic reset date
- *Minutes* - Number of minutes
- *Hhhh:mm:ss* - Same number converted to time
- *Calls* - Number of calls
- *Reject* - number of unconnected calls (no free GSM module available - call rejected with a cause 41(42))

- *Failed* - number of unconnected calls (rejected by the GSM network)
- *C.off*s - number of unconnected calls (terminated by the calling party)
- *Errors* - number of unconnected calls (wrong requests - dialled prefix, etc.)
- *Red.in* - number of connected calls (re-routed to this GSM group)
- *Red.out* - number of connected calls (re-routed to another GSM group)
- *sm*ses - Number of sent SMS messages

---

# 9

## SECTION 4

---

### **Technical Parameters**

## 2N<sup>®</sup> BRI Lite gateway

---

### GSM:

Mobile network type	GSM 850/900/1800/1900MHz , UMTS/3G – according to the GSM/3G module used
SIM card	plug-in 3 V ("small")
Transmission power	Up to 2 W
Receiver sensitivity	-104 dBm

### Antennas:

Frequency	850/900/1800/1900/2100 MHz depending on the gateway type
Impedance	50 $\Omega$
Maximum output power	2W
Antenna connector type	SMA (male)
Number of antennas	1 or 2 (according to the gateway type)
Cable length	3-10 m or without cable

### Power Supply:

Adapter	110 - 230 V, 50/60 Hz / 12V DC
DC power supply	12 V DC / 2 A
Supply connector	DC jack, 2.1 mm
Lithium battery	CR2032 (only models with serial number XX-XXXX-XXXX)

### ISDN:

Type of ISDN BRI connection	So, point to multipoint So, point to point NT or TE connection type
ISDN protocol	EuroISDN, DSS – 1
Type ISDN connector	2x RJ 45 (parallel crossed connection)
NT interface supply	from an external adapter or ISDN

### Communication Interface:

Type	USB
Connector	B type
	USB 1.1

### Others:

Dimensions (w/o connectors)	250 x 150 x 55 mm
Operational temperature	0°C to 45°C
Relative humidity	5 to 95%



2N TELEKOMUNIKACE a.s.

Modřanská 621, 143 01 Praha 4, Czech Republic  
tel.: 261 301 111, fax: 261 301 999,  
e-mail: sales@2n.cz  
www.2n.cz

PR 1528 v1.4