



QUEST-X GX1500E

25 Watt VHF/FM

ITU Class D DSC Marine Transceiver

Owner's Manual

- Waterproof construction
- Commercial grade ITU Class D DSC VHF
- Independent Channel 70 receiver built-in for continuous DSC watching
- Capable of connecting up to one second station microphone
- Intercom between radio and second station microphone
- DSC position request and send functions with compatible STANDARD HORIZON GPS Chart plotters
- Versatile user-programmable scanning, priority scan and Dual Watch
- One-button access to Channel 16 and 9
- Oversized rotary channel knob, backlit display and keys.
- Navigation information shown on display when optional GPS connected

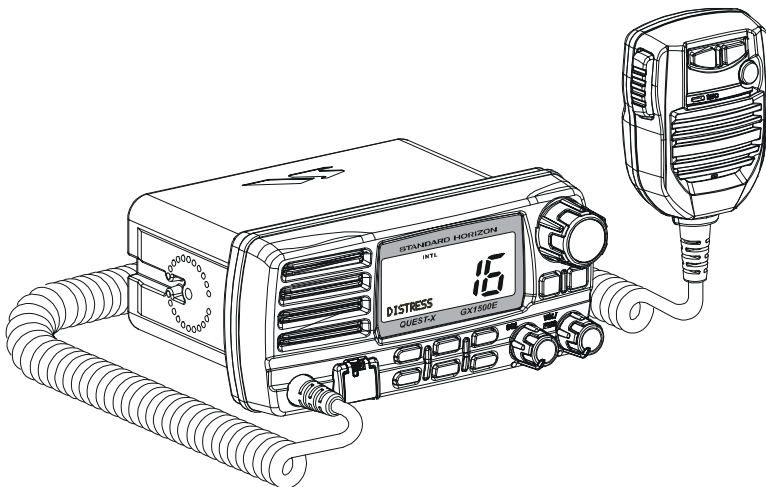

VERTEX STANDARD CO., LTD.

TABLE OF CONTENTS

1	GENERAL INFORMATION	4
2	PACKING LIST	4
3	OPTIONS	4
4	INSTALLATION NOTE	5
5	GETTING STARTED	6
5.1	ABOUT VHF RADIO	6
5.2	SELECTING AN ANTENNA	6
5.3	COAXIAL CABLE	7
6	INSTALLATION	8
6.1	LOCATION	8
6.2	MOUNTING THE RADIO	8
6.2.1	Supplied Universal Mounting Bracket	8
6.2.2	Optional MMB-84 Flash Mount Bracket	9
6.3	ELECTRICAL CONNECTIONS	10
6.4	ACCESSORY CABLE	11
6.5	CHECKING GPS CONNECTIONS	12
6.6	CHANGING THE GPS TIME	12
6.7	CHANGING THE TIME LOCATION	13
6.8	CHANGING COG TO TRUE OR MAGNETIC	13
6.9	OPTIONAL ENHANCED RAM+ SECOND STATION MIC AND/OR VH-310 HANDSET INSTALLATION	14
7	CONTROLS AND INDICATORS	16
8	BASIC OPERATION	22
8.1	RECEPTION	22
8.2	TRANSMISSION	22
8.3	TRANSMIT TIME-OUT TIMER (TOT)	22
8.4	SIMPLEX / DUPLEX CHANNEL USE	23
8.5	INTERNATIONAL, USA, AND CANADA MODE	23
8.6	NOAA WEATHER CHANNELS	23
8.6.1	NOAA Weather Alert	23
8.6.2	NOAA Weather Alert Testing	24
8.7	EMERGENCY (CHANNEL 16 USE)	24
8.8	CALLING ANOTHER VESSEL (CHANNEL 16 OR 9)	25
8.9	MAKING TELEPHONE CALLS	25
8.10	OPERATING ON CHANNELS 13 AND 67	26
8.11	DUAL WATCH (TO PRIORITY CHANNEL)	26
8.12	SCANNING	27
8.12.1	Selecting the Scan Type	27
8.12.2	Memory Scanning (M-SCAN)	27
8.12.3	Priority Scanning (P-SCAN)	28
8.13	NAVIGATION INDICATION	28
8.14	INTERCOM OPERATION	29
8.14.1	Communication	29
8.14.2	Calling	29
9	DIGITAL SELECTIVE CALLING	30
9.1	GENERAL	30
9.2	MARITIME MOBILE SERVICE IDENTITY (MMSI)	30
9.2.1	What is an MMSI?	30
9.2.2	Programming the MMSI	31
9.3	DISTRESS ALERT	32
9.3.1	Transmitting a Distress Alert	32
9.3.2	Receiving a Distress Alert	34
9.3.3	Distress Relay	34
9.4	ALL SHIPS CALL	35
9.4.1	Transmitting an All Ships Call	35
9.4.2	Receiving an All Ships Call	36
9.5	INDIVIDUAL CALL	37

TABLE OF CONTENTS

9.5.1	Setting up the Individual / Position Call Directory	37
9.5.2	Setting up Individual Ringer	38
9.5.3	Setting up Individual / Group Call Ringer	39
9.5.4	Transmitting an Individual Call	40
9.5.5	Receiving an Individual Call	42
9.6	CALL WAITING DIRECTORY	42
9.6.1	Enabling / Disabling the Call Waiting Feature	42
9.6.2	Reviewing Received Calls Logged into the Call Waiting Directory	43
9.6.3	To Delete the Received Log from the "DSC Log" Directory	43
9.7	GROUP CALL	44
9.7.1	Setting up a Group Call	44
9.7.2	Transmitting a Group Call	45
9.7.3	Receiving a Group Call	47
9.8	POSITION REQUEST	48
9.8.1	Setting up Position Reply	48
9.8.2	Transmitting a Position Request to Another Vessel	49
9.8.3	Receiving a Position Request	51
9.9	POSITION SEND	52
9.9.1	Setting up Position Send Ringer	52
9.9.2	Transmitting a DSC Position Send Call	53
9.9.3	Receiving a DSC Position Send Call	54
9.10	DSC TRANSMISSION TEST	54
9.11	MANUAL INPUTTING OF THE GPS LOCATION (LAT/LON)	55
10	RADIO SETUP MODE	56
10.1	LAMP ADJUSTING	56
10.2	LCD CONTRAST	56
10.3	TIME OFFSET	57
10.4	TIME LOCATION	58
10.5	TRUE MAGNETIC CHANGE (NAV display)	58
10.6	PRIORITY CHANNEL SET	59
10.7	SCAN TYPE	59
10.8	SCAN RESUME TIME	60
10.9	KEY BEEP (ON/OFF)	60
10.10	WX ALERT	61
10.11	CHANNEL NAME CHANGE	62
10.12	NAMING THE RADIO OR RAM+ STATIONS	63
11	ENHANCED RAM+ MIC OPERATION	64
11.1	RAM+ MIC CONTROLS	64
11.2	INTERCOM OPERATION	66
11.2.1	Communication	66
11.2.2	Calling	67
11.3	MANUAL INPUTTING OF THE GPS LOCATION (LAT/LON)	67
11.4	DSC / RADIO SETUP MODE	68
11.4.1	Changing GPS Information to Vessel position or COG	69
12	VH-310 HANDSET OPERATION	70
12.1	VH-310 HANDSET CONTROLS	70
12.2	INTERCOM OPERATION	74
12.2.1	Communication	74
12.2.2	Calling	74
12.3	MANUAL INPUTTING OF THE GPS LOCATION (LAT/LON)	75
12.4	DSC / RADIO SETUP MODE	76
12.4.1	Changing GPS Information to Vessel position or COG	77
12.4.2	External Speaker AF Selection	77
13	MAINTENANCE	78
13.1	REPLACEMENT PARTS	78
13.2	FACTORY SERVICE	78
13.3	TROUBLESHOOTING CHART	79
14	CHANNEL ASSIGNMENTS	80
15	SPECIFICATIONS	84

1 GENERAL INFORMATION

The Vertex Standard **GX1500E** is a VHF/FM transceiver designed for use in the frequency range of 156.025 to 163.275 MHz. The **GX1500E** can be operated from 11 to 16 VDC and has a switchable RF output power of 1 watt or 25 watts.

The **GX1500E** is capable of DSC (Digital Selective Calling) Class D operation and an Enhanced second station RAM+ mic (**CMP25** remote-control speaker/microphone with display) or **VH-310** Handset. Class D operation allows continuous receiving of Digital Selective Calling functions on channel 70 even if the radio is receiving a call.

2 PACKING LIST

When the package containing the transceiver is first opened, please check it for the following contents:

- **GX1500E** Transceiver
- Mounting Bracket and attaching hardware
- Panel Cover
- Power Cord
- Owner's Manual
- Warranty Card

3 OPTIONS

MMB-84	Flush-Mount Bracket
CMP25B/W	Remote-Access Microphone (RAM+ Mic, Black/White)
VH-310	Remote Handset (available in Black)
CT-100	7 m Extension Cable for RAM+ Mic/Remote Handset
MLS-310	Amplified External Speaker
MLS-300	External Loudspeaker

4 INSTALLATION NOTE

The installation of this equipment should be made in such a manner as to respect the EC recommended electromagnetic field exposure limits (1999/519/EC).

The maximum RF power available from this device is 25 watts. The antenna should be installed as high as possible for maximum efficiency and that this installation height should be at least 5 meters above ground (or accessible) level. In the case that an antenna can not be installed at a reasonable height, then the transmitter should neither be continuously operated for long periods if any person is within 5 metres of the antenna, nor operated at all if any person is touching the antenna.

In all cases any possible risk depends on the transmitter being activated for long periods (actual recommendation limits are specified as an average of 6 minutes). Normally the transmitter is not active for long periods of time. Some radio licenses will require that a timer circuit automatically cuts the transmitter after 1 - 2 minutes.

5 GETTING STARTED

5.1 ABOUT VHF RADIO

The radio frequencies used in the VHF marine band lie between 156 and 158 MHz with some shore stations available between 161 and 163 MHz. The marine VHF band provides communications over distances that are essentially “line of sight” (VHF signals do not travel well through objects such as buildings, hills or trees). Actual transmission range depends much more on antenna type, gain and height than on the power output of the transmitter. On a fixed mount 25W radio transmission expected distances can be greater than 25 km.

5.2 SELECTING AN ANTENNA

Marine antennas are made to radiate signals equally in all horizontal directions, but not straight up. The objective of a marine antenna is to enhance the signal toward the horizon. The degree to which this is accomplished is called the antenna’s gain. It is measured in decibels (dB) and is one of the major factors in choosing an antenna. In terms of effective radiated power (ERP), antennas are rated on the basis of how much gain they have over a theoretical antenna with zero gain. A 1 m, 3dB gain antenna represents twice as much gain over the imaginary antenna.

Typically a 1 m 3dB gain stainless steel whip is used on a sailboat mast. The longer 2.5 m 6dB fibreglass whip is primarily used on power boats that require the additional gain.

5.3 COAXIAL CABLE

VHF antennas are connected to the transceiver by means of a coaxial cable – a shielded transmission line. Coaxial cable is specified by it's diameter and construction.

For runs less than 6 m, RG-58/U, about 6 mm in diameter is a good choice. For runs over 6 m but less than 15 m, the larger RG-8X should be used for cable runs over 15 m RG213 should be used. For installation of the connector onto the coaxial cable refer to the figure below.

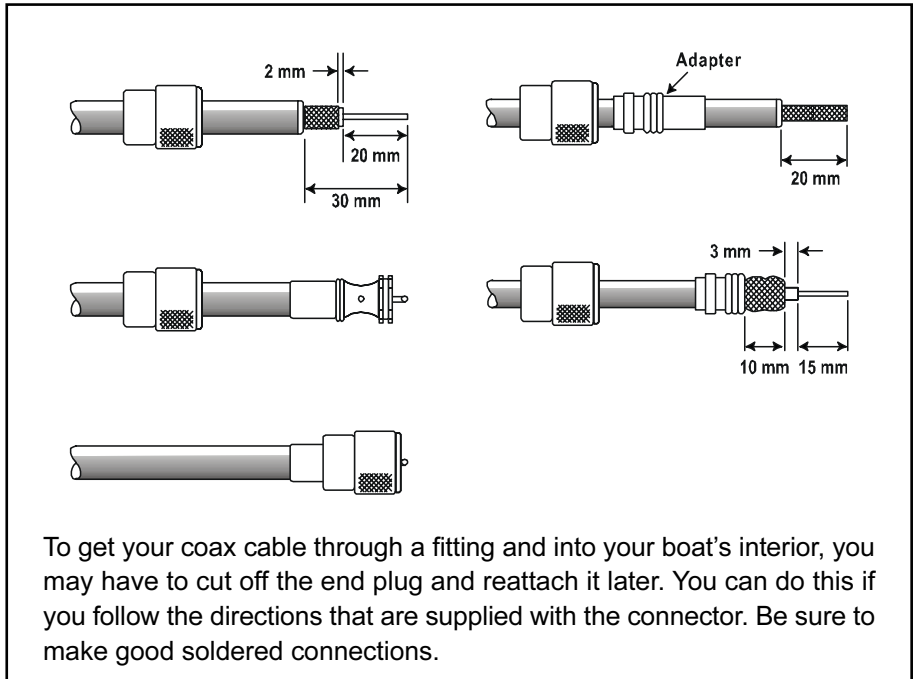

6 INSTALLATION

6.1 LOCATION

The radio can be mounted at any angle. Choose a mounting location that:

- keeps the radio and microphone at least 1 m away from your vessel's magnetic navigation compass
- provides accessibility to the front panel controls
- allows connection to a power source and an antenna
- has nearby space for installation of a microphone hanger
- the antenna must be mounted at least 1 m from radio

Note: To insure the radio does not affect the compass or radios performance is not affected by the antenna location, temporarily connect the radio in the desired location and:

- a. Examine the compass to see if the radio causes any deviation
- b. Connect the antenna and key the radio. Check to ensure the radio is operating correctly by requesting a radio check.

6.2 MOUNTING THE RADIO

6.2.1 Supplied Universal Mounting Bracket

The supplied universal mounting bracket allows overhead or desktop mounting.

Use a 5.2-mm (17/64") bit to drill the holes to a surface which is more 10 mm thick and can support more than 5 kg and secure the bracket with the supplied screws, spring washers, flat washers, and nuts.

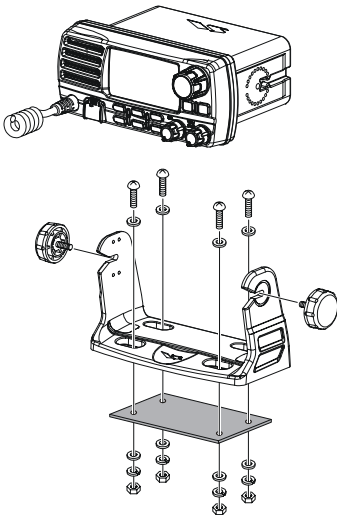

Desktop Mounting

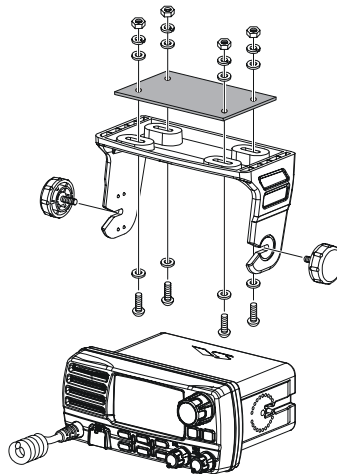

Overhead Mounting

6.2.2 Optional MMB-84I Flush Mount Bracket

1. To assist in flush mounting, a template has been included. Use this template to assess the mounting location.
2. Use the template to mark the location where the rectangular hole is to be cut. Confirm the space behind the dash or panel is deep enough to accommodate the transceiver (at least 15 cm deep).
There should be at least 1.5 cm between the transceiver's heatsink and any wiring, cables or structures.
3. Cut out the rectangular hole and insert the transceiver.
4. Fasten the brackets to the sides of the transceiver with the lock washer nut combination; so that the mounting screw base faces the mounting surface (see Figure 2).
5. Turn the adjusting screw to adjust the tension so that the transceiver is tight against the mounting surface.

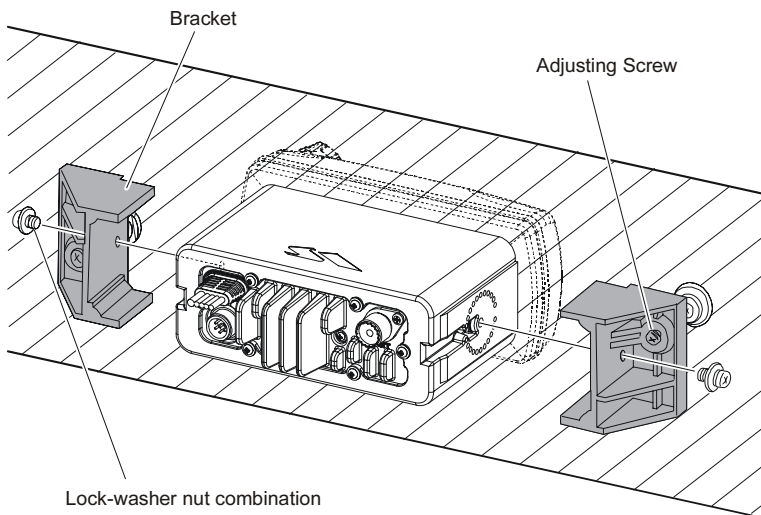

MMB-84 Flush Mount Installation

6.3 ELECTRICAL CONNECTIONS

CAUTION

Reverse polarity connections will damage the radio!

Connect the power cord and antenna to the radio. Antenna and Power Supply connections are as follows (see Figure 1):

1. Mount the antenna at least 1 m away from the radio. At the rear of the radio, connect the antenna cable.
2. Connect the red power wire to a 13.8 VDC $\pm 20\%$ power source. Connect the black power wire to a negative ground.
3. If an optional remote extension speaker is to be used, refer to next section for connections.
4. It is advisable to have a Certified Marine Technician check the power output and the standing wave ratio of the antenna after installation.

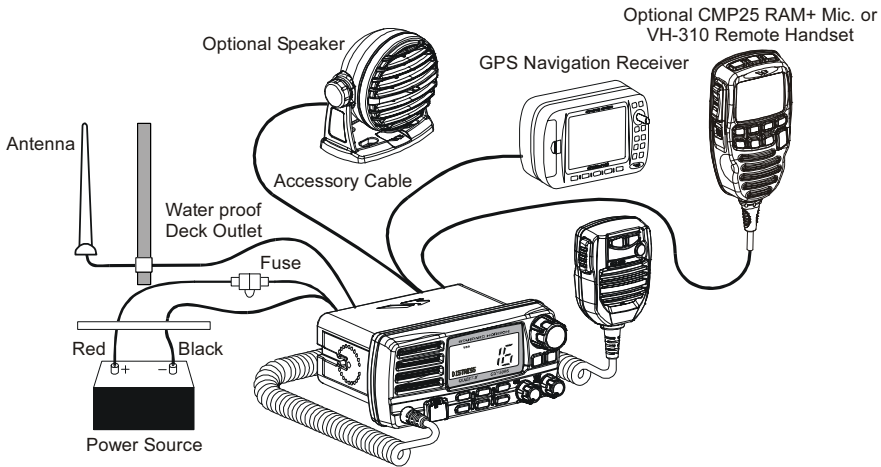
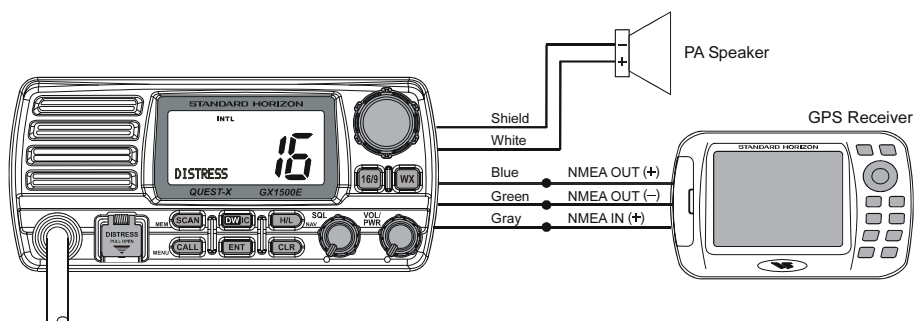

Figure 1. General Installation

6.4 ACCESSORY CABLE

Wire Color/Description	Connection Examples
WHITE - External Speaker (+)	Connect to external 4 Ohm audio speaker
SHIELD - External Speaker (-)	Connect to external 4 Ohm audio speaker
BLUE - NMEA Input (+)	Connect to NMEA (+) output of GPS
GREEN - NMEA Input (-)	Connect to NMEA (-) output of GPS
GRAY - NMEA Output (+)	Connect to NMEA (+) input of GPS
BROWN-NMEA Output (-)	No connection

When connecting the external speaker or GPS navigation receiver, strip off about 2.5 cm of the specified wire's insulation, then splice the ends together using proper waterproofing techniques.



- The GPS must have the NMEA Output turned on and set to 4800 Baud in the setup menu. If there is a selection for parity select none.
- For further information on interfacing /setting up your GPS. Please contact the manufacturer of the GPS receiver.
- **GX1500E** can read NMEA-0183 version 2.0 or higher.
- The NMEA supported sentences are:
 Input: GLL, GGA, RMC and GNS (RMC sentence is recommended)
 Output: DSC and DSE
 (DSC sentences to Standard Horizon Plotter for Position Polling)

6.5 CHECKING GPS CONNECTIONS

After connections have been made between the **GX1500E** and the GPS, a small satellite icon will appear on the top right corner of the LCD display. To see the additional GPS information, press and hold the **[H/L(NAV)]** key. The **GX1500E** shows the Date, Time, SOG and COG.

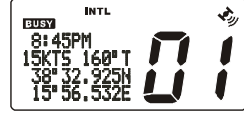

6.6 CHANGING THE GPS TIME

From the Factory the **GX1500E** shows GPS satellite time or UTC time. A time offset is needed to show the local time in your area.

1. Press and hold down the **[CALL(MENU)]** key until “Radio Setup” menu appears.
2. Press the **[ENT]** key, then select “Time Set” with the **CHANNEL** selector knob.
3. Press the **[ENT]** key.
4. Turn the **CHANNEL** selector knob to select time offset from UTC. See illustration below to find your offset time from UTC. If “0:00” is assigned, the time is the same as UTC (Universal Time Coordinated or GMT Greenwich Mean Time).
5. Press the **[ENT]** key to store the time offset.
6. Press the **[16/9]** key or turn the **CHANNEL** selector knob to select “Exit,” then press the **[ENT]** key to return to the “Radio Setup” menu, select “Exit” and press the **[ENT]** key to return to radio operation.

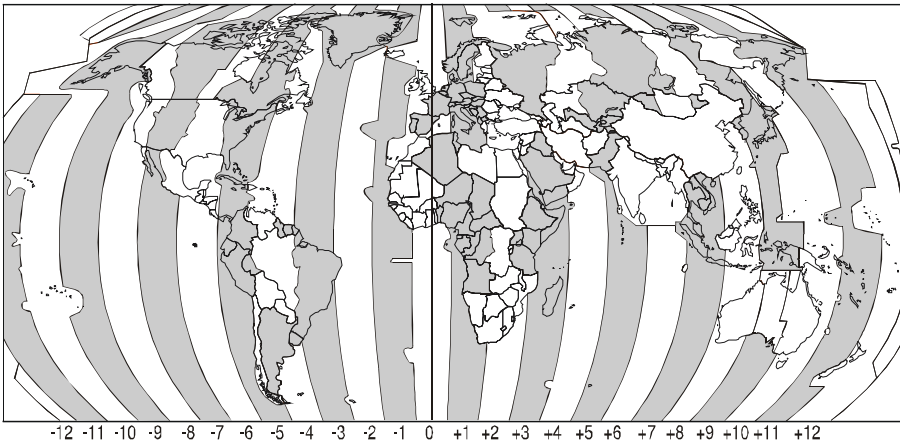

UTC/GMT
OFFSET TIME TABLE

6.7 CHANGING THE TIME LOCATION

Sets the radio to show UTC time or local time with the offset inputted in section 8.6 Changing the GPS Time.

1. Press and hold down the **[CALL(MENU)]** key until “Radio Setup” menu appears.
2. Press the **[ENT]** key, then select “Time Disp” in the “Radio Setup” menu with the **CHANNEL** selector knob.
3. Press the **[ENT]** key.
4. Turn the **CHANNEL** selector knob to select “UTC” or “Local.”
5. Press the **[ENT]** key to store the selected setting.
6. To exit this menu and return to radio operation mode press the **[16/9]** key.



In Local time mode, the display shows the time by the 12-hour system. In UTC time mode the display shows the time by the 24-hour system.

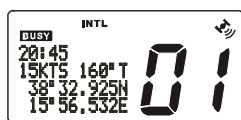

(“UTC” mode)

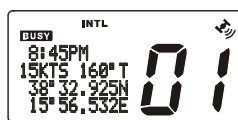

(“LOCAL” mode)

6.8 CHANGING COG TO TRUE OR MAGNETIC

Allows customising the NAV data showing GPS Course Over Ground (COG). Factory default is True however following the steps below the COG can be changed to Magnetic.

1. Press and hold down the **[CALL(MENU)]** key until “Radio Setup” menu appears.
2. Press the **[ENT]** key, then select “Magnetic” with the **CHANNEL** selector knob.
3. Press the **[ENT]** key.
4. Turn the **CHANNEL** selector knob to select “On” (representing “Magnetic”) or “Off” (representing “True”).
5. Press the **[ENT]** key to store the selected setting.
6. Turn the **CHANNEL** selector knob to select “Exit,” then press the **[ENT]** key to return to the “Radio Setup” menu, select “Exit” and press the **[ENT]** key to return to radio operation.

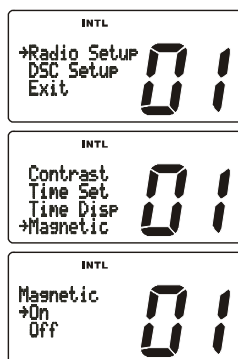

6.9 OPTIONAL ENHANCED RAM+ SECOND STATION MIC AND/OR VH-310 HANDSET INSTALLATION

The **GX1500E** is capable of using a Enhanced RAM+ mic or **VH-310** Handset to remotely control the Radio, DSC, and Distress functions. In addition the **GX1500E** can operate as a full function intercom system.

1. Connect the Routing Cable to the Remote Mic eight pin connector on the rear panel, then tighten the Cable Nut (See Figure 3).
2. Referring to Figure 4, make a 30 mm hole in the wall, then insert the Routing Cable into this hole. Connect the Gasket and Mount Base to the Routing Cable Connector using the Nut.
3. Drill the four Screw holes (approx. 2 mm) on the wall, then install the Mounting Base to the wall using four screws.
4. Put the Rubber Cap on to the Nut. The installation is now complete.
5. Wires for a external speaker are provided on the Routing Cable. Connect any 8 Ohm external speaker. When connected the RAM+ (or **VH-310** Handset) controls the volume level of this speaker.

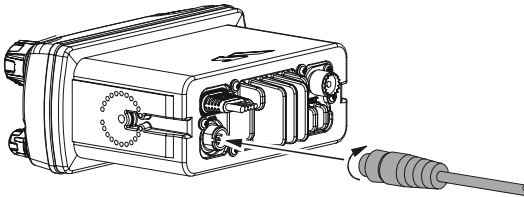

Figure 3

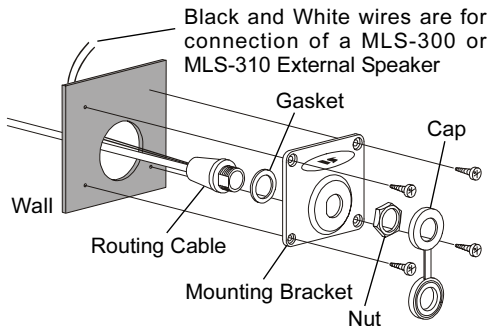

Figure 4

Remote Mic or External Speaker Selection

By default the RAM+ or **VH-310** Handset internal speaker is turned on, however using the RAM+ mic (or **VH-310** Handset) this speaker can be turned off so the external speaker can be used.

RAM+ mic procedure

1. Press and hold the [**CALL(ENT)**] key.
2. Press the [**▲**] or [**▼**] key to select “RADIO SETUP.”
3. Press the [**CALL(ENT)**] key.
4. Press the [**▼**] key to until “EXT SPK” is shown and press the [**CALL(ENT)**] key.
5. Press the [**▲**] or [**▼**] key to select “oF” (External speaker off) or “on” (External speaker on).
6. Press the [**CALL(ENT)**] key to save the selection.
7. Press the [**16/9**] key to exit this mode.

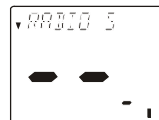

VH-310 Procedure

1. Press and hold the [**CALL(MENU)**] key.
2. Press the [**▲**] or [**▼**] key to select “RADIO SETUP.”
3. Press the [**ENT**] key
4. Press the [**▼**] key to until “EXT SPK” is shown and press the [**ENT**] key.
5. Press the [**▲**] or [**▼**] key to select “oF” (External speaker off) or “on” (External speaker on).
6. Press the [**ENT**] key to save the selection.
7. Press the [**16/9**] key to exit this mode.

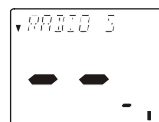

7 CONTROLS AND INDICATORS

NOTE

This section defines each control of the transceiver. See Figure 4 for location of controls. For detailed operating instructions refer to section “8 BASIC OPERATION.”

① CHANNEL SELECTOR KNOB

The rotary knob is used to select channels and to choose menu items (such as the DSC menu, radio setup menu, and DSC setup menu). The [UP(▲)] / [DOWN(▼)] keys on the microphone can also be used to select channels and menu items.

Secondary Use

While holding down the [SCAN] key and turning the **CHANNEL** selector knob, you can confirm memory channels for scanning.

② [WX] Key

Immediately recalls the previously selected NOAA weather channel from any channel.

Secondary use

Holding down the [16/9] key while pressing the [WX] key changes from USA, International and Canadian channel groups.

③ [16/9] Key

Immediately recalls channel 16 from any channel location and automatically selects high power. Holding down this key recalls channel 9. Pressing the [16/9] key again reverts to the previous selected working channel.

Secondary use

Press and hold the [16/9] key then press the [WX] key to switch between the USA, Canadian, and International Channel Groups.

④ POWER SWITCH / VOLUME CONTROL (VOL/PWR)

Turns the transceiver on and off as well as adjusts the audio volume.

Press and hold this knob for one second to turn the radio on. Clockwise rotation of this knob increases the audio volume level.

Press and hold this knob for two seconds to turn the radio off.

⑤ SQUELCH CONTROL (SQL)

Adjusting this control clockwise, sets the point at which random noise on the channel does not activate the audio circuits but a received signal will.

This point is called the squelch threshold. Further adjustment of the squelch control will degrade reception of wanted transmissions.

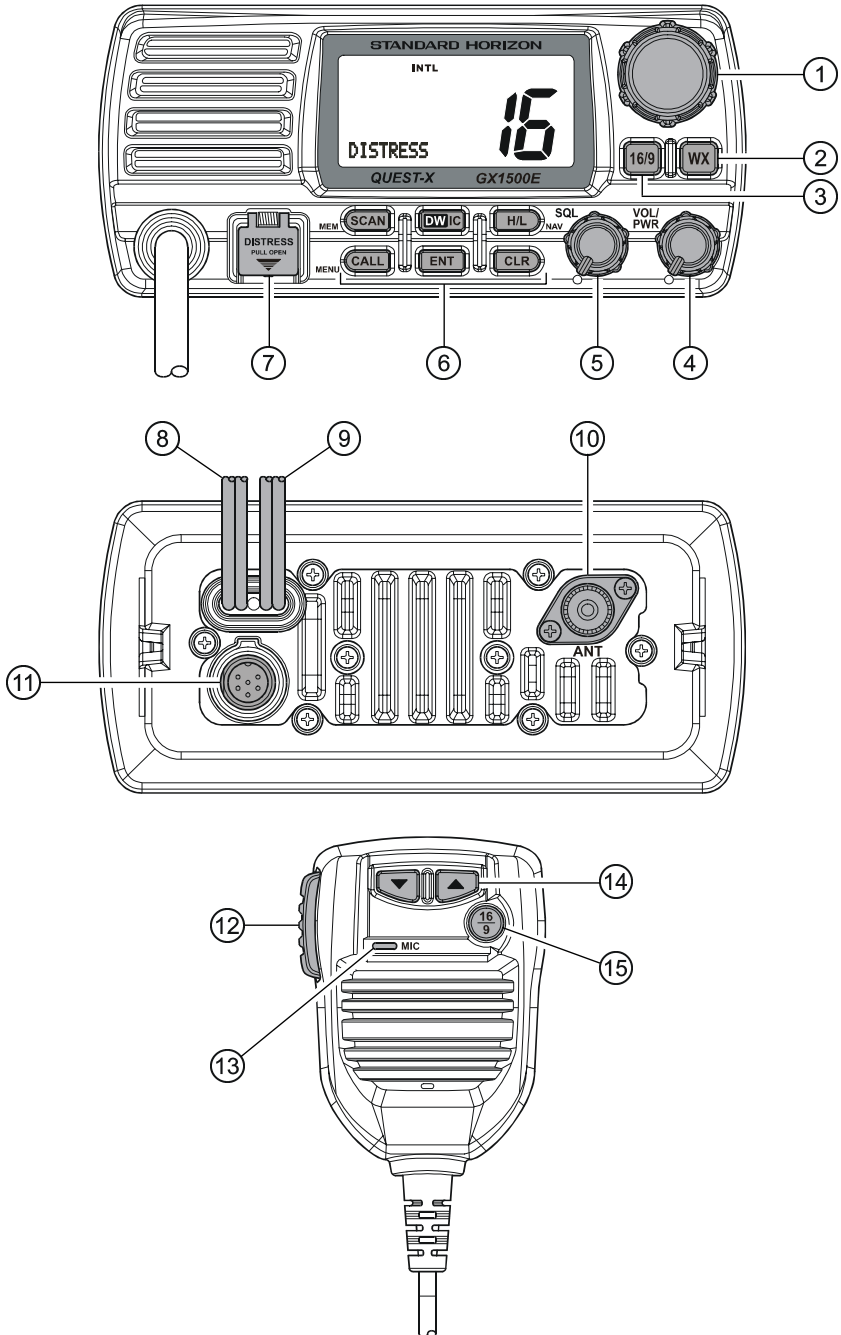

Figure 4. Controls and Connectors

⑥ KEYPAD

[SCAN(MEM)] Key

Press this key to start and stop the scanning of programmed channels. Refer to section “**9.12 SCANNING**” for details.

Secondary use

To add a channel into the scan memory, select the channel and press and hold the [SCAN(MEM)] key until “MEM” is shown on the display.

To delete a memorised channel from scan memory, select the channel and press and hold the [SCAN(MEM)] key until “MEM” is removed from the display.

[DW/IC)] Key

Pressing this key enables dual watch between a priority channel (Ch16 is the default) and a selected channel until a signal is received. When a signal is received on the selected channel the radio will momentarily switch to the Priority channel and listen for communications. Refer to section “**9.11 DUAL WATCH (TO PRIORITY CHANNEL)**” for details.

Secondary use

Press and hold this key, when the optional RAM+ Mic or **VH-310** Handset is connected, intercom operation will operate between radio and option mic or handset. Refer to section “**8.14 INTERCOM OPERATION**” for details.

[H/L(NAV)] Key

Press this key to toggle the transmit output power between 25 W (High) and 1 W (Low) power. When the [H/L(NAV)] key is pressed while the transceiver is on channel 13 or 67, the power will temporarily switch from LO to HI power until the **PTT** is released.

The [H/L(NAV)] key does not function on transmit inhibited and low power only channels.

NOTE: 1W low power is indicated by LO on the display, when 25W high power is selected the display do not show an indication.

Secondary use

Press and hold this key, the LCD displays NAV GPS Data, Time, SOG (Speed Over Ground), and COG (Course Over Ground) when a GPS is connected to the accessory cable of the **GX1500E**. See section “**6.3 ACCESSORY CABLE**” for details.

[CALL(MENU)] Key

Press the [CALL(MENU)] key to access the DSC OPERATION menu. The "INDIVIDUAL CALL," "GROUP CALL," and "ALL SHIPS CALL" functions can be accessed from the DSC OPERATION menu.

NOTE: Before the DSC OPERATION menu can be selected a MMSI must be entered. Refer to section "9.2 MARITIME MOBILE SERVICE IDENTITY (MMSI)."

Secondary use

Press and hold the [CALL(MENU)] key to access the "Radio Setup" (refer to section "10 RADIO SETUP MODE") or "DSC Setup" menu (refer to section "11 DIGITAL SELECTIVE CALLING").

[ENT] Key

Press the [ENT] Key to determine the menu selection.

[CLR] Key

Press the [CLR] Key to cancel the menu selection.

⑦ [DISTRESS] Key

Used to send a DSC Distress Call. To send the distress call refer to section "9.3.1 (Transmitting A DSC Distress Call)."

⑧ ACCESSORY CONNECTION CABLE

Connects the **GX1500E** to a GPS and an external speaker.

⑨ DC INPUT CABLE

Connects the radio to a DC power supply capable of delivering 12V DC.

⑩ ANTENNA JACK

Connects an antenna to the transceiver. Use a marine VHF antenna with an impedance of 50 ohms.

⑪ REMOTE MIC CONNECTOR

Connects the **GX1500E** to the enhanced RAM+ MIC (Remote Access Microphone) or the **VH-310** Handset. Refer to section "11 ENHANCED RAM+ MIC OPERATION" or "12 VH-310 HEADSET OPERATION" for details.

⑫ PTT (Push-To-Talk) SWITCH

Keys the transmitter when the transceiver is in radio mode. If the transceiver is in the intercom mode (between the RAM+ or **VH-310** Headset and the **GX1500E**), or PA mode, it activates the **GX1500E** microphone for voice communications.

⑬ **MICROPHONE**

Transmits the voice message with reduction of background noise, using Clear Voice Noise Reduction Technology.

NOTE: Be sure your mouth is about 1.5 cm from the mic hole for best performance.

⑭ **[UP(▲)] / [DOWN(▼)] KEYS**

The **[UP(▲)]** and **[DOWN(▼)]** on the microphone function the same as the **CHANNEL** selector knob on the front panel of the transceiver.

⑮ **[16/9] Key**

The **[16/9]** key on the microphone functions the same as the **[16/9]** key on the front panel of the transceiver.

Immediately recalls channel 16 from any channel location. Holding down this key recalls channel 9. Pressing the **[16/9]** key again reverts to the previous selected working channel.

8 BASIC OPERATION

8.1 RECEPTION

1. After the transceiver has been installed, ensure that the power supply and antenna are properly connected.
2. Press and hold the **VOL/PWR** knob until the radio turns on.
3. Turn the **SQL** knob fully counterclockwise. This state is known as “squelch off”.
4. Turn up the **VOL** knob until noise or audio from the speaker is at a comfortable level.
5. Turn the **SQL** knob clockwise until the random noise disappears. This state is known as the “squelch threshold.”
6. Turn the **CHANNEL** selector knob to select the desired channel. Refer to the channel chart on page 83 for available channels.
7. When a message is received, adjust the volume to the desired listening level. The “**BUSY**” indicator in the LCD is displayed indicating that the channel is being used.

8.2 TRANSMISSION

1. Perform steps 1 through 6 of RECEPTION.
2. Before transmitting, monitor the channel to ensure it is clear.
3. Press the **PTT** (push-to-talk) switch. The “**TX**” indicator in the LCD is displayed.
4. Speak slowly and clearly into the microphone.
5. When the transmission is finished, release the **PTT** switch.

NOTE

This is a noise canceling microphone. The oval slot on the bottom of microphone should be positioned within 1.5 cm from the mouth for optimum performance.

8.3 TRANSMIT TIME - OUT TIMER (TOT)

When the **PTT** switch on the microphone is held down, transmit time is limited to 5 minutes. This limits unintentional transmissions due to a stuck microphone. About 10 seconds before automatic transmitter shutdown, a warning beep will be heard from the speaker(s). The transceiver will automatically go to receive mode, even if the **PTT** switch is continually held down. Before transmitting again, the **PTT** switch must first be released and then pressed again.

NOTE

When a transmission was shut down by the TOT, the **GX1500E** can not transmit afterwards for 10 seconds.

8.4 SIMPLEX/DUPLEX CHANNEL USE

Refer to the VHF MARINE CHANNEL CHART (page 79) for instructions on use of simplex and duplex channels.

NOTE

All channels are factory-programmed in accordance with International, Industry Canada (Canada), and FCC (USA) regulations. Mode of operation cannot be altered from simplex to duplex or vice-versa.

8.5 INTERNATIONAL, USA, AND CANADA MODE

1. To change the modes, hold the [16/9] key and press the [WX] key. The mode changes from International to Canadian to USA with each press of the [WX] key.
2. “INTL” will be displayed for International mode, “CAN” will be displayed for Canadian mode, and “USA” will be displayed on the LCD for USA mode.
3. Refer to the VHF MARINE CHANNEL CHART (page 79) for allocated channels in each mode.

8.6 NOAA WEATHER CHANNELS

NOTE

NOAA Weather channels are available in the waters of USA and Canada only.

1. To receive a NOAA weather channel, press the [WX] key from any channel. The transceiver will go to the last selected weather channel.
2. Turn the **CHANNEL** selector knob on the radio or [UP(▲)] / [DOWN(▼)] keys on the microphone to select a different NOAA weather channel.
3. To exit from the NOAA weather channels, press the [WX] key. The transceiver returns to the channel it was on prior to a weather channel.

8.6.1 NOAA Weather Alert

In the event of extreme weather disturbances, such as storms and hurricanes, the NOAA (National Oceanic and Atmospheric Administration) sends a weather alert accompanied by a 1050 Hz tone and subsequent weather report on one of the NOAA weather channels. When the Weather Alert feature is enabled (see section “10.9 WX ALERT”), the transceiver is capable of receiving this alert if the following is performed:

1. Program NOAA weather channels into the transceiver’s memory for scanning. Follow the same procedure as for regular channels under section “9.12 SCANNING.”
2. Press the [SCAN] key once to start memory scanning or priority scanning (determined from the “Radio Setup” selection, see page 54 for details).

3. The programmed NOAA weather channels will be scanned along with the regular-programmed channels. However, scanning will not stop on a normal weather broadcast unless a NOAA alert is received.
4. When an alert is received on a NOAA weather channel, scanning will stop and the transceiver will emit a loud beep to alert the user of a NOAA broadcast.
5. Press the [WX] key to stop the alert tone and receive the weather report.

NOTE

If the [WX] key is not pressed the alert tone will be emitted for 5 minutes and then the weather report will be received.

NOTE

The Weather Alert feature is also engaged while the transceiver is receiving on one of the NOAA weather channels.

8.6.2 NOAA Weather Alert Testing

NOAA tests the alert system every Wednesday between 11AM and 1PM. To test the **GX1500E**'s NOAA Weather alert feature, on Wednesday between 11AM and 1PM, setup as in previous section and confirm the alert is heard.

8.7 EMERGENCY (CHANNEL 16 USE)

Channel 16 is known as the Hail and Distress Channel. An emergency is defined as a threat to life or property. In such instances, be sure the transceiver is on and set to CHANNEL 16. Then use the following procedure:

1. Press the microphone push-to-talk switch and say "**Mayday, Mayday, Mayday**. This is _____, _____, _____" (your vessel's name).
2. Then repeat once: "**Mayday, _____**" (your vessel's name).
3. Now report your position in latitude/longitude, or by giving a true or magnetic bearing (state which) to a well-known landmark such as a navigation aid or geographic feature such as an island or harbor entry.
4. Explain the nature of your distress (sinking, collision, aground, fire, heart attack, life-threatening injury, etc.).
5. State the kind of assistance your desire (pumps, medical aid, etc.).
6. Report the number of persons aboard and condition of any injured.
7. Estimate the present seaworthiness and condition of your vessel.
8. Give your vessel's description: length, design (power or sail), colour and other distinguishing marks. The total transmission should not exceed 1 minute.
9. End the message by saying "**OVER.**" Release the microphone button and listen.
10. If there is no answer, repeat the above procedure. If there is still no response, try another channel.

8.8 CALLING ANOTHER VESSEL (CHANNEL 16 OR 9)

Channel 16 may be used for initial contact (hailing) with another vessel.

However, its most important use is for emergency messages. This channel must be monitored at all times except when actually using another channel.

It is monitored by the European, U.S. and Canadian Coast Guards and by other vessels. **Use of channel 16 for hailing must be limited to initial contact only.** Calling should not exceed 30 seconds, but may be repeated 3 times at 2-minute intervals. In areas of heavy radio traffic, congestion on channel 16 resulting from its use as a hailing channel can be reduced significantly in U.S. waters by using **channel 9** as the initial contact (hailing) channel for non-emergency communications. Here, also, calling time should not exceed 30 seconds but may be repeated 3 times at 2-minute intervals.

Prior to making contact with another vessel, refer to the channel charts in this manual, and select an appropriate channel for communications after initial contact. For example, Channels 68 and 69 are some of the channels available to non-commercial (recreational) boaters. Monitor your desired channel in advance to make sure you will not be interrupting other traffic, and then go back to either channel 16 or 9 for your initial contact.

When the hailing channel (16 or 9) is clear, state the name of the other vessel you wish to call and then **“this is”** followed by the name of your vessel and your Station License (Call Sign). When the other vessel returns your call, immediately request another channel by saying **“go to,”** the number of the other channel, and **“over.”** Then switch to the new channel. When the new channel is not busy, call the other vessel.

After a transmission, say **“over,”** and release the microphone’s push-to-talk (PTT) switch. When all communication with the other vessel is completed, end the last transmission by stating your Call Sign and the word **“out.”** Note that it is not necessary to state your Call Sign with each transmission, only at the beginning and end of the contact.

Remember to return to Channel 16 when not using another channel. Some radios automatically monitor Channel 16 even when set to other channels or when scanning.

8.9 MAKING TELEPHONE CALLS

To make a radiotelephone call, use a channel designated for this purpose, The fastest way to learn which channels are used for radiotelephone traffic is to ask at a local marina. Channels available for such traffic are designated **Public Correspondence** channels on the channel charts in this manual. Some examples for USA use are Channels 24, 25, 26, 27, 28, 84, 85, 86, and 87. Call

the marine operator and identify yourself by your vessel's name, The marine operator will then ask you how you will pay for the call (telephone credit card, collect, etc.) and then link your radio transmission to the telephone lines.

The marine telephone company managing the VHF channel you are using may charge a link-up fee in addition to the cost of the call.

8.10 OPERATING ON CHANNELS 13 AND 67

Channel 13 is used at docks and bridges and by vessels manoeuvring in port. Messages on this channel must concern navigation only, such as meeting and passing in restricted waters.

Channel 67 is used for navigational traffic between vessels.

By regulation, power is normally limited to 1 Watt on these channels. Your radio is programmed to automatically reduce power to this limit on these channels. However, in certain situations it may be necessary to temporarily use a higher power. See page 18 ([H/L(NAV)] key) for means to temporarily override the low-power limit on these two channels.

8.11 DUAL WATCH (TO PRIORITY CHANNEL)

Dual watch allows the radio to monitor one channel and the assigned Priority channel. By default the priority channel is set to 16, however the priority channel may be changed by referring to section “10.6 PRIORITY CHANNEL SET.”

1. Adjust the **SQL** knob until the background noise disappears.
2. Select the channel you wish to dual watch to “Priority channel.”
3. Press the [DW(IC)] key.

The display will scan between Priority channel and the channel that was selected in step 2.

If a transmission is received on the channel selected in step 2, the **GX1500E** will dual watch between the working channel and the Priority channel.

4. To stop Dual Watch, press the [DW(IC)] key again.

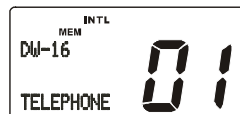

8.12 SCANNING

Allows the user to select the scan type from Memory scan or Priority scan. “Memory scan” scans the channels that were programmed into memory. “Priority scan” scans the channels programmed in memory with the priority channel.

8.12.1 Selecting the Scan Type

1. Press and hold down the [CALL(MENU)] key until “Radio Setup” menu appears.
2. Press the [ENT] key, then select “SCAN Type” in the “Radio Setup” menu with the CHANNEL selector knob.
3. Press the [ENT] key.
4. Turn the CHANNEL selector knob to select “Priority” or “Memory.”
5. Press the [ENT] key to store the selected setting.
6. To exit this menu and return to radio operation mode press the [16/9] key.



8.12.2 Memory Scanning (M-SCAN)

1. Adjust the SQL knob until background noise disappears.
2. Select a desired channel to be scanned using the CHANNEL selector knob. Press and hold the [SCAN(MEM)] key for one second, “MEM” will appear on the LCD which indicates the channel has been programmed into the transceivers memory.
3. Repeat step 2 for all the desired channels to be scanned.
4. To DELETE a channel from the transceiver’s memory, select the channel then press and hold the [SCAN(MEM)] key for one second, “MEM” will disappear in the LCD.
5. To start scanning, just press the [SCAN(MEM)] key momentarily. “M-SCAN” appears on the LCD. Scanning will proceed from the lowest to the highest programmed channel number and will stop on a channel when a transmission is received.
6. The channel number will blink during reception.
7. To stop scanning, press the [16/9] or [WX] key.

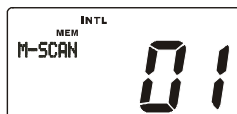
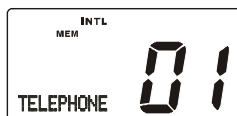

8.12.3 Priority Scanning (P-SCAN)

In the default setting, Channel 16 is set as the priority channel. You may change the priority channel to the desired channel from the Channel 16 by the Radio Setup Mode, refer to section “10.6 PRIORITY CHANNEL SET.”

1. Adjust the **SQL** knob until background noise disappears.
2. Select a desired channel to be scanned using the **CHANNEL** selector knob. Press and hold the [**SCAN(MEM)**] key for one second, “MEM” will appear on the display which indicates the channel has been programmed into the transceivers memory.
3. Repeat step 2 for all the desired channels to be scanned.
4. To DELETE a channel from the transceiver’s memory, select the channel then press and hold the [**SCAN(MEM)**] key until “MEM” is removed from the display.
5. To start priority scanning, just press the [**SCAN(MEM)**] key momentarily. “P-SCAN” appears on the LCD. Scanning will proceed between the memorized channels and the priority channel. The priority channel will be scanned after each programmed channel.
6. To stop scanning, press the [**16/9**] or [**WX**] key.

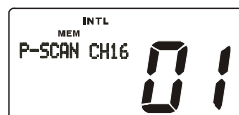
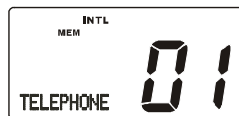

You may change the scan resume time in the Radio Setup Mode, refer to section “10.8 SCAN RESUME TIME.”

8.13 NAVIGATION INDICATION

The transceiver has the ability to display Time, SOG, COG, as well as the position (LAT/LON), when connected to a GPS receiver.

1. Press and hold the [**H/L(NAV)**] key, display the position information on the LCD. If the GPS receiver is not receiving a fix, the display will be as shown in the illustration on the right.
- NOTE:** When Ch16 is selected only lat/lon will shown.
2. To hide the position information, press and hold the [**H/L(NAV)**] key again.

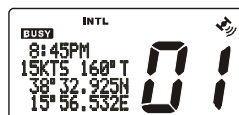

8.14 INTERCOM OPERATION

Connecting a **CMP25 RAM+** or **VH-310** handset to the **GX1500E** allows intercom communications. Refer to section “**11.2 INTERCOM OPERATION**” for **CMP25 RAM+** Microphone or section “**12.2 INTERCOM OPERATION**” for **VH-310** Handset.

8.14.1 Communication

1. Press and hold the **[DW(IC)]** key, the mode is changed to “INTERCOM” mode.
2. When the “INTERCOM” is activated, “Intercom” is displayed on the **GX1500E**, and “IC” is displayed on the RAM+ Mic or **VH-310** Handset.
3. Press the **PTT** switch. “Talk” will be shown on the display.



NOTE: A warning beep will be emitted when the **GX1500E** microphone’s **PTT** switch is pressed while the RAM+ Mic’s or **VH-310** Handset’s **PTT** switch is pressed.



(GX1500E’s PTT switch is pressed)

4. Speak slowly and clearly into the microphone, hold the microphone about 1.5 cm away from your mouth.
5. When finished, release the **PTT** switch.
6. To exit the “INTERCOM” mode and return to radio operation mode, press the **[16/9]** or **[CLR]** key.



(RAM+ Mic’s PTT switch is pressed)

8.14.2 Calling

While in INTERCOM mode, pressing and holding the **[DW(IC)]** key on the **GX1500E**, **CMP25** or **VH-310** will produce a calling beep [at the other station.

9 DIGITAL SELECTIVE CALLING

9.1 GENERAL

WARNING

This radio is designed to generate a digital maritime distress and safety call to facilitate search and rescue. To be effective as a safety device, this equipment must be used only within communication range of a shore-based VHF marine channel 70 distress and safety watch system. The range of signal may vary but under normal conditions should be approximately 20 nautical miles.

Digital Selective Calling is a semi-automated method of establishing a radio call, it has been designated by the International Maritime Organization (IMO) as an international standard for establishing VHF, MF, and HF radio calls. It has also been designated as part of the Global Maritime Distress and Safety System (GMDSS). It is planned that DSC will eventually replace aural watches on distress frequencies and will be used to announce routine and urgent maritime safety information broadcasts.

This new system allows mariners to instantly send a distress call with GPS position (when connected to the transceiver) to the Coast Guard and other vessels within range of the transmission. DSC will also allow mariners to initiate or receive Distress, Urgency, Safety, Routine, POSITION REQUEST, POSITION SEND, and Group calls to or from another vessel equipped with a DSC transceiver.

9.2 MARITIME MOBILE SERVICE IDENTITY (MMSI)

9.2.1 What is an MMSI?

An MMSI is a nine digit number used on Marine Transceivers capable of using Digital Selective Calling (DSC). This number is used like a telephone number to selectively call other vessels.

THIS NUMBER MUST BE PROGRAMMED INTO THE RADIO TO OPERATE THE GX1500E DSC FUNCTIONS.

How can I obtain an MMSI assignment?

Please contact the Radio Licensing Authority for your country for information on how to obtain an MMSI number.

9.2.2 Programming the MMSI

WARNING

A User MMSI can be input only once. If the user tries to input an MMSI more than once the radio will show the display on the right. Therefore, ***please be careful not to input the incorrect MMIS number.*** If the user needs to change the MMSI number after it has been entered, the radio will have to be returned to Factory Service. Refer to the section “13.2. FACTORY SERVICE.”



1. Press and hold down the [CALL(MENU)] key until the “Radio Setup” menu appears.
2. Turn the **CHANNEL** selector knob to the left to select “DSC Setup” menu.
3. Press the [ENT] key, then select “User MMSI” with the **CHANNEL** selector knob.
4. Press the [ENT] key. The display will show a series of dashes.
5. Turn the **CHANNEL** selector knob or press the [UP(▲)] / [DOWN(▼)] key on the microphone to select the first number of your MMSI, then press the [ENT] key to step to the next number.
6. Repeat step 5 to set your MMSI (up to nine digits).
7. When finished programming the number, press and hold the [ENT] key until the confirmation message appears.
8. Press the [ENT] key to store the number in memory and return to radio operation mode.

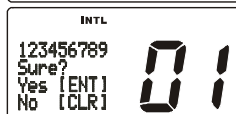
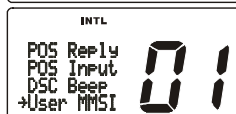
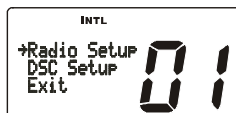

9.3 DISTRESS ALERT

The **GX1500E** is capable of transmitting and receiving DSC Distress messages to all DSC radios. The **GX1500E** may be connected to a GPS to also transmit the Latitude and Longitude of the vessel.

9.3.1 Transmitting a Distress Alert

NOTE

To be able to transmit a Distress Alert an MMSI number must be programmed, refer to section “9.2.2 Programming the MMSI.”

In order for your vessels location to be transmitted either connect a GPS to the **GX1500E** (refer to section “6.3 ACCESSORY CABLE”) or manually input your position (refer to section “9.9 MANUAL INPUTTING OF THE GPS LOCATION”).

1. Lift the red spring loaded DISTRESS cover, then press and hold the [DISTRESS] key. The “DISTRESS” menu will appear on the LCD and the radios display will count down (5-4-3-2-1) and then transmit the Distress Alert. The backlight of the LCD and keypad flashes while the radios display is countdown.
2. When the distress signal is sent, CH70 and the “TX” icon will appear on the LCD.

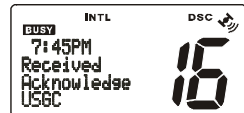
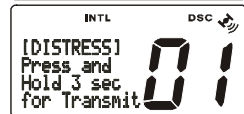

3. The transceiver will watch for a DSC acknowledgment transmission on CH70 and also receive calls on CH16.
4. If an acknowledgement is received, select channel 16 and advise your distress situation.
5. If no acknowledgment is received, the Distress Alert is repeated at approximately 4 minute intervals until a DSC acknowledgment is received.
6. When a DSC Distress acknowledgment is received, a DSC Distress Alarm sounds and channel 16 is automatically selected. The LCD shows the MMSI of the ship responding to your distress.
RECEIVED ACK: acknowledgment signal is received.
RECEIVED RLY ACK: relay acknowledgment signal is received from another vessel or coast station.
7. To cancel the DSC Distress Alarm signal from the speaker, press any key.

Transmitting a Distress Alert with Nature of Distress

The **GX1500E** is capable of transmitting a Distress Alert with the following “Nature of Distress” categories:

Undesignated, Fire, Flooding, Collision, Grounding, Capsizing, Sinking, Adrift, Abandoning, Piracy, Mob

1. Lift the red spring loaded DISTRESS cover and press the **[DISTRESS]** key. The “**DISTRESS**” menu will appear on the LCD.
2. Turn the **CHANNEL** selector knob to select the desired nature of distress category.
3. Press and hold the **[DISTRESS]** key. The radios display will count down (5-4-3-2-1) and then transmit the Distress Alert. The backlight of the LCD and keypad flashes while the radios display is countdown.
4. When the distress signal is sent, CH70 and “**TX**” icon will appear on the LCD.
5. The transceiver will watch for a DSC acknowledgment transmission on CH70 and also receive calls on CH16.
6. If an acknowledgement is received, select channel 16 and advise your distress situation.
7. If no acknowledgment is received, the Distress Alert is repeated in 4 minute intervals until a DSC acknowledgment is received.
8. When a DSC Distress acknowledgment is received, a distress alarm sounds and channel 16 is automatically selected. The LCD shows the MMSI of the ship responding to your distress.

RECEIVED ACK: acknowledgment signal is received.

RECEIVED RLY ACK: relay acknowledgment signal is received from another vessel or coast station.

9. To cancel the DSC distress alarm signal from the speaker, press any key.

Cancel a Distress Alert

In order to cancel the repeat call function of the DSC, press the **[CLR]** key, then press the **[ENT]** key.

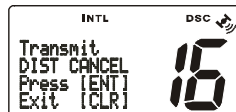
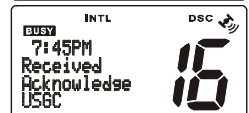
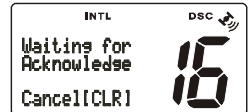

9.3.2 Receiving a Distress Alert

1. When a Distress Alert is received, an emergency alarm sounds.
Then channel 16 is automatically selected.
2. Press any key to stop the alarm.
3. Turn the **CHANNEL** selector knob to change the display to show the position of the vessel in distress.
4. If the position of the vessel distress data does not include position, the LCD will show the display on the right.

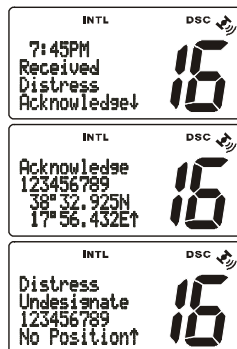

NOTE

When there is an unread Distress Alert, the “DSC” icon will blink. You may review the unread Distress Alert from the DSC Log, refer to section “9.6.2 Reviewing Received Calls Logged into the Call Waiting Directory.”

NOTE

You must continue monitoring channel 16 as a coast station may require assistance in the rescue attempt.

9.3.3 Distress Relay

The Distress Relay allows you to send (relay) the received Distress Alert to other vessel.

1. Press the [CALL(MENU)] key. The “DSC Operation” menu will appear.
2. Turn the **CHANNEL** selector knob to select “DSC Log” menu.
3. Press the [ENT] key, then select “Distress” with the **CHANNEL** selector knob.
4. Press the [ENT] key, then select the station (name or MMSI number) to be sent (relay) the received Distress Alert with the **CHANNEL** selector knob.
5. Press the [ENT] key.
6. Turn the **CHANNEL** selector knob to select the “Individual” you want to send (relay) the received Distress Alert, if you have already set up the Individual Directory (refer to section “9.5.1 Setting up the Individual / Position Call Directory” for setting) or “Manual,” then press the [ENT] key.

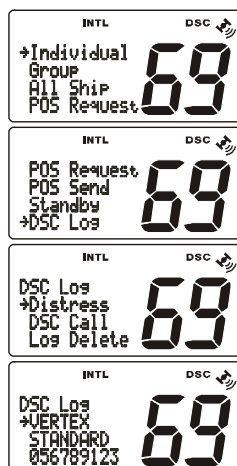

- When “Manual” is selected at the previous step, enter the MMSI number (nine digits) to which you want to send (relay) the received Distress Alert. To do this, turn the **CHANNEL** selector knob to scroll through numbers “0-9,” then press the [ENT] key to move the entry location to the right. If a mistake was made entering in the MMSI number repeat pressing the [H/L(NAV)] key until the wrong number is selected, then move the channel knob to correct the entry. When finished entering the MMSI number, press and hold the [ENT] key.
- Press the [ENT] key again to transmit the Distress Relay signal.

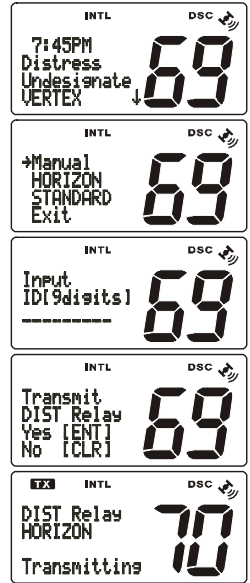

9.4 ALL SHIPS CALL

The All Ships Call function allows contact to be established with other vessel stations without having their ID in the individual calling directory. Also, priority for the call can be designated as Agency or Safety.

URGENCY Call: This type of call is used when a vessel may not truly be in distress, but have a potential problem that may lead to a distress situation. This call is the same as saying PAN PAN PAN on channel 16.

SAFETY Call: Used to transmit boating safety information to other vessels. This message usually contains information about an overdue boat, debris in the water, loss of a navigation aid or an important meteorological message. This call is the same as saying Securite, Securite, Securite.”

9.4.1 Transmitting an All Ships Call

- Press the [CALL(MENU)] key. The “DSC Operation” menu will appear.
- Turn the **CHANNEL** selector knob to select “All Ships.”
- Press the [ENT] key. (To cancel, turn the **CHANNEL** selector knob to select “Exit.”)
- Turn the **CHANNEL** selector knob to select the call (“Agency” or “Safety”), then press the [ENT] key.

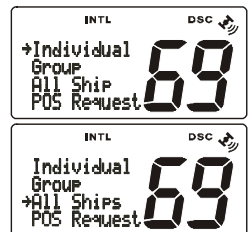

5. Press the [ENT] key again to transmit the selected type of all ships DSC call.
6. After the ALL SHIPS CALL is transmitted, the transceiver will switch to CH16.
7. Listen to the channel to make sure it is not busy, then key the microphone and say PAN PAN PAN or "Securite, Securite, Securite" depending on the priority of the call. Say your call sign and announce the channel you wish to switch to for communications.



9.4.2 Receiving an All Ships Call

1. When an all ships call is received, an emergency alarm sounds.
The radio will automatically change to channel 16.
2. Press any key to stop the alarm.
3. Turn the **CHANNEL** selector knob to see the MMSI of the vessel transmitting the All Ships Call.
4. Monitor channel 16 or traffic channel until the URGENCY voice communication is completed.



NOTE

When there is an unread All Ship Call, the "DSC" icon will blink. You may review the unread All Ship Call from the DSC Log, refer to section "9.6.2 Reviewing Received Calls Logged into the Call Waiting Directory."

9.5 INDIVIDUAL CALL

This feature allows the **GX1500E** to contact another vessel with a DSC VHF radio and automatically switch the receiving radio to a desired communications channel. This feature is similar to calling a vessel on CH16 and requesting to go to another channel (switching to the channel is private between the two stations).

9.5.1 Setting up the Individual / Position Call Directory

The **GX1500E** has a DSC directory that allows you to store a vessel or person's name and the MMSI number associated with vessels you wish to transmit Individual calls, Position Requests and Position Send transmissions.

To transmit an Individual call you must program this directory with the information of the persons you wish to call, similar to a cellular phones directory.

1. Press and hold down the **[CALL(MENU)]** key until "Radio Setup" menu appears.
2. Turn the **CHANNEL** selector knob to select "DSC Setup" menu.
3. Press the **[ENT]** key, then select "INDIV DIR" with the **CHANNEL** selector knob.
4. Press the **[ENT]** key, then select "Add" with the **CHANNEL** selector knob.
5. Press the **[ENT]** key.
6. Turn the **CHANNEL** selector knob to scroll to the first letter of the name of the vessel or person you want to list in the directory.
7. Press the **[ENT]** key to store the first letter of the name and step to the next letter to the right.
8. Repeat step 6 and 7 until the name is complete. The name can consist of up to eleven characters, if you do not use all eleven characters press the **[ENT]** key to move to the next space. This method can also be used to enter a blank space in the name. To clear the previous letter, press the **[CLR]** key.
9. After the eleventh letter or space has been entered, press and hold the **[ENT]** key to advance to the MMSI Maritime Mobile Service Identity Number number entry.
10. Turn the **CHANNEL** selector knob to scroll through numbers, 0-9. To enter the desired number and move one space to the right press the **[ENT]** key. Repeat this procedure until all nine spaces of the MMSI number are entered.

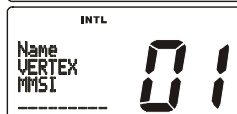
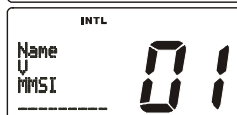

11. If a mistake was made entering in the name or the MMSI number repeat pressing the **[H/L(NAV)]** key until the wrong character is selected, then move the channel knob to correct the entry.
12. To store the data entered, press and hold the **[ENT]** key.
13. To enter another individual address, repeat steps 4 through 12.
14. To exit this menu and return to radio operation mode press the **[16/9]** key.

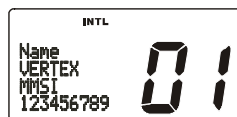

NOTE

Selecting “Next” or “Exit” will automatically save the name and MMSI number into memory.

9.5.2 Setting up Individual Reply

Allows setting up the radio to automatically (default setting) or manually respond to a DSC Individual call requesting you to switch to a working channel for voice communications. When Manual is selected the MMSI of the calling vessel is shown allowing you to see who is calling. This function is similar to caller id on a cellular phone.

1. Press and hold down the **[CALL(MENU)]** key until “Radio Setup” menu appears.
2. Turn the **CHANNEL** selector knob to select “DSC Setup” menu.
3. Press the **[ENT]** key, then select “INDIV Reply” with the **CHANNEL** selector knob.
4. Press the **[ENT]** key.
5. Turn the **CHANNEL** selector knob to select “Auto” or “Manual.”
6. Press the **[ENT]** key to store the selected setting.
7. To exit this menu and return to radio operation mode press the **[16/9]** key.



9.5.3 Setting up the Individual/Group Call Ringer

When a Individual Call or Group Call is received the radio will produce a ringing tone for 3 minutes. This selection allows the Individual Call ringer time to be changed.

1. Press and hold down the [**CALL(MENU)**] key until “Radio Setup” menu appears.
2. Turn the **CHANNEL** selector knob to select “DSC Setup” menu.
3. Press the [**ENT**] key, then select “INDIV Ring” with the **CHANNEL** selector knob.
4. Press the [**ENT**] key.
5. Turn the **CHANNEL** selector knob to select ringing time of a Individual Call.
6. Press the [**ENT**] key to store the selected setting.
7. To exit this menu and return to radio operation mode press the [**16/9**] key.

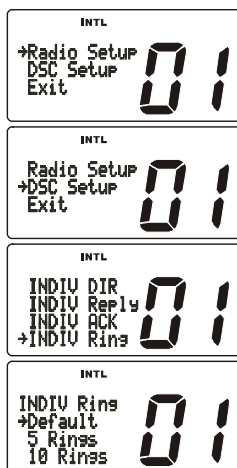

The **GX1500E** has the capability to turn off the Individual call ringer.

1. Press and hold down the [**CALL(MENU)**] key until “Radio Setup” menu appears.
2. Turn the **CHANNEL** selector knob to select “DSC Setup” menu.
3. Press the [**ENT**] key, then select “DSC Beep” with the **CHANNEL** selector knob.
4. Press the [**ENT**] key.
5. Turn the **CHANNEL** selector knob to select “Individual” if you wish to disable the Individual Call ringer, or “Group” if you wish to disable the Group Call ringer and press the [**ENT**] key.
6. Turn the **CHANNEL** selector knob to select “Off.”
7. Press the [**ENT**] key to store the selected setting.
8. To exit this menu and return to radio operation mode press the [**16/9**] key.

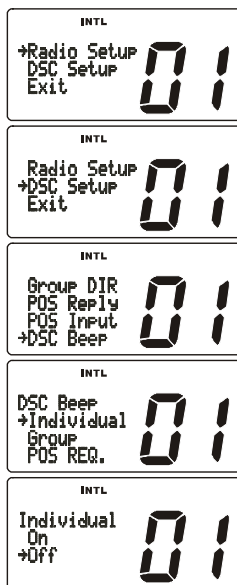

If you wish to return to enabling the ringer tone, just repeat the above procedure, turning the **CHANNEL** selector knob to select “On” in step “6” above.

9.5.4 Transmitting an Individual Call

This feature allows the user to contact another vessel with a DSC radio. This feature is similar to calling a vessel on CH16 and requesting to go to another channel.

Pre-Programmable Calling

1. Press the [**CALL(MENU)**] key. The “DSC Operation” menu will appear.
2. Turn the **CHANNEL** selector knob to select “Individual.” (To cancel, select “Exit” with the **CHANNEL** selector knob or press the [**16/9**] key.)
3. Press the [**ENT**] key. The transceiver will beep, and the “Individual directory” will appear.
4. Turn the **CHANNEL** selector knob to select the “Individual” you want to contact.
5. Press the [**ENT**] key, then turn the **CHANNEL** selector knob to select the operating channel you want to communicate on and press the [**ENT**] key.
6. Press the [**ENT**] key again to transmit the individual DSC signal.
7. After INDIVIDUAL CALL is transmitted, the transceiver will wait 8 seconds for the acknowledgment. If the reply signal is not received, the transceiver will transmit again.
8. After the second INDIVIDUAL CALL is transmitted, if the reply signal is not received, the display will be as shown in the illustration on the right. To send the call again, press the [**ENT**] key.
9. When an individual call acknowledgment is received, the established channel is automatically changed to the channel which is selected on step 5 above and a ringing tone sounds.
10. Press any key to listen to the channel to make sure it is not busy, then key the microphone and call the other vessel you desire to communicate with.

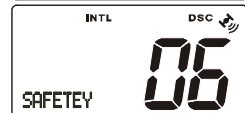
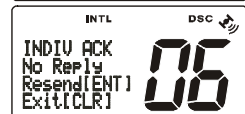
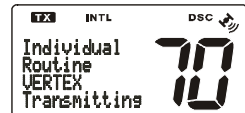

Manual Calling

You may enter an MMSI number manually to contact without storing it in the Individual Directory.

1. Press the **[CALL(MENU)]** key. The “DSC Operation” menu will appear.
2. Turn the **CHANNEL** selector knob to select “Individual.” (To cancel, select “Exit” with the **CHANNEL** selector knob or press the **[16/9]** key.)
3. Press the **[ENT]** key. The transceiver will beep, and the “Individual directory” will appear.
4. Turn the **CHANNEL** selector knob to select “Manual,” then press the **[ENT]** key.
5. Turn the **CHANNEL** selector knob to scroll through numbers, 0-9. To enter the desired number and move one space to the right, press the **[ENT]** key. Repeat this procedure until all nine spaces of the MMSI number which you want to contact are entered.
6. If a mistake was made entering in the MMSI number repeat pressing the **[H/L(NAV)]** key until the wrong number is selected, then move the channel knob to correct the entry.
7. When finished entering the MMSI number, press and hold the **[ENT]** key.
8. Press the **[ENT]** key, then turn the **CHANNEL** selector knob to select the operating channel you want to communicate on and press the **[ENT]** key.
9. Press the **[ENT]** key again to transmit the individual DSC signal.
10. After INDIVIDUAL CALL is transmitted, the transceiver will wait 8 seconds for the acknowledgment. If the reply signal is not received, the transceiver will transmit again.
11. After the second INDIVIDUAL CALL is transmitted, if the reply signal is not received, the display will be as shown in the illustration on the right. To send the call again, press the **[ENT]** key or to exit the mode, press the **[CLR]** key.
12. When an individual call acknowledgment is received, the established channel is automatically changed to the channel which is selected on step 5 above and a ringing tone sounds.

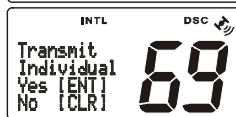
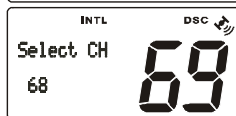
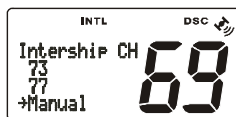

- Press any key to listen to the channel to make sure it is not busy, then key the microphone and call the other vessel you desire to communicate with.



9.5.5 Receiving an Individual Call

When receiving an individual call, an acknowledgment must be sent back to the calling station. The **GX1500E** default setting is Automatic, but has a selection that allows you to manually send a reply before the radio will switch to the requested calling channel. This selection is useful if you want to see who is calling and requesting you to switch to a channel for communications, similar to caller id on a cellular phone.

- When an individual call is received, an individual call ringing alarm sounds. The radio automatically switches to the requested channel.
- Press any key to stop the alarm.
- Press the **PTT** on the mic and talk to the calling ship.

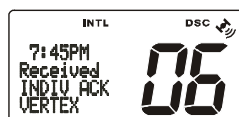

9.6 CALL WAITING DIRECTORY

The **GX1500E** logs received distress calls and individual calls. The DSC Call Waiting feature is similar to an answer machine where calls are recorded for review. When a call is logged while the radio is set on the DSC Standby function, a message will appear on the LCD. The **GX1500E** can memorise the latest 23 Distress and up to the latest 56 DSC Calls.

9.6.1 Enabling/Disabling the Call Waiting Feature

Follow the steps below to enable or disable the Call Waiting feature.

- Press and hold down the [**CALL(MENU)**] key until "Radio Setup" menu appears.
- Turn the **CHANNEL** selector knob to select "DSC Setup" menu.
- Press the [**ENT**] key, then select "INDIV ACK" with the **CHANNEL** selector knob.
- Press the [**ENT**] key.
- Turn the **CHANNEL** selector knob to select "Able" or "Unable."
- Press the [**ENT**] key to store the selected setting.
- To exit this menu and return to radio operation mode press the [**16/9**] key.



9.6.2 Reviewing Received Calls Logged into the Call Waiting Directory

1. Press the [CALL(MENU)] key. The “DSC Operation” menu will appear.
2. Turn the **CHANNEL** selector knob to select “DSC Log” menu.
3. Press the [ENT] key, then turn the **CHANNEL** selector knob to select the category (“Distress” or “DSC Call”) you want to review and/or call back.
4. Press the [ENT] key, then turn the **CHANNEL** selector knob to select the station (name or MMIS number) you want to review and/or call back.
5. Press the [ENT] key, to review details for the selected station.
6. Press the [ENT] key again, to call the selected station.

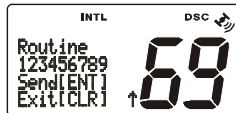
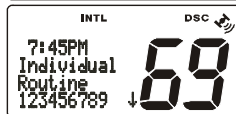

NOTE

When there is an unread received call, the category (“Distress” or “DSC Call”) notation will blink.

9.6.3 To Delete the Received Log from the “DSC Log” Directory

1. Press the [CALL(MENU)] key. The “DSC Operation” menu will appear.
2. Turn the **CHANNEL** selector knob to select “DSC Log” menu.
3. Press the [ENT] key, then turn the **CHANNEL** selector knob to select “Log Delete.”
4. Press the [ENT] key, then turn the **CHANNEL** selector knob to select the category (“Distress” or “DSC Call”) to be deleted.
5. Press the [ENT] key, then turn the **CHANNEL** selector knob to select the station (name or MMIS number) to be deleted.
6. Press and hold the [ENT] key until the station (name or MMIS number) is removed from the display.
7. To exit this menu and return to radio operation mode press the [16/9] key.



9.7 GROUP CALL

This feature allows the user to contact a group of specific vessels (example members of a yacht club) with a group MMSI number using the Group call function to automatically switch to a desired channel for voice communications.

9.7.1 Setting up a Group Call

For this function to operate the same Group MMSI must be programmed into all the DSC VHF radios within the group of vessels that will be using this feature. The group MMSI is a 9 digit (first digit permanently set to "0") number that will allow other radios to call your vessel along with others to automatically switch to a working channel for voice communications. This function is very useful for yacht clubs and vessels traveling together that want to collectively make announcements on a predetermined channel.

1. Press and hold down the **[CALL(MENU)]** key until "Radio Setup" menu appears.
2. Turn the **CHANNEL** selector knob to select "DSC Setup" menu.
3. Press the **[ENT]** key, then select "Group DIR" with the **CHANNEL** selector knob.
4. Press the **[ENT]** key, then select "Add" with the **CHANNEL** selector knob.
5. Press the **[CALL(MENU)]** key.
6. Turn the **CHANNEL** selector knob to scroll through the first letter of the name of the vessel or person you want to reference in the directory.
7. Press the **[ENT]** key to store the first letter in the name and step to the next letter to the right.
8. Repeat step 6 and 7 until the name is complete. The name can consist of up to eleven characters, if you do not use all eleven characters press the **[ENT]** key to move to the next space. This method can also be used to enter a blank space in the name. To clear the previous letter, press the **[CLR]** key.
9. After the eleventh letter or space has been entered, press and hold the **[ENT]** key to advance to the MMSI (Maritime Mobile Service Identity Number) number entry.
10. Turn the **CHANNEL** selector knob to scroll through numbers, 0-9. To enter the desired number and move one space to the right press the **[ENT]** key. Repeat this procedure until all nine space of the MMSI number are entered.

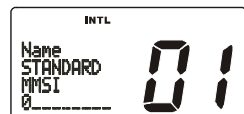
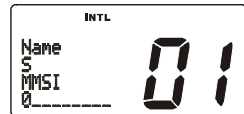
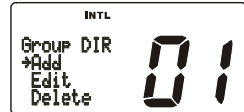

11. If a mistake was made entering in the name or the MMSI number repeat pressing the **[H/L(NAV)]** key until the wrong character is selected, then move the channel knob to correct the entry.
12. To store the data entered, press and hold the **[ENT]** key.
13. To enter another individual address, repeat steps 4 through 12.
14. To exit this menu and return to radio operation mode press the **[16/9]** key.



9.7.2 Transmitting a Group Call

Pre-Programmable Calling

1. Press the **[CALL(MENU)]** key. The “DSC Operation” menu will appear.
2. Turn the **CHANNEL** selector knob to select “Group.” (To cancel, select “Exit” with the **CHANNEL** selector knob or press **[16/9]** key.)
3. Press the **[ENT]** key. The transceiver will beep, and the “Group Directory” will appear.
4. Turn the **CHANNEL** selector knob to select the “Group” you want to contact.
5. Press the **[ENT]** key, then turn the **CHANNEL** selector knob to select the operating channel you want to communicate on and press the **[ENT]** key.
6. Press the **[ENT]** key again to transmit the Group Call signal.
7. After the GROUP CALL is transmitted, all the radios in the group will switch to the designated channel.
8. Listen to the channel to make sure it is not busy, then key the microphone and call the other vessels you desire to communicate with.



Manual Calling

You may enter an MMSI number manually to contact without the Setting up the Group call number.

1. Press the [CALL(MENU)] key. The “DSC Operation” menu will appear.
2. Turn the **CHANNEL** selector knob to select “Group.” (To cancel, select “Exit” with the **CHANNEL** selector knob or press [16/9] key.)
3. Press the [ENT] key. The transceiver will beep, and the “Group Directory” will appear.
4. Turn the **CHANNEL** selector knob to select “Manual,” then press the [ENT] key.
5. Turn the **CHANNEL** selector knob to scroll through numbers, 0-9. To enter the desired number and move one space to the right press the [ENT] key. Repeat this procedure until all nine space of the MMSI number which you want to contact are entered.
6. If a mistake was made entering in the MMSI number repeat pressing the [H/L(NAV)] key until the wrong number is selected, then move the channel knob to correct the entry.
7. When finish the entering the MMSI number, press and hold the [ENT] key.
8. Press the [ENT] key to transmit the Group Call signal.
9. After the GROUP CALL is transmitted, all the radios in the group will switch to the designated channel.
10. Listen to the channel to make sure it is not busy, then key the microphone and call the other vessels you desire to communicate with.

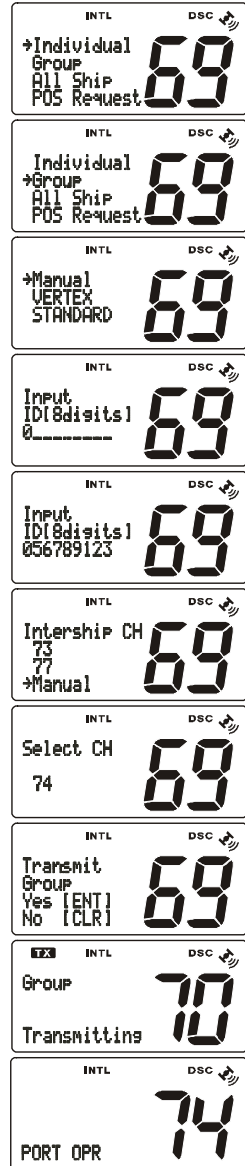

9.7.3 Receiving a Group Call

1. When a group call is received, the **GX1500E** will produce a ringing alarm sound.
2. The radio automatically switches to the requested channel.
3. Press any key to stop the alarm.
4. Monitor the channel for the person calling the Group for a message.
5. If you want to respond, monitor the channel to make sure it is clear, then press the **PTT** on the mic and talk to the calling ship(s).

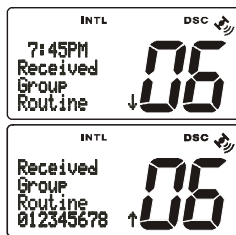

NOTE

When there is an unread Group Call, the “DSC” icon will blink. You may review the unread Group Call from the DSC Log, refer to section “9.6.2 Reviewing Received Calls Logged into the Call Waiting Directory.”

NOTE

After a Group call is received, the time the call was made and the ships MMSI or vessels name will appear on the LCD.

9.8 POSITION REQUEST

Advancements in DSC have made it possible to poll the location of another vessel and show the position of that vessel on the display of the **GX1500E**. Standard Horizon has taken this feature one step further, if any Standard Horizon GPS is connected to the **GX1500E**, the polled position of the vessel is shown on the display of the GPS chart plotter making it easy to navigate to the location of the polled vessel. This is a great feature for anyone wanting to know the position of another vessel. For example your friend that is catching fish, or finding the location of a person you are cruising with.

NOTE

The other vessel must have an operating GPS receiver connected to its DSC transceiver and must not have its transceiver set to deny position requests. (Refer the section “**9.5.1 Setting up the Individual / Position Call Directory**” to enter information into the individual directory).

9.8.1 Setting up Position Reply

The **GX1500E** can be set up to automatically or manually send your position to another vessel. This selection is important if you are concerned about someone polling the position of your vessel that you may not want to. In the manual mode you will see the MMSI or persons name shown on the display allowing you to choose to send your position to the requesting vessel.

1. Press and hold down the [**CALL(MENU)**] key until “Radio Setup” menu appear.
2. Turn the **CHANNEL** selector knob to select “DSC Setup” menu.
3. Press the [**ENT**] key, then select “POS Reply” with the **CHANNEL** selector knob.
4. Press the [**ENT**] key.
5. Turn the **CHANNEL** selector knob to select “Auto” or “Manual.” In “Auto” mode, after a DSC POS Request is received, the radio will automatically transmit your vessels position. In “Manual” mode, the display of the **GX1500E** will show who is requesting the position.
6. Press the [**ENT**] key to store the selected setting.
7. To exit this menu and return to radio operation mode press the [**16/9**] key.



The **GX1500E** has the capability to turn off the Position Request ringer.

1. Press and hold down the [**CALL(MENU)**] key until “Radio Setup” menu appears.
2. Turn the **CHANNEL** selector knob to select “DSC Setup” menu.
3. Press the [**ENT**] key, then select “DSC Beep” with the **CHANNEL** selector knob.
4. Press the [**ENT**] key.
5. Turn the **CHANNEL** selector knob to select “POS Request.”
6. Turn the **CHANNEL** selector knob to select “Off.”
7. Press the [**ENT**] key to store the selected setting.
8. To exit this menu and return to radio operation mode press the [**16/9**] key.



If you wish to return to enabling the ringer tone, just repeat the above procedure, turning the **CHANNEL** selector knob to select “On” in step “6” above.

9.8.2 Transmitting a Position Request to Another Vessel

Pre-Programmable Request

1. Press the [**CALL(MENU)**] key. The “DSC Operation” menu will appear in the display.
2. Turn the **CHANNEL** selector knob to select “POS Request.”
3. Press [**ENT**] key to show the Position request directory. This directory uses the INDIVIDUAL Directory information.
4. Turn the **CHANNEL** selector knob to select a name, then press the [**ENT**] key.
5. Press the [**ENT**] key to transmit the position request DSC call.
6. When the **GX1500E** receives the position from the polled vessel it is shown on the radio display and also transferred to the GPS Chart plotter.
7. If the **GX1500E** does not receive a reply, the display will be as shown in the illustration on the right. To send again, press the [**ENT**] key.



NOTE

If the **GX1500E** does not receive position data from the polled vessel, the LCD will show “NO POSITION DATA.”

Manual Request

You may enter an MMSI number manually to contact without the Setting up the Individual / Position Call Directory.

1. Press the [**CALL(MENU)**] key. The “DSC Operation” menu will appear in the display.
2. Turn the **CHANNEL** selector knob to select “POS Request.”
3. Press [**ENT**] key to show the Position request directory. This directory uses the INDIVIDUAL Directory information.
4. Turn the **CHANNEL** selector knob to select the “Manual,” then press the [**ENT**] key.
5. Turn the **CHANNEL** selector knob to scroll through numbers, 0-9. To enter the desired number and move one space to the right press the [**ENT**] key. Repeat this procedure until all nine space of the MMSI number which you want to contact are entered.
6. If a mistake was made entering in the MMSI number repeat pressing the [**H/L(NAV)**] key until the wrong number is selected, then move the channel knob to correct the entry.
7. When finished entering the MMSI number, press and hold the [**ENT**] key.
8. Press the [**ENT**] key to transmit the position request DSC call.
9. When the **GX1500E** receives the position from the polled vessel it is shown on the radio display and also transferred to the GPS Chart plotter.
10. If the **GX1500E** does not receive a reply, the display will be as shown in the illustration on the right. To send again, press the [**ENT**] key.

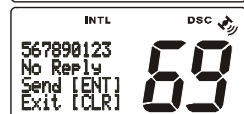
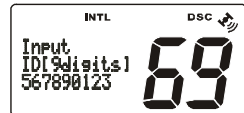

9.8.3 Receiving a Position Request

When a position request call is received from another vessel, a ringing alarm will sound and POS REQUEST will be shown in the LCD. Operation and transceiver function differs depending on “POS Reply” in the “DSC Setup” menu setting.

Automatically reply:

1. When a position request call is received, a calling alarm sounds 4 times. Then requested position coordinates are transmitted automatically to the vessel requesting your vessels position.
2. To exit from position request display, press any key.



Manually reply:

1. When a position request call is received from another vessel, the LCD will be as shown in the illustration at the right.
2. A ringing alarm sounds 4 times. Then select type of reply function “Send” or “No Reply” by using the **CHANNEL** selector knob.
3. The **GX1500E** display will show “Send” or “No Reply” allowing you to send your vessels location by using the **CHANNEL** selector knob.
4. When “Send” is selected, press the [ENT] key. And your position will be transmitted to the requesting vessel.
5. To exit from position request display, press the [16/9] key.

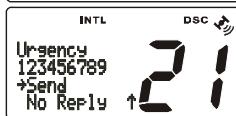

9.9 POSITION SEND

The feature is similar to Position Request, however instead of requesting a position of another vessel this function allows you to send your position to another vessel. In order to send your position you need to have a GPS receiver connected or to have manually input your position. See section “9.11 MANUAL INPUTTING OF THE GPS LOCATION.”

9.9.1 Setting up a Position Send Ringer

The **GX1500E** has the capability to turn off the Position Send ringer.

1. Press and hold down the [**CALL(MENU)**] key until “Radio Setup” menu appears.
2. Turn the **CHANNEL** selector knob to select “DSC Setup” menu.
3. Press the [**ENT**] key, then select “DSC Beep” with the **CHANNEL** selector knob.
4. Press the [**ENT**] key.
5. Turn the **CHANNEL** selector knob to select “POS Send.”
6. Turn the **CHANNEL** selector knob to select “Off.”
7. Press the [**ENT**] key to store the selected setting.
8. To exit this menu and return to radio operation mode press the [**16/9**] key.



If you wish to return to enabling the ringer tone, just repeat the above procedure, turning the **CHANNEL** selector knob to select “On” in step “6” above.

9.9.2 Transmitting a DSC Position Send Call

Pre-Programmable Calling

1. Press the **[CALL(MENU)]** key. The “DSC Operation” menu will appear in the display.
2. Turn the **CHANNEL** selector knob to select the “POS Send.”
3. Press the **[ENT]** key to select the Individual directory.
4. Turn the **CHANNEL** selector knob to select a name in the directory, then press the **[ENT]** key.
5. Press the **[ENT]** key to send your position to the selected vessel.

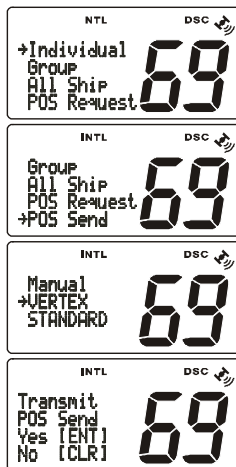

Manual Calling

You may enter an MMSI number manually to contact without the Setting up the Individual / Position Call Directory.

1. Press the **[CALL(MENU)]** key. The “DSC Operation” menu will appear in the display.
2. Turn the **CHANNEL** selector knob to select the “POS Send.”
3. Press **[ENT]** key to show the Position Send directory. This directory uses the INDIVIDUAL Directory information.
4. Turn the **CHANNEL** selector knob to select “Manual,” then press the **[ENT]** key.
5. Enter the MMSI number (nine digits) which you want to contact, then press the **[ENT]** key.
6. Press the **[ENT]** key to send your position to the selected vessel.

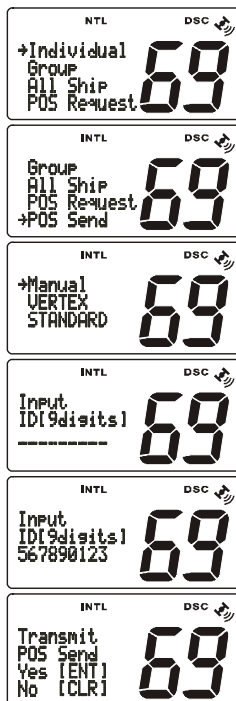

9.9.3 Receiving a DSC Position Send Call

When another vessel transmits their location to the **GX1500E** the following will happen:

1. A ringing sound will be produced when the call is received.
2. Press the [16/9] key to stop ringing
3. The position from the calling vessel will be shown on the display of the radio and also transferred to any Standard Horizon GPS Chart plotter if connected.

9.10 DSC TRANSMISSION TEST

1. Press the [CALL(MENU)] key. The “DSC Operation” menu will appear.
2. Turn the **CHANNEL** selector knob to select “DSC Test” menu.
3. Press the [ENT] key, then select the station (name or MMSI number) to be sent the test signal with the **CHANNEL** selector knob.
4. Press the [ENT] key.
5. Turn the **CHANNEL** selector knob to select the “Individual” you want to send the test signal or “Manual,” then press the [ENT] key.
6. If “Manual” is selected at the previous step, enter the MMSI number (nine digits) which you want to send the test signal. To do this, turn the **CHANNEL** selector knob to scroll through numbers “0-9,” then press the [ENT] key to move the entry location to the right. If a mistake was made entering in the MMSI number repeat pressing the [H/L(NAV)] key until the wrong number is selected, then move the channel knob to correct the entry. When finished entering the MMSI number, press and hold the [ENT] key.
7. Press the [ENT] key again to transmit the Test signal.

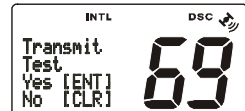

9.11 MANUAL INPUTTING OF THE GPS LOCATION (LAT/LON)

You may send the Latitude/Longitude of your vessel manually even if the **GX1500E** is not connected the GPS receiver unit.

After the position is entered, transmitting a DSC Distress, Position Request, or Position Send will contain the manually entered position.

1. Press and hold down the **[CALL(MENU)]** key until “Radio Setup” menu appears.
2. Turn the **CHANNEL** selector knob to select “DSC Setup” menu.
3. Press the **[ENT]** key, then select “POS Input” with the **CHANNEL** selector knob.
4. Press the **[ENT]** key. The transceiver will beep, and the display will be as shown in the illustration on the right.
5. Enter the your local time by the 24-hour system on the UTC time. Use the **[ENT]** and **[H/L(NAV)]** key to navigate to each column of the time, then use the **CHANNEL** selector knob to select the desired numbers in each column. Repeat for each column, to complete the time.
6. Enter the Latitude/Longitude of your vessel location with the same procedure as description above.
7. To store the data entered, press the **[ENT]** key. To exit this menu and return to radio mode press the **[16/9]** key.

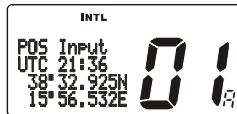
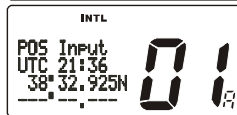
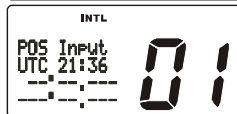
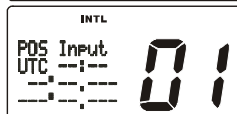

10 RADIO SETUP

NOTE

The optional **CMP25** RAM+ mic and **VH-310** Handset can also change the RADIO SETUP menu. Refer to page 68 (RAM+ mic) and page 76 (**VH-310**) for details.

10.1 LAMP ADJUSTING

Allows setting up the backlight intensity or to turn it off.

1. Press and hold down the [**CALL(MENU)**] key until “Radio Setup” menu appears.
2. Press the [**ENT**] key, then select “Dimmer” in the “Radio Setup” menu with the **CHANNEL** selector knob.
3. Press the [**ENT**] key.
4. Turn the **CHANNEL** selector knob to select the desired level. When “OFF” is selected, the lamp is extinguished.
5. Press the [**ENT**] key to store the selected level.
6. To exit this menu and return to radio operation mode press the [**16/9**] key.

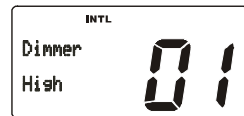

10.2 LCD CONTRAST

This selection sets up the display for best viewability for the varying mounting locations (overhead or below).

1. Press and hold down the [**CALL(MENU)**] key until “Radio Setup” menu appears.
2. Press the [**ENT**] key, then select “Contrast” in the “Radio Setup” menu with the **CHANNEL** selector knob.
3. Press the [**ENT**] key.
4. Turn the **CHANNEL** selector knob to select the desired level. The contrast level can be set from “00” to “31.”
5. Press the [**ENT**] key to store the selected level.
6. To exit this menu and return to radio operation mode press the [**16/9**] key.

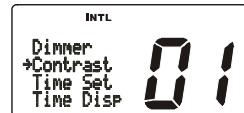

10.3 TIME OFFSET

This selection sets the time offset between local time and UTC (time GPS sends to radio). Time is displayed when GPS position (LAT/LON) is displayed by pressing the [F] key followed by the [6(NAV)] key.

1. Press and hold down the [CALL(MENU)] key until “Radio Setup” menu appears.
2. Press the [ENT] key, then select “Time Set” in the “Radio Setup” menu with the **CHANNEL** selector knob.
3. Press the [ENT] key.
4. Turn the **CHANNEL** selector knob to select time offset from UTC. See illustration below to find your offset time from UTC. If “0:00” is assigned, the time is the same as UTC (Universal Time Coordinated or GMT Greenwich Mean Time).
5. Press the [ENT] key to store the time offset.
6. To exit this menu and return to radio operation mode press the [16/9] key.

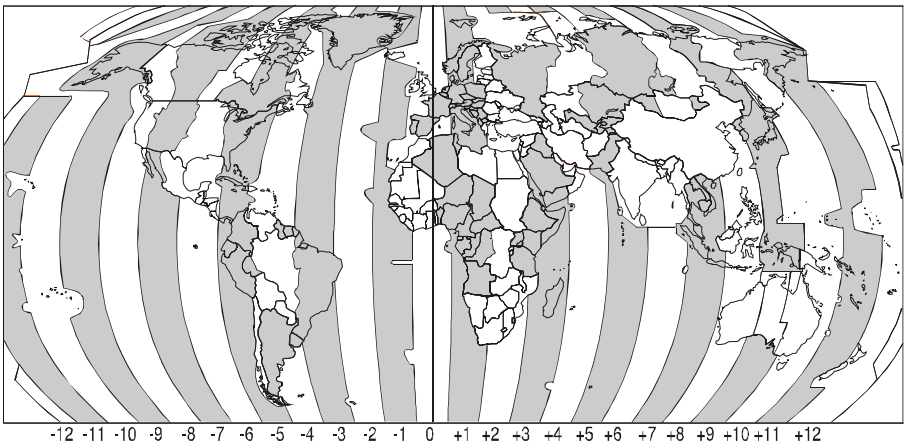
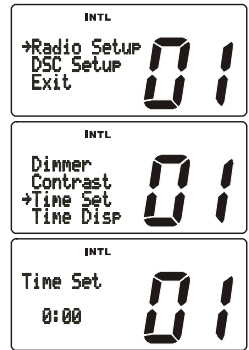

OFFSET TIME TABLE

10.4 TIME LOCATION

This selection selects the time display between local time and UTC (time GPS sends to radio). Time is displayed when GPS position (LAT/LON) is displayed by pressing the [F] key followed by the [6(NAV)] key.

1. Press and hold down the [CALL(MENU)] key until "Radio Setup" menu appears.
2. Press the [ENT] key, then select "Time Disp." in the "Radio Setup" menu with the CHANNEL selector knob.
3. Press the [ENT] key.
4. Turn the CHANNEL selector knob to select "UTC" or "Local."
5. Press the [ENT] key to store the selected setting.
6. To exit this menu and return to radio operation mode press the [16/9] key.



In the local time mode, the display shows the time by the 12-hour system. Meanwhile, the display shows the time by the 24-hour system in the UTC mode.

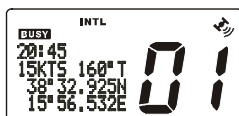

("UTC" mode)

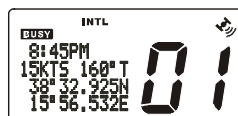

("LOCAL" mode)

10.5 TRUE MAGNETIC CHANGE (NAV display)

This selection allows customising the GPS COG (Course Over Ground) displayed on the LCD to be in True or Magnetic.

1. Press and hold down the [CALL(MENU)] key until "Radio Setup" menu appears.
2. Press the [ENT] key, then select "Magnetic" in the "Radio Setup" menu with the CHANNEL selector knob.
3. Press the [ENT] key.
4. Turn the CHANNEL selector knob to select "On" (representing "Magnetic") or "Off" (representing "True").
5. Press the [ENT] key to store the selected setting.
6. To exit this menu and return to radio operation mode press the [16/9] key.

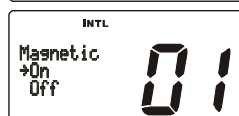

10.6 PRIORITY CHANNEL SET

Allows selection of the priority channel.

1. Press and hold down the [**CALL(MENU)**] key until “Radio Setup” menu appears.
2. Press the [**ENT**] key, then select “Priority CH” in the “Radio Setup” menu with the **CHANNEL** selector knob.
3. Press the [**ENT**] key.
4. Turn the **CHANNEL** selector knob to select the channel to be a priority.
5. Press the [**ENT**] key to store the selected setting.
6. To exit this menu and return to radio operation mode press the [**16/9**] key.



10.7 SCAN TYPE

This selection selects the scan mode between “Memory Scan” and “Priority Scan.”

1. Press and hold down the [**CALL(MENU)**] key until “Radio Setup” menu appears.
2. Press the [**ENT**] key, then select “SCAN Type” in the “Radio Setup” menu with the **CHANNEL** selector knob.
3. Press the [**ENT**] key.
4. Turn the **CHANNEL** selector knob to select “Priority” or “Memory.”
5. Press the [**ENT**] key to store the selected setting.
6. To exit this menu and return to radio operation mode press the [**16/9**] key.

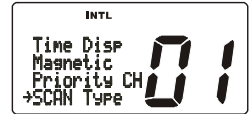

10.8 SCAN RESUME TIME

This selection is used to select the time the **GX1500E** waits after a transmission ends before starting scanning.

1. Press and hold down the [**CALL(MENU)**] key until “Radio Setup” menu appears.
2. Press the [**ENT**] key, then select “SCAN Resume” in the “Radio Setup” menu with the **CHANNEL** selector knob.
3. Press the [**ENT**] key.
4. Turn the **CHANNEL** selector knob to select the desired resume time. The resume time can be set to “1sec,” “2sec,” “3sec,” or “Off.” In the “Off” selection, the scanner will resume after the other station stops transmitting (carrier drops).
5. Press the [**ENT**] key to store the selected setting.
6. To exit this menu and return to radio operation mode press the [**16/9**] key.



10.9 KEY BEEP (ON/OFF)

This selection allows the beep tone when a key is pressed to be turned off.

1. Press and hold down the [**CALL(MENU)**] key until “Radio Setup” menu appears.
2. Press the [**ENT**] key, then select “Key Beep” in the “Radio Setup” menu with the **CHANNEL** selector knob.
3. Press the [**ENT**] key.
4. Turn the **CHANNEL** selector knob to select “On” or “Off.”
5. Press the [**ENT**] key to set the key beep condition.
6. To exit this menu and return to radio operation mode press the [**16/9**] key.



NOTE

Emergency alarm and beeps for DSC operation cannot be turned OFF.

10.10 WX ALERT

This selection allows the radios NOAA Weather alert to be turned off. Default setting is ON.

1. Press and hold down the [**CALL(MENU)**] key until “Radio Setup” menu appears.
2. Press the [**ENT**] key, then select “WX Alert” in the “Radio Setup” menu with the **CHANNEL** selector knob.
3. Press the [**ENT**] key.
4. Turn the **CHANNEL** selector knob to select the desired WX alert mode. The WX alert mode can be set to “On WX,” “On SCAN,” “On SCAN/WX,” or “Off.”
5. Press the [**ENT**] key to store the selected setting.
6. To exit this menu and return to radio operation mode press the [**16/9**] key.

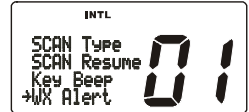

10.11 CHANNEL NAME CHANGE

This selection allows you to customise the name of a channel from the default name.

1. Press and hold down the [CALL(MENU)] key until “Radio Setup” menu appears.
2. Press the [ENT] key, then select “CH Name” in the “Radio Setup” menu with the **CHANNEL** selector knob.
3. Press the [ENT] key.
4. Turn the **CHANNEL** selector knob to select the channel to be named, then press the [ENT] key.
5. Turn the **CHANNEL** selector knob to scroll through the first letter of the channel name.
6. Press the [ENT] key to store the first letter in the name and step to the next letter to the right.
7. Repeat step 6 and 7 until the name is complete. The name can consist of up to twelve characters, if you do not use all twelve characters press the [ENT] key to move to the next space. This method can also be used to enter a blank space in the name. To clear the previous letter, press the [CLR] key.
8. Press and hold the [ENT] key to enter the name and exit from the “CH Name” menu. The LCD will return to the “Radio Setup” menu.
9. If you want to enter the name of another channel, select “Next” then press the [ENT] key. Otherwise, select “Exit” then press the [ENT] key.
10. To exit this menu and return to radio operation mode press the [16/9] key.

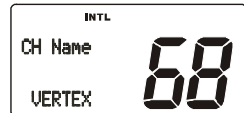
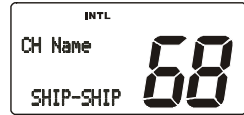
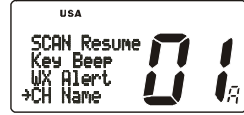

10.12 NAMING THE RADIO OR SECOND STATION MIC OR HANDSET

This selection allows you to provide the name to the radio and optional RAM+ Mic's when connected.

1. Press and hold down the [**CALL(MENU)**] key until "Radio Setup" menu appears.
2. Press the [**ENT**] key, then select "Unit Name" in the "Radio Setup" menu with the **CHANNEL** selector knob.
3. Press the [**ENT**] key.
4. Turn the **CHANNEL** selector knob to select the Unit ("Radio" or "RAM1") to be named, then press the [**ENT**] key.
5. Turn the **CHANNEL** selector knob to scroll through the first letter of the channel name.
6. Press the [**ENT**] key to store the first letter in the name and step to the next letter to the right.
7. Repeat step 6 and 7 until the name is complete. The name can consist of up to twelve characters, if you do not use all twelve characters press the [**ENT**] key to move to the next space. This method can also be used to enter a blank space in the name. To clear the previous letter, press the [**CLR**] key.
8. Press and hold the [**ENT**] key to enter the name and return to the "Unit Name" menu.
9. If you want to enter the name of another unit, repeat steps 4 through 8.
10. To exit this menu and return to radio operation mode press the [**16/9**] key.

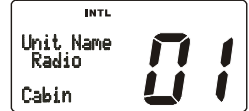

11 ENHANCED RAM+ MIC OPERATION

When the RAM+ microphone is connected to the **GX1500E**, most VHF, DSC, and setup menus can be remotely operated. The RAM+ Mic is supplied with 7 m of routing cable and can be extended up to 21 m using three 7 m extension cables model **CT-100**. The intercom operation can be used between the RAM+ Mic and the transceiver.

11.1 RAM+ MIC CONTROLS

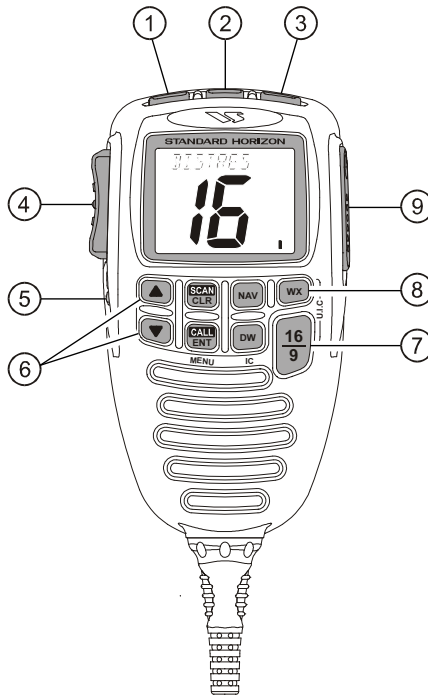

① SQUELCH CONTROL (SQL)

Activates the squelch adjusting mode.

Press this key to activate the squelch adjusting mode. Press the microphone's [▲] or [▼] key to adjust the squelch.

② VOLUME KEY (VOL)

Activates the volume adjusting mode.

Press this key to activate the volume adjusting mode. Press the microphone's [▲] or [▼] to adjust the volume.

③ POWER SWITCH (PWR)

Press and hold down this key to turn to the transceiver and RAM+ Mic on and off.

④ **PTT (Push-To-Talk) SWITCH**

Activates transmission.

⑤ **[H/L] KEY**

Toggles between high and low power. When the [H/L] key is pressed while the transceiver is on channel 13 or 67, the power will temporarily switch from LO to HI power until the **PTT** is released. The [H/L] key does not function on transmit inhibited and low power only channels.

⑥ **[▲](UP)/[▼](DOWN) KEY**

These keys are used to select channels, adjust the volume and squelch level, and to choose the item selection of different functions (such as the DSC operation). In many ways, these keys emulate the function of the transceiver's **CHANNEL** selector knob.

⑦ **[16/9] KEY**

Immediately recalls channel 16 from any channel location. Holding down this key recalls channel 9. Pressing the [16/9] key reverts to the previous selected working channel.

Secondary use

Please see secondary use for the [WX] and [MEM] key.

⑧ **KEY PAD**

[SCAN(CLR)] Key

1. Starts and stops scanning of programmed channels.
2. If held while the [UP(▲)] or [DOWN(▼)] key on the microphone are pressed, the radio will show the channels programmed in scan memory. This function will not work if the unit is scanning.

NOTE: The priority channel by default is Channel 16, however the priority channel can be changed. To select a different priority channel refer to section "11.7 SCAN TYPE."

Secondary use

Press the [SCAN(CLR)] key to cancel the DSC selection.

[CALL(ENT)] Key

The [CALL(ENT)] key functions as the enter key.

Secondary use

Press the [CALL(ENT)] key to access the DSC OPERATION menu.

Press and hold the [CALL(ENT)] key to access the SETUP menu.

[DW(IC)] Key

Watches for a transmission on CH16 and another selected channel until either signal is received. (Dual watch)

Secondary use

Press and hold [DW] key, intercom operation will operate between radio and RAM+ Mic.

[NAV] Key

Press this key, when connected to the GPS receiver, the LCD displays Position Data and Time from the GPS.

[WX] Key

Immediately recalls the previously selected US NOAA weather channel from any channel location.

Secondary use

Holding down the [16/9] key while pressing the [WX] key switch the Channel Group.

⑨ [DISTRESS] KEY

Used to send a Distress Alert. To send the Distress Alert refer to section "9.3.1. Transmitting a Distress Alert."

11.2 INTERCOM OPERATION

11.2.1 Communication

1. Press and hold the [DW] key while in "RADIO" mode, the mode is changed to "INTERCOM" mode. When the "INTERCOM" operation is activated, "IC" is displayed on the RAM+ Mic (and **VH-310** Handset) and "INTERCOM" is displayed on the **GX1500E**.



2. Press the PTT switch, "TALK" is displayed.

NOTE: A warning beep is emitted when the RAM+ Mic PTT switch is also being pressed while the transceiver microphone's PTT switch is pressed.



(RAM+ Mic's PTT switch is pressed)

3. Speak slowly and clearly into the microphone, hold the microphone about 1.5 cm away from your mouth.



(GX1500E's PTT switch is pressed)

4. When finished, release the PTT switch.
5. Press the [DW] key momentarily, the mode will revert to "RADIO" mode.

11.2.2 Calling

Hold down the [DW] key for 1 second or more, when the “INTERCOM” operation is activated. A calling beep is emitted twice from the called unit.

11.3 MANUAL INPUTTING OF THE GPS LOCATION (LAT/LON)

You may send the Latitude/Longitude of your vessel manually from the RAM+ Mic even if the **GX1500E** is not connected the GPS receiver unit.

After the position is entered, transmitting a DSC Distress, Position Request, or Position Send will contain the manually entered position.

1. Press and hold down the [CALL(ENT)] key until “Radio Setup” menu appears.
2. Press the [▼] key to select “DSC SETUP” menu.
3. Press the [CALL(ENT)] key, then select “POS INPUT” with the [▲]/[▼] key.
4. Press the [CALL(ENT)] key then, enter the your local time by the 24-hour system on the UTC time. Use the [CALL(ENT)] and [H/L] key to navigate to each column of the time, then use the [▲]/[▼] key to select the desired numbers in column. Repeat for each column, to completed the time.
5. Enter the Latitude/Longitude of your vessel location with the same procedure as description above.
6. Press and hold in the [ENT] key to store the data entered, then press the [16/9] key to exit this menu and return to radio operation mode.



11.4 DSC/RADIO SETUP MODE

The RAM+ can access the DSC / RADIO setup menu (refer to section “9 DIGITAL SELECTIVE CALLING” and section “10 RADIO SETUP MODE” for details). The LAMP, CONTRAST, and KEY BEEP menu item accessed from the RAM+ only controls the RAM+’s display and speaker.

DSC/RADIO Setup mode from the RAM+:

1. Press and hold down the [CALL(ENT)] key until “RADIO SETUP” menu appears.
2. Press the [▲]/[▼] key to select “RADIO SETUP” or “DSC SETUP” menu.
3. Press the [CALL(ENT)] key, then select the menu item you wish to work on by pressing the [▲]/[▼] key.
4. Press the [CALL(ENT)] key.
5. Press the [▲]/[▼] key to change the value or condition for the menu item, then press the [CALL(ENT)] key to save the new setting.
6. Press the [▲]/[▼] key to select “EXIT,” then press the [CALL(ENT)] key to return to the normal operation.

RADIO SETUP-menu

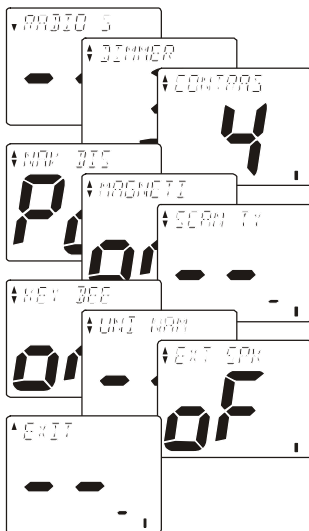

DSC SETUP-menu

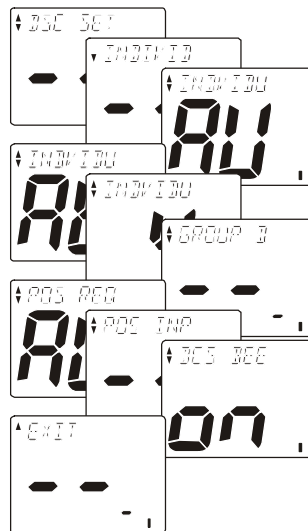

NOTE

When setup menu is selected, the **GX1500E** will be temporarily disabled until the RAM+ mic, exits from the setup mode.

11.4.1 Changing GPS Information to Vessel position or COG

Allows customising of the NAV data showing GPS Information. Factory default is “Your Vessel’s Current Position,” however, following the steps below the GPS Information can be changed to “Course Over Ground (COG).”

1. Press and hold down the [CALL(ENT)] key until “RADIO SETUP” menu appears.
2. Press the [CALL(ENT)] key, then select “NAV DISPLAY” with the [▲]/[▼] key.
3. Press the [CALL(ENT)] key.
4. Press the [▼] or [▲] key to select “Pos (Your Vessel’s Current Position)” or “Cru (Course Over Ground).”
5. Press the [CALL(ENT)] to store the data entered, then press the [16/9] key to exit this menu and return to radio operation mode.

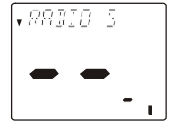

12 VH-310 HANDSET OPERATION

When the **VH-310** HANDSET is connected to the **GX1500E**, most VHF, DSC, and setup menus can be remotely operated. The **VH-310** HANDSET is supplied with 7 m of routing cable and can be extended up to 21 m using three 7 m extension cables model **CT-100**. The intercom operation can be used between the **VH-310** HANDSET or the **GX1500E**.

12.1 VH-310 HANDSET CONTROLS

① **PWR** key

Press and hold down this key to turn to the transceiver and **VH-310** HANDSET on and off.

② **PTT (Push-To-Talk)** Switch

Activates transmission.

③ **[H/L]** key

Toggles between high and low power. When the **[H/L]** key is pressed while the transceiver is on channel 13 or 67, the power will temporarily switch from “LO” to “HI” power until the **PTT** is released. The **[H/L]** key does not function on transmit inhibited and low power only channels.

④ **[DISTRESS]** key

Used to send a Distress Alert. To send the Distress Alert refer to section “9.3.1. Transmitting a Distress Alert.”

⑤ **RADIO CONTROL KEYS**

[VOL] key

Activates the volume adjusting mode.

Press this key to activate the volume adjusting mode.

Press the **[▲]** or **[▼]** to adjust the volume.

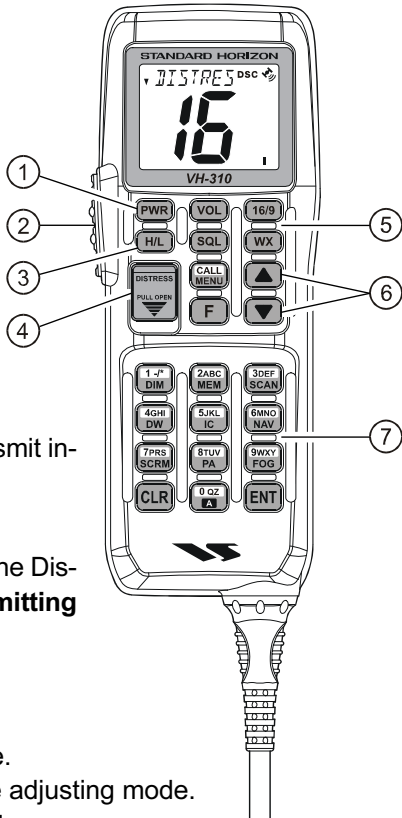

NOTE

When the **VH-310** handset is removed from the cradle the speaker audio will be automatically reduced so not to damage your hearing. When the **VH-310** is in the cradle the speaker audio will increase so communications can be heard.

[SQL] key

Activates the squelch adjusting mode.

Press this key to activate the squelch adjusting mode. Press the [▲] or [▼] key to adjust the squelch.

[CALL(MENU)] key

The [CALL(MENU)] key functions as the enter key.

Secondary use

Press the [CALL(MENU)] key to access the DSC OPERATION menu. The “INDIVIDUAL CALL,” “GROUP CALL,” “ALL SHIP CALL,” “POSITION REQUEST,” “POSITION SEND,” “STANDBY MODE,” and “CALL WAITING” functions can be accessed from the DSC OPERATION menu. Press and hold the [CALL(MENU)] key to access the RADIO SETUP (refer to section 10) or DSC SETUP menu (refer to section 9).

[F] key

Activates the “Alternate” key function.

Press this key to activate the “Alternate” key function of the numerical keys.

[16/9] key

Immediately recalls channel 16 from any channel location. Holding down this key recalls channel 9. Pressing the [16/9] key reverts to the previous selected working channel.

Secondary use

Press and hold the [16/9] key then press the [WX] key to switch between the USA, International or Canadian channels.

[WX] key

Immediately recalls the previously selected US NOAA weather channel from any channel location.

Secondary use

Holding down the [16/9] key while pressing the [WX] key switches the Channel Group.

⑥ [▲] / [▼] KEY

These keys are used to select channels, adjust the volume and squelch level, and to choose the item selection of different functions (such as DSC operation).

⑦ KEYPAD

[1(DIM)] key

When in radio mode, this key is used to directly select digit “1” in a channel number.

Secondary use

Press the [F] key first then press the [1(DIM)] key to access the LCD Dimmer menu. Refer to section “**10.1 LAMP ADJUSTING**” for details.

[2(MEM)] Key

When in radio mode, this key is used to directly select digit “2” in a channel number.

Secondary use

Press the [F] key first then press the [2(MEM)] key, memorise the selected channel into the transceiver scan memory for scanning. When repeat the same procedures ([F] → [2(MEM)]), will delete the channel from the scan memory. Refer to section “**8.12 SCANNING**” for details.

[3(SCAN)] Key

When in radio mode, this key is used to directly select digit “3” in a channel number.

Secondary use

Press the [F] key first then press the [3(SCAN)] key to start and stop the scanning of programmed channels. Refer to section “**8.12 SCANNING**” for details.

[4(DW)] Key

When in radio mode, this key is used to directly select digit “4” in a channel number.

Secondary use

Press the [F] key first then press the [4(DW)] key to scan for voice communications on the priority channel and another selected channel until a signal is received on either channel (Dual Watch). Refer to section “**8.11 DUAL WATCH (TO PRIORITY CHANNEL)**” for details.

[5(IC)] Key

When in radio mode, this key is used to directly select digit “5” in a channel number.

Secondary use

Press the [F] key then press the [5(IC)] key to activate intercom function between RAM+(s) or **VH-310** handset(s).

Refer to section “**12.2 INTERCOM OPERATION**” for details.

[6(NAV)] Key

When in radio mode, this key is used to directly select digit “6” in a channel number.

Secondary use

Press the **[F]** key first then press the **[6(NAV)]** key, the LCD will display NAV GPS Data, Time, SOG (Speed Over Ground), and COG (Course Over Ground) when a GPS is connected to the accessory cable of the **GX1500E**. See section “**6.4 ACCESSORY CABLE**” for details.

[7(SCRM)] Key

When in radio mode, this key is used to directly select digit “7” in a channel number.

[8(PA)] Key

When in radio mode, this key is used to directly select digit “8” in a channel number.

[9(FOG)] Key

When in radio mode, this key is used to directly select digit “9” in a channel number.

[0(A)] Key

When in radio mode, this key is used to directly select digit “0” in a channel number.

Secondary use

Used to select A (alpha channels). Press the desired channel keys then press and hold **[0(A)]** key until “A” appears next to the channel number and press **[ENT]** to select the channel.

[CLR] Key

Press the **[CLR]** key to cancel the menu selection and/or keypad entry.

[ENT] Key

Press the **[ENT]** key to enter the menu selection and/or keypad entry.

12.2 INTERCOM OPERATION

12.2.1 Communication

1. Press the [F] key followed by the [5(IC)] key, the mode is changed to “INTERCOM” mode.
2. When the “INTERCOM” operation is activated, “IC” is displayed on the **VH-310** Handset (and RAM+ Mic, if used) and “INTERCOM” is displayed on the **GX1500E**.
3. Press the **PTT** switch, “TALK” is displayed.



NOTE: A warning beep is emitted when the RAM+ Mic **PTT** switch is also being pressed while the transceiver microphone’s **PTT** switch is pressed.

4. Speak slowly and clearly into the microphone, hold the microphone about 1.5 cm away from your mouth.
5. When finished, release the **PTT** switch.
6. To exit the “INTERCOM” mode and return to radio operation mode, press the [F] key followed by the [5(IC)] key again.



(VH-310's PTT switch is pressed)



(GX1500E's PTT switch is pressed)

12.2.2 Calling

Press and hold the [5(IC)] key for 1 second when the “INTERCOM” operation is activated, a calling beep is emitted from the **GX1500E** speaker.

12.3 MANUAL INPUTTING OF THE GPS LOCATION (LAT/LON)

You may send the Latitude/Longitude of your vessel manually from the **VH-310** Handset even if the **GX1500E** is not connected the GPS receiver unit.

After the position is entered, transmitting a DSC Distress, Position Request, or Position Send will contain the manually entered position.

1. Press and hold down the **[CALL(MENU)]** key until “Radio Setup” menu appears.
2. Press the **[▼]** key to select “DSC SETUP” menu.
3. Press the **[ENT]** key, then select “POS INPUT” with the **[▲]/[▼]** key.
4. Press the **[ENT]** key then, enter the your local time from the keypad by the 24-hour system on the UTC time.
5. Enter the Latitude of your vessel location (xx.xx.xx) by the keypad, then press the **[6(NAV)]** key to select North (N), or **[7(SCRM)]** key to select South (S).
6. Enter the Longitude of your vessel location (xxx.xx.xx) by the keypad, then press the **[3(SCAN)]** to select East (E), or **[9(FOG)]** key to select West (W).
7. If a number was entered by mistake, press the **H/L** key repeatedly to select the number. Press the **[▲]/[▼]** key to select the desired number.
8. Press and hold in the **[ENT]** key to store the data entered, then press the **[16/9]** key to exit this menu and return to radio operation mode.

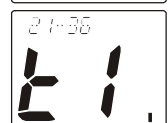
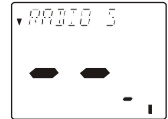

12.4 DSC/RADIO SETUP MODE

The **VH-310** Handset can access the DSC / RADIO setup menu (refer to section “**9 DIGITAL SELECTIVE CALLING**” and section “**10 RADIO SETUP MODE**” for details). The CONTRAST, NAV DISPLAY, KEY BEEP, and AF SELECT menu item accessed from the **VH-310** Handset only controls the **VH-310** Handset’s display and speaker.

DSC/RADIO Setup mode from the **VH-310** Handset:

1. Press and hold down the **[CALL(MENU)]** key until “RADIO SETUP” menu appears.
2. Press the **[▲]/[▼]** key to select “RADIO SETUP” or “DSC SETUP” menu.
3. Press the **[ENT]** key, then select the menu item you wish to work on by pressing the **[▲]/[▼]** key.
4. Press the **[ENT]** key.
5. Press the **[▲]/[▼]** key to change the value or condition for the menu item, then press the **[ENT]** key to save the new setting.
6. Press the **[▲]/[▼]** key to select “EXIT,” then press the **[ENT]** key to return to the normal operation.

RADIO SETUP-menu

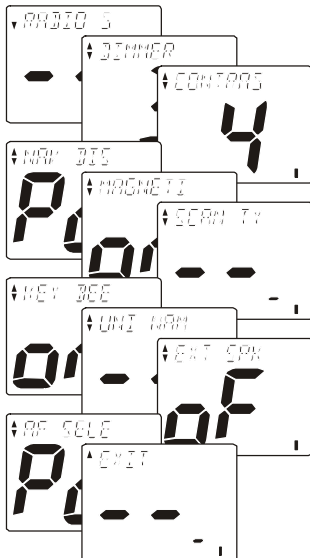

DSC SETUP-menu

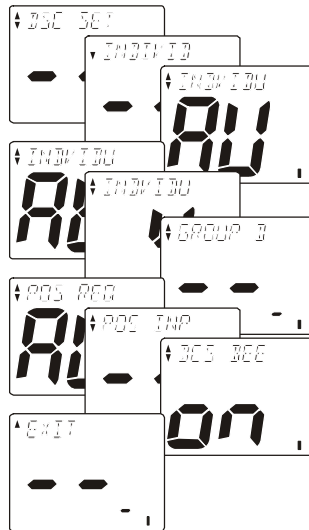

NOTE

When the SETUP menu is selected, using the **VH-310** Handset, the **GX1500E** will be temporarily disabled until the **VH-310** Handset exits from the setup mode.

12.4.1 Changing GPS Information to Vessel position or COG

Allows customising of the NAV data showing GPS Information. Factory default is “Your Vessel’s Current Position,” however, following the steps below the GPS Information can be changed to “Course Over Ground (COG).”

1. Press and hold down the [CALL(MENU)] key until “RADIO SETUP” menu appears.
2. Press the [ENT] key, then select “NAV DISPLAY” with the [▲]/[▼] key.
3. Press the [ENT] key.
4. Press the [▼] or [▲] key to select “Pos (Your Vessel’s Current Position)” or “Cru (Course Over Ground).”
5. Press the [ENT] key to store the data entered, then press the [16/9] key to exit this menu and return to radio operation mode.

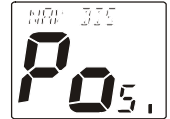
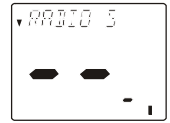

12.4.2 External Speaker AF Selection

The AF SELECT menu allows you to set the audio output level of the **VH-310**'s External Speaker to “fixed” regardless the VOL level setting of the **VH-310**, which is useful to the case when use with the amplified speaker, such as the Standard Horizon **MLS-310**.

1. Press and hold down the [CALL(MENU)] key until “Radio Setup” menu appears.
2. Press the [ENT] key, then select “AF SELECT” with the [▲]/[▼] key.
3. Press the [ENT] key.
4. Press the [▲] or [▼] key to select “Pr” (External Speaker Level is “Fixed”) or “Po” (External Speaker Level is “Adjustable”).
5. Press the [ENT] key to store the data entered, then press the [16/9] key to exit this menu and return to radio operation mode.

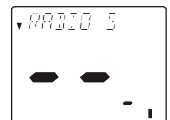

13 MAINTENANCE

The inherent quality of the solid-state components used in this transceiver will provide many years of continuous use. Taking the following precautions however, will prevent damage to the transceiver.

- Keep the microphone connected or the jack covered at all times to prevent corrosion of electrical contacts;
- Never key the microphone unless an antenna or suitable dummy load is connected to the transceiver.
- Ensure that the supply voltage to the transceiver does not exceed 16 VDC or fall below 11 VDC.
- Use only STANDARD HORIZON-approved accessories and replacement parts.

In the unlikely event of serious problems, please contact your Dealer or our repair facility.

13.1 REPLACEMENT PARTS

- **Panel Cover:** RA0777900
- **Power Cord:** T9023306
- **VOL/SQL Knob (Black):** RA0757600
- **VOL/SQL Knob (White):** RA0763500
- **Rotary Channel Knob (Black):** RA0757700
- **Rotary Channel Knob (White):** RA0763600
- **Mounting Bracket (Black):** RA0784000
- **Mounting Bracket (White):** RA0784100
- **Mounting Bracket Knob (Black):** RA045910A
- **Mounting Bracket Knob (White):** RA043770A
- **Microphone Hanger (Black):** RA0458800
- **Microphone Hanger (White):** RA0436000
- **RAM+ Mic or VH-310 Routing Cable Assembly:** S8101512

13.2 FACTORY SERVICE

In the unlikely event that the radio fails to perform or needs servicing, please contact your Dealer or Marine Division of Vertex Standard.

An "RA" Return Authorisation number is not necessary to send a product in for service. Include a brief note describing the problem along with your name, return address, phone number, and proof of purchase.

13.3 TROUBLESHOOTING CHART

SYMPTOM	PROBABLE CAUSE	REMEDY
Transceiver fails to power up.	No DC voltage to the transceiver, or blown fuse.	a. Check the 12VDC battery connections and the fuse. b. The PWR key needs to be pressed and held to turn the radio on.
Transceiver blows fuse when connected to power supply.	Reversed power wires.	Check the power cable for DC voltage, or replace the fuse (6A 250V). Make sure the red wire is connected to the positive (+) battery post, and the black wire is connected to the negative (-) battery post. If the fuse still blows, contact your Dealer.
Popping or whining noise from the speaker while engine runs.	Engine noise.	Reroute the DC power cables away from the engine. Add noise suppressor on power cable. Change to resistive spark plug wires and/or add an alternator whine filter.
Sound is not emitted from the internal or external speaker.	Accessory cable.	Check the connections of the accessory cable (Possible short circuit on the External speaker cable WHITE/SHIELD).
Receiving station report low transmit power, even with transceiver set to HI power.	Antenna.	Have the antenna checked or test the transceiver with another antenna. If the problem persists, contact your Dealer for servicing.
"HI BATTERY" or "LO BATTERY" message is appeared when the power is turned on.	The power supply voltage is too high or too low.	Confirm that the connected power supply voltage is between 10 volts and 17 volts DC. Confirm that the generator has not malfunctioned.
Your position is not displayed.	Accessory cable.	Check the accessory cable connection. Some GPS use the battery ground line for NMEA connection.
	Setting of the GPS navigation receiver.	Check the output signal format of the GPS navigation receiver. This radio requires NMEA0183 format with GLL, RMB, GGA, or GNS sentence as an output signal. If the GPS has a baud rate setting make sure to select 4800 and parity to NONE.

14 CHANNEL ASSIGNMENTS

Tables on the following columns list the VHF Marine Channel assignments for U.S.A. and International use. Below are listed some data about the charts.

1. VTS. Where indicated, these channels are part of the U.S. Coast Guard's **Vessel Traffic System**.
2. Alpha channel numbers, that is, channel numbers followed by the letter A (such as Channel 07**A**) are **simplex** channels on the U.S.A. or Canadian channel assignments whose counterparts in the International assignments are **duplex** channels. International channels do not use "alpha" numbers. If you call the Coast Guard on Channel 16, they will sometimes ask you to "**go to channel 22 Alpha**." This is a channel assigned to U.S.A., and Canadian Coast Guards for handling distress and other calls. If your radio is set for **International** operation you will go to Channel 22 instead of 22**A**, and will not be able to communicate with the Coast Guard. To use Channel 22**A**, your radio must be set for **USA** or **Canada** operation, usually by a U/I/C (USA/International/Canada) control or combination of controls. Channel 22 (without an "A") is an **International** duplex channel for port operations. Some radios indicate an "A" adjacent to the alpha channels on the display; on others "alpha" is not indicated but the proper channel is selected based on the U/I/C setting.
3. Bridge-to-Bridge channels (for example, Channel 13) are for use by bridge operators on intercoastal waterways and rivers. It is also used by marine vessels in the vicinity of these bridges for navigation and for communicating with the bridge operators. Note that a limit of 1 Watt is specified for these channels. See page 26 for additional information.
4. The **S/D** column on the chart indicates either S (simplex) or D (duplex). **Simplex** means transmitting and receiving on the same frequency. Only one party at a time can talk, unlike a telephone. Be sure to say "**over**" and release your microphone push-to-talk switch at the end of each transmission. **Duplex** operation involves the use of one frequency for transmitting and a separate frequency for receiving. On channels specified as duplex on the charts, correct mode of operation is established automatically by your radio when you select a channel; you cannot change the mode. And you still must release the push-to-talk switch after each transmission in order to listen to the radio.
5. Channels normally used by recreational boaters are those that include the term "non-commercial" in the **Channel Use** column of the chart. Some of these are shared with other users and some are used only in certain geographic regions.

6. Marine vessels equipped with VHF radios are required to monitor Channel 16.

VHF MARINE CHANNEL CHART								
CH	U	C	I	S/D	TX	RX	CHANNEL USE	
01		X	X	D	156.050	160.650	Public Correspondence (Marine Operator)	
01A	X			S	156.050		Port Operation and Commercial. VTS in selected areas	
02		X	X	D	156.100	160.700	Public Correspondence (Marine Operator)	
03		X	X	D	156.150	160.750	Public Correspondence (Marine Operator)	
03A	X			S	156.150		US Government only, Coast Guard	
04			X	D	156.200	160.800	Public Correspondence (Marine Operator), Port operation, ship movement	
04A		X		S	156.200		Pacific coast: Coast Guard, East Coast: Commercial fishing	
05			X	D	156.250	160.850	Public Correspondence (Marine Operator), Port operation, ship movement	
05A	X	X		S	156.250		Port operation. VTS in Seattle	
06	X	X	X	S	156.300		Inter-ship Safety	
07			X	D	156.350	160.950	Public Correspondence (Marine Operator), Port operation, ship movement	
07A	X	X		S	156.350		Commercial	
08	X	X	X	S	156.400		Commercial (Inter-ship only)	
09	X	X	X	S	156.450		Boater Calling channel, Commercial & Non-commercial (Recreational)	
10	X	X	X	S	156.500		Commercial	
11	X	X	X	S	156.550		Commercial. VTS in selected areas.	
12	X	X	X	S	156.600		Port operation. VTS in selected areas.	
13	X	X	X	S	156.650		Inter-ship Navigation Safety (Bridge-to-bridge)	
14	X	X	X	S	156.700		Port operation. VTS in selected areas.	
15	X			S	---	156.750	Environmental (Receive only)	
15		X	X	S	156.750		Commercial, non-commercial, ship movement (1 W)	
16	X	X	X	S	156.800		International Distress, Safety and Calling	
17	X	X	X	S	156.850		State Controlled (1 W)	
18			X	D	156.900	161.500	Port operation, ship movement	
18A	X	X		S	156.900		Commercial	
19			X	D	156.950	161.550	Port operation, ship movement	
19A	X			S	156.950		US: Commercial	
19A		X		S	156.950		Coast Guard	
20	X	X	X	D	157.000	161.600	Canadian Coast Guard Only, International: port operations and shipment	
20A	X			S	157.000		Port operation	
21			X	D	157.050	161.650	Port operation, ship movement	
21A	X	X		S	157.050		U.S. Government Only, Canadian Coast Guard	
22			X	D	157.100	161.700	Port operation, ship movement	
22A	X	X		S	157.100		US and Canadian Coast Guard Liaison and Maritime Safety Information Broadcasts announced on channel 16	

VHF MARINE CHANNEL CHART							
CH	U	C	I	S/D	TX	RX	CHANNEL USE
23		X	X	D	157.150	161.750	Public Correspondence (Marine Operator)
23A	X			S	157.150		U.S. Government Only
24	X	X	X	D	157.200	161.800	Public Correspondence (Marine Operator)
25	X	X	X	D	157.250	161.850	Public Correspondence (Marine Operator)
26	X	X	X	D	157.300	161.900	Public Correspondence (Marine Operator)
27	X	X	X	D	157.350	161.950	Public Correspondence (Marine Operator)
28	X	X	X	D	157.400	162.000	Public Correspondence (Marine Operator)
60		X	X	D	156.025	160.625	Public Correspondence (Marine Operator)
61			X	D	156.075	160.675	Public Correspondence (Marine Operator), Port operation, ship movement
61A	X	X		S	156.075		U.S. Government Only, Canadian Coast Guard-Pacific Coast, Commercial Fishing-East Coast
62			X	D	156.125	160.725	Public Correspondence (Marine Operator), Port operation, ship movement
62A		X		S	156.125		Public Coast: Coast Guard; East Coast: commercial fishing only
63			X	D	156.175	160.775	Public Correspondence (Marine Operator), Port operation, ship movement
63A	X			S	156.175		Port Operation and Commercial. VTS in selected areas.
64		X	X	D	156.225	160.825	Public Correspondence (Marine Operator), Port operation, ship movement
64A	X	X		S	156.225		U.S. Government Only, Canadian Commercial Fishing
65			X	D	156.275	160.875	Public Correspondence (Marine Operator), Port operation, ship movement
65A	X	X		S	156.275		Port Operations
66			X	D	156.325	160.925	Public Correspondence (Marine Operator), Port operation, ship movement
66A	X	X		S	156.325		Port Operations
67	X	X	X	S	156.375		US: Commercial. Used for Bridge-to-bridge communications in lower Mississippi River. Inter-ship only, Canada: Commercial fishing, S&R
68	X	X	X	S	156.425		Non-commercial (Recreational)
69	X	X	X	S	156.475		US: Non-commercial (Recreational), Canada: Commercial fishing only, International: Inter-ship, Port operations and Ship movement
70	X	X	X	S	156.525		Digital selective calling (voice communications not allowed)
71	X	X	X	S	156.575		US, Canada: Non-commercial (Recreational), International: Port operations and Ship movement
72	X	X	X	S	156.625		Non-commercial (Inter-ship only)
73	X	X	X	S	156.675		US: Port Operations, Canada: Commercial fishing only, International: Inter-ship, Port operations and Ship movement
74	X	X	X	S	156.725		US: Port Operations, Canada: Commercial fishing only, International: Inter-ship, Port operations and Ship movement

VHF MARINE CHANNEL CHART							
CH	U	C	I	S/D	TX	RX	CHANNEL USE
75	X			S	156.775		Port Operations (Inter-ship only) (1W)
76	X			S	156.825		Port Operations (Inter-ship only) (1W)
77	X	X		S	156.875		Port Operations (Inter-ship only) (1W)
77			X	S	156.875		Port Operations (Inter-ship only)
78			X	D	156.925	161.525	Public Correspondence (Marine Operator), Port operation, ship-movement
78A	X	X		S	156.925		Non-commercial (Recreational)
79			X	D	156.975	161.575	Port operation and Ship movement
79A	X	X		S	156.975		Commercial
80			X	D	157.025	161.625	Port operation, ship movement
80A	X	X		S	157.025		Commercial
81			X	D	157.075	161.675	Port operation, ship movement
81A	X	X		S	157.075		U.S. Government Only - Environmental protection operations.
82			X	D	157.125	161.725	Public Correspondence (Marine Operator), Port operation, ship movement
82A	X	X		S	157.125		U.S. Government Only, Canadian Coast Guard Only
83		X	X	D	157.175	161.775	Canadian Coast Guard Only
83A	X	X		S	157.175		U.S. Government Only, Canadian Coast Guard Only
83		X	X	D	157.175	161.775	Public Correspondence (Marine Operator)
84	X	X	X	D	157.225	161.825	Public Correspondence (Marine Operator)
85	X	X	X	D	157.275	161.875	Public Correspondence (Marine Operator)
86	X	X		D	157.325	161.925	Public Correspondence (Marine Operator)
86			X	S	161.925		Public Correspondence (Marine Operator)
87	X	X		D	157.375	161.975	Public Correspondence (Marine Operator)
87			X	S	161.975		Public Correspondence (Marine Operator)
88	X	X	X	D	157.425	162.025	Public Correspondence (ship-to-coast)
88A	X			S	157.425		Commercial, Inter-ship Only
WX01	X	X	X	D	---	162.550	Weather (receive only)
WX02	X	X	X	D	---	162.400	Weather (receive only)
WX03	X	X	X	D	---	162.475	Weather (receive only)
WX04	X	X	X	D	---	162.425	Weather (receive only)
WX05	X	X	X	D	---	162.450	Weather (receive only)
WX06	X	X	X	D	---	162.500	Weather (receive only)
WX07	X	X	X	D	---	162.525	Weather (receive only)
WX08	X	X	X	D	---	161.650	Weather (receive only)
WX09	X	X	X	D	---	161.775	Weather (receive only)
WX10	X	X	X	D	---	163.275	Weather (receive only)

The above **BOLD** channels are not for use of the general public in U.S. waters, unless proper authorization is given.

15 SPECIFICATIONS

Performance specifications are nominal, unless otherwise indicated, and are subject to change without notice.

15.1 GENERAL

Channels	All USA, International and Canadian
Input Voltage	13.8 VDC \pm 20%
Current Drain	
Standby	0.4 A
Receive	1.5 A
Transmit	5.5 A (Hi); 1.5 A (Lo)
Dimensions	80 H x 180 W x 145 D mm
Flush-Mount Dimensions	64 H x 160 W x 130 D mm
Weight	1 kg

15.2 TRANSMITTER

Frequency Range	156.025 to 157.425 MHz
RF Output	25 W (Hi); 1 W (Lo)
Conducted Spurious Emissions	80 dB (Hi); 66 dB (Lo)
Audio Response	within +1/-3 of a 6 dB/octave pre-emphasis characteristic at 300 to 3000 Hz
Audio Distortion	5 %
Modulation	16K0G3E, for DSC 16K0G2B
Frequency Stability (-20°C to +50°C)	\pm 1.5 kHz
FM Hum and Noise	50 dB

15.3 RECEIVER

Frequency Range	156.050 to 163.275 MHz
Sensitivity	
20 dB SINAD	0.3 μ V
20 dB SINAD (70 CH Receiver)	0.3 μ V
Squelch Sensitivity (Threshold)	0.35 μ V
Modulation Acceptance Bandwidth	\pm 7.5 kHz
Selectivity	
Spurious and Image Rejection	-75 dB
Intermodulation and Rejection at 20 dB SINAD	-70 dB
Audio Output	4.5 W
Audio Response	within + 1/-3 of a 6 dB/octave de-emphasis characteristic at 300 to 3000 Hz
Frequency Stability (-20°C to +50°C)	\pm 1.5 kHz
Channel Spacing	25 kHz
DSC Format	ITU-R M.493
NMEA Input/Output	Output - DSC, DSE Input - GLL, GGA, RMC and GNS

MEMO

Lined area for writing notes, consisting of multiple horizontal dashed lines.

Declaration of Conformity

We, Yaesu Europe B.V. declare under our sole responsibility that the following equipment complies with the essential requirements of the Directive 1999/5/EC.

Type of Equipment:	VHF Transceiver
Brand Name:	STANDARD HORIZON
Model Number:	GX1500E
Manufacturer:	Vertex Standard Co., Ltd.
Address of Manufacturer:	4-8-8 Nakameguro Meguro-Ku, Tokyo 153-8644, Japan

Applicable Standards:

This equipment is tested and conforms to the essential requirements of directive, as included in following standards.

Radio Standard:	EN 300 698-3
	EN 301 025-2
	EN 301 025-3
	EN 301 843-2
EMC Standard:	
	EN 60065
Safety Standard:	

The technical documentation as required by the Conformity Assessment procedures is kept at the following address:

Company: Yaesu Europe B.V.
Address: Cessnalaan 24, 1119NL Schiphol-Rijk, The Netherlands



VERTEX STANDARD CO., LTD.

4-8-8 Nakameguro, Meguro-Ku, Tokyo 153-8644, Japan

VERTEX STANDARD

US Headquarters

10900 Walker Street, Cypress, CA 90630, U.S.A.

YAESU EUROPE B.V.

P.O. Box 75525, 1118 ZN Schiphol, The Netherlands

YAESU UK LTD.

Unit 12, Sun Valley Business Park, Winnall Close
Winchester, Hampshire, SO23 0LB, U.K.

VERTEX STANDARD HK LTD.

Unit 5, 20/F., Seaview Centre, 139-141 Hoi Bun Road,
Kwun Tong, Kowloon, Hong Kong

VERTEX STANDARD (AUSTRALIA) PTY., LTD.

Normanby Business Park, Unit 14/45 Normanby Road
Notting Hill 3168, Victoria, Australia



Copyright 2006

VERTEX STANDARD CO., LTD.

All rights reserved.

No portion of this manual
may be reproduced
without the permission of
VERTEX STANDARD CO., LTD.

