

TOSHIBA
Leading Innovation >>>

OWNER'S MANUAL

LED TV

HDMI[™]
HIGH-DEFINITION MULTIMEDIA INTERFACE

Welcome to Toshiba

- Thank you for purchasing this Toshiba LED TV. This manual will help you use the exciting features of your new TV.
- Instructions in this manual are based on using the remote control.
- You also can use the controls on the TV if they have the same name as those referred to on the remote control.
- Please read all safety and operating instructions in this manual carefully, and keep this manual for future reference.
- "LED TV" means LCD Panel with LED Backlight.

24P1300 Series

29P1300 Series

32P1300 Series

Owner's Record

You will find the model number and serial number on the back of the TV. Record these numbers in the spaces provided below. Refer to them whenever you call upon your TOSHIBA dealer regarding this product.

Model number: _____

Serial number: _____

Pedestal stand Assembling

CAUTION: Before beginning pedestal assembly, carefully lay the front of the LCD Panel face down on a flat, cushioned surface such as a quilt or blanket. Leave the bottom of the unit protruding over the edge of the surface and assemble as indicated.

Note:

Extreme care should always be used when attaching the pedestal stand to avoid damage to the LCD panel.

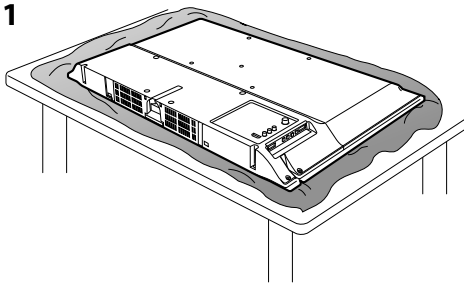

2
29P1300Series models / 32P1300Series models

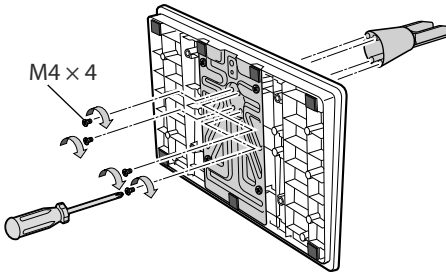

24P1300Series models

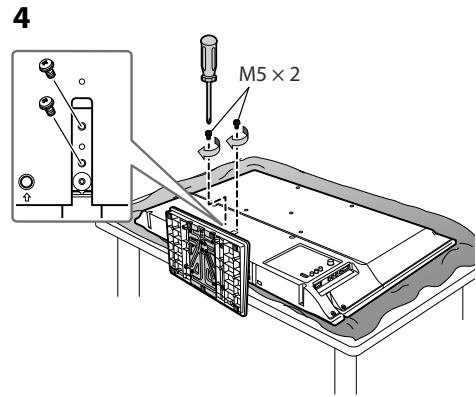
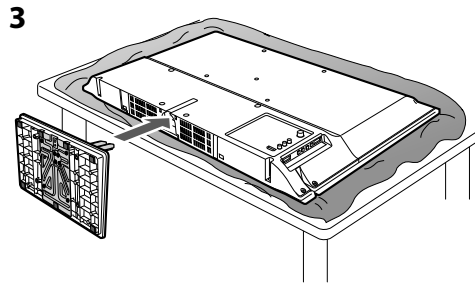
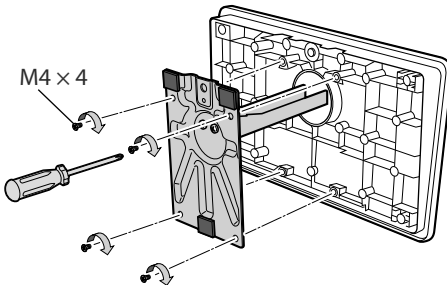

Warning: Ensure the power cable is not pinched when attaching the pedestal stand as this could cause an electric shock.

Contents

Connecting an aerial	6
Exploring your new TV	6
TV panel controls	6
Learning about the remote control	7
TV back panel connections	7
Connecting HDMI devices	8
Turning the TV on	8
Tuning the TV for the first time	9
Using the Quick menu	10
Learning about the menu system	10
Watching TV programmes	11
Selecting the external input source to view	11
Channel List	12
Picture adjustment	12
Sound adjustment	13
Other features settings	14
Teletext	15
Troubleshooting	17
Broadcast system	18
Specifications	18

Important Safety Instructions

Be sure to observe the following instructions and precautions to ensure safe use of this TV.

Installation

1) WARNING: To prevent injury, this apparatus must be securely attached to the floor/wall in accordance with the installation instructions. Install the TV in a horizontal, stable location. Attach the TV to the stand with the mounting screw.

- If the TV is not installed securely, it may lean or fall over and cause an injury.
- To prevent injury, use the exclusive optional stand or wall-hanging bracket to install this TV on the floor or wall securely in accordance with a qualified technician.

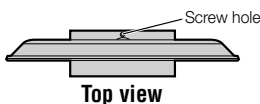

2) Never place the TV in an unstabilized location such as on a shaky table, incline or location subject to vibration.

- Only use cabinets or stands recommended by the TV manufacturer.
- Only use furniture that can safely support the TV.
- Ensure that the TV is not hanging over the edge of the supporting furniture.
- Never place the TV on tall furniture (for example, cupboards or bookcases) without anchoring both the furniture and the TV to a suitable support.
- Never stand the TV on cloth or other material placed between the TV and supporting furniture.

The TV may drop or fall off, which may cause an injury or damage.

3) Never stand or climb on the TV.

- Educate children about the dangers of climbing on furniture to reach the TV or its controls.

Be especially careful in households with children to prevent them through climbing on top of the TV. It may move, fall over, break, become damaged or cause an injury.

4) Always connect the power plug to an appropriate electrical outlet equipped with 110-240 V, AC 50/60 Hz.

Never use the TV outside the specified voltage range. It may cause a fire or an electric shock.

About the fuse (only for E models)

In a three pin earthing-type, the fuse fitted in this plug is approved by ASTA or BSI to BS1362. It should only be replaced by a correctly rated and approved type and the fuse cover must be refitted.

About the use

- Make sure to insert the plugs firmly, when plugging the AC power cord into the TV set end and wall outlet end.
- Make sure to hold the plug, when unplugging the AC power cord.
- Never use other cord except for supplied AC power cord, and never use the supplied power cord for any other purpose.

5) Never insert or remove the power plug with wet hands.

This may cause an electric shock.

6) Never block or cover the slots and openings in the cabinet.

- Never place the TV so that it is facing upward or on its side.
- Never place the TV in a closet, bookcase or other similar area where the ventilation is poor.

- Never drape a newspaper, tablecloth or curtain on the TV.
- When installing the TV against a wall, always keep the TV at least 10 cm away from the wall.
- Never place the TV on a soft unstable surface, such as a carpet, or a cushion.

The inside of this TV will overheat if the ventilation holes are covered, blocked or sealed, which may result in a fire.

7) Never place the TV near a heater or in direct sunlight.

The surface of the cabinet or power cord may melt and result in a fire or an electric shock.

8) Never place the TV in an area exposed to high humidity levels, such as in a bathroom or close to a humidifier.

This may cause a fire or an electric shock.

9) Never place the TV next to a stove where it will be exposed to oil, smoke, or steam, or in a location where there is a large quantity of dust.

This may cause a fire or an electric shock.

10) Precautions for moving the TV

- When moving the TV, be sure to remove the plug from the wall outlet and disconnect the aerial cable and audio/video cables, any steady ties and mounting screw. A fire or an electric shock may result if the power cord is damaged.
- When carrying the TV, at least two people are needed. Be sure to carry it upright.
- Never carry the TV with the screen facing up or down.

11) Precautions for installing on outdoor aerial

An outside aerial system should not be located in the vicinity of overhead power lines, or other electric light or power circuits. If the aerial falls down or drops, it may cause an injury or an electric shock.

Use

1) Never place hot objects or open flame sources, such as lighted candles or nightlights, on or close to the TV.

High temperatures can melt plastic and lead to fires.

2) The apparatus shall not be exposed to dripping or splashing and that no objects filled with liquids, such as vases, shall be placed on the apparatus.

When liquids are spilled or small items are dropped inside the TV, this may cause a fire or an electric shock.

If small objects drop inside the TV, turn off the TV and remove the power plug from the outlet immediately and contact a service technician.

3) Never insert objects (metal or paper) or pour water inside the TV through ventilation holes and other openings.

These items may cause a fire or an electric shock. If these objects are inserted inside the TV, turn off the TV and remove the power plug from the outlet immediately and contact a service technician. Be especially careful that children do not insert objects in the TV.

4) When the TV will not be used for a long period of time, such as during vacation or travel, remove the power plug from the wall outlet for safety.

- The TV is not completely disconnected from the power supply line, as minute current is consumed even when the O/I Power switch is turned off.
- The mains plug or an appliance coupler is used as the disconnect device, therefore the disconnect device shall remain readily operable.

5) Never pull on the power cord when removing the plug from the wall outlet.

Always hold the plug firmly when removing it. If the power cord is yanked, the cord may become damaged and a fire or an electric shock may occur.

6) Never cut, break, modify, twist, bunch up or bent the cord or apply excessive force or tension to it.

Never place heavy objects on the cord or allow it to overheat as this may cause damage, a fire or an electric shock. Contact a service technician if the power cord is damaged.

7) If there is thunder or lightning, never touch the aerial cable or other connected cables.

You may suffer an electric shock.

Service

1) Never repair, modify or disassemble the TV by yourself.

It may cause a fire or an electric shock. Consult a service technician for inspection and repairs.

2) When a malfunction occurs, or if smoke or an unusual odor comes from the TV, turn off the TV and remove the power plug from the outlet immediately.

Make sure that the smoke or smell has stopped, then contact a service technician. If the TV is still used in this condition, it may cause a fire or an electric shock.

3) If the TV is dropped or the cabinet is broken, turn off the TV and remove the power plug from the outlet immediately.

If the TV has power in this condition, it may cause a fire or an electric shock. If the cabinet is broken, be careful when handling the TV to prevent an injury.

Contact a service technician for inspection and repair.

4) When the TV reaches the end of its useful life, ask a qualified service technician to properly dispose of the TV.

Cleaning

CAUTION: Avoid using chemicals (such as air refreshers, cleaning agents, etc.) on or near the TV pedestal. Studies indicate that plastics may weaken and crack over time from the combination effects of chemical agents and mechanical stress (such as weight of TV). Failure to follow these instructions could result in serious injury and/or permanent damage to TV and TV pedestal.

1) Remove the power plug before cleaning.

Never use solvents such as benzine or thinner to clean the TV.

- These solvents may distort the cabinet or damage its finish.
- If rubber or vinyl products remain in contact with the TV for a long time, a stain may result.

If the cabinet becomes dirty, clean it with a soft, dry cloth.

When cleaning the surface of the LCD display, wipe the panel surface gently with a soft, dry cloth.

2) Periodically disconnect the power plug from the outlet and check it.

If dust has collected on the power plug connectors, clean off the dust with a dry cloth.

This dust may cause a fire due to reduced insulation on the plug.

Important information

1) About LCD screen

- If you have the LCD screen facing to the sun, the LCD screen will be damaged. Be aware of locating the TV close to a window or outdoors.
- Never press the LCD screen strongly or scratch it, and never put anything on it. These actions will damage the LCD screen.

2) About cabinet and LCD screen

Never spray volatile compounds such as insecticide on the cabinet and LCD screen.

This may cause a discolouration or damage the cabinet and LCD screen.

3) Some pixels of the screen do not light up

The LCD display panel is manufactured using an extremely high level of precision technology, however sometimes some pixels of the screen may be missing picture elements or have luminous spots. This is not sign of malfunction.

4) About Interference

The LCD display may cause interference in image, sound, etc. of other electronic equipment that receives electromagnetic waves (e.g. AM radios and video equipment).

5) About using under the low temperature places

If you use the TV in the room of 0°C or less, the picture brightness may vary until the LCD monitor warms up. This is not a sign of malfunction.

6) About afterimage

If a still picture is displayed, an afterimage may remain on the screen, however it will disappear. This is not a sign of malfunction.

Exemptions

- Toshiba is not liable for any damage caused by fires, natural disaster (such as thunder, earthquake, etc.), acts by third parties, accidents, owner's misuse, or uses in other improper conditions.
- Toshiba is not liable for incidental damages (such as profit loss or interruption in business, modification or erasure of record data, etc.) caused by use or inability to use of product.
- Toshiba is not liable for any damage caused by neglect of the instructions described in the owner's manual.
- Toshiba is not liable for any damage caused by misuse or malfunction through simultaneous use of this product and the connected equipment.

Trademark Information

- HDMI, the HDMI logo, and High-Definition Multimedia Interface are trademarks or registered trademarks of HDMI Licensing LLC in the United States and other countries.

Connecting an aerial

Optimum reception of colour requires a good signal and will generally mean that an outdoor aerial must be used.

The exact type and positioning of the aerial will depend upon your particular area.

Your Toshiba dealer or service personnel can best advise you on which aerial to use in your area.

Before connecting the aerial cable, turn off all main power switches.

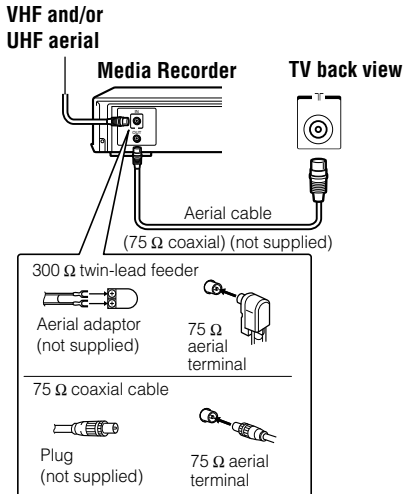

Exploring your new TV

Installing the remote control batteries

Remove the battery cover.

Insert two R03 (AAA) batteries matching the -/+ polarities of the battery to the -/+ marks inside the battery compartment.

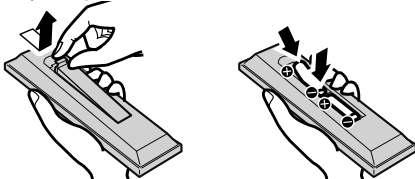

Cautions:

- Dispose of batteries in a designated disposal area. Batteries must not be exposed to excessive heat such as sunshine, fire or the like.
- Attention should be drawn to the environmental aspects of battery disposal.
- Never mix battery types or combine used batteries with new ones.

Notes:

- If the remote control does not operate correctly, or if the operating range becomes reduced, replace both batteries with new ones.
- If the batteries are dead or if you will not use the remote control for a long time, remove the batteries to prevent battery acid from leaking into the battery compartment.

Effective range

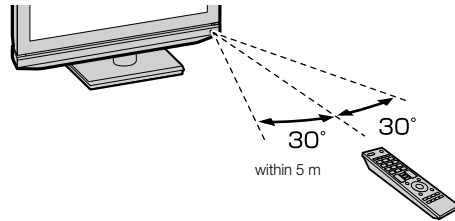

TV panel controls

- You can operate your TV using the buttons on the side panel or the remote control. The back of the panel provide the terminal connections to connect other equipment to your TV.

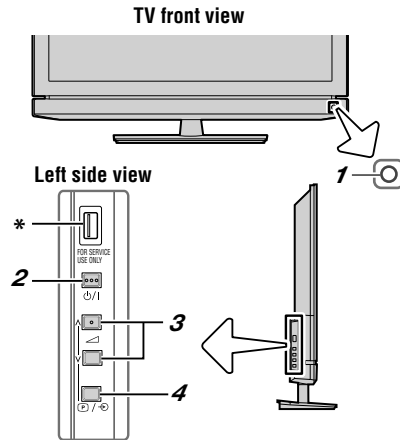

- 1 O/I (**power LED**) — Power indicator.
- 2 O/I (**power on/standby**) — Press to turn the TV on/standby.
- 3 \triangle - + (**volume**) — These buttons adjust the volume level.
 \wedge \vee (**mode up/down**) — When on-screen information is displayed, a programme position can be selected. In external input mode, an input source can be selected.

- 4 / (on-screen information or input source) — This button switches to the on-screen information or the input source selection.

* **USB (FOR SERVICE USE ONLY)** — Terminal for service use only. Not used normally.

Learning about the remote control

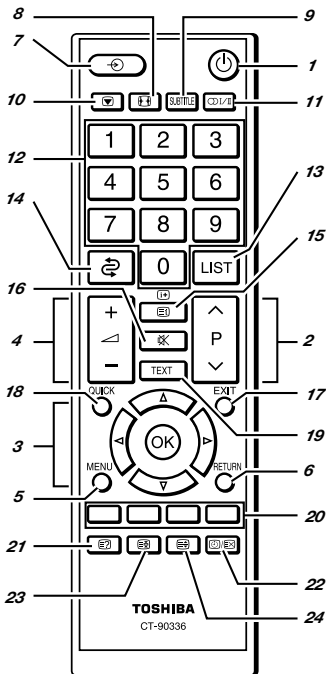

- 1 **Power on/standby** — Press to turn the TV on/standby.
- 2 **Programme position** — When no menu is on screen, these buttons select the programme position.
- 3 **MENU up/down** — When a menu is on-screen, these buttons function as up/down menu navigation buttons.
MENU left/right — When a menu is on-screen, these buttons function as left/right menu navigation buttons or adjust settings.
OK — To confirm your selection.
- 4 **Volume** — These buttons adjust the volume level.
- 5 On-screen Menus
- 6 To return to the previous menu
- 7 Input source selection
- 8 Picture Size
- 9 TEXT Subtitle pages if available

- 10 Picture still
- 11 Stereo/Bilingual selection
- 12 Number buttons (0-9)
- 13 To display the Channel List
- 14 To return to the previous programme
- 15 To display on-screen information Initial/Index function for Teletext
- 16 This button turns the sound off/on
- 17 To exit menu
- 18 To access the Quick Menu
- 19 Teletext on/Superimpose Teletext/off
- 20 Teletext control buttons (Four coloured buttons: Red, Green, Yellow, Blue)
- 21 To reveal concealed text
- 22 To select a page while viewing a normal picture
To select the time display
- 23 To hold a wanted page
- 24 To enlarge the teletext display size

TV back panel connections

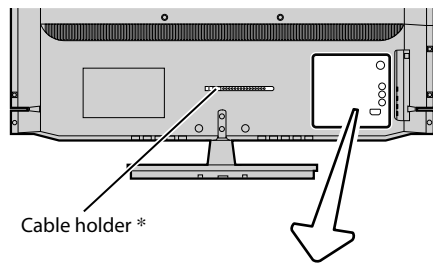

Cable holder *

Connection example

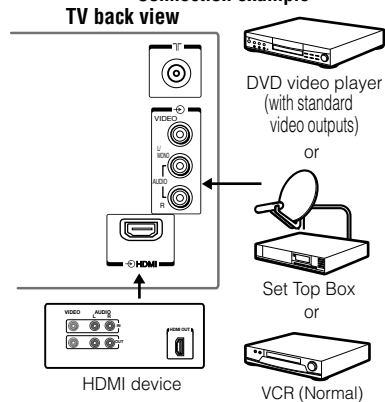

Cable holder *

- * You can use the cable holder to hold the aerial cable, video and audio cables etc.
Never grasp the holder when moving the TV.

- **HDMI (input terminal)** — High-Definition Multimedia Interface input receives digital audio and uncompressed digital video from an HDMI device.
- **T (aerial input terminal)** — Analogue aerial signal input.
- **Ⓜ (video input terminal)** — Standard video and standard stereo audio input.

Notes:

- Before connecting any external equipment, turn off all main power switches.
- The unauthorized recording of TV programmes, DVDs, video tapes and other materials may infringe upon the provisions of copyright law.

Connecting HDMI devices

- When turning on your electronic components, turn on the TV first, and then the HDMI device.
- When turning off your electronic components, turn off the HDMI device first, and then the TV.
- This TV may not be compatible with features and/or specifications that may be added in the future.
- This TV is only operable with L-PCM on 32/44.1/48 kHz and 16/20/24 bits.
- This TV is able to connect with HDMI devices. But it is possible that some HDMI devices may not operate properly with this TV.

The HDMI input on your TV receives digital audio and uncompressed digital video from an HDMI device.

This input is designed to accept HDCP programme material in digital from CEA-861-D compliant consumer electronic devices (such as a set top box and DVD player with HDMI output).

The HDMI input is designed for best performance with 1080i (50/60 Hz) and 1080p (50/60 Hz) high-definition video signals, but will also accept and display 480i, 480p, 576i, 576p, and 720p (50/60 Hz) and VGA (VESA 640 × 480 @ 60/72/75 Hz) signals.

- HDMI: High-Definition Multimedia Interface
- HDCP: High-bandwidth Digital Content Protection
- CEA-861-D compliance covers the transmission of uncompressed digital video with high-bandwidth digital content protection, which is being standardized for reception of high-definition video signals. Because this is an evolving technology, it is possible that some devices may not operate properly with the TV.
- Acceptable PC signal format:
- S-VGA: VESA 800 × 600 @ 56/60/72/75 Hz
- XGA: VESA 1024 × 768 @ 60/70/75 Hz
- W-XGA: VESA 1280 × 768 @ 60 Hz
- W-XGA: VESA 1360 × 768 @ 60 Hz
- S-XGA: VESA 1280 × 1024 @ 60 Hz

However, these signal formats are converted to match the number of pixels of the LCD panel. Therefore, the TV may not display small text properly.



If you connect this unit to your PC, the compressed image is displayed in S-XGA mode, therefore the picture quality may deteriorate and characters may not be read.

- L-PCM: Linear-Pulse Code Modulation
- Supported Audio format: L-PCM sample rate 32/44.1/48 kHz

Turning the TV on

Switching on the TV



Connect the power cord to a wall outlet, the /1 power indicator lights in red (standby mode).

- 1 Press  on the remote control or /1 on the TV left side panel, the /1 power indicator lights in green.

Note:

If you watch black and white programmes when the **Colour System** mode is set to "A" (Automatic), colour noise may appear on the screen. In this case select the appropriate **Colour System** (For the system of each country or region, refer to pages 9, 18).

Switching off the TV

- 1 Press  on the remote control or /1 on the TV left side panel to switch to the standby mode.

Notes:

- When the TV will not be used for a long period of time, such as during vacation or travel, remove the power plug from the wall outlet.
- The TV will automatically turn off in 15 minutes based on **No Signal Power Down** settings ( page 15) if no signal is detected. The TV will automatically turn itself off after approximately 2 hours if you do not operate the TV after turned on by on timer function.
- If power is cut off while you are viewing the TV, the Last Mode Memory function turns on the TV automatically when power is applied again. If power is going to be off for a long time and you are going to be away from your TV, unplug the power cord to prevent the TV from turning on in your absence.

Tuning the TV for the first time

Before switching on the TV, put your decoder and media recorder to standby, if they are connected, and ensure that the aerial is connected. To setup the TV, use the buttons on the remote control as detailed on page 7.

- 1 Press the  button. The **Quick Setup** screen will appear. This screen will appear the first time that the TV is switched on.



- 2 Press ◀ or ▶ to select the menu language .
- 3 Press **OK**, to display the **Location** menu. Press ◀ or ▶ to select **Store** or **Home**. For normal home use, select **Home**. You can select either **Home** or **Store** mode. **Home** is recommended for normal home use. Select **Store** when using a TV for displaying in a shop, etc.

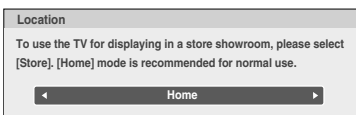

- 4 Press **OK** to display the **Auto Tuning** menu, and then ◀ or ▶ to select **On** or **Off**.

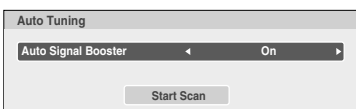

- 5 Select **Start Scan** and press **OK** to start the automatic search.

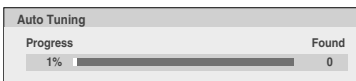

When the automatic search is completed, the TV will automatically appear the **Manual Tuning** menu.

Use the **Manual Tuning** operation if desired channels cannot be preset with the **Auto Tuning** or if you would like to preset channels to specific position numbers one by one.

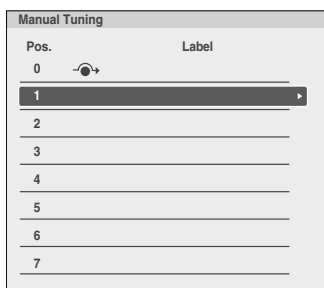

- 6 Press ▼ or ▲ to select the programme position you want to arrange and press **OK** to display the breakdown menu. Press ◀ or ▶ to select an item, then press ▼ or ▲ to select the item as shown below.

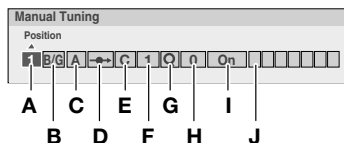

A. Position selection

B. System (Sound) (🔊 page 18)

C. Colour System (🎨 page 18)

A : Automatic (factory set), **P** : PAL,
S : SECAM, **N4** : NTSC 4.43 (MHz),
N3 : NTSC 3.58 (MHz)

If the colour of a certain channel is abnormal, the automatic colour system selection (A) may have malfunctioned, or sound system selection is wrong. In such a case, select another colour and/or sound system (🔊 page 18).

D. Position skip selection

Press ▼ or ▲ to turn the position skip option on "👁️" or off "➡️". The position will then be skipped when you select channels with **P▲** or **P▼**. The "👁️" mark will appear beside a position number when you use the Number button on the remote control.

E. Signal Class

The channel classification.

F. Channel

The channel number on which a station is being broadcast.

G. Channel search operation

Press ▲ to search up the band or ▼ to search down the band.

Press ▼ or ▲ repeatedly until your desired channel is displayed.

When a station is found, it will be displayed. NEVER PRESS ANY OTHER BUTTONS WHILE THE SET IS TUNING.

H. Manual Fine Tuning

Press ▼ or ▲ until better picture and sound are obtained.

I. Signal Booster

If the receiving signal is weak/strong and the picture is noisy, the picture may be improved when using this function.

Press the ▼ or ▲ to turn the **Signal Booster On** or **Off**.

J. Label

Station labels appear under the programme position display each time you turn on the TV, select a channel, or press **1+**.

To change or create station labels:

- 1) Press ∇ or \triangle repeatedly to select a character for the first space, then press \triangleleft or \triangleright .

$\boxed{\text{A} \leftrightarrow \text{Z} \leftrightarrow (\leftrightarrow) \leftrightarrow * \leftrightarrow + \leftrightarrow , \leftrightarrow - \leftrightarrow . \leftrightarrow / \leftrightarrow 0 \leftrightarrow 9 \leftrightarrow \square \leftrightarrow}$

"(blank space)"

- 2) Repeat step 1) to enter the rest of the characters. If you would like a blank space in the label name, you must choose a blank space from the list of characters.

Press **OK** to store your settings.

Notes:

- The **Quick Setup**, **Location**, **Auto Tuning**, **Manual Tuning** menu can also be display at any time from the **SETUP** menu.
- When you preset the channel which sound of broadcast transmission system adopts "M" system (page 18), the sound system may not be tuned correctly if the radio waves transmit badly. At that time, preset the channel by **Manual Tuning**.

Using the Quick Menu

Press **QUICK** to display the **Quick Menu** and use ∇ or \triangle to select the option.

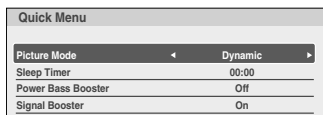

Note:

Quick Menu items are different depending on the current mode.

Quick menu item	Description
Picture Mode	page 13.
Sleep Timer	page 14.
Power Bass Booster	page 14.
Signal Booster	page 9.

Learning about the menu system

We suggest you familiarize yourself with the display charts before using the menu system:

- Press **MENU** to display menu, then press \triangleleft or \triangleright to select main menu headings.
- Press ∇ or \triangle to select an item.
- Press \triangleleft or \triangleright to select or adjust setting.
- Press **OK** to display the next menu.
- Press **EXIT** to close the menu.
- Press **RETURN** to return the previous menu.

Displaying the menu chart

PICTURE

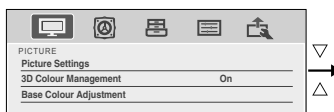

SOUND



APPLICATIONS



PREFERENCES

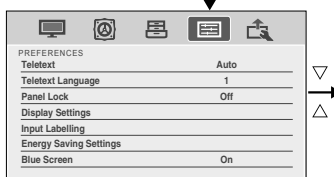

SETUP



Watching TV programmes

Selecting the menu language

You can select a language for the on-screen display.

- Use the menu: **SETUP**
- Use the item: **Menu Language**

Changing the position

- 1 Enter the desired position number using the **Number** buttons on the remote control. For positions below 10, use 0 and the required number e.g., for position 1.
- 2 You can also change the position by using **P** or **P**. The position will be displayed on the screen with the Mono/Stereo/Dual audio status.

Note:

Changing positions between different format channels takes several seconds.

Switching between two positions

You can switch two positions without entering actual position number each time.

- 1 Select the first position you want to view.
- 2 Select the second position with the **Number** buttons (0-9).
- 3 Press **↔**. The previous channel will be displayed.

Each time you press **↔**, the TV will switch back and forth between the two positions.

Displaying the on-screen information

- 1 Press **[+]** to display the following on-screen information.

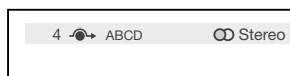

The information will disappear in 6 seconds. To erase the display instantly, press **[+]** again.

Sorting positions

Ex.: To swap channel ABCD (Prog.1) for channel MNOP (Prog.4):

- 1 From the **SETUP** menu, press **▽** or **△** to select **Manual Tuning** menu, and then press **OK**.
- 2 Press **▽** or **△** to select the channel **ABCD**, then press **▷**.

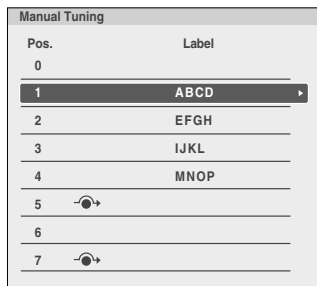

- 3 Press **▽** to select the new position "4", then press **◀**.
- 4 Press **△** to select the channel **MNOP**, then press **▷**.
- 5 Press **△** to select the new position "1", then press **◀**.
- 6 Confirm new **Manual Tuning** menu.

Selecting the external input source to view

- 1 Press **⊞** on the remote control until the video input mode list appears on the screen, then press **▽**, **△** or **⊞** to select appropriate input source (or touch **[D]** / **⊞** and **^** or **v** on the TV left side panel to select required input source directly).
- 2 Press **OK**.
TV (analogue aerial input),
VIDEO (⊞), standard video input),
HDMI (HDMI input)

Labeling external input sources

These input labels are shown in the input selector. You can label external inputs according to the devices you have connected to the TV.

- 1 From the **PREFERENCES** menu, press **▽** or **△** to select **Input Labelling** and then press **OK**.
- 2 Press **▽** or **△** to select the item you want to label and press **◀** or **▷** to select **--**, **Amplifier**, **Cable**, **DVD**, **Game**, **PC**, **Recorder**, **Satellite** or **VCR**, or press the **RED** button to turn on the skip.

Channel List

- 1 Press the **LIST** button. The **Channel List** will appear.
- 2 Press ∇ or \triangle to select a channel, and press **OK** to watch.

Picture adjustment

Selecting the Picture Size

- 1 Press ⏏ repeatedly to select the desired **Picture Size**.

Native

This setting will display the image correctly without distortion or picture clipping.

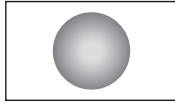

Wide

Use this setting when watching a wide-screen DVD, widescreen video tape or a 16:9 broadcast (when available). Due to the range of wide-screen formats (16:9, 14:9, 20:9 etc.), you may see bars on the top and bottom of the screen.

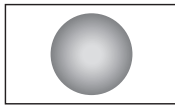

4:3

Use this setting to view a true 4:3 broadcast.

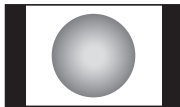

Super Live

This setting will enlarge a 4:3 image to fit the screen by stretching the image horizontally and vertically, holding better proportions at the centre of the image. Some distortion may occur.

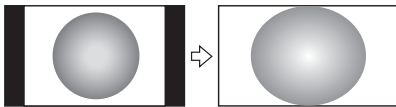

PC Normal

Use this setting for PC connected via HDMI when receiving PC signal format. This setting will display the image correctly without distortion or picture clipping.

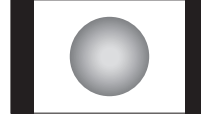

PC Wide

Use this setting for PC connected via HDMI when receiving PC signal format. This setting will display the image without picture clipping.

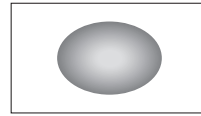

Notes:

- Using the special functions to change the size of the displayed image (e.g. changing the height/width ratio) for the purpose of public display or commercial gain may infringe on copyright laws.
- If the aspect ratio of the selected format is different from the one of the TV transmission or video programme, it can cause a difference in vision. Change to the correct aspect ratio picture size.
- When using the PC connected via HDMI, the moving image quality may be deteriorated.

Using the picture still

- Press ⏏ to freeze the picture. Even if an image is frozen on the TV screen, the pictures are running on the input source. Audio continues to be output as well. To return to a moving picture, press ⏏ again.

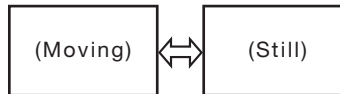

Note:

If you use this function except for the purpose of your private viewing and listening, it may infringe the copyright protected by the copyright laws.

Activating the Picture Mode

This TV offers the choice of personalising the picture style.

Dynamic, Standard, Mild, Movie and **Game** are preset options and affect many features/settings within the TV.

- Use menus: **PICTURE** and **Picture Settings**
- Use the item: **Picture Mode**

Note:

Game mode is available in external input mode (other than aerial input). When you select **Game** mode, suitable widescreen formats will be selected.

Activating the picture preferences

You can customise current **Picture Mode** settings as desired.

- Use menus: **PICTURE** and **Picture Settings**
- Use items: **Contrast, Brightness, Colour, Tint** and **Sharpness**

Setting the Contrast Booster

Contrast Booster improves the contrast of the picture.

- Use menus: **PICTURE** and **Picture Settings**
- Use the item: **Contrast Booster**
- Use modes: **High, Off, Low** and **Middle**

Using the Cinema Mode

A movie film's picture runs at 24 frames a second, whereas movie software such as DVD, etc., that you enjoy watching on TV at home runs at 30 (NTSC) or 25 (PAL) frames a second. To convert this signal to reproduce a smooth motion and picture quality, select the **On** mode.

Effective signal and setup conditions:

- When the Video input mode is selected.
- When the input signal format is 480i, 576i or 1080i signals.
- Use menus: **PICTURE** and **Picture Settings**
- Use the item: **Cinema Mode**

Note:

When a DVD movie with subtitle is playing back, this mode may not work correctly.

Adjusting the Colour Temperature

Colour Temperature increases the warmth or coolness of the picture by setting the red, green or blue tint.

- Use menus: **PICTURE** and **Picture Settings**
- Use items: **Colour Temperature, Red Level, Green Level** and **Blue Level**
- Use modes: **Cool, Natural** and **Warm** etc.

Activating the Noise Reduction (NR)

If the receiving signal of MPEG is a mosquito (grained) noise depending on the compression and conversion, the picture is weak and the picture is blurry, the picture may be improved when using this function.

- Use menus: **PICTURE, Picture Settings** and **Noise Reduction**
- Use items: **Auto Clean, MPEG NR** and **DNR**
- Use modes: **Low, Middle, High** and **Off** etc.

Resetting the Picture Settings

- Use menus: **PICTURE** and **Picture Settings**
- Use the item: **Reset** (select **Yes** and press **OK**)

Adjusting the Colour Management

You can adjust the picture colour quality by selecting from 6 base colour adjustments : **Red, Green, Blue, Yellow, Magenta** or **Cyan**.

- Use menus: **PICTURE, 3D Colour Management (On)** and **Base Colour Adjustment**
- Use items: **Hue, Saturation** and **Brightness**

Resetting the Base Colour Adjustment

- Use menus: **PICTURE, 3D Colour Management (On)** and **Base Colour Adjustment**
- Use the item: **Reset**

Sound adjustment

Setting the MTS (Multi-channel TV Sound)

Auto mode

The **MTS Auto** mode automatically recognize stereo/bilingual programmes depending on the broadcast signal.

Mono mode

If you experience noise or poor reception of any stereo/bilingual programme, set the **MTS** mode to **Mono**.

Noise will be reduced and reception may improve.

- Use the menu: **SOUND**
- Use the item: **MTS**

Note:

If you experience noise with a particular programme on whose channel reception is usually good, try setting **MTS** mode to **Auto**, then switch \odot /I to \square Mono (monaural).

Selecting the Dual 1 or Dual 2 mode



You can hear only **Dual 1** or **Dual 2** sound selected, whenever bilingual programmes are received.

- Use the menu: **SOUND**
- Use the item: **Dual**

Notes:



- When the MTS setting is in **Mono mode**, the **Dual menu** is not selectable.
- The **Dual menu setting status** remains even if the TV is turned off.



Selecting the stereo programmes

When a stereo programme is received,  **Stereo** appears and press .

- Use modes: **Stereo** and **Mono**

Selecting the bilingual programmes

When a bilingual programme is received,  **Dual** appears and press .



Display	Sound to be heard	
	NICAM	German stereo/ bilingual broadcast
 Dual 1	Sub I sound	Main sound
 Dual 2	Sub II sound	Sub sound
 Mono	Main sound	—

Note:

These settings are not stored in the TV memory.

Selecting the monaural programmes

If sound distortion, interruptions or silence arises in the low sound volume level, setting the  **Mono 2** mode will mitigate the problem.

When a monaural programme is received,  **Mono** appears and press .

- Use modes: **Mono 1** and **Mono 2**

Note:

On some cases, the reception of stereo/bilingual broadcasts may not be possible after switching on the  **Mono 2** mode.

Adjusting the sound quality

You can adjust the basic sound quality.

- Use the menu: **SOUND**
- Use items: **Bass**, **Treble** and **Balance**

Using the Power Bass Booster



Power Bass Booster helps to create rich bass.

- Use menus: **SOUND** and **Power Bass Booster**
- Use items: **Super**, **Normal** and **Off**

Other features settings

Setting the On Timer and Sleep Timer

The Timer is especially useful if you want the TV to turn itself on or off after a selected period of time.

- Use the menu: **APPLICATIONS**
- Use items: **On Timer** and **Sleep Timer**
- Use the button: **OK** button, **Number** buttons (0-9),  and 

Configure the following settings in **On Timer**:

Enable On Timer: Select **On** or **Off**.



Input: Select an input source.

Position: Select a channel.

Volume: Select a volume.

Time Until Power On: Set a time until the timer turns on.

After configuring the settings, select **Done** and press **OK**.

Press **EXIT** to exit the menu. Set the Standby mode by pressing  on the remote control or  on the TV.

Note:

The TV will automatically turn itself off after approximately 2 hours if you do not operate the TV after turned on by on timer function.

Using the Auto Format

When the TV receives a true HDMI signal picture and the **Auto Format** is **On**, it will automatically be displayed in HDMI signal format, irrespective of the TV's previous setting.

- Use the menu: **PREFERENCES** and **Display Settings**
- Use the item: **Auto Format**

Activating the 4:3 Stretch

When **4:3 Stretch** is activated, this function will switch 4:3 format programmes into a full screen picture.

- Use the menu: **PREFERENCES** and **Display Settings**
- Use the item: **4:3 Stretch**

Note:

In HDMI signal format, this function is available.

Activating Blue Screen

With the **Blue Screen** function **On**, the screen will automatically turn blue and the sound will be muted when no signal is being received.

- Use the menu: **PREFERENCES**
- Use the item: **Blue Screen**

Note:

The sound is not muted when selecting the external input.

Setting the Automatic Power Down

The TV will automatically turn itself off (standby) after approximately 4 hours, if you don't touch the control buttons on the remote control or on the TV control panel.

- Use the menu: **PREFERENCES** and **Energy Saving Settings**
- Use the item: **Automatic Power Down**

Setting the No Signal Power Down

After 15 minutes of inactivity during no signal, TV will automatically switch to standby. You can change the settings to **Off**.

Default setting is all **On**.

- Use the menu: **PREFERENCES** and **Energy Saving Settings**
- Use the item: **No Signal Power Down**

The No signal Power Down function also works in the following situations:

- Low signal strength of channel (no signal detection)
- Only Audio L/R is connected to external input to listen to music through the TV speakers

Note:

- A warning message will appear 1 minute before turning off.

Panel Lock

Panel Lock disables the buttons on the TV. All buttons on the remote control can still be used.

- Use the menu: **PREFERENCES**
- Use the item: **Panel Lock**

Note:

When **Panel Lock** is **On**, a reminder will appear when the buttons on the TV are pressed.

If the standby button is pressed, the TV will switch off and can only be brought out of standby by using the remote control.

Setting the Colour System

This feature is available in Standard video (composite) inputs mode.

- Use the menu: **SETUP** and **Colour System**
- Use the item: **Auto**, **PAL**, **SECAM**, **NTSC 4.43** or **NTSC 3.58**

Note:

Confirm that **Colour System** is set to "Auto". If not, select "Auto" with ◀ or ▶.

Viewing the System Information

This feature can be used to check the version of software currently installed.

- Use the menu: **SETUP**
- Use the item: **System Information**
- Use the button: **OK**

Resetting the TV

Reset TV will reset all TV settings, including stored channels, to their original factory values.

- Use the menu: **SETUP**
- Use the item: **Reset** (select **Yes** and press **OK**)

Note:

When the set powers back on, the first time screen will appear (see page 8).

Teletext

This TV has a multi-page Teletext memory, which takes a few moments to load and it offers two ways of viewing **Teletext Auto** and **List** which are explained below.

Setting up the Teletext mode

To select a language for Teletext:

The language 1-4 option enables the display of different language when using **Teletext**.

- Use the menu: **PREFERENCES**
- Use the item: **Teletext Language**

Language 1: English, German, Dutch, Flemish, Russian, Bulgarian, Ukrainian, Lettish, Lithuanian, Czech, Slovak, Estonian

Language 2: Polish, German, Dutch, Flemish, Estonian, Lettish, Lithuanian, French, Serbian, Croatian, Slovenian, Czech, Slovak, Rumanian

Language 3: English, French, Hebrew, Turkish, Arabic

Language 4: English, French, Hebrew, Turkish, Farsi (Iranian/Persian)

To select Teletext mode:

Select a channel position with the desired Teletext service.

- Use the menu: **PREFERENCES**
- Use the item: **Teletext**
- Use modes: **Auto** and **List**

Teletext general information

TEXT button

Pressing **TEXT** once will bring up the teletext screen. Press again to superimpose the teletext over a normal broadcast picture. Press again to return to normal TV mode. You need to return to normal viewing if you wish to change channels.

When you first press **TEXT** to access the text service, the first page you see will be the initial page.

In **Auto** mode, this displays the main subjects available and their relevant page numbers.

In **List** mode, you will see the page numbers currently stored on the **each colour** button.

Sub-pages:

Once in this chosen page, if there are sub-pages they will automatically load into memory without changing the one you are reading. If there are many sub-pages, it will take a long time for them all to load and this will depend on the speed with which the broadcaster transmits them.

To access the sub-pages in memory, press < or > to view them.

Using Subtitles

- 1 Press **SUBTITLE** on the remote control while the teletext screen is displayed to display subtitles. While the subtitles are displayed, press **SUBTITLE** again to change the setting.

Using Auto mode

There are two Modes: **Auto** will display FASTEXT, if available. **List** will display your four favorite pages. In either mode, as an alternative to the coloured buttons, you can access a page by entering a 3-digit number, using the **Number** buttons on the remote control, or to advance to the next page, press **P>**, to go back to the previous page press **P<**. To change between **Auto** and **List**, see above.

- Press **TEXT** to access teletext.

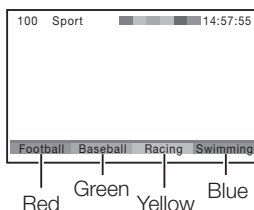

If FASTEXT is available, you will see 4 coloured titles at the base of the TV screen. To access any given subject, simply press the relevant coloured button on the remote control.

If FASTEXT is not available, you can access any page simply by entering a 3-digit page number or pressing the corresponding coloured button. For further information on your particular text system(s), see the broadcast teletext index page or consult your local Toshiba dealer.

Using List mode

- 1 Press **TEXT** to access teletext.

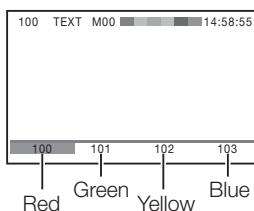

The four choices at the bottom of the screen are now number — **100, 101, 102** and **103**, which have been programmed into the TV's memory.

- 2 To view these pages, use the coloured prompt buttons.
e.g. press the **Green** button to view page 101.
- 3 If you want to change these stored pages, press the coloured button for the colour you want to change.
e.g. Press the **Green** button and enter the 3-digit number.
This number will change and blinking.
- 4 Press **OK** to store your choice. The bars at the bottom of the screen will flash white.
- 5 You may view other pages by simply entering the 3-digit page number — but **NEVER** press **OK** or you will lose the favorite already stored.

Teletext buttons on the remote control

Below is an introduction to the teletext buttons on your remote control and their functions.

To display a page of teletext:

Press **TEXT** to display teletext. Press again to superimpose the teletext over a normal broadcast picture. Press again to return to normal TV mode.

To display an index/initial page:

In Auto-mode
Press  to access the index page. The one displayed is dependant on the broadcaster.

In List-mode

Press  to return to the 100 page or initial page.

To reveal concealed text:

Some pages cover topics such as quizzes and jokes. To discover the solutions, press .

To hold a wanted page:

This function is included as it is part of the broadcast teletext system but you will not need it as this TV allows you to control the display of sub-pages.

To enlarge the teletext display size:

Press  once to enlarge the top half of the page, press again to enlarge the bottom half of the page. Press again to revert to the normal size.



To select a page while viewing a normal picture:

When in teletext mode, if a page selection is made and then  is pressed, a normal picture will be displayed. The TV will indicate when the page is present by displaying the title bar of the text page at the top of the screen. Press **TEXT** to view the page.

Note:

It will not be possible to change programme position while in Teletext mode, you will have to cancel the teletext first by pressing **TEXT** to return to a normal TV picture.

To select the time display:

If you press   while watching a normal TV broadcast, you will see a time display from the broadcaster. It will remain on the screen for about 5 seconds.

9:56 and 25 seconds p.m.

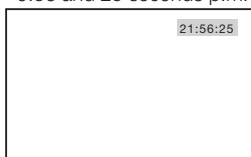
**Troubleshooting**

Before calling a service technician, please check the following table for a possible cause of the symptom and some solutions.



Symptom and solution**TV will not turn on**

- Make sure the power cord is plugged in, and then press .
- The remote control batteries may be dead. Replace the batteries.

No picture, no sound

- Check the aerial connections.

No sound, picture OK

- The sound may be muted. Press  +, - or .
- The station may have broadcast difficulties. Try another channel.

Poor sound, picture OK

- The station may have broadcast difficulties. Try another channel.

Poor picture, sound OK

- Check the aerial connections.
- The station may have broadcast difficulties. Try another channel.
- Adjust the **PICTURE** menu.

Poor reception of broadcast channels

- Check the aerial connections.
- The station may have broadcast difficulties. Try another channel.
- Make sure the **Colour System** is properly set.

Teletext problems

- Check the aerial connections. Good performance of text depends on a good strong broadcast signal.

The brightness of the screen comes down, or flickers of the screen are caused, or some parts of the screen do not light up.

- When you just buy and start to use this TV, a flickering may be caused in the screen. In this case, switch off the TV, then switch on it again to cure the condition.

Some pixels of the screen do not light up

- The LCD display panel is manufactured using an extremely high level of precision technology, however, sometimes some pixels of the screen may be missing picture elements or have luminous spots. This is not a sign of a malfunction.

The picture brightness varies when you display switch the TV on.

- If you switch the TV on at 0°C and under, wait until the warms up.

Multiple images

- The station may have broadcast difficulties. Try another channel.
- Aerial reception may be poor. Use a high directional outdoor aerial.
- Check if the direction of the aerial has changed.

Poor colour or no colour

- The station may have broadcast difficulties. Try another channel.
- Adjust the **Tint** and/or **Colour** in the **PICTURE** menu.

The remote control does not operate

- Remove all obstructions between the remote control and the remote control sensor on the TV.
- The remote control batteries may be dead. Replace the batteries.

Broadcast system

Broadcast transmission systems of each country or region

Asia M.E.

Country or region	Colour	Sound
Bahrain, Kuwait, Israel, Oman, Qatar, United Arab Emirates, Yemen, etc. Indonesia, Malaysia, Singapore, Thailand, etc.	PAL	B/G
China, Vietnam	PAL	D/K
China Hong Kong	PAL	I
Iraq, Islamic Republic of Iran, Lebanon, Saudi Arabia, etc.	SECAM	B/G
Russian Federation, etc.	SECAM	D/K
Myanmar, Republic of the Philippines, etc.	NTSC	M

Africa

Country or region	Colour	Sound
Republic of South Africa, etc.	PAL	I

Note:

PAL, SECAM and NTSC 3.58 (MHz) are different colour signal broadcast transmission systems applicable to different countries or region. NTSC 4.43 (MHz) is used in special VCRs to playback NTSC recorded video tapes through PAL TV equipment.

Specifications

LED TV

Model

24P1300 Series, 29P1300 Series, 32P1300 Series

Power source

110-240 V, AC 50/60 Hz

Power consumption

24" : 25 W, 0.4 W

29" : 40 W, 0.4 W

32" : 40 W, 0.4 W

Dimensions

24" : 552 (W) 430 (H) 135 (D) mm

29" : 666 (W) 503 (H) 180 (D) mm

32" : 734 (W) 543 (H) 180 (D) mm

Mass (Weight)

24" : 3.0 kg

29" : 4.3 kg

32" : 5.0 kg

TV system (Aerial input)

Channel coverage:

PAL	B/G	(CCIR)	VHF	2 - 12
			UHF	21 - 69
			CATV	X - Z+2, S1 - S41
PAL	I	(UK)	VHF	-
			UHF	21 - 69
			CATV	-
PAL	D/K	(CHINA)	VHF	1 - 12
			UHF	13 - 57
			CATV	Z1 - Z38
SECAM	B/G	(CCIR)	VHF	2 - 12
			UHF	21 - 69
			CATV	X - Z+2, S1 - S41
SECAM	D/K	(OIRT)	VHF	1 - 12
			UHF	21 - 69
			CATV	X1 - X19
NTSC	M	(US)	VHF	2 - 13
			UHF	14 - 69
			CATV	A6 - A1, A - W, AA - ZZ, AAA, BBB
NTSC	M	(JAPAN)	VHF	1 - 12
			UHF	13 - 62
			CATV	M1 - M10, S1 - S41

Special RF signal:

NTSC 4.43 colour system

5.5/6.0/6.5 MHz sound system

PAL 60 Hz colour system

5.5/6.0/6.5 MHz sound system

Colour System

PAL, SECAM, NTSC 3.58/4.43

Aspect ratio

16 : 9

Visible size (diagonal)

24" : 59.8 cm

29" : 72.3 cm

32" : 80.0 cm

Number of pixels

24" : 1366 (H) dots × 768 (V) dots

29" : 1366 (H) dots × 768 (V) dots

32" : 1366 (H) dots × 768 (V) dots

Audio power



8 W + 8 W

Speakers

24" : Main 42 × 70 mm 2pcs.

29", 32" : Main 40 × 120 mm 2pcs.

Input / Output terminals

	Input	
	Phono jacks	A/V
	Input (type A)	
	19 pin	A/V Digital
	HDMI (Lip Sync)	

Operating condition

Temperature 0°C - 35°C

Humidity 20% - 80% (No moisture condensation)

Supplied accessories

Owner's manual (1), Remote control (1), Batteries (2), Screw (1) (☞ page 3), Predestal stand (1), Screw (M5 x 2, M4 x 4) (stand type) (☞ page 2)

- Design and specifications are subject to change without notice.
- Never service or remodel the TV by yourself. It may expose you to a fire hazard or dangerous voltages.

Following information is only for India:

The use of this symbol indicates that this product may not be treated as household waste.



By ensuring this product is disposed of correctly, you will help prevent potential negative consequences for the environment and human health, which could otherwise be caused by inappropriate waste handling of this product.

For more detailed information about recycling of this product, please visit our website(<http://www.toshiba-india.com>) or contact call center (1800-200-8674).

License Information on the software used in the TOSHIBA TV

The software pre-installed in the TOSHIBA Televisions consists of multiple, independent software components. Each software component is copyrighted by TOSHIBA or a third party.

The TOSHIBA Televisions uses software components that are distributed as freeware under a third-party end-user license agreement or copyright notice (hereinafter referred to as a "EULA"). Some EULAs require that the source code of the applicable component be disclosed as the condition for distributing the software component in executable format.

You can check EULA related information on the following Home Page:

URL : <http://www.regza-asia.com/support/oss>

In addition, some of the software components which are used in Toshiba Televisions include the software that are made or developed originally by TOSHIBA. These software and accompanied documents are copyrighted by TOSHIBA, and protected by Copyright Act, an international treaty's articles and other governing laws. The software components which are made or developed originally by TOSHIBA and not subject to EULAs are not a target of source code offering.

The Toshiba warranty provided in respect of the TV is the only warranty provided and no additional warranties are provided in respect of the software components subject to EULAs.

Some of the software components distributed under EULAs are made available for use by the user on the premise that they are not copyrighted or warranted by TOSHIBA or any third party. These software components are licensed to the user free of charge and therefore not covered by any warranty within the scope of the applicable laws. These software components are provided in "as is" condition without any warranty, whether express or implied. "Warranty" here includes, but not limited to, an implied warranty for marketability or fitness for specific uses. All risks associated with the quality or performance of these software components are assumed by the user. TOSHIBA shall not be liable whatsoever for any cost of repair or correction or other incidental expense incurred in connection with a defect found in any of these software components. Unless specified under the applicable laws or in a written agreement, a party who changes or redistributes the software with consent from the copyright holders or based on the aforementioned licenses shall not be held liable whatsoever for any loss arising from the use of or inability to use such software components. The same applies even when the copyright holders or relevant third parties have been informed of the possibility of such loss. "Loss" here includes normal, special, incidental and indirect loss (including, but not limited to, the loss of data or its accuracy; loss incurred by the user or any third party; and interface incompatibility with other software). Please read each EULA for details on the use conditions and items that must be observed regarding these software components.

The table below lists the software components pre-installed in the TOSHIBA Televisions, which are subject to EULAs. The user should read the applicable EULAs carefully before using these software components. The EULAs are exhibited in their original text (English) as exactly written by the respective parties other than TOSHIBA.

For at least three (3) years from the date of distribution

of this product, Toshiba will give to anyone who contacts <linux@toshiba-dme.co.jp>, for a charge of no more than our cost of physically performing source code distribution, a complete machine-readable copy of the complete corresponding GPL and LGPL source code for the version of the GPL and LGPL code that we distributed to you in this product.

Pre-Installed Software - EULA

File system(FAT32,NTFS) - Exhibit (A)
libPNG – Exhibit(B)

Exhibit (A)

GNU GENERAL PUBLIC LICENSE

Version 2, June 1991

Copyright (C) 1989, 1991 Free Software Foundation, Inc.,
51 Franklin Street, Fifth Floor, Boston, MA 02110-1301 USA

Everyone is permitted to copy and distribute verbatim copies of this license document, but changing it is not allowed.

Preamble

The licenses for most software are designed to take away your freedom to share and change it. By contrast, the GNU General Public License is intended to guarantee your freedom to share and change free software—to make sure the software is free for all its users. This General Public License applies to most of the Free Software Foundation's software and to any other program whose authors commit to using it. (Some other Free Software Foundation software is covered by the GNU Lesser General Public License instead.) You can apply it to your programs, too.

When we speak of free software, we are referring to freedom, not price. Our General Public Licenses are designed to make sure that you have the freedom to distribute copies of free software (and charge for this service if you wish), that you receive source code or can get it if you want it, that you can change the software or use pieces of it in new free programs; and that you know you can do these things.

To protect your rights, we need to make restrictions that forbid anyone to deny you these rights or to ask you to surrender the rights. These restrictions translate to certain responsibilities for you if you distribute copies of the software, or if you modify it.

For example, if you distribute copies of such a program, whether gratis or for a fee, you must give the recipients all the rights that you have. You must make sure that they, too, receive or can get the source code. And you must show them these terms so they know their rights.

We protect your rights with two steps: (1) copyright the software, and (2) offer you this license which gives you legal permission to copy, distribute and/or modify the software.

Also, for each author's protection and ours, we want to make certain that everyone understands that there is no warranty for this free software. If the software is modified by someone else and passed on, we want its recipients to know that what they have is not the original, so that any problems introduced by others will not reflect on the original authors' reputations.

Finally, any free program is threatened constantly by software patents. We wish to avoid the danger that

redistributors of a free program will individually obtain patent licenses, in effect making the program proprietary. To prevent this, we have made it clear that any patent must be licensed for everyone's free use or not licensed at all.

The precise terms and conditions for copying, distribution and modification follow.

GNU GENERAL PUBLIC LICENSE

TERMS AND CONDITIONS FOR COPYING, DISTRIBUTION AND MODIFICATION

0. This License applies to any program or other work which contains a notice placed by the copyright holder saying it may be distributed under the terms of this General Public License. The "Program", below, refers to any such program or work, and a "work based on the Program" means either the Program or any derivative work under copyright law: that is to say, a work containing the Program or a portion of it, either verbatim or with modifications and/or translated into another language. (Hereinafter, translation is included without limitation in the term "modification".) Each licensee is addressed as "you".

Activities other than copying, distribution and modification are not covered by this License; they are outside its scope. The act of running the Program is not restricted, and the output from the Program is covered only if its contents constitute a work based on the Program (independent of having been made by running the Program). Whether that is true depends on what the Program does.

1. You may copy and distribute verbatim copies of the Program's source code as you receive it, in any medium, provided that you conspicuously and appropriately publish on each copy an appropriate copyright notice and disclaimer of warranty; keep intact all the notices that refer to this License and to the absence of any warranty; and give any other recipients of the Program a copy of this License along with the Program.

You may charge a fee for the physical act of transferring a copy, and you may at your option offer warranty protection in exchange for a fee.

2. You may modify your copy or copies of the Program or any portion of it, thus forming a work based on the Program, and copy and distribute such modifications or work under the terms of Section 1 above, provided that you also meet all of these conditions:
 - a) You must cause the modified files to carry prominent notices stating that you changed the files and the date of any change.
 - b) You must cause any work that you distribute or publish, that in whole or in part contains or is derived from the Program or any part thereof, to be licensed as a whole at no charge to all third parties under the terms of this License.
 - c) If the modified program normally reads commands interactively when run, you must cause it, when started running for such interactive use in the most ordinary way, to print or display an announcement including an appropriate copyright notice and a notice that there is no warranty (or else, saying that you provide a warranty) and that users may redistribute the program under these conditions, and telling the user how to view a copy of this License. (Exception: if the Program itself is interactive but does not normally print such an announcement, your work based on the Program is

not required to print an announcement.)

These requirements apply to the modified work as a whole. If identifiable sections of that work are not derived from the Program, and can be reasonably considered independent and separate works in themselves, then this License, and its terms, do not apply to those sections when you distribute them as separate works. But when you distribute the same sections as part of a whole which is a work based on the Program, the distribution of the whole must be on the terms of this License, whose permissions for other licensees extend to the entire whole, and thus to each and every part regardless of who wrote it.

Thus, it is not the intent of this section to claim rights or contest your rights to work written entirely by you; rather, the intent is to exercise the right to control the distribution of derivative or collective works based on the Program.

In addition, mere aggregation of another work not based on the Program with the Program (or with a work based on the Program) on a volume of a storage or distribution medium does not bring the other work under the scope of this License.

3. You may copy and distribute the Program (or a work based on it, under Section 2) in object code or executable form under the terms of Sections 1 and 2 above provided that you also do one of the following:
 - a) Accompany it with the complete corresponding machine-readable source code, which must be distributed under the terms of Sections 1 and 2 above on a medium customarily used for software interchange; or,
 - b) Accompany it with a written offer, valid for at least three years, to give any third party, for a charge no more than your cost of physically performing source distribution, a complete machine-readable copy of the corresponding source code, to be distributed under the terms of Sections 1 and 2 above on a medium customarily used for software interchange; or,
 - c) Accompany it with the information you received as to the offer to distribute corresponding source code. (This alternative is allowed only for noncommercial distribution and only if you received the program in object code or executable form with such an offer, in accord with Subsection b above.)

The source code for a work means the preferred form of the work for making modifications to it. For an executable work, complete source code means all the source code for all modules it contains, plus any associated interface definition files, plus the scripts used to control compilation and installation of the executable. However, as a special exception, the source code distributed need not include anything that is normally distributed (in either source or binary form) with the major components (compiler, kernel, and so on) of the operating system on which the executable runs, unless that component itself accompanies the executable.

If distribution of executable or object code is made by offering access to copy from a designated place, then offering equivalent access to copy the source code from the same place counts as distribution of the source code, even though third parties are not

compelled to copy the source along with the object code.

4. You may not copy, modify, sublicense, or distribute the Program except as expressly provided under this License. Any attempt otherwise to copy, modify, sublicense or distribute the Program is void, and will automatically terminate your rights under this License. However, parties who have received copies, or rights, from you under this License will not have their licenses terminated so long as such parties remain in full compliance.
5. You are not required to accept this License, since you have not signed it. However, nothing else grants you permission to modify or distribute the Program or its derivative works. These actions are prohibited by law if you do not accept this License. Therefore, by modifying or distributing the Program (or any work based on the Program), you indicate your acceptance of this License to do so, and all its terms and conditions for copying, distributing or modifying the Program or works based on it.
6. Each time you redistribute the Program (or any work based on the Program), the recipient automatically receives a license from the original licensor to copy, distribute or modify the Program subject to these terms and conditions. You may not impose any further restrictions on the recipients' exercise of the rights granted herein. You are not responsible for enforcing compliance by third parties to this License.
7. If, as a consequence of a court judgment or allegation of patent infringement or for any other reason (not limited to patent issues), conditions are imposed on you (whether by court order, agreement or otherwise) that contradict the conditions of this License, they do not excuse you from the conditions of this License. If you cannot distribute so as to satisfy simultaneously your obligations under this License and any other pertinent obligations, then as a consequence you may not distribute the Program at all. For example, if a patent license would not permit royalty-free redistribution of the Program by all those who receive copies directly or indirectly through you, then the only way you could satisfy both it and this License would be to refrain entirely from distribution of the Program.

If any portion of this section is held invalid or unenforceable under any particular circumstance, the balance of the section is intended to apply and the section as a whole is intended to apply in other circumstances.

It is not the purpose of this section to induce you to infringe any patents or other property right claims or to contest validity of any such claims; this section has the sole purpose of protecting the integrity of the free software distribution system, which is implemented by public license practices. Many people have made generous contributions to the wide range of software distributed through that system in reliance on consistent application of that system; it is up to the author/donor to decide if he or she is willing to distribute software through any other system and a licensee cannot impose that choice.

This section is intended to make thoroughly clear what is believed to be a consequence of the rest of this License.

8. If the distribution and/or use of the Program is restricted in certain countries either by patents or by copyrighted interfaces, the original copyright holder who places the Program under this License may add an explicit geographical distribution limitation excluding those countries, so that distribution is permitted only in or among countries not thus excluded. In such case, this License incorporates the limitation as if written in the body of this License.

9. The Free Software Foundation may publish revised and/or new versions of the General Public License from time to time. Such new versions will be similar in spirit to the present version, but may differ in detail to address new problems or concerns.

Each version is given a distinguishing version number. If the Program specifies a version number of this License which applies to it and "any later version", you have the option of following the terms and conditions either of that version or of any later version published by the Free Software Foundation. If the Program does not specify a version number of this License, you may choose any version ever published by the Free Software Foundation.

10. If you wish to incorporate parts of the Program into other free programs whose distribution conditions are different, write to the author to ask for permission. For software which is copyrighted by the Free Software Foundation, write to the Free Software Foundation; we sometimes make exceptions for this. Our decision will be guided by the two goals of preserving the free status of all derivatives of our free software and of promoting the sharing and reuse of software generally.

NO WARRANTY

11. BECAUSE THE PROGRAM IS LICENSED FREE OF CHARGE, THERE IS NO WARRANTY FOR THE PROGRAM, TO THE EXTENT PERMITTED BY APPLICABLE LAW. EXCEPT WHEN OTHERWISE STATED IN WRITING THE COPYRIGHT HOLDERS AND/OR OTHER PARTIES PROVIDE THE PROGRAM "AS IS" WITHOUT WARRANTY OF ANY KIND, EITHER EXPRESSED OR IMPLIED, INCLUDING, BUT NOT LIMITED TO, THE IMPLIED WARRANTIES OF MERCHANTABILITY AND FITNESS FOR A PARTICULAR PURPOSE. THE ENTIRE RISK AS TO THE QUALITY AND PERFORMANCE OF THE PROGRAM IS WITH YOU. SHOULD THE PROGRAM PROVE DEFECTIVE, YOU ASSUME THE COST OF ALL NECESSARY SERVICING, REPAIR OR CORRECTION.

12. IN NO EVENT UNLESS REQUIRED BY APPLICABLE LAW OR AGREED TO IN WRITING WILL ANY COPYRIGHT HOLDER, OR ANY OTHER PARTY WHO MAY MODIFY AND/OR REDISTRIBUTE THE PROGRAM AS PERMITTED ABOVE, BE LIABLE TO YOU FOR DAMAGES, INCLUDING ANY GENERAL, SPECIAL, INCIDENTAL OR CONSEQUENTIAL DAMAGES ARISING OUT OF THE USE OR INABILITY TO USE THE PROGRAM (INCLUDING BUT NOT LIMITED TO LOSS OF DATA OR DATA BEING RENDERED INACCURATE OR LOSSES SUSTAINED BY YOU OR THIRD PARTIES OR A FAILURE OF THE PROGRAM TO OPERATE WITH ANY OTHER PROGRAMS), EVEN IF SUCH HOLDER OR OTHER PARTY HAS BEEN ADVISED OF THE POSSIBILITY OF SUCH DAMAGES.

END OF TERMS AND CONDITIONS

How to Apply These Terms to Your New Programs

If you develop a new program, and you want it to be of the greatest possible use to the public, the best way to achieve this is to make it free software which everyone can redistribute and change under these terms.

To do so, attach the following notices to the program. It is safest to attach them to the start of each source file to most effectively convey the exclusion of warranty; and each file should have at least the "copyright" line and a pointer to where the full notice is found.

<one line to give the program's name and a brief idea of what it does.>

Copyright (C) <year> <name of author>

This program is free software; you can redistribute it and/or modify it under the terms of the GNU General Public License as published by the Free Software Foundation; either version 2 of the License, or (at your option) any later version.

This program is distributed in the hope that it will be useful, but WITHOUT ANY WARRANTY; without even the implied warranty of MERCHANTABILITY or FITNESS FOR A PARTICULAR PURPOSE. See the GNU General Public License for more details.

You should have received a copy of the GNU General Public License along with this program; if not, write to the Free Software Foundation, Inc., 51 Franklin Street, Fifth Floor, Boston, MA 02110-1301 USA.

Also add information on how to contact you by electronic and paper mail.

If the program is interactive, make it output a short notice like this when it starts in an interactive mode:

Gnomovision version 69, Copyright (C) year name of author
Gnomovision comes with ABSOLUTELY NO WARRANTY;
for details type `show w'. This is free software, and you are
welcome to redistribute it under certain conditions; type
`show c' for details.

The hypothetical commands `show w' and `show c' should show the appropriate parts of the General Public License. Of course, the commands you use may be called something other than `show w' and `show c'; they could even be mouse-clicks or menu items--whatever suits your program.

You should also get your employer (if you work as a programmer) or your school, if any, to sign a "copyright disclaimer" for the program, if necessary. Here is a sample; alter the names:

Yoyodyne, Inc., hereby disclaims all copyright interest in the program `Gnomovision' (which makes passes at compilers) written by James Hacker.

<signature of Ty Coon>, 1 April 1989

Ty Coon, President of Vice

This General Public License does not permit incorporating your program into proprietary programs. If your program is a subroutine library, you may consider it more useful to permit linking proprietary applications with the library. If this is what you want to do, use the GNU Lesser General Public License instead of this License.

Exhibit (B)

This copy of the libpng notices is provided for your convenience. In case of any discrepancy between this copy and the notices in the file png.h that is included in the libpng distribution, the latter shall prevail.

COPYRIGHT NOTICE, DISCLAIMER, and LICENSE:

If you modify libpng you may insert additional notices immediately following this sentence.

libpng versions 1.2.6, August 15, 2004, through 1.2.18, May 15, 2007, are

Copyright (c) 2004, 2006-2007 Glenn Randers-Pehrson, and are distributed according to the same disclaimer and license as libpng-1.2.5 with the following individual added to the list of Contributing Authors

Cosmin Truta

libpng versions 1.0.7, July 1, 2000, through 1.2.5 - October 3, 2002, are

Copyright (c) 2000-2002 Glenn Randers-Pehrson, and are distributed according to the same disclaimer and license as libpng-1.0.6 with the following individuals added to the list of Contributing Authors

Simon-Pierre Cadieux
Eric S. Raymond
Gilles Vollant

and with the following additions to the disclaimer:

There is no warranty against interference with your enjoyment of the library or against infringement. There is no warranty that our efforts or the library will fulfill any of your particular purposes or needs. This library is provided with all faults, and the entire risk of satisfactory quality, performance, accuracy, and effort is with the user.

libpng versions 0.97, January 1998, through 1.0.6, March 20, 2000, are

Copyright (c) 1998, 1999 Glenn Randers-Pehrson, and are distributed according to the same disclaimer and license as libpng-0.96, with the following individuals added to the list of Contributing Authors:

Tom Lane
Glenn Randers-Pehrson
Willem van Schaik

libpng versions 0.89, June 1996, through 0.96, May 1997, are

Copyright (c) 1996, 1997 Andreas Dilger

Distributed according to the same disclaimer and license as libpng-0.88, with the following individuals added to the list of Contributing Authors:

John Bowler
Kevin Bracey
Sam Bushell
Magnus Holmgren
Greg Roelofs
Tom Tanner

libpng versions 0.5, May 1995, through 0.88, January 1996, are

Copyright (c) 1995, 1996 Guy Eric Schalnat, Group 42, Inc.

For the purposes of this copyright and license, "Contributing Authors" is defined as the following set of individuals:

Andreas Dilger
Dave Martindale
Guy Eric Schalnat
Paul Schmidt
Tim Wegner

The PNG Reference Library is supplied "AS IS". The Contributing Authors and Group 42, Inc. disclaim all warranties, expressed or implied, including, without

limitation, the warranties of merchantability and of fitness for any purpose. The Contributing Authors and Group 42, Inc.

assume no liability for direct, indirect, incidental, special, exemplary, or consequential damages, which may result from the use of the PNG Reference Library, even if advised of the possibility of such damage.

Permission is hereby granted to use, copy, modify, and distribute this source code, or portions hereof, for any purpose, without fee, subject to the following restrictions:

1. The origin of this source code must not be misrepresented.
2. Altered versions must be plainly marked as such and must not be misrepresented as being the original source.
3. This Copyright notice may not be removed or altered from any source or altered source distribution.

The Contributing Authors and Group 42, Inc. specifically permit, without fee, and encourage the use of this source code as a component to supporting the PNG file format in commercial products. If you use this source code in a product, acknowledgment is not required but would be appreciated.

A "png_get_copyright" function is available, for convenient use in "about" boxes and the like:

```
printf("%s",png_get_copyright(NULL));
```

Also, the PNG logo (in PNG format, of course) is supplied in the files "pngbar.png" and "pngbar.jpg (88x31)" and "pngnow.png" (98x31).

Libpng is OSI Certified Open Source Software. OSI Certified Open Source is a certification mark of the Open Source Initiative.

Glenn Randers-Pehrson
glennrp at users.sourceforge.net
May 15, 2007

TOSHIBA CORPORATION