

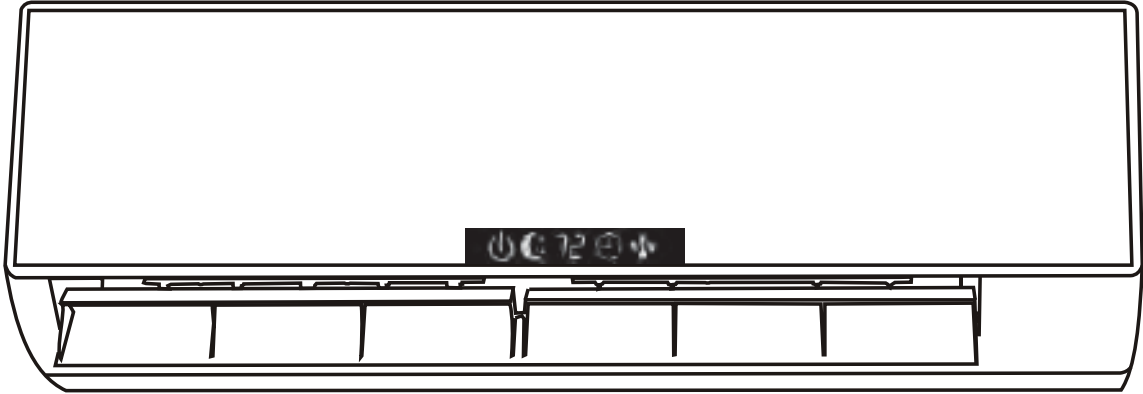

# INSTRUCTION & INSTALLATION MANUAL DUCTLESS MINI SPLIT AIR CONDITIONING SYSTEMS

















# CONTENTS

---





SAFETY PRECAUTIONS.....	1
NAMES OF THE PARTS.....	3
INDOOR UNIT DISPLAY.....	4
EMERGENCY FUNCTION & AUTO-RESTART FUNCTION.....	5
REMOTE CONTROL.....	6
MODES OF OPERATION.....	9
PROTECTION.....	14
INSTALLATION MANUAL.....	15
MAINTENANCE.....	24
TROUBLESHOOTING.....	25



## SAFETY RULES AND RECOMMENDATIONS FOR THE INSTALLER

-  Read this guide before installing and using the appliance.
-  During the installation of the indoor and outdoor units, access to the working area should be off limits to children. Unforeseeable accidents can occur.
-  Make sure that the base of the outdoor unit is securely installed and stable before use.
-  Check that air cannot enter the refrigerant system and check for refrigerant leaks when moving the air conditioner.
-  Carry out a test cycle after installing the air conditioner and record the operating data.
-  The ratings of the fuse installed in the built in-control unit are 3.15A / 250V for 220V units, and 3.15A / 125V for 110V units.
-  The indoor unit must be protected using a fuse of suitable capacity for the maximum input current or with another overload protection device.
-  Ensure the mains voltage corresponds to the voltage stamped on the rating plate. Keep the switch or power plug clean. Insert the power plug correctly and firmly into the socket to avoid risk of electric shock or fire due to insufficient contact.
-  Check that the socket is suitable for the plug or have the socket replaced.





-  Do not install the appliance closer than 50cm from flammable substances (alcohol, etc.) or pressurized containers (e.g. spray cans).
-  If the appliance is used in areas without the possibility of ventilation, precautions must be taken to prevent any leaks of refrigerant gas from remaining in the environment to avoid creating a fire hazard.
-  The packaging materials are recyclable and should be disposed of in separate waste bins. The air conditioner itself must be taken to a special waste collection center for proper disposal.
-  Only use the air conditioner as instructed in this booklet. These instructions are not intended to cover every possible condition or situation. As with any electric household appliance, common sense and caution are therefore always recommended for installation, operation, and maintenance.
-  The appliance must be installed in accordance with applicable national regulations.
-  Before accessing the terminals, all the power circuits must be disconnected from the power supply.





## SAFETY RULES AND RECOMMENDATIONS FOR THE USER

-  Do not try to install the air conditioner alone; always contact trained, experienced personnel.
-  Cleaning and maintenance must be carried out by specialized technical personnel. Under any circumstances, disconnect the appliance from the mains electricity supply before carrying out any cleaning or maintenance.
-  Ensure that the mains voltage corresponds to the rating stamped on the rating plate. Keep the switch and power plug clean. Insert the power plug correctly and firmly into the socket to avoid risk of electric shock or fire due to insufficient contact.
-  Do not pull out the plug to switch off the appliance during operation. Doing so could create a spark and cause a fire or create a fire hazard, etc.







-  Never remain directly exposed to the flow of cold air for extended periods. Direct and prolonged exposure to cold air could be dangerous to your health. Particular care should be taken in rooms where there are children, elderly, or sick individuals.
-  If the appliance gives off smoke or there is a burning smell, immediately disconnect the power supply and contact the Service Center. Prolonged use of the device afterward could cause fire or electrocution.
-  Have repairs carried out only by a Service Center authorized by the manufacturer. Incorrect repair could expose the user to risk of electric shock, fire hazard, etc.







## SAFETY RULES AND RECOMMENDATIONS FOR THE USER

-  This appliance has been made for air conditioning domestic environments and must not be used for any other purpose, such as for drying clothing, cooling food, etc.
-  The packaging materials are recyclable and should be disposed of in separate waste bins. The air conditioner itself must be taken to a special waste collection center for proper disposal.
-  Always use the appliance with the air filter mounted. The use of the conditioner without the air filter could cause an excessive accumulation of dust or waste on the inner parts of the device with possible subsequent failures.
-  The user is responsible for having the appliance installed by a qualified technician, who must check that it is earthed in accordance with current legislation and insert a thermomagnetic circuit breaker.

-  Disable automatic functions if you foresee not using the device for an extended period of time. The air flow direction must also be properly adjusted.
-  The flaps should be directed downwards in heating mode and upwards in cooling mode.
-  Only use the air conditioner as instructed in this booklet. These instructions are not intended to cover every possible condition or situation. As with any electric household appliance, common sense and caution are therefore always recommended for installation, operation, and maintenance.
-  Ensure that the appliance is disconnected from the power supply when it will not be in operation for an extended period and before carrying out any cleaning or maintenance.
-  Selecting the most suitable temperature can prevent damage to the appliance.

## SAFETY RULES AND PROHIBITIONS

-  Do not bend, tug or compress the power cord, since this could damage it. Electrical shock or fire are often caused by damaged power cords. Specialized technical personnel should be the only persons allowed to repair or replace damaged power cords.
-  Do not use extensions or gang modules.
-  Do not touch the appliance when barefoot or parts of the body are wet or damp.
-  Do not obstruct the air inlet or outlet of the indoor or outdoor units. Obstruction of these openings causes a reduction in the operating efficiency of the air conditioner and can lead to consequent failures or damages.
-  Do not alter the characteristics of the appliance in any way.
-  Do not install the appliance in environments where the air could contain gas, oil or sulphur or near sources of heat.
-  This appliance is not intended for use by persons (including children) with reduced physical, sensory, or mental capabilities, or lack of experience and knowledge unless they have been given supervision or instruction concerning use of the appliance by a person responsible for their safety.

-  Do not climb onto or place any heavy or hot objects on top of either the indoor or outdoor unit.
-  Do not leave windows or doors open for long when the air conditioner is in operation.
-  Do not direct the flow of cold air onto plants or animals. Prolonged direct exposure to cold air produced by the air conditioner could have negative effects on plants and animals.
-  Do not put the air conditioner in contact with water. The electrical insulation could be damaged and lead to electrocution.
-  Never insert a stick or similar object into the appliance. Such misuse can lead to injury or damage to the operation of the units.
-  Children should be supervised to ensure that they do not play with the appliance. If the supply cord is damaged, it must be replaced by the manufacturer, an authorized service agent, or similarly qualified personnel to avoid hazard.

# NAMES OF THE PARTS

## INDOOR UNIT

No.	Description
1	Front Panel
2	Air Filter
3	Optional Filter (if installed)
4	LED Display
5	Signal Receiver
6	Terminal Block Cover
7	Ionizer Generator (if installed)
8	Deflectors
9	Emergency Button
10	Indoor Unit Rating Label
11	Airflow Direction Flaps
12	Remote Control

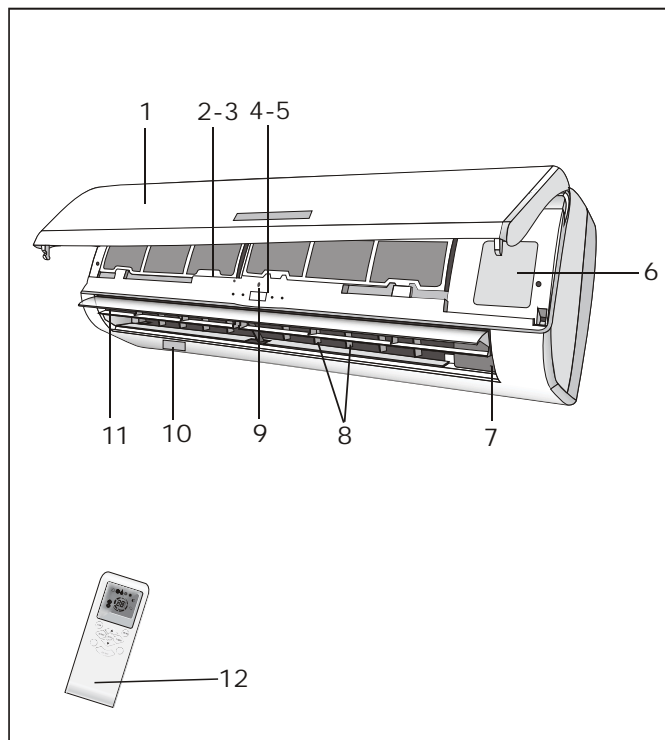

## OUTDOOR UNIT

No.	Description
13	Air Outlet Grille
14	Outdoor Unit Rating Label
15	Cover
16	Gas Valve
17	Liquid Valve

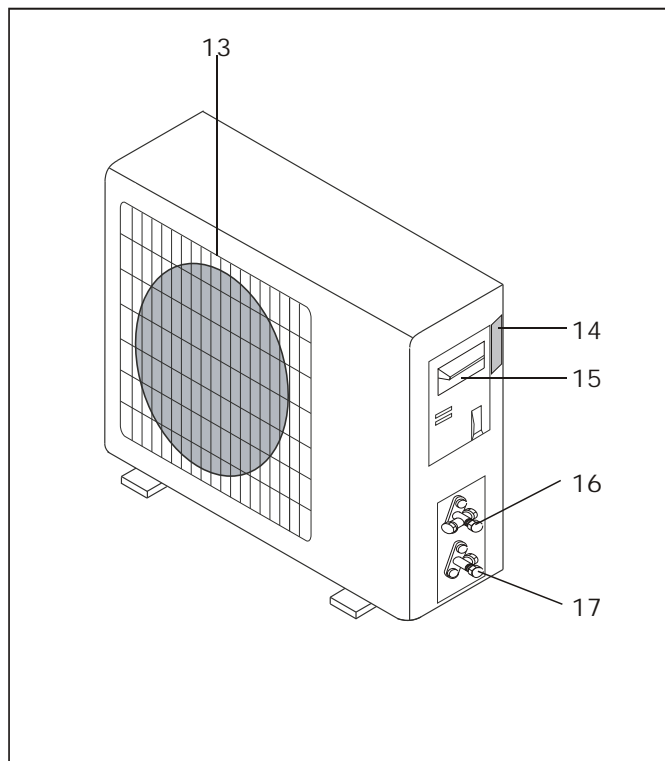





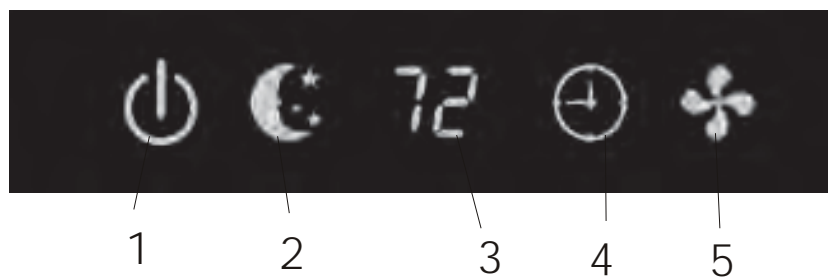

## WALL AIR CONDITIONER

- The air conditioner is made up of two or more units connected to each other through copper pipes (properly insulated) and an electrical connecting cable.
- The indoor unit is installed onto the wall of the room intended to be air conditioned.
- The outdoor unit is installed on the ground or on an outdoor wall using suitable brackets.
- Technical data for the air conditioner is printed on the labels placed on both indoor and outdoor units.
- The remote control is designed for quick and simple use.

NOTE: the above figures are only intended to be a simple diagram of the overall units and may not correspond to the appearance of the units purchased.

# INDOOR UNIT DISPLAY



No.	Led		Function
1	POWER		Shows that the unit is powered
2	SLEEP		SLEEP mode
3	Temperature display (if present)		Indicates the set temperature in C° or F°
4	TIMER		TIMER mode
5	RUN		Unit working

# EMERGENCY FUNCTION AND AUTO-RESTART FUNCTION

## AUTO-RESTART FUNCTION

The appliance comes equipped with a preset Auto-Restart function by the manufacturer. Using this function, the air conditioner can keep the selected settings after a blackout or a voltage drop.

To deactivate the Auto-Restart function, perform the following:

1. Switch the air conditioner off and unplug it.
2. Press and hold the emergency button while plugging it back in.
3. Keep pressing the emergency button for at least 10 seconds until you hear four short beeps from the unit. The Auto-Restart function is now off.

To re-activate the Auto-Restart function, follow the same procedure until you hear three short beeps from the unit.

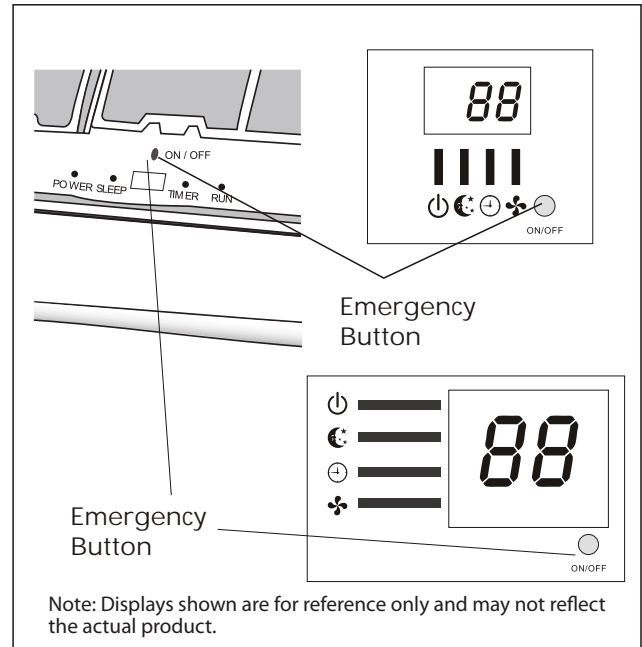



## EMERGENCY FUNCTION

If the remote control is lost, perform the following:

Lift the unit's front panel to reach the air conditioner's emergency button.

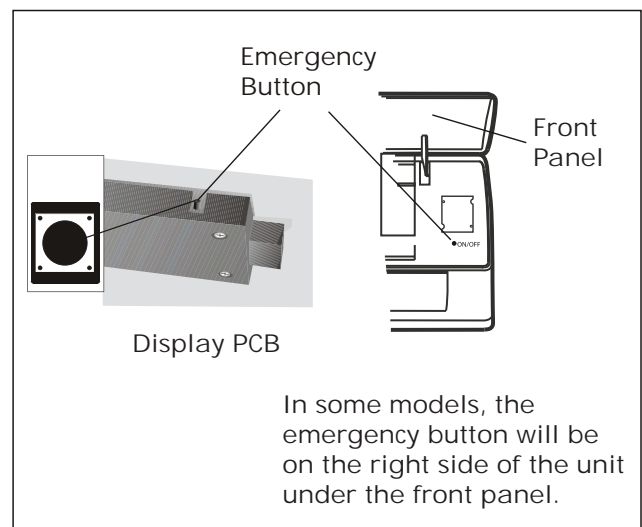
1. Press once and you will hear one beep. The system will operate in forced cool mode.
2. Press twice and you will hear two beeps. The system will operate in forced heat mode. (NOTE: Heating function not available on all models.)
3. To switch off the unit, press the emergency button one more time and you will hear one long beep. After 30 minutes in a forced function mode, the system will automatically begin working in FEEL mode. The FEEL function is described on page 13 of this manual.



 The shape and position of the emergency button may vary according to the model, but their function will be the same.

Note: the external static pressure of heat pumps (on select models) is 0 Pa for all models.

# REMOTE CONTROL

NOTE: The Remote controls all functions of the system.  
If it is lost, the system can still function using the EMERGENCY BUTTON,  
but certain functions will not be accessible.

1 ON/OFF Button   
Starts and stops operation





2 TIMER Button    
Selects TIMER operation

3 UP Button (TOO COOL)   
Increases the set room temperature (16°C - 31°C)  
and time (0.5h-24h)





4 DOWN Button (TOO WARM)   
Decreases the set room temperature (16°C - 31°C)  
and time

5 SLEEP Button    
Sets or cancels sleep function

6 SWING Button   
Adjusts airflow direction

7 FAN Button  
Controls the indoor fan motor speed:  
Auto  High  Med  or Low   
(This function does not work in sleep mode)

8 MODE Button  
Selects the type of operating mode:

- FEEL 
  - COOL 
  - DRY 
  - FAN 
  - HEAT 
- (Heating function not available in all units)

FEEL mode selects the operating mode  
automatically depending on the room temperature  
FEEL mode is the default initial mode

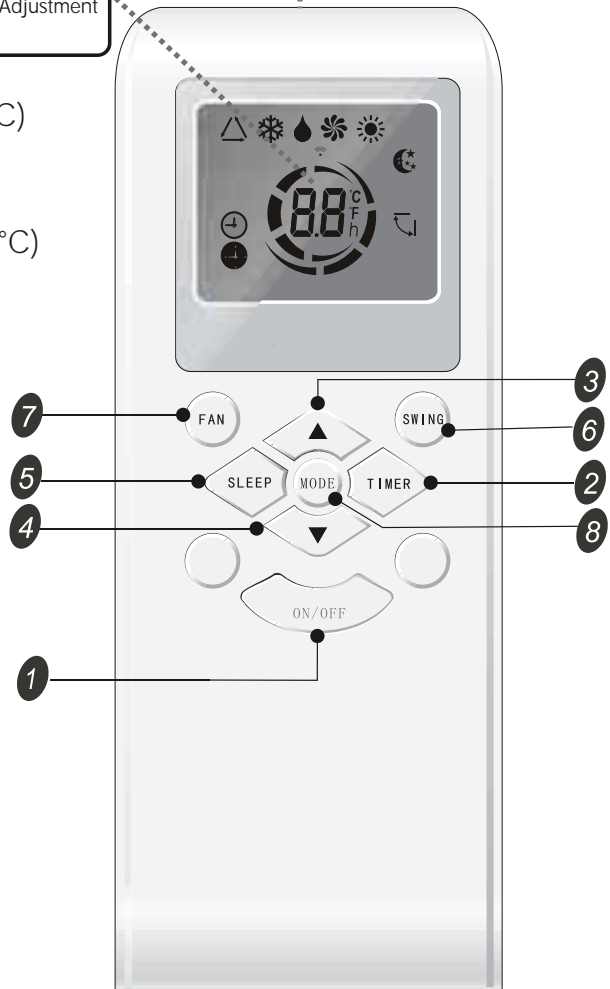
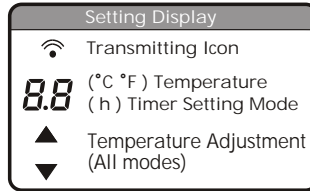

Note: each mode and relevant function will be further specified in following pages.



# REMOTE CONTROL

## Remote Control Display Guide to LCD Symbols

No.	Symbols	Indicator
1	△	FEEL mode
2	❄️	COOL mode
3	💧	DRY mode
4	🌀	FAN ONLY mode
5	☀️	HEATING mode
6	📶	TRANSMIT SIGNAL
7	🕒	TIMER OFF
8	🕒	TIMER ON
9	🌀	AUTO FAN mode
10	🌀	LOW FAN mode
11	🌀	MEDIUM FAN mode
12	🌀	HIGH FAN mode
13	🌙	SLEEP mode
14	↺	FLAP SWING mode

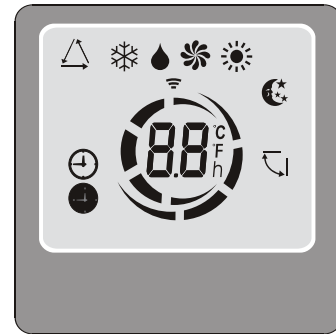

# REMOTE CONTROL PROGRAMMING

## Preliminary Instructions How to Insert the Batteries

- See **Diagram 1**: Remove the cover from the battery compartment by sliding it in the direction of the arrow.
- Insert the new batteries, ensuring that the (+) and (-) symbols are correct.
- Replace the cover by sliding it into place.

⚠ Use 2 LRO 3 AAA (1.5V) batteries. Do not use rechargeable batteries. Replace the old batteries with new ones of the same type when the display is no longer legible.

⚠ The remote control batteries must be disposed of in accordance with the applicable laws in place in the country of use.

See **Diagram 2**:  
When you insert the remote control's batteries for the first time or if you change them, you may see a DIP switch under the back cover (select models).

DIP switch position	Function
DIP 1 ON: °C	The display will read in degrees Celsius.
DIP 1 OFF: °F	The display will read in degrees Fahrenheit.
DIP 2 ON: Cool	The remote control is set to cooling only mode.
DIP 2 OFF: Heat	The remote control is set to heating only mode.

⚠ **NOTE:** Heating function not available on all units. After adjusting the DIP switches, you will need to remove the batteries and re-insert them using the above procedure to reset the remote control.

See **Diagram 3**:  
When inserting the remote control's batteries for the first time or if you change them, you will need to program the remote to function in cooling or heating mode (if available).

⚠ Immediately after inserting the batteries, the remote's LCD display will flash the COOL symbol ❄ and the HEAT symbol ☀ one at a time. If a button is pressed while the COOL symbol ❄ is displayed, the remote will be set to operate the system in cooling only mode. If a button is pressed while the HEAT symbol ☀ is displayed, the remote will be set to operate the system in heating only mode (if applicable).

⚠ **NOTE:** The remote will not be able to operate the system in cooling only mode if it is set to heating only mode. Also, it will not be able to operate the the system in heating only mode if set to cooling only

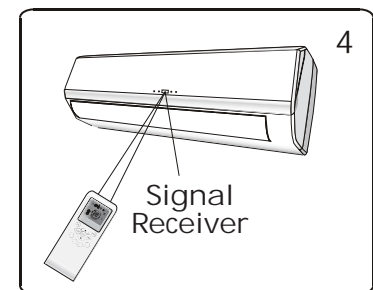
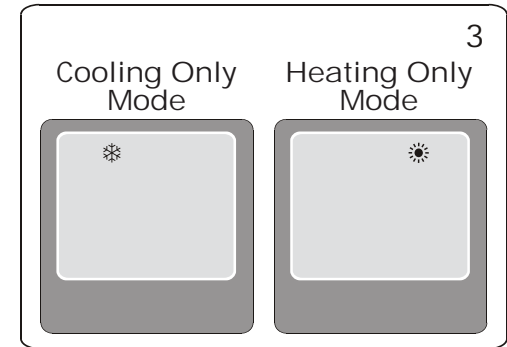
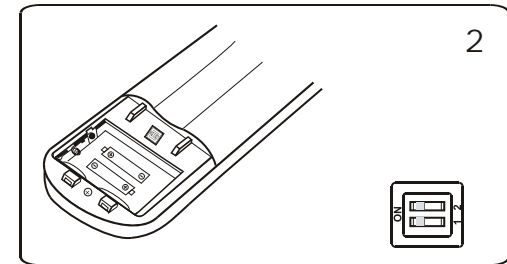
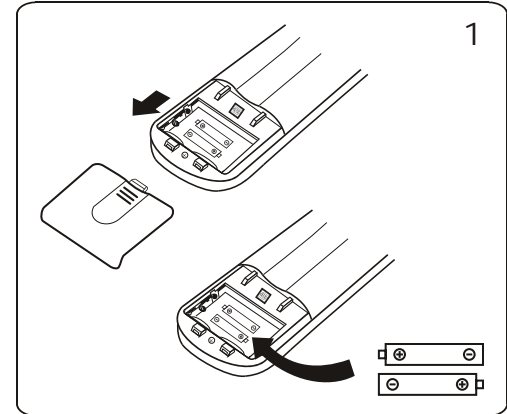

**To Use**  
See **Diagram 4**:

- Direct the remote control toward the indoor unit
- Make sure no objects are between the remote and the signal receiver.
- Select the desired function by pressing the appropriate button on the remote control.
- Do not leave the remote exposed to direct sunlight for extended periods of time.
- Keep the remote at least 1m away from other electrical appliances, such as televisions or microwave ovens.

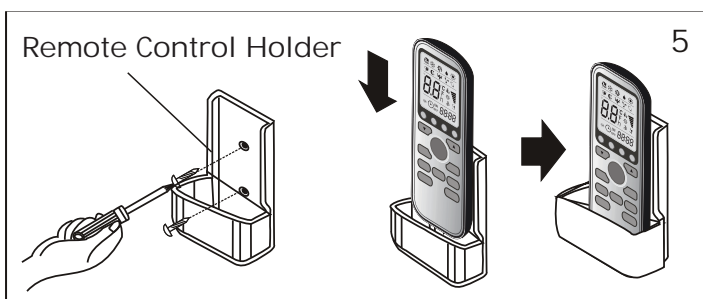

It is recommended to use the supplied Remote Control Holder for easy location and usage. The supplied holder may be mounted to a wall as shown in **Diagram 5**.

# MODES OF OPERATION

This air conditioner is designed to create a comfortable climate for individuals in the affected room. All models can cool and dehumidify the air completely automatically and some models can also provide heat using either a heat pump or electric heat.

Air pulled by the fan enters through the grill of the front panel and passes through the filter, which traps dust inside. Air is then sent to the heat exchanger and is cooled, dehumidified, or re-heated by the heat exchanger.

Heat removed from the air is then sent outside.

When the cycle is finished, the fan sends the freshened air back into the room. The direction of the air outlet is regulated by the flaps, which are motorized to move up and down as well as left and right by the vertical deflectors.

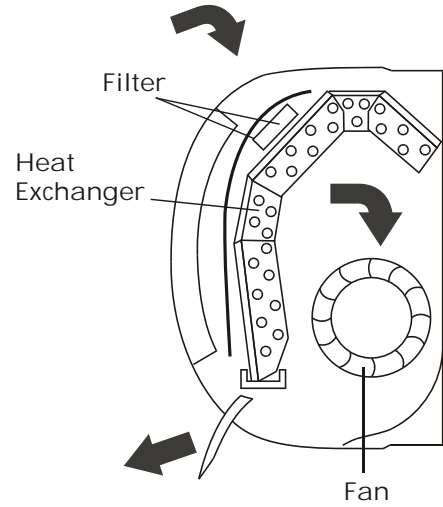

## 'SWING' CONTROL OF AIR FLOW



- The air flow from the outlet is uniformly distributed throughout the room.
- Air can be directed in a particular way for optimum effect.

The SWING button on the remote controls the position of the flaps, causing air to be directed up or down. For best results and to guarantee even diffusion of air in the room, use the following tips:

- In cooling mode, orient the flaps horizontally or slightly upward
- In heating mode (if applicable), orient the flaps downward, as warm air will always tend to rise upward.

Vertical deflectors can be positioned manually and are located under the flaps. By adjusting these, air can be directed to flow to the right or to the left.

**⚠** Manual adjustment of the deflectors must be done with the unit switched off.

**CAUTION:** Never position the flaps manually; the control mechanism is delicate and can be seriously damaged.

**DANGER:** Never insert your hand or any objects into the air outlet of the units - all units contain a fan that operates at high speed.

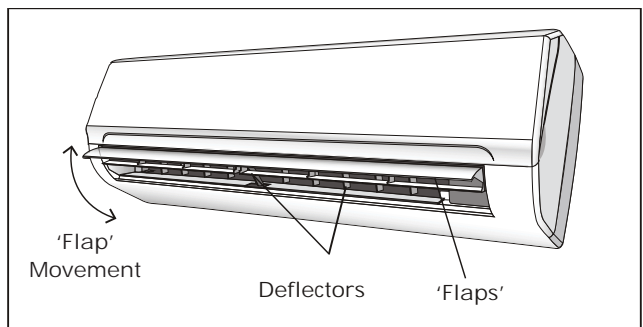
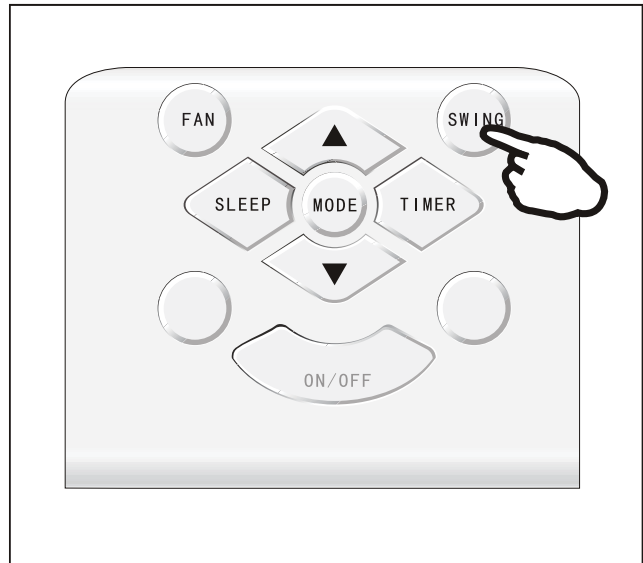

# MODES OF OPERATION

## COOLING MODE



The cooling function allows the air conditioner to cool the room while dehumidifying the air at the same time.

To activate the cooling function (COOL), press the MODE button until the symbol ❄️ (COOL) appears on the LCD display.

The cooling cycle is activated by using the ▲ or ▼ keys to set the system to a temperature lower than that of the room.

To adjust the system to an optimal level, set the temperature, the speed, and the direction of air flow using the correct keys.

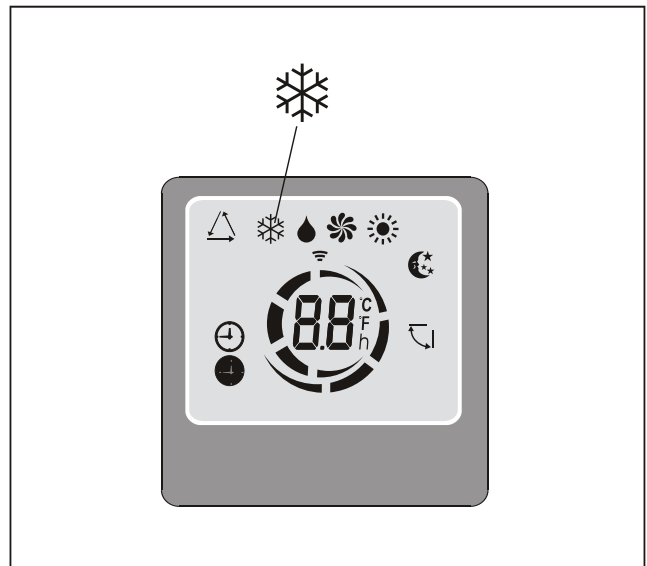

## HEATING MODE (SELECT MODELS)



The heating function allows the air conditioner to produce hot air either through a heat pump or using electric heat.

To activate the heating function (HEAT), press the MODE button until the symbol ☀️ (HEAT) appears on the LCD display.

The heating cycle is activated by using the ▲ or ▼ keys to set the system to a temperature higher than that of the room.

To adjust the system to an optimal level, set the temperature, the speed, and the direction of air flow using the correct keys.

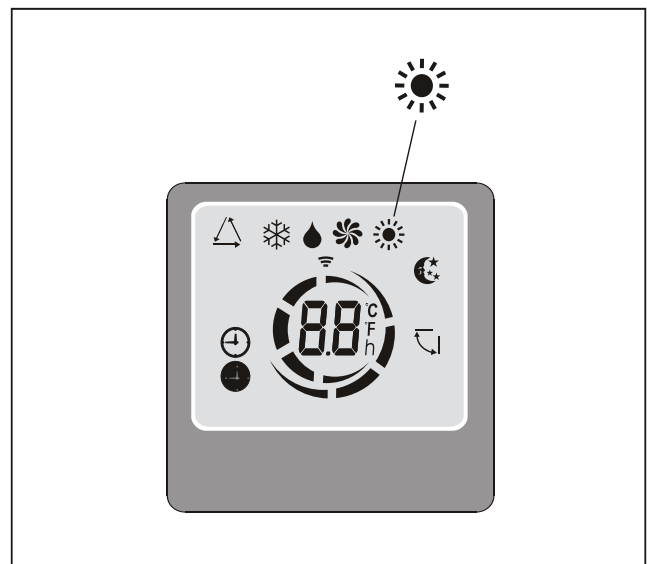

⚠️ Each unit that includes heating is fitted with a Hot Start function, which delays immediate startup of the system for several seconds so that air produced will be immediately hot.

⚠️ During heating mode, the unit can automatically activate a defrost cycle, which is essential to clear the condenser from a excess deposit of frost. The process usually lasts for 2-10 minutes and during defrosting, the fan will stop operating. After completing the defrost cycle, it will return to heating mode automatically.

# MODES OF OPERATION

## TIMER MODE - TIMER ON

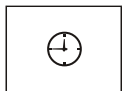

The TIMER function allows the system to automatically switch on.

To set timed start, the system should be turned off.

Press TIMER, set the desired temperature by pressing the ▲ or ▼ buttons. Press TIMER again and set the amount of time, again using the ▲ or ▼ buttons. Press TIMER again until the display shows the amount of time entered until the programmed TIMER start. The timer is now set.

**IMPORTANT NOTE:** Before setting a timed start, you must choose which mode the system will begin running in. Press the MODE button to select the correct system function, press the FAN button to select the correct fan speed, then turn the system off using the ON/OFF button. You may then set a timed start using the above instructions.

To cancel a timed start that has already been entered, press the TIMER button again.

If the system is powered off, it will be necessary to reset a timed start again using the above instructions.

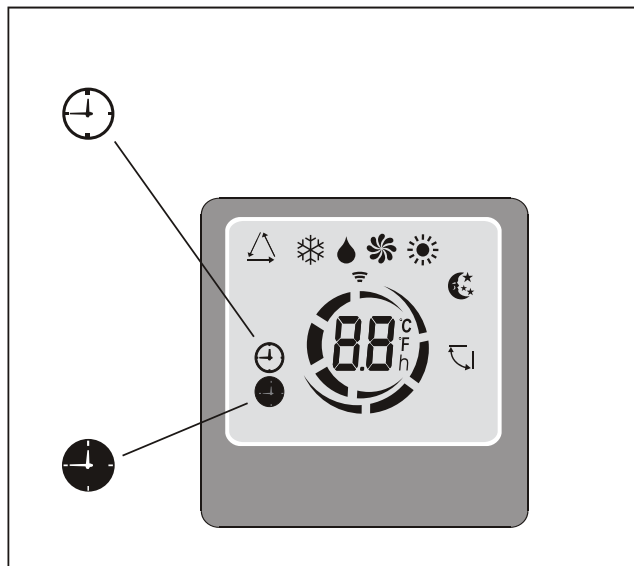

## TIMER MODE - TIMER OFF



The TIMER function allows the system to automatically switch off as well.

To set a timed stop, the system should be turned on.

Press the TIMER button, then use the ▲ or ▼ buttons to set the amount of time desired until the system will automatically stop. As you do this, the display will show the amount of time the system can be programmed to stop after.

To cancel a timed stop that has already been entered, press the TIMER button again.

If the system loses power or is turned off, it will be necessary to reset a timed stop again using the above instructions.

 **NOTE:** Both timed starts and timed stops can only be programmed in half hour increments.

# MODES OF OPERATION

## FAN MODE



The system can be set to run in FAN mode, providing ventilation only.

To run the system in FAN mode, press the MODE button until the FAN symbol  appears on the display. Pressing the FAN button while in this mode changes the fan speed to LOW, MEDIUM, HIGH, or AUTO.

The remote control will automatically save the last fan speed setting from the previous time the system was in operation.

In FEEL mode (automatic), the air conditioner will automatically select the appropriate fan speed and mode of operation, COOL or HEAT (if available).

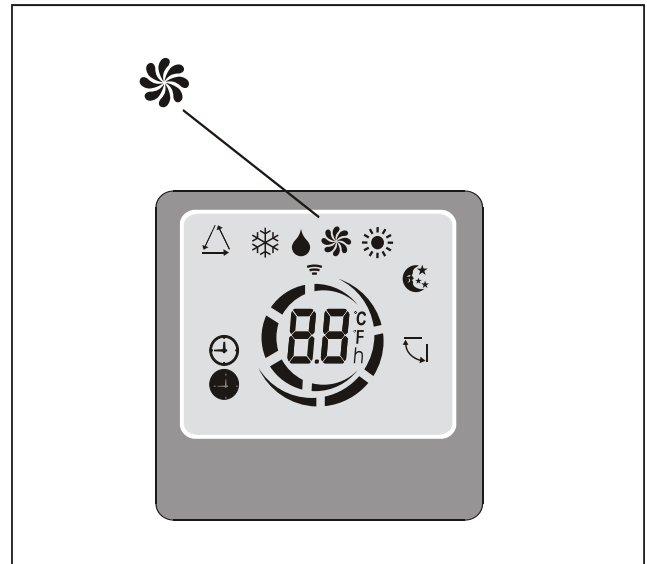

## DRY MODE



The system can also be set to run in DRY mode, reducing the humidity of the air in the room for increased comfort.

To run the system in DRY mode, press the MODE button until the DRY symbol  appears on the display. The air conditioner will automatically cycle between cooling and fan only modes to dehumidify the air.

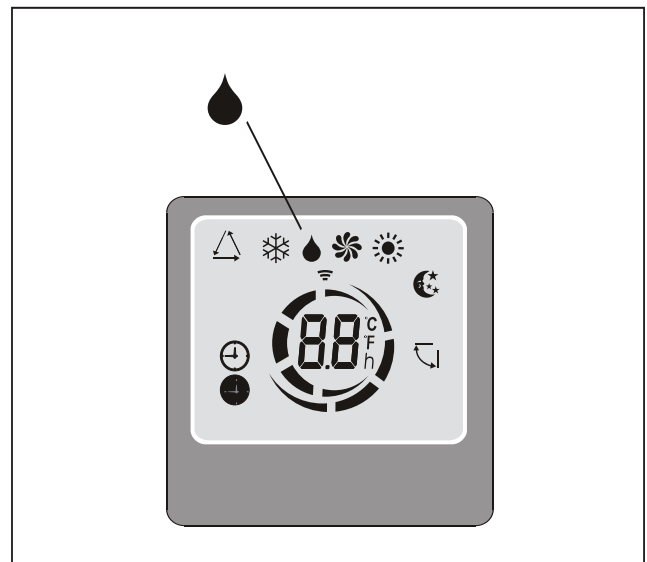

# MODES OF OPERATION

## FEEL MODE



The initial default operating mode is FEEL. FEEL mode automatically adjusts the function of the system based on a temperature range.

To set the air conditioner to FEEL mode, press the MODE button until the FEEL symbol  $\triangle$  appears on the display.

While in FEEL mode, the fan speed and the temperature are automatically set according to the room temperature. The room temperature is measured by a sensor built into the indoor unit and is programmed to stay within a certain range.

Ambient Temp.	Operation Mode	Auto Temp.
< 20° C	HEAT (if available) FAN (cool only units)	23° C
20° C - 26° C	DRY mode	18° C
> 26° C	COOL mode	23° C

For optimal performance of your air conditioner, only adjust the temperature  $\pm 2^{\circ}$  C, and adjust the fan speed and direction of air flow by using the FAN control function and correct positioning of the deflectors.

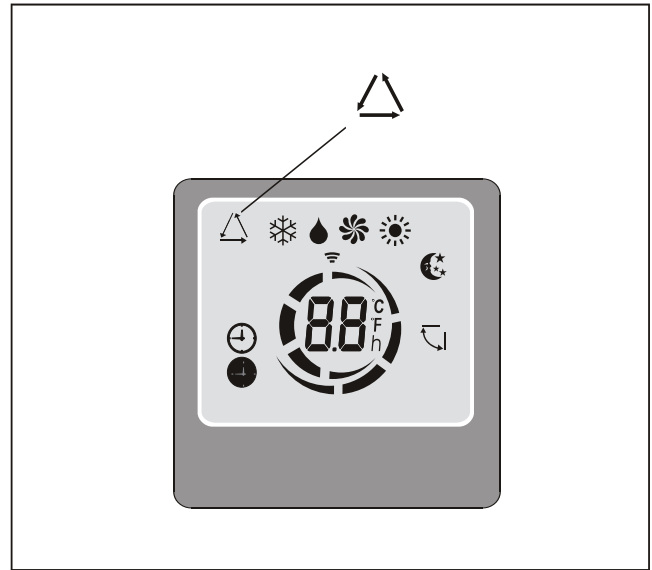

## SLEEP MODE



This system can also function in SLEEP mode, which will automatically adjust the temperature to maximize comfort during night time sleep.

To put the air conditioner into SLEEP mode, press the SLEEP button until the SLEEP symbol  $\text{☾}$  appears on the display.

If the system is set to run using the cooling or DRY function, the set temperature will automatically be raised by 1° C every 60 minutes for a total of 2° C during the first 2 hours.

If the system is set to run using the heating function, the set temperature will be gradually lowered by 2° C during the first 2 hours.

After 10 hours operating in SLEEP mode, the system will switch off automatically.

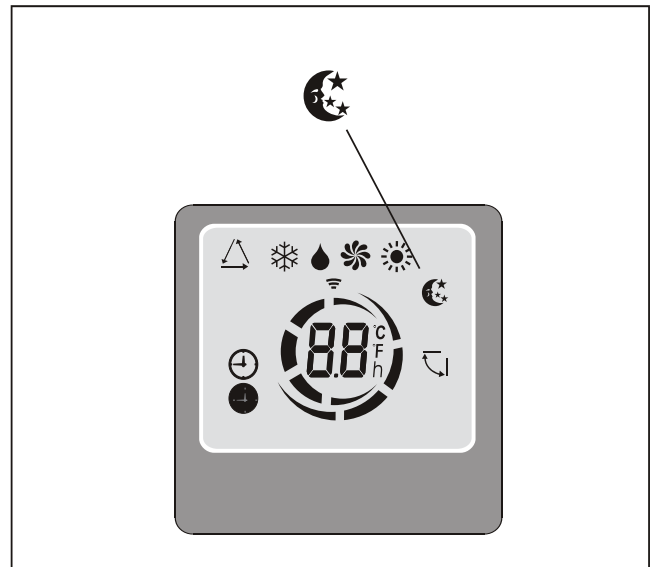

# PROTECTION

In the cases listed below, the built-in protective device may be tripped, causing the system to stop operation.

For T1 Climate condition models:

No.	MODEL	
1	Heating	Outdoor air temperature is over 24° C
		Outdoor air temperature is below -7° C
		Room temperature is over 27° C
2	Cooling	Outdoor air temperature is over 43° C
		Room temperature is below 21° C
3	Dry	Room temperature is below 18° C

For Tropical (T3) Climate condition models:

No.	MODEL	
1	Heating	Outdoor air temperature is over 24° C
		Outdoor air temperature is below -7° C
		Room temperature is over 27° C
2	Cooling	Outdoor air temperature is over 52° C
		Room temperature is below 21° C
3	Dry	Room temperature is below 18° C

 After stopping and restarting the air conditioner or after changing the mode during operation, will not restart immediately; as a protective measure for the compressor, it will pause for three minutes before resuming normal function.



# SELECTING THE INSTALLATION PLACE

## INDOOR UNIT

- Install the indoor unit level on a strong wall that is not subject to vibrations.
- The inlet and outlet ports should not be obstructed: the air should be able to blow all over the room.
- Do not install the unit near a source of heat, steam, or flammable gas.
- Install the unit near an electric socket or private circuit.
- Do not install the unit where it will be exposed to direct sunlight.
- Install the unit where connection between indoor and outdoor unit is as easy as possible.
- Install the unit where it is easy to drain the condensed water.
- Check the machine operation regularly and leave the necessary spaces as shown in the picture.
- Install the indoor unit where the filter can be easily accessible.

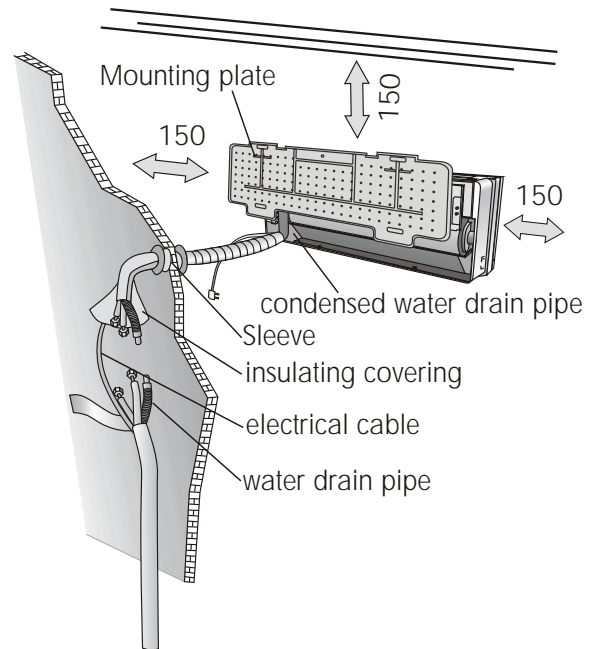

minimum space to be left (mm) showing in the picture

## OUTDOOR UNIT

- Do not install the outdoor unit near sources of heat, steam or flammable gas.
- Do not install the unit in too windy or dusty places.
- Do not install the unit where people often pass. Select a place where the air discharge and operating sound level will not disturb the neighbours.
- Avoid installing the unit where it will be exposed to direct sunlight (otherwise use a protection, if necessary, that should not interfere with the air flow).
- Leave the spaces as shown in the picture for the air to circulate freely.
- Install the outdoor unit in a safe and solid place.
- If the outdoor unit is subject to vibration, place rubber gaskets onto the feet of the unit.

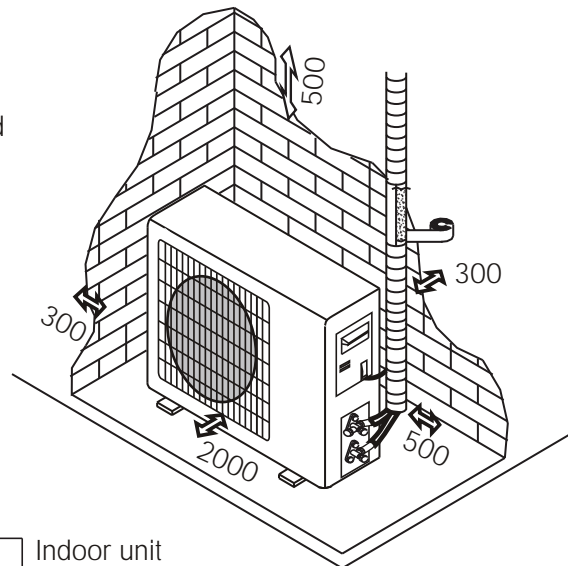

## INSTALLATION DIAGRAM

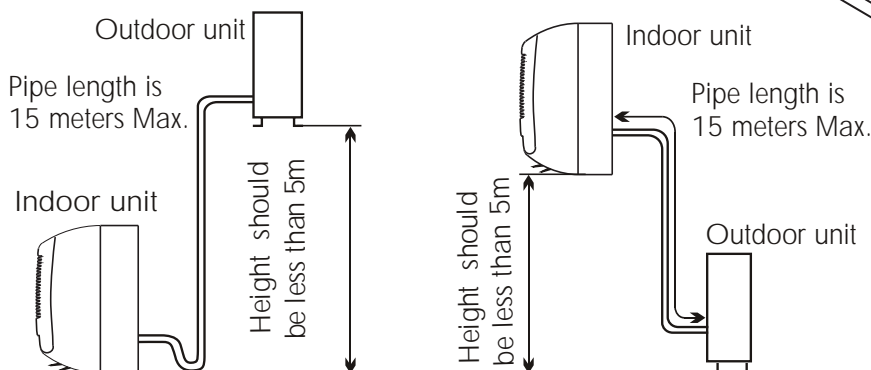

Only persons and/or companies qualified and experienced in the installation, service and repair of refrigerant products should be permitted to do so. The purchaser must ensure that the person and/or company who is to install, service or repair this air conditioner has qualifications and experience in refrigerant products.

# INSTALLATION OF THE INDOOR UNIT

Before starting installation, decide on the position of the indoor and outdoor units, taking into account the minimum space required around the units

⚠ Install the indoor unit in the room to be air conditioning, avoiding to install in corridors or communal areas.

⚠ Install the indoor unit at a height of at least 2.5 m from the ground.

To install, proceed as follows:

## Installation of the mounting plate

1. By using a level, put the mounting plate in a perfect square position vertically and horizontally.
2. Drill 32 mm deep holes in the wall to fix the plate;
3. Insert the plastic anchors into the hole;
4. Fix the mounting plate by using the provided tapping screws
5. Check that the mounting plate is correctly fixed;

Note : The shape of the mounting plate may be different from the one above, but installation method is similar .

## Drilling a hole in the wall for the piping

1. Decide where to drill the hole in the wall for the piping ( if necessary ) according to the position of the mounting plate;
2. Install a flexible flange through the hole in the wall to keep the latter intact and clean.

⚠ The hole must slope downwards towards the exterior

Note : Keep the drain pipe down towards the direction of the wall hole, otherwise leakage may occur.

## Electrical connections---Indoor unit

1. Lift the front panel.
2. Take off the cover as indicated in the picture ( by removing a screw or by breaking the hooks).
3. For the electrical connections, see the circuit diagram on the right part of the unit under the front panel.
4. Connect the cable wires to the screw terminals by following the numbering ,Use wire size suitable to the electric power input (see name plate on the unit) and according to all current national safety code requirements.
5. The cable connecting the outdoor and indoor units must be suitable for outdoor use.
6. The plug must be accessible also after the appliance has been installed so that it can be pulled out if necessary.
7. An efficient earth connection must be ensured.
8. If the power cable is damaged, it must be replaced by an authorised Service Centre.

Note: The cable wires has been connected to the main PCB of indoor unit by manufacturer according to the model without terminal block

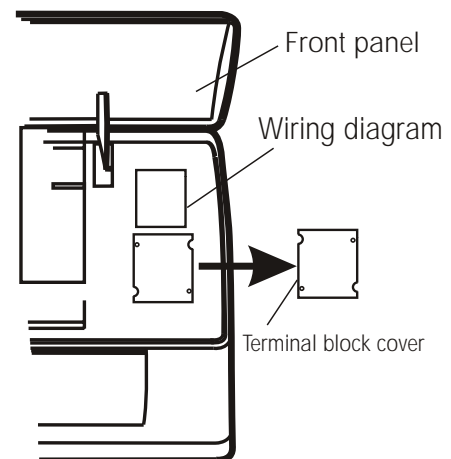
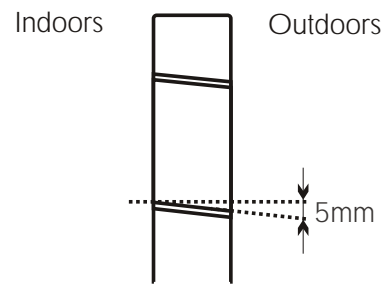
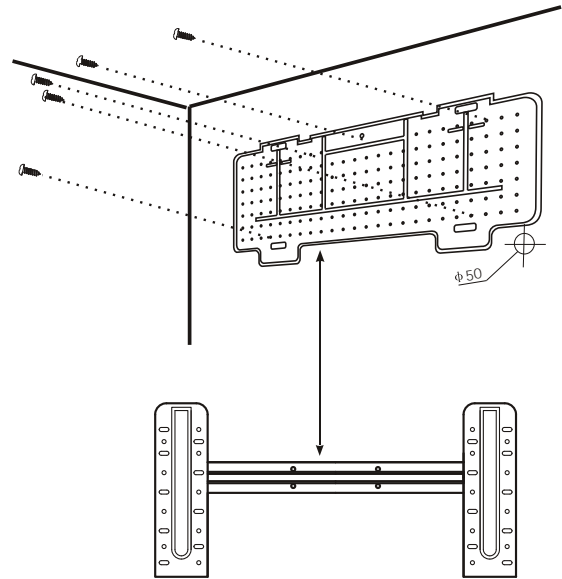

# INSTALLATION OF THE INDOOR UNIT - Continued

## Refrigerant piping connection

The piping can be run in the 3 directions indicated by numbers in the picture. When the piping is run in direction 1 or 3, cut a notch along the groove on the side of the indoor unit with a cutter.

Run the piping in the direction of the wall hole and bind the copper pipes, the drain pipe and the power cables together with the tape with the drain pipe at the bottom, so that water can flow freely.

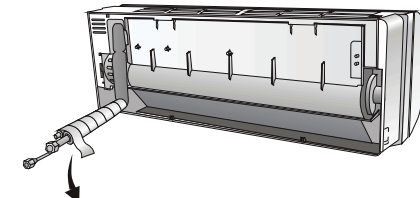
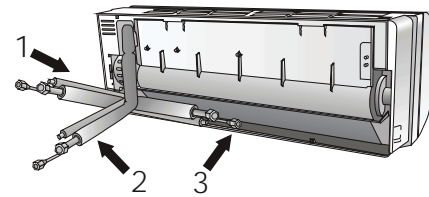

Shape the connection pipe

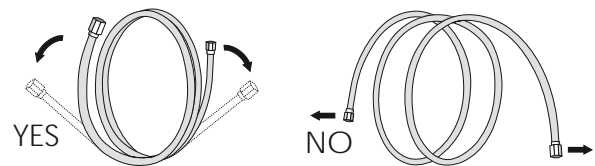

Extending the rolled pipe

## Connecting the pipes

- Do not remove the cap from the pipe until connecting it, to avoid dampness or dirt from entering.
- If the pipe is bent or pulled too often, it will become stiff. Do not bend the pipe more than three times at one point.
- When extending the rolled pipe, straighten the pipe by unwinding it gently as shown in the picture.

## Connections to the indoor unit

1. Remove the indoor unit pipe cap (check that there is no debris inside).
2. Insert the flare nut and create a flange at the extreme end of the connection pipe.
3. Tighten the connections by using two wrenches working in opposite directions



torque wrench

## Indoor unit condensed water drainage

The indoor unit condensed water drainage is fundamental for the success of the installation.

1. Place the drain hose below the piping, taking care not to create siphons.
2. The drain hose must slant downwards to aid drainage.
3. Do not bend the drain hose or leave it protruding or twisted and do not put the end of it in water. If an extension is connected to the drain hose, ensure that it is lagged when it passes into the indoor unit.
4. If the piping is installed to the right, the pipes, power cable and drain hose must be lagged and secured onto the rear of the unit with a pipe connection.
  - 1) Insert the pipe connection into the relative slot.
  - 2) Press to join the pipe connection to the base.

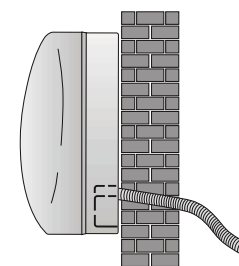

YES

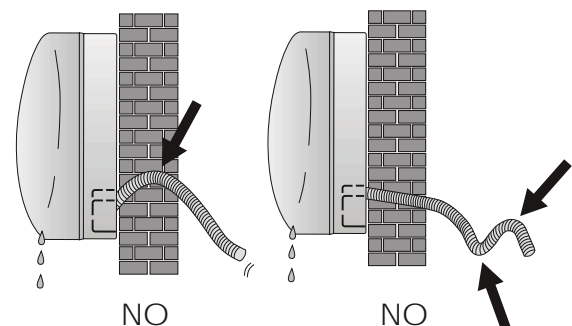

NO

NO

# INSTALLATION OF THE INDOOR UNIT - Continued

## INSTALLATION OF THE INDOOR UNIT

After having connected the pipe according to the instructions, install the connection cables. Now install the drain pipe. After connection, lag the pipe, cables and drain pipe with the insulating material.

1. Arrange the pipes, cables and drain hose well.
2. Lag the pipe joints with insulating material, securing it with vinyl tape.
3. Run the bound pipe, Cables and drain pipe through the wall hole and mount the indoor unit onto the upper part of the mounting plate securely.
4. Press and push the lower part of the indoor unit tightly against the mounting plate.

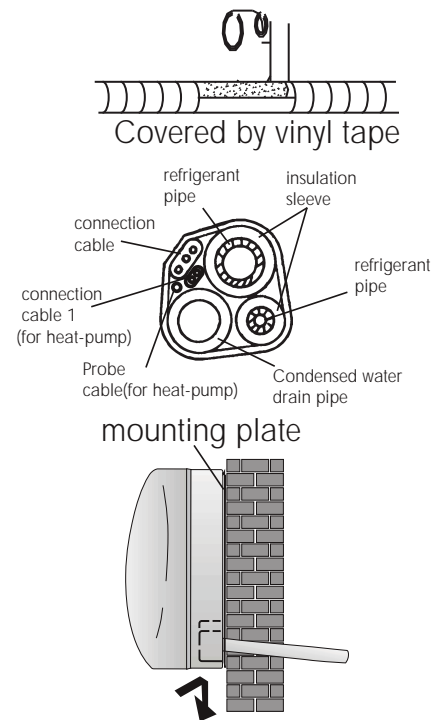

# INSTALLATION OF THE OUTDOOR UNIT

- The outdoor unit should be installed on a solid wall and fastened securely.
- The following procedure must be observed before connecting the pipes and connecting cables: decide which is the best position on the wall and leave enough space to be able to carry out maintenance easily.
- Fasten the support to the wall using screw anchors which are particularly suited to the type of wall;
- Use a larger quantity of screw anchors than normally required for the weight they have to bear to avoid vibration during operation and remain fastened in the same position for years without the screws becoming loose.
- The unit must be installed following the national regulations.

## Outdoor unit condensed water drainage (only for heat pump models)

The condensed water and the ice formed in the outdoor unit during heating operation can be drained away through the drain pipe.

1. Fasten the drain port in the 25mm hole placed in the part of the unit as shown in the picture.
2. Connect the drain port and the drain pipe. Pay attention that water is drained in a suitable place.

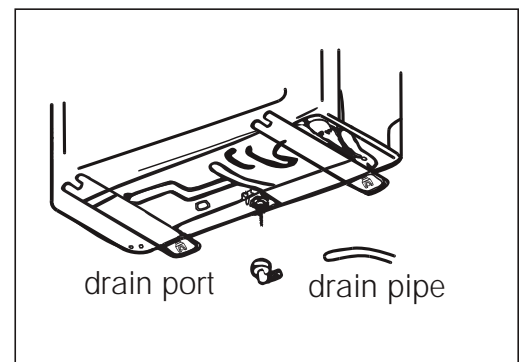

# INSTALLATION OF THE INDOOR UNIT - Continued

## ELECTRICAL CONNECTIONS

1. Take the cover away.
2. Connect the cable wires to the terminal board using the same numbering as in the indoor unit.
3. For the electrical connections, see the wiring diagram on the back of the cover
4. Fasten the cables with a cable-clamp.
5. An efficient earth connection must be ensured.
6. Replace the covers .

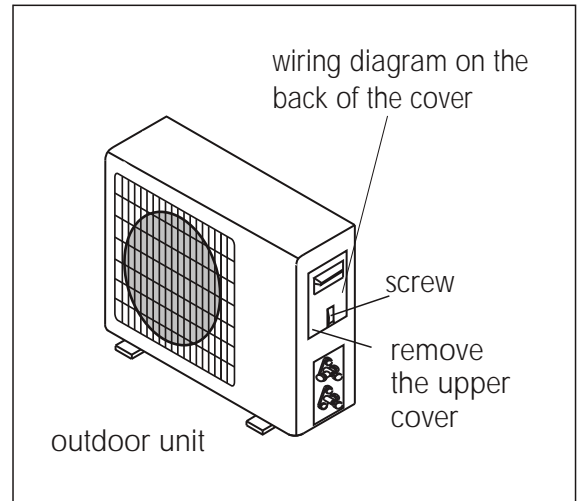

## CONNECTING THE PIPES

Screw the flare nuts to the outdoor unit coupling with the same tightening procedures described for the indoor unit.

To avoid leakage, pay attention to the following points:

1. Tighten the flare nuts using two wrenches. Pay attention not to damage the pipes.
2. If the tightening torque is not sufficient, there will probably be some leakage. With excessive tightening torque there will also be some leakage, as the flange could be damaged.
3. The surest system consists in tightening the connection by using a fix wrench and a torque wrench: in this case use the table on page 21.

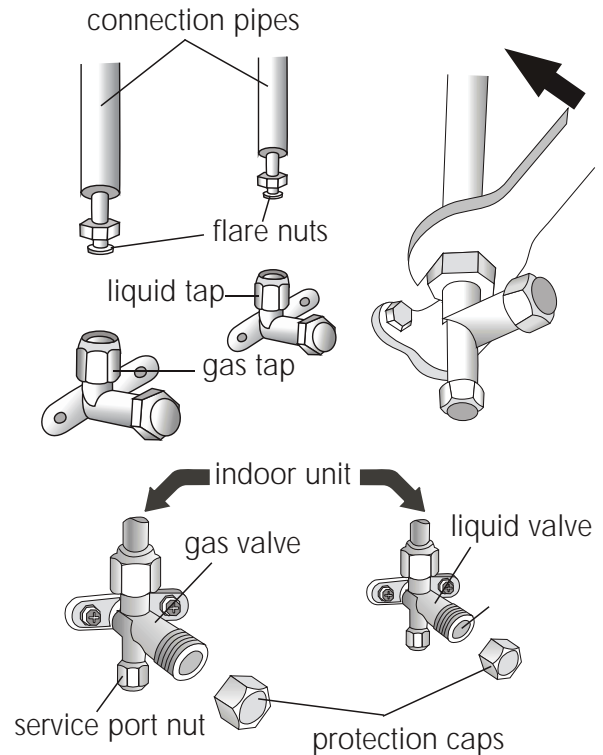

## BLEEDING

Air and humidity left inside the refrigerant circuit can cause compressor malfunction. After having connected the indoor and outdoor units, bleed the air and humidity from the refrigerant circuit by using a vacuum pump.

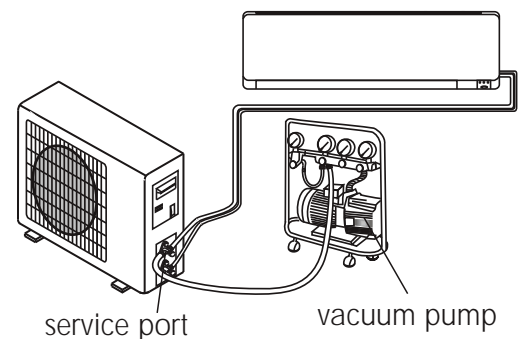

# INSTALLATION OF THE OUTDOOR UNIT - Continued

## BLEEDING

The air and humidity left inside the refrigerant circulation can cause compressor malfunction. After having connected the indoor and outdoor units, bleed the air and humidity from the refrigerant circulation using a vacuum pump.

- (1) Unscrew and remove the caps from the 2-way and 3-way valves.
- (2) Unscrew and remove the cap from the service port.
- (3) Connect the vacuum pump hose to the service port.
- (4) Operate the vacuum pump for 10 - 15 minutes until an absolute vacuum of 10 mm Hg has been reached.
- (5) With the vacuum pump still in operation, close the low - pressure knob on the vacuum pump coupling. Stop the vacuum pump.
- (6) Open the 2-way valve by 1/4 turn and then close it after 10 seconds. Check all the joints for leaks using liquid soap or an electronic leak device.
- (7) Turn the body of the 2-way and 3-way valves. Disconnect the vacuum pump hose.
- (8) Replace and tighten all the caps on the valves.

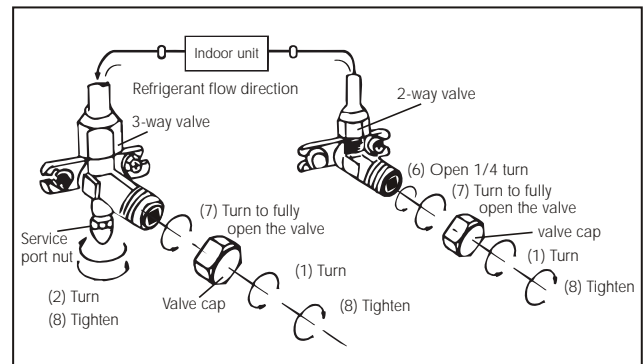
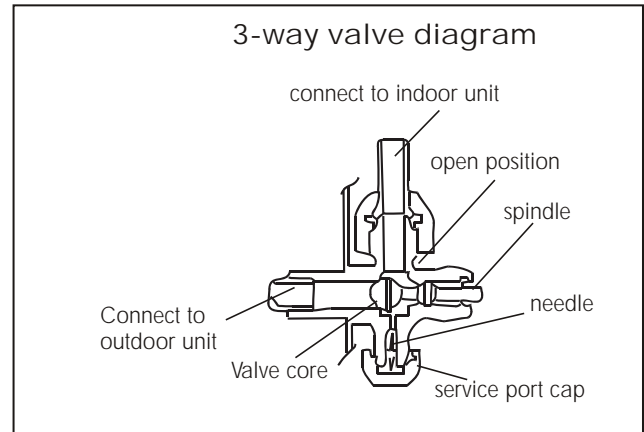

## FINAL STAGES

1. Wind insulating covering around the joints of the indoor unit and fix it with insulating tape.
2. Fix the exceeding part of the signal cable to the piping or to the outdoor unit.
3. Fix the piping to the wall (after having coated it with insulating tape) using clamps or insert them into plastic slots.
4. Seal the hole in the wall through which the piping is passed so that no air or water can fill.

### Indoor unit test

- Do the ON/OFF and FAN operate normally?
- Does the MODE operate normally?
- Do the set point and TIMER function properly?
- Does each lamp light normally?
- Do the flap for air flow direction operate normally?
- Is the condensed water drained regularly?

### Outdoor unit test

- Is there any abnormal noise or vibration during operation?
- Could the noise, the air flow or the condensed water drainage disturb the neighbours?
- Is there any coolant leakage?

*Note: the electronic controller allows the compressor to start only three minutes after voltage has reached the system.*

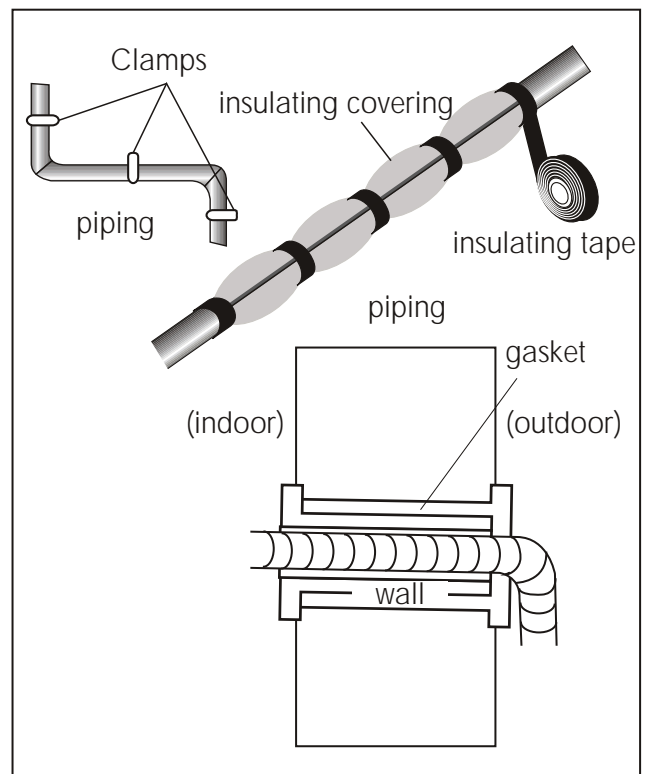

# INFORMATION FOR THE INSTALLER

FIXED-SPEED TYPE MODEL capacity (Btu/h)	7k	9k	12k	15/18k	22/24k	28/30k
Liquid pipe diameter	1/4" (φ6)	1/4" (φ6)	1/4" (φ6)	1/4" (φ6)	3/8" (φ9.52)	3/8" (φ9.52)
Gas pipe diameter	3/8" (φ9.52)	3/8" (φ9.52)	3/8" (φ9.52)	1/2" (φ12)	5/8" (φ15.88)	5/8" (φ15.88)
Length of pipe with standard charge	3m	3m	3m	4m	4m	4m
Maximum distance between indoor and outdoor unit	15m	15m	15m	15m	15m	15m
Additional gas charge	20g/m	20g/m	20g/m	30g/m	30g/m	30g/m
Max. diff. in level between indoor and outdoor unit	5m	5m	5m	5m	5m	5m
Type of refrigerant(1)	R410A	R410A	R410A	R410A	R410A	R410A

(1) Refer to the data rating label stuck on the outdoor unit.

## TIGHTENING TORQUE FOR PROTECTION CAPS AND FLANGE CONNECTION

PIPE	TIGHTENING TORQUE [N x m]	CORRESPONDING STRESS (using a 20 cm wrench)		TIGHTENING TORQUE [N x m]
1/4" (φ6)	15 - 20	wrist strength	Service port nut	7 - 9
3/8" (φ9.52)	31 - 35	arm strength	Protection caps	25 - 30
1/2" (φ12)	35 - 45	arm strength		
5/8" (φ15.88)	75 - 80	arm strength		

# INFORMATION FOR THE INSTALLER - CONTINUED

## WIRING DIAGRAM

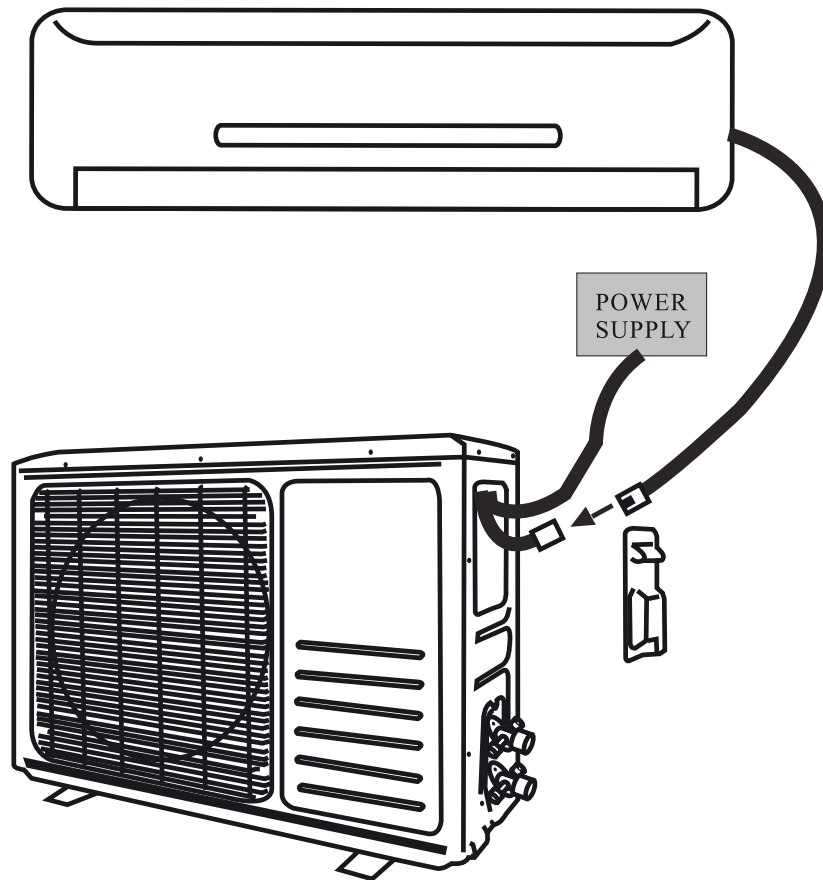
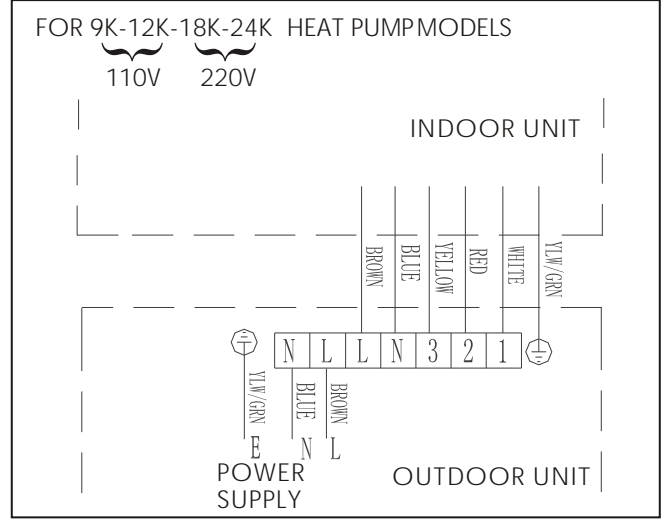
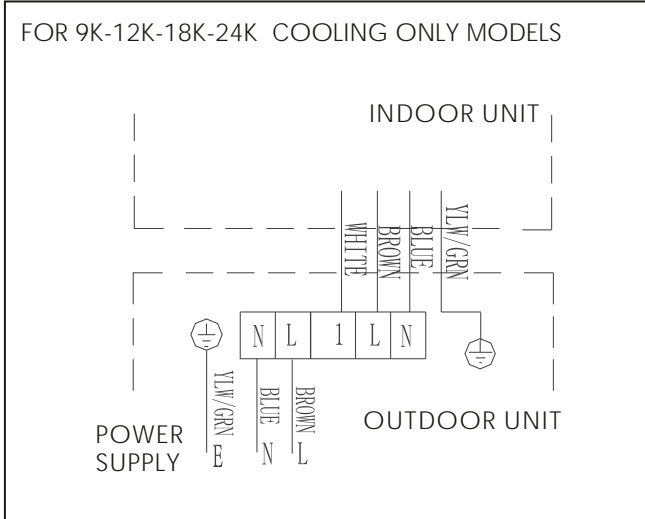

Please see the pasted diagram instruction on the unit first

*Note: The cable wires has been connected to the main PCB of indoor unit by manufacturer according to the model without terminal block, see the wiring diagram on the right part of the unit under the front panel and the back of the outdoor cover*



# INFORMATION FOR THE INSTALLER - CONTINUED

## CABLE WIRES SPECIFICATION

MODEL capacity (Btu/h)		5k	7k	9k	12k	15/18k	22/24k	28/30k
		sectional area						
Power supply cable	N	1.0mm <sup>2</sup> AWG18	1.0mm <sup>2</sup> AWG18	1.6mm <sup>2</sup> AWG14	1.6mm <sup>2</sup> AWG14	2.0mm <sup>2</sup> AWG12	2.0mm <sup>2</sup> AWG12	2.6mm <sup>2</sup> AWG10
	L	1.0mm <sup>2</sup> AWG18	1.0mm <sup>2</sup> AWG18	1.6mm <sup>2</sup> AWG14	1.6mm <sup>2</sup> AWG14	2.0mm <sup>2</sup> AWG12	2.0mm <sup>2</sup> AWG12	2.6mm <sup>2</sup> AWG10
	E	1.0mm <sup>2</sup> AWG18	1.0mm <sup>2</sup> AWG18	1.6mm <sup>2</sup> AWG14	1.6mm <sup>2</sup> AWG14	2.0mm <sup>2</sup> AWG12	2.0mm <sup>2</sup> AWG12	2.6mm <sup>2</sup> AWG10
Connection supply cable	N	1.0mm <sup>2</sup>	1.0mm <sup>2</sup>	1.0mm <sup>2</sup>	1.0mm <sup>2</sup> (1.5mm)	1.5mm <sup>2</sup>	0.75mm <sup>2</sup>	0.75mm <sup>2</sup>
	L	1.0mm <sup>2</sup>	1.0mm <sup>2</sup>	1.0mm <sup>2</sup>	1.0mm <sup>2</sup> (1.5mm)	1.5mm <sup>2</sup>	0.75mm <sup>2</sup>	0.75mm <sup>2</sup>
	1	1.0mm <sup>2</sup>	1.0mm <sup>2</sup>	1.0mm <sup>2</sup>	1.0mm <sup>2</sup> (1.5mm)	1.5mm <sup>2</sup>	0.75mm <sup>2</sup>	0.75mm <sup>2</sup>
	2	0.75mm <sup>2</sup>	0.75mm <sup>2</sup>	0.75mm <sup>2</sup>	0.75mm <sup>2</sup>	0.75mm <sup>2</sup>	0.75mm <sup>2</sup>	0.75mm <sup>2</sup>
	3	0.75mm <sup>2</sup>	0.75mm <sup>2</sup>	0.75mm <sup>2</sup>	0.75mm <sup>2</sup>	0.75mm <sup>2</sup>	0.75mm <sup>2</sup>	0.75mm <sup>2</sup>
		0.75mm <sup>2</sup>	0.75mm <sup>2</sup>	0.75mm <sup>2</sup>	0.75mm <sup>2</sup>	0.75mm <sup>2</sup>	0.75mm <sup>2</sup>	0.75mm <sup>2</sup>

Type for 220V of fuse used on indoor unit controller for 7K , 9K , 12K 15K , 16K , 18K , 22K , 24K , 30K is 50T with rating 3.15 A , 250V Type for 110V of fuse used on indoor unit controller for 7K , 9K 12k is 50T with rating 3.15 A , 125V ; Type of fuse used on inverter outdoor unit controller for 7K , 9K , 12K is 61T with rating 15 A , 250V , for 18K , 22K , 24K is 65TS with rating 25A , 250V.

# MAINTENANCE

Periodic maintenance is essential for keeping your air conditioner efficient.

Before carrying out any maintenance, disconnect the power supply by putting the installation on/ off switch to “off”.

## INDOOR UNIT

### ANTIDUST FILTERS

1. Open the front panel following the direction of the arrow
2. Keeping the front panel raised with one hand, take out the air filter with the other hand
3. Clean the filter with water; if the filter is soiled with oil, it can be washed with warm water (not exceeding 45°C).  
Leave to dry in a cool and dry place.
4. Keeping the front panel raised with one hand, insert the air filter with the other hand
5. Close

The electrostatic and the deodorant filter (if installed) cannot be washed or regenerated and must be replaced with new filters once every 6 months.

### CLEANING THE HEAT EXCHANGER

1. Open the front panel of the unit and lift it till its greatest stroke and then unhooking it from the hinges to make the cleaning easier.
2. Clean the indoor unit using a cloth with the water (not higher than 40°C) and neutral soap. Never use aggressive solvents or detergents.
3. If the battery of the outdoor unit is clogged, remove the leaves and the waste and remove the dust with air jet or a bit of water.

### END OF SEASON MAINTENANCE

1. Disconnect the automatic switch or the plug.
2. Clean and replace the filters
3. On a sunny day let the conditioner work in ventilation for some hours, so that the inside of the unit can dry completely..

### REPLACING THE BATTERIES

When:

- There is no confirmation beep from the indoor unit.
- The LCD doesn't activate.

How:

- Take off the cover at back.
- Place the new batteries respecting the symbols + and -.

N.B: Use only new batteries. Remove the batteries from the remote control when the conditioner is not in operation

**WARNING!** Do not throw batteries into common rubbish, they should be disposed of in the special containers situated in the collection points.

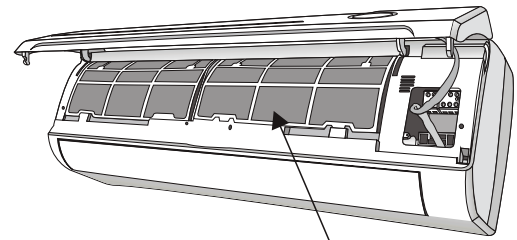
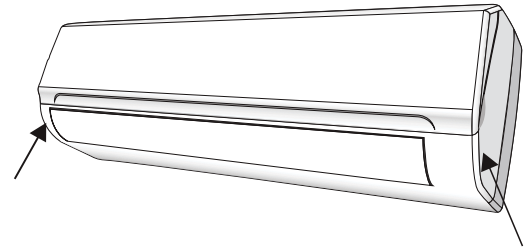

antidust filter

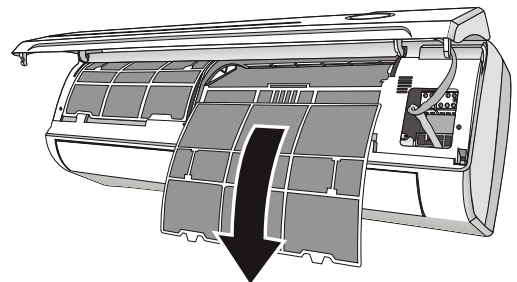

# TROUBLESHOOTING

MALFUNCTION	POSSIBLE CAUSES
The appliance does not operate	Power failure/plug pulled out
	Damaged indoor/outdoor unit fan motor
	Faulty compressor thermomagnetic circuit breaker
	Faulty protective device or fuses.
	Loose connections or plug pulled out
	It sometimes stops operating to protect the appliance.
	Voltage higher or lower than the voltage range
	Active TIMER-ON function
	Damaged electronic control board
Strange odour	Dirty air filter
Noise of running water	Back flow of liquid in the refrigerant circulation
A fine mist comes from the air outlet	This occurs when the air in the room becomes very cold, for example in the “COOLING” or “DEHUMIDIFYING/DRY” modes.
A strange noise can be heard	This noise is made by the expansion or contraction of the front panel due to variations in temperature and does not indicate a problem.
Insufficient airflow, either hot or cold	Unsuitable temperature setting.
	Obstructed air conditioner intakes and outlets.
	Dirty air filter.
	Fan speed set at minimum.
	Other sources of heat in the room.
The appliance does not respond to commands	No refrigerant.
	Remote control is not near enough to indoor unit.
	The batteries of remote control nearly has no power.
The display is off	Obstacles between remote control and signal receiver in indoor unit.
	Active LIGHT function
Switch off the air conditioner immediately and cut off the power supply in the event of:	Power failure
	Strange noises during operation.
	Faulty electronic control board
	Faulty fuses or switches.
	Spraying water or objects inside the appliance.
	Overheated cables or plugs.
Very strong smells coming from the appliance.	

## ERROR SIGNALS ON THE DISPLAY

In case of error, the display on the indoor unit shown the following error codes:

	RUN lamp	Description of the trouble
<b>E1</b>	flashes once	The fault of indoor temperature sensor
<b>E2</b>	flashes twice	The fault of indoor pipe temperature sensor
<b>E6</b>	flashes 6 times	Malfunction of indoor fan motor.