

IP67 Sealed Industrial Ethernet Ring Switch Direct Machine Mount Switch for Heavy Industrial Applications

The SIXNET IP67 Industrial Ethernet Switch mounts directly onto a machine or any convenient flat surface in the harshest industrial environments. The rugged packaging and Amphenol RJField connectors are IP67 (NEMA 6) rated to protect against water, oil, dust, vibration and much more. This advanced technology switch ensures real-time deterministic performance and super-fast ring redundancy. The switch is ultra-reliable with over 1,000,000 hours Mean Time Between Failure (MTBF) and protected by SIXNET's 20-year support and service policy.

SIXNET IP67 Switch Benefits:

- Reduced installation cost
- Mount anywhere - save space
- Ensure real-time operation and allow for Deterministic Control
- Increased network reliability

Ideal Ethernet Switch for:

- Direct machine mounting
- Outdoor or marine use
- Military applications & much more



Rugged, Reliable and Easy to Use!

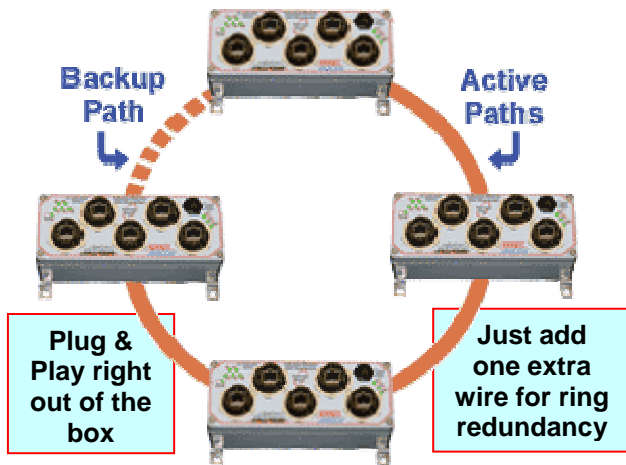

Featuring Amphenol RJField Connectors:

- Fits over any standard Ethernet cordset
- Easy to install – no tools required!
- Super rugged – IP67 and military tough!

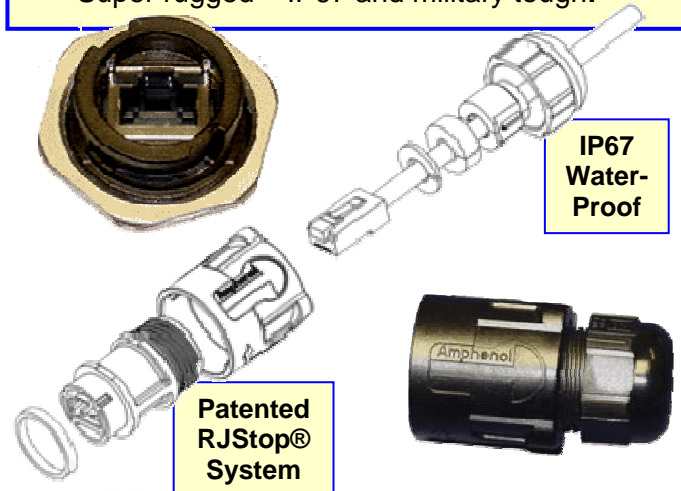

SIXNET Real-time Ring™ Redundancy:

- Easy to use - plug and play simple
- Super fast switch over on failure
- Modbus monitoring over Ethernet



ISO9001
Quality



Hazardous
Locations



Emissions,
Immunity & Safety



US/Canada
Safety



Marine &
Offshore



US/Canada
Emissions



Military
Tough



Lead and Hazardous
Substance Free

Real-Time Ring™ Switches Deliver Ultra-Reliable Results

The switch provides very fast, fault-tolerant network redundancy and prioritized message delivery needed in critical real-time systems. Real-time Rings self-configure and just run, without the complex configuration steps required by alternative solutions. This break-through technology delivers reliability, performance, saves you money, and makes your job easier.

Advanced Network Performance:

- Real-time fault tolerant rings
 - Fast ring recovery of 30 mS + 5 mS / hop!
 - Modbus over Ethernet monitoring
- Real-time traffic prioritization with QoS
 - Assure delivery of real-time data
 - Improve network utilization
 - User settable priority assignments
- Advanced switch features
 - User configurable port settings
 - Port mirroring for traffic diagnostics
 - Pre-configurable for plug & play simplicity

Rugged and Reliable Hardware:

- SIXNET reliability and long-term support
 - Ultra-reliable 1,000,000 hours MTBF
 - Unique 20-year support & service policy
 - Firmware upgrades are FREE forever
- Truly industrial design and packaging
 - Tough fiber-reinforced enclosure
 - Rugged Amphenol connectors
 - Dual power inputs and alarm output
- Industrial rated to perform
 - MIL-STD-1275 power protection (-E models)
 - Wide operating temperature -40 to +75°C

Fault-tolerant Systems Survive Network Breaks - Real-time Rings have an alternative network path in constant readiness. When a failure occurs, the Real-time Ring instantly redirects the traffic through the alternative path.

Achieve Deterministic Performance - Rings are simple by design. The alternative path is unique and the action to take when a failure occurs is predetermined. Ring Switches use this to deliver deterministic performance, with recovery times of 5 mS per hop plus some overhead.

Avoid the High Cost and Complexity of Managed Switches - Ring Switches are ideal for achieving fault tolerance without the higher cost and complexity of managed switches. In most cases, Ring Switches will do what you need with just the factory settings. Or a simple Windows wizard (FREE) allows you to fine tune the performance. Now you can get the job done without needing the "IT" department.

Priority Queuing For Real-time Performance - Security cameras and other devices can significantly slow down your real-time data delivery. Ring Switches can tag the camera ports as lower priority (or you can set the critical data as a higher priority). Then the data will travel from switch to switch using priority queuing best suited for your situation. Ring switches will cure your data overload headaches!

Connect Independent Rings Together - Ring Switches may be members of more than one ring. This allows you to design fast, work-cell oriented rings that are joined to exchange information. Smaller rings recover faster and are more reliable.

Alarm Output and Modbus Avoid Future Problems - An "OK" contact assures that the redundant power inputs and the ring (or rings) are complete. Modbus registers report the readiness of individual ports to your SCADA or control system. This is a SIXNET exclusive!

Real-time Switches Deliver Ultra-Reliability - Real-time Ring Switches have field-proven reliability of more than 1,000,000 hours MTBF. These SIXNET industrially hardened switches are certified to survive in your harsh environment – Even outdoors in marine and military applications.

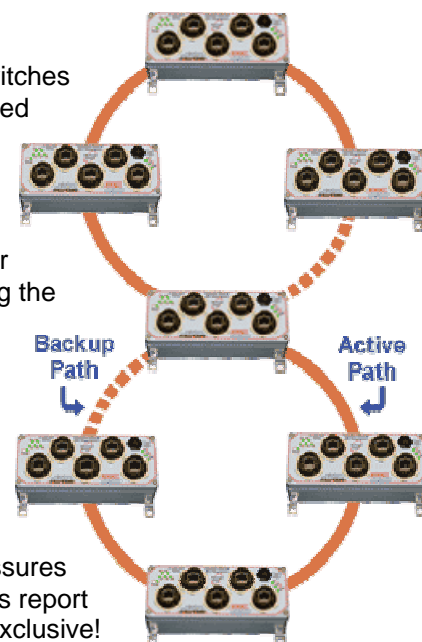

SIXNET Industrial Switches Make Your Job Easier - In most applications, the factory pre-configuration will just work for you. Mount these switches, plug in your network cables, sit back and watch the data flow, year after year.



SIXNET®

331 Ushers Road, P.O. Box 767 • Clifton Park, NY 12065 USA • +1 (518) 877-5173
Fax +1 (518) 877-8346 • mailto: sales@sixnetswitch.com • <http://www.sixnetswitch.com>

Operation and Performance Specifications

Performance Specifications		
General		
Ethernet switch type	5 Ethernet ports	
Ethernet protocols supported	Intelligent store & forward	
RJ45 ports (shielded)	All IEEE 802.3	
RJ45 speed (10 or 100 Mbps)	10/100BaseTX	
RJ45 MDI/MDIX	Auto-negotiation	
RJ45 TD and RD polarity	Auto-crossover	
Typical latency @ 10 Mbps	16 us + frame time	Varies on load & settings
Typical latency @ 100 Mbps	5 us + frame time	
Full or half duplex operation	Configurable	
MAC addresses supported	2048	
Memory bandwidth	3.2 Gbps	
Status Reporting (RS model)		
Modbus status registers	Power & operational status	
"OK" contact output	Modbus Ethernet over UDP	
Real-Time Ring™ Features		
Maximum switches in ring	Sourcing power @ 0.5 Amp	
Dual ring support	SIXNET Exclusive (RS model)	
Link loss recovery time	50+	
Environmental		
Power input	Full industrial ratings	
Input power (typical)	Redundant input connections	
Input voltage (-D models)	ES: 2.4 W, RS: 2.7 W	
Transient protection	10-30 VDC	
Spike protection	15,000 watts peak	
<div style="text-align: center;">  <p>Exceeds MIL-STD-1275 Beyond Industrial Strength</p> </div>		
Input voltage (-E models)	5,000 watts (10 times for 10 uS)	
Extended power protection	-E models	
Military surge protection	Exceeds MIL-STD-1275; 100 volts for 1 second	
Transient protection	15,000 watts peak	
Spike Protection	5,000 watts (10x for 10 uS) or 250 volts (50x for 100 uS)	
Ethernet isolation	1500 VRMS 1 minute	
Operating temperature range	-40 to +75 °C	
Storage temperature range	-40 to +85 °C	
Humidity (non-condensing)	5 to 95% RH	
Vibration, shock and freefall	IEC68-2-6, -27 and -32	
Electrical safety		UL508/CSA C22, EN61010-1
EMI emissions		FCC part 15, ICES-003, EN55022
EMC immunity		IEC61326-1
Hazardous locations (Class 1, Div. 2) (Zone 2)	UL1604, CSA C22.2/213, Cenelec EN50021	
Marine and off-shore	DNV (Det Norske Veritas)	
Protection rating	IP67 and NEMA 6	
Enclosure material	Fiber reinforced polyester	
Dimensions and mounting	See mechanical diagram	
Weight	1.2 lbs (0.54 kg)	

Specifications are subject to change. Consult factory for latest information.

Hardware Highlights:

- 5 port truly industrial IP67 water-proof Ethernet switch
- Output for reporting power and operational status
- Redundant power inputs and enhanced surge/spike protection (meets MIL-STD-1275 on "-E" models)
- Industrial rated -40 to +75 °C operation (without fans!)
- UL/CSA, CE and Zone 2 rated for hazardous locations
- DNV rated for marine and off-shore use
- Direct to panel or machine mounting

Networking Features:

- Store and forward wire speed switching – no delays
- Support for up to 2048 MAC addresses
- Automatic address learning and aging
- Full-Duplex operation with flow control (no collisions!)
- Auto crossover (MDI/MDIX) and auto polarity
- Real-Time Ring™ for ultra-fast fault-tolerant loops
- Priority queuing for real-time network performance
- Message filtering to prevent broadcast storms
- Port mirroring for advanced diagnostics
- Easy to use Windows configuration utility

Ethernet Compliance:

- IEEE 802.3 (10Mbps Ethernet supports legacy devices)
- IEEE 802.3u (Fast Ethernet 100Mbps for newer devices)
- IEEE 802.3x (Full-Duplex with Flow Control)
- IEEE 802.1p (QoS / CoS – Quality & Class of Service)

**Pre-configured
To Make Your
Job Easier!**

Ordering Guide

ET-5RS-IP67-D1	
0	Pre-set for 0 rings (special order)
1	Pre-set for 1 ring (standard)
2	Pre-set for 2 rings (special order)
C	Custom configured for you
D	dual power w/ industrial protection
E	dual power w/ military-rated (MIL-STD-1275) protection
IP67	= water, oil and dust proof
RS	= Real-time Ring™ model
ES	= Unmanaged model (special order)
5	= 5 Ethernet ports
ET	= EtherTRAK family

IP67 Accessories:

Setup Wizard	Free Windows configuration tool
ET-RJF-PWR-1	IP67 power plug
ET-RJFRB-6	IP67 Ethernet plug
ET-RJFRB-C7	IP67 cap for unused ports
ET-RJFRB-71	IP67 bulk-head connector
ET-RJF5E-xx	Industrial cordsets & bulk cable (Kevlar Reinforced!)

SIXNET®

331 Ushers Road, P.O. Box 767 • Clifton Park, NY 12065 USA • +1 (518) 877-5173
 Fax +1 (518) 877-8346 • mailto: sales@sixnetswitch.com • <http://www.sixnetswitch.com>

IP67 Accessories and Kevlar Protected Cabling

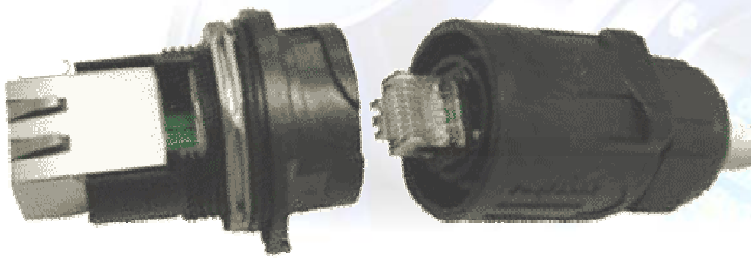

Benefits of IP67 Plug Accessories:

- IP67 protection – dust, oil and water-proof!
- Positive lock for shock & vibration resistance
- Strain relief prevents cable breaks
- Field-installable – No tools needed!
- Fits over standard Ethernet cables
- Quick ¼ turn reverse-bayonet latching reduces installation time and costs

Performance Specifications	
Electrical characteristics	
Ethernet data rates supported	10BaseT, 100BaseT, 1000BaseT
Cat 5E cable supported per	TIA/EIA 568B and ISO/IEC 11801, Class D
Cat 6 cable supported per	TIA/EIA 568B and ISO/IEC 11801, Class E
Mechanical characteristics	
Coupling (connection method)	Reverse bayonet – just a quarter turn and lock
RJ45 cordset retention	70 N in the axis
Mating cycles	500 minimum
Environmental protection	
Sealing protection	IP67 and NEMA 6 – dust, oil and water-proof to 1 meter for >30 min
Salt spray protection	1000 hours minimum
Fire retardant / low smoke	UL94 V0; NFF 16102, DIN 5510-2
Thermal shock	5 cycles @ -40°C to +100°C
Operating temperature	-40°C to +85°C

Specifications are subject to change. Consult factory for latest information.



Kevlar Protected Industrial Cabling:

- Category 5E for up to 1000BaseT connections
- Kevlar reinforced for superior strength & ruggedness
- Doubled shielded for the best noise immunity
- High flexibility makes routing easier
- Excellent UV, hydrolysis and microbial resistance
- Low smoke, halogen free flame retardant (HFFR) black polyurethane jacketing
- Available in cordsets and bulk cable reels
- Part #: ET-RJF5E-xx (xx = length in meters)
(see separate datasheet for more details)

RJ45 Ethernet Plug: Part #: ET-RJFRB-6

Cable Dia:
0.2" (5 mm) min.
0.4" (10 mm) max.



RJ45 Bulkhead Connector:



Part #: ET-RJFRB-71

Power Plug:



Part#: ET-RJF-PWR-1

Protective Cap with Tether:



Part #: ET-RJFRB-C7

SIXNET®

331 Ushers Road, P.O. Box 767 • Clifton Park, NY 12065 USA • +1 (518) 877-5173
 Fax +1 (518) 877-8346 • mailto: sales@sixnetswitch.com • <http://www.sixnetswitch.com>

Mechanical and Mounting Dimensions

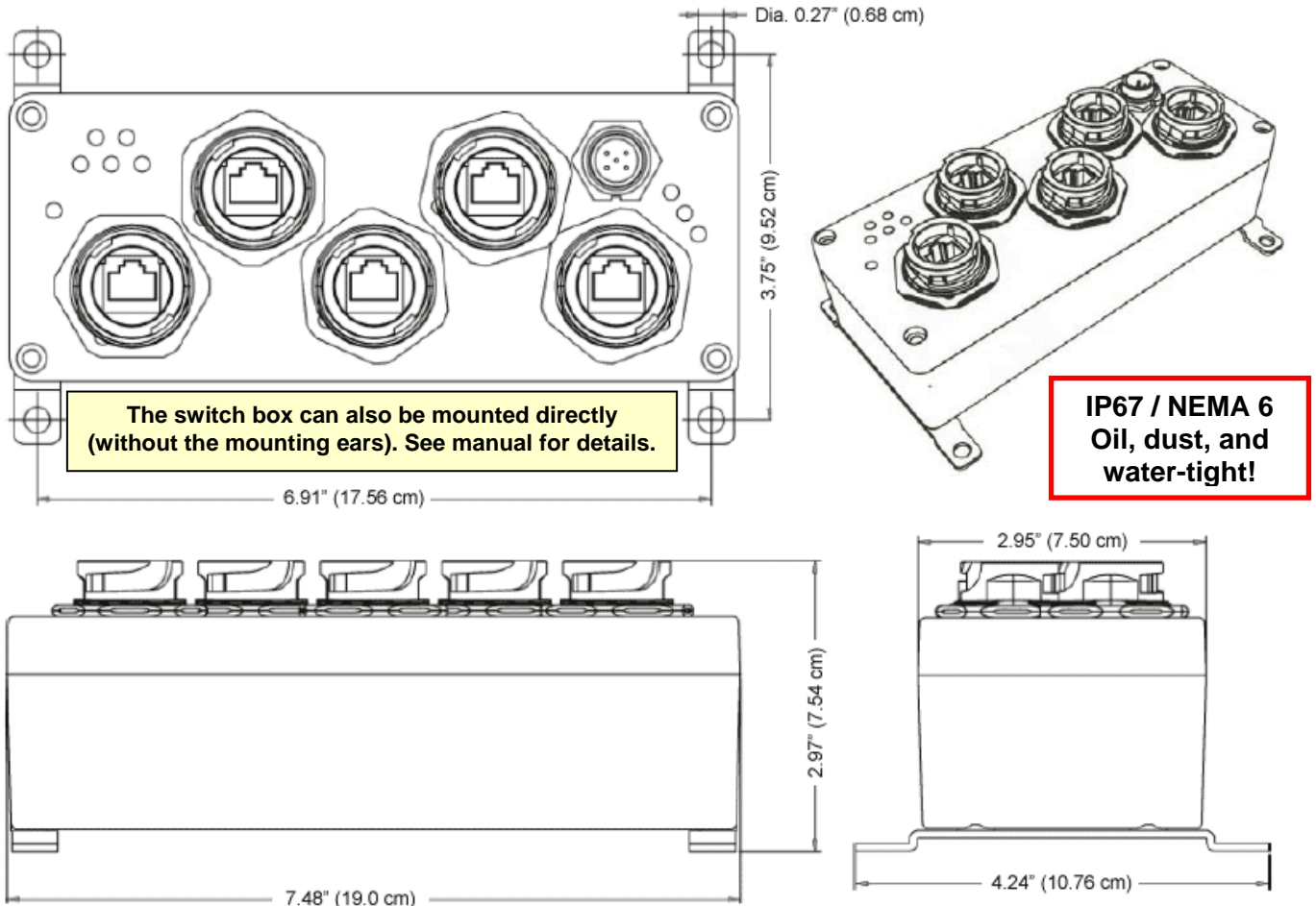

Fiber Reinforced Polyester Enclosure

Accessory Dimensions (See User Manual for More Details)

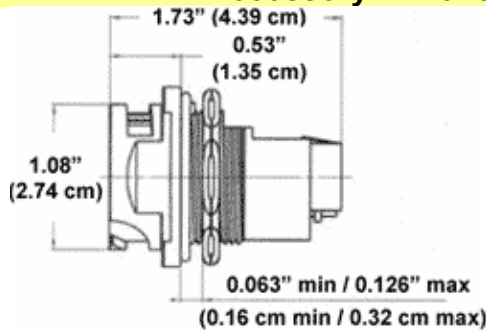

ET-RJFRB-71 (IP67 Bulkhead Connector)

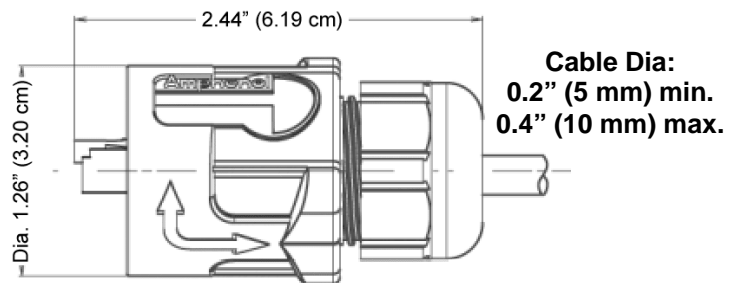

ET-RJFRB-6 (IP67 Ethernet Plug)

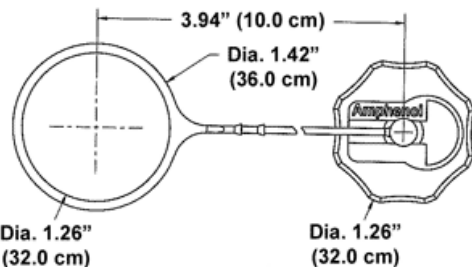

ET-RJFRB-C7 (IP67 Cap with Tether)

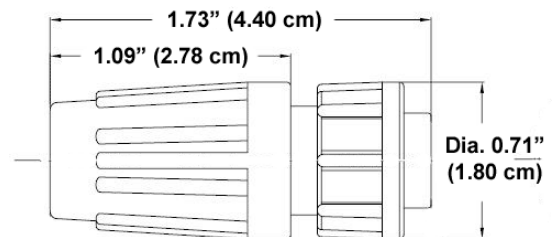

ET-RJF-PWR-1 (IP67 Power Plug)

SIXNET®

331 Ushers Road, P.O. Box 767 • Clifton Park, NY 12065 USA • +1 (518) 877-5173
 Fax +1 (518) 877-8346 • mailto: sales@sixnetswitch.com • <http://www.sixnetswitch.com>

A Complete Family of I/O Solutions

Ethernet and RS485 I/O

SIXNET can provide you the building blocks for the open systems you are looking for. Three complementary families of modular DIN rail mounted I/O provide local, remote, enterprise level, or Internet I/O solutions.

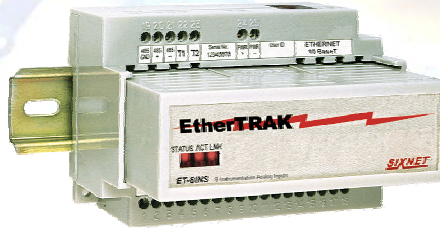

Industrial Telephone Modems

SIXNET rugged industrial modems eliminate the hassles of mounting a telephone modem in an industrial enclosure. These robust modems are rated for -30 to +70 °C industrial operation.

Industrial Ethernet Managed Switches

SIXNET Industrial Ethernet Switches offer the most advanced features, from Rapid Spanning Tree Protocol for redundancy, to SNMP for easy network management. These switches are rugged, reliable, real-time and most of all, secure.

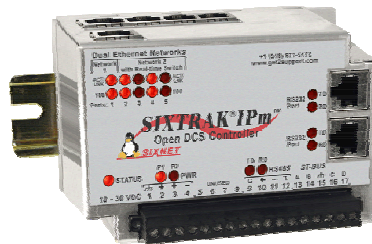

Controllers & RTUs with Open-Source Linux

SIXNET IPm is a combination of installation-ready industrial controllers & RTUs and a wealth of powerful software solutions. IPm offers the reliability of a PLC, the familiarity of powerful Windows programming and configuration utilities, all combined with powerful open-source Linux flexibility.



Request Your
FREE Product CD at
<http://www.sixnetswitch.com>

Contact your SIXNET Applications Engineer Today!

For the latest information, check out
<http://www.sixnetswitch.com>

SIXNET®

331 Ushers Road, P.O. Box 767 • Clifton Park, NY 12065 USA • +1 (518) 877-5173
Fax +1 (518) 877-8346 • mailto: sales@sixnetswitch.com • <http://www.sixnetswitch.com>