

GS1 Series Drives User Manual

GS1 AC DRIVE

120V Input: 0.25 - 0.5 Hp

230V Input: 0.25 - 2.0 Hp



WARNING

Thank you for purchasing automation equipment from Automationdirect.com™. We want your new automation equipment to operate safely. Anyone who installs or uses this equipment should read this publication (and any other relevant publications) before installing or operating the equipment.

To minimize the risk of potential safety problems, you should follow all applicable local and national codes that regulate the installation and operation of your equipment. These codes vary from area to area and usually change with time. It is your responsibility to determine which codes should be followed, and to verify that the equipment, installation, and operation is in compliance with the latest revision of these codes.

At a minimum, you should follow all applicable sections of the National Fire Code, National Electrical Code, and the codes of the National Electrical Manufacturer's Association (NEMA). There may be local regulatory or government offices that can also help determine which codes and standards are necessary for safe installation and operation.

Equipment damage or serious injury to personnel can result from the failure to follow all applicable codes and standards. We do not guarantee the products described in this publication are suitable for your particular application, nor do we assume any responsibility for your product design, installation, or operation.

Our products are not fault-tolerant and are not designed, manufactured or intended for use or resale as on-line control equipment in hazardous environments requiring fail-safe performance, such as in the operation of nuclear facilities, aircraft navigation or communication systems, air traffic control, direct life support machines, or weapons systems, in which the failure of the product could lead directly to death, personal injury, or severe physical or environmental damage ("High Risk Activities"). Automationdirect.com™ specifically disclaims any expressed or implied warranty of fitness for High Risk Activities.

For additional warranty and safety information, see the Terms and Conditions section of our catalog. If you have any questions concerning the installation or operation of this equipment, or if you need additional information, please call us at 770-844-4200.

This publication is based on information that was available at the time it was printed. At Automationdirect.com™ we constantly strive to improve our products and services, so we reserve the right to make changes to the products and/or publications at any time without notice and without any obligation. This publication may also discuss features that may not be available in certain revisions of the product.

Trademarks

This publication may contain references to products produced and/or offered by other companies. The product and company names may be trademarked and are the sole property of their respective owners. Automationdirect.com™ disclaims any proprietary interest in the marks and names of others.

**Copyright 2002, Automationdirect.com™ Incorporated
All Rights Reserved**

No part of this manual shall be copied, reproduced, or transmitted in any way without the prior, written consent of Automationdirect.com™ Incorporated. Automationdirect.com™ retains the exclusive rights to all information included in this document.

⚡ AVERTISSEMENT ⚡

Nous vous remercions d'avoir acheté l'équipement d'automatisation de Automationdirect.comMC. Nous tenons à ce que votre nouvel équipement d'automatisation fonctionne en toute sécurité. Toute personne qui installe ou utilise cet équipement doit lire la présente publication (et toutes les autres publications pertinentes) avant de l'installer ou de l'utiliser.

Afin de réduire au minimum le risque d'éventuels problèmes de sécurité, vous devez respecter tous les codes locaux et nationaux applicables régissant l'installation et le fonctionnement de votre équipement. Ces codes diffèrent d'une région à l'autre et, habituellement, évoluent au fil du temps. Il vous incombe de déterminer les codes à respecter et de vous assurer que l'équipement, l'installation et le fonctionnement sont conformes aux exigences de la version la plus récente de ces codes.

Vous devez, à tout le moins, respecter toutes les sections applicables du Code national de prévention des incendies, du Code national de l'électricité et des codes de la National Electrical Manufacturer's Association (NEMA). Des organismes de réglementation ou des services gouvernementaux locaux peuvent également vous aider à déterminer les codes ainsi que les normes à respecter pour assurer une installation et un fonctionnement sûrs.

L'omission de respecter la totalité des codes et des normes applicables peut entraîner des dommages à l'équipement ou causer de graves blessures au personnel. Nous ne garantissons pas que les produits décrits dans cette publication conviennent à votre application particulière et nous n'assumons aucune responsabilité à l'égard de la conception, de l'installation ou du fonctionnement de votre produit.

Nos produits ne sont pas insensibles aux défaillances et ne sont ni conçus ni fabriqués pour l'utilisation ou la revente en tant qu'équipement de commande en ligne dans des environnements dangereux nécessitant une sécurité absolue, par exemple, l'exploitation d'installations nucléaires, les systèmes de navigation aérienne ou de communication, le contrôle de la circulation aérienne, les équipements de survie ou les systèmes d'armes, pour lesquels la défaillance du produit peut provoquer la mort, des blessures corporelles ou de graves dommages matériels ou environnementaux («activités à risque élevé»). La société Automationdirect.comMC nie toute garantie expresse ou implicite d'aptitude à l'emploi en ce qui a trait aux activités à risque élevé.

Pour des renseignements additionnels touchant la garantie et la sécurité, veuillez consulter la section Modalités et conditions de notre documentation. Si vous avez des questions au sujet de l'installation ou du fonctionnement de cet équipement, ou encore si vous avez besoin de renseignements supplémentaires, n'hésitez pas à nous téléphoner au 770-844-4200.

Cette publication s'appuie sur l'information qui était disponible au moment de l'impression. À la société Automationdirect.com, nous nous efforçons constamment d'améliorer nos produits et services. C'est pourquoi nous nous réservons le droit d'apporter des modifications aux produits ou aux publications en tout temps, sans préavis ni quelque obligation que ce soit. La présente publication peut aussi porter sur des caractéristiques susceptibles de ne pas être offertes dans certaines versions révisées du produit.

Marques de commerce

La présente publication peut contenir des références à des produits fabriqués ou offerts par d'autres entreprises. Les désignations des produits et des entreprises peuvent être des marques de commerce et appartiennent exclusivement à leurs propriétaires respectifs. Automationdirect.comMC nie tout intérêt dans les autres marques et désignations.

**Copyright 2002, Automationdirect.com™ Incorporated
Tous droits réservés**

Nulle partie de ce manuel ne doit être copiée, reproduite ou transmise de quelque façon que ce soit sans le consentement préalable écrit de la société Automationdirect.com™ Incorporated. Automationdirect.com™ conserve les droits exclusifs à l'égard de tous les renseignements contenus dans le présent document.

⚡ WARNING ⚡



WARNING: Always read this manual thoroughly before using GS1 Series AC Motor Drives.



WARNING: AC input power must be disconnected before performing any maintenance. Do not connect or disconnect wires or connectors while power is applied to the circuit. Maintenance must only be performed by a qualified technician.



WARNING: There are highly sensitive MOS components on the printed circuit boards. These components are especially sensitive to static electricity. To avoid damage to these components, do not touch these components or the circuit boards with metal objects or your bare hands.



WARNING: A charge may still remain in the DC-link capacitor with hazardous voltages even if the power has been turned off. To avoid personal injury, do not remove the cover of the AC drive until all "DISPLAY LED" lights on the digital keypad are off. Please note that there are live components exposed within the AC drive. Do not touch these live parts.



WARNING: Ground the GS1 AC Drive using the ground terminal. The grounding method must comply with the laws of the country where the AC drive is to be installed. Refer to "Basic Wiring Diagram" in CHAPTER 2.



WARNING: The mounting enclosure of the AC drive must comply with EN50178. Live parts shall be arranged in enclosures or located behind barriers that meet at least the requirements of the Protective Type IP20. The top surface of the enclosures or barrier that is easily accessible shall meet at least the requirements of the Protective Type IP40. Users must provide this environment for GS1 Series AC Drive.



WARNING: The AC drive may be destroyed beyond repair if incorrect cables are connected to the input/output terminals. Never connect the AC drive output terminals T1, T2, and T3 directly to the AC main circuit power supply.



GS1 SERIES AC DRIVE USER MANUAL

Please include the Manual Number and the Manual Issue, both shown below, when communicating with Technical Support regarding this publication.

Manual Number: GS1-M
Issue: First Edition
Issue Date: 6/07/02

Publication History		
Issue	Date	Description of Changes
First Edition	6/07/02	Original

TABLE OF CONTENTS



Chapter 1: Getting Started	1-1
Manual Overview	1-2
GS1 AC Drive Introduction	1-3
GS1 AC Drive Specifications	1-5
Chapter 2: Installation and Wiring	2-1
Ambient Conditions	2-2
Installation	2-3
GS1 AC Drive Dimensions	2-4
GS1 Circuit Connections	2-5
Main Circuit Wiring	2-7
Chapter 3: Keypad Operation and Quickstart	3-1
The GS1 Digital Keypad	3-2
GS1 Quickstart	3-5
Example 1: Constant torque (e.g. conveyors, compressors, etc.)	3-5
Example 2: Variable torque (e.g. fans, centrifugal pumps, etc.)	3-9
Chapter 4: AC Drive Parameters	4-1
GS1 Parameter Summary	4-2
Detailed Parameter Listings	4-9
Motor Parameters	4-9
Ramp Parameters	4-11
Volts/Hertz Parameters	4-17
Digital Parameters	4-20
Analog Parameters	4-29
Analog Input Examples	4-31
Preset Parameters	4-37
Protection Parameters	4-38

Display Parameters	4-45
Communication Parameters	4-46
Chapter 5: GS1 MODBUS Communications	5-1
Communication Parameters Summary	5-2
GS1 Status Addresses (Read Only)	5-4
Communicating with DirectLogic PLCs	5-6
Communicating with Third-party Devices	5-16
Chapter 6: Maintenance and Troubleshooting	6-1
Maintenance and Inspection	6-2
Troubleshooting	6-3
Appendix A: Accessories	A-1
Circuit Protection Devices	A-2
Fuse Kits	A-2
Ethernet Interface	A-4
Miscellaneous Accessories	A-5
Appendix B: GS1 AC Drives with DirectLOGIC PLCs	B-1
Compatible DirectLOGIC PLCs and Modules	B-2
Typical Connections to the GS1 Series AC Drive	B-6
Index	i-1

GETTING STARTED



CHAPTER

1

In This Manual...

Manual Overview	1-2
GS1 AC Drive Introduction	1-3
GS1 AC Drive Specifications	1-5

Manual Overview

Overview of this Publication

The GS1 AC Drive User Manual describes the installation, configuration, and methods of operation of the GS1 Series AC Drive.

Who Should Read This Manual

This manual contains important information for those who will install, maintain, and/or operate any of the GS1 Series AC Drives.

Supplemental Publications

The National Electrical Manufacturers Association (NEMA) publishes many different documents that discuss standards for industrial control equipment. Global Engineering Documents handles the sale of NEMA documents. For more information, you can contact Global Engineering Documents at:

15 Inverness Way East
Englewood, CO 80112-5776
1-800-854-7179 (within the U.S.)
303-397-7956 (international)
www.global.ihs.com

NEMA documents that might assist with your AC drive systems are:

- **Application Guide for AC Adjustable Speed Drive Systems**
- **Safety Standards for Construction and Guide for Selection, Installation, and Operation of Adjustable Speed Drive Systems.**

Technical Support

By Telephone: 770-844-4200
(Mon.-Fri., 9:00 a.m.-6:00 p.m. E.T.)

On the Web: www.automationdirect.com

Our technical support group is glad to work with you in answering your questions. If you cannot find the solution to your particular application, or, if for any reason you need additional technical assistance, please call technical support at **770-844-4200**. We are available weekdays from 9:00 a.m. to 6:00 p.m. Eastern Time.

We also encourage you to visit our web site where you can find technical and non-technical information about our products and our company. Visit us at **www.automationdirect.com**.

Special Symbols



When you see the “notepad” icon in the left-hand margin, the paragraph to its immediate right will be a special note.



When you see the “exclamation mark” icon in the left-hand margin, the paragraph to its immediate right will be a WARNING. This information could prevent injury, loss of property, or even death (in extreme cases).

GS1 AC Drive Introduction

Unpacking

After receiving the AC motor drive, please check for the following:

- Make sure that the package includes an AC drive, the GS1 Series AC Drive User Manual, and the GS1 Series AC Drive Quick Reference.
- Inspect the unit to insure it was not damaged during shipment.
- Make sure that the part number indicated on the nameplate corresponds with the part number of your order.

Nameplate Information:

Example of 0.5HP 120V AC drive

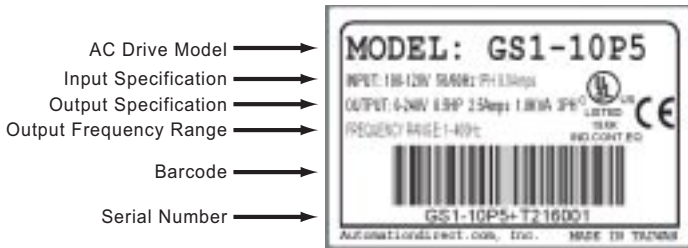

Model Explanation:

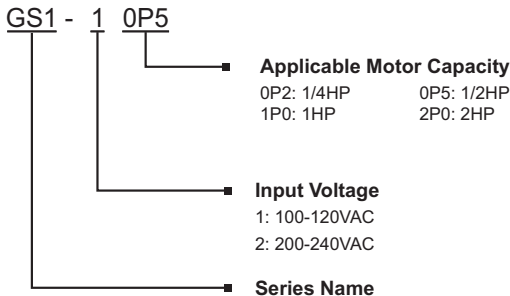

External Parts and Labels:



GS1 AC Drive Specifications

100V Class			
Model Name		GS1-10P2	GS1-10P5
Motor Rating	HP	1/4HP	1/2HP
	kW	0.2kW	0.4kW
Rated Input Voltage		Single-phase 100-120VAC $\pm 10\%$, 50/60Hz, $\pm 5\%$	
Maximum Output Voltage		Three-phase: 200-240VAC (x2 of input voltage)	
Rated Input Current (A)		6	9
Rated Output Current (A)		1.6	2.5
Watt Loss 100% (I)		19.2	19.2
Dimensions (HxWxD)		132.0mm (5.20") x 68.0mm (2.68") x 128.1mm (5.04")	

200V Class					
Model Name		GS1-20P2	GS1-20P5	GS1-21P0	GS1-22P0
Motor Rating	HP	1/4HP	1/2HP	1HP	2HP
	kW	0.2kW	0.4kW	0.7kW	1.5kW
Rated Input Voltage		Single/three-phase: 200-240VAC $\pm 10\%$, 50/60Hz $\pm 5\%$			Three-phase: 200-240VAC $\pm 10\%$, 50/60Hz $\pm 5\%$
Maximum Output Voltage		Three-phase: 200-240VAC (proportional to input voltage)			
Rated Input Current (A)		4.9/1.9	6.5/2.7	9.7/5.1	9
Rated Output Current (A)		1.6	2.5	4.2	7.0
Watt Loss 100% (I)		18.4	26.8	44.6	73
Dimensions (HxWxD)		132.0mm (5.20") x 68.0mm (2.68") x 128.1mm (5.04")			

General Specifications			
Control Characteristics			
Control System	Sinusoidal Pulse Width Modulation, carrier frequency 3kHz - 10kHz		
Rated Output Frequency	1.0 to 400.0 Hz		
Output Frequency Resolution	0.1 Hz		
Overload Capacity	150% of rated current for 1 minute		
Torque Characteristics	Includes auto-slip compensation and starting torque 150% @5.0Hz		
DC Braking	Operation frequency 60Hz, 0-30% rated voltage. Start time 0.0-5.0 seconds. Stop time 0.0 to 25.0 seconds		
Acceleration/Deceleration Time	0.1 to 600 seconds (can be set individually)		
Voltage/Frequency Pattern	V/F pattern adjustable. Settings available for Constant Torque - low and high starting torque, Variable Torque - low and high starting torque, and user configured		
Stall Prevention Level	20 to 200% or rated current		
Operation Specification			
Inputs	Frequency Setting	Keypad	Setting by <UP> or <DOWN> buttons or potentiometer
		External Signal	Potentiometer - 5k Ω 0.5W, 0 to 10VDC (input impedance 100k Ω), 4 to 20 mA (input impedance 250 Ω), Multi-function inputs 3 and 4 (3 steps, JOG, UP/DOWN command), RS485 communication setting
	Operation Setting	Keypad	Setting by <RUN>, <STOP> buttons
		External Signal	DI1, DI2, DI3, DI4 can be combined to offer various modes of operation, RS485 communication port
	Multi-Function Input Signal		Multi-speed selection 0 to 3, Jog, Accel/decel inhibit, First/second accel/decel switch, External base block (N.C., N.O.) selection
Outputs	Multi-Function Output Signal		AC drive operating, Frequency attained, Non zero speed, Base Block, Fault indication
	Operating Functions		Automatic voltage regulation, S-curve, Over-voltage stall prevention, DC braking, Fault records, Adjustable carried frequency, Starting frequency setting of DC braking, Over-current stall prevention, Momentary power loss restart, Reverse inhibition, Frequency limits, Parameter lock/reset

General Specifications (cont.)		
Protective Functions		Overcurrent, Overvoltage, Undervoltage, Electronic thermal motor overload, Overheating, Overload, Self testing
Operator Interface	Operator Devices	5-key, 4-digit, 7-segment LED, 4 status LEDs, potentiometer
	Programming	Parameter values for setup and review, fault codes
	Parameter Monitor	Master Frequency, Output Frequency, Scaled Output Frequency, Output Voltage, DC Bus Voltage, Output Direction, Trip Event Monitor, Trip History Monitor
	Key Functions	RUN/STOP, DISPLAY/RESET, PROGRAM/ENTER, <UP>, <DOWN>
Environment	Enclosure Rating	Protected chassis, IP20
	Ambient Temperature	-10° to 40°C (14°F to 104°F) w/o derating
	Storage Temperature	-20° to 60 °C (-4°F to 140°F) during short-term transportation period)
	Ambient Humidity	0 to 90% RH (non-condensing)
	Vibration	9.8 m/s ² (1G), less than 10Hz. 5.88 m/s ² (0.6G) 20 to 50 Hz
	Installation Location	Altitude 1000m or lower above sea level, keep from corrosive gas, liquid and dust

INSTALLATION AND WIRING



CHAPTER 2

In This Chapter...

Ambient Conditions	2-2
Installation	2-3
GS1 AC Drive Dimensions	2-4
GS1 Circuit Connections	2-5
Main Circuit Wiring	2-7

Ambient Conditions

The AC drive should be kept in the shipping carton before installation. In order to retain the warranty coverage, the AC drive should be stored properly when it is not to be used for an extended period of time. Some storage suggestions are:

- Store in a clean and dry location free from direct sunlight or corrosive fumes.
- Store within an ambient temperature range of -20°C to +60°C.
- Store within a relative humidity range of 0% to 90% and non-condensing environment.
- Store within an air pressure range of 86 kPa to 106kPa.

Ambient Conditions	
Ambient Temperature	-10° to 40°C (14°F to 104°F) w/o derating
Storage Temperature	-20° to 60 ° C (-4°F to 140°F) during short-term transportation period)
Relative Humidity	0 to 90% RH (non-condensing)
Atmosphere Pressure	86 kPa to 106kPa
Vibration	9.8 m/s ² (1G), less than 10Hz. 5.88 m/s ² (0.6G) 20 to 50 Hz
Installation Location	Altitude 1000m or lower above sea level, keep from corrosive gas, liquid and dust
Enclosure Rating	Protected chassis, IP20

Installation

Improper installation of the AC drive will greatly reduce its life. Be sure to observe the following precautions when selecting a mounting location:



WARNING: Failure to observe these precautions may damage the drive and void the warranty!

- Do not mount the AC drive near heat-radiating elements or in direct sunlight.
- Do not install the AC drive in a place subjected to high temperature, high humidity, excessive vibration, corrosive gases or liquids, or airborne dust or metallic particles.
- Mount the AC drive vertically and do not restrict the air flow to the heat sink fins.



WARNING: AC drives generate a large amount of heat which may damage the AC drive. Auxiliary cooling methods are typically required in order not to exceed maximum ambient temperatures.

Minimum Clearances and Air Flow

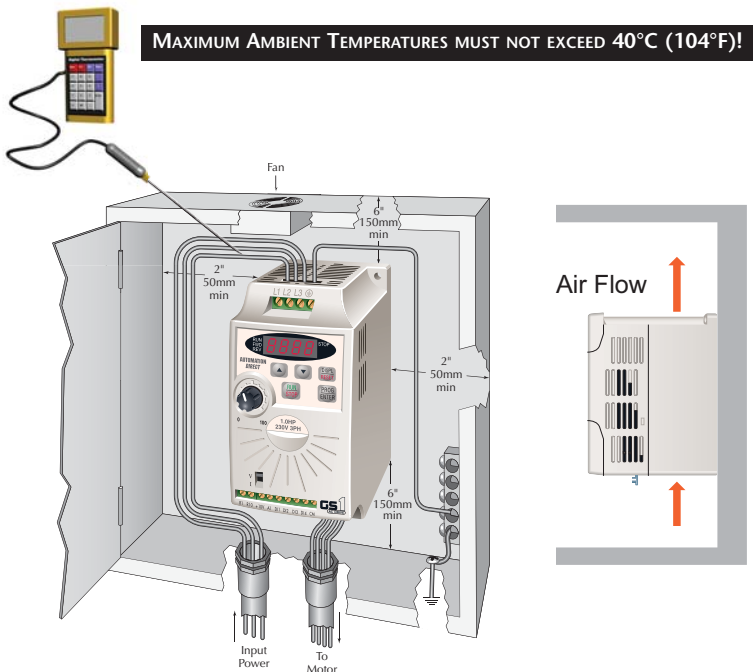

GS1 AC Drive Dimensions

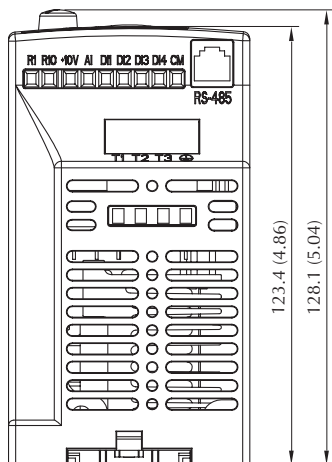
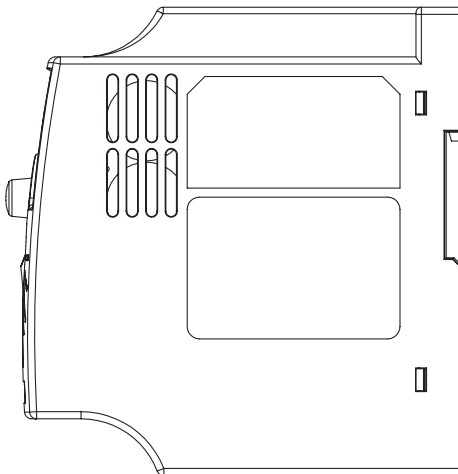
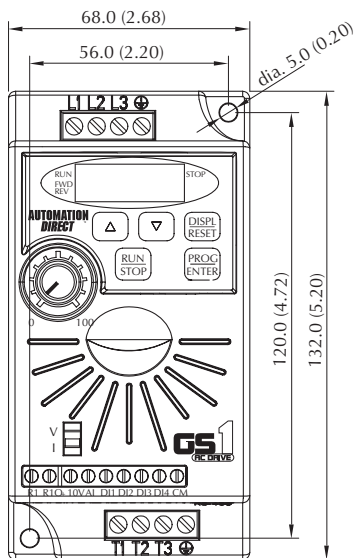

Unit: mm (in)

GS1 Circuit Connections

DANGER!



HAZARDOUS VOLTAGE! Before making any connection to the AC drive, disconnect all power to the AC drive, and wait five minutes for DC bus capacitors to discharge.



WARNING: Any electrical or mechanical modification to this equipment without prior written consent of AutomationDirect.com, Inc. will void all warranties, may result in a safety hazard, and may void the UL listing.

Wiring Notes: PLEASE READ PRIOR TO INSTALLATION.



WARNING: Do not connect the AC input power to the T1, T2, T3 output terminals. This will damage the AC drive.



WARNING: Tighten all screws to the proper torque rating. See “Main Circuit Wiring” later in this chapter.

1. During installation, follow all local electrical, construction, and safety codes for the country the AC drive is to be installed in.
2. Make sure the appropriate protective devices (circuit breaker or fuses) are connected between the power supply and AC drive.
3. Make sure that the leads are connected correctly and the AC drive is properly grounded. (Ground resistance should not exceed 0.1Ω.)
4. Use ground leads that comply with AWG/MCM standards and keep them as short as possible.
5. Multiple GS1 units can be installed in one location. All the units should be grounded directly to a common ground terminal. The GS1 ground terminals may also be connected in parallel, as shown in the figure below. **Make sure there are no ground loops.**

Correct



Incorrect

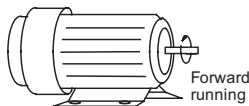

6. When the AC drive output terminals T1, T2, and T3 are connected to the motor terminals T1, T2, and T3, respectively, the motor will rotate counterclockwise (as viewed from the shaft end of the motor) when a forward operation command is received. To reverse the direction of motor rotation, switch the connections of any of the two motor leads.
7. Make sure that the power source is capable of supplying the correct voltage and required current to the AC drive.

8. Do not attach or remove wiring when power is applied to the AC drive.
9. Do not monitor the signals on the circuit board while the AC drive is in operation.
10. For the single-phase, 200V class AC drives, the AC power can be connected to any two of the three input terminals L1, L2, and L3. For single-phase, 120V class AC drives, AC power must be connected to terminals L1 and L2.



Note: This AC drive is not intended for use with single-phase motors.

11. Route the power and control wires separately, or at 90 degree angle to each other.
12. When using a GFCI (Ground Fault Circuit Interrupt), select current sensor with sensitivity of 200mA, and not less than 0.1-second detection to avoid nuisance tripping.

Motor Operation Precautions

1. When using the AC drive to operate a standard 3-phase induction motor, notice that the energy loss is greater than for an inverter duty motor.
2. Avoid running a standard induction motor at low speed, which may cause the motor temperature to exceed the motor rating due to limited airflow produced by the motor's fan.
3. When the standard motor operates at low speed, the output load must be decreased.
4. If 100% output torque is desired at low speed, it may be necessary to use a special "inverter-duty" rated motor.

Short Circuit Withstand:

Suitable for use on a circuit capable of delivering not more than 5,000 rms symmetrical amperes. For all 120V models, the maximum is 120 volts. For all 230V Models, the maximum is 240 volts.

Applicable Codes

All GS1 Series AC drives are Underwriters Laboratories, Inc. (UL) and Canadian Underwriters Laboratories (cUL) listed, and therefore comply with the requirements of the National Electrical Code (NEC) and the Canadian Electrical Code (CEC).

Installation intended to meet the UL and cUL requirements must follow the instructions provided in "Wiring Notes" as a minimum standard. Follow all local codes that exceed UL and cUL requirements. Refer to the technical data label affixed to the AC drive and the motor nameplate for electrical data.

The "Circuit Protection Devices" in APPENDIX A, lists the recommended fuse part number for each GS1 Series part number. These fuses (or equivalent) must be used on all installations where compliance with U.L. standards is required.

Main Circuit Wiring

Main Circuit Terminals	
Terminal	Description
L1, L2, L3	Input Power
T1, T2, T3	AC Drive Output
⊕	Ground

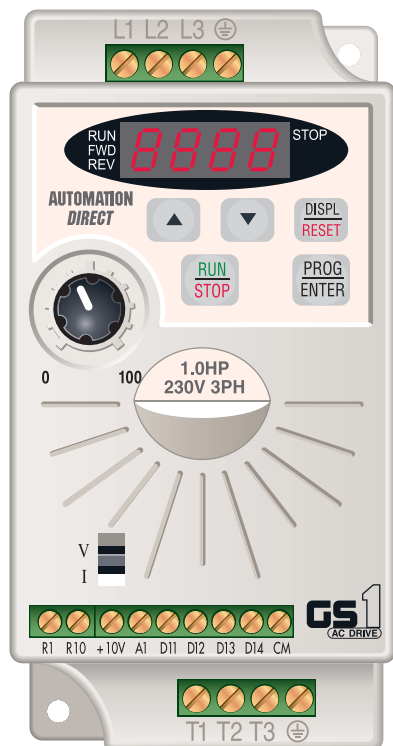

Main Circuit Wiring Specifications			
AC Drive Model	Max. Current (Input/Output)	Wire Gauge	Torque
GS1-10P2	6A/1.6A	12-16 AWG	5.5kgf-cm
GS1-10P5	9A/2.5A		
GS1-20P2 (1-phase)	4.9A/1.6A		
GS1-20P2 (3-phase)	1.9A/1.6A		
GS1-20P5 (1-phase)	6.5A/2.5A	12-14 AWG	5.5kgf-cm
GS1-20P5 (3-phase)	2.7A/2.5A		
GS1-21P0 (1-phase)	9.7A/4.2A		
GS1-21P0 (3-phase)	5.1A/4.2A		
GS1-22P0	9A/7.0A		

*Wire type: 75°C, Copper only

Input Power Connections

3-phase Input Power Connections

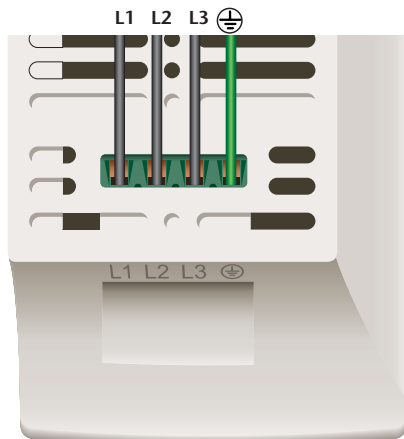

GSI Top View

3-phase Input Power	
200V Class	Three-phase: 200-240VAC \pm 10%, 50/60Hz \pm 5%

1-phase Input Power Connections*

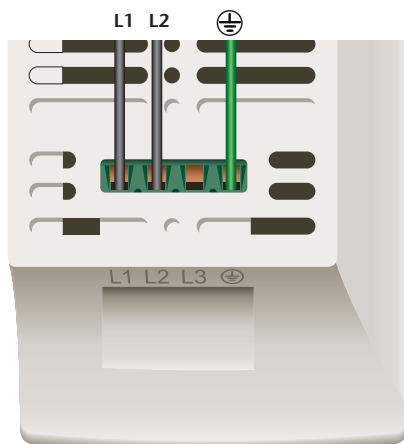

GSI Top View

1-phase Input Power*	
100V Class	Single-phase 100-120VAC \pm 10%, 50/60Hz, \pm 5%
200V Class	Single-phase: 200-240VAC \pm 10%, 50/60Hz \pm 5%

*Only models GS1-10P2, GS1-10P5, GS1-20P2, GS1-20P5, and GS1-21P0 are rated for single-phase input power.

Output Power Connections

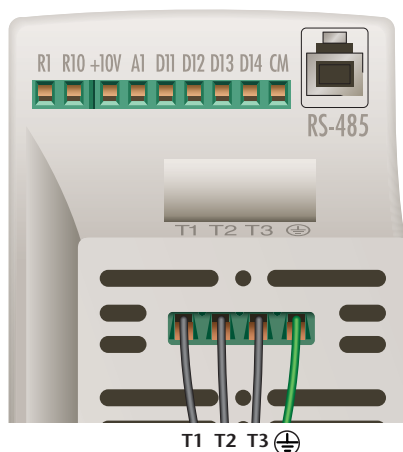

GSI Bottom View

100V Class			
Model Name		GSI-10P2	GSI-10P5
Max. Motor Output	HP	1/4HP	1/2HP
	kW	0.2kW	0.4kW
Maximum Output Voltage	Three phase: 200-240VAC (x2 of input voltage)		
Rated Output Current		1.6A	2.5A
Rated Output Frequency	1.0 to 400Hz		

200V Class					
Model Name		GSI-20P2	GSI-20P5	GSI-21P0	GSI-22P0
Max. Motor Output	HP	1/4HP	1/2HP	1HP	2HP
	kW	0.2kW	0.4kW	0.75kW	1.5kW
Maximum Output Voltage	Three phase: 200-240VAC (proportional to input voltage)				
Rated Output Current		1.6A	2.5A	4.2A	7.0A
Rated Output Frequency	1.0 to 400Hz				

Control Terminal Wiring (Factory Settings)

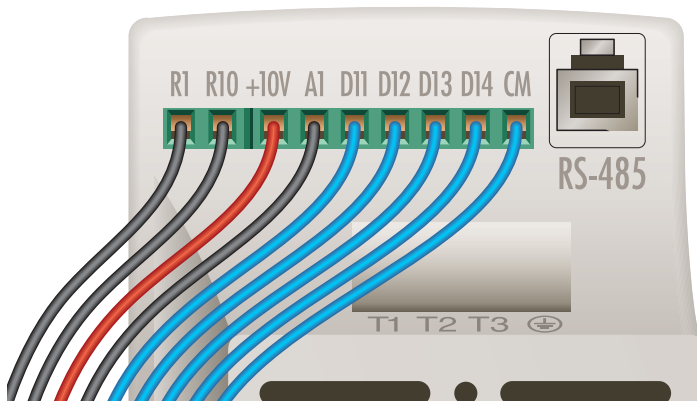

G51 Bottom View

Control Circuit Terminals		
Terminal Symbol	Description	Remarks
R1	Relay Output Common	120VAC/24VDC @5A, 230VAC @2.5A
R10	Relay Output Normally Open	
+10V	Internal Power Supply	+10VDC
AI	Analog Input	0 to +10V (Max. Output Frequency) Input or 4 to 20mA (Max. Output Frequency) Input
DI1	Digital Input 1	See "Basic Wiring Diagram" on next page.
DI2	Digital Input 2	
DI3	Digital Input 3	
DI4	Digital Input 4	
CM	Common	



Note: Use twisted-shielded, twisted-pair or shielded-lead wires for the control signal wiring. It is recommended to run all signal wiring in a separate steel conduit. The shield wire should only be connected at the AC drive. Do not connect shield wire on both ends.

Basic Wiring Diagram



Note: Users must connect wiring according to the circuit diagram shown below.

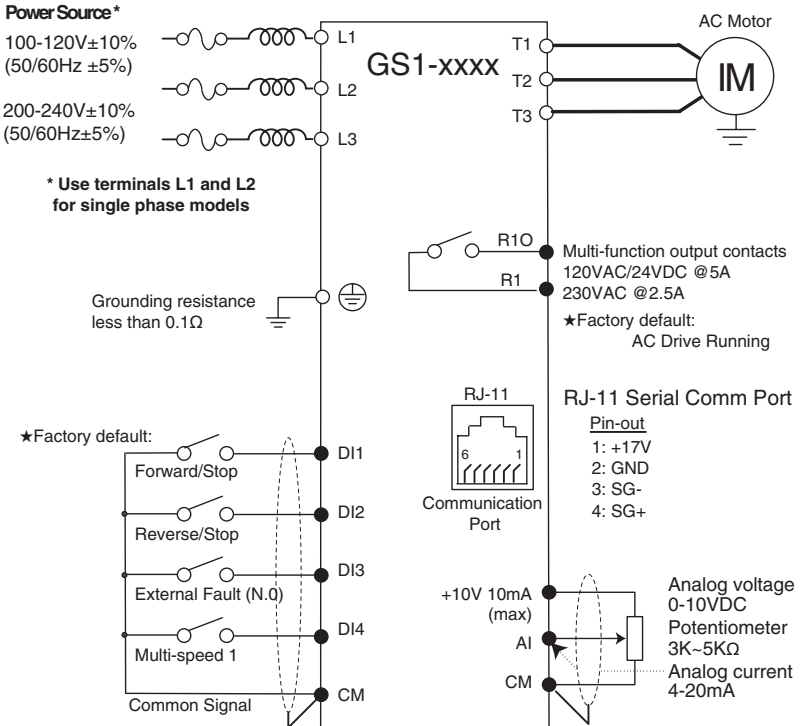

★Factory default: output frequency determined by the potentiometer on the keypad.

○ Main circuit (power) terminals ● Control circuit terminal ⚡ Shielded leads



WARNING: Do not plug a modem or telephone into the GS1 RJ-11 Serial Comm Port, or permanent damage may result. Terminals 1 and 2 must not be used as a power source for your communication connection.

External Wiring

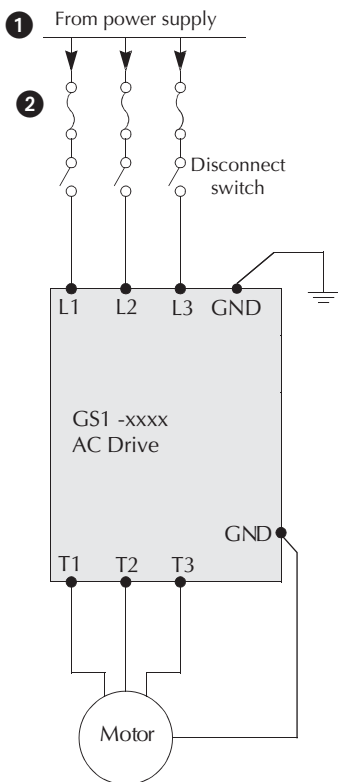

1 Power Supply

Please follow the specific power supply requirements shown in CHAPTER 1.

2 Fuse

Input fuses protect the AC drive from excessive input current due to line surges, short circuits, and ground faults. They are recommended for all installations and may be required for UL-listed installations.



Note: Please refer to APPENDIX A for specifications on GS1 AC Drive Accessories.

KEYPAD OPERATION AND QUICKSTART



CHAPTER 3

In This Chapter...

The GS1 Digital Keypad	3-2
GS1 Quickstart	3-5

The GS1 Digital Keypad

The digital keypad includes a 4-digit LED display, 4 LED indicators, 5 function keys, and a potentiometer. The diagram below shows all of the features of the digital keypad and an overview of their functions.

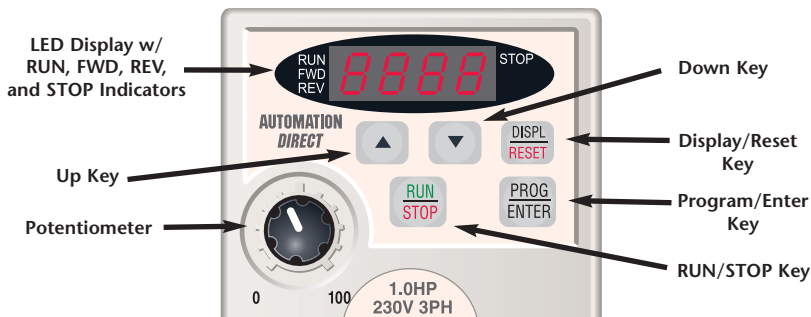

LED Display

The LED Display shows the operation values and parameter settings of the AC drive. The display also has four LED Indicators that show the RUN, STOP, FWD, and REV status of the AC drive.

Function Keys



Program/Enter Key

Press the PROGRAM/ENTER key to view parameters and store parameter settings.



Display/Reset Key

Press the DISPL/RESET key to cycle through the operational values (Status Display) of the AC drive. This key will also reset the AC drive when a fault has occurred.



Run/Stop Key

Press the RUN/STOP key to start or stop the AC drive operation.

Up / Down Keys



Press the "UP" or "Down" keys to scroll through the parameter set or to change parameter settings. Press the "Up" or "Down" key momentarily to change the parameter settings in single-unit increments. To quickly run through the range of settings, press and hold the "Up" or "Down" keys.

Potentiometer



The potentiometer is used to for set the AC drive operation frequency.

Displaying the Status of the GS1 AC Drive

Press the DISPL/RESET button on the keypad repeatedly to cycle through the status messages on the AC drive. The diagram below shows the order of the status messages and their definitions. The status of the AC drive can be shown in RUN or STOP mode.

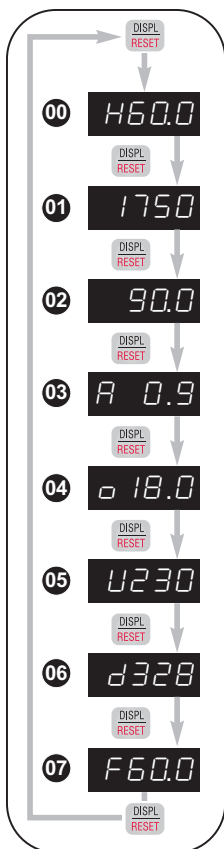

00 Actual Operating Frequency

Displays the actual operating frequency present at the T1, T2, and T3 terminals. *Example: 60.0Hz*

01 RPM

Displays the present *estimated* speed of the motor. *Example: 1750 RPM*

02 Scaled Frequency

Displays the result of output frequency x 8-01. *Example: 60Hz x 1.5 = 90.0*

03 Amps

Displays the output current present at the T1, T2, and T3 terminals. *Example: 0.9A*

04 % Load

Displays the amount of load on the AC drive. *Example: (Output Current ÷ Drive Rated Current) x 100*

05 Output Voltage

Displays the output voltage present at the T1, T2, and T3 terminals. *Example: 230V*

06 DC Bus Voltage

Displays the DC Bus Voltage. *Example: 328 VDC*

07 Setpoint Frequency

Displays the frequency setting of the AC drive. *Example: 60.0Hz*

Programming the GS1 AC Drive

The GS1 AC Drive parameters are organized into 10 different groups according to their functions. The illustration below shows you how to navigate through the parameter groups and parameter settings. For a complete list of parameters, see CHAPTER 4.

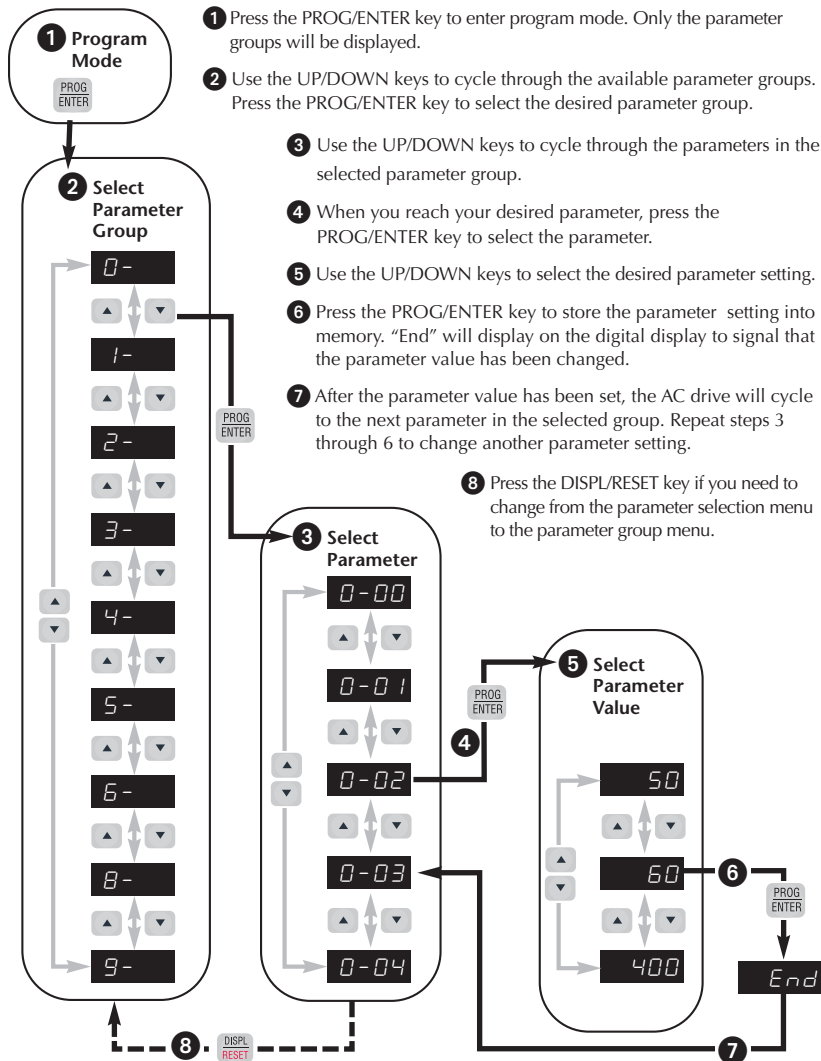

GS1 Quickstart

The following examples will help you quickly setup your GS1 AC Drive for two common applications. The first example applies to an application that requires constant torque, and the second example requires variable torque in its application.



Note: For a complete list and description of the parameters for the GS1 Series AC drives, see CHAPTER 4.

Example 1: Constant torque (e.g. conveyors, compressors, etc.)

In this example, the AC drive needs to operate a motor that is connected to a conveyor. In order to decide which parameters need modifications, we will make a list of the needs for the application.

Application Needs

- The AC drive must control a 230V, 1HP motor. The AC drive model we will be using for this application is a GS1-21P0. An example of the motor nameplate is shown below.

INVERTER DUTY MOTOR							
HP	1	Volts	230	PHASE	3	TYPE	P
RPM	1725	AMPS	4.2	HZ	60	SF	1.15
DESIGN	B		AMB	40°C		INSUL CLASS	F
DUTY	CONT		ENCL	TEFC		CODE	K

- The maximum speed for the motor is 2000 RPM.
- The motor should accelerate to maximum speed in 5 seconds.
- The motor should decelerate from maximum speed in 5 seconds.
- The motor will require a high torque when starting.
- The operation of the motor (start, stop, etc.) will be controlled by external control terminals. All keys on the GS1 keypad should be disabled.
- The frequency of the AC drive will be determined by remote potentiometer that has a 0 to +10V signal.
- The display of the AC drive should default to the motor speed (RPM) when running.

Parameter Setup

In order to meet the needs of this application, the parameters should be set as follows:

0-00 **Motor Nameplate Voltage** **Setting: 230**

Range: 200V series: 200/208/220/230/240 Default Setting: 240
This parameter setting is determined by the motor nameplate.

0-01 **Motor Nameplate Amps** **Setting: 4.2**

Range: Drive Rated Amps x .3 to Default Setting: Drive Rating (A)
Drive Rated Amps x 1.0

This parameter setting is determined by the motor nameplate..

0-02 **Motor Base Frequency** **Setting: 60**

Range: 50/60/400 Default Setting 60
This parameter setting is determined by the motor nameplate.

0-03 **Motor Base RPM** **Setting: 1725**

Range: 375 to 9999 RPM Default Setting: 1750
This parameter setting is determined by the motor nameplate.

0-04 **Motor Maximum RPM** **Setting: 2000**

Range: **0-03** to 9999 RPM Default Setting: **0-03**
This parameter setting is determined by the needs of the application.



WARNING: The Motor Maximum RPM parameter (0-04) should never exceed the maximum RPM rating for the motor you are using. If this information is not readily available, consult your motor manufacturer.

1-00 **Stop Methods** **Setting: 0**

Range: 0 - Ramp to Stop Default Setting: 0
1 - Coast to stop

The application requires that this parameter be set to Ramp to Stop because the motor needs to stop under power. If the AC drive was set for Coast to Stop, the AC drive would ignore the Deceleration Time setting.



WARNING: If the Stop Method for the GS1 AC drive is set for Coast to Stop, the AC drive will ignore any setting you have for Deceleration Time (1-02).

1-01 Acceleration Time **Setting: 5.0**

Range: 0.1 to 600 sec Default Setting: 10 sec
 The motor should accelerate from 0 RPM to Base RPM (0-03) in 5 seconds.

1-02 Deceleration Time **Setting: 5.0**

Range: 0.1 to 600 sec Default Setting: 30 sec
 The motor should decelerate from Maximum RPM (0-04) to 0 RPM in 5 seconds.

2-00 Volts/Hertz Settings **Setting: 1**

Range: 0 - General Purpose Default Setting: 0
 1 - High Starting Torque
 2 - Fans and Pumps
 3 - Custom

The GS1 Series AC drive has some predefined torque settings that meet the needs of most applications. A custom setting is available if needed. In this example, the application requires a high starting torque.

3-00 Source of Operation Command **Setting: 2**

Default Setting: 0

Settings	0	Operation Determined by Digital Keypad
	1	Operation determined by external control terminals. Keypad STOP is enabled.
	2	Operation determined by external control terminals. Keypad STOP is disabled.
	3	Operation determined by RS485 interface. Keypad STOP is enabled.
	4	Operation determined by RS485 interface. Keypad STOP is disabled.

The AC drive operation will be determined by external control terminals and the keypad stop will be disabled.

4-00

Source of Frequency Command

Setting: 2

The frequency of the AC drive will be determined by an external potentiometer with a 0 to +10V signal.

Default: 0

- Settings:
- 0 Frequency determined by keypad potentiometer
 - 1 Frequency determined by digital keypad up/down
 - 2 Frequency determined by 0 to +10V input on AI terminal. AI switch must be set to "V".



Switch must be set to "V" in order to use a 0 to +10V input

- 3 Frequency determined by 4 to 20mA input on AI terminal. AI switch must be set to "I".



Switch must be set to "I" in order to use a 4 to 20mA input

- 4 Frequency determined by 0 to 20mA input on AI terminal. AI switch must be set to "I".



Switch must be set to "I" in order to use a 0 to 20mA input

- 5 Frequency determined by RS485 communication interface

8-00

User Defined Display Function

Setting: 1

The AC drive display will default to motor speed (RPM) when running.

Default Setting: 0

- Settings:
- 0 Output Frequency (Hz)
 - 1 Motor Speed (RPM)
 - 2 Output Frequency x 8-01
 - 3 Output Current (A)
 - 4 Motor Output Current (%)
 - 5 Output Voltage(V)
 - 6 DC Bus Voltage (V)
 - 9 Frequency Setpoint

Example 2: Variable torque (e.g. fans, centrifugal pumps, etc.)

In this example, the AC drive needs to operate a motor that is connected to a centrifugal pump. As in Example 1, we will make a list of the needs for the application in order to decide which parameters need modifications.

Application Needs

- The AC drive must control a 208V, 1/2HP motor. The AC drive model we will be using for this application is a GS1-20P5. An example of the motor nameplate is shown below.

INVERTER DUTY MOTOR							
HP	0.5	Volts	208	PHASE	3	TYPE	P
RPM	3525	AMPS	2.5	HZ	60	SF	1.15
DESIGN	B		AMB	40°C		INSUL CLASS	F
DUTY	CONT		ENCL	TEFC		CODE	K

- The maximum speed for the motor is 3600 RPM.
- The motor should accelerate to maximum speed in 20 seconds.
- The motor should coast to stop when operation is terminated.
- The motor will be turning a centrifugal pump.
- The operation of the motor (start, stop, etc.) will be controlled by the GS1 digital keypad.
- The frequency of the AC drive will be determined by the GS1 keypad potentiometer.
- The display of the AC drive should default to output current (A) when running.

Parameter Setup

In order to meet the needs of this application, the parameters should be set as follows:

0-00 **Motor Nameplate Voltage** **Setting: 208**

Range: 200V series: 200/208/220/230/240 Default Setting: 240
This parameter setting is determined by the motor nameplate.

0-01 **Motor Nameplate Amps** **Setting: 2.5**

Range: Drive Rated Amps x .3 to Default Setting: Drive Rating (A)
Drive Rated Amps x 1.0
This parameter setting is determined by the motor nameplate.

0-02 Motor Base Frequency **Setting: 60**

Range: 50/60/400

Default Setting: 60

This parameter setting is determined by the motor nameplate.

0-03 Motor Base RPM **Setting: 3525**

Range: 375 to 9999 RPM

Default Setting: 1750

This parameter setting is determined by the motor nameplate.

0-04 Motor Maximum RPM **Setting: 3600**

Range: 0-03 to 9999 RPM

Default Setting: 0-03

This parameter setting is determined by the needs of the application.



WARNING: The Motor Maximum RPM parameter (0-04) should never exceed the maximum RPM rating for the motor you are using. If this information is not readily available, consult your motor manufacturer.

1-00 Stop Methods **Setting: 1**

Range: 0 - Ramp to Stop
1 - Coast to stop

Default Setting: 0

The application requires that this parameter be set to Coast to Stop.



WARNING: If the Stop Method for the GS1 AC drive is set for Coast to Stop, the AC drive will ignore any setting you have for Deceleration Time (1-02).

1-01 Acceleration Time **Setting: 20.0**

Range: 0.1 to 600 sec

Default Setting: 10 sec

The motor should accelerate from 0 RPM to Base RPM (0-03) in 20 seconds.

2-00 Volts/Hertz Settings **Setting: 2**

Range: 0 - General Purpose
1 - High Starting Torque
2 - Fans and Pumps
3 - Custom

Default Setting: 0

The GS1 Series AC drive has some predefined torque settings that meet the needs of most applications. A custom setting is available if needed. In this example, the motor will be running a pump.

3-00**Source of Operation Command****Setting: 0**

The AC drive operation will be determined by external control terminals and the keypad stop is enabled.

Default Setting: 0

Settings	0	Operation Determined by Digital Keypad
	1	Operation determined by external control terminals. Keypad STOP is enabled.
	2	Operation determined by external control terminals. Keypad STOP is disabled.
	3	Operation determined by RS485 interface. Keypad STOP is enabled.
	4	Operation determined by RS485 interface. Keypad STOP is disabled.

4-00**Source of Frequency Command****Setting: 0**

The frequency of the AC drive will be determined by keypad potentiometer.

Default: 0

Settings:	0	Frequency determined by keypad potentiometer
	1	Frequency determined by digital keypad up/down
	2	Frequency determined by 0 to +10V input on AI terminal. AI switch must be set to "V".



Switch must be set to "V" in order to use a 0 to +10V input

	3	Frequency determined by 4 to 20mA input on AI terminal. AI switch must be set to "I".
--	---	---



Switch must be set to "I" in order to use a 4 to 20mA input

	4	Frequency determined by 0 to 20mA input on AI terminal. AI switch must be set to "I".
--	---	---



Switch must be set to "I" in order to use a 0 to 20mA input

	5	Frequency determined by RS485 communication interface
--	---	---

6-00**Electronic Thermal Overload Relay****Setting: 1**

Range: 0 - Constant Torque
1 - Variable Torque
2 - Inactive

Default Setting: 0

- This function is used to limit the output power of the AC drive when powering a “self-cooled” motor at low speed.

8-00**User Defined Display Function****Setting: 03**

Default Setting: 00

Settings:	00	Output Frequency (Hz)
	01	Motor Speed (RPM)
	02	Output Frequency x 8-01
	03	Output Current (A)
	04	Motor Output Current (%)
	05	Output Voltage(V)
	06	DC Bus Voltage (V)
	09	Frequency Setpoint

The AC drive display will default to output current (A) when running.



Note: For a complete list and description of the parameters for the GS1 Series AC drives, see CHAPTER 4.

AC DRIVE PARAMETERS



CHAPTER 4

In This Chapter...

GS1 Parameter Summary	4-2
Detailed Parameter Listings	4-9
Motor Parameters	4-9
Ramp Parameters	4-11
Volts/Hertz Parameters	4-17
Digital Parameters	4-20
Analog Parameters	4-29
Analog Input Examples	4-31
Preset Parameters	4-37
Protection Parameters	4-38
Display Parameters	4-45
Communication Parameters	4-46

GS1 Parameter Summary

Motor Parameters			
GS1 Parameter	Description	Range	Default
0-00	Motor Nameplate Voltage	200/208/220/230/240	240
0-01	Motor Nameplate Amps	Drive Rated Amps X .3 to 1.0	Drive Rated Amps X 1.0
0-02	Motor Base Frequency	50/60/400	60
0-03	Motor Base RPM	375 to 9999 RPM	1750
0-04	Motor Maximum RPM	0-03 to 9999 RPM	0-03
Ramps			
1-00	Stop Methods	0: Ramp to Stop 1: Coast to Stop	0
◆ 1-01	Acceleration Time 1	0.1 to 600.0 sec	10.0
◆ 1-02	Deceleration Time 1	0.1 to 600.0 sec	30.0
1-03	Accel S-curve	0 to 7	0
1-04	Decel S-curve	0 to 7	0
◆ 1-05	Acceleration Time 2	0.1 to 600.0 sec	10.0
◆ 1-06	Deceleration Time 2	0.1 to 600.0 sec	30.0
1-07	Select method to use 2nd Accel/Decel	0: RMP2 from terminal 1: Transition Frequencies P1.08 & P1.09	0
1-08	Accel 1 to Accel 2 frequency transition	0.0 to 400.0 Hz	0.0
1-09	Decel 1 to Decel 2 frequency transition	0.0 to 400.0 Hz	0.0
1-10	Skip Frequency 1	0.0 to 400.0 Hz	0.0
1-11	Skip Frequency 2	0.0 to 400.0 Hz	0.0
1-12	Skip Frequency 3	0.0 to 400.0 Hz	0.0
1-17	Skip Frequency Band	0.0 to 20.0 Hz	0.0
1-19	DC Injection Voltage Level	0 to 30%	0
1-20	DC Injection during Start-up	0.0 to 5.0 sec	0.0
1-21	DC Injection during Stopping	0.0 to 25.0 sec	0.0
1-22	Start-point for DC Injection	0.0 to 60.0 Hz	0.0

◆ Parameter can be set during RUN Mode.

Ramps			
G51 Parameter	Description	Range	Default
2-00	Volts/Hertz Settings	0: General Purpose 1: High Starting Torque 2: Fans and Pumps 3: Custom	0
◆ 2-01	Slip Compensation	0.0 to 10.0	0.0
◆ 2-03	Manual Torque Boost	0 to 10%	1
2-04	Mid-point Frequency	1.0 to 400 Hz	1.5
2-05	Mid-point Voltage	2.0 to 255V	10.0
2-06	Min. Output Frequency	1.0 to 20.0 Hz	1.5
2-07	Min. Output Voltage	2.0 to 50V	10.0
2-08	PWM Carrier Frequency	03 to 10 KHz	10
Digital			
3-00	Source of Operation Command	0: Operation determined by digital keypad 1: Operation determined by external control terminals, keypad STOP is enabled 2: Operation determined by external control terminals, keypad STOP is disabled 3: Operation determined by RS-485 interface, keypad STOP is enabled 4: Operation determined by RS-485 interface, keypad STOP is disabled	0
3-01	Multi-function Input Terminals (DI1 - DI2)	0: DI1 - FWD / STOP, DI2 - REV / STOP 1: DI1 - RUN / STOP, DI2 - REV / FWD 2: DI1 - RUN momentary (N.O.) DI2 - REV / FWD DI3 - STOP momentary (N.C.)	0
3-02	Multi-function Input (DI3)	0: External Fault (N.O.) 1: External Fault (N.C.) 2: External Reset 3: Multi-Speed Bit 1 4: Multi-Speed Bit 2 9: Jog 10: External Base Block (N.O.)	0
3-03	Multi-function Input (DI4)	11: External Base Block (N.C.) 12: Second Accel/Decel Time 13: Speed Hold 14: Increase Speed 15: Decrease Speed 16: Reset Speed to Zero 99: Input Disable	3

◆ Parameter can be set during RUN Mode.

Digital (cont.)			
GS1 Parameter	Description	Range	Default
3-11	Multi-Function Output Terminal	0: AC Drive Running 1: AC Drive Fault 2: At Speed 3: Zero Speed 4: Above Desired Frequency (3-16) 5: Below Desired Frequency (3-16) 6: At Maximum Speed 7: Over torque detected 8: Above Desired Current (3-17) 9: Below Desired Current (3-17)	0
◆ 3-16	Desired Frequency	0.0 to 400Hz	0.0
◆ 3-17	Desired Current	0.0 to Drive Rated Amps	0.0
Analog			
4-00	Source of Frequency Command	0: Frequency determined by keypad potentiometer 1: Frequency determined by digital keypad up/down 2: Frequency determined by 0 to +10V input on AI terminal with switch 3: Frequency determined by 4 to 20mA input on AI terminal with switch 4: Frequency determined by 0 to 20mA input on AI terminal with switch 5: Frequency determined by RS-485 communication interface	0
4-01	Analog Input Offset Polarity	0: No Offset 1: Positive Offset 2: Negative Offset	0
◆ 4-02	Analog Input Offset	0.0 to 100.0%	0.0
◆ 4-03	Analog Input Gain	0.0 to 300.0%	100.0
4-04	Analog Input Reverse Motion Enable	0: Forward Motion Only 1: Reverse Motion Enable	0
4-05	Loss of ACI Signal (4-20mA)	0: Decelerate to 0Hz 1: Stop immediately and display error code "EF" 2: Continue operation by the last frequency command	0
Presets			
◆ 5-00	Jog	0.0 to 400Hz	6.0
◆ 5-01	Multi-Speed 1	0.0 to 400Hz	0.0
◆ 5-02	Multi-Speed 2	0.0 to 400Hz	0.0
◆ 5-03	Multi-Speed 3	0.0 to 400Hz	0.0

◆ Parameter can be set during RUN Mode.

Protection			
G51 Parameter	Description	Range	Default
6-00	Electronic Thermal Overload Relay	0: Constant Torque 1: Variable Torque 2: Inactive	0
6-01	Auto Restart after Fault	0 to 10	0
6-02	Momentary Power Loss	0: Stop operation after momentary power loss 1: Continue operation after momentary power loss, speed search from Speed Reference 2: Continue operation after momentary power loss, speed search from Minimum Speed	0
6-03	Reverse Operation Inhibit	0: Enable Reverse Operation 1: Disable Reverse Operation	0
6-04	Auto Voltage Regulation	0: AVR enabled 1: AVR disabled 2: AVR disabled during decel 3: AVR disabled during stop	0
6-05	Over-Voltage Trip Prevention	0: Enable Over-voltage Trip Prevention 1: Disable Over-voltage Trip Prevention	0
6-06	Auto Adjustable Accel/Decel	0: Linear Accel/Decel 1: Auto Accel, Linear Decel 2: Linear Accel, Auto Decel 3: Auto Accel/Decel 4: Auto Accel/Decel Stall Prevention (limited by 1-01, 1-02, 1-05 and 1-06)	0
6-07	Over-Torque Detection Mode	0: Disabled 1: Enabled during constant speed operation 2: Enabled during acceleration	0
6-08	Over-Torque Detection Level	30 to 200%	150
6-09	Over-Torque Detection Time	0.1 to 10.0	0.1
6-10	Over-Current Stall Prevention during Acceleration	20 to 200%	150
6-11	Over-Current Stall Prevention during Operation	20 to 200%	150
6-12	Maximum Allowable Power Loss Time	0.3 to 5.0 sec	2.0
6-13	Base-Block Time for Speed Search	0.3 to 5.0 sec	0.5
6-14	Maximum Speed Search Current Level	30 to 200%	150
6-15	Upper Bound of Output Frequency	0.1 to 400.0Hz	400.0
6-16	Lower Bound of Output Frequency	0.0 to 400.0Hz	0.0

◆ Parameter can be set during RUN Mode.

Protection (cont.)			
G51 Parameter	Description	Range	Default
6-31	Present Fault Record	0: No Fault occurred 1: Over-current (oc) 2: Over-voltage (ov)	0
6-32	Second Most Recent Fault Record	3: Overheat (oH) 4: Overload (oL) 5: Overload 1 (oL1)	0
6-33	Third Most Recent Fault Record	6: Overload 2 (oL2) 7: External Fault (EF) 8: CPU failure 1 (CF1)	0
6-34	Fourth Most Recent Fault Record	9: CPU failure 2 (CF2) 10: CPU failure 3 (CF3) 11: Hardware Protection Failure (HPF)	0
6-35	Fifth Most Recent Fault Record	12: Over-current during accel (OCA) 13: Over-current during decel (OCd) 14: Over-current during steady state (OCn)	0
6-36	Sixth Most Recent Fault Record	18: External Base-Block (bb) 19: Auto Adjust accel/decel failure (cFA) 20: Software protection code (codE)	0
Display			
◆ 8-00	User Defined Display Function	0: Output Frequency (Hz) 1: Motor Speed (RPM) 2: Output Freq. X 8-01 3: Output Current (A) 4: Motor Output Current (%) 5: Output Voltage (V) 6: DC Bus Voltage (V) 9: Frequency Setpoint	0
◆ 8-01	Frequency Scale Factor	0.1 to 160.0	1.0

◆ Parameter can be set during RUN Mode.

Communications			
GS1 Parameter	Description	Range	Default
9-00	Communication Address	1 to 254	1
9-01	Transmission Speed	0: 4800 baud 1: 9600 baud 2: 19200 baud	1
9-02	Communication Protocol	0: MODBUS ASCII mode, 7 data bits, no parity, 2 stop bits 1: MODBUS ASCII mode, 7 data bits, even parity, 1 stop bit 2: MODBUS ASCII mode, 7 data bits, odd parity, 1 stop bit 3: MODBUS RTU mode, 8 data bits, no parity, 2 stop bits 4: MODBUS RTU mode, 8 data bits, even parity, 1 stop bit 5: MODBUS RTU mode, 8 data bits, odd parity, 1 stop bit	0
9-03	Transmission Fault Treatment	0: Display fault and continue operating 1: Display fault and RAMP to stop 2: Display fault and COAST to stop 3: No fault displayed and continue operating	0
9-04	Time Out Detection	0: Disable 1: Enable	0
9-05	Time Out Duration	0.1 to 60.0 seconds	0.5
◆ 9-07	Parameter Lock	0: All parameters can be set and read 1: All parameters are read-only	0
9-08	Restore to Default	99: Restores all parameters to factory defaults	0
◆ 9-11	Block Transfer Parameter 1	0-00 to 8-01, 9-99	9-99
◆ 9-12	Block Transfer Parameter 2	0-00 to 8-01, 9-99	9-99
◆ 9-13	Block Transfer Parameter 3	0-00 to 8-01, 9-99	9-99
◆ 9-14	Block Transfer Parameter 4	0-00 to 8-01, 9-99	9-99
◆ 9-15	Block Transfer Parameter 5	0-00 to 8-01, 9-99	9-99
◆ 9-16	Block Transfer Parameter 6	0-00 to 8-01, 9-99	9-99
◆ 9-17	Block Transfer Parameter 7	0-00 to 8-01, 9-99	9-99
◆ 9-18	Block Transfer Parameter 8	0-00 to 8-01, 9-99	9-99
◆ 9-19	Block Transfer Parameter 9	0-00 to 8-01, 9-99	9-99
◆ 9-20	Block Transfer Parameter 10	0-00 to 8-01, 9-99	9-99

◆ Parameter can be set during RUN Mode.

Communications (cont.)			
GS1 Parameter	Description	Range	Default
◆ 9-26	RS485 Speed Reference	0.0 to 400.0 Hz	60.0
◆ 9-27	RUN Command	0: Stop 1:Run	0
◆ 9-28	Direction Command	0: Forward 1:Reverse	0
◆ 9-29	External Fault	0: No fault 1:External fault	0
◆ 9-30	Fault Reset	0: No action 1:Fault Reset	0
◆ 9-31	JOG Command	0: Stop 1:jog	0
9-41	GS Series Number	1: GS1 2: GS2 3: GS3 4: GS4	##
9-42	Manufacturer Model Information	0: GS1-10P2 (120V, 1ph, 0.25HP) 1: GS1-10P5 (120V, 1ph, 0.5HP) 2: GS1-20P2 (230V, 1ph/3ph, 0.25HP) 3: GS1-20P5 (230V, 1ph/3ph, 0.5HP) 4: GS1-21P0 (230V, 1ph/3ph, 1HP) 5: GS1-22P0 (230V, 3ph, 2HP)	##

◆ Parameter can be set during RUN Mode.

Detailed Parameter Listings

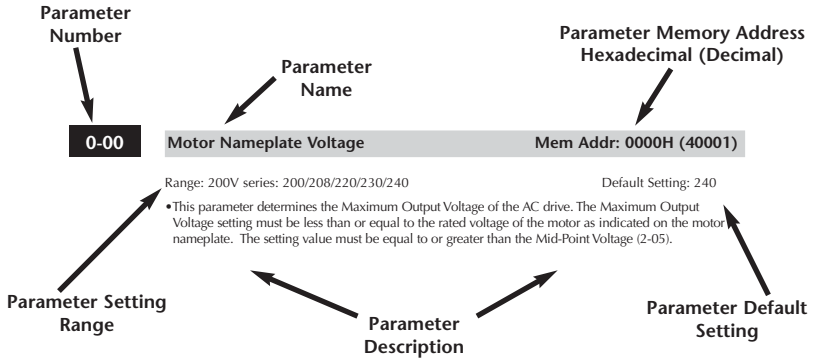

Note: If the \blacklozenge symbol is found next to the parameter name, the parameter can be edited when the AC drive is in RUN Mode.

Motor Parameters

0-00**Motor Nameplate Voltage****Mem Addr: 0000H(40001)**

Range: 200V series: 200/208/220/230/240

Default Setting: 240

- This parameter determines the Maximum Output Voltage of the AC drive. The Maximum Output Voltage setting must be less than or equal to the rated voltage of the motor as indicated on the motor nameplate. The setting value must be equal to or greater than the Mid-Point Voltage (2-05).

0-01**Motor Nameplate Amps****Mem Addr: 0001H(40002)**Range: Drive Rated Amps x 0.3 to
Drive Rated Amps x 1.0

Default Setting: Drive Rating (A)

- This parameter sets the output current to the motor. The value is determined by the value found on the motor nameplate.

0-02

Motor Base Frequency

Mem Addr: 0002H(40003)

Range: 50/60/400

Default Setting 60

- This value should be set according to rated frequency of the motor as indicated on the motor nameplate. Maximum Voltage Frequency determines the volts per hertz ratio.

0-03

Motor Base RPM

Mem Addr: 0003H(40004)

Range: 375 to 9999 RPM

Default Setting: 1750

- This value should be set according to rated Base RPM of the motor as indicated on the motor nameplate.

0-04

Motor Maximum RPM

Mem Addr: 0004H(40005)

Range: 0-03 to 9999 RPM

Default Setting: 0-03

- This value should be set according to the desired maximum speed of the motor. This value should not exceed the motor's maximum rated speed.

Ramp Parameters

1-00

Stop Methods

Mem Addr: 0100H(40257)

Range: 0 Ramp to Stop

Default Setting: 0

1 Coast to stop

- This parameter determines how the motor is stopped when the AC drive receives a valid stop command.
- Ramp: The AC drive decelerates the motor to Minimum Output Frequency (2-06) according to the deceleration time set in 1-02 or 1-06.
- Coast: The AC drive stops output instantly upon command, and the motor free runs until it comes to a complete stop.



Note: The drive application or system requirements will determine which stop method is needed.

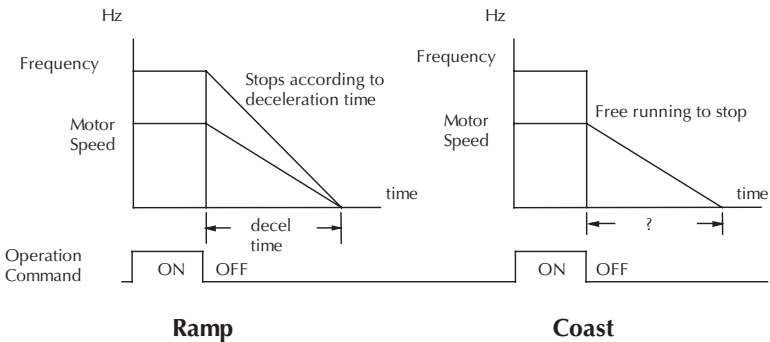

1-01

◆ Acceleration Time 1

Mem Addr: 0101H(40258)

Range: 0.1 to 600.0 sec

Default Setting: 10 sec

- This parameter is used to determine the rate of acceleration for the AC drive to reach Maximum Motor RPM (0-04). The rate is linear unless S-Curve is "Enabled."

1-02

◆ Deceleration Time 1

Mem Addr: 0102H(40259)

Range: 0.1 to 600.0 sec

Default Setting: 30.0 sec

• This parameter is used to determine the time required for the AC drive to decelerate from the Maximum Motor RPM (0-04) down to 0Hz. The rate is linear unless S-Curve is "Enabled."

1-03

◆ Accel S-Curve

Mem Addr: 0103H(40260)

Range: 0 to 7

Default Setting: 0

• This parameter is used whenever the motor and load need to be accelerated more smoothly. The Accel S-Curve may be set from 0 to 7 to select the desired acceleration S Curve.

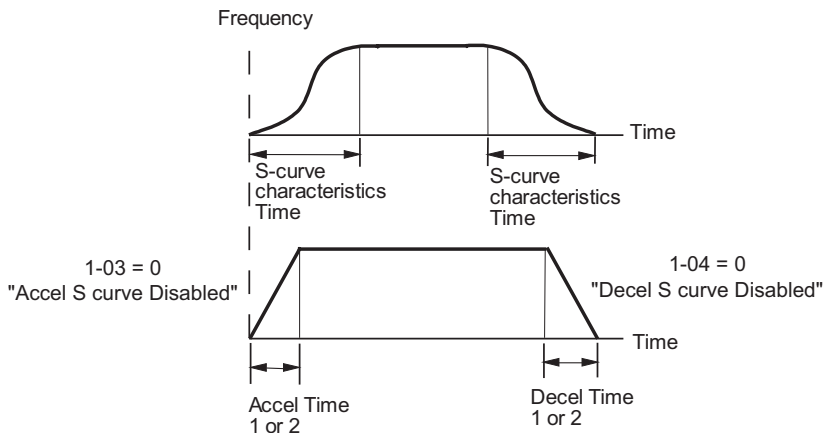

1-04

Decel S-Curve

Mem Addr 0104H(40261)

Range: 0 to 07

Default Setting: 0

This parameter is used whenever the motor and load need to be decelerated more smoothly. The Decel S-Curve may be set from 0 to 7 to select the desired deceleration S-Curve.

Note: From the diagram shown below, the original setting accel/decel time will be for reference when the function of the S-curve is enabled. The actual accel/decel time will be determined based on the S-curve selected (1 to 7).

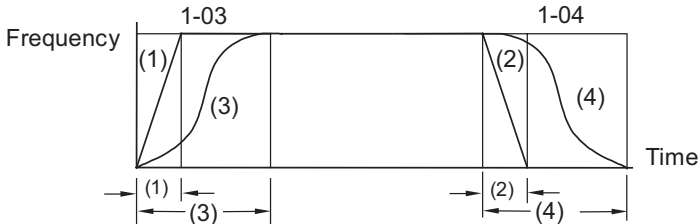

Disabling S curve is disabled in (1), (2)

1-03 sets S curve for (3)

1-04 sets S curve for (4)

1-05

◆ Acceleration Time 2

Mem Addr 0105H(40262)

Range: 0.1 to 600.0 sec

Default Setting: 10.0

- The Second Acceleration Time determines the time for the AC drive to accelerate from 0 RPM to Maximum Motor RPM (0-04). Acceleration Time 2 (1-05) can be selected using a multi-function input terminal or frequency transition (1-07).

1-06

◆ Deceleration Time 2

Mem Addr 0106H(40263)

Range: 0.1 to 600.0 sec

Default Setting: 30 sec

- The Second Deceleration Time determines the time for the AC drive to decelerate from Maximum Motor RPM (0-04) to 0 RPM. Deceleration Time 2 (1-06) can be selected using a multi-function input terminal or frequency transition (1-07).

1-07

Select method for 2nd Accel/Decel

Mem Addr 0107H(40264)

Range: 0: Second Accel/Decel from terminal

Default Setting: 0

1: Frequency Transition
1-08 & 1-09

- The second set of acceleration and deceleration times 1-05 and 1-06 can be selected either with a multi-function input terminal programmed to Second Accel/Decel or by the values of the transition frequencies 1-08 and 1-09

Second Accel/Decel Times selected with Multi-Function Input Terminal

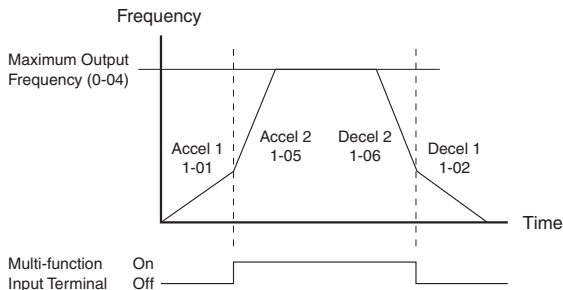

1-08

Accel 1 to Accel 2 Frequency Transition

Mem Addr 0108H(40265)

Range: 0.0 to 400.0 Hz

Default Setting: 0.0

Second Accel/Decel Times selected with Frequency Transition

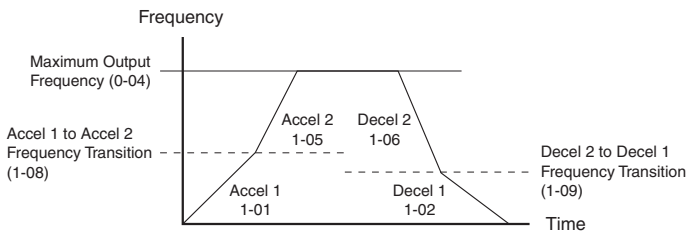

1-09

Decel 1 to Decel 2 Frequency Transition

Mem Addr 0109H(40266)

Range: 0.0 to 400.0 Hz

Default Setting: 0.0

1-10 Skip Frequency 1 Mem Addr 010AH(40267)

Range: 0.0 to 400.0Hz

Default Setting: 0.0

1-11 Skip Frequency 2 Mem Addr 010BH(40268)

Range: 0.0 to 400.0Hz

Default Setting: 0.0

1-12 Skip Frequency 3 Mem Addr 010CH(40269)

Range: 0.0 to 400.0 Hz

Default Setting: 0.0

- 1-10, 1-11, and 1-12 determine the location of the frequency bands that will be skipped during AC drive operation.

1-17 Skip Frequency Band Mem Addr 0111H(40274)

Range: 0.0 to 20.0 Hz

Default Setting: 0.0

- This parameter determines the frequency band for a given Skip Frequency (1-10, 1-11, or 1-12). Half of the Skip Frequency Band is above the Skip Frequency and the other half is below. Programming this parameter to 0.0 disables all skip frequencies.

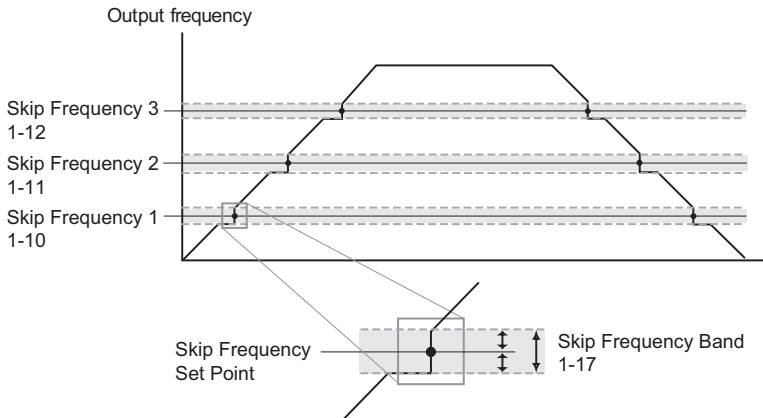

1-19 DC Injection Voltage Level Mem Addr 0113H(40276)

Range: 0 to 30% Default Setting: 0

- This parameter determines the amount of DC Braking Voltage applied to the motor during start-up and stopping. When setting DC Braking Voltage, please note that the setting is a percentage of the rated voltage of the drive. It is recommended to start with a low DC Braking Voltage Level and then increase until proper holding torque has been attained.

1-20 DC Injection during Start-up Mem Addr 0114H(40277)

Range: 0.0 to 5.0 sec Default Setting: 0.0

- This parameter determines the duration of time that the DC Braking Voltage will be applied to the motor during the AC drive start-up. DC Braking will be applied for the time set in this parameter until the Minimum Frequency is reached during acceleration.

1-21 DC Injection during Stopping Mem Addr 0115H(40278)

Range: 0.0 to 25.0 sec Default Setting: 0.0

- This parameter determines the duration of time that the DC braking voltage will be applied to the motor during stopping. If stopping with DC Braking is desired, then 1-00 must be set to Ramp to Stop (00).

1-22 Start-point for DC Injection Mem Addr 0116H(40279)

Range: 0.0 to 60.0 Hz Default Setting: 0.0

- This parameter determines the frequency when DC Braking will begin during deceleration.

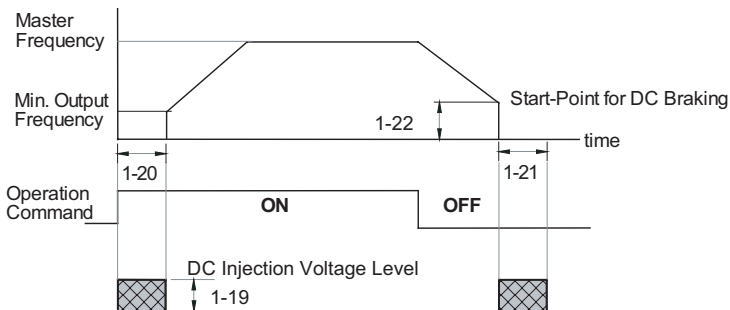

Volts/Hertz Parameters

2-00

Volts/Hertz Settings

Mem Addr 0200H(40513)

Range: 0 - General Purpose
 1 - High Starting Torque
 2 - Fans and Pumps
 3 - Custom

Default Setting: 0

0: General Purpose

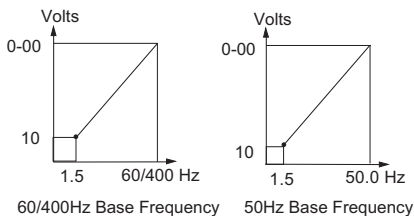

3: Custom

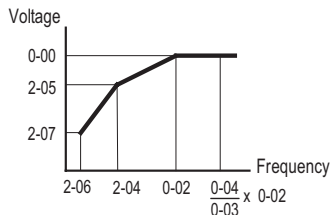

1: High Starting Torque

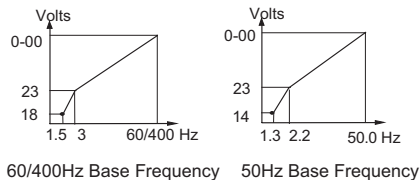

2: Fans and Pumps

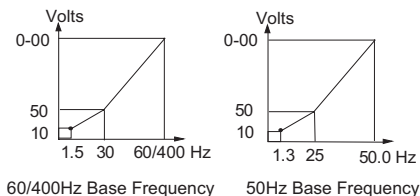

2-01**◆ Slip Compensation****Mem Addr 0201H(40514)**

Range: 0.0 to 10.0

Default Setting: 0.0

- When controlling an asynchronous induction motor, load on the AC drive will increase causing an increase in slip. This parameter may be used to compensate the nominal slip within a range of 0 to 10. When the output current of the AC drive is greater than the motor no-load current (0-01), the AC drive will adjust its output frequency according to this parameter.

2-03**◆ Manual Torque Boost****Mem Addr 0203H(40516)**

Range: 0 to 10%

Default Setting: 1



Note: 2-04 through 2-07 are only used when the Volts/Hertz parameter (2-00) is set to 3.

2-04**Mid-point Frequency****Mem Addr 0204H(40517)**

Range: 1.0 to 400 Hz

Default Setting: 1.5

- This parameter sets the Mid-Point Frequency of V/F curve. With this setting, the V/F ratio between Minimum Frequency and Mid-Point frequency can be determined.

This parameter must be greater than or equal to the Minimum Output Frequency (2-06) and less than or equal to the Maximum Voltage Frequency (0-02).

2-05**Mid-point Voltage****Mem Addr 0205H(40518)**

Range: 2.0 to 255.0V

Default Setting: 10.0

- This parameter sets the Mid-Point Voltage of any V/F curve. With this setting, the V/F ratio between Minimum Frequency and Mid-Point Frequency can be determined. **This parameter must be greater than or equal to the Minimum Output Voltage (2-07) and less than or equal to the Maximum Output Voltage (0-00).**

2-06**Minimum Output Frequency****Mem Addr 0206H(40519)**

Range: 1.0 to 20.0 Hz

Default Setting: 1.5

- This parameter sets the Minimum Output Frequency of the AC drive. **This parameter must be less than or equal to the Mid-Point Frequency (2-04).**

2-07**Minimum Output Voltage****Mem Addr 0207H(40520)**

Range: 2.0 to 50.0V

Default Setting: 10.0

- This parameter sets the Minimum Output Voltage of the AC drive.
This parameter must be equal to or less than Mid-Point Voltage (2-05).

2-08**PWM Carrier Frequency****Mem Addr 0208H(40521)**

Range: 3 to 10 KHz

Default Setting: 10

- This parameter sets the carrier frequency of PWM (Pulse-Width Modulated) output.
- In the table below, we see that the carrier frequency of PWM output has a significant influence on the electromagnetic noise, leakage current, heat dissipation of the AC drive and the acoustic noise to the motor

Carrier Frequency	Acoustic Noise	Electromagnetic Noise, Leakage Current	Heat Dissipation
3kHz	significant	minimal	minimal
10kHz	minimal	moderate	moderate

Digital Parameters

3-00**Source of Operation Command****Mem Addr 0300H(40769)**

Default Setting: 0

Settings	0	Operation Determined by Digital Keypad
	1	Operation determined by external control terminals. Keypad STOP is enabled.
	2	Operation determined by external control terminals. Keypad STOP is disabled.
	3	Operation determined by RS485 interface. Keypad STOP is enabled.
	4	Operation determined by RS485 interface. Keypad STOP is disabled.

- This parameter sets the input source for the AC drive operation commands.
- Refer to 3-01 and 3-03 for more details.

3-01**Multi-function Input Terminals (DI1-DI2) Mem Addr 0301H(40770)**

Default Setting: 0

Settings	0	DI1 - FWD/STOP DI2 - REV/STOP
	1	DI1 - RUN/STOP DI2 - REV/FWD
	2	DI1 - RUN (N.O. latching input) DI2 - REV/FWD DI3 - STOP (N.C. latching input)

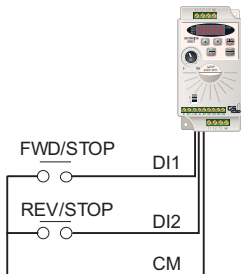

Note: Multi-function Input Terminals DI1 and DI2 do not have separate parameter designations. DI1 and DI2 must be used in conjunction with one another to operate two and three wire control.

3-01: Setting 0

DI1	DI2	Result
OFF	OFF	STOP
ON	OFF	FWD
OFF	ON	REV
ON	ON	STOP

3-01: Setting 1

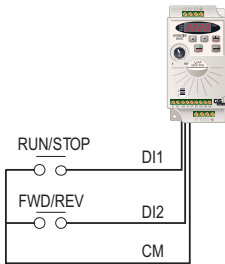

D11- RUN/STOP select
 "Open" : Stop
 "Close" : Run
 D12- FWD/REV select
 "Open" : FWD
 "Close" : REV

3-01: Setting 2

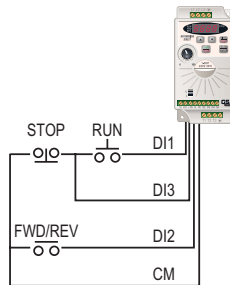

D11- RUN command
 Latching input (N.O.)
 Runs when closed
 D12- FWD/REV select
 "Open" : FWD
 "Close" : REV
 D13- STOP command
 Latching input (N.C.)
 Stops when open

3-02

Multi-Function Input (DI3)

Mem Addr 0302H(40771)

Default Setting: 0

3-03

Multi-Function Input (DI4)

Mem Addr 0303H(40772)

Settings for 3-02 and 3-03

Default Setting: 3

Settings	0	External Fault (N.O.)	
	1	External Fault (N.C.)	
	2	External Reset	
	3	Multi-Speed Bit 1	
	4	Multi-Speed Bit 2	
	9	Jog	
	10	External Base Block (N.O.)	
	11	External Base Block (N.C.)	
	12	Second Accel/Decel Time	
	13	Speed Hold	
	14	Increase Speed	} 4-00 must be set to 1.
	15	Decrease Speed	
	16	Reset Speed to Zero	
	99	Input Disable	

Setting Explanations for parameters 3-02 and 3-03

Setting 0: External Fault (N.O.)

When an External Fault input signal is received, the AC drive output will turn off, the drive will display "EF" on the LED Display, and the motor will Coast to Stop. To resume normal operation, the external fault must be cleared, and the drive must be reset.

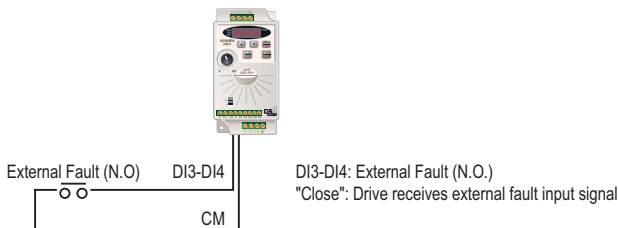

Setting 1: External Fault (N.C.)

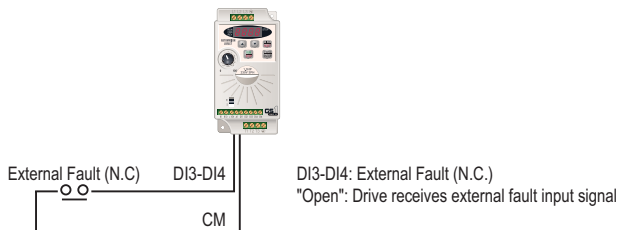

Setting 2: External Reset

An External Reset has the same function as the Reset key on the digital keypad. Use an External Reset to reset the drive after a fault.

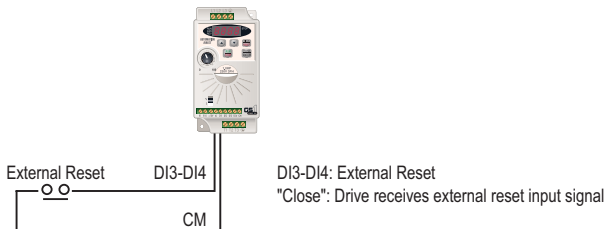

Settings 3 and 4: Multi-Speed Bits 1 and 2

The three Multi-Speed Bits are used to select the multi-speed settings defined by parameters 5-01 to 5-03.

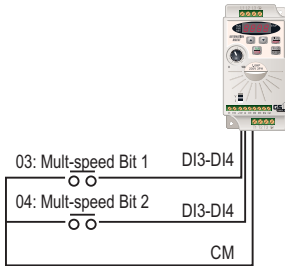

Multi-Speed Bits		Speed Selection
Bit 2	Bit 1	
OFF	OFF	4-00: Source of Frequency
OFF	ON	5-01: Multi-Speed 1
ON	OFF	5-02: Multi-Speed 2
ON	ON	5-03: Multi-Speed 3



Note: In order to use the Multi-Speed settings, parameters 5-01 to 5-03 must be set.



Note: When all multi-speed inputs are off, the AC drive reverts back to the Command Frequency (4-00).

Setting 9: Jog Command

This setting configures a Multi-function Input Terminal to give the Jog Command when activated. 5-00 sets the Jog Speed.

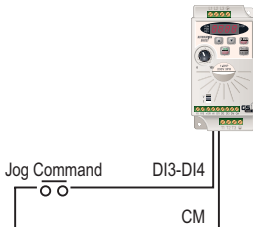

DI3-DI4: Jog Command
 "Close": Drive receives Jog Command signal



Note: The Jog Command cannot be used when the motor is running. The motor must be stopped to initiate this command.

Setting 10 and 11: External Base Block (N.O.) and External Base Block (N.C.)

Value 10 is for a normally open (N.O.) input and value 11 is for a normally closed (N.C.) input.

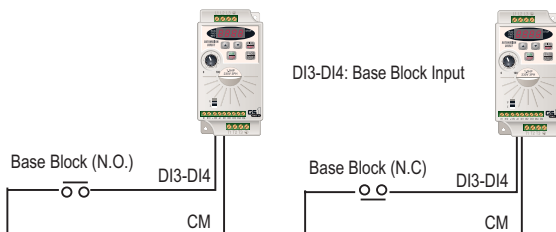

When an External Base Block is activated, the LED display shows *bb*, the AC drive stops all output, and the motor will free run. When the External Base Block is deactivated, the AC drive will start the speed search function and synchronize with the motor speed. The AC drive will then accelerate to the Master Frequency.

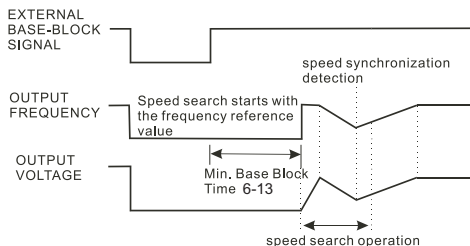

Setting 12: Second Accel/Decel Time

Multi-function Input Terminals DI3 and DI4 can be set to select between Accel/Decel times 1 and 2. Parameters 1-01 and 1-02 set Accel 1 and Decel 1 times. Parameters 1-05 and 1-06 set Accel 2 and Decel 2 times.

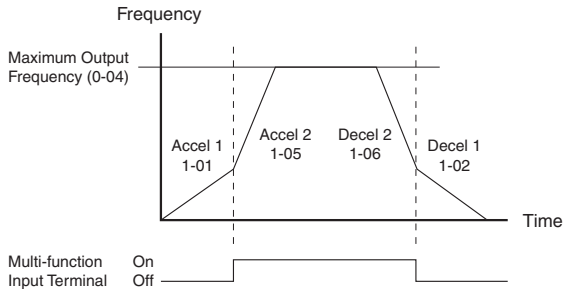
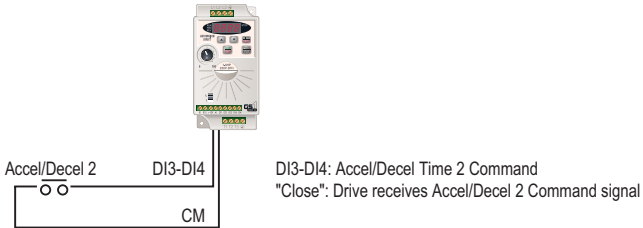

Setting 13: Speed Hold

When the Speed Hold command is received, the drive acceleration or deceleration is stopped and the drive maintains a constant speed.

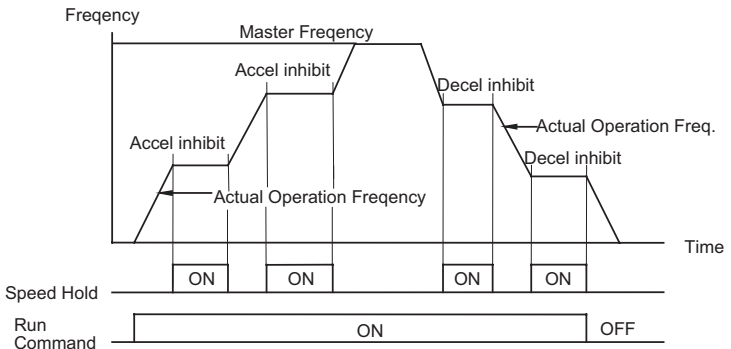

Settings 14 and 15: Increase and Decrease Speed (Electronic Motor Operated Potentiometer)

Settings 14 and 15 allow the Multi-function terminals to be used to increase or decrease speed incrementally. Each time an increase/decrease speed input is received the Master Frequency will increase/decrease by one unit.

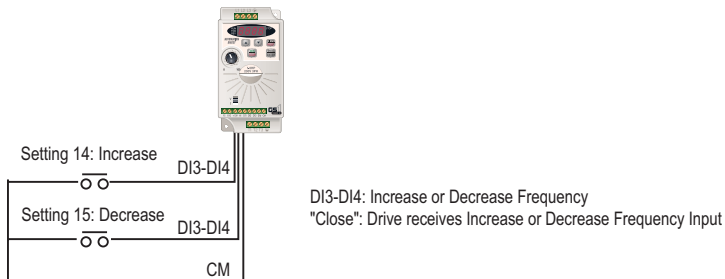

Note: In order to use these settings, 4-00 must be set to 1.

Setting 16: Reset Speed to Zero

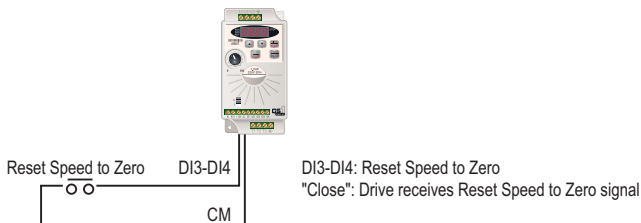

Setting 99: Multi-Function Input Disable

Setting a Multi-Function Input to 99 will disable that input. The purpose of this function is to provide isolation for unused Multi-Function Input Terminals. Any unused terminals should be programmed to 99 to make sure they have no effect on drive operation.



Note: Any unused terminals should be programmed to 99 to make sure they have no effect on drive operation.

Default Setting: 0

Settings:	0	AC Drive Running
	1	AC Drive Fault
	2	At Speed
	3	Zero Speed
	4	Above Desired Frequency (3-16)
	5	Below Desired Frequency (3-16)
	6	At Maximum Speed (0-02)
	7	Over Torque Detected
	8	Above Desired Current (3-17)
	9	Below Desired Current (3-17)

Function Explanations:

Setting 0: AC Drive Running—The terminal will be activated when there is an output from the drive.

Setting 1: AC Drive Fault—The terminal will be activated when a fault occurs.

Setting 2: At Speed—The terminal will be activated when the AC drive attains the Command Frequency (4-00).

Setting 3: Zero Speed—The output will be activated when Command Frequency (4-00) is lower than the Minimum Output Frequency (2-06).

Setting 4: Above Desired Frequency—The output will be activated when the AC drive is above the Desired Frequency (3-16).

Setting 5: Below Desired Frequency—The output will be activated when the AC drive is below the Desired Frequency (3-16).

Setting 6: At Maximum Speed—The output will be activated when the AC drive reaches Motor Maximum RPM (0-04).

Setting 7: Over Torque Detected—The output will be activated when the AC drive reaches the Over-torque Detection Level (6-08) and exceeds this level for a time greater than the Over-torque Detection Time (6-09).

Setting 8: Above Desired Current—The output will be activated when the AC drive is above the Desired Current (3-17).

Setting 9: Below Desired Current—The output will be activated when the AC drive is below the Desired Current (3-17).

3-16

◆ Desired Frequency

Mem Addr 0310H(40785)

Range: 0.0 to 400.0 Hz

Default Setting: 0.0

- If the Multi-function output terminal is set to function as Desired Frequency Attained (3-11 =04 or 05), then the output will be activated when the programmed frequency is attained.

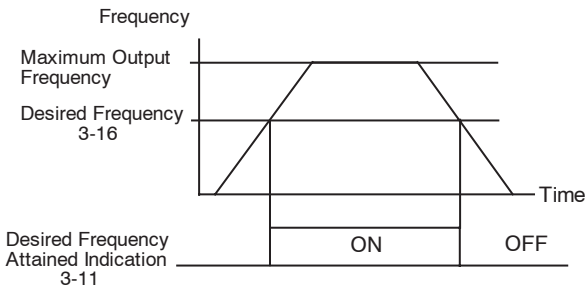

$$\text{Max. Output Frequency} = \left(\frac{\text{Motor Max. RPM (0-04)}}{\text{Motor Base RPM (0-03)}} \right) \times \text{Base Frequency (0-02)}$$

3-17

◆ Desired Current

Mem Addr 0311H(40786)

Range: 0.0 to <Drive Rated Amps>

Default Setting: 0.0

Analog Parameters

4-00

Source of Frequency Command

Mem Addr 0400H(41025)

Default: 0

- Settings:
- 0 Frequency determined by keypad potentiometer
 - 1 Frequency determined by digital keypad up/down
 - 2 Frequency determined by 0 to +10V input on AI terminal. Analog input switch must be set to "V".



Switch must be set to "V" in order to use a 0 to +10V input

- 3 Frequency determined by 4 to 20mA input on AI terminal. Analog input switch must be set to "I".



Switch must be set to "I" in order to use a 4 to 20mA input

- 4 Frequency determined by 0 to 20mA input on AI terminal. Analog input switch must be set to "I".



Switch must be set to "I" in order to use a 0 to 20mA input

- 5 Frequency determined by RS485 communication interface

4-01

Analog Input Offset Polarity

Mem Addr 0401H(41026)

Range: 0 Offset disabled

Default Setting: 0

- 1 Positive Offset
- 2 Negative Offset

- This parameter sets the potentiometer Bias Frequency to be positive or negative.
- The Analog Input Offset calculation will also define the Offset Polarity. See the note after 4-02.

P4.02

◆ Analog Input Offset

Mem Addr 0402H(41027)

Range: 0.0 to 100%

Default Setting: 0.0

This parameter can be set during the operation

- This parameter provides a frequency offset for an analog input.
- Use the equation below to determine the Analog Input Offset. For this equation, you will need to know the necessary Minimum and Maximum Frequency References needed for your application.

$$\text{Analog Offset \%} = \left(\frac{\text{Min. Frequency Reference}}{\text{Max. Frequency Reference}} \right) \times 100$$



Note: The result of the Analog Input Offset calculation will also define the Analog Input Offset Polarity (4-01). A positive answer means you should have a positive offset. A negative answer means you should have a negative offset.

4-03

◆ Analog Input Gain

Mem Addr 0403H(41028)

Range: 0.0 to 300.0%

Default Setting: 100.0

This parameter can be set during the operation

- This parameter sets the ratio of analog input vs frequency output.
- Use the equation below to calculate the Analog Input Gain. For this equation, you will need to know the minimum and maximum set-point frequencies needed for your application.

$$\text{Analog Gain \%} = \left(\frac{\text{Max. Frequency Reference} - \text{Min. Frequency Reference}}{\text{Maximum Output Frequency}} \right) \times 100$$

4-04

◆ Analog Input Reverse Motion Enable

Mem Addr 0404H(41029)

Range: 0 Forward Motion Only

Default Setting: 0

1 Reverse Motion Enable

- 4-01 to 4-04 are used when the source of frequency command is the analog signal (0 to +10VDC, 4 to 20mA, or 0 to 10mA). Refer to the following examples:

Analog Input Examples

Use the equations below when calculating the values for the Maximum Output Frequency, Analog Input Offset, Analog Input Gain, and the Mid-point Frequency.

$$\text{A) Max. Output Frequency} = \left(\frac{\text{Motor Max. RPM (0-04)}}{\text{Motor Base RPM (0-03)}} \right) \times \text{Base Frequency (0-02)}$$



Note: The Maximum Output Frequency is not a parameter setting but is needed in order to calculate the Analog Gain. The default Maximum Output Frequency for the GS1 drive is 60Hz. If parameters 0-02, 0-03, or 0-04 are changed, then the Maximum Output Frequency will change.

$$\text{B) Analog Offset \%} = \left(\frac{\text{Min. Frequency Reference}}{\text{Max. Frequency Reference}} \right) \times 100$$

$$\text{C) Analog Gain \%} = \left(\frac{\text{Max. Frequency Reference} - \text{Min. Frequency Reference}}{\text{Maximum Output Frequency}} \right) \times 100$$

$$\text{D) Mid-point Freq.} = \left(\frac{\text{Max. Freq. Reference} - \text{Min. Freq. Reference}}{2} \right) + \text{Min. Freq. Reference}$$



Note: The Mid-point Frequency calculation shows the frequency reference of the drive when the potentiometer or other analog device is at its mid-point.

Example 1: Standard Operation

This example illustrates the default operation of the drive. The example is given to further illustrate the use of the analog calculations. The full range of the analog input signal corresponds to the full forward frequency range of the AC drive.

- Minimum Frequency Reference = 0Hz
- Maximum Frequency Reference = 60Hz

Calculations

A) **Max. Output Frequency** = $\left(\frac{1750 \text{ RPM}}{1750 \text{ RPM}}\right) \times 60\text{Hz} = 60\text{Hz}$

B) **Analog Offset %** = $\left(\frac{0\text{Hz}}{60\text{Hz}}\right) \times 100 = 0\%$

C) **Analog Gain %** = $\left(\frac{60\text{Hz} - 0\text{Hz}}{60\text{Hz}}\right) \times 100 = 100\%$

D) **Mid-point Frequency** = $\left(\frac{60\text{Hz} - 0\text{Hz}}{2}\right) + 0\text{Hz} = 30\text{Hz}$

Parameter Settings

- 4-01: 1 – Positive Input Offset Polarity
- 4-02: 0 – 0% Analog Input Offset
- 4-03: 100 – 100% Analog Input Gain
- 4-04: 0 – Forward Motion Only

Results

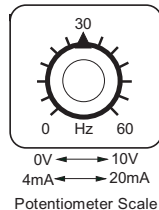
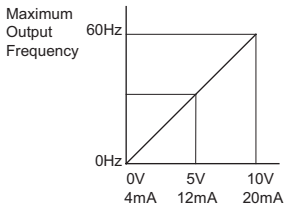

Example 2: Positive Offset

In this example, the Analog Input will have a positive offset while still using the full scale of the potentiometer. When the potentiometer is at its lowest value (0V, 0mA, or 4mA), the set-point frequency will be at 10Hz. When the potentiometer is at its maximum value (10V or 20mA), the set-point frequency will be at 60Hz.

- Minimum Frequency Reference = 10Hz
- Maximum Frequency Reference = 60Hz

Calculations

$$\text{A) Max. Output Frequency} = \left(\frac{1750 \text{ RPM}}{1750 \text{ RPM}} \right) \times 60\text{Hz} = 60\text{Hz}$$

$$\text{B) Analog Offset \%} = \left(\frac{10\text{Hz}}{60\text{Hz}} \right) \times 100 = 16.7\%$$

$$\text{C) Analog Gain \%} = \left(\frac{60\text{Hz} - 10\text{Hz}}{60\text{Hz}} \right) \times 100 = 83.3\%$$

$$\text{D) Mid-point Frequency} = \left(\frac{60\text{Hz} - 10\text{Hz}}{2} \right) + 10\text{Hz} = 35\text{Hz}$$

Parameter Settings

- 4-01: 1 – Positive Input Offset Polarity
 4-02: 16.7 – 16.7% Analog Input Offset
 4-03: 83.3 – 83.3% Analog Input Gain
 4-04: 0 – Forward Motion Only

Results

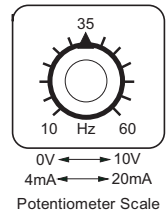
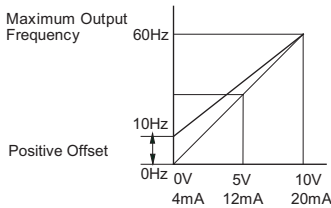

Example 3: Forward and Reverse Operation

In this example, the potentiometer is programmed to run a motor full-speed in both forward and reverse direction. The frequency reference will be 0Hz when the potentiometer is positioned at mid-point of its scale. Parameter 4-04 must be set to enable reverse motion.



Note: When calculating the values for the Analog Input using reverse motion, the reverse frequency reference should be shown using a negative (-) number. Pay special attention to signs (+/-) for values representing reverse motion.

- Minimum Frequency Reference = -60Hz (reverse)
- Maximum Frequency Reference = 60Hz

Calculations

A) **Max. Output Frequency** = $\left(\frac{1750 \text{ RPM}}{1750 \text{ RPM}}\right) \times 60\text{Hz} = 60\text{Hz}$

B) **Analog Offset %** = $\left(\frac{-60\text{Hz}}{60\text{Hz}}\right) \times 100 = -100\%$



Note: The negative (-) value for the Analog Offset % shows that a negative offset is needed for 4-01.

C) **Analog Gain %** = $\left(\frac{60\text{Hz} - (-60\text{Hz})}{60\text{Hz}}\right) \times 100 = 200\%$

D) **Mid-point Frequency** = $\left(\frac{60\text{Hz} - (-60\text{Hz})}{2}\right) + (-60\text{Hz}) = 0\text{Hz}$

Parameter Settings

- 4-01: 2 – Negative Input Offset Polarity
- 4-02: 100 – 100% Analog Input Offset
- 4-03: 200 – 200% Analog Input Gain
- 4-04: 1 – Reverse Motion Enable

Results

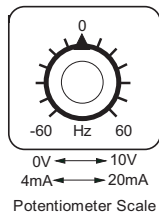
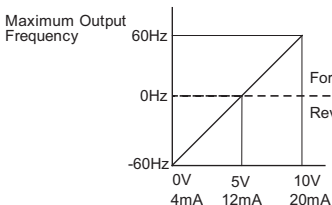

Example 4: Forward Run/Reverse Jog

This example shows an application in which the drive runs full-speed forward and jogs in reverse. The full scale of the potentiometer will be used.



Note: When calculating the values for the Analog Input using reverse motion, the reverse frequency reference should be shown using a negative (-) number. Pay special attention to signs (+/-) for values representing reverse motion.

- Minimum Frequency Reference = -15Hz (reverse)
- Maximum Frequency Reference = 60Hz

Calculations

$$A) \text{ Max. Output Frequency} = \left(\frac{1750 \text{ RPM}}{1750 \text{ RPM}} \right) \times 60\text{Hz} = 60\text{Hz}$$

$$B) \text{ Analog Offset \%} = \left(\frac{-15\text{Hz}}{60\text{Hz}} \right) \times 100 = -25\%$$



Note: The negative (-) value for the Analog Offset % shows that a negative offset is needed for 4-01.

$$C) \text{ Analog Gain \%} = \left(\frac{60\text{Hz} - (-15\text{Hz})}{60\text{Hz}} \right) \times 100 = 125\%$$

$$D) \text{ Mid-point Frequency} = \left(\frac{60\text{Hz} - (-15\text{Hz})}{2} \right) + (-15\text{Hz}) = 22.5\text{Hz}$$

Parameter Settings

- 4-01: 2 – Negative Input Offset Polarity
- 4-02: 25 – 25% Analog Input Offset
- 4-03: 125 – 125% Analog Input Gain
- 4-04: 1 – Reverse Motion Enable

Results

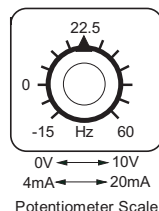
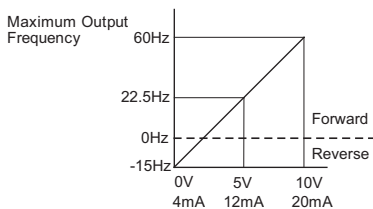

4-05**Loss of ACI Signal (4-20mA)****Mem Addr 0405H(41030)**

Range: 0 - Decelerate to 0Hz

Default Setting: 0

1 - Stop immediately and display "EF".

2 - Continue operation by the last frequency command

- This parameter determines the operation of the drive when the ACI frequency command is lost.

Preset Parameters

5-00

◆ Jog

Mem Addr 0500H(41281)

Range: 0.0 to 400.0 Hz

Default Setting: 6.0

- The Jog Command is selected by a Multi-Function Input Terminal (3-02 and 3-03) set to the Jog Function (9).

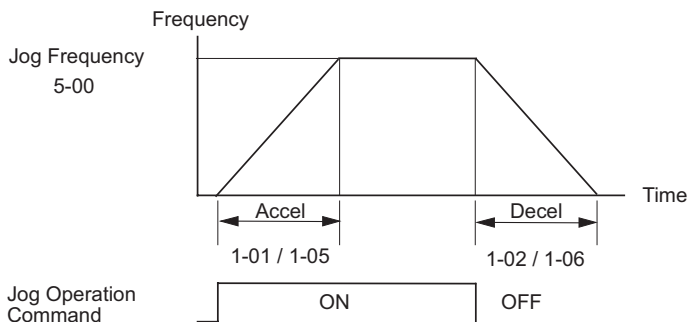

5-01

◆ Multi-Speed 1

Mem Addr 0501H(41282)

5-02

◆ Multi-Speed 2

Mem Addr 0502H(41283)

5-03

◆ Multi-Speed 3

Mem Addr 0503H(41284)

Range for 5-01 to 5-03: 0.0 to 400.0 Hz

Default Setting: 0.0

- The Multi-Function Input Terminals (refer to 3-02 and 3-03) are used to select one of the AC drive Multi-Step speeds. The speeds (frequencies) are determined by 5-01 to 5-03 shown above.

Multi-Speed Bits		Speed Selection
Bit 2	Bit 1	
OFF	OFF	4-00: Source of Frequency
OFF	ON	5-01: Multi-Speed 1
ON	OFF	5-02: Multi-Speed 2
ON	ON	5-03: Multi-Speed 3



Note: When all multi-speed inputs are off, the AC drive reverts back to the Command Frequency (4-00).

Protection Parameters

6-00 Electronic Thermal Overload Relay Mem Addr 0600H(41537)

Range: 0 - Constant Torque Default Setting: 0
 1 - Variable Torque
 2 - Inactive

- This function is used to limit the output power of the AC drive when powering a “self-cooled” motor at low speed.

6-01 Auto Restart after Fault Mem Addr 0601H(41538)

Range: 0 to 10 Default Setting: 0

- After fault occurs (allowable faults: over-current OC, over-voltage OV), the AC drive can be reset/restarted automatically up to 10 times. Setting this parameter to 0 will disable the reset/restart operation after any fault has occurred. When enabled, the AC drive will restart with speed search, which starts at the Master Frequency. To set the fault recovery time after a fault, please see (6-13) base-block time for speed search.

6-02 Momentary Power Loss Mem Addr 0602H(41539)

Default Setting: 0

Settings:	0	Stop operation after momentary power loss.
	1	Continue operation after momentary power loss, speed search from Speed Reference.
	2	Continue operation after momentary power loss, speed search from Minimum Speed.



Note: This parameter will only work if the Source of Operation (3-00) is set to something other than 0 (Operation determined by digital keypad).

6-03 Reverse Operation Inhibit Mem Addr 0603H(41540)

Default Setting: 0

Settings:	0	Enable Reverse Operation
	1	Disable Reverse Operation

This parameter determines whether the AC Motor Drive can operate in the reverse direction.

6-04

Auto Voltage Regulation

Mem Addr 0604H(41541)

Default Setting: 0

Settings:	0	AVR enabled
	1	AVR disabled
	2	AVR disabled during decel
	3	AVR disabled during Stop

- AVR function automatically regulates the AC drive output voltage to the Maximum Output Voltage (0-00). For instance, if 0-00 is set at 200 VAC and the input voltage is at 200V to 264VAC, then the Maximum Output Voltage will automatically be regulated to 200 VAC.
- Without AVR function, the Maximum Output Voltage may vary between 180V to 264VAC, due to the input voltage varying between 180V to 264 VAC.
- Selecting program value 2 enables the AVR function and also disables the AVR function during deceleration. This offers a quicker deceleration.

6-05

Over-Voltage Trip Prevention

Mem Addr 0605H(41542)

Range: 0 Enable Over-voltage Trip Prevention
1 Disable Over-voltage Trip Prevention

Default Setting: 0

- During deceleration, the AC drive DC bus voltage may exceed its Maximum Allowable Value due to motor regeneration. When this function is enabled, the AC drive will stop decelerating, and maintain a constant output frequency. The drive will resume deceleration when the voltage drops below the factory-preset value.

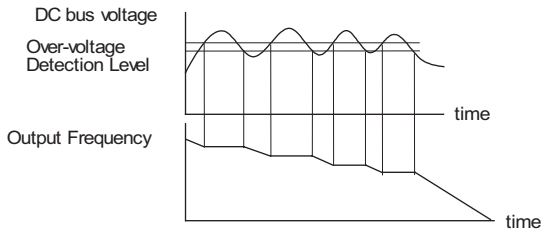

Note: With moderate inertial loads, over-voltage during deceleration will not occur. For applications with high inertia loads, the AC drive will automatically extend the deceleration time.

6-06

Auto Adjustable Accel/Decel

Mem Addr 0606H(41543)

Default Setting: 0

Settings:	0	Linear Accel/Decel
	1	Auto Accel, Linear Decel
	2	Linear Accel, Auto Decel
	3	Auto Accel/Decel
	4	Auto Accel/Decel Stall Prevention

If the auto accel/decel is selected, the AC drive will accel/decel in the fastest and smoothest means possible by automatically adjusting the time of accel/decel.

This parameter provides five modes to choose:

- 0 Linear Acceleration and deceleration (operation by 1-01, 1-02 or 1-05, 1-06 acceleration/deceleration time).
- 1 Automatic acceleration, linear deceleration (Operation by automatic acceleration time, 1-02or 1-06 deceleration time).
- 2 Linear acceleration and automatic deceleration (Operation by automatic deceleration time, 1-01 or 1-05 acceleration time).
- 3 Automatic acceleration, deceleration (Operation by AC drive auto adjustable control).
- 4 Auto acceleration, deceleration. The auto accel/decel will not be quicker than the settings for acceleration (1-01 or 1-05) or deceleration (1-02 or 1-06). The operation is specific to preventing a stall.

6-07

Over-Torque Detection Mode

Mem Addr 0607H(41544)

Default Setting: 0

Settings:	0	Disabled
	1	Enabled during constant speed operation
	2	Enabled during acceleration

6-08

Over-Torque Detection Level

Mem Addr 0608H(41545)

Range: 30 to 200%

Default Setting: 150

- A setting of 100% is proportional to the Rated Output Current of the drive.
- This parameter sets the Over-Torque Detection level in 1% increments. (The AC drive rated current is equal to 100%.)

6-09

Over-Torque Detection Time

Mem Addr 0609H(41546)

Range: 0.1 to 10.0

Default Setting: 0.1

This parameter sets the Over-Torque Detection Time in units of 0.1 seconds.

6-10 Over-current Stall Prevention during Acceleration Mem Addr 060AH(41547)

Range: 20 to 200%

Default setting: 150

A setting of 100% is equal to the Rated Output Current of the drive.

- Under certain conditions, the AC drive output current may increase abruptly, and exceed the value specified by 6-10. This is commonly caused by rapid acceleration or excessive load on the motor. When this function is enabled, the AC drive will stop accelerating and maintain a constant output frequency. The AC drive will only resume acceleration when the current drops below the maximum value.

6-11 Over-current Stall Prevention during Operation Mem Addr: 060BH(41548)

Range: 20 to 200%

Default Setting: 150

- During steady-state operation with motor load rapidly increasing, the AC drive output current may exceed the limit specified in 6-11. When this occurs, the output frequency will decrease to maintain a constant motor speed. The drive will accelerate to the steady-state output frequency only when the output current drops below the level specified by 6-11.

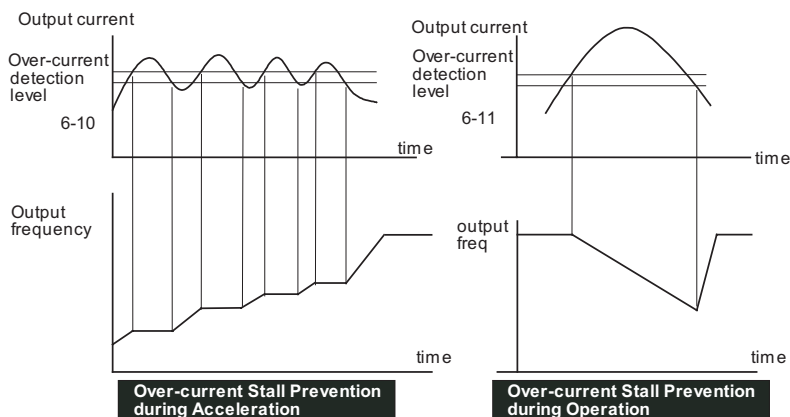

6-12 Maximum Allowable Power Loss Time Mem Addr: 060CH(41549)

Range: 0.3 to 5.0 sec

Default Setting: 2.0

- During a power loss, if the power loss time is less than the time defined by this parameter, the AC drive will resume operation. If the Maximum Allowable Power Loss Time is exceeded, the AC drive output is turned off.

6-13 Base-Block Time for Speed Search Mem Addr 060DH(41550)

Range: 0.3 to 5.0 sec

Default Setting: 0.5

- When a momentary power loss is detected, the AC drive turns off for a specified time interval determined by 6-13 before resuming operation. This time interval is called Base-Block. This parameter should be set to a value where the residual output voltage due to regeneration is nearly zero, before the drive resumes operation.
- This parameter also determines the searching time when performing external Base-Block and Fault Reset (6-01)

6-14 Maximum Speed Search Current Level Mem Addr 060EH(41551)

Range: 30 to 200%

Default Setting: 150

- Following a power failure, the AC drive will start its speed search operation only if the output current is greater than the value determined by 6-14. When the output current is less than that of 6-14, the AC drive output frequency is at a "speed synchronization point". The drive will start to accelerate or decelerate back to the operating frequency at which it was running prior to the power failure.

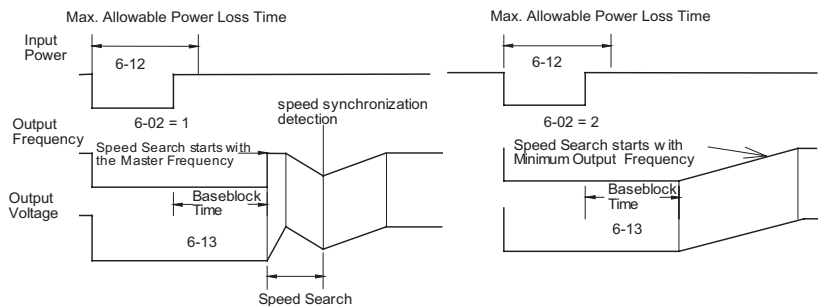

6-15**Upper Bound of Output Frequency****Mem Addr 060FH(41552)**

Range: 0.1 to 400 Hz

Default Setting: 400.0

This parameter must be equal to or greater than the Lower Bound of Output Frequency (6-16).

6-16**Lower Bound of Output Frequency****Mem Addr 0610H(41553)**

Range: 0.0 to 400 Hz

Default Setting: 0.0

This parameter must be less than or equal to the Upper Bound of Output Frequency (6-15).

- The Upper/Lower Bound is to prevent operation error and machine damage.
- If the Upper Bound of Output Frequency is 50 Hz and the Maximum Output Frequency is 60 Hz, the Maximum Output Frequency will be limited to 50 Hz.
- If the Lower Bound of Output Frequency is 10 Hz, and the Minimum Output Frequency (2-06) is set at 1.0 Hz, then any Command Frequency between 1-10 Hz will generate a 10 Hz output from the drive.

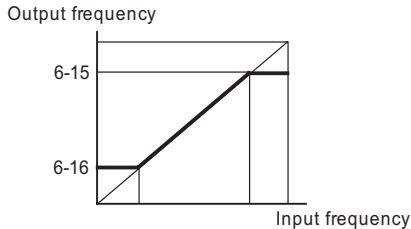

6-31	Present Fault Record	Mem Addr 061FH(41568)
6-32	Second Most Recent Fault Record	Mem Addr 0620H(41569)
6-33	Third Most Recent Fault Record	Mem Addr 0621H(41570)
6-34	Fourth Most Recent Fault Record	Mem Addr 0622H(41571)
6-35	Fifth Most Recent Fault Record	Mem Addr 0623H(41572)
6-36	Sixth Most Recent Fault Record	Mem Addr 0624H(41573)

Default Setting: 0

Settings for 6-31 - 6-36:

0	No Fault occurred
1	Over-current (oc)
2	Over-voltage (ov)
3	Overheat (oH)
4	Overload (oL)
5	Overload 1 (oL1)
6	Overload 2 (oL2)
7	External Fault (EF)
8	CPU failure 1 (CF1)
9	CPU failure 2 (CF2)
10	CPU failure 3 (CF3)
11	Hardware Protection Failure (HPF)
12	Over-current during accel (OCA)
13	Over-current during decel (OCd)
14	Over-current during steady state (OCn)
18	External Base Block (bb)
19	Auto Adjust Accel/decel failure (cFA)
20	Software protection code (co)

Display Parameters

8-00

◆ User Defined Display Function

Mem Addr 0800H(42049)

Default Setting: 0

Settings:	0	Output Frequency (Hz)
	1	Motor Speed (RPM)
	2	Output Frequency x 8-01
	3	Output Current (A)
	4	Motor Output Current (%)
	5	Output Voltage(V)
	6	DC Bus Voltage (V)
	9	Frequency Setpoint

8-01

◆ Frequency Scale Factor

Mem Addr 0801H(42050)

Range: 0.1 to 160.0

Default Setting: 1.0

- The coefficient K determines the multiplying factor for the user-defined unit.
 - The display value is calculated as follows:

$$\text{Display value} = \text{output frequency} \times K$$

- The display window is only capable of showing four digits, but 8-01 can be used to create larger numbers. The display window uses decimal points to signify numbers up to three digits as explained below:

DISPLAY NUMBER REPRESENTED

9999	The absence of a decimal point indicates a four digit integer.
999.9	A single decimal point between the middle and the right-most numbers is a true decimal point; it separates ones and tenths as in "30.5 (thirty and one-half).
9999.	A single decimal point after the right-most number is not a true decimal point; instead it indicates that a zero follows the right-most numbers. For example, the number 1230 would be displayed as "123."

Communication Parameters

9-00

Communication Address

Mem Addr 0900H(42305)

Range: 1 to 254

Default Setting: 1

- If the AC drive is controlled by RS-485 serial communication, the communication address must be set via this parameter.

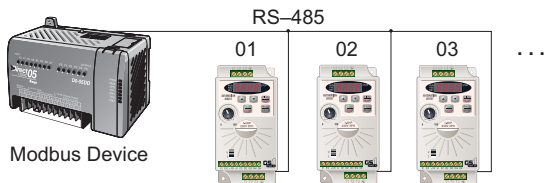

9-01

Transmission Speed

Mem Addr 0901H(42306)

Range: 0 to 2

Default Setting: 1

Setting 0: 4800 baud data transmission speed
 1: 9600 baud data transmission speed
 2: 19200 baud data transmission speed

- Users can set parameters and control the operation of the AC drive via the RS-485 serial interface of a personal computer. This parameter is used to set the transmission speed between the computer and AC drive.

9-02

Communication Protocol

Mem Addr 0902H(42307)

Default Setting: 0

Settings: 0 MODBUS ASCII mode.
 <7 data bits, no parity, 2 stop bits>
 1 MODBUS ASCII mode
 <7 data bits, even parity, 1 stop bit>
 2 MODBUS ASCII mode
 <7 data bits, odd parity, 1 stop bit>
 3 MODBUS RTU mode
 <8 data bits, no parity, 2 stop bits>
 4 MODBUS RTU mode
 <8 data bits, even parity, 1 stop bit>
 5 MODBUS RTU mode
 <8 data bits, odd parity, 1 stop bit>

9-03 Transmission Fault Treatment Mem Addr 0903H(42308)

Default Setting: 0

- Setting:
- 0 - Display fault and continue operating
 - 1 - Display fault and RAMP to stop
 - 2 - Display fault and COAST to stop
 - 3 - No fault displayed and continue operating

9-04 Time Out Detection Mem Addr 0904H(42309)

Range: 0 - Disable
1 - Enable

Default Setting: 0

- This parameter is used for ASCII mode. When this parameter is set to 01, it indicates that the over-time detection is enabled and the time slot between each character cannot exceed 500 ms.

9-05 Time Out Duration Mem Addr 0905H(42310)

Range: 0.1 to 60.0 seconds

Default Setting: 0.5

9-07 Parameter Lock Mem Addr 0907H(42312)

Range: 0 - All parameters can be set and read
1 - All parameters are read-only

Default setting: 0

9-08 Restore to Default Mem Addr 0908H(42313)

Range: 0 to 99

Default Setting: 0

- Setting 99 restores all parameters to factory defaults.

9-11 Block Transfer Parameter 1 Mem Addr 090BH(42316)

Range: 0-00 to 8-01, and 9-99

Default Setting: 9-99

- Setting 9-99 disables the parameter.

9-12 Block Transfer Parameter 2 Mem Addr 090CH(42317)

Range: 0-00 to 8-01, and 9-99

Default Setting: 9-99

- Setting 9-99 disables the parameter.

9-13 **◆ Block Transfer Parameter 3** **Mem Addr 090DH(42318)**

Range: 0-00 to 8-01, and 9-99 Default Setting: 9-99
• Setting 9-99 disables the parameter.

9-14 **◆ Block Transfer Parameter 4** **Mem Addr 090EH(42319)**

Range: 0-00 to 8-01, and 9-99 Default Setting: 9-99
• Setting 9-99 disables the parameter.

9-15 **◆ Block Transfer Parameter 5** **Mem Addr 090FH(42320)**

Range: 0-00 to 8-01, and 9-99 Default Setting: 9-99
• Setting 9-99 disables the parameter.

9-16 **◆ Block Transfer Parameter 6** **Mem Addr 0910H(42321)**

Range: 0-00 to 8-01, and 9-99 Default Setting: 9-99
• Setting 9-99 disables the parameter.

9-17 **◆ Block Transfer Parameter 7** **Mem Addr 0911H(42322)**

Range: 0-00 to 8-01, and 9-99 Default Setting: 9-99
• Setting 9-99 disables the parameter.

9-18 **◆ Block Transfer Parameter 8** **Mem Addr 0912H(42323)**

Range: 0-00 to 8-01, and 9-99 Default Setting: 9-99
• Setting 9-99 disables the parameter.

9-19 **◆ Block Transfer Parameter 9** **Mem Addr 0913H(42324)**

Range: 0-00 to 8-01, and 9-99 Default Setting: 9-99
• Setting 9-99 disables the parameter.

9-20 **◆ Block Transfer Parameter 10** **Mem Addr 0914H(42325)**

Range: 0-00 to 8-01, and 9-99 Default Setting: 9-99
• Setting 9-99 disables the parameter.

9-26**◆ RS485 Speed Reference****Mem Addr 091AH(42331)**

Range: 0.0 to 400.0 Hz

Default Setting: 60.0

- This parameter is used to set the Master Frequency when the AC drive is controlled by communication interface.

9-27**◆ RUN Command****Mem Addr 091BH(42332)**Range: 0 - Stop
1 - Run

Default Setting: 0

9-28**◆ Direction Command****Mem Addr 091CH(42333)**Range: 0 - Forward
1 - Reverse

Default Setting: 0

9-29**◆ External Fault****Mem Addr 091DH(42334)**Range: 0 - No fault
1 - External fault

Default Setting: 0

9-30**◆ Fault Reset****Mem Addr 091EH(42335)**Range: 0 - No action
1 - Fault Reset

Default Setting: 0

9-31**◆ JOG Command****Mem Addr 091FH(42336)**Range: 0 - Stop
1 - Jog

Default Setting: 0

9-41

GS Series Number

Mem Addr: 0929H(42346)

Default Setting: ##

Settings:	1	GS1
	2	GS2
	3	GS3
	4	GS4

9-42

Manufacturer Model Information

Mem Addr 092AH(42347)

Default Setting: ##

Settings:	0	GS1-10P2 (120V, 1ph, 0.25HP)
	1	GS1-10P5 (120V, 1ph, 0.5HP)
	2	GS1-20P2 (230V, 1ph/3ph, 0.25HP)
	3	GS1-20P5 (230V, 1ph/3ph, 0.5HP)
	4	GS1-21P0 (230V, 1ph/3ph, 1HP)
	5	GS1-22P0 (230V, 3ph, 2HP)

GS1 MODBUS COMMUNICATIONS



CHAPTER 5

In This Chapter...

Communication Parameters Summary	5-2
GS1 Status Addresses (Read Only)	5-4
Communicating with DirectLogic PLCs	5-6
Communicating with Third-party Devices	5-16

Communication Parameters Summary

A summary of the GS1 Communications Parameters is listed below. For a complete listing of the GS1 Parameter, refer to CHAPTER 4.

Communications			
GS1 Parameter	Description	Range	Default
9-00	Communication Address	1 to 254	1
9-01	Transmission Speed	0: 4800 baud 1: 9600 baud 2: 19200 baud	1
9-02	Communication Protocol	0: MODBUS ASCII mode, 7 data bits, no parity, 2 stop bits 1: MODBUS ASCII mode, 7 data bits, even parity, 1 stop bit 2: MODBUS ASCII mode, 7 data bits, odd parity, 1 stop bit 3: MODBUS RTU mode, 8 data bits, no parity, 2 stop bits 4: MODBUS RTU mode, 8 data bits, even parity, 1 stop bit 5: MODBUS RTU mode, 8 data bits, odd parity, 1 stop bit	0
9-03	Transmission Fault Treatment	0: Display fault and continue operating 1: Display fault and RAMP to stop 2: Display fault and COAST to stop 3: No fault displayed and continue operating	0
9-04	Time Out Detection	0: Disable 1: Enable	0
9-05	Time Out Duration	0.1 to 60.0 seconds	0.5
◆ 9-07	Parameter Lock	0: All parameters can be set and read 1: All parameters are read-only	0
9-08	Restore to Default	99: Restores all parameters to factory defaults	0
◆ 9-11	Block Transfer Parameter 1	0-00 to 8-01, 9-99	9-99
◆ 9-12	Block Transfer Parameter 2	0-00 to 8-01, 9-99	9-99
◆ 9-13	Block Transfer Parameter 3	0-00 to 8-01, 9-99	9-99
◆ 9-14	Block Transfer Parameter 4	0-00 to 8-01, 9-99	9-99
◆ 9-15	Block Transfer Parameter 5	0-00 to 8-01, 9-99	9-99
◆ 9-16	Block Transfer Parameter 6	0-00 to 8-01, 9-99	9-99
◆ 9-17	Block Transfer Parameter 7	0-00 to 8-01, 9-99	9-99
◆ 9-18	Block Transfer Parameter 8	0-00 to 8-01, 9-99	9-99
◆ 9-19	Block Transfer Parameter 9	0-00 to 8-01, 9-99	9-99
◆ 9-20	Block Transfer Parameter 10	0-00 to 8-01, 9-99	9-99

◆ Parameter can be set during RUN Mode.

Communication Parameters Summary (cont.)

Communications (cont.)				
GS1 Parameter	Description	Range		Default
◆ 9-26	RS485 Speed Reference	0.0 to 400.0 Hz		60.0
◆ 9-27	RUN Command	0: Stop	1:Run	0
◆ 9-28	Direction Command	0: Forward	1:Reverse	0
◆ 9-29	External Fault	0: No fault	1:External fault	0
◆ 9-30	Fault Reset	0: No action	1:Fault Reset	0
◆ 9-31	JOG Command	0: Stop	1:jog	0
9-41	GS Series Number	1: GS1 2: GS2 3: GS3 4: GS4		##
9-42	Manufacturer Model Information	0: GS1-10P2 (120V, 1ph, 0.25HP) 1: GS1-10P5 (120V, 1ph, 0.5HP) 2: GS1-20P2 (230V, 1ph/3ph, 0.25HP) 3: GS1-20P5 (230V, 1ph/3ph, 0.5HP) 4: GS1-21P0 (230V, 1ph/3ph, 1HP) 5: GS1-22P0 (230V, 3ph, 2HP)		##

◆ Parameter can be set during RUN Mode.

GS1 Status Addresses (Read Only)

The GS1 Series AC drive has status memory addresses that are used to monitor the AC drive. The status addresses and value definitions are listed below.

Status Monitor 1

Memory Address 2100H(48449)

Error Codes:

0: No fault occurred	11: Hardware Protection Failure (HPF)
1: Over-current(oc)	12: Over-current during accel (OCA)
2: Over-voltage(ov)	13: Over-current during decel (Ocd)
3: Overhear (oH)	14: Over-current during steady state (Ocd)
4: Overload (oL)	16: Low voltage (Lv)
5: Overload 1 (oL1)	18: External Base-Block (bb)
6: Overload 2 (oL2)	19: Auto adjust accel/decel failure (cFA)
7: External Fault (EF)	20: Software protection code (codE)
8: CPU failure 1 (CF1)	
9: CPU failure 2 (CF2)	
10: CPU failure 3 (CF3)	

Status Monitor 2

Memory Address 2101H(48450)

GS1 Memory Address
(hexadecimal)

GS1 Memory Data (binary)

2001	15	14	13	12	11	10	9	8	7	6	5	4	3	2	1	0	Bits
	0	0	0	0	0	0	0	0	0	1	0	0	0	1	0		
	32768	16384	8192	4096	2048	1024	512	256	128	64	32	16	8	4	2	1	Bit Values (decimal)

Memory Address 2001

Address Bit(s)	Bit(s) Value Binary (Decimal)	AC Drive Status
0 and 1	00 (0)	Drive operation stopped (STOP)
	01 (1)	Run to Stop transition
	10 (2)	Standby
	11 (3)	Drive operation running (RUN)
2	1 (4)	JOG active
3 and 4	00 (0)	Rotational direction forward (FWD)
	01 (8)	REV to FWD transition
	10 (16)	FWD to REV transition
	11 (24)	Rotational direction reverse (REV)
5	1 (32)	Source of frequency determined by communication interface (4-00 = 5)
6	1 (64)	Source of frequency determined by AI terminal (4-00 = 2, 3, or 4)
7	1 (128)	Source of operation determined by communication interface (3-00 = 3 or 4)
8	1 (256)	Parameters have been locked (9-07 = 1)
9 to 15	N/A	Reserved

Frequency Command F (XXX.X) Memory Address 2102H(48451)

Status location for the frequency setting of the AC drive.

Output Frequency H (XXX.X) Memory Address 2103H(48452)

Status location for the actual operating frequency present at the T1, T2, and T3 terminals

Output Current A (XXX.X) Memory Address 2104H(48453)

Status location for the output current present at the T1, T2, and T3 terminals.

DC-BUS Voltage d (XXX.X) Memory Address 2105H(48454)

Status location for the DC Bus Voltage.

Output Voltage U (XXX.X) Memory Address 2106H(48455)

Status location for the output voltage present at the T1, T2, and T3 terminals.

Motor RPM Memory Address 2107H(48456)

Status location for the present estimated speed of the motor

Scale Frequency (Low word) Memory Address 2108H(48457)

Status location for result of output frequency x 8-01 (low word).

Scale Frequency (High word) Memory Address 2109H(48458)

Status location for result of output frequency x 8-01 (high word).

% Load Memory Address 210BH(48460)

Status location for the amount of load on the AC drive. (Output Current ÷ Drive Rated Current) x 100

Firmware Version Memory Address 2110H(48465)

Communicating with *Direct*LOGIC PLCs

The following steps explain how to connect and communicate with the GS1 Series AC drives using *Direct*LOGIC PLCs.

Step 1: Choose the Appropriate CPU.

The GS1 Series AC drives will communicate with the following *Direct*LOGIC CPUs using MODBUS communications.

- DL05 • DL06 • DL250
- DL260 • DL350 • DL450

Step 2: Make the Connections

The GS1 Comm Port can accommodate an RS 485 network connection. The GS1 Comm Port pin-out can be found to the right.

An RS-485 network cable can span up to 1000 meters (4000 feet). However, most *Direct*LOGIC PLCs require an FA-ISONET (RS 232C to RS422/485 network adapter) in order to make this type of connection.

Use the following wiring diagrams to connect your *Direct*LOGIC PLC to a GS1 Series AC drive with an RS-485 interface.

RJ-11 Serial Comm Port

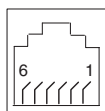

RS-485 Interface

- 1: +17V
- 2: GND
- 3: SG-
- 4: SG+



Note: If an FA-ISONET module is used in your connection, make sure the jumpers are set for RS485 communications.

DL05: RS-485 Connection Wiring

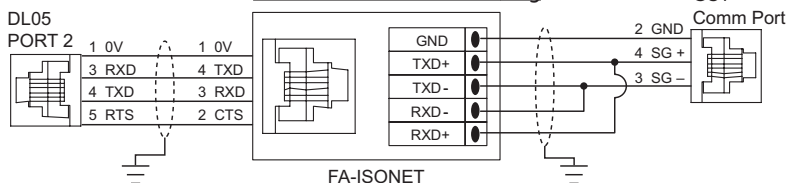

DL250: RS-485 Connection Wiring

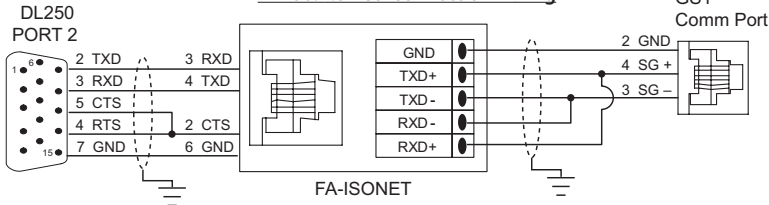

Continued on next page

DL350/DL450: RS-485 Connection Wiring

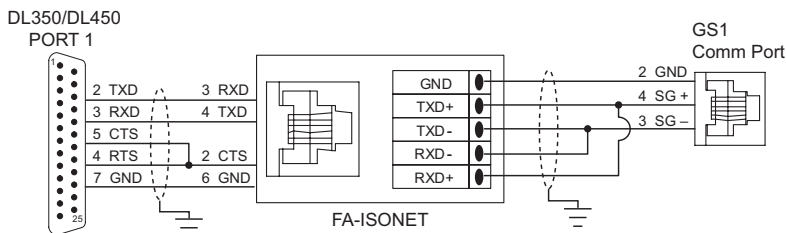

Step 3: Set AC Drive Parameters

The following parameters need to be set as shown in order to communicate properly.

- 3-00: 3 or 4 – Operation Determined by RS485 interface. Keypad STOP is enabled (3) or disabled (4).
- 4-00: 5 – Frequency determined by RS485 communication interface
- 9-00: xx – Communication address 1-254 (unique for each device, see 9.00)
- 9.01: 1 – 9600 baud data transmission speed
- 9.02: 5 – MODBUS RTU mode <8 data bits, odd parity, 1 stop bit>



*Note: The previous list of parameter settings are the minimum required to communicate with a **DirectLOGIC** PLC. There may be other parameters that need to be set to meet the needs of your application.*

Step 4: Configure the **DirectLOGIC** CPUs

The **DirectLOGIC** CPUs must be configured to communicate with the GS1 Series AC drives. This set up includes setting up the communication port and adding instructions to your logic program.

The set up for all of the **DirectLOGIC** CPUs is very similar. However, there may be some subtle differences between CPUs. Refer to the appropriate CPU User Manual for the specifics on your **DirectLOGIC** CPU.



Note: For instructions on MODBUS Configuration for your specific CPU, refer to the appropriate CPU User Manual.

DirectLOGIC MODBUS Port Configuration

The following configuration example is specific to the DL250 CPU. Refer to the appropriate CPU User Manual for the specifics on your **DirectLOGIC** CPU.

- In **DirectSOFT**, choose the PLC menu, then Setup, then “Secondary Comm Port”.
- From the **Port** list box, choose “Port 2”.
- For the protocol, select “MODBUS”.

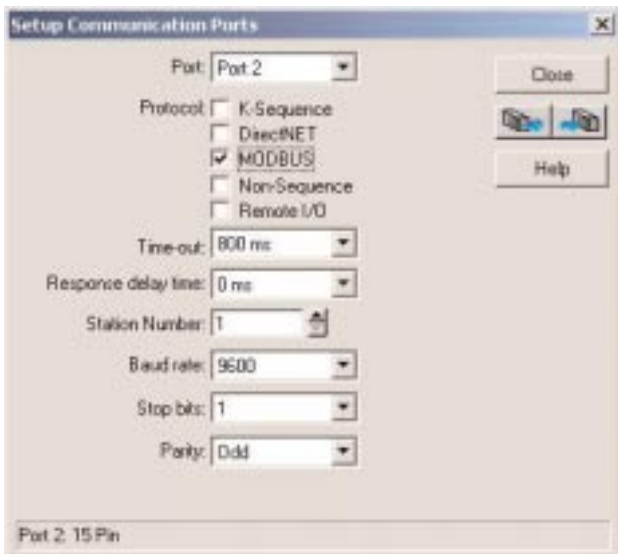

- In the **Timeout** list box, select “800 mS”.
- **Response Delay Time** should be “0 mS”.
- The **Station Number** should be set to “1” to make the DL250 CPU a MODBUS master.



Note: The DL250 network instructions used in Master mode will access only slaves 1 to 90. Each slave must have a unique number.

- The **Baud Rate** should be set at “9600”.
- In the **Stop Bits** list box, choose “1”.
- In the **Parity** list box, choose “Odd”.

DirectLOGIC MODBUS Ladder Programming

The set up for all of the **DirectLOGIC** CPUs is very similar. However, there may be some subtle differences between CPUs. Refer to the appropriate CPU User Manual for the specifics on your **DirectLOGIC** CPU.

The following ladder program shows some examples of how to control the GS1 AC drive through MODBUS RTU. The drive should be setup and tested for communications before it is connected to a load.



WARNING: A drive should never be connected to a load until any applicable communication programs have been proven.



Note: This program is for illustration purposes only and not intended for a true application.

In many drive applications, electromagnetic interference can at times cause frequent, short duration communication errors. Unless the application environment is perfect, an occasional communication error will occur. In order to distinguish between these non-fatal transients and a genuine communication failure, you may want to use the instructions as shown in Rungs 1 through 4.

Rung 1 monitors the number of times that the PLC attempts to communicate with the AC drive. When the PLC's communication attempts are successful, SP116 will count up and SP117 will not count. Once the count reaches 9999, the counter will reset and resume counting.

DirectSOFT

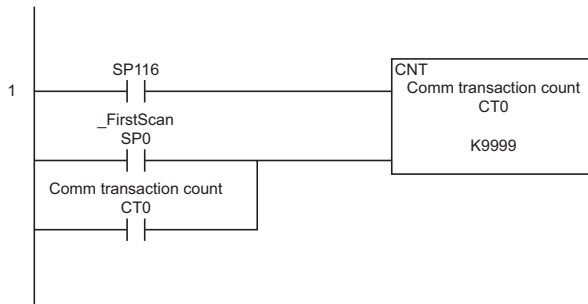

*Note: SP116 and SP117 are special relays in the **DirectLOGIC** CPUs that monitor the PLC's communications. SP116 is on when Port 2 is communicating with another device. SP117 is on when Port 2 has encountered a communication error.*

(Cont. next page)

DirectLOGIC MODBUS Ladder Programming (cont.)

Rungs 2 through 4 monitor the number of times the PLC fails in communicating with the AC drive. These instructions set the C50 bit (to be used for alarm or shut-down) based on the number of times the SP117 bit is active in one minute. In this example the C50 bit will be set if the number of errors exceed 20 in one minute.

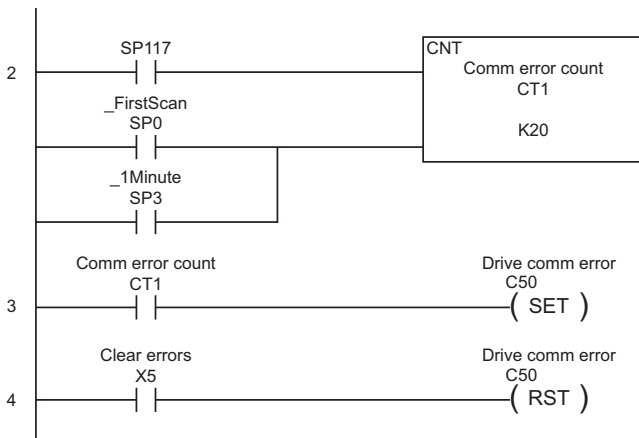

Block Transfer

There is a group of block transfer parameters available in the GS1 AC drive (9.11 to 9.20). This contiguous block of parameters can be used to "group" miscellaneous parameters throughout the drive. This will allow you to update these miscellaneous parameters in one block instead of having to use multiple WX or RX commands.

For example: If you need to change the Slip Compensation (2-01), accel time (1-01), decel time (1-02), and multi-speed 1 (5-01), this would typically take three different WX commands because the parameters are non-contiguous. If you set 9-11 to 2-01, 9-12 to 1-01, 9-13 to 1-02, and 9-14 to 5-01, then all of these parameters could be controlled using one WX command.

Rung 5 writes the values from V2000 to V2023 to the drive parameters 9-11 to 9-20. In the WX box, the value is V4413. 4413 is an octal number like all addresses in the *DirectLOGIC* PLCs. If you convert 4413 octal to hex, you get 90B. 90B is the address for parameter 9-11.



Note: Refer to your PLC User Manual for more specifics on MODBUS addressing and address conversions.

(Cont. next page)

DirectLOGIC MODBUS Ladder Programming (cont.)

If you only want to control the start/stop and speed reference of the drive, simply change the second LD command of this rung to K4 and WX command to V4432. Then V2000 would be your speed reference location and V2001 would be your start/stop location.

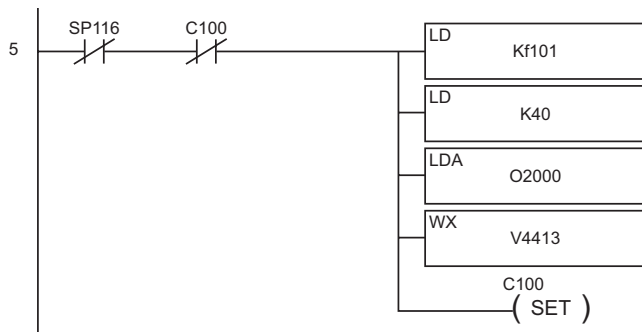

Rung 6 is used to read the status of the GS1 AC drive. These instructions read the values from the GS1 status addresses, 2100 to 2105, and places the values into the PLC memory addresses, V3000 to V3005.

Notice the number in the RX box - V20400. 20400 is an octal number as are all address references in the **DirectLOGIC** PLCs. 20400 octal converted to hex gives you 2100 - the first status address for the GS1 AC drive.



Note: Refer to your PLC User Manual for more specifics on MODBUS addressing and address conversions.

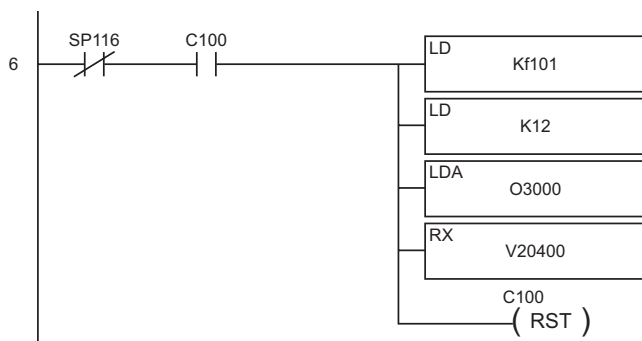

Alternate MODBUS Ladder Programming

The Read and Write commands for the DL260 and DL06 CPUs are different from other **Direct**LOGIC CPUs. Rungs 5 and 6 are shown below as they relate to DL260 and DL06 CPUs.

Rung 5 writes the values from V2000 to V2023 to the drive parameters 9.11 to 9.30. In the MWX box, the Start Slave Memory Address value is 42316. 42316 is a MODBUS decimal number. To convert 42316 decimal to hex, you first subtract 40001, and then convert the remainder to hex (90B). 90B is the address for parameter 9.11.



Note: Refer to your PLC User Manual for more specifics on MODBUS addressing and address conversions.

If you only want to control the start/stop and speed reference of the drive, simply change the number of elements to K2 and the slave memory address to 42331. Then V2000 would be your speed reference location and V2001 would be your start/stop location.

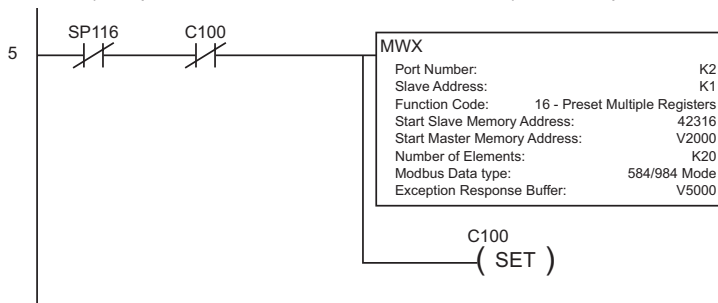

Rung 6 is used to read the status of the GS1 AC drive. These instructions read the values from the GS1 status addresses, 2100 to 2105, and places the values into the PLC memory addresses, V3000 to V3005.

The Start Slave Memory Address in the MRX box is 48449. 48449 is a MODBUS decimal number. To convert 48449 decimal to hex, you first subtract 40001, and then convert the remainder to hex (2100). 2100 is the address for the GS1 Status Monitor.

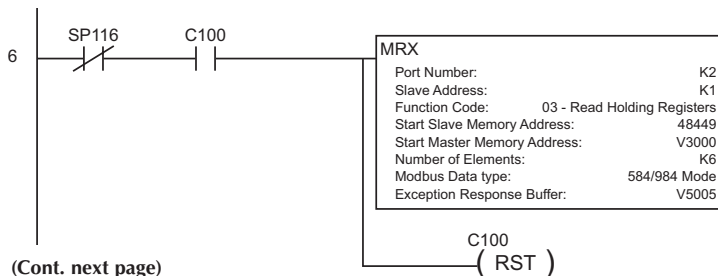

(Cont. next page)

DirectLOGIC MODBUS Ladder Programming (cont.)

Rung 7 is used to set bit C55 if the AC drive has an error. Rung 8 will reset bit C55.

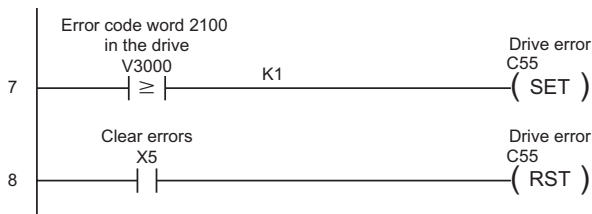

Rung 9 is used to set bit C51 if the AC drive has a specific error. In this example C51 will be set if the AC drive has an overcurrent error. Rung 10 will reset bit C51.

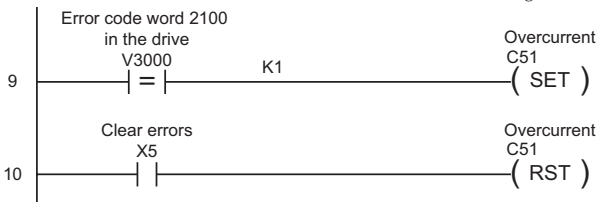

Rung 11 loads a value of 1 into drive parameter 9-27. This is the signal to run. V2020 is the 17th V-memory register in the block of 20 that is being written to in the WX instruction in Rung 5.

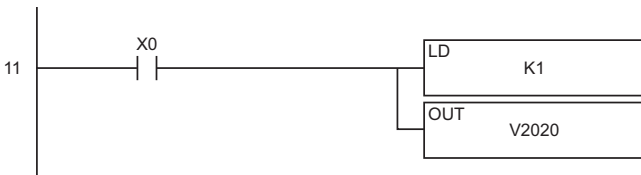

Rung 12 loads a value of 0 into drive parameter 9-27. This is the signal to stop. V2020 is the 17th V-memory register in the block of 20 that is being written to in the WX instruction in Rung 5.

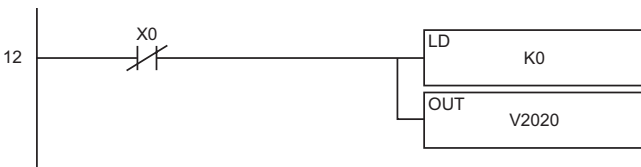

(Cont. next page)

DirectLOGIC MODBUS Ladder Programming (cont.)

Rung 13 loads a decimal value of 150 into drive parameter 9-26. The BIN instruction converts BCD/HEX to decimal. This tells the drive to run at 15.0Hz.

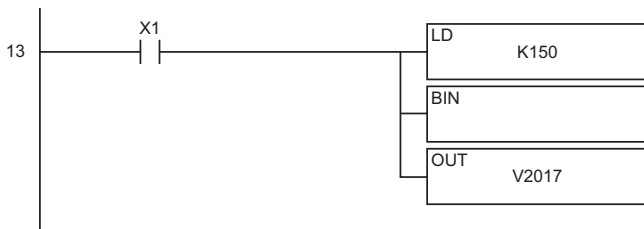

Rung 14 loads a decimal value of 300 into drive parameter 9-26. The BIN instruction converts BCD/HEX to decimal. This tells the drive to run at 30.0Hz.

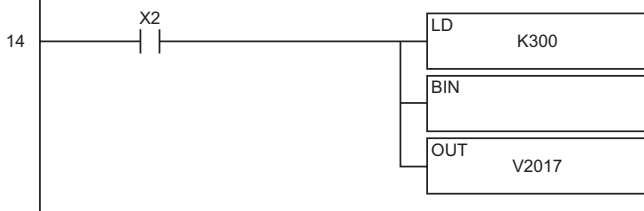

Rung 15 loads a decimal value of 450 into drive parameter 9-26. The BIN instruction converts BCD/HEX to decimal. This tells the drive to run at 45.0Hz.

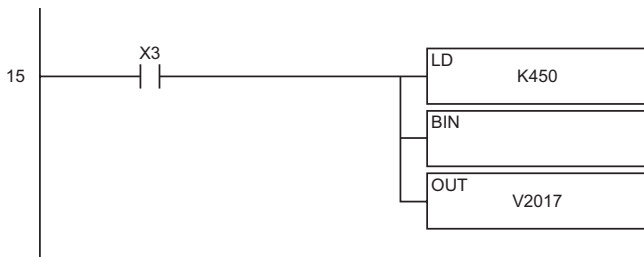

(Cont. next page)

DirectLOGIC MODBUS Ladder Programming (cont.)

Rung 16 loads a decimal value of 600 into drive parameter 9-26. The BIN instruction converts BCD/HEX to decimal. This tells the drive to run at 60.0Hz.

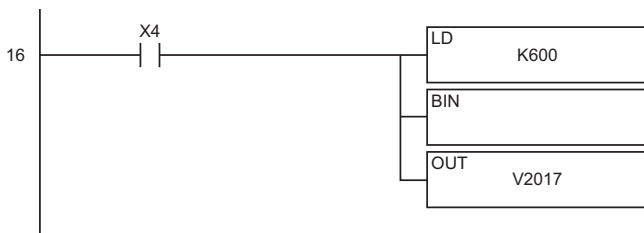

Rung 17 sets the motion of the drive to forward by loading a value of 0 into parameter 9-28. V2021 is the 18th V-memory register in the block of 20 that is being written to in the WX instruction in Rung 5.



Rung 18 sets the motion of the drive to reverse by loading a value of 1 into parameter 9-28. V2021 is the 18th V-memory register in the block of 20 that is being written to in the WX instruction in Rung 5.

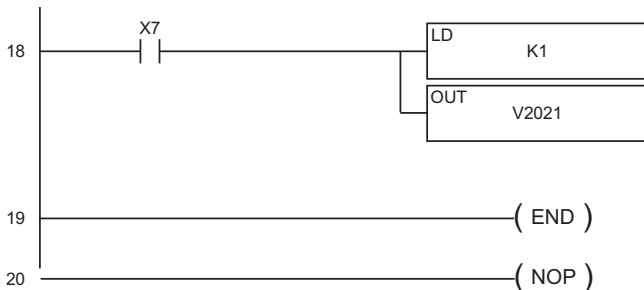

Communicating with Third-party Devices

The GS1 Comm Port can accommodate an RS485 network connection. The GS1 Comm Port pin-out can be found to the right. An RS-485 network cable can span up to 1000 meters (4000 feet).

The GS1 Series AC drive communication address is specified by 9-00. The third party device then controls each AC drive according to its communication address.

The GS1 Series AC drive can be setup to communicate on standard MODBUS networks using the following transmission modes: ASCII or RTU. Using the Communication Protocol parameter (9-02), you can select the desired mode, data bits, parity, and stop bits. The mode and serial parameters must be the same for all devices on a MODBUS network.

RJ-11 Serial Comm Port

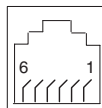

RS-485 Interface

- 1: +17V
- 2: GND
- 3: SG-
- 4: SG+

Data Format

ASCII Mode: 10-bit character frame (For 7-bit character):

9-02 = 0 (7 data bits, no parity, 2 stop bits)

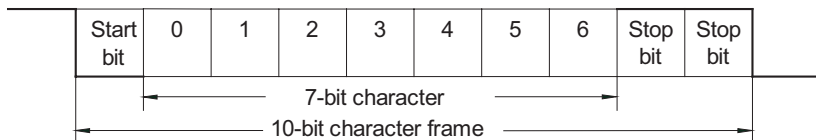

9.02 = 01 (7 data bits, even parity, 1 stop bit)

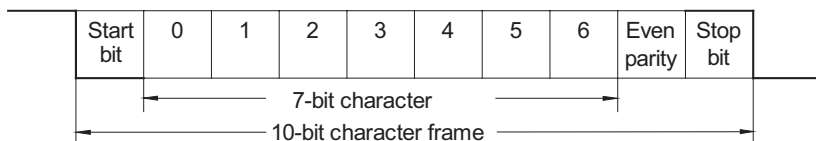

9-02 = 2 (7 data bits, odd parity, 1 stop bit)

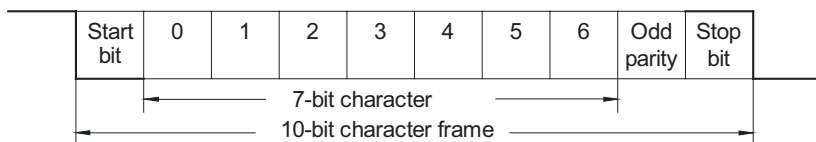

RTU Mode: 11-bit character frame (For 8-bit character):

9-02 = 3 (8 data bits, no parity, 2 stop bits)

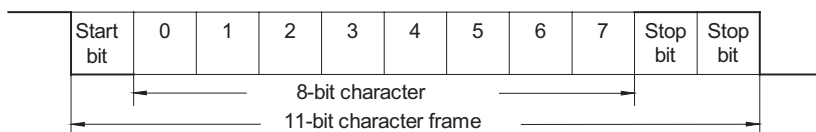

9-02 = 4 (8 data bits, even parity, 1 stop bit)

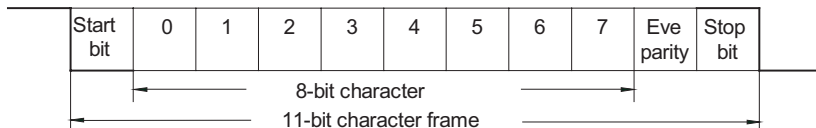

9-02 = 5 (8 data bits, odd parity, 1 stop bit)

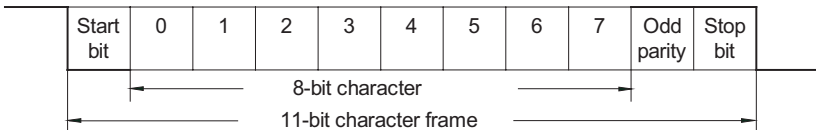

Communication Protocol

ASCII Mode:

STX	Start Character: (3AH)
ADR 1	Communication Address: 8-bit address consists of 2 ASCII codes
ADR 0	
CMD 1	
CMD 0	
DATA (n-1)	Contents of data: n x 8-bit data consists of 2n ASCII codes. n[]25 maximum of 50 ASCII codes
.....	
DATA 0	
LRC CHK 1	LRC check sum: 8-bit check sum consists of 2 ASCII codes
LRC CHK 0	
END 1	END characters: END 1=CR (0DH), END 0 =LF (0AH)
END-0	

RTU Mode:

START	A silent interval of more than 10 ms
ADR	Communication Address: 8-bit address
CMD	
DATA (n-1)	Contents of data: n x 8-bit data, n<=25
.....	
DATA 0	
CRC CHK Low	CRC check sum: 16-bit check sum consists of 2 8-bit characters
CRC CHK High	
END	A silent interval of more than 10 ms

ADR (Communication Address)

Valid communication addresses are in the range of 0 to 254. Communication address equals to 0 means broadcast to all AC drives (AMD), in this case, the AMD will not reply any message to the master device.

For example, communication to AMD with address 16 decimal:

ASCII mode: (ADR 1, ADR 0)='1','0' => '1'=31H, '0'=30H

RTU mode: (ADR)=10H

CMD (Command code) and DATA (data characters)

The format of data characters depends on the command code. The available command codes are described as followed: Command code: 03H, read N words. The maximum value of N is 20. For example, reading continuous 2 words from starting address 2102H of AMD with address 01H.

ASCII mode:

Command Message	
STX	'1'
ADR 1 ADR 0	'0'
	'1'
CMD 1 CMD 0	'0'
	'3'
Starting data address	'2'
	'1'
	'0'
	'2'
Number of data (Count by word)	'0'
	'0'
	'0'
	'2'
LRC CHK 1 LRC CHK 0	'D'
	'7'
END 1 END 0	CR
	LF

Response Message	
STX	'1'
ADR 1 ADR 0	'0'
	'1'
CMD 1 CMD 0	'0'
	'3'
Number of data (Count by byte)	'0'
	'4'
Content of starting data address 2102H	'1'
	'7'
	'7'
	'0'
Content data address 2103H	'0'
	'0'
	'0'
	'0'
LRC CHK 1 LRC CHK 0	'7'
	'1'
END 1 END 0	CR
	LF

RTU mode:

Command Message	
ADR	01H
CMD	03H
Starting data address	21H
	02H
Number of data (Count by word)	00H
	02H
CRC CHK Low CRC CHK High	6FH
	F7H

Response Message	
ADR	01H
CMD	03H
Number of data (Count by byte)	04H
	'0'
Content of data address 2102H	17H
	70H
Content of data address 2103H	00H
	02H
CRC CHK Low CRC CHK High	FEH
	5CH

Command code: 06H, write 1 word

For example, writing 6000(1770H) to address 0100H of AMD with address 01H.

ASCII mode:

Command Message	
STX	':'
ADR 1	'0'
ADR 0	'1'
CMD 1	'0'
CMD 0	'6'
Data Address	'0'
	'1'
	'0'
	'0'
	'1'
	'7'
	'0'
LRC CHK 1	'7'
LRC CHK 0	'1'
END 1	CR
END 0	LF

Response Message	
STX ':'	':'
ADR 1	'0'
ADR 0	'1'
CMD 1	'0'
CMD 0	'6'
Data Address	'0'
	'1'
	'0'
	'0'
Data Content	'1'
	'7'
	'7'
	'0'
LRC CHK 1	'7'
LRC CHK 0	'1'
END 1	CR
END 0	LF

RTU mode:

This is an example of using function code 16 for writing to multiple registers.

Command Message	
ADR	01H
CMD	10H
Starting data address	20H
	00H
Number of data (Count by byte)	04H
Content of data address 2000H	00H
	02H
Content of data address 2001H	02H
	58H
CRC CHK Low	CBH
CRC CHK High	34H

Response Message	
ADR	01H
CMD	10H
Starting data address	20H
	00H
Number of data (Count by word)	00H
	02H
CRC CHK Low	4AH
CRC CHK High	08H

CHK (check sum)

ASCII Mode:

LRC (Longitudinal Redundancy Check) is calculated by summing up, module 256, the values of the bytes from ADR1 to last data character then calculating the hexadecimal representation of the 2's-complement negation of the sum.

For example, reading 1 word from address 0401H of the AC drive with address 01H.

Command Message	
STX	'.'
ADR 1	'0'
ADR 0	'1'
CMD 1	'0'
CMD 0	'3'
Starting data address	'0'
	'4'
	'0'
	'1'
Number of data (Count by word)	'0'
	'0'
	'0'
	'1'
LRC CHK 1	'F'
LRC CHK 0	'6'
END 1	CR
END 0	LF

$01H+03H+04H+01H+00H+01H=0AH$,
the 2's complement negation of 0AH is F6H.

RTU Mode:

Response Message	
ADR	01H
CMD	03H
Starting data address	21H
	02H
Number of data (Count by word)	00H
	02H
CRC CHK Low	6FH
CRC CHK High	F7H

CRC (Cyclical Redundancy Check) is calculated by the following steps:

Step 1: Load a 16-bit register (called CRC register) with FFFFH.

Step 2: Exclusive OR the first 8-bit byte of the command message with the low order byte of the 16-bit CRC register, putting the result in the CRC register.

Step 3: Shift the CRC register one bit to the right with MSB zero filling. Extract and examine the LSB.

Step 4: If the LSB of CRC register is 0, repeat step 3, else Exclusive or the CRC register with the polynomial value A001H.

Step 5: Repeat step 3 and 4 until eight shifts have been performed. When this is done, a complete 8-bit byte will have been processed.

Step 6: Repeat steps 2 to 5 for the next 8-bit byte of the command message.

Continue doing this until all bytes have been processed. The final contents of the CRC register are the CRC value.



Note: When transmitting the CRC value in the message, the upper and lower bytes of the CRC value must be swapped, i.e. the lower order byte will be transmitted first.

The following is an example of CRC generation using C language. The function takes two arguments:

Unsigned char* data ← a pointer to the message buffer

Unsigned char length ← the quantity of bytes in the message buffer

The function returns the CRC value as a type of unsigned integer.

```
Unsigned int crc_chk(unsigned char* data, unsigned char length){
    int j;
    unsigned int reg_crc=0xFFFF;
    while(length--){
        reg_crc ^= *data++;
        for(j=0;j<8;j++){
            if((reg_crc & 0x01){ /* LSB(b0)=1 */
                reg_crc=(reg_crc>>1) ^ 0xA001;
            }else{
                reg_crc=reg_crc >>1;
            }
        }
    }
    return reg_crc;
}
```

MAINTENANCE AND TROUBLESHOOTING



CHAPTER 6

In This Chapter...

Maintenance and Inspection	6-2
Troubleshooting	6-3

Maintenance and Inspection

Modern AC drives are based on solid state electronics technology. Preventive maintenance is required to operate the AC drive in its optimal condition, and to ensure a long life. It is recommended that a qualified technician perform a regular inspection of the AC drive. Some items should be checked once a month, and some items should be checked yearly. Before the inspection, always turn off the AC Input Power to the unit. Wait at least 2 minutes after all display lamps have turned off.



WARNING! Disconnect AC power and ensure that the internal capacitors have fully discharged before inspecting the AC drive!

Monthly Inspection:

Check the following items at least once a month.

1. Make sure the motors are operating as expected.
2. Make sure the installation environment is normal.
3. Make sure the cooling system is operating as expected.
4. Check for irregular vibrations or sounds during operation.
5. Make sure the motors are not overheating during operation.
6. Check the input voltage of the AC drive and make sure the voltage is within the operating range. Check the voltage with a voltmeter.

Annual Inspection

Check the following items once annually.

1. Tighten and reinforce the screws of the AC drive if necessary. They may loosen due to vibration or changing temperatures.
2. Make sure the conductors and insulators are not corroded and damaged.
3. Check the resistance of the insulation with Megaohmmeter.
4. Check the the capacitors and relays, and replace if necessary.
5. Clean off any dust and dirt with a vacuum cleaner. Pay special attention to cleaning the ventilation ports and PCBs. Always keep these areas clean. Accumulation of dust and dirt in these areas can cause unforeseen failures.

If the AC drive is not used for a long period of time, turn the power on at least once every two years and confirm that it still functions properly. To confirm functionality, disconnect the motor and energize the AC drive for 5 hours or more before attempting to run a motor with it.





Troubleshooting

Fault Codes

The AC drive has a comprehensive fault diagnostic system that includes several different alarms and fault messages. Once a fault is detected, the corresponding protective functions will be activated. The fault codes are then displayed on the digital keypad display. The three most recent faults can be read on the digital keypad display by viewing 6-31 to 6-36.



NOTE: Faults can be cleared by a reset from the keypad or input terminal.





Fault Codes		
Fault Name	Fault Descriptions	Corrective Actions
	The AC drive detects an abnormal increase in current.	<ol style="list-style-type: none"> 1. Check whether the motor's horsepower corresponds to the AC drive output power. 2. Check the wiring connections between the AC drive and motor for possible short circuits. 3. Increase the Acceleration time (1-01 or 1-05). 4. Check for possible excessive loading conditions at the motor. 5. If there are any abnormal conditions when operating the AC drive after short-circuit is removed, the AC drive should be sent back to the manufacturer.
	The AC drive detects that the DC bus voltage has exceeded its maximum allowable value.	<ol style="list-style-type: none"> 1. Check whether the input voltage falls within the rated AC drive input voltage. 2. Check for possible voltage transients. 3. Bus over-voltage may also be caused by motor regeneration. Either increase the decel time or add an optional braking resistor. 4. Check whether the required braking power is within the specified limits.
	The AC drive temperature sensor detects excessive heat.	<ol style="list-style-type: none"> 1. Ensure that the ambient temperature falls within the specified temperature range. 2. Make sure that the ventilation holes are not obstructed. 3. Remove any foreign objects on the heatsinks and check for possible dirty heat sink fins. 4. Provide enough spacing for adequate ventilation.
	The AC drive detects that the DC bus voltage has fallen below its minimum value.	Check whether the input voltage falls within the AC drive's rated input voltage.
	The AC drive detects excessive drive output current. Note: The AC drive can withstand up to 150% of the rated current for a maximum of 60 seconds.	<ol style="list-style-type: none"> 1. Check whether the motor is overloaded. 2. Reduce torque compensation setting as set in 2-03. 3. Increase the AC drive's output capacity.

Fault Codes		
Fault Name	Fault Descriptions	Corrective Actions
OL1	Internal electronic overload trip	<ol style="list-style-type: none"> 1. Check for possible motor overload. 2. Check electronic thermal overload setting. 3. Increase motor capacity. 4. Reduce the current level so that the AC drive output current does not exceed the value set by the Motor Rated Current 0-01.
OL2	Motor overload. Check the parameter settings (6-07 to 6-09)	<ol style="list-style-type: none"> 1. Reduce the motor load. 2. Adjust the over-torque detection setting to an appropriate level.
OC A	Over-current during acceleration: <ol style="list-style-type: none"> 1. Short-circuit at motor output. 2. Torque boost too high. 3. Acceleration time too short. 4. AC drive output capacity is too small. 	<ol style="list-style-type: none"> 1. Check for possible poor insulation at the output line. 2. Decrease the torque boost setting in 2-03. 3. Increase the acceleration time. 4. Replace with the AC drive with one that has a higher output capacity (next HP size).
OC D	Over-current during deceleration <ol style="list-style-type: none"> 1. Short-circuit at motor output. 2. Deceleration time too short. 3. AC drive output capacity is too small. 	<ol style="list-style-type: none"> 1. Check for possible poor insulation at the output line. 2. Increase the deceleration time. 3. Replace with the AC drive with one that has a higher output capacity (next HP size).
OC N	Over-current during steady state operation: <ol style="list-style-type: none"> 1. Short-circuit at motor output. 2. Sudden increase in motor loading. 3. AC drive output capacity is too small. 	<ol style="list-style-type: none"> 1. Check for possible poor insulation at the output line. 2. Check for possible motor stall. 3. Replace with the AC drive with one that has a higher output capacity (next HP size).
CF1	Internal memory IC cannot be programmed.	<ol style="list-style-type: none"> 1. Switch off power supply. 2. Check whether the input voltage falls within the AC drive's rated input voltage. 3. Switch the AC drive back on.
CF2	Internal memory IC can not be read.	<ol style="list-style-type: none"> 1. Check the connections between the main control board and the power board. 2. Reset drive to factory defaults.
HPF	Hardware protection failure	Return to the factory.
CODE	Software protection failure	Return to the factory.
CF3	AC Drive's internal circuitry abnormal.	<ol style="list-style-type: none"> 1. Switch off power supply. 2. Check whether the input voltage falls within the rated AC drive input voltage. Switch on the AC drive.
EF	The external terminal EF-CM goes from OFF to ON.	When external terminal EF-CM is closed, the output will be turned off (under N.O. E.F.).
CF A	Auto accel/decel failure	Don't use the function of auto acceleration/ deceleration.

Fault Codes		
Fault Name	Fault Descriptions	Corrective Actions
	External Base Block: AC drive output is turned off.	<ol style="list-style-type: none"> 1. When the external input terminal (base-block) is active, the AC drive output will be turned off. 2. Disable this connection and the AC drive will begin to work again.

Warning Messages

There are several Warning Messages that GS1 AC Drive may give. The GS1 AC Drive allows you to decide how the AC drive should react to these messages. The descriptions of the Warning Messages are listed below.

Warning Messages		
Warning Name	Warning Descriptions	Corrective Actions
	Communications Warning: Illegal command code - The command code received in the command message is not available for the AC drive.	<p>The corrective action can be set with the Transmission Fault Treatment parameter (9-03). The available settings are:</p> <ol style="list-style-type: none"> 0 - Display fault and continue operating 1 - Display fault and RAMP to stop 2 - Display fault and COAST to stop 3 - No fault displayed and continue operating <p>The default setting is 0.</p>
	Communications Warning: Illegal data address - The data address received in the command message is not available for the AC drive.	
	Communications Warning: Illegal data value - The data value received in the command message is not available for the AC drive.	
	Communications Warning: Slave device failure - The AC drive is unable to perform the requested action.	
	Communications Warning: Communication Time Out	

ACCESSORIES



APPENDIX

A

In This Appendix...

Circuit Protection Devices	A-2
Fuse Kits	A-2
Ethernet Interface	A-4
Miscellaneous Accessories	A-5

Circuit Protection Devices

Circuit protection devices are essential to prevent costly damage to your AC Drive application equipment. Fuse kits are available from Automation Direct for the GS1 Series AC Drives, and their specifications are found below. Specifications for other circuit protection devices used in conjunction with the GS1 AC Drives can be found on the next few pages.

Fuse Kits

The following fuse kits consist of one fuse block and fuses sized to match each GS1 Series AC Drive. Replacement fuses are also available, and their part numbers are listed in the table below.

Fuse Kit Specifications						
Part Number	Fuse Block	Wire Range	Fuse Type	Dimensions	Fuse Rating	Replacement Fuses
GS-10P2-FKIT-1PH	Two-pole	Al/Cu #2-14	A3T	Figure 1	300V@20A	GS-10P2-FUSE-1PH
GS-10P5-FKIT-1PH	Two-pole			Figure 1	300V@30A	GS-10P5-FUSE-1PH
GS-20P2-FKIT-1PH	Two-pole			Figure 1	300V@15A	GS-20P2-FUSE-1PH
GS-20P2-FKIT-3PH	Three-pole			Figure 2	300V@10A	GS-20P2-FUSE-3PH
GS-20P5-FKIT-1PH	Two-pole			Figure 1	300V@20A	GS-20P5-FUSE-1PH
GS-20P5-FKIT-3PH	Three-pole			Figure 2	300V@10A	GS-20P5-FUSE-3PH
GS-21P0-FKIT-1PH	Two-pole			Figure 1	300V@30A	GS-21P0-FUSE-1PH
GS-21P0-FKIT-3PH	Three-pole			Figure 2	300V@20A	GS-21P0-FUSE-3PH
GS-22P0-FKIT-3PH	Three-pole			Figure 2	300V@25A	GS-22P0-FUSE-3PH

Fuse Kit Dimensions

Figure 1

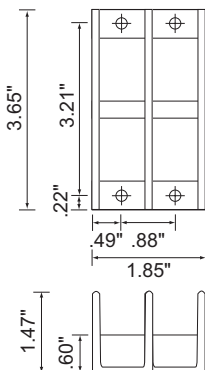
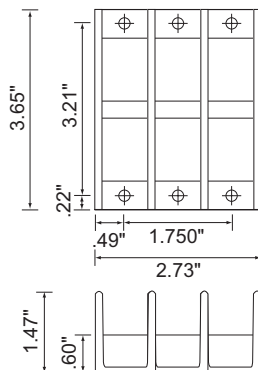

Figure 2



*Units = inches

Non-fuse Circuit Breaker Chart

If you choose to use a non-fuse circuit breaker in your application, refer to the chart below for sizing.

1. For 1-phase AC Drives with input currents of 100A or less, the current rating of the breaker shall be four times the maximum of **input** current rating.
2. For 3-phase AC Drives with output currents of 100A or less, the current rating of the breaker shall be four times the maximum of **output** current rating.

Non-fuse Circuit Breaker Chart			
Part Number	Input Current	Output Current	Recommended Breaker Size
GS1-10P2	6A	1.6A	20A
GS1-10P5	9A	2.5A	30A
GS1-20P2 (1 Ø/3 Ø)*	4.9A	1.6A	15A/10A
GS1-20P5 (1 Ø/3 Ø)*	6.5A	2.5A	25A/10A
GS1-21P0 (1 Ø/3 Ø)*	9.7A	4.2A	45A/20A
GS1-22P0	9.0A	7.0A	25A

* Ø=phase

Circuit breaker size is dependent on input power phase.

Fuse Specification Chart

The chart below gives the recommend fuse sizes for the GS1 Series AC Drives. Smaller fuses than those shown in the table are permitted.

Fuse Specification Chart			
Part Number	Input Current	Output Current	Recommended Fuse Size
GS1-10P2	6A	1.6A	20A
GS1-10P5	9A	2.5A	30A
GS1-20P2 (1 Ø/3 Ø)*	4.9A	1.6A	15A/10A
GS1-20P5 (1 Ø/3 Ø)*	6.5A	2.5A	25A/10A
GS1-21P0 (1 Ø/3 Ø)*	9.7A	4.2A	45A/20A
GS1-22P0	9.0A	7.0A	25A

* Ø=phase

Fuse size is dependent on input power phase.

Ethernet Interface

GS-EDRV

The GS-EDRV provides a high-performance Ethernet link between a control system and a GS1 Series AC drive. It mounts on DIN rail and connects a drive to an Ethernet hub or PC. The GS-EDRV processes input signals from the drive, formats the signals to conform with the Ethernet standard, and transmits the signals to the controller. The Ethernet interface also receives and translates the output signals from the controller and distributes the signals to the drive.

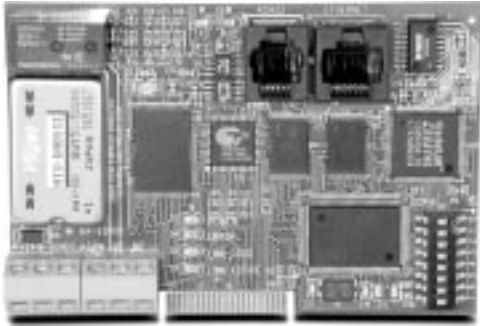

Note: The GS-EDRV requires an external 24VDC power supply.

Automatic power shut-down

The GS1 AC drives do not have a provision for shutting down control or power to the inverter in the event of a communications time-out. The GS-EDRV provides an on-board communication watch-dog relay. This relay is used to disable control and/or power circuits if communication on either side of the Ethernet interface is broken or timed out. The time-out value is configurable. When the value is exceeded, the state of the relay changes.

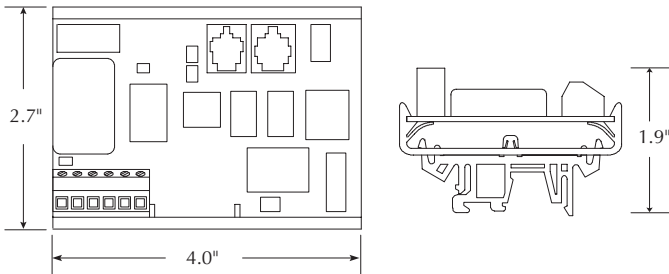

Miscellaneous Accessories

Communication Distribution Blocks

GS-RS485-4

4 port RS485 Communication
Distribution Block

GS-RS485-8

8 port RS485 Communication
Distribution Block

GS-RS485-4**GS-RS485-8**

**USING GS1 AC
DRIVES WITH
*DIRECT*LOGIC PLCs**



**APPENDIX
B**

In This Appendix...

- Compatible DirectLOGIC PLCs and ModulesB-2
- Typical Connections to the GS1 Series AC Drive . .B-6

Compatible *DirectLOGIC* PLCs and Modules

The following tables show which *DirectLOGIC* PLCs and modules can be used with the GS1 Series AC Drive.

DirectLOGIC PLC Modules for Use with GS1 AC Drives	
DL05 PLCs	
D0-05AR	DL05 CPU, 8 AC in / 6 Relay out, 110/220VAC Power Supply. Inputs: 8 AC inputs, 90-120 VAC, 2 isolated commons. Outputs: 6 Relay outputs, 6-27 VDC, 6-240 VAC, 2A/pt. max., 2 isolated commons
D0-05DR	DL05 CPU, 8 DC in / 6 Relay out, 110/220VAC Power Supply. Inputs: 8 DC inputs, 12-24 VDC current sinking/sourcing, 2 isolated commons. Outputs: 6 Relay outputs, 6-27 VDC, 6-240 VAC, 2A/pt. max., 2 isolated commons
D0-05DD	DL05 CPU, 8 DC in / 6 DC out, 110/220VAC Power Supply. Inputs: 8 DC inputs, 12-24 VDC current sinking/sourcing, 2 isolated commons. Outputs: 6 DC outputs, 6-27 VDC current sinking, 1.0A/pt. max.
D0-05DD-D	DL05 CPU, 8 DC in / 6 DC out, 12/24VDC Power Supply. Inputs: 8 DC inputs, 12-24 VDC current sinking/sourcing, 2 isolated commons. Outputs: 6 DC outputs, 6-27 VDC current sinking, 1.0A/pt. max.
D0-05DR-D	DL05 CPU, 8 DC in / 6 Relay out, 12/24VDC Power Supply. Inputs: 8 DC inputs, 12-24 VDC current sinking/sourcing, 2 isolated commons. Outputs: 6 Relay outputs, 6-27 VDC, 6-240 VAC, 2A/pt. max., 2 isolated commons
DL06 PLCs	
D0-06DD1	DL06 CPU, 20 DC in / 16 DC out, 110/220VAC Power Supply, with 0.3A 24VDC Auxiliary Device Power Supply. Inputs: 20 DC inputs, 12-24 VDC current sinking/sourcing, 5 isolated commons (4 inputs per common). Outputs: 16 DC outputs, 12-24 VDC current sinking, 1.0A/pt. max., 4 commons non-isolated (4 points per common).
D0-06DR	DL06 CPU, 20 DC in / 16 Relay out, 110/220VAC Power Supply, with 0.3A 24VDC Auxiliary Device Power Supply. Inputs: 20 DC inputs, 12-24 VDC current sinking/sourcing, 5 isolated commons (4 inputs per common). Outputs: 16 Relay outputs, 6-27 VDC, 6-240 VAC, 2A/pt. max., 4 isolated commons (4 points per common).
D0-06AR	DL06 CPU, 16 AC in / 20 Relay out, 110/220VAC power supply, with 0.3A 24VDC auxiliary device power supply. Inputs: 20 AC inputs, 90-120 VAC, 5 isolated commons (4 inputs per common). Outputs: 16 Relay outputs, 6-27VDC, 6-240VAC, 2A/pt. max., 4 isolated commons (4 points per common).
D0-06DD1-D	DL06 CPU, 20 DC in / 16 DC out, 12/24VDC Power Supply. Inputs: 20 DC inputs, 12-24 VDC current sinking/sourcing, 5 isolated commons (4 inputs per common). Outputs: 16 DC outputs, 12-24 VDC current sinking, 1.0A/pt. max., 4 commons non-isolated (4 points per common).
D0-06DR-D	DL06 CPU, 20 DC in / 16 Relay out, 110/220VAC Power Supply. Inputs: 20 DC inputs, 12-24 VDC current sinking/sourcing, 5 isolated commons (4 inputs per common). Outputs: 16 Relay outputs, 6-27 VDC, 6-240 VAC, 2A/pt. max., 4 isolated commons (4 points per common).
DL05/DL06 DC Input/Output Module	
D0-08CDD1	4 pt. 12-24VDC current sinking/sourcing input, 1 common, 4 pt. 12-24VDC sinking output, 0.3A/point, 1.2A/module, removable terminal, no fuse
DL05/DL06 DC Output Modules	
D0-10TD1	10 pt. 12-24 VDC current sinking output module, 2 commons non-isolated (5 pts. per common), 0.3A/point, 1.5A/common, removable terminal, no fuse
D0-16TD1	16 pt. 12-24 VDC current sinking output module, 2 commons non-isolated (5 pts. per common), 0.3A/point, 1.5A/common, removable terminal, no fuse.

DirectLOGIC PLC Modules for Use with GS1 AC Drives (cont.)	
DL05/DL06 Analog Module	
F0-2AD2DA-2	2 channel in, 2 channel out voltage analog option card; 0-5V, 0-10V
F0-4AD2DA-2	4 channel in, 2 channel out voltage analog option card; 0-5V, 0-10V
F0-4AD2DA-1	4 channel in, 2 channel sourcing out current analog option card; 4-20mA
DL105 PLCs	
F1-130DR	DL06 CPU, 20 DC in / 16 DC out, 110/220VAC Power Supply, with 0.3A 24VDC Auxiliary Device Power Supply. Inputs: 20 DC inputs, 12-24 VDC current sinking/sourcing, 5 isolated commons (4 inputs per common). Outputs: 16 DC outputs, 12-24 VDC current sinking, 1.0A/pt. max., 4 commons non-isolated (4 points per common).
F1-130DD-D	DL130 CPU, 10 DC in / 8 DC out, 12/24VDC Power Supply. Inputs: 10 DC inputs, 12-24 VDC current sinking/sourcing, 3 isolated commons. Outputs: 8 DC outputs, 5-30VDC current sinking, 0.5A/pt. max, 3 internally connected commons.
F1-130DR-D	DL130 CPU, 10 DC in / 8 Relay out, 12/24VDC Power Supply. Inputs: 10 DC inputs, 12-24 VDC current sinking/sourcing, 3 isolated commons. Outputs: 8 relay outputs, 12-30VDC, 12-250VAC, 7A/pt. max., 4 isolated commons
F1-130DD-D	DL130 CPU, 10 DC in / 8 DC out, 12/24VDC Power Supply. Inputs: 10 DC inputs, 12-24 VDC current sinking/sourcing, 3 isolated commons. Outputs: 8 DC outputs, 5-30VDC current sinking, 0.5A/pt. max, 3 internally connected commons.
DL205 DC Output Module	
D2-16TD1-2	16 pt. 12-24 VDC current sinking output module, 1 common (2 common terminals), 0.1A/point, 1.6A/module, no fuse, European type removable terminal
D2-32TD1	32 pt. 12-24 VDC current sinking output module. 1 common (4 common terminals), 0.1A/point, 3.2A/module, no fuse.
DL205 Relay Output Modules	
D2-04TRS	4-pt. 5-30 VDC or 5-240 VAC isolated relay output module, 4 Form A (SPST) relays, 4 commons, 4A/point, 8.0A/module, replaceable fuse, removable terminal
D2-08TR	8-pt. 5-30 VDC or 5-240 VAC output module, 8 Form A (SPST) relays, 1 common (2 common terminals), 1A/point, 4.0A/module, replaceable fuse, removable terminal
F2-08TR	8-pt relay output, 10A/common, 5-30VDC or 5-240VAC
F2-08TRS	8-pt. 12-28 VDC or 12-240 VAC output module, 5 Form A (SPST) relays, 3 Form C (SPDT) relays, 8 isolated commons, 7A/point max., no fuses, removable terminal
D2-12TR	12 pt. 5-30 VDC or 5-240 VAC relay output module, 12 Form A (SPST) relays, 2 commons, 1.5A/point max., 3.0A/common, 2 replaceable fuses, removable terminal
DL205 DC Input/Output Modules	
D2-08CDR	4 pt. 24VDC sinking/sourcing input, 1 common, 4 pt. relay output, 1A/pt., 4A/module, 1 common, replaceable fuse
DL205 Analog Output Module	
F2-02DAS-1	2 channel, 16-bit resolution, Isolated 4-20mA sourcing (2 isolated commons). Designed to operate with 24 VDC user-supplied power supply.
F2-02DAS-2	2 channel analog output, 16 bit resolution, isolated, range: 0-5V, 0-10V (2 isolated commons). Designed to operate with 24 VDC user-supplied power supply.
F2-08DA-1	8 channel analog output module, 12 bit resolution, range: 4-20mA, sink or source output configurable. Designed to operate with 24 VDC user-supplied power supply.
F2-02DA-2	2 channel analog output module, 12 bit resolution, ranges: 0-5V, 0-10V, -5 to +5V, -10 to +10V. Designed to operate with 24 VDC user-supplied power supply.
F2-08DA-2	8 channel analog output module, 12 bit resolution, ranges: 0-5V, 0-10V. [†] Designed to operate with 24 VDC user-supplied power supply.

DirectLOGIC PLC Modules for Use with GS1 AC Drives (cont.)	
DL305 AC/DC Output Modules	
D3-08TR	8 pt. 5-30 VDC or 5-220 VAC output module, 5A/point DC or 4A/point AC, 8 Form A relays (SPST), 2 commons (isolated), non-removable terminal, 2 user replaceable fuses
D3-16TR	16 pt. 5-30 VDC or 5-220 VAC output module, 2A/point, 16 Form A relays (SPST), 2 commons (isolated), removable terminal, no internal fuses
DL305 Analog Output Modules	
F3-04DAS	4 channel isolated analog output module, 12 bit resolution, ranges: 0 to 5V, 0 to 10V, -5 to +5V, -10 to +10V, 4 to 20mA, 0 to 20mA. -750 to +750 VDC channel to channel isolation
DL405 DC Output Modules	
D4-08TD1	8 pt. 12-24 VDC current sinking output module, 2 commons (internally connected), 2A/point, 5A/common, removable terminal
D4-16TD1	16 pt. 5-24 VDC current sinking output module, 2 commons (internally connected), 0.5A/point, 3A/common, removable terminal
D4-32TD1	32 pt. 5-24 VDC current sinking output module, 4 commons (isolated), 0.2A/point, 1.6A/common. Requires one connector, sold separately.
DL405 AC/DC Output Modules	
D4-08TR	8 pt. 5-30 VDC or 5-250 VAC output module, 8 Form A (SPST) relays, 2 commons (isolated), 2A/point, 5A/common, removable terminal
F4-08TRS-1	8 pt. 12-30 VDC or 12-250 VAC isolated output module, 4 Form A (SPST) and 4 Form C (SPDT) relays, 8 commons (isolated), 10A/point, 40A/module, removable terminal.
F4-08TRS-2	8 pt. 12-30 VDC or 12-250 VAC isolated output module, 4 Form A (SPST) relays and 4 Form C (SPDT) relays, 8 commons (isolated), 5A/point, 40A/module, replaceable fuses, removable terminals.
D4-16TR	16 pt. 5-30 VDC or 5-250 VAC output module, 8 Form A (SPST) relays, 2 commons (isolated), 1A/point, 5A/common, removable terminals.
DL405 Analog Output Modules	
F4-04DAS-1	4 channel analog output module, 16 bit resolution, isolated, range: 4 to 20mA current sourcing.
F4-04DAS-2	4 channel analog output module, 16 bit resolution, isolated, range: 0-5V, 0-10V.
F4-08DA-2	8 channel analog output module, 12 bit resolution, range: 0-5V or 0-10V
F4-16DA-2	16 channel analog output module, 12 bit resolution, range: 0-5V or 0-10V.

DirectLOGIC PLC Modules for Use with GS1 AC Drives (cont.)	
Terminator I/O DC Output Modules	
T1K-08TD1	8 pt. 12-24 VDC current sinking output module, 4 points per common, 1.0A/point, 2 replaceable fuses (T1K-FUSE-1). (use with T1K-08B or T1K-08B-1 terminal base)
T1K-16TD1	16 pt. 12-24 VDC current sinking output module, 4 points per common, 1.0A/point, 4 replaceable fuses (T1K-FUSE-1). (use with T1K-16B or T1K-16B-1 terminal base)
Terminator I/O AC/DC Output Modules	
T1K-08TR	8 pt. 5-30 VDC or 5-240 VAC output module, 8 Form A (SPST) relays, 4 points per common, 2.0A/point max., 2 replaceable fuses (T1K-FUSE-2). (use with T1K-08B or T1K-08B-1 terminal base)
T1K-16TR	16 pt. 5-30 VDC or 5-240 VAC output module, 16 Form A (SPST) relays, 4 points per common, 2.0A/point max., 4 replaceable fuses (T1K-FUSE-2). (use with T1K-16B or T1K-16B-1 terminal base)
T1K-08TRS	8 pt. 5-30 VDC or 5-240 VAC isolated relay output module, 8 Form A (SPST) relays, 1 point per common, 7.0A/point max., 8 replaceable fuses (T1K-FUSE-3). (isolation requires use of T1K-16B or T1K-16B-1 terminal base)
Terminator I/O Analog Output Modules	
T1F-08DA-2	8 channel analog output, 12 bit resolution, range: 0-5VDC, 0-10VDC, +/-5VDC, +/-10VDC. (use with T1K-08B or T1K-08B-1 terminal base)
T1F-16DA-2	16 channel analog output, 12 bit resolution, range: 1-5VDC, 1-10VDC, +/-5VDC, +/-10VDC. (use with T1K-16B or T1K-16B-1 terminal base)

Typical Connections to the GS1 Series AC Drive

The following drawings show some typical connections between the GS1 Series AC Drive and DirectLOGIC PLCs and modules.

DC Output Modules

- D0-05DD
- D0-05DD-D
- D0-06DD1
- D0-06DD1-D
- D0-10TD1
- D0-16TD1
- D2-16TD1-2
- D2-32TD1
- D4-08TD1
- D4-16TD1
- D4-32TD1
- T1K-08TD1
- T1K-16TD1

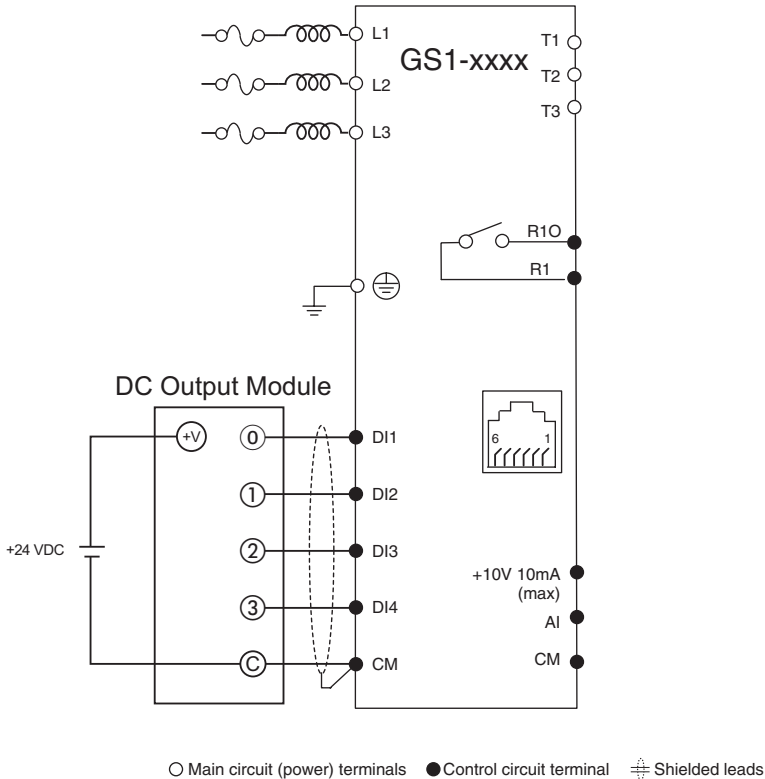

Isolated Analog Output Modules

- F2-02DAS-1
- F2-02DAS-2
- F4-04DAS-1
- F4-04DAS-2

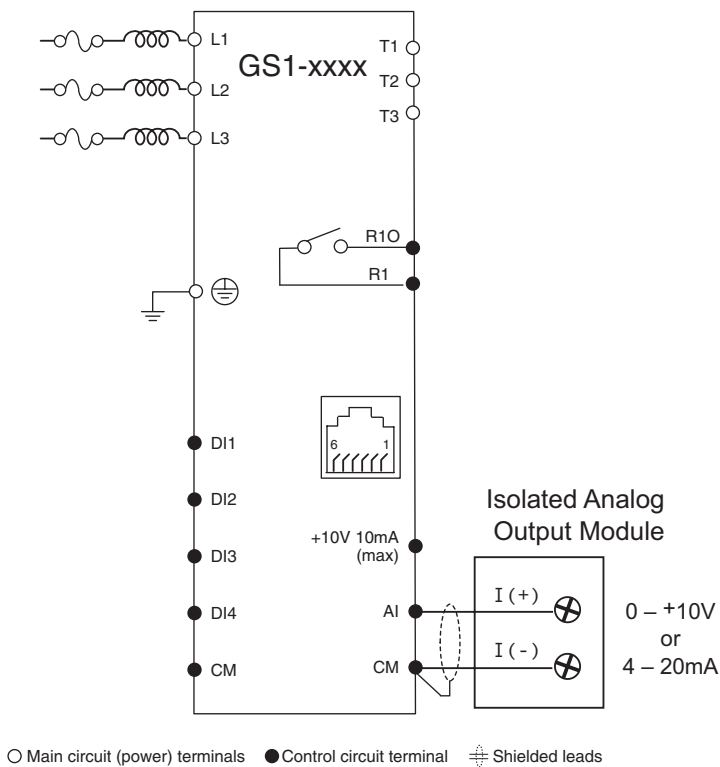

Non-Isolated Voltage or Sourcing Current Analog Output Modules

- F0-02AD2DA-2
- F0-04AD2DA-1
- F0-04AD2DA-2
- F2-02DAS-1
- F2-02DAS-2
- F2-08DA-1
- F2-02DA-2
- F2-08DA-2
- F4-08DA-2
- F4-16DA-2
- T1F-08DA-2
- T1F-16DA-2
- T1F-8AD4DA-1
- T1F-8AD4DA-2

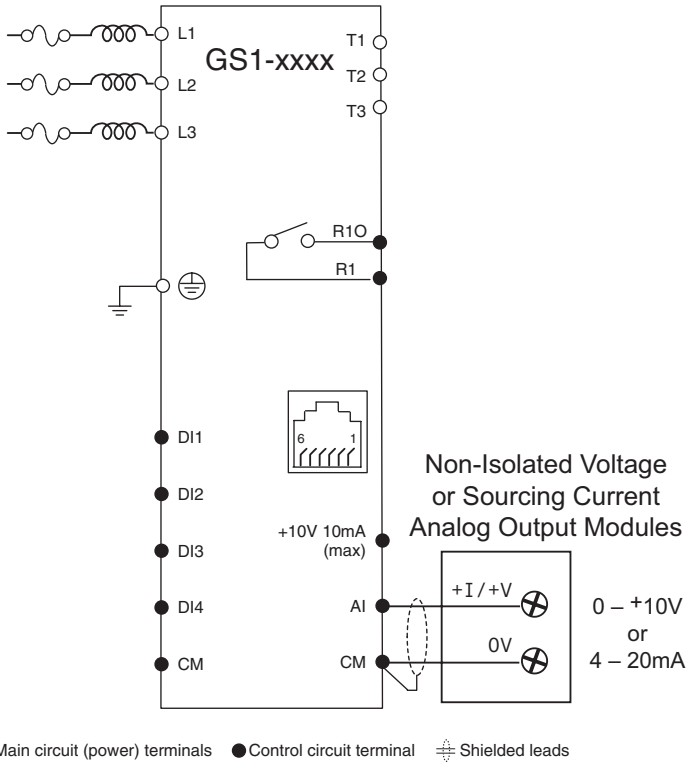

INDEX



A

- Accel 1 to Accel 2 Frequency Transition, 4-14
- Accel S-Curve, 4-12
- Acceleration Time 1, 4-11
- Acceleration Time 2, 4-13
- Accessories
 - Circuit Protection Devices, A-2
 - Fuse Kits, A-2
 - Miscellaneous, A-5
- AirFlow, 2-3
- Ambient Conditions, 2-2
- Analog Input
 - examples, 4-31
 - gain, 4-30
 - Loss of ACI Signal, 4-36
 - offset, 4-30
 - offset polarity, 4-29
 - reverse motion enable, 4-30
- Analog Parameters, 4-29
- Applicable Codes, 2-6
- Auto Adjustable Accel/Decel, 4-40
- Auto Restart after Fault, 4-38
- Auto Voltage Regulation, 4-39

B

- Base-Block Time for Speed Search, 4-42
- Basic Wiring Diagram, 2-11
- Block Transfer, 5-10, 5-12
- Block Transfer Parameters, 4-47

C

- Circuit Breaker, A-3
- Circuit Connections, 2-5
- Circuit Protection Devices, A-2
- Communicating with DirectLogic PLCs, 5-6
- Communicating with Third-party Devices, 5-16
- Communication Address, 4-46
- Communication Distribution Blocks, A-5
- Communication Parameters, 4-46, 5-2
- Communication Protocol, 4-46
- Communication Transmission Speed, 4-46
- Communications connections, 5-6
- Control Terminal Wiring, 2-10

D

- DC Injection
 - Current Level, 4-16
 - during Start-up, 4-16
 - during Stopping, 4-16
 - Start-point, 4-16
- Decel 1 to Decel 2 Frequency Transition, 4-14
- Decel S-Curve, 4-13
- Deceleration Time 1, 4-12
- Deceleration Time 2, 4-13
- Default (restore to), 4-47
- Desired Current, 4-28
- Desired Frequency, 4-28
- Dimensions, 2-4
- Direction Command, 4-49

DirectLOGIC MODBUS Ladder Programming, 5–9
DirectLOGIC PLCs, B–2
Display, 3–2
Display Function, 4–45
Display Parameters, 4–45

E

Electronic Thermal Overload Relay, 4–38
Error Codes, 6–3
External Fault, 4–49
External Parts, 1–4
External Wiring, 2–12

F

Fault (external), 4–49
Fault Codes, 6–3
Fault Record, 4–44
Fault Reset, 4–49
Frequency command, 5–14
Function Keys, 3–2
Fuse Kits, A–2
Fuse Specifications, A–3 thru A–2
Fuses, 2–12

G

GS Series Number, 4–50
GS2 AC Drive

- ambient conditions, 2–2
- circuit connections, 2–5
- dimensions, 2–4
- displaying the status, 3–3
- external parts, 1–4
- function keys, 3–2
- installation, 2–3
- introduction, 1–3
- keypad, 3–2
- labels, 1–4
- programming, 3–4

quickstart, 3–5
specifications, 1–5
wiring, 2–5 thru 2–12

I

Input Terminals, 4–20
Inspection, 6–2

- Annual, 6–2
- Monthly, 6–2

Installation, 2–3
Introduction, 1–3

J

Jog, 4–37
Jog Command, 4–49

K

Keypad, 3–2

L

Labels, 1–4
LED Display, 3–2
Lower Bound of Output Frequency, 4–43

M

Main Circuit Wiring, 2–7
Maintenance, 6–2
Manufacturer Model Information, 4–50
Maximum Allowable Power Loss Time, 4–42
Maximum Speed Search Current Level, 4–42
Mid-point Frequency, 4–18
Mid-point Voltage, 4–18
Minimum Clearances, 2–3
Minimum Output Frequency, 4–18
Minimum Output Voltage, 4–19
MODBUS ASCII, 5–16
MODBUS RTU, 5–16
Model Explanation, 1–3

Model Information, 4–50
 Model Number, 1–3
 Momentary Power Loss, 4–38
 Motor Base Frequency, 4–10
 Motor Base RPM, 4–10
 Motor Maximum RPM, 4–10
 Motor Nameplate Amps, 4–9
 Motor Nameplate Voltage, 4–9
 Motor Parameters, 4–9
 Multi-function Input Terminals, 4–20, 4–37
 Multi-function Output Terminals, 4–27
 Multi-speed settings, 4–37

N

Nameplate Information, 1–3

O

Output Terminals, 4–27
 Over-current Stall Prevention during Operation, 4–41
 Over-current Stall Prevention during Acceleration, 4–41
 Over-Torque Detection Level, 4–40
 Over-Torque Detection Mode, 4–40
 Over-Torque Detection Time, 4–40
 Over-Voltage Trip Prevention, 4–39

P

Package contents, 1–3
 Parameter Details, 4–9
 Parameter Lock, 4–47
 Parameter Summary, 4–2
 Parameters

- Accel 1 to Accel 2 Frequency Transition, 4–14
- Accel S-Curve, 4–12
- Acceleration Time 1, 4–11
- Acceleration Time 2, 4–13
- Analog Input Gain, 4–30

- Analog Input Offset, 4–30
- Analog Input Offset Polarity, 4–29
- Analog Input Reverse Motion Enable, 4–30
- Auto Adjustable Accel/Decel, 4–40
- Auto Restart after Fault, 4–38
- Auto Voltage Regulation, 4–39
- Auto-torque Boost, 4–18
- Base-Block Time for Speed Search, 4–42
- Block Transfer Parameters, 4–47
- Communication Address, 4–46
- Communication Protocol, 4–46
- DC Injection, 4–16
 - current level, 4–16
 - during start-up, 4–16
 - during stopping, 4–16
 - start-point, 4–16
- Decel 1 to Decel 2 Frequency Transition, 4–14
- Decel S-Curve, 4–13
- Deceleration Time 1, 4–12
- Deceleration Time 2, 4–13
- Desired Current, 4–28
- Desired Frequency, 4–28
- Direction Command, 4–49
- Electronic Thermal Overload Relay, 4–38
- External Fault, 4–49
- Fault Reset, 4–49
- Frequency Scale Factor, 4–45
- Jog, 4–37
- JOG Command, 4–49
- Loss of ACI Signal, 4–36
- Lower Bound of Output Frequency, 4–43
- Maximum Allowable Power Loss Time, 4–42
- Maximum Speed Search Current Level, 4–42
- Mid-point Frequency, 4–18
- Mid-point Voltage, 4–18
- Minimum Output Frequency, 4–18
- Minimum Output Voltage, 4–19
- Momentary Power Loss, 4–38
- Motor Base Frequency, 4–10

- Motor Base RPM, 4–10
 - Motor Maximum RPM, 4–10
 - Motor Nameplate Amps, 4–9
 - Motor Nameplate Voltage, 4–9
 - Multi-function Input Terminals, 4–20
 - Multi-function Output Terminals, 4–27
 - Multi-speed bits, 4–37
 - Over-current Stall Prevention during Operation, 4–41
 - Over-current Stall Prevention during Acceleration, 4–41
 - Over-Torque Detection Level, 4–40
 - Over-Torque Detection Mode, 4–40
 - Over-Torque Detection Time, 4–40
 - Over-Voltage Trip Prevention, 4–39
 - Parameter Lock, 4–47
 - Present Fault Record, 4–44
 - PWM Carrier Frequency, 4–19
 - Restore to Default, 4–47
 - Reverse Operation Inhibit, 4–38
 - RS485 Speed Reference, 4–49
 - RUN Command, 4–49
 - Select method for 2nd Accel/Decel, 4–14
 - Skip Frequencies , 4–15
 - Skip Frequency Band, 4–15
 - Slip Compensation, 4–18
 - Source of Frequency Command, 4–29
 - Source of Operation Command, 4–20
 - Stop Methods, 4–11
 - summary, 4–2
 - Time Out Detection, 4–47
 - Time Out Duration, 4–47
 - Transmission Fault Treatment, 4–47
 - Transmission Speed, 4–46
 - Upper Bound of Output Frequency, 4–43
 - User Defined Display Function, 4–45
 - Volts/Hertz, 4–17
 - PLC Module Connections, B–6
 - PLC Modules, B–2
 - Potentiometer, 3–2
 - Present Fault Record, 4–44
 - Preset Parameters, 4–37
 - Programming, 3–4
 - Protection Parameters, 4–38
 - PWM Carrier Frequency, 4–19
- ## Q
- Quickstart, 3–5
- ## R
- Ramp Parameters, 4–11
 - Reset faults, 4–49
 - Restore to Default, 4–47
 - Reverse Operation Inhibit, 4–38
 - RS485 Speed Reference, 4–49
 - RUN Command, 4–49, 5–13
- ## S
- Select method for 2nd Accel/Decel, 4–14
 - Skip Frequencies , 4–15
 - Skip Frequency Band, 4–15
 - Slip Compensation, 4–18
 - Source of Frequency Command, 4–29
 - Source of Operation Command, 4–20
 - Specifications, 1–5
 - Status Addresses, 5–4
 - Status Display, 3–3
 - Status Monitor, 5–4
 - Stop Command, 5–13
 - Stop Methods, 4–11
 - Supplemental Publications, 1–2
- ## T
- Technical Support, 1–2
 - Time Out Detection, 4–47
 - Time Out Duration, 4–47
 - Transmission Fault Treatment, 4–47
 - Troubleshooting, 6–3

U

Unpacking, 1–3

Upper Bound of Output Frequency, 4–43

V

Voltz/Hertz Parameters, 4–17

W

Warning Messages, 6–6

Wiring, 2–5 thru 2–12



G S 1 - M