



CONTENTS

About This Manual.	5
Definitions	5
Scope	5
Introduction.	5
Installation.	6
Prerequisites.	6
Installing the Daughterboard	6
System Configuration.	8
Master Class 1	8
Master Class2	8
General Station Data (GSD) Files for Master Class 1 Devices	9
Cyclic Data Exchange	9
Identity Numbers	10
Network Baud Rate	10
Slave Device Network Address	10
Data Management.	11
Physical Block	11
Transducer Block.	13
Compliance	20

ABOUT THIS MANUAL

Definitions

DD	Device Description
DP	PROFIBUS® protocol for (D)ecentralized or distributed (P)eripherals. Defines the basic functions related to cyclic data exchange.
DPV1	Extended functions of PROFIBUS DP that allow acyclic communication for parameter configuration. DP is traditionally only suited for transfer of measured variables.
DTM	Device Type Manager
GSD	General Station Data file. Driver file that defines the behavior of the PROFIBUS DP device over PROFIBUS. The driver file describes capabilities like data-rates, dynamic variables, etc. A PROFIBUS DP master uses the GSD file to start cyclic communication with the device.
PA Profile	The PA profile standardizes the basic functions for all the different PROFIBUS devices.
PV	Process Value
SPS	Alternate abbreviation for PLC (Programmable Logic Controller)
User Units	Defined by configuration of the meter's volume unit or flow unit

Scope

This document shall discuss the supported features of PROFIBUS DP, how these features are related to the M2000, and the special considerations and type of data that is accessible over PROFIBUS DP. This document assumes general understanding of the PROFIBUS DP protocol by the reader. For further information regarding the PROFIBUS DP Protocol, refer to www.PROFIBUS.com.

The M2000 PROFIBUS DP daughterboard supports PROFIBUS DPV1 protocol. This is an extended protocol that allows for acyclic communication for parameter configuration.

In addition, the M2000 PROFIBUS DP daughterboard supports PA Profile Version 3.0.

INTRODUCTION

PROFIBUS is an international, vendor-independent, bus standard for a wide range of applications in manufacturing, production, process and building automation, and other automation control industries.

The PROFIBUS family comprises three types of protocol, PROFIBUS DP, PROFIBUS-PA and PROFIBUS-FMS, and each is used for different tasks. Only PROFIBUS DP is considered in this document.

PROFIBUS DP (Decentralized Periphery) is a rapid and low cost communication connection designed for high speed data transmission. PROFIBUS DP is accomplished with an M2000 through a PROFIBUS DP to MODBUS RTU signal conversion board, referred to as the PROFIBUS DP daughterboard throughout the remainder of this document.

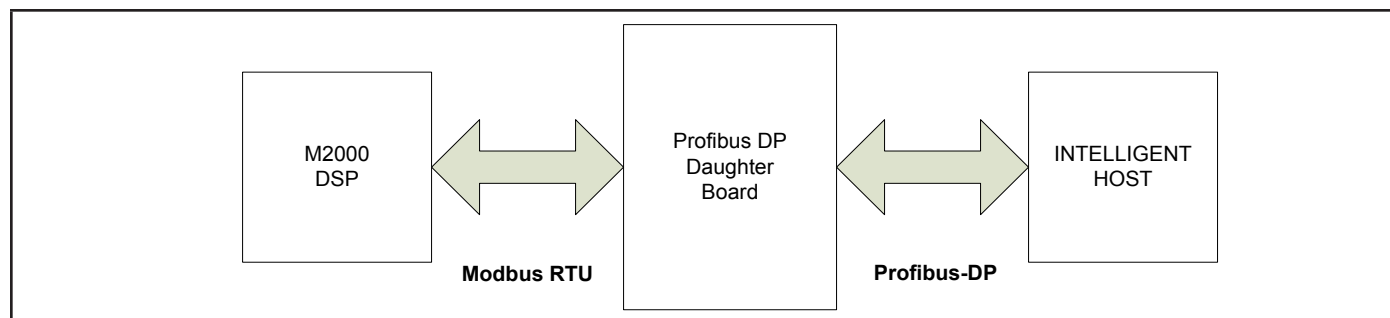

Figure 1: PROFIBUS DP-to-MODBUS RTU Commands

INSTALLATION

Prerequisites

Installing a PROFIBUS DP daughterboard into an M2000 requires firmware revision v1.10 or later.

Installing the Daughterboard

The PROFIBUS DP daughterboard connects to the 11-pin connector labeled COMMUNICATION on the main amplifier.

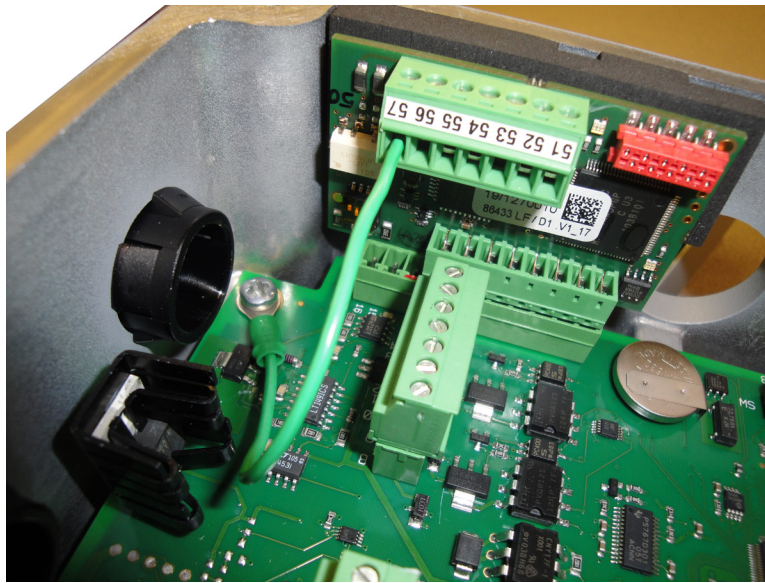

Figure 2: Daughterboard Connection

Follow these steps to install the daughterboard.

1. Prior to installing the daughterboard, verify or configure the M2000 Communication Port B.

The port settings are located at *Main Menu > Communications > Port B Settings*.

Parameter	Value	Comments
Port Address	001	Mandatory value of 001
Extended Port Address	—	Application specific. Sets PROFIBUS DP address of module
Baud Rate	38400	PROFIBUS DP Daughterboard auto-bauds
Data Bits	8	Mandatory value of 8
Parity	EVEN	Mandatory value of EVEN
Stop Bits	1	Mandatory value of 1

2. Power off the M2000.

CAUTION

DISCONNECT THE INPUT POWER BEFORE ACCESSING THE EQUIPMENT.

This step is important for the M2000 to properly recognize the PROFIBUS DP daughterboard.

3. Prior to inserting the daughterboard, install the foam insulation pad as shown [Figure 3](#). Be sure to align the groove with the two screws attaching the detector or wall mount bracket to the enclosure. The primary purpose of this pad is to ensure the daughterboard is insulated from the enclosure wall. It is important to install this pad flush with the top of the enclosure wall.

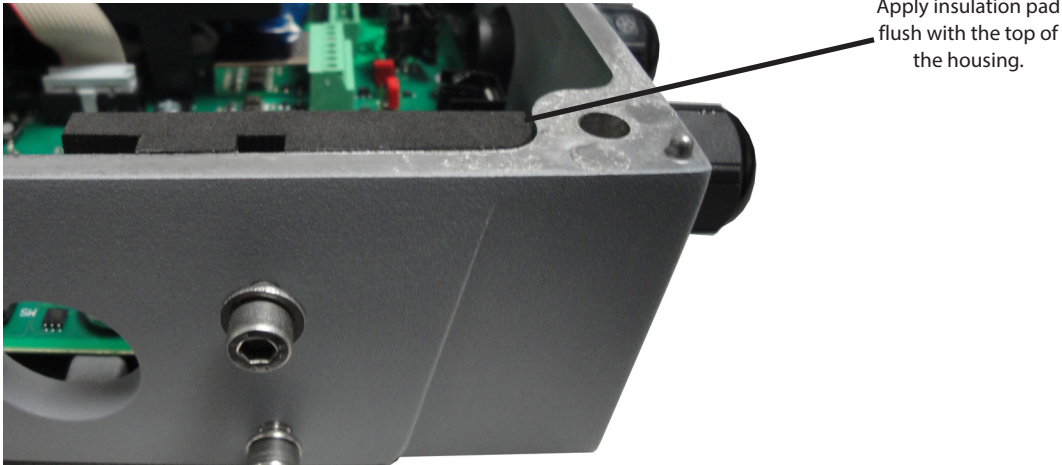

Figure 3: Installing Foam Insulation Pad

4. Insert the 8-pin daughterboard into the 11-pin connector.
5. Use the following information to make appropriate wiring of signals to the 7-pin customer connector.

Pin Number	Pin Description	Comments
51	RXD/TXD-P	Receive Data / Transmission Data – Plus
52	RXD/TXD-N	Receive Data / Transmission Data – Negative
53	Shield	—
54	RXD/TXD-P	Receive Data / Transmission Data – Plus
55	RXD/TXD-N	Receive Data / Transmission Data – Negative
56	Shield	—
57	Chassi	—

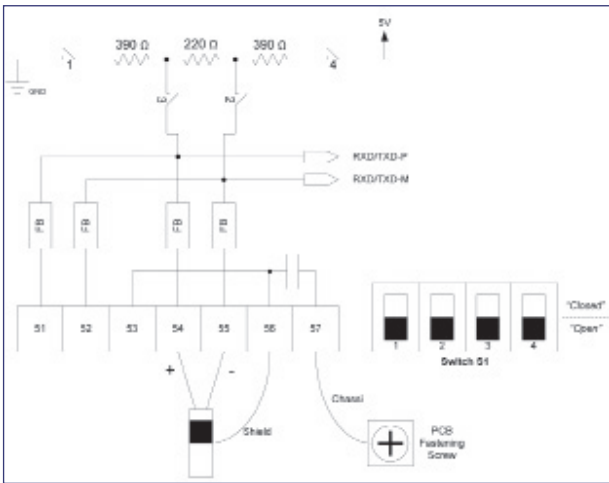

Figure 4: Signal Wiring Diagram

6. Power on the M2000.
7. Allow time for the daughterboard to properly power up and be recognized by the M2000 before navigating the menus. This time is typically 5 seconds. If the PROFIBUS DP daughterboard is not recognized, then the M2000 should be power cycled.
8. Verify recognition of the PROFIBUS DP daughterboard. Navigate to *Main Menu > Info > Help*. The *Daughterboard Info* field indicates the Daughterboard Type is PROFIBUS DP.

SYSTEM CONFIGURATION

The network diagram below illustrates a typical network configuration of PROFIBUS devices with an RS485 interface. The PROFIBUS devices with an RS485 interface do not need any segment coupler. These devices can connect directly to the PROFIBUS DP network.

The maximum cable length in a segment depends on the transmission speed. The PROFIBUS DP daughterboard communicates at speeds from 9.6 kbps to 6 Mbps over distances from 100 to 1200 meters.

Baud Rate (pbs)	9.6 K	19.2 K	93.75 K	187.5 K	500 K	1.5 M	6M
Length (m)	1200	1200	1200	1000	400	200	100

The PROFIBUS DP protocol has two distinct modes of operation—cyclic data-exchange mode and acyclic configuration mode. Two types of master devices are defined in a DPV1 network.

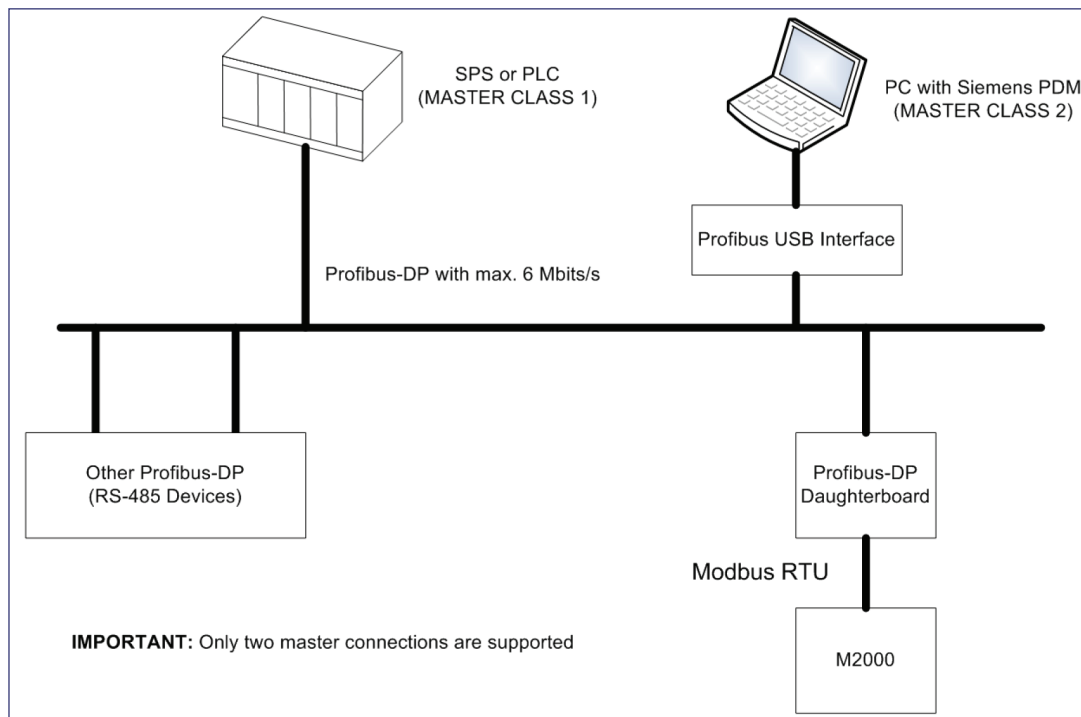

Figure 5: Typical Network Configuration

Master Class 1

Master Class 1 devices can read and write to variables within the slave device cyclically. The Master Class 1 device will also support acyclic read and write services to application parameters in the slave device. The slave device offers such services only to the master device that has set the device into cyclic data exchange and only when it is in cyclic data exchange.

A Master Class 1 device is typically a process controller (PLC or SPS) that is performing control functions based on continuously updated measurement variables.

Master Class2

Master Class 2 devices typically establish connections to the slave device. Through this connection the master device will be able to manipulate application parameters of the slave device.

A Master Class 2 device is typically a configuration station (Laptop/PC with configuration management software). Master Class 2 devices are capable of configuring the device and may operate on all network accessible parameters within the PA profile.

General Station Data (GSD) Files for Master Class 1 Devices

The GSD files contain information that will be needed for project planning of the PROFIBUS communication network and are downloadable via the internet.

GSD files describe the capabilities of the PROFIBUS DP device. For example, the baud rates supported by the slave device are listed in the GSD file.

Configuration Type	Identity Number	GSD File Name
PROFIBUS 3.0 PA Profile Configuration	0x9700	PA139700.GSD
Manufacture Specific Configuration	0x0D01	BD020D01.GSD

Follow the instructions of the vendor PLC or SPS when installing the GSD file into the PLC.

Cyclic Data Exchange

During network configuration the user defines which data should be transferred cyclically to the master from the slave device. This is performed through the bus configuration tool for the PLC or SPS. Network configuration will be done using one of the supported GSD files (PA139700.GSD or BD020D01.GSD).

The PA Profile Configuration cyclically transfers the analog input function block as defined by the GSD file, PA139700.GSD. The PROFIBUS DP daughterboard associates the meter's flow rate [User Units] with the analog input function block. This is the only dynamic variable that can be cyclically exchanged using the PA profile configuration.

The Manufacture Specific Configuration allows for selection of up to 11 dynamic variables to be transmitted cyclically. The table below defines configurable data that can be exchanged cyclically.

Slot Assignment (see GSD)	Dynamic Variable	Units	Number of Bytes	Supported Configurations
1	Flow Rate	User Units	5	0x94 or 0x42 84 08 05
2	Flow Velocity	m/s	4	0x93
3	T1/T+	User Units	4	0x93
4	T2/T-	User Units	4	0x93
5	T3/TN	User Units	4	0x93
6	Digital Input Status	—	2	0x91
7	Flow Direction	—	2	0x91
8	Relative Flow Rate	%	4	0x93
9	Preset Batch Totalizer	m ³	4	0x93
10	Preset Batch Totalizer	User Units	4	0x93
11	Power Loss Totalizer	seconds	4	0x93
Total:			41 bytes (Maximum)	

The PROFIBUS DP daughterboard supports zero module configuration (0x00) to allow the possibility of leaving a dynamic variable out of cyclic data exchange when using manufacture-specific configurations.

IMPORTANT

For both types of supported network configurations, modification of the display units [User Units] will have an immediate effect on the data transferred over PROFIBUS.

IMPORTANT

For best performance of the PROFIBUS DP daughterboard, ensure the MODBUS RTU baud rate for Port B is set to 38400.

Identity Numbers

The PROFIBUS DP daughterboard is based on the PROFIBUS PA Profile v3.0. The device supports two identity numbers.

- 0x0D01 belongs to GSD file BD020D01.GSD and includes the complete functionality of the M2000.
- 0x9700 is a manufacturer independent identity number and belongs to the GSD file PA139700.GSD. This provides interchangeability of devices (that is, an exchange of electromagnetic flow meters of different vendors).

Network Baud Rate

After power on, a baud rate search is started to detect the current bus speed. It is not necessary to set the baud rate manually. If the baud rate is changed during operation, a power cycle of the slave device is required to re-establish communication with the master.

IMPORTANT

*The PROFIBUS DP daughterboard only supports baud rates up to 6 Mbs.
A baud rate of 12 Mbs is not supported.*

Slave Device Network Address

A new device will have the address of 126. In order to operate on the network it must be assigned a bus address in the range of 0 to 125. Normally, the lower addresses will be assigned for master devices. The address may be changed only when the device is not in cyclic data exchange mode.

There are two ways to commission the network address of the slave device:

- Using PROFIBUS DP
- Using M2000 menu (Port B External Node Address)

DATA MANAGEMENT

The PROFIBUS DP interface is based on the PROFIBUS PA Profile v3.0 and supports the following blocks:

- One Physical Block – contains parameters defined in PA Profile v3.0
- One Transducer Block – contains parameters defined in PA Profile v3.0 in addition to meter specific parameters.
- One Analog Input Function Block – contains one fixed channel, Flow Rate [User Units]

Physical Block

The physical block contains general device setup parameters. It is important to describe the details of the DIAGNOSIS and DIAGNOSIS_EXT parameters of the physical block.

Below is the definition of the supported bits of the DIAGNOSIS parameter.

Bit	Bit Mnemonic	Supported	Bit Description
0	DIA_HW_ELECTR	Yes	Hardware Failure of electronics
1	DIA_HW_MECH	—	—
2	DIA_TEMP_MOTOR	—	—
3	DIA_TEMP_ELECTR	—	—
4	DIA_MEM_CHKSUM	—	—
5	DIA_MEASUREMENT	Yes	Failure in measurement – sensor failure, set if there is a failure over modbus.
6	DIA_NOT_INIT	—	—
7	DIA_INIT_ERR	—	—
8	DIA_ZERO_ERR	—	—
9	DIA_SUPPLY	—	—
10	DIA_CONF_INVALID	Yes	Configuration Invalid – Configuration mismatch between the PROFIBUS DP daughterboard and the sensor electronics
11	DIA_WARMSTART	Yes	Reset occurred within last 10 seconds
12	DIA_COLDSTART	Yes	Power cycle occurred within last 10 seconds
13	DIA_MAINTENANCE	—	—
14	DIA_CHARACTER	—	—
15	IDENT_NUMBER_VIOLATION	Yes	Wrong identity number
16-30	—	—	—
31	EXTENSION_AVAILABLE	Yes	Extension status is available

Below is the definition of the DIAGNOSIS_EXTENSION parameter.

Byte	Bit	Supported	Bit Description
0	0	Yes	Detector Error
	1		Empty Pipe Error
	2		Full Scale Flow Error
	3		Totalizer Rollover Error
	4		Totalizer Rollover Status
	5		Flow Simulation Status
	6		Pulse Synchronization Warning
	7		ADC Interrupt Error
1	0	Yes	ADC Range Error
	1-7	—	—
2	0-7	—	—
3	0-7	—	—
4	0	Yes	Internal Communication Failure – sensor electronics have not responded to modbus requests
	1	Yes	Configuration Error
	2-7	—	—
5	0-7	—	—

The FACTORY_RESET parameter of the physical block is supported. This parameter index is used to reset the device. Three levels exist based on the value written to this index.

- 1 – Factory Reset
- 2506 – Warm start
- 2712 – Set bus address to 126

Remaining parameter indices of the physical block are out of the scope of this document. Please refer to PROFIBUS standards for additional information.

Transducer Block

Typically, the Device Description file is used to understand the organization of the meter specific parameters within the transducer block.

PROFIBUS Transducer Block Indexes (SLOT 1) by Category

Measurements Category

Absolute Index	Relative Index	Write Access Level	Index name	MODBUS Register Address	Data Type	Static Revision
120	10	READ-ONLY	T1 / T+ [m ³]	0x00CF	FLOAT32	—
121	11	READ-ONLY	T1 / T+ [User Units]	0x00D3	FLOAT32	—
122	12	READ-ONLY	T2 / T- [m ³]	0x00D7	FLOAT32	—
123	13	READ-ONLY	T2 / T- [User Units]	0x00DB	FLOAT32	—
124	14	READ-ONLY	T3 / TN [m ³]	0x00DF	FLOAT32	—
125	15	READ-ONLY	T3 / TN [User Units]	0x00E3	FLOAT32	—
126	16	READ-ONLY	T1 / T+ Rollver Counter	0x00E7	UINT16	—
127	17	READ-ONLY	T2 / T- Rollover Counter	0x00E8	UINT16	—
128	18	READ-ONLY	Flow Velocity [m/s]	0x00E9	FLOAT32	—
129	19	READ-ONLY	Flow Rate [m ³ /s]	0x00ED	FLOAT32	—
130	20	READ-ONLY	Flow Rate [User Units]	0x00F1	DS-33	—
131	21	READ-ONLY	Relative Flow Rate [%]	0x00F3	FLOAT32	—
132	22	READ-ONLY	Preset Batch Totalizer [m ³]	0x00EB	FLOAT32	—
133	23	READ-ONLY	Preset Batch Totalizer [User Units]	0x00EF	FLOAT32	—
134	24	READ-ONLY	Power Loss Totalizer [seconds]	0x0107	UINT32	—
135	25	READ-ONLY	Flow Direction	0x012D	UINT16	—

Product Identification Category

Absolute Index	Relative Index	Write Access Level	Index name	MODBUS Register Address	Data Type	Static Revision
136	26	READ-ONLY	Product Code	0x0000	UINT16	—
137	27	READ-ONLY	Firmware Name	0x0009	UCHAR16[16]	—
138	28	READ-ONLY	Application Version	0x0019	UCHAR16[10]	—
139	29	READ-ONLY	Compile Date [MM:DD:YYYY]	0x0023	UCHAR16[16]	—
140	30	READ-ONLY	Compile Time [HH:MM:SS]	0x0033	UCHAR16[16]	—
141	31	READ-ONLY	OTP Boot Checksum	0x0048	UCHAR16[3]	—
142	32	READ-ONLY	Flash OS Checksum	0x004B	UCHAR16[3]	—
143	33	READ-ONLY	Boot Version	0x004E	UCHAR16[5]	—
144	34	READ-ONLY	OS Version	0x0053	UCHAR16[4]	—
145	35	READ-ONLY	Daughterboard Major Version	0x0058	UINT16	—
146	36	READ-ONLY	Daughterboard Minor Version	0x0059	UINT16	—
147	37	READ-ONLY	Power On Splash Line 1	0x005A	UCHAR16[11]	—
148	38	READ-ONLY	Power On Splash Line 2	0x0156	UCHAR16[11]	—

Meter Calibration Category

Absolute Index	Relative Index	Write Access Level	Index name	MODBUS Register Address	Data Type	Static Revision
149	39	READ-ONLY	Detector Diameter	0x006F	UINT16	—
150	40	READ-ONLY	Detector Diameter Other [mm]	0x0070	UINT16	—
151	41	READ-ONLY	Detector Factor	0x0071	FLOAT32	—
152	42	READ-ONLY	Detector Offset [m/s]	0x0075	FLOAT32	—
153	43	READ-ONLY	Amplifier Factor	0x0079	FLOAT32	—
154	44	READ-ONLY	Detector Current [A]	0x007D	FLOAT32	—
155	45	SERVICE	Power Line Frequency [Hz]	0x0081	UINT16	YES
156	46	ADMIN	Excitation Frequency [Hz]	0x0082	UINT16	YES
157	47	SERVICE	Scale Factor [%]	0x010B	FLOAT32	YES

Meter Measurement Settings Category

Absolute Index	Relative Index	Write Access Level	Index name	MODBUS Register Address	Data Type	Static Revision
158	48	USER	Flow Unit	0x0083	UINT16	YES
159	49	USER	Volume Unit	0x0084	UINT16	YES
160	50	USER	Unit Multiplier	0x0085	UINT16	YES
161	51	USER	Full Scale Velocity [m/s]	0x0086	FLOAT32	YES
240	130	USER	Full Scale Flow [User Units]	0x0090	FLOAT32	YES
162	52	USER	Low Flow Cutoff [%]	0x008E	FLOAT32	YES
163	53	USER	Flow Direction	0x0092	UINT16	YES
164	54	USER	Damping Factor [s]	0x0093	UINT16	YES

Digital Input Category

Absolute Index	Relative Index	Write Access Level	Index name	MODBUS Register Address	Data Type	Static Revision
165	55	SERVICE	Digital Input: Input Operation	0x0094	UINT16	YES
166	56	READ-ONLY	Digital Input: Status	0x0155	UINT16	—

Output 1 Category

Absolute Index	Relative Index	Write Access Level	Index name	MODBUS Register Address	Data Type	Static Revision
167	57	SERVICE	Output #1: Pulses Per Unit [User Units]	0x009C	FLOAT32	YES
168	58	SERVICE	Output #1: Pulse Width [ms]	0x00A0	UINT16	YES
169	59	SERVICE	Output #1: Flow Alarm Minimum [%]	0x00A1	UINT16	YES
170	60	SERVICE	Output #1: Flow Alarm Maximum [%]	0x00A2	UINT16	YES
171	61	SERVICE	Output #1: Output Mode	0x00A3	UINT16	YES
172	62	SERVICE	Output #1: Output Operation	0x00A4	UINT16	YES

Output 2 Category

Absolute Index	Relative Index	Write Access Level	Index name	MODBUS Register Address	Data Type	Static Revision
173	63	SERVICE	Output #2: Pulses Per Unit [User Units]	0x00A9	FLOAT32	YES
174	64	SERVICE	Output #2: Pulse Width [ms]	0x00AD	UINT16	YES
175	65	SERVICE	Output #2: Flow Alarm Minimum [%]	0x00AE	UINT16	YES
176	66	SERVICE	Output #2: Flow Alarm Maximum [%]	0x00AF	UINT16	YES
177	67	SERVICE	Output #2: Output Mode	0x00B0	UINT16	YES
178	68	SERVICE	Output #2: Output Operation	0x00B1	UINT16	YES

Output 3 Category

Absolute Index	Relative Index	Write Access Level	Index name	MODBUS Register Address	Data Type	Static Revision
179	69	SERVICE	Output #3: Full Scale Frequency [Hz]	0x00B2	UINT16	YES
180	70	SERVICE	Output #3: Flow Alarm Minimum [%]	0x00B3	UINT16	YES
181	71	SERVICE	Output #3: Flow Alarm Maximum [%]	0x00B4	UINT16	YES
182	72	SERVICE	Output #3: Output Mode	0x00B5	UINT16	YES
183	73	SERVICE	Output #3: Hardware Select	0x00B6	UINT16	YES
184	74	SERVICE	Output #3: Output Operation	0x00B7	UINT16	YES

Output 4 Category

Absolute Index	Relative Index	Write Access Level	Index name	MODBUS Register Address	Data Type	Static Revision
185	75	SERVICE	Output #4: Flow Alarm Minimum [%]	0x00B8	UINT16	YES
186	76	SERVICE	Output #4: Flow Alarm Maximum [%]	0x00B9	UINT16	YES
187	77	SERVICE	Output #4: Output Mode	0x00BA	UINT16	YES
188	78	SERVICE	Output #4: Hardware Select	0x00BB	UINT16	YES
189	79	SERVICE	Output #4: Output Operation	0x00BC	UINT16	YES

Port A DiagnosticCounters Category

Absolute Index	Relative Index	Write Access Level	Index name	MODBUS Register Address	Data Type	Static Revision
190	80	READ-ONLY	Port A: Packets Processed	0x00BD	UINT16	—
191	81	READ-ONLY	Port A: Broadcast Packets	0x00BE	UINT16	—
192	82	READ-ONLY	Port A: CRC Errors	0x00BF	UINT16	—
193	83	READ-ONLY	Port A: Packets Received	0x00C0	UINT16	—
194	84	READ-ONLY	Port A: Packets Sent	0x00C1	UINT16	—
195	85	READ-ONLY	Port A: Parity Errors	0x00C2	UINT16	—
196	86	READ-ONLY	Port A: Framing Errors	0x00C3	UINT16	—
197	87	READ-ONLY	Port A: Overrun Errors	0x00C4	UINT16	—
198	88	READ-ONLY	Port A: Break Detects	0x00C5	UINT16	—

Port B Diagnostic Counters Category

Absolute Index	Relative Index	Write Access Level	Index name	MODBUS Register Address	Data Type	Static Revision
199	89	READ-ONLY	Port B: Packets Processed	0x00C6	UINT16	—
200	90	READ-ONLY	Port B: Broadcast Packets	0x00C7	UINT16	—
201	91	READ-ONLY	Port B: CRC Errors	0x00C8	UINT16	—
202	92	READ-ONLY	Port B: Packets Received	0x00C9	UINT16	—
203	93	READ-ONLY	Port B: Packets Sent	0x00CA	UINT16	—
204	94	READ-ONLY	Port B: Parity Errors	0x00CB	UINT16	—
205	95	READ-ONLY	Port B: Framing Errors	0x00CC	UINT16	—
206	96	READ-ONLY	Port B: Overrun Errors	0x00CD	UINT16	—
207	97	READ-ONLY	Port B: Break Detects	0x00CE	UINT16	—

Meter Diagnostic Counters Category

Absolute Index	Relative Index	Write Access Level	Index name	MODBUS Register Address	Data Type	Static Revision
208	98	READ-ONLY	Power Up Counter	0x00F5	UINT16	—
209	99	READ-ONLY	Detector Error Counter	0x00F6	UINT16	—
210	100	READ-ONLY	Empty Pipe Counter	0x00F7	UINT16	—
211	101	READ-ONLY	Full Scale Counter	0x00F8	UINT16	—
212	102	READ-ONLY	Totalizer Overflow Counter	0x00F9	UINT16	—
213	103	READ-ONLY	Pulse Sync Counter	0x00FC	UINT16	—
214	104	READ-ONLY	ADC Interrupt Counter	0x00FD	UINT16	—
215	105	READ-ONLY	ADC Range Counter	0x00FE	UINT16	—
216	106	READ-ONLY	WDT Resets Counter	0x00FF	UINT16	—
217	107	READ-ONLY	WDT Location	0x0100	UINT16	—
218	108	READ-ONLY	System Error #	0x0101	UINT16	—
219	109	READ-ONLY	Meter Status	0x0106	UINT16	—
220	110	READ-ONLY	Action Request Overflows	0x0109	UINT16	—
221	111	READ-ONLY	Measurement Overflows	0x010A	UINT16	—
222	112	READ-ONLY	Remote Resets	0x0154	UINT16	—

Miscellaneous Category

Absolute Index	Relative Index	Write Access Level	Index name	MODBUS Register Address	Data Type	Static Revision
223	113	USER	Display Backlight Mode	0x010F	UINT16	YES
224	114	SERVICE	Preset Batch Amount [m ³]	0x0110	FLOAT32	YES
225	115	USER	Menu Language Setting	0x0114	UINT16	YES

Empty Pipe Category

Absolute Index	Relative Index	Write Access Level	Index name	MODBUS Register Address	Data Type	Static Revision
226	116	READ-ONLY	Empty Pipe Actual Resistance [Ohms]	0x011A	FLOAT32	—
227	117	ADMIN	Empty Pipe Calibration [Volts]	0x011E	FLOAT32	YES
228	118	READ-ONLY	Empty Pipe Measure Value [Volts]	0x0120	FLOAT32	—
229	119	ADMIN	Full Pipe Calibration [Volts]	0x0122	FLOAT32	YES
230	120	SERVICE	Empty Pipe Mode	0x0124	UINT16	YES

Control Commands Category

Absolute Index	Relative Index	Write Access Level	Index name	MODBUS Register Address	Data Type	Static Revision
231	121	SERVICE	Flow Simulation	0x012A	SINT16	YES
236	126	SERVICE	Command Action Request	0x0125	UINT16	YES

Security Category

Absolute Index	Relative Index	Write Access Level	Index name	MODBUS Register Address	Data Type	Static Revision
237	127	READ-ONLY	Security Status	0x011C	UINT8	—
238	128	READ-ONLY	Access Level	0x011C	UINT8	—
239	129	READ-ONLY	Display Active	0x011D	UINT8	—
241	131	READ-ONLY	Random Value	0x012B	UINT32	—
233	123	NONE	Remote Login	0x012F	UINT32	—

Analog Input Functional Block

The Analog Input (AI) function block has a single fixed channel. This fixed channel associates with the Flow Rate [User Units] parameter. The AI function block operates in modes controlled by a state machine. The modes determine the output (that is, OUT) from the function block. The following modes are supported:

Mode	Output from Function Block	Mode Coding (Hexadecimal)
Out of Service	Last output value (when resource states shows a HW Failure).	0x80
Manual	Output value set by operator.	0x10
Auto	Output value is calculated from the function block input. (The input may be set by the operator when in simulation).	0x08

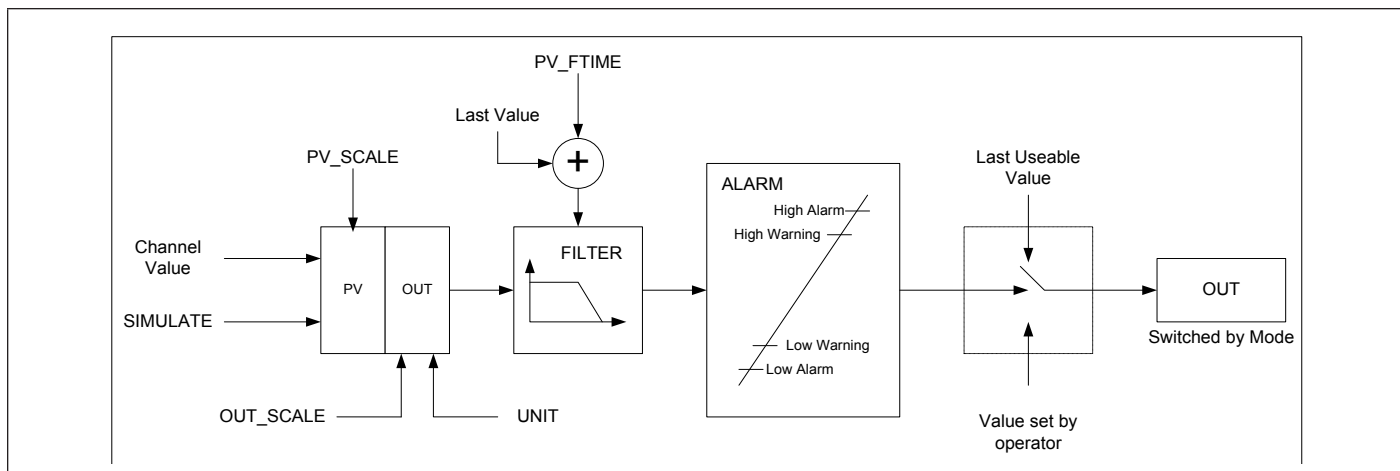

Figure 6: Analog Input Function Block Structure

NOTE: PV_SCALE, PV_FTME, OUT_SCALE, UNIT and SIMULATE are programmable function block parameters within the analog input function block.

The input to the function block is normally taken from an index in the transducer block and is determined by the CHANNEL parameter (fixed) of Analog Input function block. However, if the operator enables the simulate function, the input value is taken from the SIMULATE parameter.

In addition, the operator may choose to scale the output into another unit compared to what is given by the measurement (PV). Normally the OUT value will be given in either % or in the unit of measurement of PV. The scaling is linear and is made between the PV upper/lower range and the OUT upper/lower range.

IMPORTANT

*The PV unit is fixed to the meter's selected flow unit.
Changing the meter's flow units will change the PV unit.
After changing the flow unit, review the scaling parameters of the OUT value.*

The output from the Analog Input function block is the OUT parameter. The source for the output is determined by the mode of the function block. The function block is executed as normal in AUTO mode and the function block execution generates the OUT value. In Out-of-Service mode, the function block execution is stopped and the OUT value remains at the last usable value. In manual mode, the operator may write directly to the OUT value and force the output to a value.

A first order low-pass filter may be used. PV_FTME is the damping factor of the filter. This value represents the time when the OUT value has reached 63% of the final value after an input step.

There are four configurable alarm levels: Low Alarm, Low Warning, High Alarm, and High Warning. When the OUT value has exceeded one of the alarm levels, then the status of the OUT value is changed to signal the event.

The output value (OUT) consists of 5 bytes: a 4 byte float value (defined according to IEEE Standard 745) followed by a 1 byte status value.

IMPORTANT

*The only way to check the quality of the transmitted measured values is to monitor the status value.
A value will be transmitted even if the status of the measurement value is bad or uncertain.*

The supported status values are described in the following table.

Quality		Quality Substatus				Alarm Limits		Description	Special Notes
Bit 7	Bit 6	Bit 5	Bit 4	Bit 3	Bit 2	Bit 1	Bit 0		
0	0	0	0	1	0	—	—	Bad – Not Connected	The PROFIBUS DP daughterboard is powered up without connection to the M2000.
—	—	0	0	1	1	—	—	Bad – Device Failure	The resource block is failing.
—	—	0	1	0	0	—	—	Bad – Sensor Failure	No sensor value has been received for the last 5 MODBUS requests.
—	—	0	1	1	1	—	—	Bad – Out of Service	Analog Input Function Block is in Out-of-Service mode for other reasons than resource block failure.
0	1	0	0	0	1	—	—	Uncertain – Last Usable Value	No update from MODBUS over the last 3 updates.
1	0	0	0	0	0	—	—	Good – Non Cascade (Value OK)	—
—	—	0	0	1	0	0	0	Good – No Alarm (Priority < 8)	—
—	—	—	—	—	—	0	1	Good – Low Limit Warning	—
—	—	—	—	—	—	1	0	Good – High Limit Warning	—
—	—	—	—	—	—	1	1	Good – Constant Output	—
—	—	0	0	1	1	0	1	Good – Low Limit Alarm	—
—	—	—	—	—	—	1	0	Good – High Limit Alarm	—

COMPLIANCE



Certificate

PROFIBUS Nutzerorganisation e.V. grants to
Badger Meter Europa
Nürtinger Str. 76, 72639 Neuffen, Germany

the Certificate No: **Z01692** for the PROFIBUS Device:

Model Name: M2000
Revision: 1; SW/FW: V1.17; HW: Rev 1
GSD: BD020D01.GSD, File Version: 1.0
PA039700.GSD

This certificate confirms that the product has successfully passed the certification tests with the following scope:

<input checked="" type="checkbox"/>	DP-V0	MS0, Set_Slave_Add
<input checked="" type="checkbox"/>	DP-V1	MS2, Prm_Block_Structure
<input checked="" type="checkbox"/>	Profile	PROFIBUS PA 3.02
<input checked="" type="checkbox"/>	Physical Layer	RS485

Test Report Number: **PCN166-PAS-01**
 Authorized Test Laboratory: **PROCENEC, Wateringen, The Netherlands**

The tests were executed in accordance with the following documents:
 "Test Specifications for PROFIBUS DP Slaves, Version 3.0.9, September 2008" and
 "Test Specifications for PROFIBUS PA Devices (Profile 3.02), Version 5.0.4, February 2010".

This certificate is granted according to the document:
 "Framework for testing and certification of PROFIBUS and PROFINET products".

For all products that are placed in circulation by May 10, 2015 the certificate is valid for life.

Board of PROFIBUS Nutzerorganisation e. V.

 (Official in Charge)

 (Karsten Schneider)

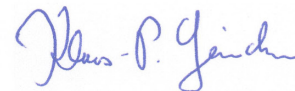

 (K.-P. Lindner)

INTENTIONAL BLANK PAGE

INTENTIONAL BLANK PAGE

INTENTIONAL BLANK PAGE

Control. Manage. Optimize.

M-SERIES is registered trademark of Badger Meter, Inc. Other trademarks appearing in this document are the property of their respective entities. Due to continuous research, product improvements and enhancements, Badger Meter reserves the right to change product or system specifications without notice, except to the extent an outstanding contractual obligation exists. © 2015 Badger Meter, Inc. All rights reserved.

www.badgermeter.com

The Americas | Badger Meter | 4545 West Brown Deer Rd | PO Box 245036 | Milwaukee, WI 53224-9536 | 800-876-3837 | 414-355-0400
México | Badger Meter de las Americas, S.A. de C.V. | Pedro Luis Ogazón N°32 | Esq. Angelina N°24 | Colonia Guadalupe Inn | CP 01050 | México, DF | México | +52-55-5662-0882
Europe, Middle East and Africa | Badger Meter Europa GmbH | Nurtinger Str 76 | 72639 Neuffen | Germany | +49-7025-9208-0
Europe, Middle East Branch Office | Badger Meter Europe | PO Box 341442 | Dubai Silicon Oasis, Head Quarter Building, Wing C, Office #C209 | Dubai / UAE | +971-4-371 2503
Czech Republic | Badger Meter Czech Republic s.r.o. | Mařikova 2082/26 | 621 00 Brno, Czech Republic | +420-5-41420411
Slovakia | Badger Meter Slovakia s.r.o. | Racianska 109/B | 831 02 Bratislava, Slovakia | +421-2-44 63 83 01
Asia Pacific | Badger Meter | 80 Marine Parade Rd | 21-06 Parkway Parade | Singapore 449269 | +65-63464836
China | Badger Meter | 7-1202 | 99 Hangzhong Road | Minhang District | Shanghai | China 201101 | +86-21-5763 5412