



Artisan Technology Group is your source for quality new and certified-used/pre-owned equipment

- FAST SHIPPING AND DELIVERY
- TENS OF THOUSANDS OF IN-STOCK ITEMS
- EQUIPMENT DEMOS
- HUNDREDS OF MANUFACTURERS SUPPORTED
- LEASING/MONTHLY RENTALS
- ITAR CERTIFIED SECURE ASSET SOLUTIONS

SERVICE CENTER REPAIRS

Experienced engineers and technicians on staff at our full-service, in-house repair center

*InstraView*SM REMOTE INSPECTION

Remotely inspect equipment before purchasing with our interactive website at www.instraview.com ↗

WE BUY USED EQUIPMENT

Sell your excess, underutilized, and idle used equipment. We also offer credit for buy-backs and trade-ins. www.artisanng.com/WeBuyEquipment ↗

LOOKING FOR MORE INFORMATION?

Visit us on the web at www.artisanng.com ↗ for more information on price quotations, drivers, technical specifications, manuals, and documentation

Contact us: (888) 88-SOURCE | sales@artisanng.com | www.artisanng.com



DI-700

Software-Configurable USB Recording Instrument

User's Manual

Manual Revision E
Software Release Level 1

Copyright © 2004 by DATAQ Instruments, Inc. The Information contained herein is the exclusive property of DATAQ Instruments, Inc., except as otherwise indicated and shall not be reproduced, transmitted, transcribed, stored in a retrieval system, or translated into any human or computer language, in any form or by any means, electronic, mechanical, magnetic, optical, chemical, manual, or otherwise without expressed written authorization from the company. The distribution of this material outside the company may occur only as authorized by the company in writing.

DATAQ Instruments' hardware and software products are not designed to be used in the diagnosis and treatment of humans, nor are they to be used as critical components in any life-support systems whose failure to perform can reasonably be expected to cause significant injury to humans.



241 Springside Dr.
Akron, Ohio 44333 USA
www.dataq.com
Telephone: 330/668-1444
Fax: 330/666-5434

Designed and manufactured in the
United States of America

Warranty and Service Policy

Product Warranty

DATAQ Instruments, Inc. warrants that this hardware will be free from defects in materials and workmanship under normal use and service for a period of one year from the date of shipment. DATAQ Instruments' obligations under this warranty shall not arise until the defective material is shipped freight prepaid to DATAQ Instruments. The only responsibility of DATAQ Instruments under this warranty is to repair or replace, at its discretion and on a free of charge basis, the defective material.

This warranty does not extend to products that have been repaired or altered by persons other than DATAQ Instruments employees, or products that have been subjected to misuse, neglect, improper installation, or accident.

DATAQ Instruments shall have no liability for incidental or consequential damages of any kind arising out of the sale, installation, or use of its products.

Service Policy

1. All products returned to DATAQ Instruments for service, regardless of warranty status, must be on a freight-prepaid basis.
2. DATAQ Instruments will repair or replace any defective product within 5 days of its receipt.
3. For in-warranty repairs, DATAQ Instruments will return repaired items to the buyer freight prepaid. Out of warranty repairs will be returned with freight prepaid and added to the service invoice.

Table of Contents

Warranty and Service Policy	iii
1. Introduction	1
Features	1
Analog Input	1
Digital Input and Output	1
2. Specifications.	3
Signal Connections	3
Interface Characteristics	3
Analog Inputs	3
Digital Input/Output	3
Input Scan List	3
On-board Micro Controller	4
Physical/Environmental	4
3. Getting Started	5
Unpacking	5
Connecting the DI-700 Instrument to your Computer and Installing the Driver	5
DI-700 Instrument Controls and Indicators	7
Instrument Rear Panel	7
Instrument Front Panel	8
4. Accessories	9
The DI-705: Signal Input/Output Option	9
General	9
Input Signal Configuration	9
The DI-75B: 5B Module Expander	9
CABL-4: Female 37-pin “D” to 16 BNC Connectors	9
CABL-5: Male to Female 37-pin “D”	10
5. Block Diagram	11

1. Introduction

Congratulations on your purchase of the DI-700 data acquisition instrument. It permits data acquisition through the USB port on IBM personal computers and compatibles running Windows 98 Operating System or higher.

This manual describes how to connect and use the DI-700. It does not describe any software in detail other than the installation software.

Features

The DI-700 provides the following features:

- It connects to the USB port of any desktop, transportable, notebook, or laptop PC-compatible computer.
- Per channel software-configurable settings:
 - Single-ended or differential input.
 - Input gain.
- Power is derived from the USB port, no external power is required.
- 975 samples/second maximum sampling rate.
- 16-bit A/D converter, for high resolution measurement accuracy.
- 16-entry input scan list allows you to scan any sequence of input channels at any available gain.

The following provides a brief overview of the major subsystems of the DI-700:

Analog Input

16 single-ended or 8 differential analog inputs allow your analog signals to be converted into 16-bit digital data via the onboard A/D converter.

The DI-700 features the following software-programmable input measurement ranges:

<u>PGL Models</u>	<u>PGH Models</u>
±10V full scale measurement range at a gain of 1	±10V full scale measurement range at a gain of 1
±1V full scale measurement range at a gain of 10	±5V full scale measurement range at a gain of 2
±100mV full scale measurement range at a gain of 100	±2.5V full scale measurement range at a gain of 4
±10mV full scale measurement range at a gain of 1000	±1.25V full scale measurement range at a gain of 8

Digital Input and Output

The DI-700 contains 8 input and 8 output lines for input/output operations. These lines provide an interface for the transfer of data between user memory and a peripheral device connected to the instrument. Digital inputs can monitor alarms or sensors with TTL outputs, while digital outputs can drive TTL inputs on control or measurement equipment.

2. Specifications.

Signal Connections

Signal connections are made directly to the 37-pin, D-type connector on the front panel of the instrument. Signal connections can also be made with the DI-705, which is an optional, screw terminal signal interface that plugs into the 37-pin connector and allows you to connect bare-wire analog input signals to the DI-700. Refer to chapter 5 Accessories in this manual for complete DI-705 details. Note that the DI-705 is an extra-cost option that is not included with the purchase of a DI-700 instrument

Interface Characteristics

Compatible computer architecture: Connects to computer via the USB (universal serial bus) port.

Analog Inputs

Number of input channels:	16 single-ended, 8 differential (software selectable per channel)
Converter resolution:	16-bit
Common mode rejection ratio:	60 dB minimum, 1kW unbalance @ 60 Hz
Accuracy:	$\pm 0.25\%$ of full scale range
Crosstalk:	60 dB @ 975Hz sample rate
Sample throughput rate:	975 samples/second max
Maximum analog measurement range (software selectable per channel):	

	PGL Models:	PGH Models:
	$\pm 10\text{V}$ full scale at a gain of 1	$\pm 10\text{V}$ full scale at a gain of 1
	$\pm 1\text{V}$ full scale at a gain of 10	$\pm 5\text{V}$ full scale at a gain of 2
	$\pm 100\text{mV}$ full scale at a gain of 100	$\pm 2.5\text{V}$ full scale at a gain of 4
	$\pm 10\text{mV}$ full scale at a gain of 1000	$\pm 1.25\text{V}$ full scale at a gain of 8
Gain error	1 bit max @ 1kHz sample rate	
Input offset voltage	1 bit max @ 1kHz sample rate	
Input settling time	1ms to 0.01% at all gains	
Input impedance	1 MW	

Digital Input/Output

Capacity	8 each input and output
Compatibility	TTL compatible
Max source current	0.4mA @ 2.4V
Max sink current	7.2mA @ 1V
Digital input termination	4.7kW pull-up to +5VDC

Input Scan List

Capacity	16 elements
----------	-------------

On-board Micro Controller

Type Cypress 7C63411 @ 6MHz

Physical/Environmental

Box dimensions 4"W by 5.5"L by 1.52"H

I/O connector 37-pin male D-type

Weight 1 lb

Operating environment:

 Component temperature 0° to 70° C

 Relative humidity 0% to 90% non condensing

Storage environment:

 Temperature -55° to 150° C

 Relative humidity 0% to 90% non condensing

3. Getting Started

Unpacking

The following items are included with each DI-700 Series instrument. Verify that you have the following:

- DI-700 Series instrument
- Communications cable designed to connect the DI-700 to your computer's USB port
- The WINDAQ Resource CD-ROM
- DI-700 User's Manual (which you are currently reading)

If an item is missing or damaged, call DATAQ Instruments at (330) 668-1444. We will guide you through the appropriate steps for replacing missing or damaged items. Save the original packing material in the unlikely event that your unit must, for any reason, be sent back to DATAQ Instruments.

Connecting the DI-700 Instrument to your Computer and Installing the Driver

For a successful installation, the DI-700 requires Windows 98 or higher.

1. With your computer powered, Windows running, and all other applications closed, plug the appropriate end of the supplied USB communications cable into the USB port (labeled USB) on the rear panel of the instrument. Connect the other end of this cable to your computer's USB port.

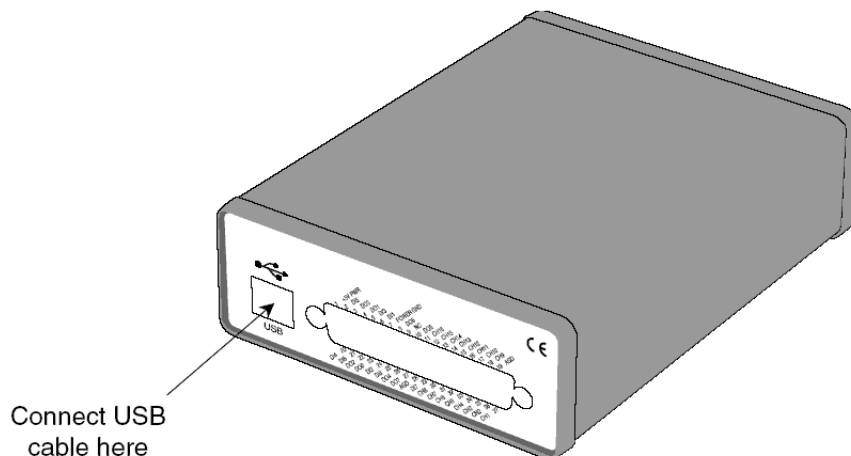

The addition of this new piece of hardware will be “sensed” by Windows and the “Found New Hardware Wizard” will automatically be launched, anticipating the installation of a device driver for the new hardware.

2. Insert *The WINDAQ Resource* CD-ROM into your CD-ROM drive. It contains the device driver and all other files necessary to operate the DI-700. If your Windows autoplay feature is enabled, the WINDAQ Software Installation will start automatically. Click on the Exit button as we will not be installing the software yet.
3. From the initial “Found New Hardware Wizard” screen click on the option “Install the software automatically (Recommended)” radio button and click Next.

4. The Files Needed dialog box opens allowing you to select origination of the DI-700 Driver. Make sure your CD-ROM drive is selected and click Next. The Driver installs automatically.
5. After the Driver is installed, click Finish to close the Found New Hardware Wizard. Windows should prompt you that the device has been installed properly. Now you can install the acquisition software (WINDAQ/Lite).
6. Re-insert the WINDAQ Resource CD for the autoplay feature to run or run the Setup application located on your CD.
7. In the “What do you want to do?” window, select “Install Software for all other products except Starter Kits” and click OK.
8. In the “Specify the Product” window, select “WINDAQ/Lite, WWB, and Software Development Kit” and click OK.
9. In the “Specify the Instrument” window, select “DI-700 USB Unit” and click OK.
10. In the Welcome window, click “OK” to start the installation or “Abort” to cancel.
11. Read the License Agreement. If you accept the terms, click “Accept and Continue.” If you choose not to accept, this will end the installation.
12. After accepting the License Agreement, the Registration Information dialog box appears. Enter your Name and Company in the appropriate text boxes and click on OK. Verify the information is correct and click Yes.
13. The Select Destination Dialog Box appears allowing you to specify the directory where you want to install your WINDAQ software. We recommend you accept the default path, but you can name this new directory anything you like. Simply substitute the desired drive and directory in the “Destination Directory:” text box or click on the desired folder. If the directory already exists, WINDAQ Installation Software will prompt you to verify the location. If you are sure about the location click on Yes. If you would like to change the location click on No and you will return to the Select Destination Dialog Box.
14. After you have chosen your file destination, the “Make Backups?” dialog box is displayed asking if you would like to make backup copies of all files replaced during the installation. This is offered as a safety courtesy, backup copies are not required. Choose the No button if you don't want to make backups. Choose the Yes button to create backups. If you decide to create backups, you will be prompted to specify a backup file directory.
15. After you have chosen to make backups or not, the Select Program Manager Group appears allowing you to specify a destination (or group window) in the Start Menu for WINDAQ software icons. The default path is recommended, but you can specify any group window you like.
16. The ID address dialog box allows you to specify the ID address of your DI-700 device. This is important only when installing multiple devices. Every DI-700 is initially assigned an ID address of “0.” If you are adding only one DI-700 to your system, accept the default ID address of 0 and click on “OK.” If you are adding multiple DI-700s to your system, you must change subsequent DI-700 device ID addresses so that each instrument has a unique ID address on your system.

NOTE: When installing more than one DI-700 on your system, you must configure each instrument's ID address and run the installation program (starting with step 6) for each device. Simply select the same destination directory (step 13) when re-running the installation program for subsequent DI-700s. The installation program will create a WINDAQ software shortcut with unique DLL information for each instrument. The installation program will NOT install multiple instances of WINDAQ software.

ID addresses are changed by opening the DI-700 case and re-configuring the device ID jumpers as shown in the following illustration:

To gain access to ID jumpers:

1. Remove two screws
2. Remove end panel.
3. Slide cover back.

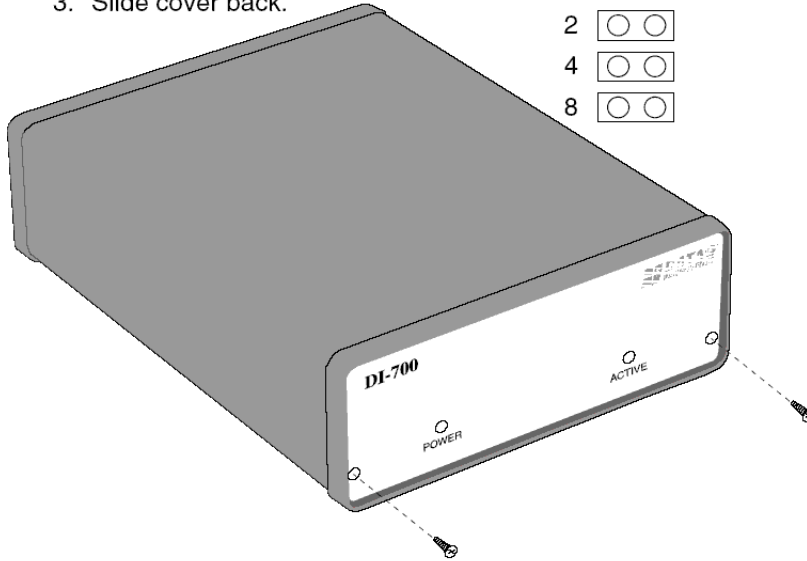
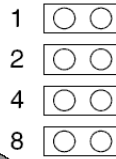
Device ID jumpers
(ID address 0 shown)DI-700 ID addresses

- 0 = All jumpers installed
- 1 = Jumper 1 removed
- 2 = Jumper 2 removed
- 3 = Jumpers 1 & 2 removed
- 4 = Jumper 4 removed
- 5 = Jumpers 1 & 4 removed
- 6 = Jumpers 2 & 4 removed
- 7 = Jumpers 1, 2, & 4 removed
- 8 = Jumper 8 removed
- 9 = Jumpers 1 & 8 removed
- 10 = Jumpers 2 & 8 removed
- 11 = Jumpers 1, 2, & 8 removed
- 12 = Jumpers 4 & 8 removed
- 13 = Jumpers 1, 4, & 8 removed
- 14 = Jumpers 2, 4, & 8 removed
- 15 = All jumpers removed

17. After WINDAQ Software installs, the Advanced CODAS Analysis Systems dialog box appears prompting you to install the CODAS software. If you purchased this software click on Yes. If you did not - click on No. The Make Backup? box appears again allowing you the option of creating backups for files replaced during installation. Click on Yes to make backups or No not to. Installation is complete - you will now see a Successful Installation box - click on OK to exit WINDAQ Installation software. If you are installing multiple devices, change the Device ID address of each and run steps 6 through 17 for each device.
18. To run WINDAQ/Lite or WINDAQ Waveform Browser go to the appropriate icon group in your Start Menu and double-click on the program you would like to run.

DI-700 Instrument Controls and Indicators

The following describes the user accessible items on the DI-700 instrument.

Instrument Rear Panel

The 37-pin male “D” connector is used to interface analog input channels 1 through 16, eight digital inputs, and eight digital outputs to the instrument. The analog inputs are labeled CH1 through CH16, the digital inputs are labeled DI0 through DI7, and the digital outputs are labeled DO0 through DO7. Other items include two analog grounds labeled AGD.

DI-700 Series instruments can accept 16 analog inputs in single-ended configuration or 8 analog inputs in differential configuration. Single-ended inputs are configured by connecting one signal lead to the desired channel and the other signal lead to analog ground (AGD) as shown in the following illustration.

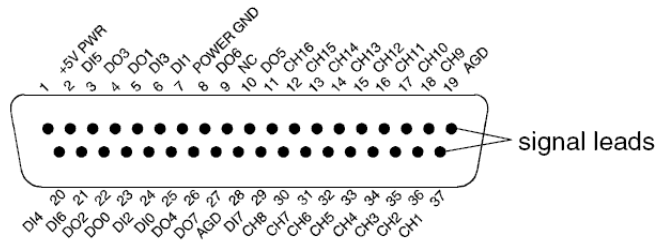

Channel 1 configured for single-ended operation

Differential inputs occupy two channels (i.e., these channel pairs constitute a differential input: 1 and 9, 2 and 10, 3 and 11, 4 and 12, 5 and 13, 6 and 14, 7 and 15, 8 and 16, etc.), with the lowest numbered channel in the pair assuming the positive (+) input and the channel number. For example, say we have channels 2 and 10 configured as a differential input. Channel 2 is the positive (+) input, channel 10 is the negative (-) input, and the pair is referred to as “channel 2 differential.” The following illustration shows channels 2 and 10 configured as a differential input:

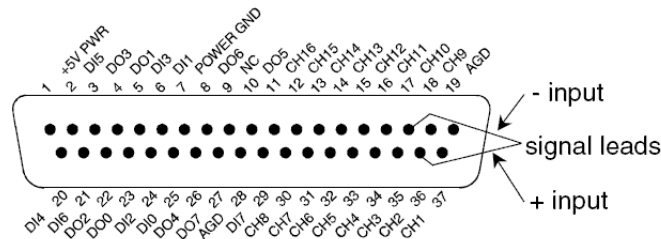

Channel 2 configured for differential operation

Pinout is as follows:

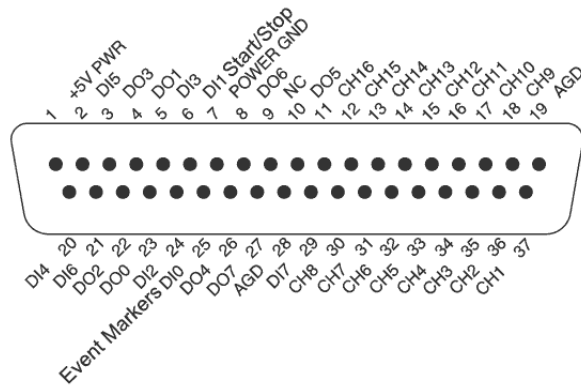

Instrument Front Panel

The front panel consists of two LED indicators:

- ACTIVE This indicator glows red whenever the DI-700 instrument is actively scanning. This includes all digital input/output and analog input activity.
- POWER This indicator glows green when power is applied to the instrument.

4. Accessories

This section describes hardware products that may be used with DI-700 instruments. Contact DATAQ Instruments for information on the latest available accessories.

The DI-705: Signal Input/Output Option

General

The DI-705 is a screw terminal signal interface that provides a convenient way to interface analog input and digital input/output signals to the DI-700. It plugs into the 37-pin “D” connector on the DI-700 and provides signal access through screw terminal strips. The terminal strips accept 16-22 gauge wire and each screw terminal is silk screened with the corresponding “D” connector pin number. The DI-705 also features a 37-pin male “pass-through” connector, which allows you to connect our BNC cable (model number CABL-4), or our DI-75B, or any 37-pin DAS-16 compatible cable to the DI-700 while still allowing screw terminal access.

Input Signal Configuration

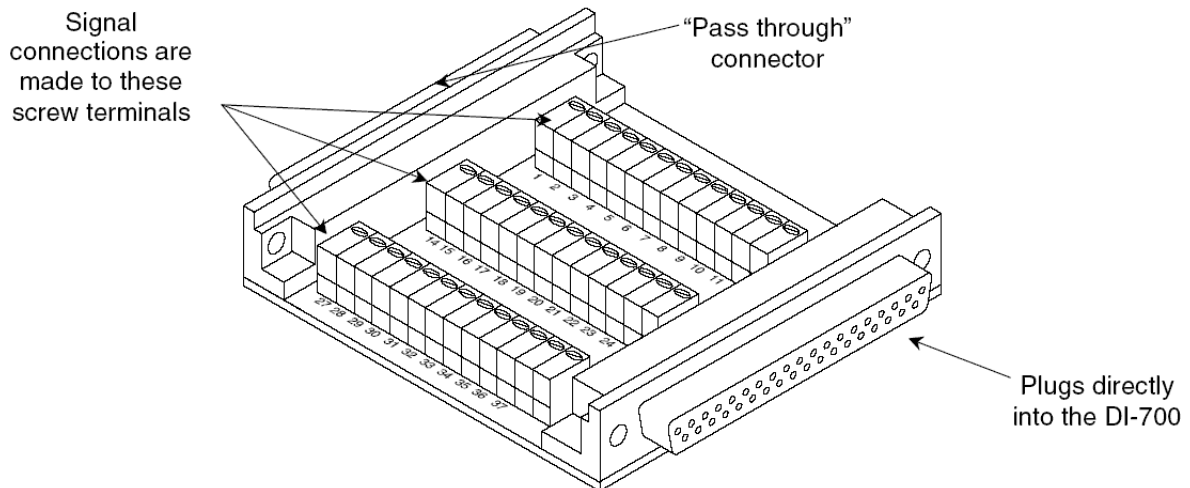

Any combination of single-ended or differential channels may be connected to the DI-705, but keep in mind a differential channel uses two analog inputs. Configure single-ended and differential channels on the DI-705 the same way as on the DI-700. Refer to the paragraph titled “DI-700 Instrument Controls and Indicators” in the Getting Started section of this manual for single-ended/differential configuration details.

The DI-75B: 5B Module Expander

The DI-75B is an eight-channel expansion instrument that allows you to make isolated industrial measurements with the DI-700. Each DI-75B measures 9"L × 7.29"W × 2.7"H and accepts up to eight 5B style signal conditioning modules to bring thermocouple, true rms, voltage, strain, frequency, process current, RTD, potentiometer, and DC transducer measurement capability to the DI-700, in any combination suitable for your application.

CABL-4: Female 37-pin “D” to 16 BNC Connectors

CABL-4 is an interface cable that allows you to use the DI-700 with any device that uses BNC-style connectors. CABL-4 features a 37-pin female “D” connector on one end that mates directly with the DI-700 and 16 BNC connectors on the other, each individually labeled.

CABL-5: Male to Female 37-pin “D”

Instead of directly connecting the DI-705 to your DI-700 instrument, six-foot long CABL-5 can be used between them to allow more accessibility when connecting your input signals to the DI-705.

5. Block Diagram

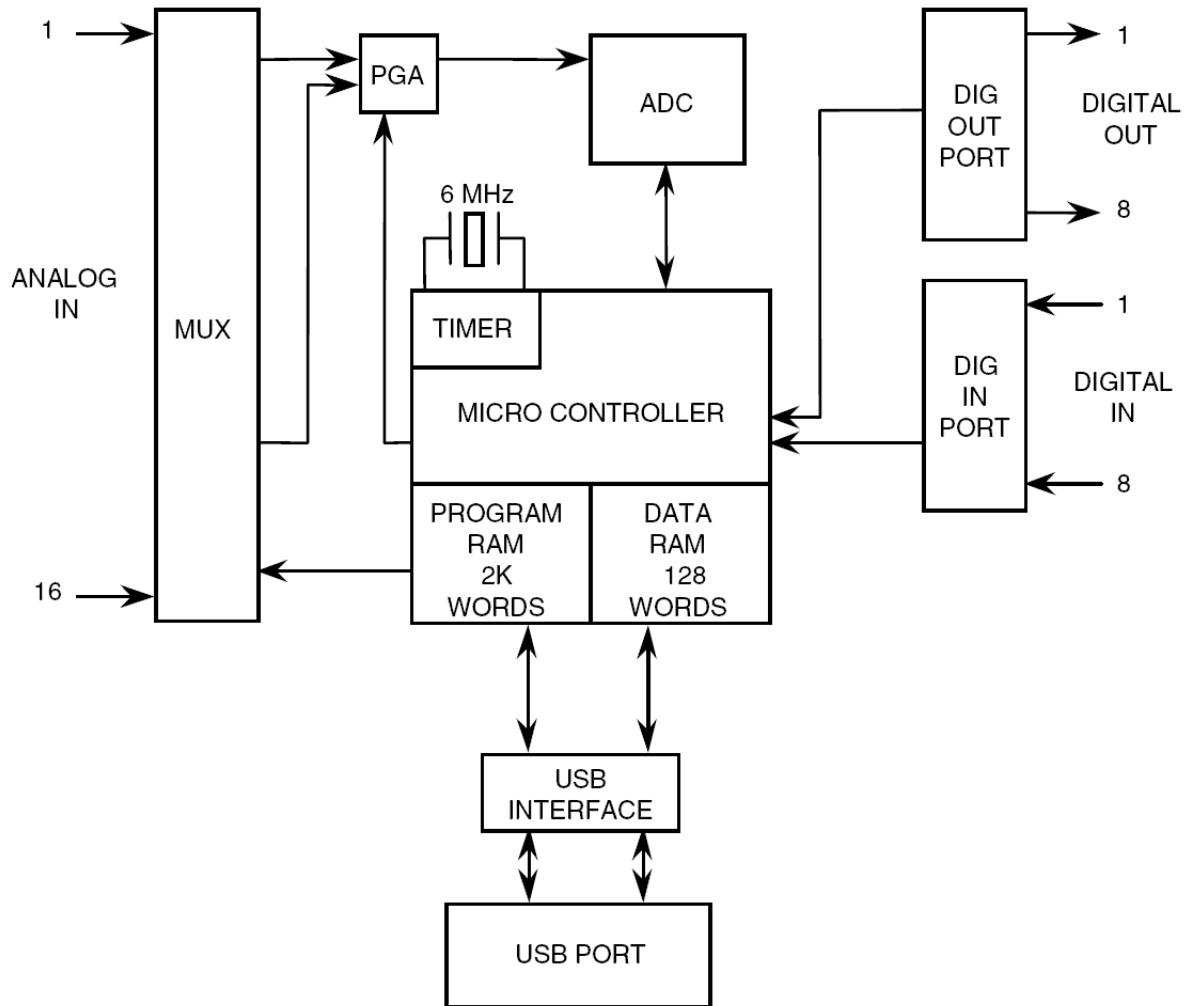



DATAQ Instruments, Inc.
241 Springside Drive
Akron, Ohio 44333
Telephone: 330-668-1444
Fax: 330-666-5434
E-mail: support@dataq.com

Direct Product Links

(click on text to jump to page)

[Data Acquisition](#) | [Data Logger](#) | [Chart Recorder](#) | [Thermocouple](#) | [Oscilloscope](#)



Artisan Technology Group is your source for quality new and certified-used/pre-owned equipment

- FAST SHIPPING AND DELIVERY
- TENS OF THOUSANDS OF IN-STOCK ITEMS
- EQUIPMENT DEMOS
- HUNDREDS OF MANUFACTURERS SUPPORTED
- LEASING/MONTHLY RENTALS
- ITAR CERTIFIED SECURE ASSET SOLUTIONS

SERVICE CENTER REPAIRS

Experienced engineers and technicians on staff at our full-service, in-house repair center

*InstraView*SM REMOTE INSPECTION

Remotely inspect equipment before purchasing with our interactive website at www.instraview.com ↗

WE BUY USED EQUIPMENT

Sell your excess, underutilized, and idle used equipment. We also offer credit for buy-backs and trade-ins. www.artisanng.com/WeBuyEquipment ↗

LOOKING FOR MORE INFORMATION?

Visit us on the web at www.artisanng.com ↗ for more information on price quotations, drivers, technical specifications, manuals, and documentation

Contact us: (888) 88-SOURCE | sales@artisanng.com | www.artisanng.com