

Hydra

user manual



Dimensions

All dimensions are in millimeters

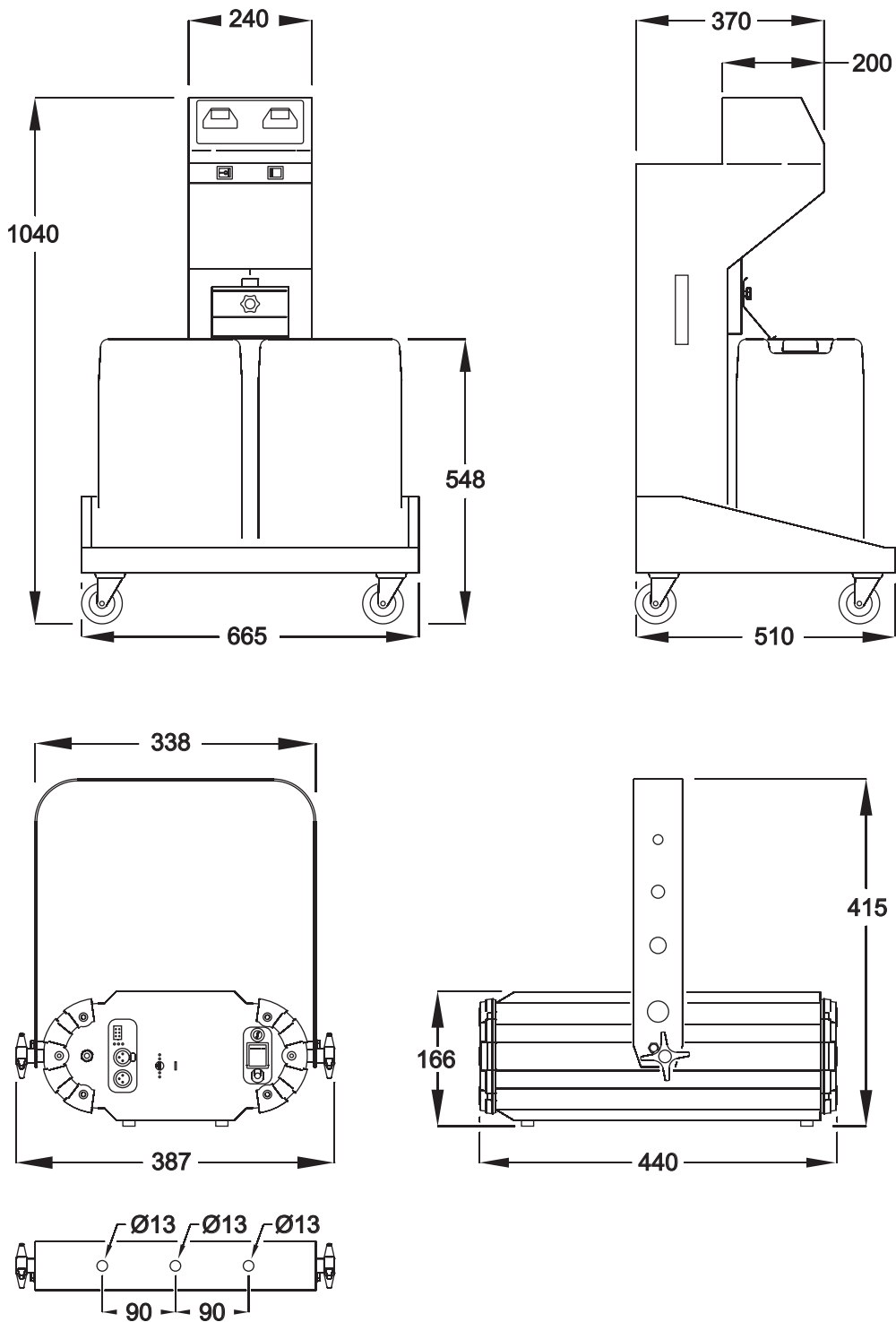

©2006 Martin Professional A/S.

All rights reserved. No part of this manual may be reproduced, in any form or by any means, without permission in writing from Martin Professional A/S, Denmark. Information subject to change without notice. Martin Professional A/S and all affiliated companies disclaim liability for any injury, damage, direct or indirect loss, consequential or economic loss or any other loss occasioned by the use of, inability to use or reliance on the information contained in this manual.

P/N 35000194, Rev. C

Safety information

The following symbols are used to identify important safety information:



Caution! Safety hazard. Risk of personal injury.



Caution! Burn hazard. Hot surface. Do not touch.



Danger! Hazardous voltage. Contact will cause electric shock.



Caution! Fire hazard.



Warning! This product is not for household use. It presents risks of injury due to electric shock, burns, falls and respiratory problems!

Read this manual before operating the machine, follow the safety precautions listed below, and observe all warnings in this manual and printed on the base unit and smoke heads. Use the system only as described in this manual and in accordance with local laws and regulations.

If you have questions about how to operate the machine safely, or if you have followed the instructions in this manual and the machine is malfunctioning, please contact Jem Service.



Preventing electric shocks

- Always ground (earth) the machine electrically.
- Use only a source of AC power that complies with local building and electrical codes, and that has both overload and ground-fault protection.
- Before connecting the Hydra to power, check that the voltage indicated on the machine's serial label matches your local AC power voltage. If your AC power voltage does not match, do not use the machine. Contact Jem Service for assistance.
- Before using the machine, check that all power distribution equipment and cables are in perfect condition and rated for the current requirements of all connected devices.
- If the machine or any cables connected to it are in any way damaged, defective, wet, or show signs of overheating, stop using the machine and contact Jem Service for assistance.
- Disconnect the machine from AC power before servicing and when not in use.
- This system is not waterproof and should not be exposed to wet outdoor conditions. Do not immerse in water or any other liquid. Do not expose to high-pressure water jets.
- Do not spill fluid over the base or smoke heads. If fluid is spilled, disconnect AC power and clean with a damp cloth. If fluid is spilled onto electronic parts, take the system out of service and contact Jem for advice.
- Do not remove the covers or attempt to repair a faulty machine. Refer any service not described in this manual to Jem.
- Do not operate the machine if any parts are damaged, defective or missing.
- Moisture and electricity do not mix. Do not aim smoke output at electrical connections or devices.



Preventing burns and fire

- The smoke produced by the machine is hot enough to cause burns when it leaves the nozzle, and very hot droplets of fluid escape occasionally. Keep people and objects at least 1 meter (39 inches) away from the smoke output nozzle.
- Do not touch the smoke output nozzles during or after use – they become extremely hot and remain hot for several hours after the heads have been shut down.
- Smoke output contains glycol, a flammable alcohol that burns with an almost invisible blue flame. Do not point smoke output at sources of ignition such as open flames or pyrotechnic effects.
- Do not attempt to bypass thermostatic switches, fluid sensors or fuses.
- Replace fuses only with ones of the type and rating specified in this manual for the machine.
- Provide a minimum free space of 10 cm (4 inches) around the machine.
- Provide a minimum free space of 50 cm (20 inches) around fans and air vents and ensure free and unobstructed air flow to and around the machine.
- Keep the machine at least 60 cm (24 inches) away from combustible and heat-sensitive materials.



- Do not operate the machine if the ambient temperature (Ta) is below 5° C (41° F) or above 40° C (104° F).
- Do not operate the machine if the relative air humidity exceeds 80%.



Preventing injuries

- Ensure that the surface on which the machine is installed can safely hold the weight of the machine.
- Do not install the smoke heads over areas where people are present.
- Verify that the smoke heads' temperature setting is suitable for the type of fluid in use whenever changing fluid or resetting the default menu values.
- Smoke machines can cause condensation. Do not point the output at smooth floors. Floors and surfaces may become slippery. Check these frequently and wipe dry as necessary to avoid any danger of slipping.
- Ensure at least 2m visibility in areas where smoke is being produced.
- Smoke fluid contains food-grade glycols in solution but may present health risks if swallowed. Do not drink it. Store it securely. If eye contact occurs, rinse with water. If fluid is swallowed, give water and obtain medical advice.



Preventing breathing problems

- A smoke machine can operate safely only with the smoke fluid it is designed for. Use the machine only with fluids specified under "*Smoke fluid options*" on page 15 or you may cause the release of toxic gases, presenting a severe health hazard. You will also probably damage the machine.
- Do not create dense smoke in confined or poorly ventilated areas.
- Do not expose people with health problems (including allergic and/or respiratory conditions such as asthma) to smoke output.
- Do not point smoke output directly at a person's face or at face height.

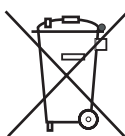

Disposing of this product

Jem products are supplied in compliance with Directive 2002/96/EC of the European Parliament and of the Council of the European Union on WEEE (Waste Electrical and Electronic Equipment), as amended by Directive 2003/108/EC, where applicable.

Help preserve the environment! Ensure that this product is recycled at the end of its life. Your supplier can give details of local arrangements for the disposal of Jem products.

Contents

Safety information	3
Product overview	7
Rear panel details	8
Introduction	9
Product description	9
Features at glance	9
Installation	10
Included items	10
Location requirements	10
Fluid line limits	10
Head location requirements	11
Base location requirements	11
Fluid line configuration	11
Fluid line components	11
Basic fluid line configuration	11
Touring fluid line configuration	11
Fluid line connections	12
Base connections	12
Tee connections	12
Head connections	12
Self-seal connections	12
Data line configuration	12
About the data line	12
Data cable	12
Hydra terminators	12
Connecting the data line	13
AC power	13
Preparing the power cords	13
Connecting to AC power	13
Head address setting	14
Physical installation	14
Installing heads	14
Fluid system	15
Smoke fluid options	15
Pro Steam Simulation	15
Regular DJ Fluid (DJ mix)	15
Pro Smoke Super (ZR mix)	15
Pro Smoke High Density (SP mix)	15
Filling the Hydra	15
Refilling or replacing empty tanks	15
Transition between fluid types	15
Control panel	16
Overview	16
Critical settings	16
Menu key	17
Enter key	17
Up/Down keys	17
Status messages	17
Left display	17
Right display	17
Menu navigation	17
FLU (fluid control) setting	18
ENC (tank selection) setting	18

<i>Hd</i> (head number) setting	18
<i>Adr</i> (DMX address) setting	18
<i>Pr i</i> (base prime) command	18
Base control menu	18
<i>Pt</i> (target pressure) setting	19
<i>P i</i> (input pressure) readout	19
<i>Po</i> (output pressure) readout	19
<i>tP</i> (pressure test time) setting	19
<i>td</i> (pump time delay) setting	19
<i>rSt</i> (reset) command	19
<i>HOt</i> (head temperature) setting	20
<i>rUn</i> (run) commands	20
<i>Fo9</i> (fog level) setting	20
<i>ton</i> (time-on) setting	20
Head control menu	20
<i>tOf</i> (time-off) setting	21
<i>ALt</i> (alternate menu) setting	21
<i>Pr i</i> (prime fluid line) command	21
<i>StA</i> (head status) readout	21
<i>rSt</i> (reset) command	21
Remote control	22
Overview	22
Functions	22
Connection	22
DMX control	23
Overview	23
DMX connection	23
DMX address and channels	23
Command values	23
Initiating DMX operation	23
General operation	24
Pre-operation checks	24
Starting the Hydra for first time	24
Normal start procedure	24
Fluid consumption	25
Generating smoke	25
Priming the fluid line	26
Shutting down the system	26
Touring with the Hydra	26
Priming the base	26
Basic service	27
Cleaning	27
Diagnosing leaks	27
Draining the fluid line	27
Fuse replacement	28
Base	28
Head	28
Annual pressure check	28
Flushing the system	28
Troubleshooting	29
System diagrams	30
Specifications	33

Product overview

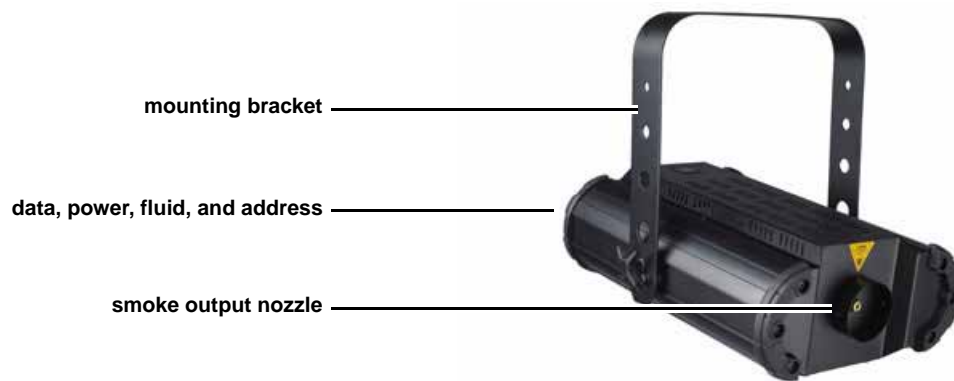

Rear panel details

Rear Panel of Base

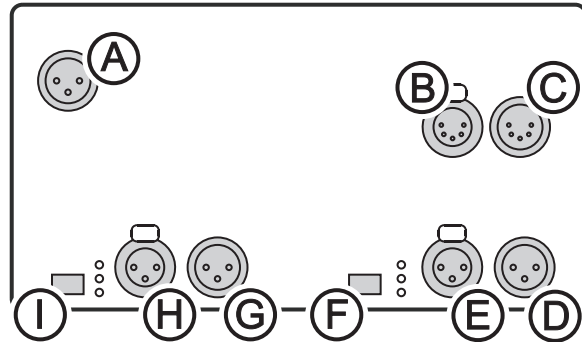

- | | |
|------------------------|----------------------------|
| A remote control input | F AVR socket (service use) |
| B 5-pin XLR DMX out | G Hydra data line in |
| C 5-pin XLR DMX in | H Hydra data line out |
| D 3-pin XLR DMX in | I AVR socket (service use) |
| E 3-pin XLR DMX out | |

Rear Panel of Head

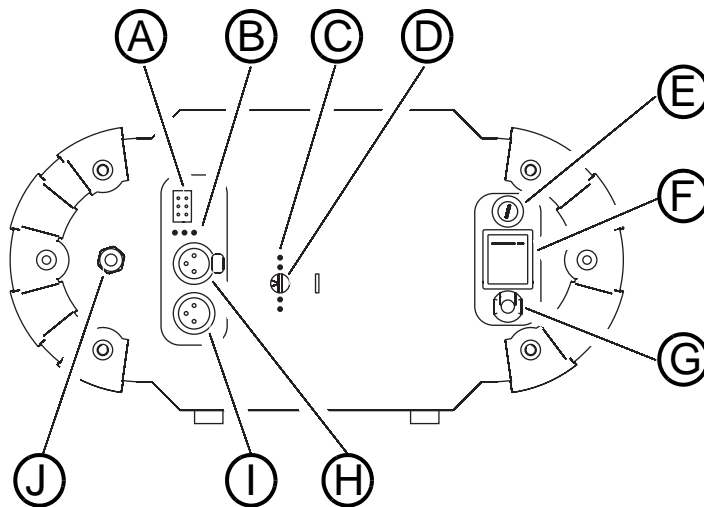

- | | |
|----------------------------|-----------------------|
| A AVR socket (service use) | F power switch |
| B update status LEDs | G power cord |
| C head status LEDs | H Hydra data line out |
| D address dial | I Hydra data line in |
| E fuse holder | J fluid inlet |

Introduction

Product description

The Hydra smoke system from Jem provides a uniquely flexible and convenient solution to a wide range of smoke requirements whether permanently installed or, with the addition of the touring accessories, taken on the road.

The Hydra system can be configured with 1 to 16 smoke heads that can be up to 150 m from the Hydra's base. Systems with less than 16 heads can be expanded at any time.

With variable-temperature heat exchangers, Hydra heads can use multiple weights of fluid. Just about anything that can be done with smoke - from an ephemeral steam chases to a dense, long-lasting "white-out" - can be achieved with the Hydra. The Hydra can even be equipped with two types of fluid simultaneously.

With the fluid reservoir located centrally at the base, keeping the machines filled couldn't be easier. There is no need to access multiple machines in hard-to-reach corners or suspended in the rig, and the 50 liter fluid capacity provides plenty of firing time between refills. If that's not enough, we can supply custom hoses to fit 220 liter barrels.

Equipped with the accessory flight case and self-seal connectors, touring with the Hydra is a snap. The fluid line seals itself, allowing the crew to unplug hoses along with the power and data cables after the show, roll them up, and reconnect them at the next location! The Hydra is fully operable with any DMX512 controller, and for added convenience has both 3-pin and 5-pin XLR connectors.

By the way, there is no need to worry about leaks. The Hydra is constantly on guard, monitoring the fluid line pressure whenever the heads are idle. If a leak should occur, the Hydra will detect it and shut itself down.

Congratulations on your purchase of the Hydra smoke system from Jem. Details of the full range of Jem products are available on our website at www.jemsmoke.com.

Features at glance

The Hydra features:

- Dual 25 liter fluid tanks
- Automatic tank change
- Leak detection system
- Automatic out-of-fluid detection and shutdown
- Remote on/off control of heat exchangers
- Continuous operation
- Flexible 1 to 16 head configuration
- Two fluid runs of up to 150 m
- Compatibility with multiple Jem fluids
- DMX-512 control
- Optional touring kit
- Optional Jem remote control

Installation



DANGER! DO NOT install or operate the Hydra until you have read and observed all the precautions listed in “Safety information” on page 3.

Included items

The standard Hydra system is supplied with:

- Hydra base
- Hydra smoke heads
- 2 x 25L fluid tanks (empty)
- 10mm OD fluid line (2 x 30m)
- 6mm OD fluid line x 10m (1 per head)
- 10mm push-in Tee connector (1 per head)
- 10mm to 6mm push-in adaptor (1 per head)
- 10mm cap plugs x 2
- Hydra data line terminators (1 male, 1 female)
- User manual

Unpack the system's components and check for signs of damage.

Location requirements

Fluid line limits

There is a maximum length and rise of the fluid line that must be considered when deciding where to place the smoke heads and base.

- Smoke heads may be no more than 20 m above the base.
- Smoke heads may be no more than 5 m below the base.
- The maximum length of a fluid line is 90 to 150 meters, depending on the rise.

The maximum length (L) of the line in meters is shown in the following graph, or may be calculated using the formula $L = 150\text{ m} - (3 \times R)$, where R is the rise in meters. For example, if the rise is 5 meters, the maximum line length is 135 m.

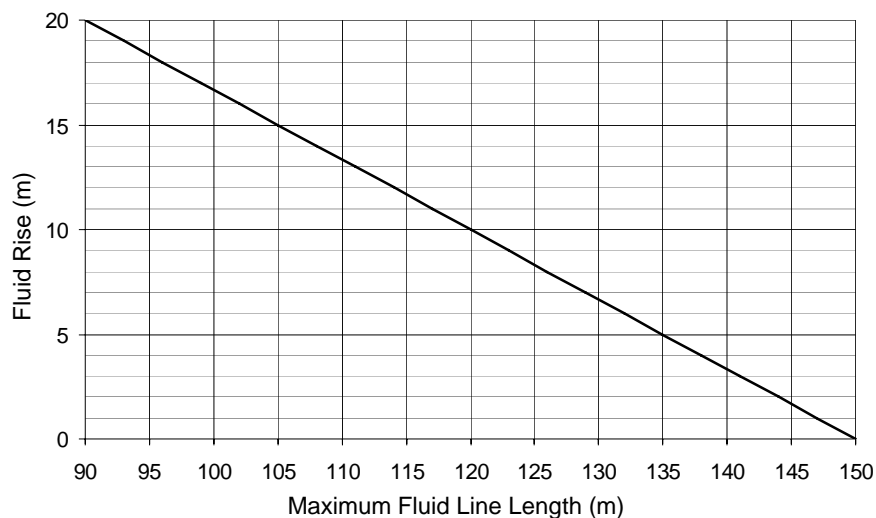

Head location requirements

The Hydra head's nozzle can reach 220°C (428° F). The heads must be positioned well out of reach of the public, so that accidental contact with the head is impossible. Install the Hydra heads in dry locations that

- are not directly above publicly trafficked areas,
- prevent accidental contact,
- comply with all safety requirements listed in the section starting on page 3.

The Hydra heads require space on all sides for safety and ventilation. Ensure that there is a minimum free space of 10 cm (4 inches) on all sides of the head, minimum 50 cm (20 inches) unobstructed airflow around the air vents, minimum 60 cm (24 inches) distance to combustible and heat-sensitive materials, and minimum 1 m (40 inches) free space in front of the smoke output nozzle.

Base location requirements

Locate the Hydra base in a dry location, on a level surface, with controlled access if operation is to be unattended.

Fluid line configuration

Fluid line components

The basic fluid line consists of the following components:

- 10 mm OD tubing
- 6 mm OD tubing
- 10 mm Tee connectors
- 10 mm to 6 mm adaptors
- 10 mm cap plugs

The following items are available as accessories:

- 10 mm self-seal connectors
- 6 mm self-seal connectors
- 10 mm inline connectors

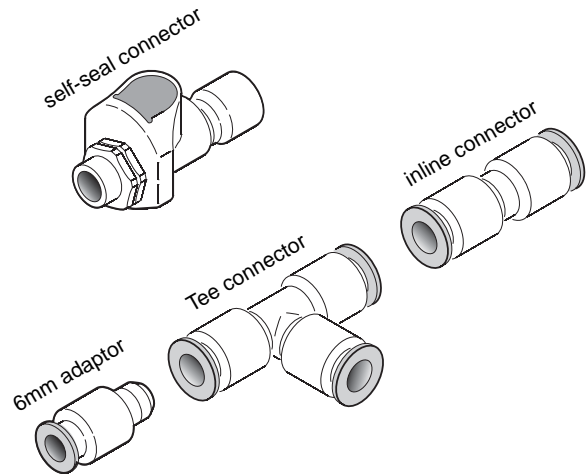

Basic fluid line configuration

Fluid flows from the base outputs towards the heads through 10 mm tubing. At points close to the heads, the fluid branches off through Tee connectors into 6 mm OD tubing connected to the heads. For examples, see the system diagrams on pages 30 - 32.

When building the fluid line,

- connect no more than 8 heads to a single fluid output,
- keep the 6 mm runs to 10 m or less,
- keep the rise to 20 m or less,
- keep the total length (of a single run) to 90 to 150 m as specified under "Fluid line limits" on page 10,
- avoid 'blind' runs. (These create air locks that cause problems with the leak detection system.)

To make it easier to drain the fluid line, try to configure it so that the end of the 10 mm line is at the high point and accessible so the plug at the end can be removed to allow air into the line. If building a ring, you can insert a Tee connector and cap plug at a convenient spot at or near the highest point.

Touring fluid line configuration

The optional self-seal connectors greatly ease setup when touring because the connectors close when disconnected to keep fluid in the line. To make a fluid line for touring, configure the line as described above with the following additions.

- Install 6 mm self-seal connectors in the lines between the Tee junctions and heads.
- Install 10 mm self-seal connectors at convenient points in the main line. Up to five 10 mm self-seal connectors may be used in each line.

See the example diagram of a touring system on page 30.

Fluid line connections

Base connections

The tube end must be cut cleanly and squarely to form a good seal with the “push-in” type connection at the base fluid outputs. To connect, simply push the 10 mm tube firmly into the fluid output as far as it will go: the outer ring clamps it in place. To disconnect, press in the outer ring while pulling on the tube.

Tee connections

The Tee connectors receive 10 mm OD tubing and have the same push in connection as the base fluid outputs. Clean and square tube ends are required for a tight seal.

- To connect 10 mm tubing, simply press the end firmly into the connector as far as it will go.
- To connect 6 mm tubing, press the tubing into a 6 mm adaptor, then insert the adaptor into the Tee connector.
- To close an unused branch, press in a 10 mm cap plug.

Head connections

To connect 6 mm tubing to a head, prepare the end by cutting it clean and square. Loosen the clamp nut on the head fitting and push the tubing onto the fitting as far as it will go. Tighten the clamp nut.

Self-seal connections

The threads of the self-seal connectors can be cross-threaded if care is not used. Install self-seal connectors as follows.

1. Trim the tube ends clean and square.
2. Loosen, but do not remove, the clamp nuts on each half of the connector.
3. Press the tubing fully onto the fitting and tighten the clamp nuts.

Data line configuration

About the data line

The Hydra system uses a dedicated bidirectional data line for communication between the base and heads. The data line connects the Hydra base and heads in series, with a data cable going from the “Out” socket of one device to the “In” socket of the next device until all devices are connected. As shown in the diagrams on pages 30 - 32, the base may be located at any point in the data line, which may be up to 300 m in length.

The Hydra data line is similar to the DMX data transmission system. Because the Hydra data line is bidirectional, however, DMX line accessories such as line splitters and amplifiers will not work.

Data cable

The Hydra system requires data cables designed for RS-485 use, available from your Jem dealer, to connect the base with the heads. Audio cable may work to some degree, but it is not designed for data transmission and its use may result in erratic performance.

The Hydra data line uses 3-pin XLR connectors with the data pair connected to pins 2 and 3. The cable shield is connected to pin 1.

Hydra terminators

The Hydra data line must be terminated on each end to prevent interference from reflected data signals using Hydra terminators. The terminators are 3-pin XLR connectors with an electronic circuit that is designed specifically for the Hydra system.

Two Hydra XLR terminators, one male and one female, are included. They have a red band on the casing to distinguish them from the typical 120 ohm terminators commonly used in DMX systems.

Important! DMX terminators are incompatible and will cause problems if used in the Hydra data line.

Connecting the data line

The data line can be connected as follows.

1. Starting at the head furthest from the base, plug the male Hydra terminator into the head's HP data "Out" socket. Plug the female end of a data cable into the head's "In" socket.
2. Lead the data cable to the next head and plug the cable into its "Out" socket. Plug another cable into the head's "In" socket.
3. Continue connecting heads "In" to "Out", working towards the base.
4. When you get to the base, connect the data cable to the HP data "Out" socket.
5. If the base is at the end of the data line, as shown on page 30, plug the female Hydra terminator into the HP data "In" socket and stop here. If the base is in the middle of the line as shown on page 31, plug the female end of a data cable into the "In" socket and continue with the next step.
6. Lead the data cable to the next head and plug it into the "Out" socket. Plug another cable into its "In" socket.
7. Continue connecting heads "In" to "Out", working away from the base.
8. At the last head, connect the data cable to the "Out" socket. Plug the female Hydra terminator into the last head's "In" socket.

AC power

Preparing the power cords



Before using the machine, grounding-type (earthed) power plugs that fit the local power outlets must be obtained locally and installed on the power cables.

DANGER! Make sure the power plug is correctly rated:

- **115 V models must be fitted with a plug rated 20 amp minimum**
- **230 V models must be fitted with a plug rated 10 amp minimum**

When installing the plug, follow the plug manufacturer's instructions and connect pins as follows: yellow and green wire to ground (earth), blue wire to neutral and brown wire to live.

The table below shows some common pin identification schemes.

Wire	Pin	Marking	Screw color
brown	live	"L"	yellow or brass
blue	neutral	"N"	silver
yellow/green	ground (earth)		green

Connecting to AC power

The Hydra is available in models designed for 115 V or 230 V nominal AC power supplies. The voltage and current requirements for each model of the head and base are stated on pages 33 and 34.



Before connecting the Hydra system to power, verify that the AC supply is adequately dimensioned for the current draw of all connected devices and that the your the local AC voltage is appropriate for your model, as indicated on the machine's serial number label. If your AC voltage is outside the appropriate range, do not use the machine. Contact Jem Service for assistance.

Installing heads

Head address setting

Each Hydra head must be assigned a unique address to identify it within the system. The address is set with the 16-position dial on the rear panel.

The head's Hydra address determines its DMX address and its firing order in the sequences described under "*ALF (alternate menu) setting*" on page 21. The Hydra address order is 0 to 9, A, B, C, D, E, F.

Starting with any head in the system, give each one a unique address starting from 0.

Physical installation

The Hydra heads may be suspended in any orientation from a suitable support by means of its adjustable mounting bracket.



Warning! Block access below the work area and work from a stable platform when installing.

Warning! Always use a secure means of secondary attachment that can hold at least 10 times the weight of the head.

Suspend Hydra heads as follows.

1. If using a rigging clamp (not included), verify that the clamp is undamaged and can bear at least 10 times the head's weight. Bolt the clamp securely to the mounting bracket with a grade 8.8 (minimum) M12 bolt and lock nut, or as recommended by the clamp manufacturer, through the 13 mm hole in the center of the mounting bracket.
2. If fastening the heads directly to a mounting surface using the adjustable mounting bracket, verify that all fasteners used and the mounting surface can bear at least 10 times the head's weight.
3. Verify that the structure used to support the smoke machine can support at least 10 times the total weight of all installed equipment, cables, etc.
4. Install a safety wire that can hold at least 10 times the weight of the smoke machine through/over the support and under the mounting bracket.
5. Loosen the swivel locks and position the head as desired. Turn the swivel locks clockwise to tighten. Verify that the smoke machine is securely installed.

Fluid system



DANGER! The Hydra can run safely only on the specific smoke fluids it is designed for. Use **ONLY** the Jem smoke fluids designated in this manual. **NEVER** use any other type of fluid, or toxic gas may be produced. You will probably also cause damage to the system that is not covered by the product warranty. Do not dilute smoke fluid with water or any other liquid. Discard smoke fluid if it becomes contaminated.

Smoke fluid options

Jem supplies high quality fog fluids that are based on ultra-pure deionized water. Use only the following genuine Jem fog fluids. No other fluid is suitable for use.

Pro Steam Simulation

Pro Steam Simulation fluid is a light fluid that produces well-defined cones of steam that disperse quickly. It is ideal for chase effects and theatrical use. When using Pro Steam Simulation fluid, the head temperature must be set to **L 0**.

Regular DJ Fluid (DJ mix)

Regular DJ fluid is an economical fluid that gives a good, medium density smoke well-suited for atmospheric effects. When using DJ mix, the head temperature must be set to **nor**.

Pro Smoke Super (ZR mix)

Pro Smoke Super fluid is a high-quality, general purpose fluid that produces a dense white air-born fog with medium dispersal time. Its medium to high index of refraction permits both good atmospheric effects and denser "white-outs". When using ZR mix, the head temperature must be set to **H 1**.

Pro Smoke High Density (SP mix)

Pro Smoke High Density fluid generates a high density, white, air-born fog with a very high index of refraction and slow evaporation rate. It is well suited for scenic obscuring, dramatic strobe effects, and "white-outs". When using SP mix, head temperature must be set to **H 1**.

Filling the Hydra

Refilling or replacing empty tanks

Replace empty fluid tanks as follows.

1. Loosen the cap fitting and remove the hoses from the depleted tank, using care to keep the hose and filter clean.
2. Loosen and raise the fluid tank holder. Remove the empty tank and replace it with a fresh one.
3. Place the fluid hose in the fresh tank and screw on the cap.
4. Lower and tighten the fluid tank holder.
5. Prime the base as described on page 26.

Transition between fluid types

The transition between two fluid types will be delayed due to the residual fluid in the delivery line. If the delay is unacceptable, you can drain the fluid line when changing fluids as described on page 27.

If the two fluids require different head temperature settings, use the lower temperature during the transition. If the new fluid requires a higher temperature, wait until it is apparent that the fluid has reached all heads to raise the setting.

If you equip the Hydra with two different types of fluid at the same time, use the manual tank change fluid setting to prevent automatic changeover.

Control panel

Overview

The Hydra control panel consists of two LED displays and two toggle switches.

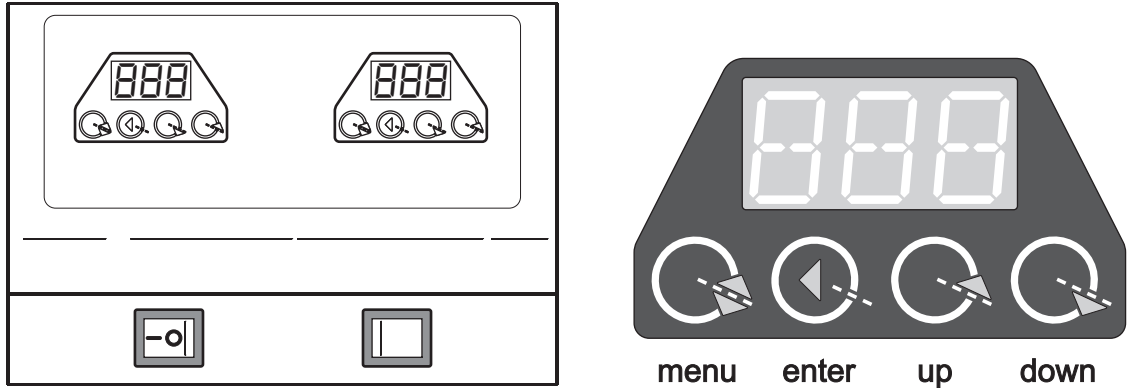

The displays allow you to

- read status messages and sensor values,
- modify user settings,
- fire the heads and run stand-alone routines, and
- execute service routines such as priming the base and lines.

The left display is for base related functions and the right display is for head related functions.

The left switch controls the fluid pump. "I" represents the ON position.

The right switch is the base power switch. The switch lights in both positions to indicate that AC power is connected whether the base is switched on or off.

Critical settings

The system works well with the default values for most settings. The most important user-set options are the head temperature setting, the fluid control setting, the tank selection setting, and the head number setting.

Because fog fluids vaporize at different temperatures, the **HDT** (head temperature) setting must be set correctly for the type of fluid in use. Generally speaking, fluids with long hang time have a higher glycol content and require a higher temperature to vaporize than lighter fluids with shorter hang times. An incorrect temperature setting causes poor performance and excessive wear and tear on the heads.

Though the Hydra base has two tanks, fluid is normally drawn from one tank at a time. This allows an empty tank to be replaced without interrupting operation. The **FLU** (fluid control) setting determines what the system does when it detects an empty tank. When set to automatic, it switches automatically to the other tank. When set to manual, it does not.

The **TNC** (tank selection) setting determines the "working" tank from which fluid is drawn.

The **Hd** (head number) setting tells the base how many heads are connected. Smoke heads will not fire as expected if this setting does not match the number of heads in the system.

Menu navigation

Located below each display are four keys with the functions described below. Approximately 25 seconds after the last keystroke, the display exits the control menu and displays a status message.

Menu key

Press the menu key to display the control menu. Press repeatedly to scroll through the menu.

Enter key

Press the enter key to display the value associated with selected menu item.

To store a new value, first change it with the up or down keys, then press the enter key until **SEt** is displayed. If a new value is not stored, it remains active while the base is on, but is lost when the base is turned off.

Up/Down keys

Press the up and down keys to increase or decrease setting values.

Status messages

Status messages over three characters long are displayed by alternating display of two messages, for example "Flu" and "Out".

Left display

These messages can appear in the left display of the control panel.

Message	Occurs when...
r dY	the base is ready for non-DMX operation. Note that the heads require time to heat up and may not be ready.
FLU Lo	the first tank is out of fluid and the base has changed over to the second tank. See " <i>Filling the Hydra</i> " on page 15.
FLU OUT	both tanks are out of fluid. See " <i>Filling the Hydra</i> " on page 15.
CAL Err	the calibration values for the pressure sensors cannot be read. Turn off the base. If the message still appears after turning the machine on again, contact Jem Service.
Adr 025	the base is ready for DMX operation. The number displayed is the DMX address.
OFF	a leak has been detected in the fluid line. See " <i>Diagnosing leaks</i> " on page 27.

Right display

These messages can appear in the right display of the control panel.

Message	Occurs when...
r dY	the base is ready for non-DMX operation. Note that the heads require time to heat up and may not be ready.
Fo9 08	the heads are being fired in stand-alone mode. The number displayed is the fog level setting.
t on 04	the system is running in timed stand-alone mode and is in the firing phase of the timing cycle. The number displayed is number of seconds remaining in the firing phase.
t oF 03	the system is running in timed stand-alone mode and is in the wait phase of the timing cycle. The number displayed is number of seconds remaining in the wait phase.
CAL Err	the calibration values for the pressure sensors cannot be read. Turn off the base. If the message still appears after turning the machine on again, contact Jem Service.

Base control menu

FLU (fluid control) setting

The fluid control setting determines how the system changes from one tank to the other.

When set to **AUT** (automatic), the system switches tanks automatically. When set to **MAN** (manual), the system shuts down instead of switching when a tank is empty.

The **DRN** (drain) option drains the fluid line into the selected tank. See “*Draining the fluid line*” on page 27.

Set as follows:

1. Under the left display, press **menu** as required to display **FLU**.
2. Press **enter** to view the current value.
3. Use the **up** and **down** keys to select the desired option.
4. Press **enter** to save the setting.

ENC (tank selection) setting

The tank selection setting determines which fluid tank to use. The options are **L** (left tank), **R** (right tank), and **L-R** (left and right tanks). Left tank is the default value.

Note: **L-R** is intended for use when priming the base only.

Set as follows:

1. Under the left display, press **menu** as required to display **ENC**.
2. Press **enter** to view the current tank.
3. Use the **up** and **down** keys to change the tank setting.
4. Press **enter** to save the setting.

Hd (head number) setting

The head number setting tells the base how many heads are connected. Values range from 1 to 16; the default is 8.

Set as follows:

1. Under the left display, press **menu** as required to display **Hd**.
2. Press **enter** to view the current value.
3. Use the **up** and **down** keys to increase or decrease the value to match the number of heads.
4. Press **enter** to save the setting.

ADR (DMX address) setting

The DMX address setting is required when operating the Hydra via a DMX controller. The setting value must match the address assigned to the Hydra on the DMX controller. Values range from 001 to 511; the default is 001.

Set as follows:

1. Make a note of the address assigned to the Hydra on the DMX controller.
2. Under the left display, press **menu** as required to display **ADR**.
3. Press **enter** to view the current value.
4. Use the **up** and **down** keys to increase or decrease the address.
5. Press **enter** to save the setting.

PR (base prime) command

The base prime command initiates the base priming cycle described under “*Priming the base*” on page 26 and resets the system after an automatic shutdown. Execute the base prime command as follows.

1. Under the left display, press **menu** as required to display **PR**.
2. Use the **up** or **down** keys to select **Y**.
3. Press **enter**.

P_t (target pressure) setting

The target pressure setting determines the pressure in the fluid line. The range is 30 to 42 psi; the default value is 36 psi and works in most applications. Increasing the target pressure may improve performance in large systems with much rise. Decreasing the pressure may improve performance if the heads are lower than the base.

Set as follows:

1. Under the left display, press **menu** as required to display **P_t**.
2. Press **enter** to view the current value.
3. Use the **up** and **down** keys to increase or decrease the pressure.
4. Press **enter** to save the setting.

P_i (input pressure) readout

The input pressure readout displays the pump output pressure. Values range from 0 to 52 psi.

Display as follows:

1. Under the left display, press **menu** as required to display **P_i**.
2. Press **enter** to view the value.

P_o (output pressure) readout

The output pressure readout displays the fluid line pressure. Values range from 0 to 52 psi.

Display as follows:

1. Under the left display, press **menu** as required to display **P_o**.
2. Press **enter** to view the value.

t_P (pressure test time) setting

The pressure test time setting determines the length of the leak detection cycle. It ranges from 3 to 20 seconds; the default value is 5 seconds. Lengthening the measurement cycle increases the ability to detect small leaks, but too long a cycle will result in false leak detection. See "*Diagnosing leaks*" on page 27.

Set as follows:

1. Under the left display, press **menu** as required to display **t_P**.
2. Press **enter** to view the current value.
3. Use the **up** and **down** keys to increase or decrease the setting value.
4. Press **enter** to save the setting.

t_d (pump time delay) setting

The pump time delay setting normally need not be adjusted. It determines the length of time the fluid pump runs to bring the output pressure up to the target pressure. The range is 10 to 80 seconds; the default value is 50 seconds.

If the target pressure cannot be achieved during normal operation, the system assumes the fluid tank is empty and either switches tanks or shuts down. Increase the delay time if the system falsely detects an out-of-fluid condition.

You may also want to increase the pump time delay if the base prime cycle is too short to bring the output pressure up to the target pressure.

Set as follows:

1. Under the left display, press **menu** as required to display **t_d**.
2. Press **enter** to view the current value.
3. Use the **up** and **down** keys to increase or decrease the setting value.
4. Press **enter** to save the setting.

r5t (reset) command

The left display's reset command restores the base user settings to their default values. The settings accessible from the right display are not effected.

Select **y** (yes) to execute the command, or **n** (no) to escape.

Head control menu

HDT (head temperature) setting

Because fluids vaporize at different temperatures, the head temperature must be set correctly for the fluid in use. An incorrect temperature setting causes poor performance and excessive wear and tear on the heads. The options are **Lo** (low), **nor** (medium), and **Hi** (high); the default value is **nor**. The correct setting for each approved fluid is shown below.

Jem Fluid	Setting
Pro Steam Simulation Fluid	Lo
Regular DJ Fluid (DJ mix)	nor
Pro Smoke Super (ZR mix)	Hi
Pro Smoke High Density	Hi

Check the setting when starting the system and whenever refilling the fluid tanks. Check or set as follows:

1. Under the right display, press **menu** as required to display **HDT**.
2. Press **enter** to view the current setting.
3. Use the **up** and **down** keys to select a different value.
4. Press **enter** to save the setting.

run (run) commands

The run command options allow you to fire the heads in stand-alone mode, i.e., without a DMX controller.

- The **on** command fires all heads continuously at the level determined by the fog level setting.
- The **off** command stops heads from firing.
- The **tr** command initiates timer operation. In this mode, heads fire in the sequence determined by the alternate menu setting, with the timing determined by the time-on and time-off settings, at the level determined by the fog level setting.

To execute a run command:

1. Under the right display, press **menu** as required to display **run**.
2. Use the **up** and **down** keys to select a command.
3. Press **enter** to execute the command.

Fog (fog level) setting

The fog level setting determines the smoke density in stand-alone mode. Values range from 00 (no output) to 20 (maximum density). The default value is 20. Set as follows:

1. Under the right display, press **menu** as required to display **Fog**.
2. Press **enter** to view the current value.
3. Use the **up** and **down** keys to increase or decrease the value.
4. Press **enter** to save the setting.

ton (time-on) setting

The time-on setting determines the length of the firing interval, in seconds, when using the timer to control the Hydra in stand-alone mode. The firing interval may range from 0 to 90 seconds; the default value is 2 seconds. A value of 0 will prevent the heads from firing. Set as follows:

1. Under the right display, press **menu** as required to display **ton**.
2. Press **enter** to view the current value.
3. Use the **up** and **down** keys to increase or decrease the value.
4. Press **enter** to save the setting.

TOF (time-off) setting

The time-off setting determines the wait interval when using the timer to control the Hydra in stand-alone mode. The wait interval may range from 0 to 90 seconds; the default value is 2 seconds. Set as follows:

1. Under the right display, press **menu** as required to display **TOF**.
2. Press **enter** to view the current value.
3. Use the **up** and **down** keys to increase or decrease the value.
4. Press **enter** to save the setting.

ALT (alternate menu) setting

The alternate menu setting determines how heads fire in timer operation mode, i.e., when the run command is set to **TR**. The options are shown below; the default is 0. The time-on and time-off settings determine the fire and wait intervals.

Alt	Firing pattern
0	All heads fire simultaneously
1	Sequential chase: heads fire sequentially in address order from first to last, then repeat from first
2	Bounce chase: heads fire sequentially in address order from first to last, then in reverse order back to first
3	Double sequential chase: heads fire simultaneously in address order and reverse address order

Set as follows:

1. Under the right display, press **menu** as required to display **ALT**.
2. Use the **up** and **down** keys to select the desired pattern.
3. Press **enter** to save the setting.

PR (prime fluid line) command

The prime fluid line command fires two heads to run fluid through the fluid line and force out air. See "Priming the fluid line" on page 26.

Execute the command as follows.

1. Under the right display, press **menu** as required to display **PR**.
2. Use the **up** or **down** keys to select **Y**.
3. Press **enter**.

STA (head status) readout

The head status readout shows the operating status of each head. The possible states are shown below.

Message	Operating status
r	ready
H	heating
-	no head detected
E	error

The readout is a combination of the head address and status message, with the address on the left and the status on the right. For example, a readout of **7 r** indicates that the head at address 7 is ready. Display head status as follows:

1. Under the right display, press **menu** as required to display **STA**.
2. Use the **up** and **down** keys to scroll through the head addresses.

r5t (reset) command

The right display's reset command restores the head user settings to their default values. The settings accessible in the left display are not effected.

Select **Y** (yes) to reset settings or **n** (no) to escape.

Remote control

Overview

The Jem digital remote control, available separately, may be used for remote control of the Hydra system.

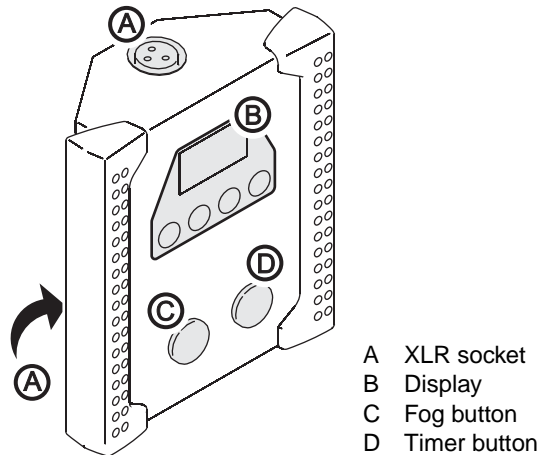

Functions

The remote control provides the following functions:

- head temperature setting (hot: lo, nor, hi)
- run commands (run: on, off, tr)
- fog level setting (fog: 0 - 20)
- timer on/off settings (ton, tof: 0 - 90 seconds)
- alternate menu (Alt: 0, 1, 2, 3).

These functions are described under “*Head control menu*” on page 20.

Note: the **FRn** and **LnC** functions are not used by the Hydra and have no effect.

The Fog button toggles the run on/off commands, firing all heads. The Timer button toggles timer operation on and off.

Connection

The remote control has two identical XLR sockets on the top and back for connection to the Hydra base. Plug the cable provided with the remote control into one of these sockets and into the XLR socket labelled REMOTE on the rear panel of the Hydra base.

The remote control is powered through its cable by the Hydra base; no batteries are required.

The cable may be extended to up to 25 m (82 ft.) with a 3-pin XLR DMX cable, available from your Jem dealer.

DMX control

Overview

DMX is a standard system that is commonly used to control entertainment lighting. As such, DMX controllers are often found in the same locations as the Hydra. Any controller meeting the DMX-512 standard may be used to control and program the firing intervals and fog density of each head.

Note: when a DMX signal is present, the Hydra's stand-alone functions are inoperative. To fire the heads from the control panel or remote control, the DMX controller must be powered off or disconnected.

DMX connection

The Hydra provides both 3-pin and 5-pin XLR sockets on the rear panel of the base for DMX connection. The sockets are interconnected: a DMX line connected to the 3-pin IN socket may be continued through the 5-pin OUT socket and vice versa. Do not, however, attempt to split a DMX line by using both the 3-pin and 5-pin OUT sockets.

Do not connect the DMX line directly to Hydra heads: they are not intended for direct DMX control.

For best results, use cable designed for high speed digital data transmission. Suitable DMX cable is available from your Jem dealer.

DMX address and channels

The Hydra's address setting must match the DMX address allocated to it on the controller. To set the address, see "*Adr (DMX address) setting*" on page 18. The Hydra requires one DMX channel per head.

DMX channels control heads in head address order, which is 0 to 9, A, B, C, D, E, F. For example, if the DMX address is channel 100 and there are 8 heads, the head at Hydra address 0 is controlled by DMX channel 100, the head at Hydra address 1 is controlled by DMX channel 101, and the head at Hydra address 7 is controlled by DMX channel 107.

Command values

Hydra heads respond to DMX levels as shown below.

DMX level	Response
0 - 19	No smoke output
20 - 219	Head fires, minimum to maximum fog density in 20 equal steps
220 - 255	Head fires at maximum output

Initiating DMX operation

To operate the Hydra with a DMX controller, follow the steps below.

1. Start the Hydra system as described in the next section.
2. Connect the Hydra to the DMX line and turn on the DMX controller.
3. Set the Hydra's DMX address as described under "*Adr (DMX address) setting*" on page 18.
4. Verify that the head number setting is correct.
5. The Hydra is ready for DMX operation when **Adr** and the DMX address alternately appear in the displays.

General operation

Pre-operation checks



DANGER! DO NOT operate the Hydra until you have read and observed all the precautions listed under “Safety information” on page 3.

Before applying power to the Hydra, verify the following:

- the base and head are safely installed and meet the location requirements stated on page 11
- the operator is familiar with, and able to comply with, the requirements for safe operation listed on pages 3 and 4.
- the smoke fluid is one of the genuine Jem fluids listed under “Smoke fluid options” on page 15
- the base and heads are electrically grounded (earthed)
- the AC power distribution circuits and lines are adequately dimensioned for the current load
- the fluid line is fully assembled and closed

Starting the Hydra for first time

Follow the steps below to start the Hydra for the first time, after it has been installed and the fluid and data lines have been connected as described in this manual.

1. Disconnect the DMX cable from the DMX input socket on the rear panel of the base, if present.
2. Set the pump enable switch on the base control panel to the “O” (off) position.
3. Connect the base to AC power and set the base power switch to the left (on) position.
4. Apply power to the smoke heads and set their power switches to the on position. Allow the heads 10 - 15 minutes to reach operating temperature.
5. Equip the base with two fresh tanks of approved fluid as described under “Filling the Hydra” on page 15.
6. Set the head temperature as described under “*HTE (head temperature) setting*” on page 20.
7. Set the number of heads in the system as described under “*Hd (head number) setting*” on page 18.
8. Set the desired fluid control option as described under “*FLU (fluid control) setting*” on page 18.
9. Verify that all heads are ready as described under “*SEA (head status) readout*” on page 21.
10. Verify that the fluid line is closed.
11. Set the pump enable switch to the “I” (on) position.
12. Prime the base as described under “*Priming the base*” on page 26.
13. Select the left or right fluid tank as described under “*ENC (tank selection) setting*” on page 18.
14. Fill and prime the fluid line as described under “*Priming the fluid line*” on page 26.
15. The Hydra is ready for use. To operate, refer to “*Generating smoke*”, below.

Normal start procedure

Follow the steps below to start the Hydra once it has been commissioned and tested.

1. Connect the base to AC power and set the base power switch to the left (on) position.
2. Apply power to the smoke heads. Allow 10 - 15 minutes to reach operating temperature. (If the heads are left on and connected to AC power, the heat exchangers switch on when the base is switched on.)
3. Check the fluid tanks. Refill with an approved Jem fluid and prime as required. If changing to a different fluid, please see “*Transition between fluid types*” on page 15.
4. Verify that head temperature setting is correct for the selected fluid.
5. Set the pump enable switch to the “I” (on) position.
6. Verify that the heads are ready as described under “*SEA (head status) readout*” on page 21.

Generating smoke

The simplest way to generate smoke is to execute the run menu's on and off commands from the control panel or, if you have the Jem Remote Control, to press the Fog button. This fires all heads at the level determined by the fog level setting.

The density and hang time of the resulting smoke will depend on firing time, fog level, fluid weight, room size, and ventilation. For thicker smoke, increase the fog level setting, and/or increase firing time. For thinner smoke, use a lower fog level setting and/or decrease firing time.

For unattended smoke generation, execute the timer command from the run menu of the control panel or the remote control. In timer mode, heads fire with the timing determined by the time-on and time-off settings, at the level determined by the fog level setting. Several minutes of manual operation will give you a feel for the time and level settings to use to achieve the desired effect.

To execute sequential chases from the control panel or remote control, refer to "*AL L (alternate menu) setting*" on page 21.

If operating the Hydra from a DMX controller, refer to "*DMX control*" on page 23.

Fluid consumption

The maximum fluid consumption of each head is approximately 3.2 l/hr. With a full, 16-head system, a 50 liters of fluid provides approximately 60 minutes of firing time at full output. In practice, very few venues can accept this much fog, so 2 tanks of fluid will last much longer.

The approximate firing time provided by 50 liters of fluid is indicated in the table below.

Heads	Approximate firing time provided by 50 l (minutes)
16	60
15	64
14	68
13	74
12	80
11	86
10	96
9	106
8	118
7	136
6	158
5	190
4	236
3	316
2	472
1	944

Priming the base

Priming the base fills the base with fluid, pressurizes the system, and resets the system if an automatic shut-down has occurred. The base must be primed when refilling or replacing both fluid tanks, when the tanks have been removed for transport, after an out-of-fluid shutdown, and after a leak detection shutdown.

The base need not be primed if replacing an empty tank while the system is running: it will prime itself automatically when switching tanks. However, priming will make the tank changeover faster.

Prime the base from the left display as follows:

1. To prevent heads from firing, verify that run is set to off, or, if there is DMX input, that all Hydra control channels are set to no output.
2. Select the fresh tank from the **ENC** menu. When fitting 2 fresh tanks (of the same fluid), you can select **L - r** to prime both tanks simultaneously.
3. Under the left display, press **menu** as required to display **Pr i**.
4. Use the **up** or **down** keys to select **Y**. Press **enter**.
5. Allow the base priming cycle to run until the pump stops.
6. Read the input pressure (**Pr i**) value in the left display. If the value is less than the target pressure (36 psi by default), repeat the base priming cycle. If more than three cycles are required with the default settings, there may be a fault with the system. Contact Jem service.
7. Select the working tank from the **ENC** menu.

Priming the fluid line

Priming the fluid line fills it with fluid and forces out air by firing two heads: those with the middle and last address. This is required before first use or after opening the fluid line for draining or maintenance. The fluid line does not require priming when refilling/replacing fluid tanks.

Prime the fluid line from the right display as follows:

1. Verify that the fluid line is closed.
2. Start the system and allow the heads to reach operating temperature.
3. Prime the base as described above.
4. Under the right display, press **menu** as required to display **Pr i**.
5. Use the **up** or **down** keys to select **Y**. Press **enter**. This opens the base fluid output valves and fires two heads for a period determined by the pump delay time setting. Large systems can take up to four minutes to fill; you may need to repeat the cycle several times.
6. Select **n** to stop the cycle when both heads are firing.

Shutting down the system

To turn off the Hydra system, simply set the base power switch to the right (off) position.

The heads may be left on, with AC power applied, if convenient. The heat exchangers are automatically switched off 20 minutes after the base is turned off to save power. When a head detects that the base is switched back on, it switches on its heat exchanger and is ready to fire 10 to 15 minutes later.

Touring with the Hydra

A custom flight case is available for transporting the Hydra base. Contact your Jem supplier for information.

The base hose fluid caps are not leakproof. Remove the fluid tank hoses from the tanks for transportation and seal the tanks with regular caps. Place the fluid tank hoses in a clean plastic bag to keep them clean.

Take care as well to keep the self-seal connectors clean.

When setting up in a new venue, run the base prime cycle after connecting the fluid lines.

Basic service



Before servicing the Hydra, read and observe all the precautions listed in “*Safety information*” on page 3. Any service not described in this section must be carried out by a Jem service technician.

Cleaning

Excessive dust, smoke fluid, and dirt buildup will degrade performance and cause overheating and damage to the machine that is not covered by the product warranty. To maintain adequate cooling, dust must be cleaned from the outer casing and air vents of the base and heads periodically.



Isolate the heads from power and allow to cool completely before cleaning. The smoke output nozzle remains hot for up to 10 hours after use.

- Remove dust from the air vents with a soft brush, cotton swab, vacuum, or compressed air.
- Clean the outer casing with a damp cloth only.

Diagnosing leaks

When the heads have been idle for 13 seconds, the system goes into a repeating leak detection cycle. The pressure at the beginning of the cycle is compared to the pressure at the end; if the pressure falls by more than 2 psi, a leak is assumed and the system shuts down automatically. **DF** appears in the left display, the heads stop firing, the output valves close, and the fluid pump stops running.

Resolve the problem as follows.

1. Inspect the fluid line for signs of leaking fluid.
2. If a leak is found, drain the fluid line as described below. Turn off the base and repair the fluid line, making sure the tube ends are clean and square. Restart the system and prime the base and fluid line.
3. If no leak can be found, the value of the pressure test time setting may be too high. Lower the setting as described under “*LP (pressure test time) setting*” on page 19. Prime the base and resume operation.
4. If the problem persists, it is likely that air trapped in the line is causing the pressure to fall. Check for blind runs in the fluid line and eliminate any that you find. Prime the base, then prime the fluid line thoroughly by firing all heads until there are no interruptions in the output.

Draining the fluid line

The fluid line can be drained to remove the fluid when servicing the line or heads, or changing fluid types. Fluid lines equipped for touring with self-seal connectors need not be drained for transport.

Make sure there is sufficient room in the tank when draining: a typical fluid line contains 5 to 10 liters of fluid.

Drain the fluid line as follows.

1. Under the left display, press **menu** as required to display **ENC**.
2. Select the tank in which to drain the fluid using the **up** or **down** keys.
3. Press **menu** as required to display **FLU**.
4. Use the **up** or **down** keys to select **drA**.
5. Press **enter**. This opens the drain valve on the selected tank and disables the pump.
6. If the heads are installed above the base, fluid will drain into the tank but it will be necessary to allow air into the system by removing a plug or 6 mm adaptor at the end of the fluid line, or at the high point if the line is connected in a ring.

If there is little rise in the system, it may be necessary to push the fluid back to the tank using a supply of compressed air (maximum 3 bar) at the end of the fluid line.

If the end of the fluid line is lower than the base, the fluid will flow towards the end of the line instead of the tank. Use an empty tank to collect fluid here.

7. After the line has drained, be sure to close the fluid line before priming the system again.

Flushing the system

The system can be flushed with deionized water to remove virtually all traces of residual fluid as described below.

Important! Never use plain drinking water to flush the system: impurities will rapidly clog the head.

1. Drain the system as described above. Close the fluid line.
2. Fill an empty tank with a sufficient quantity of deionized water to fill the fluid line.
3. Set the head temperature to **LO**.
4. Select the tank containing the water from the **ENC** menu.
5. Prime the base.
6. Fire all heads until the water tank is empty.
7. Drain any remaining water from the fluid line.

Fuse replacement

Base

The main fuse for the Hydra base is in a fuse holder located in the IEC power inlet socket on the rear panel. To replace the fuse, disconnect the power cord from the rear panel and pull out the fuse holder. Remove the spent fuse and replace with one of exactly the same size and rating. The fuse type is indicated on the serial number label. Contact Jem Service if the fuse blows repeatedly.

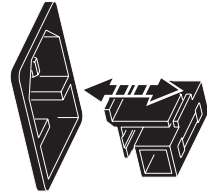

Head

The main fuse for the Hydra head is in a screw-in holder on the rear panel of the head, above the AC power cord. To replace the fuse, disconnect the head from AC power. Turn the fuse holder cap counter-clockwise to remove. Remove the spent fuse and replace with one of exactly the same size and rating. The fuse type is indicated on the serial number label. Contact Jem Service if the fuse blows repeatedly.

Annual pressure check

In order to reduce the cycling of the pump to a minimum, a diaphragm accumulator is used to store pressurized liquid in the base unit. The bias pressure on the accumulator is set to approximately 2 Bar and must be checked annually by an authorized technician. Rapid short-cycling of the pump indicates that the target pressure or the bias pressure are wrong.

Troubleshooting

Problem	Probable cause(s)	Suggested remedy
Base ready but heads cannot be fired from control panel or remote control	Heads not at operating temperature	Wait 10 to 15 minutes
	F09 set to 0	Increase setting
	t0n set to 0	Increase setting
	DMX signal present	Disconnect or turn off DMX controller
One or more heads not detected by base (status reads “-”)	Heads not powered on	Verify that AC power is connected and power switches are set to on
	Heads not connected to data line	Verify that data line is connected
	Defective data cable	Repair or replace cable
	Missing or incorrect termination	Terminate data line as described under “Hydra terminators” on page 12.
	Heads addressed incorrectly	Check head address setting (page 14)
Heads ready (status reads “R”), but one or more heads doesn’t fire as expected	Head number setting does not match number of heads in system	Change head number setting (page 18)
	Heads addressed incorrectly	Check head address setting (page 14)
	Missing or incorrect termination	Terminate data line as described under “Hydra terminators” on page 12.
Head reports error (status reads “E”)	Head malfunction	Contact Jem Service
Heads don’t fire and “off” message displayed	Leak detected	See “Diagnosing leaks” on page 27
“Flu out” message displayed, but there is fluid in one or both tanks	Base requires priming	Prime base (page 26)
Heads can be fired from control panel or remote control, but not by DMX controller	DMX address setting incorrect	Change DMX address (page 18)
	Heads addressed incorrectly	Check head address setting (page 14)
	Poor connection in DMX line	Check DMX cables and connections
Smoke output is weak	Pump switch off	Turn pump switch on
	Target pressure too low	See “ <i>P_L</i> (target pressure) setting” on page 19.
	Incorrect fluid line configuration	Verify fluid line installed as described
Wet, greasy, non-uniform smoke output, fluid drips or spits from nozzles, or very loud noise when firing heads	Incompatible smoke fluid	Use approved fluid!
	Incorrect head temperature	Refer to “ <i>H_{DL}</i> (head temperature) setting” on page 20
	Residual fluid of different type in line	Refer to “ <i>Transition between fluid types</i> ” on page 15
Base appears dead, no light in power switch	Main fuse blown	Replace fuse (page 28)
	No power at AC cable inlet	Check power cable and circuit breaker

System diagrams

System 1: One fluid line with self-seal connectors, base at end of Hydra data line

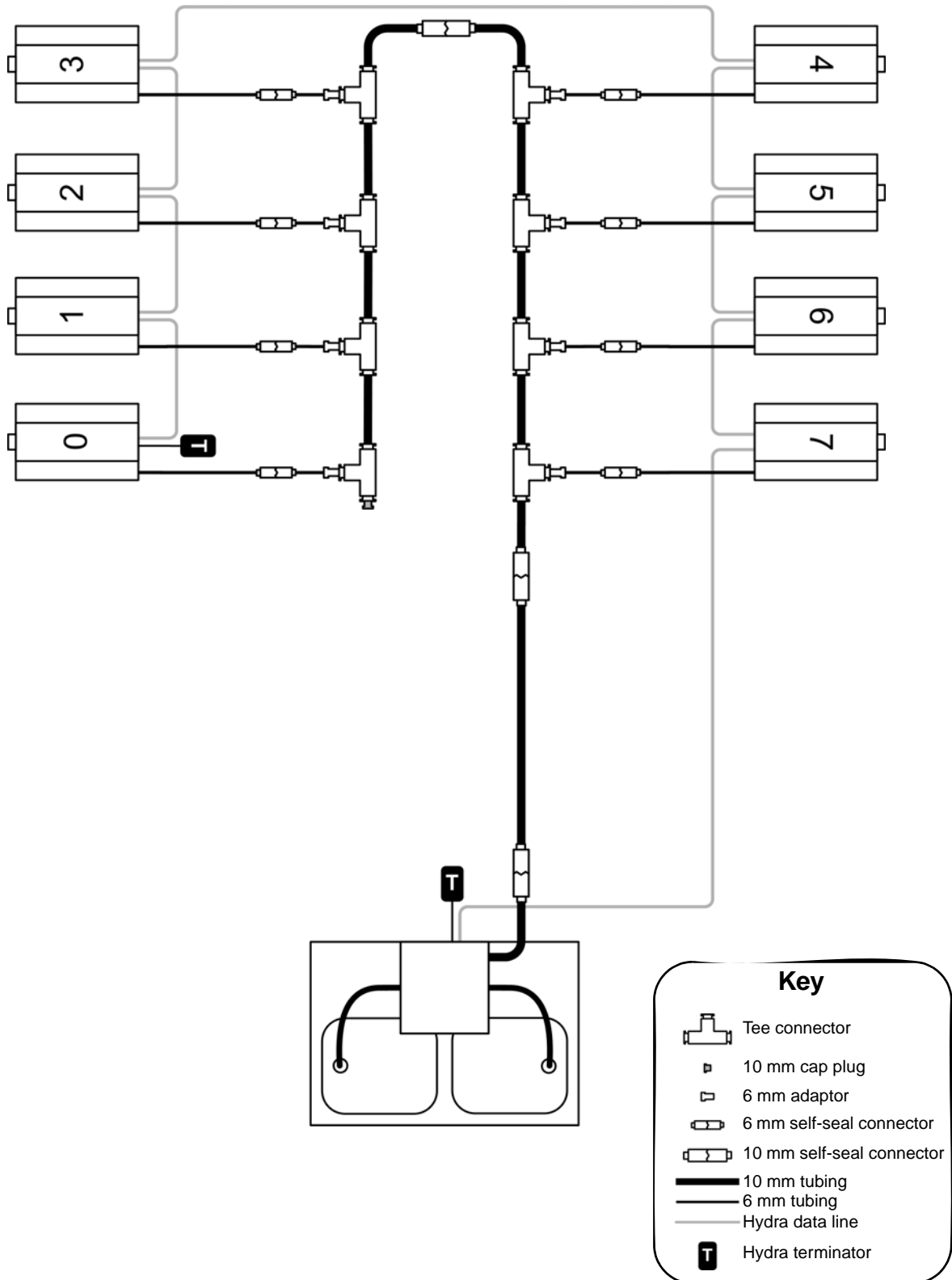



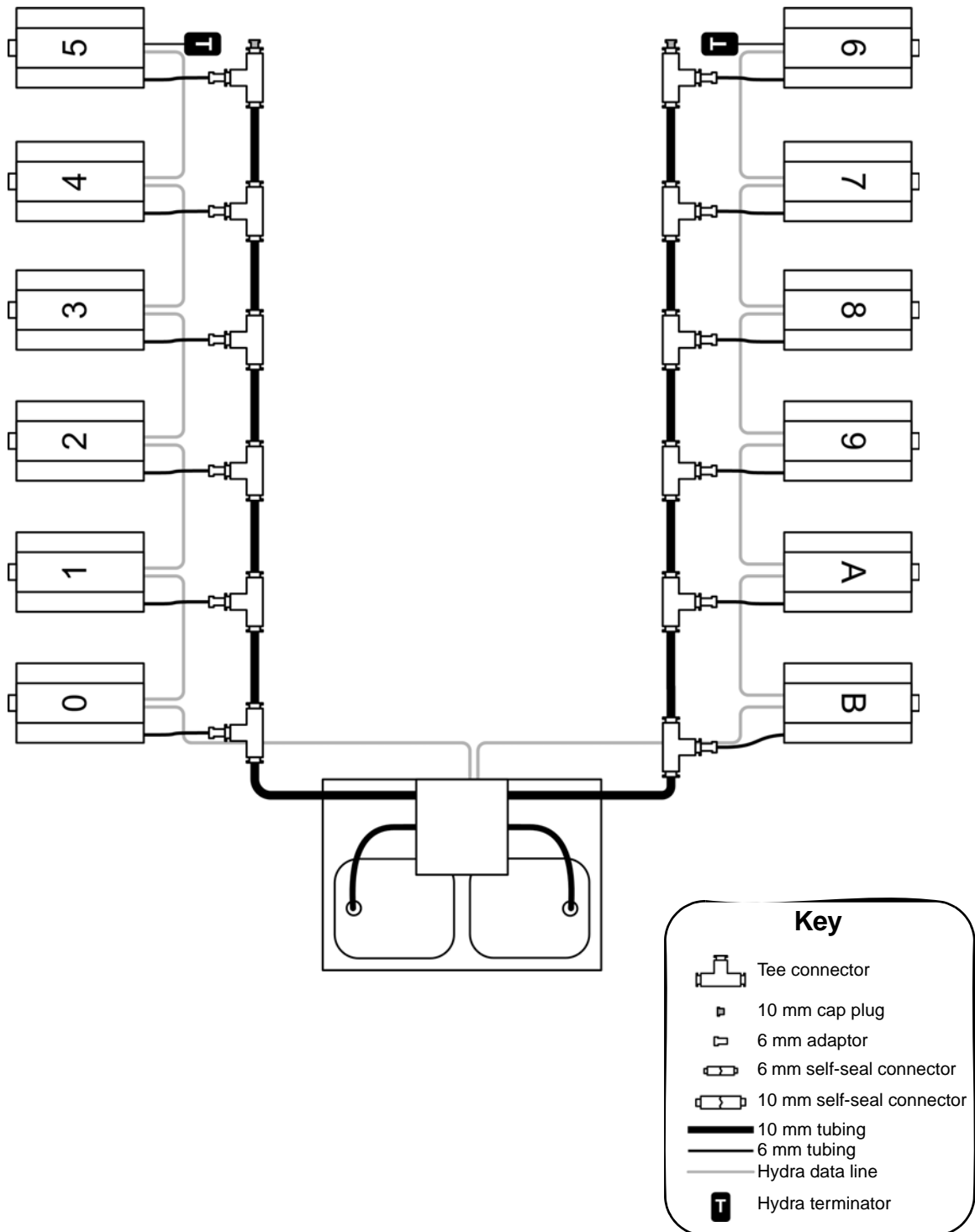



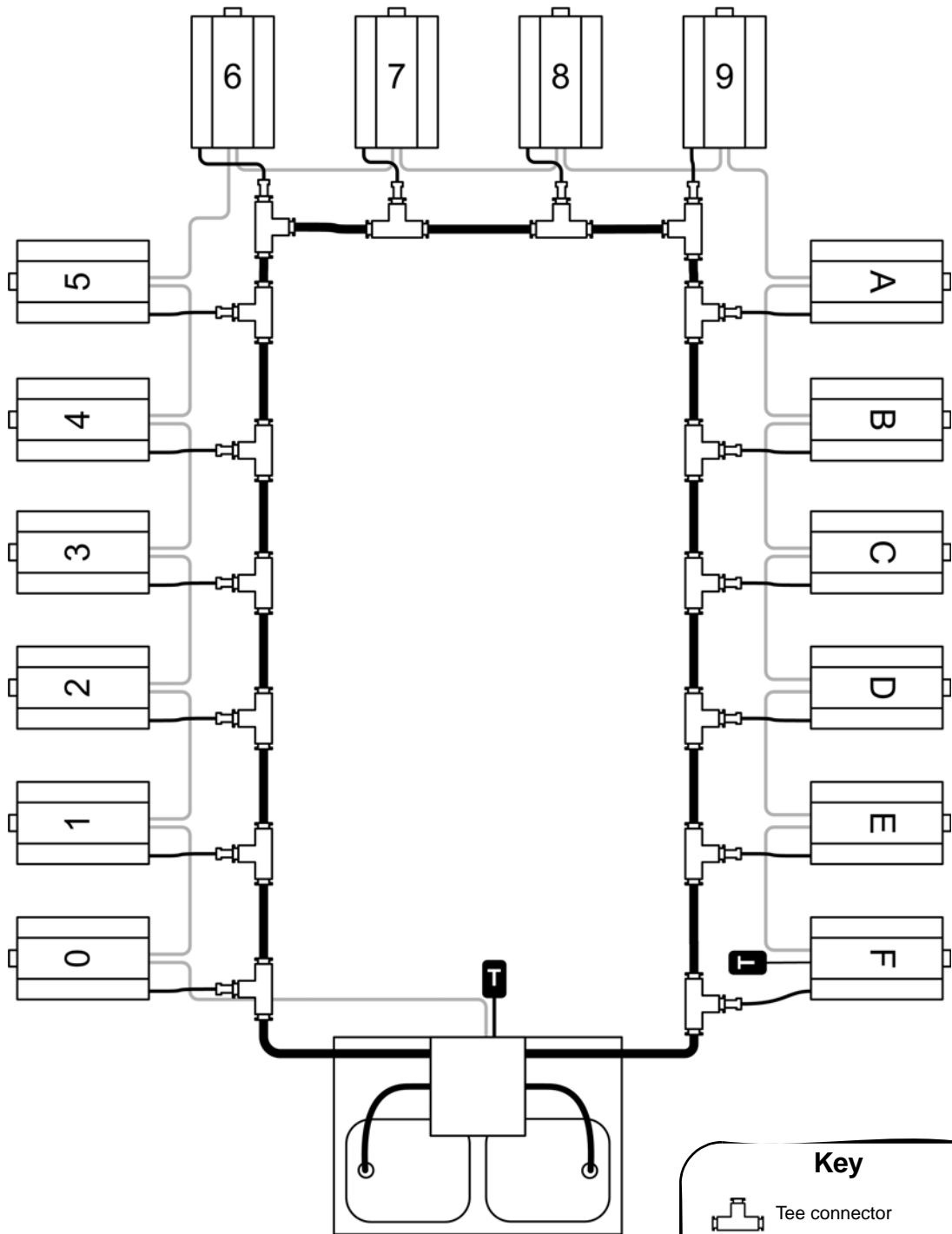

System 2: Two fluid lines, base in middle of Hydra data line



System 3: Fluid line connected in ring, base at end of Hydra data line



Key

-  Tee connector
-  10 mm cap plug
-  6 mm adaptor
-  6 mm self-seal connector
-  10 mm self-seal connector
-  10 mm tubing
-  6 mm tubing
-  Hydra data line
-  Hydra terminator

Specifications

Hydra head

Physical

Length:	440 mm (17.3 in.)
Width:	387 mm (15.2 in.)
Height:	166 mm (6.5 in.)
Height including mounting bracket:	415 mm (16.3 in.)
Weight:	13.8 kg (30.4 lbs)

Performance

Maximum operating time at full output (approx.):	n/a
Operating time:	continuous
Warm-up time (EU model):	9 minutes
Warm-up time (US model):	12 minutes

Control and programming

Control options:	Hydra base
------------------	------------

Fluid system

Fluid pump:	EP5 16 bar
Fluid capacity:	n/a
Maximum fluid consumption at peak output (Pro Smoke Super):	120 ml per minute

Installation

Orientation:	any
--------------	-----

Connections

Hydra data line:	3-pin XLR
AC power:	hard-wired cable w/o cord cap

Electrical

AC power (EU model):	200 - 250 VAC, 50/60 Hz
AC power (US model):	100 - 130 VAC, 50/60 Hz
Main fuse (EU model):	10 A
Main fuse (US model):	15 A

Power and current

EU model, maximum at 230 V / 50 Hz:	1500 W, 6.5 A
US model, maximum at 115 V / 60 Hz:	1200 W, 10.4 A

Thermal

Maximum ambient temperature (Ta max.):	40° C (104° F)
Maximum nozzle temperature:	220° C (428° F)

Approvals

	European EMC:	EN 50 081-1, EN 55 014, EN 55 022 /B, EN 60 555
	European safety:	EN 60 335-1
	Immunity:	EN 50 082-1, IEC 801-2, IEC 801-4

Included items

	6 mm o/d tube, 10 m
	Tee connector

Ordering information

Jem Hydra head, 230V 50/60 Hz:	P/N 92250400
Jem Hydra head, 115V 50/60 Hz:	P/N 92250500

Hydra base

Physical

Length: 510 mm (20.1 in.)
Width: 665 mm (26.2 in.)
Height: 1040 mm (40.9 in.)
Dry weight: 35 kg (77 lbs)

Performance

Operating time: continuous

Control and programming

Control options DMX, stand-alone, Jem Remote Control (not included)
DMX channels: variable, 1 per head, 16 max

Fluid system

Fluid pump: 2 bar
Fluid capacity 50 l
Maximum fluid consumption at peak output (16 heads): approx. 50 l/hr

Installation

Orientation horizontal

Connections

Hydra data line: 3-pin XLR
DMX: 3 and 5 pin XLR
Remote control: 3-pin XLR
Fluid line: receives 10 mm OD flexible tubing
AC power: IEC connector with integral fuse holder

Electrical

AC power (EU model) 200 - 250 VAC, 50/60 Hz
AC power (US model) 100 - 130 VAC, 50/60 Hz
Main fuse (EU model) 3.15 AT (slow-blow)
Main fuse (US model) 6.3 AT (slow-blow)

Power and current

EU model, maximum at 230 V / 50 Hz: 250 W, 1.1 A
US model, maximum at 115 V / 60 Hz: 250 W, 2.2 A

Thermal

Maximum ambient temperature (Ta max.): 40° C (104° F)
Exterior surface temperature, steady state: 40° C (104° F)

Approvals

 European EMC: EN 50 081-1, EN 55 014, EN 55 022 /B, EN 60 555
European safety: EN 60 335-1
Immunity: EN 50 082-1, IEC 801-2, IEC 801-4

Included items

..... 10 mm tube, 2 x 30 m
..... IEC three-pole AC power lead without plug
..... Male and female Hydra XLR data line terminators
..... 2 x 10 mm fluid line cap plugs
..... 2 x 25 l fluid container (empty)

Accessories

Connector, 2 x 6 mm m/f, valved (self-seal) P/N 92620007
Connector, 2 x 10 mm m/f, valved (self-seal) P/N 92620008
Connector, 2 x 10 mm, straight (in-line) P/N 92620009
Tubing, 10 mm o/d, length 30 m P/N 92620010
Hydra flightcase P/N 91540007
Jem Remote Control P/N 92765026

Ordering information

Jem Hydra base, 230V 50/60 Hz P/N 92250200
Jem Hydra base, 115V 50/60 Hz P/N 92250300

Specifications subject to change without notice.



www.martin.com • Olof Palmes Allé 18 • 8200 Aarhus N • Denmark
Tel: +45 8740 0000 • Fax +45 8740 0010