

BW-54-3RGBW IV

User Manual

Please read the instructions carefully before use

Innovation, Quality, Performance

5. Troubleshooting

Following are a few common problems that may occur during operation. Here are some suggestions for easy troubleshooting:

A. The unit does not work, no light and the fan does not work

1. Check the connection of power and main fuse.
2. Measure the mains voltage on the main connector.

B. Not responding to DMX controller

1. DMX LED should be on. If not, check DMX connectors, cables to see if link properly.
2. If the DMX LED is on and no response to the channel, check the address settings and DMX polarity.
3. If you have intermittent DMX signal problems, check the pins on connectors or on PCB of the unit or the previous one.
4. Try to use another DMX controller.
5. Check if the DMX cables run near or run alongside to high voltage cables that may cause damage or interference to DMX interface circuit.

6. Fixture Cleaning

The cleaning of internal must be carried out periodically to optimize light output. Cleaning frequency depends on the environment in which the fixture operates: damp, smoky or particularly dirty surrounding can cause greater accumulation of dirt on the fixture's optics.

- Clean with soft cloth using normal glass cleaning fluid.
- Always dry the parts carefully.
- Clean the external optics at least every 20 days.

4.4 DMX512 Connection

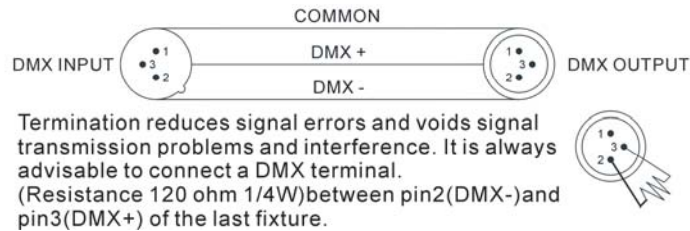
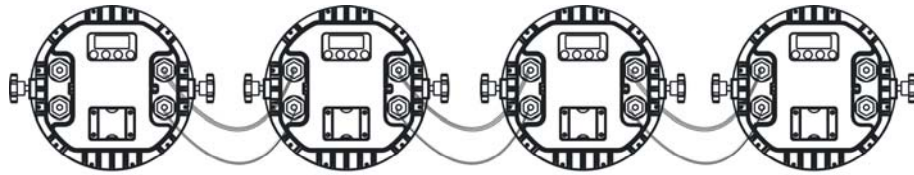

1. If you using a controller with 5 pins DMX output, you need to use a 5 to 3 pin adapter-cable.
2. At last unit, the DMX cable has to be terminated with a terminator. Solder a 120 ohm 1/4W resistor between pin 2(DMX-) and pin 3(DMX+) into a 3-pin XLR-plug and plug it in the DMX-output of the last unit.
3. Connect the unit together in a `daisy chain` by XLR plug from the output of the unit to the input of the next unit. The cable can not branched or split to a `Y` cable. DMX 512 is a very high-speed signal. Inadequate or damaged cables, soldered joints or corroded connectors can easily distort the signal and shut down the system.
4. The DMX output and input connectors are pass-through to maintain the DMX circuit, when one of the units' power is disconnected.
5. Each lighting unit needs to have an address set to receive the data sent by the controller. The address number is between 0-511 (usually 0 & 1 are equal to 1).
6. The end of the DMX 512 system should be terminated to reduce signal errors.
7. 3 pin XLR connectors are more popular than 5 pin XLR.
 3 pin XLR: Pin 1: GND, Pin 2: Negative signal (-), Pin 3: Positive signal (+)
 5 pin XLR: Pin 1: GND, Pin 2: Negative signal (-), Pin 3: Positive signal (+), Pin 4/Pin 5: Not used.

TABLE OF CONTENTS

TABLE OF CONTENTS.....	2
1. Safety Instructions.....	3
2. Technical Specifications.....	5
3. How To Set The Fixture.....	5
3.1 Control Panel.....	5
3.2. Main Functions.....	6
4.How To Control The Unit.....	11
4.1 Master/Slave Built In Preprogrammed Function.....	11
4.2 DMX Controller.....	11
4.3 DMX 512 Configuration.....	12
4.4 DMX512 Connection.....	13
5. Troubleshooting.....	14
6. Fixture Cleaning.....	14

1. Safety Instructions



WARNING

Please read the instructions carefully which include important information about the installation, operation and maintenance.

- Please keep this User Guide for future consultation. If you sell the unit to another user, be sure that they also receive this instruction booklet.

Caution:

- All fixtures are intact from the manufacturer, please operate follow up the user manual, artificial fault are not under guarantee repair.
- Unpack and check carefully there is no transportation damage before using the unit.
- The unit is for indoor use only. Use only in a dry location.
- Do install and operate by operator.
- Use safety chain when fixes the unit.
- The unit must be installed in a location with adequate ventilation, at least 50cm from adjacent surfaces.
- Be sure that no ventilation slots are blocked, otherwise the unit will be overheated.
- Before operating, ensure that the voltage and frequency of power supply match the power requirements of the unit.
- It's important to ground the yellow/green conductor to earth in order to avoid electric shock.
- Maximum ambient temperature TA : 40°C. Don't operate it where the temperature is higher than this.
- Don't connect the device to any dimmer pack.
- First run, there will be smoke or smells, and all disappearing a few minutes later.
- Make sure there are no flammable materials close to the unit while operating, as it is fire hazard.
- Look over power wires carefully, replace immediately if there is any damage.
- Unit surface temperature may reach up to 60°C. Don't touch the housing bare-hand during its operation.
- Never run on for a long time lest shortening lifespan.
- Avoid any inflammable liquids, water or metal objects entering the unit. Once it happen,

4.3 DMX 512 Configuration

4CH (4 MODE)				5CH (4D MODE)				
Ch1	Ch2	Ch3	Ch4	Ch1	Ch2	Ch3	Ch4	Ch5
RED	GREEN	BLUE	WHITE	RED	GREEN	BLUE	WHITE	DIMMER

7CH (4C MODE)						
Ch1	Ch2	Ch3	Ch4	Ch5	Ch6	Ch7
RED	GREEN	BLUE	WHITE	COLOR	DIMMER	STROBE
				248-255 Preset color32 240-247 Preset color31 232-239 Preset color30 225-231 Preset color29 217-224 Preset color28 209-216 Preset color27 202-208 Preset color26 194-201 Preset color25 186-193 Preset color24 178-185 Preset color23 171-177 Preset color22 163-170 Preset color21 155-162 Preset color20 148-154 Preset color19 140-147 Preset color18 132-139 Preset color17 124-131 Preset color16 117-123 Preset color15 109-116 Preset color14 101-108 Preset color13 093-100 Preset color12 086-092 Preset color11 078-085 Preset color10 070-077 Preset color9 063-069 Preset color8 055-062 Preset color7 047-054 Preset color6 039-046 Preset color5 032-038 Preset color4 024-031 Preset color3 016-023 Preset color2 008-015 Preset color1 001-007 OFF		248-255 OPEN 240-247 RANDOM STROBE 232-239 OPEN SLOW CLOSE 190-231 FAST OPEN 182-189 OPEN SLOW OPEN 140-181 FAST CLOSE 132-139 OPEN 16-131 *** 8-15 ** 0-7 OPEN OFF

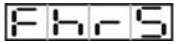

Fixture Hours

Press the **MENU** button up to when the **FHRS** is blinking on the display. Press **ENTER** button and the display will show the number of working hours of the unit. To go back to the functions press the **MENU** button.

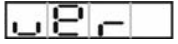

Software version

Press the **MENU** button up to when the **VER** is blinking on the display. Press **ENTER** button and the display will show the version of software of the unit. To go back to the functions press the **MENU** button again.

4.How To Control The Unit

You can operate the unit in two ways:

1. By master/slave built-in preprogram function
2. By DMX controller

No need to turn the unit off when you change the DMX address, as new DMX address setting will be effected at once. Every time you turn the unit on, it will show **6059** on the display and move all the motors to their 'home' position. After that the unit will be ready to receive DMX signal or run the built in programs.

4.1 Master/Slave Built In Preprogrammed Function

By linking the units in master/slave connection, the first unit will control the other units to give an automatic, sound activated, synchronized light show. This function is good when you want an instant show. You have to select **5h1** (show 1) or **5h2** (show 2)or **5h19** (show 19, show17~19 have to be edited by the user) show for the first unit. Its DMX input jack will have nothing plugged into. The other units will be slave mode automatically.

4.2 DMX Controller

Use universal DMX controller to control the units, you have to set DMX address from 1 to 512 channel so that the units can receive DMX signal.

Press the **MENU** button up to when the **Addr** is showing on the display. Press **ENTER** button and the display will blink. Use **DOWN** and **UP** button to change the DMX512 address. Once the address has been selected, press and keep **ENTER** button pressed up to when the display stops blinking or storing automatically 8 seconds later. To go back to the functions without any change press the **MENU** button again.

Please refer to the following diagram to address your DMX512 channel for the first 4 units:

4 Channels:

4D Channels:

4C Channels :

cut off the mains power immediately.

- Do not operate in dirty and dusty environment, also cleaning fixtures regularly.
- Do not allow children to operate the fixture.
- Do not touch any wire during operation as there might be a hazard of electric shock.
- Avoid power wires together surrounding other cables.
- Replace fuse only with the same type.
- In the event of serious operating problem, stop using the unit immediately.
- Never turn on and off the unit time after time.
- The housing, the lenses, or the ultraviolet filter must be replaced if they are visibly damaged.
- Do not open the unit as there are no user serviceable parts inside. Never try to repair the unit by yourself. Repairs carried out by unskilled people can lead to damage or malfunction. Please contact the nearest authorized technical assistance center.
- Disconnect the mains power if the fixture is not used for a long time.
- Do use original packing materials once transport it again.
- To prevent or reduce the risk of electrical shock or fire, do not expose the unit to rain or moisture.
- Do not look directly at the LED light beam while the fixture is on.
- To protect the machine, power off 10s rear can electrify.

When the power supply is 110V, do not connect in series much more than 7 units, use another mains supply for next 7 units. When the power supply is 230V, do not connect in series much more than 14 units, use another mains supply for next 14 units.

Installation

The unit should be mounted via its screw holes on the bracket. Always ensure that the unit is firmly fixed to avoid vibration and slipping while operating. Always ensure that the structure to which you are attaching the unit is secure and is able to support a weight of 10 times of the unit's weight. Also always use a safety cable that can hold 12 times of the weight of the unit when installing the fixture.

The equipment must be fixed by professionals. And it must be fixed at a place where is out of the touch of people and has no one pass by or under it.

2. Technical Specifications

- **Light source:** 3W LED x 54pcs
- **Voltage:** AC 100-240V/50HZ
- **Power consumption:** 145W
- **Lens Option:** D6, D15, D25, D30, D40, D60, D80
- **Dimension:** 300.6 x 229 x 340 mm
- **Weight:** 9.2 kg

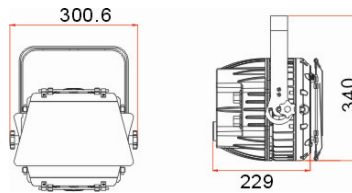

3. How To Set The Fixture

3.1 Control Panel

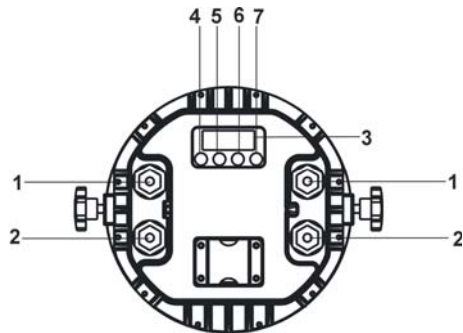

1: Power

Water proof connectors for power input/output

2: DMX input/output

Water proof connectors for DMX 512 operation, 3-pin XLR cable to link the units together

3: Display

To show the menu and the selected functions

1. If **FLASH** (flash mode) is selected, press **ENTER** button to confirm, then use **DOWN** and **UP** button to select the **WAIT**(wait time) or **STROBE** (strobe), Once select, press **ENTER** button to confirm. then use **DOWN** and **UP** button to adjust the the wait time or strobe speed (slow ,middle, fast) (1.....9). Once select, press **ENTER** button to store or automatically return to the main functions without any change after one minute. To go back to the previous functions without any change press the **MENU** button.
2. If **ROTATE** (flash mode) is selected, press **ENTER** button to confirm, then use **DOWN** and **UP** button to adjust the type of the rotation(1.....9). Once select ,press **ENTER** button to store or automatically return to the main functions without any change after one minute. To go back to the previous functions without any change press the **MENU** button.
3. If **FADE** (fade) is selected, press **ENTER** button to confirm, then use **DOWN** and **UP** button to adjust rotation time(1.....9). Once select ,press **ENTER** button to store or automatically return to the main functions without any change after one minute. To go back to the previous functions without any change press the **MENU** button.



Key Board Lock

Press the **MENU** button up to when the **Loc** is showing on the display. Press **ENTER** button and the display will blink. Use **DOWN** and **UP** button to select the **LOCK** (lock the key board) 或 **NO** (normal), Once select, press the **ENTER** button to setup or automatically return to the main functions without any change after one minute. Back to the previous functions press **MENU** button.



Self-Test

Press the **MENU** button up to when the, **TEST** is blinking on the display. Press **ENTER** button and the unit will run self-test by built-in program. To go back to the functions press the **MENU** button again.



LED

Press the **MENU** button up to when the **LED** is shown on the display. Press **ENTER** button and the display will blink. Use **DOWN** and **UP** button to select **ON** (display on) or **OFF** (display off 20 seconds after exit menu) mode. Once select, press **ENTER** button to setup or exit menu mode without any change after one minute. Back to the functions without any change press **MENU** button again.



Temperature Test

Press the **MENU** button up to when the **TEMP** is blinking on the display. Press **ENTER** button and the display will show the temperature of the unit. To go back to the functions press the **MENU** button again.

CoLo (color) and **White** (white) and **Dimm** (dimmer) for every step. Automatically return to the main functions without any change after one minute. To go back to the previous functions without any change press the **MENU** button.

Menu Manual Mode

Press the **MENU** button up to when the **Menu** is showing on the display. Press **ENTER** button and the display will blink. Use **DOWN** and **UP** button to select the **Red** (Red), **Green** (Green), **White** (White), **Dimm** (Dimmer) or **Shutter** (Shutter), Once select, press **ENTER** button to setup or automatically exit menu mode without any change after one minute. To go back to the functions without any change press the **MENU** button.

Balance Adjust White Balance

Press the **MENU** button up to when the **Balance** is showing on the display. Press **ENTER** button and the display will blink. Use **DOWN** and **UP** button to select the **Red** (Red), **Green** (Green), or **Blue** (Blue) mode. Once the mode has been selected, press the **ENTER** button to setup or automatically return to the main functions without any change after one minute. To go back to the previous functions without any change press the **MENU** button.

Disp Display Inversion

Press the **MENU** button up to when the **Disp** is showing on the display. Press **ENTER** button and the display will blink. Use **DOWN** and **UP** button to select the **Normal** (normal) or **Inverse** (inverse),

DMX DMX Control Mode

Press the **MENU** button up to when the **DMX** is shown on the display. Press **ENTER** button and the display will blink. Use **DOWN** and **UP** button to select the **DMX** (DMX control) or **Manual** (manual control), Once selected, press the **ENTER** button to setup. If **Manual** is selected, use **DOWN** and **UP** button to select **Flash** (Flash mode), **Red** (Red), **Green** (Green), **Blue** (Blue), **White** (White), **Yellow** (Yellow), **Purple** (Purple), **Cyan** (Cyan), **Whole** (Whole), **Rotation** (Rotation) or **Fade** (fade), press **ENTER** button to confirm, then use **DOWN** and **UP** button to adjust the dimmer(1...9).

Notice:

1.If **Flash**(flash mode) is selected, press **ENTER** button to confirm, then use **DOWN** and **UP** button to select the **Wait**(wait time) or **Shutter** (shutter), Once select, press **ENTER** button to confirm. then use **DOWN** and **UP** button to adjust the the wait time or shutter speed(solw ,midum, fast)(1.....9). Once select, press **ENTER** button to store or automatically return to the main functions without any change after one minute. To go back to the previous functions without any change press the **MENU** button.

Button:

4	MENU	To select the programming functions
5	DOWN	To go backward in the selected functions
6	UP	To go forward in the selected functions
7	ENTER	To confirm the selected functions

3.2. Main Functions

To select any functions, press **MENU** button until the required one is shown on the display. Select the function by **ENTER** button and the display will blink. Use **DOWN** and **UP** button to change the mode. Once the required mode has been selected, press **ENTER** button to setup or it will automatically return to the main functions without any change after idling one minute. Back to the functions without any change press **MENU** button. The main functions are shown below:

Once you set **Loc** to **925**, after running in show mode for 5 minutes without any change or restarting the unit, the key board become locked. Press **ENTER** button to enable the menu, the display will show **000**, press **UP** and **DOWN** button until it shows **111**, then press **ENTER** to unlock.

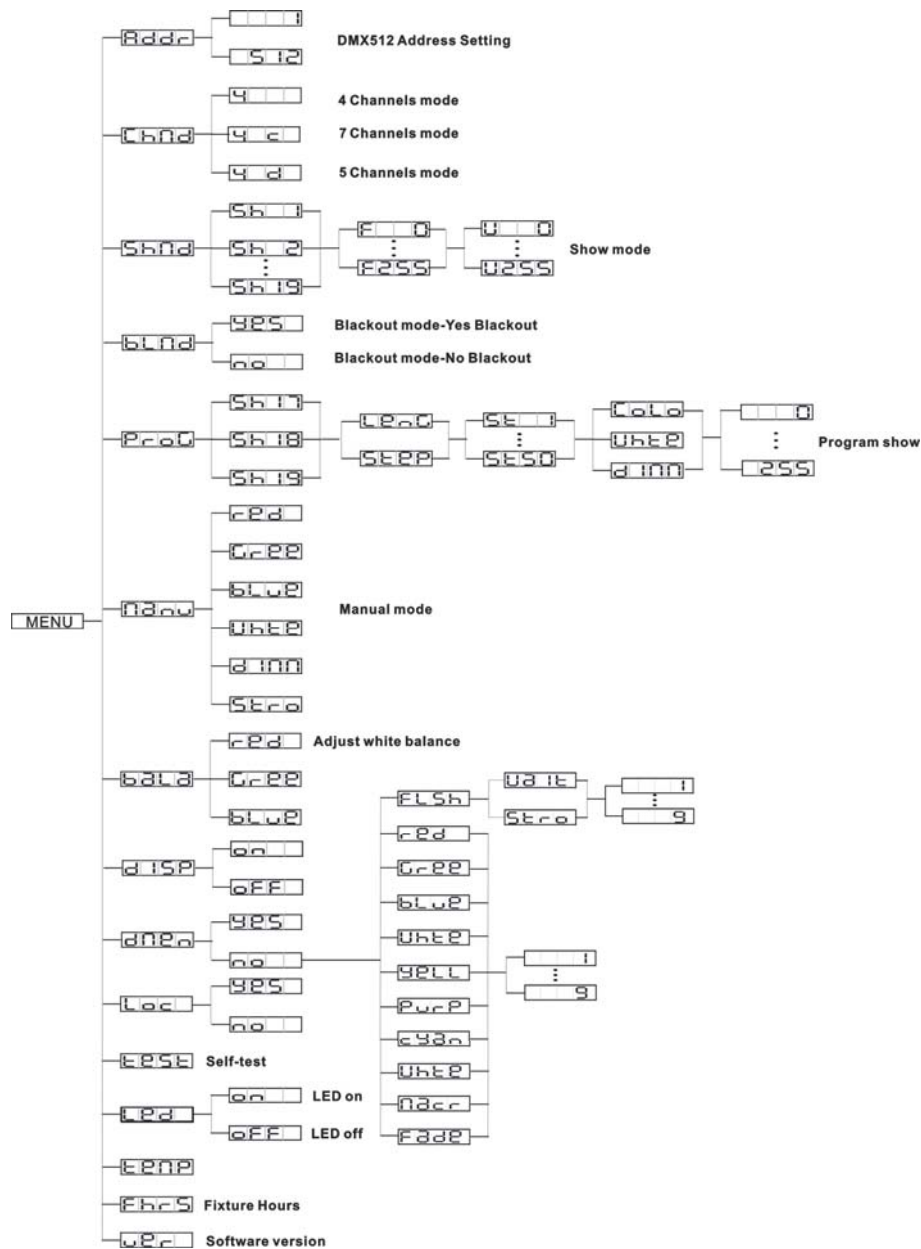

Addr DMX 512 Address Setting

Press the **MENU** button up to when the **Addr** is shown on the display. Press **ENTER** button and the display will blink. Use **DOWN** and **UP** button to change the DMX 512 address. Once the address has been selected, press **ENTER** button to setup or automatically exit menu mode without any change after one minute. Back to the previous functions without any change press **MENU** button.

Chnd Channel mode

Press the **MENU** button up to when the **Chnd** is shown on the display. Press **ENTER** button and the display will blink. Use **DOWN** and **UP** button to select the **4** (4channels), **7** (7channels) or **5** (5channels), Once select, press **ENTER** button to setup or automatically exit menu mode without any change after one minute. To go back to the functions without any change press the **MENU** button.

Shnd Show mode

Press the **MENU** button up to when the **Shnd** is shown on the display. Press **ENTER** button and the display will blink. Use **DOWN** and **UP** button to select the **5** (show 1) ... **19** (show 19), Once select, press **ENTER** button to setup. press the **ENTER** button, **F 00** will blinking on the display, use **DOWN** and **UP** button adjust the fade time (0~255), press **ENTER** button to store and **0 00** will blinking on the display, use **DOWN** and **UP** button adjust the white time (0~255), press **ENTER** button to store or automatically return to the main functions without any change after one minute. To go back to the previous functions without any change press the **MENU** button.

Blnd Blackout mode

Press the **MENU** button up to when the **Blnd** is showing on the display, Press **ENTER** button and the display will blink. Use **DOWN** and **UP** button to select the **Yes** (blackout) or **no** (normal), Once select, press **ENTER** button to setup or automatically exit menu mode without any change after one minute. To go back to the functions without any change press the **MENU** button.

Prog Program Shows

Press the **MENU** button up to when the **Prog** is showing on the display. Press **ENTER** button and select the **Prog** mode, Press **ENTER** button and the display will blink. Use **DOWN** and **UP** button to select the **5** (Show 17), **18** (Show 18) or **19** (Show 19), Once the show has been selected, press the **ENTER** button to enter setting program. Use **DOWN** and **UP** button to select **LE 00**(length, the steps, you choose from the total amount of steps, you want to run, for example, if the total amount of steps you set is 50, you can choose only first 1-10 steps to run). **STEP** (step), select **STEP** to set