

Pulse Room

By Rafael Lozano-Hemmer



CONTENTS

General important information

This short section must be read for proper operation

Description

General setup information

General tear down information

Visitor throughput

Lighting

Exhibition space

Required power

Cleaning and maintenance

Detailed technical information

A technical reference for preservation, maintenance and troubleshooting

Troubleshooting

Appendix I – Step by Step description

Appendix II – List of Components

Appendix III – Wiring diagram

Appendix IV – Chauvet dimmer pack manual

Appendix V – Installation pictures

General important information

For support please contact Rafael Lozano-Hemmer's studio
Antimodular Inc.

4060 Blvd. St-Laurent, studio 107

Montréal Québec H2W 1Y9 Canada

Tel. 1-514-597-0917

Fax 1-514-597-2092

www.antimodular.com

tech@antimodular.com

Pulse Room (2006)

By Rafael Lozano-Hemmer

Technique

Incandescent light bulbs, voltage controllers, heart rate sensors, computer and metal sculpture

Dimensions

Variable dimensions

Electrical details

31000 Watts for 100 bulbs, 120V-240V 50/60Hz

Description

Pulse Room is an interactive installation featuring one to three hundred clear incandescent light bulbs, 300 W each and hung from a cable at a height of three metres. The bulbs are uniformly distributed over the exhibition room, filling it completely. An interface placed on a side of the room has a sensor that detects the heart rate of participants. When someone holds the interface, a computer detects his or her pulse and immediately sets off the closest bulb to flash at the exact rhythm of his or her heart. The moment the interface is released all the lights turn off briefly and the flashing sequence advances by one position down the queue, to the next bulb in the grid. Each time someone touches the interface a heart pattern is recorded and this is sent to the first bulb in the grid, pushing ahead all the existing recordings. At any given time the installation shows the recordings from the most recent participants.

Operation

1. Turn on power to all dimmer packs.
2. A key is provided to open the metal structure and access the computer inside. To turn the piece ON, start the computer by pressing its start button. The Computer will boot in to Windows. After that our automatically software starts and the light bulbs will show the last 100 heart beats.
3. Test the piece by holding the heart rate sensor until a new beat is detected.
4. To turn the piece OFF, press the computer's power button. Our software will turn all light bulbs off and then the computer will shut down.
5. If desired, the power to the dimmer packs can now be turned off.

General setup information:

3-6 days with one technician from Rafael's studio in Montreal and 2-4 local technicians, depending on their experience.

The technicians should be equipped with a basic toolbox and some wire stripping pliers, used to make the bulb cables. Appropriate ladders and scaffolds will be required to hang each one of the 100 bulbs at a precise position and height. A drill may also be necessary, as well as any other tool needed to modify the space to accommodate the piece.

Furthermore, some ceiling fixtures will be required for the hanging. These should be provided by the venue or the organization supporting the event, along with the appropriate tools to install them. If drilling in the ceiling is not allowed, one possible solution could be to install horizontal poles held in place by the outside pressure they apply to two opposing walls.

Finally, the dimmer packs described later will need to be placed somewhere safe. If they are to be placed close to the ceiling, the appropriate fixture must be installed. If they are to be placed in an adjacent room, the bulb cables must be able to reach them, as well as the DMX cable from the metal structure.

General tear down information:

1-2 days for 2 technicians to bring down the installation and pack it up neatly. The same tools should be available as the ones used for the setup.

Visitor throughput:

50-150 participants can use the interface every hour. The number of people who can observe is dependant upon the exhibition space.

Lighting:

All light and daylight sources other than the piece itself should be eliminated and minimized as much as possible in order to get the full effect of the piece.

Exhibition space:

Pulse Room's visual effect is greatly influenced by the way the light interacts with the spatial and architectural setting. While the installation can cover anywhere from 100 to 1000 square meters, the resulting effects will vary greatly.

In the case of a large space where the bulbs are far apart, they will be set to light more intensely. The result will be an intricate and sometimes disorienting environment of moving shadows that tends to bring out any architectural features or lack thereof. It is in this kind of setup that architectural features are most highlighted.



In the case of a small space, the bulbs will be closer together, and their intensity diminished to a peak of around 30W so as to make it possible for them to be looked at comfortably. In this case, it is the array of bulbs that will capture more visual attention. The final result is a warmer and more intimate lighting environment.



One option to consider when adapting Pulse Room to any given venue is the possibility of placing the interface somewhere outside of the room where the main array of lights resides. A trail of pulsing lights would then lead the participant from the interface to the main room, as his pulse follows the same trail.

In all cases, for safety reasons, the floor should be free of any ankle-high obstacles, as the participants in the half-lit room may often be wandering around while looking up.

Required power:

The maximum power drawn by a 100-bulb Pulse Room is 31 000 Watts. While the power source should be able to provide this, the bulbs do not normally run at full intensity, so the average power usage actually varies between 1000 and 10 000 Watts, depending on the setup.

The interface should be on a different circuit than the units into which the bulbs are plugged. This will allow the person responsible for maintenance to turn everything off except for the computer inside the interface, which will stay on all the time.

Cleaning and maintenance:

Bulbs

The lifespan of a bulb can vary greatly depending on the model and the bulb itself. 1000 hours is a conservative estimation for a bulb running at full capacity, but since the bulbs in Pulse Room are never at full power, one can reasonably expect them to last for 3000 hours. Still, some spares should always be available, as accidents can happen.

Dimmer packs

Some dimmer packs may also fail in some unfortunate circumstances such as power surges. These are easily replaced by following some simple technical instructions provided with the piece.

Pulse sensor stand

Wipe down the Pulse Stand when it looks dirty. Use a soft fabric that is slightly damp. If needed use a bit of soap. Do not get the pulse stand wet, since it houses electronics.

Appendix I – Step by Step description

Detailed technical description:

* The first material element to consider is the interface and the elements that comprise it. It is supplied by Rafael's studio in Montreal, along with any spare parts deemed useful. This chest-high metal structure, displayed in plain sight, presents the participants with 2 handgrip sensors. Inside the structure, the sensors are connected to an embedded computer. The computer analyses the data it receives from the sensors and models the appropriate pulse dynamics.

The computer is also responsible for controlling the state of every bulb in the room. This information is updated many times per second via a USB connection to a DMX circuit board, also embedded inside the base of the metal interface. The DMX circuit board translates this data into a DMX signal, which is sent to the dimmer packs into which the bulbs are plugged.

Two cables need to come out of the metal interface. The first is a power cable, to power the computer and the sensors. The second is a DMX cable, through which information is communicated from the computer to the dimmer packs that continuously control the power going to the bulbs.

* The second material element to consider is the dimmer packs and DMX cabling. These are supplied by Rafael's studio in Montreal, along with extras. 4 bulbs are plugged into each dimmer pack and controlled independently. So, for a 100-bulb room, 25 dimmer packs are required. The dimmer packs need to be powered, and they receive data through their DMX ports. They are plugged in series. So, from the sculpture a DMX cable plugs into the first dimmer pack. Another DMX cable exits the first dimmer pack and enters the second one, and so on, until all of them are chained in this way.

The dimmer packs are generally hung close to the ceiling and made visually discreet. Alternatively, they could be stacked in an adjacent room.

* The third material element to consider is the bulbs and their cabling. This is supplied by the venue or the organization supporting the event. The bulbs used are 300W, incandescent, equipped with standard medium screw base, clear glass and possessing an "A" shape, also called "pear" shape. In the unlikely event that 300W bulbs cannot be found, 200W can be used, but the bulbs must be as big as possible, and all other specifications noted above must be respected.

The bulbs should hang at around 3 meters from the floor, all at the exact same height. The bulbs plug into their associated dimmer packs. Because the setups vary, bulbs, sockets, 2-prong cable and plugs should be bought in bulk and assembled by hand. The sockets and cable should be black and discreet.

Installation procedures:

Appendix III shows the basic setup (wiring diagram) for Pulse Room. Refer to it throughout the installation procedures.

Preparing the room:

As mentioned previously, the size and nature of a room inhabited by this piece can vary greatly. Each venue presents new challenges and possibilities that should be dealt with on a case-by-case basis.

Thought must be given to how the bulbs will be hung, especially in venues of high historical value where the integrity of the construction must be carefully preserved. In such cases, devices such as outward pressure poles may be required to ensure a clean and safe installation of the bulbs.

Bulb placement:

In a normal Pulse Room, the bulbs are placed in a grid, with constant distances between neighboring bulbs. They can be in a perfect square, or a rectangle, depending on the proportions of the room. If the shape of the room calls for something other than a grid configuration (an “L” shape for example), the bulbs should still form a regular pattern without any breaks in continuity.

The first bulb at the sensor interface should stand out from the grid. It should also be lower than the others, somewhere around 1.7 meters off the ground. The next couple of bulbs after the first do not have to fit the grid rule perfectly. Instead, their placement should underline the direction of the flow of pulses throughout the room by providing a geometrically logical transition from the singularity of the first bulb to the collective and organized nature of the grid. For a simple example of this, look at Appendix A, and notice how the second, third and fourth bulbs from the bottom reveal the direction in which the heartbeats are being offset throughout the rest of the grid.

Once established, bulb placement should be noted precisely on a floor plan for future reference and use. Also, assign numbers to the bulbs starting with 1, the bulb at the interface, and following the order and direction in which the pulses are intended to flow. Look at Annex A for guidance on this. As people use the interface, their recorded heartbeats will move over by one position when a new person participates. These sequential positions are what the numbers represent.

Dimmer pack placement:

When bulb placement is decided, you can look at where the Chauvet dimmer packs will reside. Each dimmer pack receives 4 plugs, each from a different bulb, and a XLR data cable. The position of every item should be determined precisely before anyone climbs a ladder.

Appendix III shows the simplest topology for a Pulse Room. It is likely that your grid will not consist of 4 bulbs by 25 bulbs like the one in this example, so you will have to think about how each bulb will reach its dimmer pack, and how each dimmer pack will be connected with the others using XLR cable.

An XLR cable comes out of the bottom of the sensor interface and must make its way to a Chauvet dimmer pack. Another cable comes out of this first unit and goes to a second one, until all the units are daisy chained. The order in which they are chained is not important. What should be considered are the necessary cable lengths, the optimal distribution of these items around the room, and what's available.

Note that it is not recommended to run more than 50 meters of uninterrupted XLR cable. This could cause the signal to weaken, at which point all the data communicated down the chain becomes much less precise. While this should not be a problem in spaces that respect the maximum recommended surface of 1000 square meters, a potential solution for this unlikely issue would be to incorporate a DMX signal splitter-repeater into the XLR topology.

There are two ways to secure the DMX units. They can be hung on the ceiling, close to the bulbs, or they can be stored in an adjacent room or closet.

Putting the dimmer packs in another room has the advantage of keeping the units available for troubleshooting. It will also save XLR cable, but will require a very large amount of bulb cable, as even the furthest bulbs will need to reach the units. It is very likely that the venue does not have such a room available. Lastly, if this method is chosen, ensure that the XLR cable running from the interface to the first dimmer pack does not exceed the recommended limit of 50 meters.

Putting the dimmer packs on the ceiling saves on bulb cable, but may require more XLR cable, although this cable may be already be available in long stretches. This is how Pulse Room is usually set up, as it is a more universal solution.

Once you've determined where the dimmer packs will reside, note the exact position of each one on the floor plan. Then note how each bulb will reach its dimmer pack with its electrical cable. It is likely that this cable will make right-angle turns that should be represented here. Also note how the units will connect to each other, and make sure you have the appropriate cable lengths. Your floor plan should now show the same details as Appendix IV, but adapted to your room. Once you've decided how the cables will run on the ceiling, the bulb cable can be cut at the appropriate lengths, including any height considerations, plus some extra leeway. Fix the sockets onto the cut cable, then run and hang them using the fixtures appropriate for the room. Number the plug end of each cable appropriately with a piece of tape so it can be easily identified later. Be careful to position all the sockets precisely at the exact same height and at the exact position dictated by the overall configuration. Once the cable is in place, install the plugs on the other end.

Programming the dimmer packs:

Before they are hung or secured, the Chauvet dimmer packs need to be programmed with the right address and settings using their simple embedded interface. The following is a step-by-step procedure to set up the dimmer packs. If needed, the complete user guide is available in Appendix IV.

First, at the bottom of each Chauvet, you will find a switch to set the Chauvet to receive 100V or 220V (newer units do not have this switch any more, they are auto switching). This switch must imperatively be set to the appropriate voltage depending on the power source and the local standards, and this voltage must be constant. Once the switch has been verified, plug the unit in and turn it on. You may need to flick the I/O switch next to the power input.

The small LED display at the top of the unit should light up. There are 4 buttons to navigate through the dimmer pack's options. First, the "Mode" button is used to switch between "Receive" (A***) and "Chase" (P:**). The "Chase" mode presents automated sequences – it is not what we want, but can occasionally be useful to test the bulbs. Choose the "Receive" mode, which allows the dimmer pack to be controlled via a DMX signal sent by the computer.

The display should now show "A***" where "***" is a number between 001 and 512. This is the

address of the first of the 4 DMX channels of the unit. On the first Chauvet unit should be set to "A001". Do this using the arrows. On the second unit, it should be "A005", on the third "A009", etc., in increments of 4, up to the 25th unit, which should be set to "A097". Note that these numbers do not have to match the bulb numbers on the floor plan. This correspondence will be ensured through the computer software, which we will set up later. As you set the address of the dimmer packs, label them accordingly with some masking tape to make their installation easier.

Next, the "Menu" button allows us to cycle through the options available in this mode. Pressing it once takes us to the channels setting. This option should be set to "CH:04", which makes all 4 channels independent. If this is not the case, use the arrows to change it.

Pressing the "Menu" button again takes us to "S1", which should be set to "oF". If it is set to "oN", press one of the arrows once to change it. Pressing "Menu" again takes us to "S2", "S3" and "S4", which should all be set to "oF" in the same way.

Installing the interface:

Appendix IV details all the elements contained in the metal stand. You may need to refer to it throughout the following instructions.

The sensor interface needs a power input, as well as data output through an XLR cable that runs to the closest dimmer pack. These cables will run on the floor, and need to be covered to look clean and allow for unobstructed circulation.

When these cables are plugged, the computer should boot up automatically. Give it a few minutes to load Microsoft Windows and the Pulse Room software. The behavior of the bulbs is unimportant at this point, as we are just about to set them up. Once the computer has booted, open the base of the pulse stand using the appropriate key. Ensure that the handgrip sensors are in place, and that the cabling inside the sculpture is consistent with the diagram presented in Appendix IV. On the computer, remove the DVI dummy and plug in a display instead, as well as a mouse and a keyboard in the unused USB ports.

When the display is plugged, the interface should look something like this:

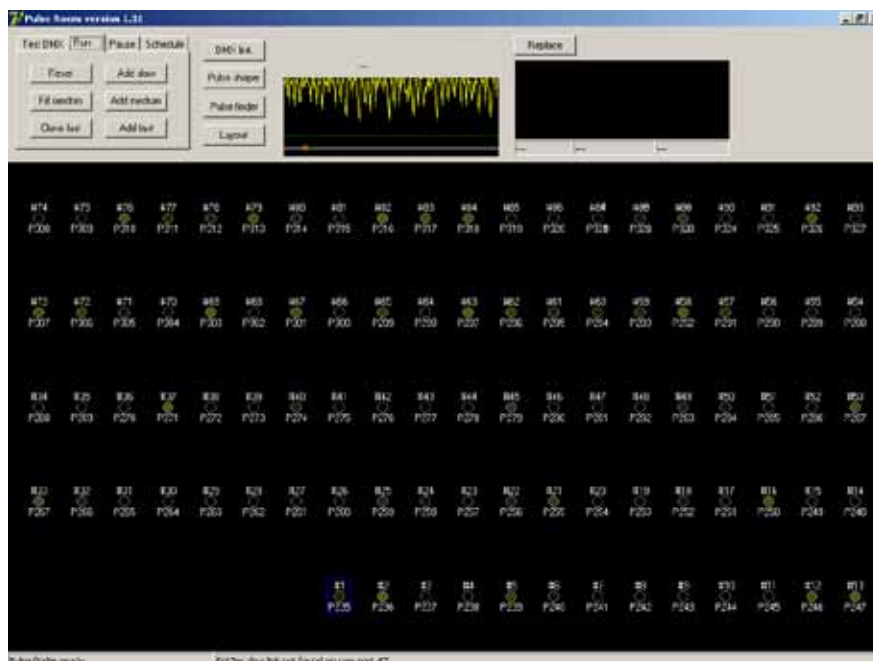

Your resolution may be different, or the bulb layout may not be the same. This is fine. Adjust the resolution of the screen to your liking, and we will soon work on adapting the layout to your situation.

First, at the bottom left of the Pulse Room software interface, make sure “Pulse finder ready” and “DMX link ready” are indicated.



If you see “Pulse finder not ready”, it is very likely that the wireless module that gets the signal from the sensors is unplugged via USB. In that case, make sure it is plugged, close the Pulse Room software and reopen it by clicking its shortcut on the desktop. Verify again that the software indicates that the pulse finder is ready. If it is still not ready, there may be a problem with the wireless module of the sensor interface. Try replacing it with an extra unit, see if the issue is fixed.

If you see “DMX link not ready”, it is very likely that the Enttec USB-DMX adapter is unplugged via USB. In that case, make sure it is plugged, close the Pulse Room software and reopen it by clicking its shortcut on the desktop.

You should also check if the Enttec USB-DMX has the right port assigned.

Exit the software, click on the “Start” button on the bottom left of the screen, select “control panels”, a window opens, select “System”, a window opens, select “Hardware”, click on the “Device Manager” button, a window opens, click on “Ports” and which COM port the USB serial Port is assigned to.

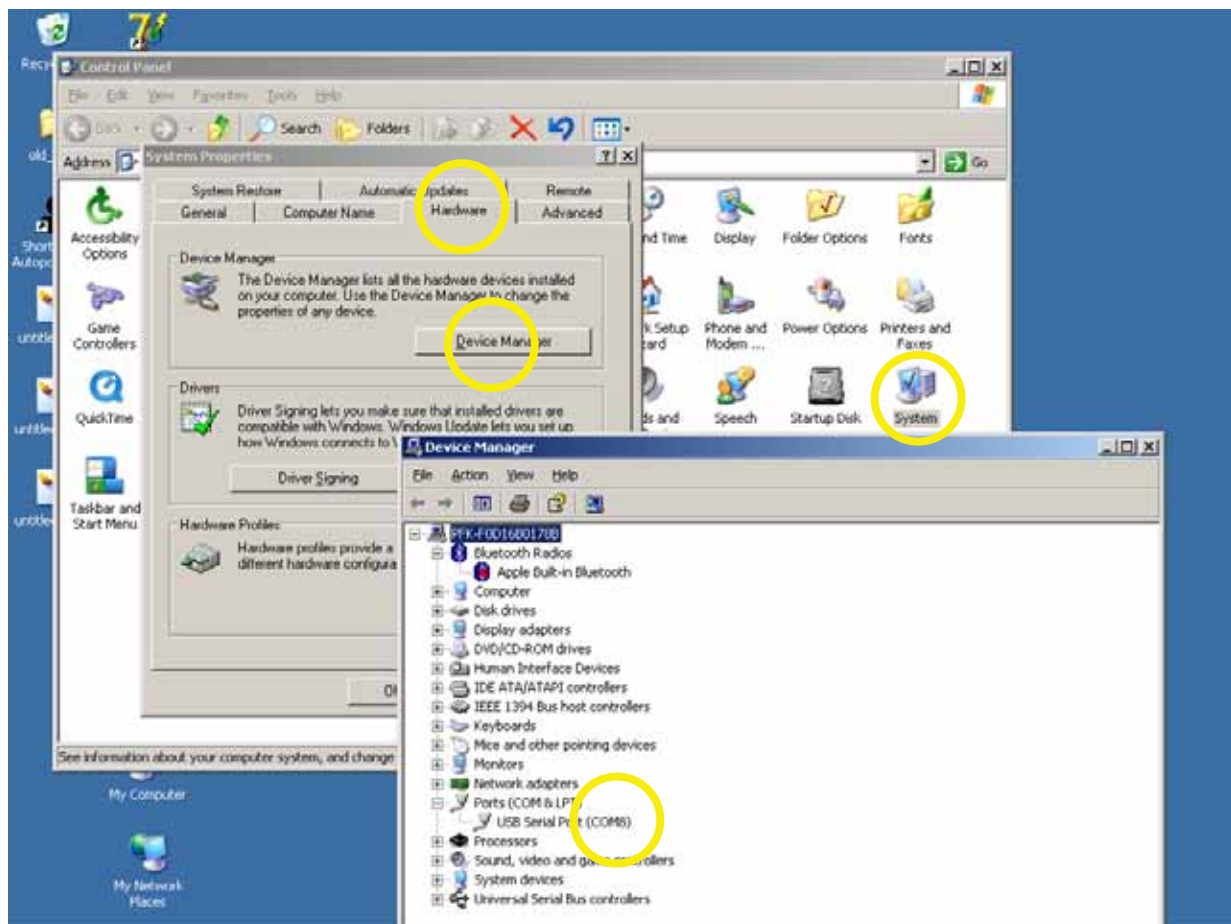

Now close all these windows and go back to the Pulse Room software. Click on the “DMX Link” button. A window opens. Enter the “COM” port number in to the field “Enttec on port#”.

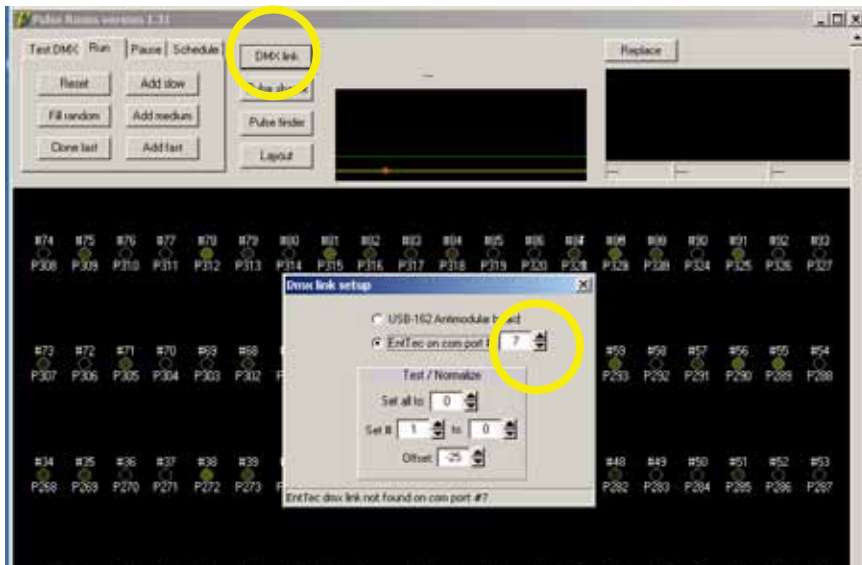

Verify again that the software indicates that the DMX link is ready now. If it is still not ready, there may be a problem. Try replacing it with an extra unit, if one is available, and see if the issue is fixed.

We will now test that the bulbs are responding to the signal being sent from the computer to the USB-DMX adapter, to the dimmer packs, to the bulbs themselves. At this point the bulbs should be plugged into the dimmer packs, the DMX daisy chain between the dimmer packs should be done, and the dimmer packs should be programmed and turned on. Also, at the pulse stand, the DMX cable - that runs to the first Chauvet dimmer pack - should be plugged in to the Enttec DMX-USB adapter.

Once all of these connections have been confirmed, go to the computer at the pulse stand, and on the Pulse Room software interface, at the top left corner, click the “Test DMX” tab. The variables presented in this tab are useful for testing purposes, like locating a particular bulb, for example. Currently, our goal is to confirm that the bulbs are responding to the signals sent by the computer. Increase the number in the “Set all bulbs to” text field, and continue increasing it until the bulbs in the room go from dark to dim. If this happens, our DMX connection is working well.



If the bulbs are not responding, something down the chain is not set up properly. Make sure the Enttec USB-DMX is plugged via USB to the computer. Make sure the DMX 3 pin to 5 pin adapter is plugged in to the Enttec USB-DMX correctly. Make sure it is connected to a DMX cable going all the way to the first dimmer pack. Make sure the dimmer packs are turned on and programmed properly. Make sure the bulbs are plugged into the dimmer packs.

Once the bulbs are indeed responding, we can start making a proper layout in the software and giving our bulbs the proper addresses. On the Pulse Room software interface, click the "Layout" button. This will bring up a new window giving us an editable version of the layout seen previously on the main interface. How the bulbs react when you do this is unimportant.

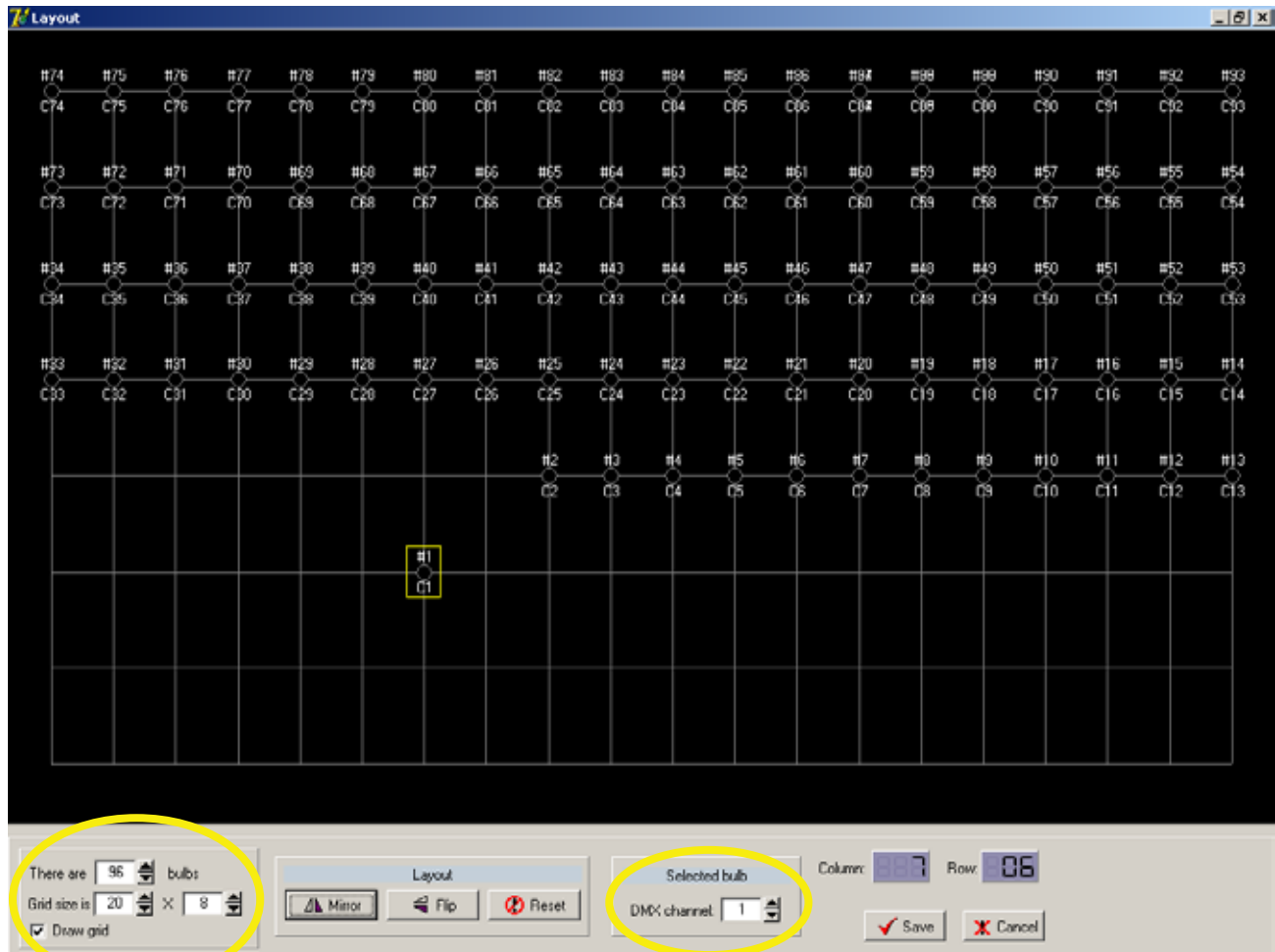

First, modify the grid size to make it bigger than what you have in reality. This will give you some freedom when manipulating the bulbs. At the bottom left of the interface, change "Grid size is ?? X ?? " text fields to give yourself more columns and rows than needed on the interface. Then specify the exact number of bulbs present in your setup (including the low bulb at the sculpture) in the "There are ?? bubs" text field.

You should now have an ample grid containing the number of bulbs you will need. The bulbs on the layout can be dragged around on the grid. Some of them may be presently overlapping, but ultimately, each will have its own place. Notice that each bulb has a "#" number above and a "C" number below. The "#" number of a bulb specifies in which order it will be lit, while the "C" number should indicate which DMX channel this bulb is plugged into. In other words, the relationship between these variables allows you to change the order of the bulbs on the layout

to accommodate a situation where the bulbs of the setup are not sequentially plugged into channels 1, 2, 3, etc. of the programmed dimmer packs.

In an ideal setup, the first bulb of the setup would be plugged into the first channel of the first Chauvet unit programmed to "A001", the second one into the second channel and so on, until the last bulb is in the last channel of the last Chauvet programmed to "A097", for example, if the room has 100 bulbs. However, there may very well be cases when the topology calls for a dimmer pack programmed at "A001" to in fact receive bulbs 1, 2, 9 and 10, for example. The layout window in the software allows us to ensure that the correct bulbs are always lit in the correct order, so that the pulses may travel across the grid in the intended fashion.

First, arrange the bulbs on the layout according to their "#" number, paying no attention to their "C" number yet. Carefully consider where the sculpture will be on the layout, and place there bulb #1. Place all the other bulbs according to their "#" number in relation to the order in which the pulses are intended to travel. Once all the bulbs have been positioned on the layout in this way, you can reduce the grid to the size you really need. Be careful when doing this, as reducing the grid size too much will result in overlapping bulbs, at which point you will be forced to redo the truncated part of the layout.

Once all the bulbs are in place according to their "#" number, it is time to assign the appropriate channel ("C" number) for each bulb. In the ideal setup described previously a bulb would have a "C" number equal to its "#" number, but this may not be the case for your setup. What we want to do now is tell the computer the channel number of every bulb. Start with bulb #1. It is plugged into a dimmer pack. What is this dimmer pack's address? Which channel of the dimmer pack does the bulb plug into? (Which of the 4 power outlets in the dimmer pack does the bulb plug into?) For example, if bulb #1 plugs into channel 3 of dimmer pack with the DMX start channel "A005", then the "C" number for bulb #1 is 7. Enter this number by clicking on bulb #1, and entering "7" in the text field called "DMX channel" at the bottom of the interface. Find the channel of every bulb on the layout and type it in as its "DMX channel". When you are done, the layout should be essentially identical to what is set up physically in the room. Click the "Save" button.

We are back at the main interface, and we will now test that every single bulb is being accessed as intended. Under the "Test DMX" tab, bring the "Set all bulbs to" text field to 0. Then, in the first two text fields, enter 1 and 150, so that the sentence reads "Set bulb #1 to 150". At this point, the first bulb, the one at the sculpture, should light up, while all the other ones should be dark. Increase the bulb # by one progressively, so as to light up #2, then #3 and so on until the last bulb. As you do this, carefully watch that the bulbs are lighting up in the right order.

If the order is wrong or if a bulb doesn't light up, verify that the layout was done correctly. Check that the dimmer packs are programmed properly. Make sure the bulb itself is not burned out. Make sure the bulbs power cable is not broken. If the problem persists, try changing the dimmer pack.

Once all the bulbs are working and in the right order, it is time to look at the pulses and the overall look of the room. Go to the "Run" tab. Click the "Fill random" button to fill the room with some automatically generated pulses. The room should now be blinking with simulated pulses. The handgrip sensors should also be working. You can test that out now. After 15 seconds of holding the handgrips, the first bulb should start beating with the rhythm of your heart. When you let go, the room should turn off for a couple of seconds, and turn back on with your pulse transferred to the next bulb.

What we are going to do now is adjust the overall brightness of the room. Press the “Pulse shaper” button to bring up a window where the features of the pulses can be tweaked. The sections of the interface called “Primary” and “Secondary” both contain an “Amplitude” variable. Increasing or decreasing these values changes the intensity of all the heartbeats in the room. In general, you’ll want to keep these proportional in such a way that the secondary beat has an intensity value equal to about three fifths of the primary value.

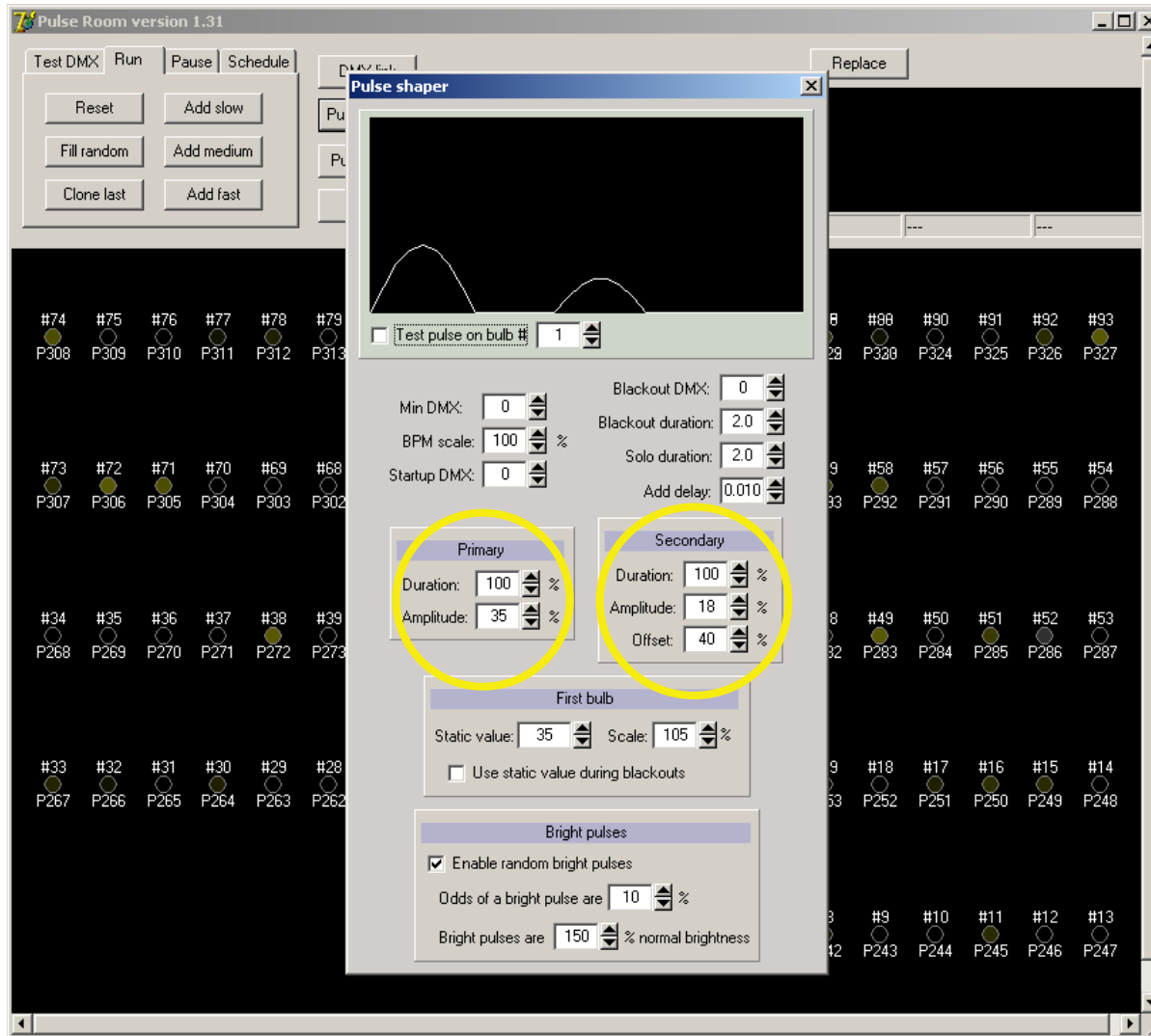

Note that the changes to the pulses will only take effect when you close the “Pulse shaper” window.

Setting these values is extremely important for the final look of the room. What we ultimately want to achieve is the highest possible visual contrast in the space between the places and moments when the lights are off, and the places and moments when the lights are on. The goal is to highlight and maximize the syncopation of the lights for anyone looking at the space.

In a very large space, this means the bulbs will be set to be very bright, so as to each have a maximum impact on the space being lit. On the other hand, a small room - where the bulbs are very close together - calls for a more subtle range of intensities. In a small room, bright bulbs would simply flood the space with light, and all contrast would be eliminated. This is undesirable. It is important at this point to spend some time playing with the intensity settings and looking at



the reflective and specular properties of the room to determine the appropriate intensity of the bulbs.

Once you've calibrated to find the ideal intensity for your particular setup, you'll also want to make sure that the difference between the primary and secondary pulses is well defined. A pulse is made of two beats, and those should be apparent in the bulbs. To maximize the clarity of the pulses, you will have to play with other properties of the beats. Both for the primary and secondary, you can specify an average duration. Obviously, very short durations for both will give you great definition, but it doesn't make for a very nice pulse. Play around with this value to strike a nice balance. Another variable to factor in is the offset of the secondary beat in relation to the first. This will also help you shape the pulse into a pattern that can be better noticed. Be aware, however, that since the pulse is essentially looping in nature, offsetting the secondary beat too far will give you strange results.



Appendix II – List of components



Parts provided by Lozano-Hemmer studio:

#	Component	Description	URLs	Image
26-30	Chauvet DMX-4	dmx dimmer	http://www.chauvetlighting.com/dmx-4-led	
1	Metal stand	houses sensor, computer, dmx controller		
1-2	Mac mini	computer with Microsoft Windows	http://www.apple.com/ca/macmini/	
2-5	Vernier Heart sensor	handgrip heart rate monitors, with CR2025 battery	http://www.vernier.com/products/sensors/hgh-bta/	
1-3	Vernier Go!Link	wireless to USB interface for handgrip sensor	http://www.vernier.com/products/sensors/hgh-bta/	
1-3	ENTTEC USB-pro	DMX to USB interface	http://www.enttec.com/index.php?main_menu=Products&prod=70304&show=description	

25-35	3 pin DMX cables	3-5 feet long, to daisy chain dimmer packs		
10-17	3 pin DMX cables	10-50 feet long, to connect first dimmer pack with computer		
1-2	DMX adapter	5 pin male to 3 pin female		

Parts provided by the venue:

#	Component	Description	URLs	Image
120-200	Incandescent light bulb	300W, E 27 socket, clear/ transparent, "A" shape		
100-110	bulb sockets	E 27, simple, black, discreet, cable entry on top		
100-110	power plugs	2-prong plugs that will plug the bulb cables into the Chauvets (whether these are American or European should be discussed beforehand)		

100-110	cable	2-prong lamp-style cables from bulbs to Chauvets (black, bought in bulk, round)		
1	description + light	illuminated sign with explains on how to interact		
6-12	stanchions	stanchions with appropriate rope to guide the public around the sensor interface (discreet, fitting with the room)		
		hanging fixtures for bulbs and possibly Chauvets		
		scaffolds, ladders and basic tools		

Appendix III – Wiring diagram

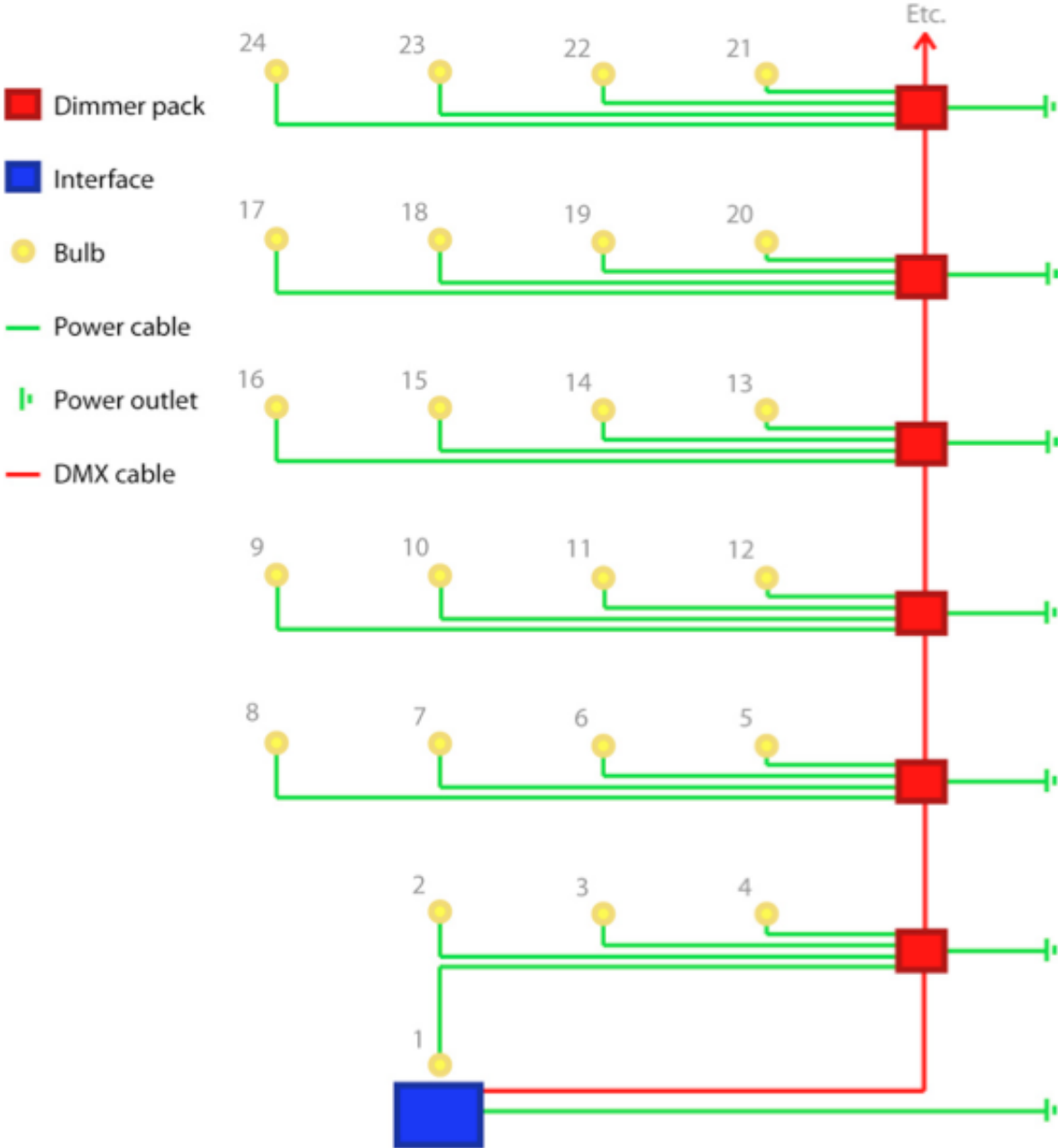

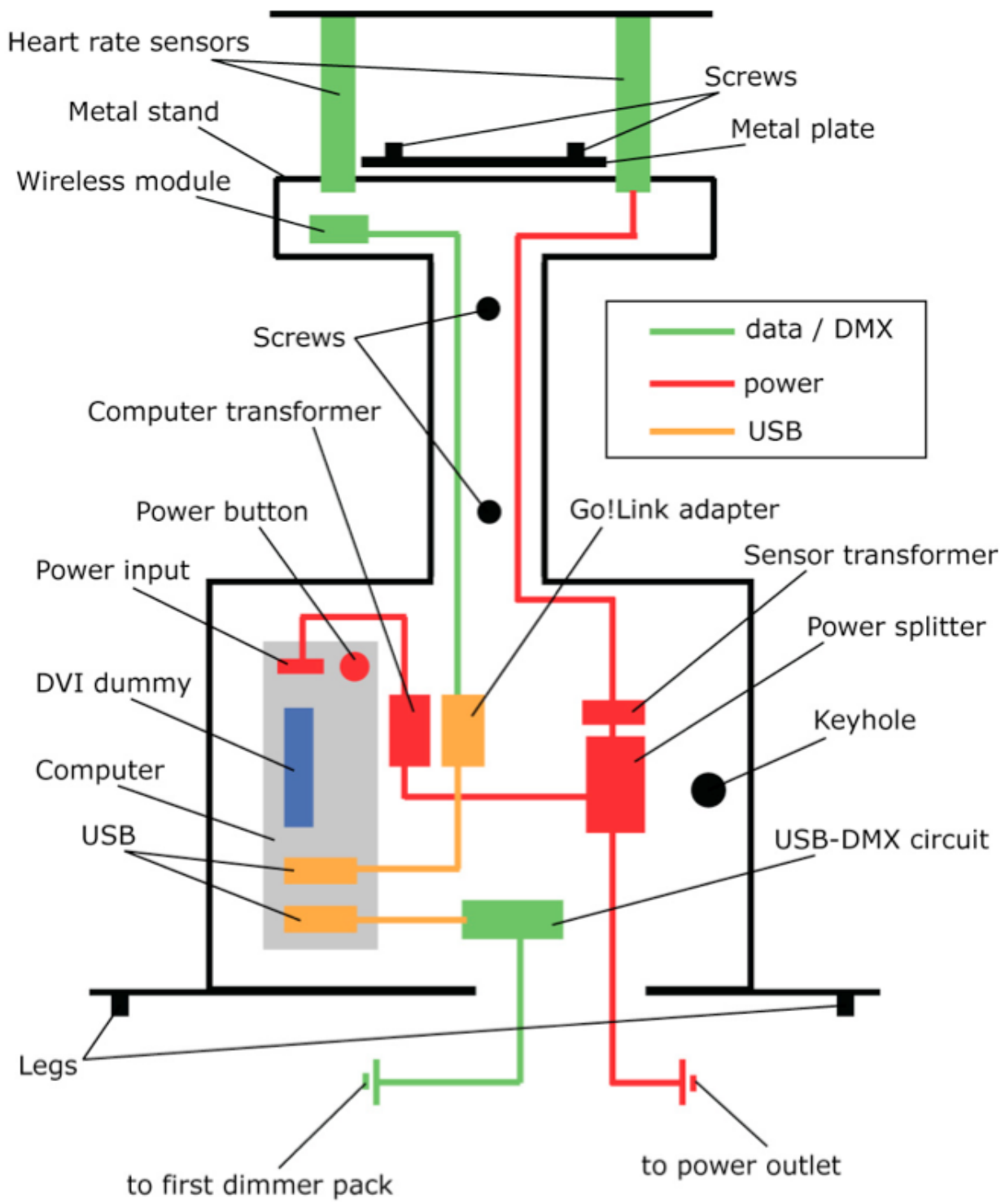

- Metal stand: Also referred to as “sculpture”, “structure” or “interface”, this is essentially the physical support for the heart sensors, and it contains the important elements that drive the piece. Two cables exit the metal stand. The first is a DMX cable to send data to the dimmer packs, and the second is the power input, which can take both European and American power.
- Legs: These adjustable legs provide the sculpture with some balance and allow it to be elevated just enough for cables to pass under.
- Keyhole: The metal stand is equipped with a lock, and the provided key is necessary to access the equipment inside.
- Metal plate: Between the handgrips lies a metal plate that squeezes them in place.
- Screws: There are two sets of screws on the sculpture. The first one holds the metal plate in place between the handgrips. They have a 1/8th inch Allen key head. The second one holds the top and bottom parts of the sculpture together, as it can separate into 2 pieces for shipping purposes. These have 5/32 Allen key security heads, meaning they require an uncommon type of bit, which is provided with the piece.
- Heart rate sensors: These sensors monitor the blood flow in the hands of the participant and send the resulting data to the computer for analysis. They resemble the sensors that one would find on an exercise machine. They should be kept clean. They have been modified to be powered through a DC transformer and they send their data wirelessly to a small module below.
- Sensor transformer: This is a 3V to 3.3V AC/DC transformer with auto-switching input, meaning it can be used in Europe and the Americas without worrying about the change in voltage. It plugs into a power splitter inside the sculpture.
- Wireless module: This little box receives data wirelessly from the sensors and sends it towards the computer. It should be secured in place facing the direction indicated by the arrow printed on it. It connects into the Go!Link adapter.
- Go!Link adapter: This module converts the sensors’ data into a USB signal understood by the computer. It receives an uncommon plug from the wireless module, and plugs into the computer via USB.
- Computer: This computer is a Mac Mini with a 1.66 GHz intel core duo processor and 512 megs of RAM. It runs Windows XP, and the piece starts up automatically when the computer boots. The important elements of the computer are as follows: a USB plug from the Go!Link adapter to receive data from the sensors, a USB plug to the USB-DMX circuit to control the bulbs, a DVI dummy to simulate the presence of a display, a power input and finally, a power button.
- Power button: Pressing this once turns the computer on or off. In both cases, it takes the computer a couple of minutes to do this.
- Power input: This plug brings power to the computer from the transformer.
- DVI dummy: This modified VGA adapter is designed to fool the computer into detecting a display. Without it, it would not boot.
- USB: Two USB plugs enter the computer. The first is from the Go!Link adapter to receive data from the sensors, and the second goes to the USB-DMX circuit to control the bulbs.
- USB-DMX circuit: This unit takes data from a USB cable it receives from the computer, and transforms it into a DMX signal which is output through an RJ-45 connector.
- Computer transformer: This is the standard Mac Mini transformer. It plugs into the power splitter and brings power to the mini’s power input.
- Power splitter: This is used to ensure that a single power cable enters the sculpture. It goes to the power outlet and gives power to the computer and the sensors.
- to first dimmer pack: This XLR plug must make its way to the first dimmer pack using one of the provided cables.
- to power outlet: This is the plug through which the sculpture is to be powered, be it with American or European power.

Appendix IV – Chauvet dimmer pack manual

DMX-4 LED User Manual

It's Green Thinking

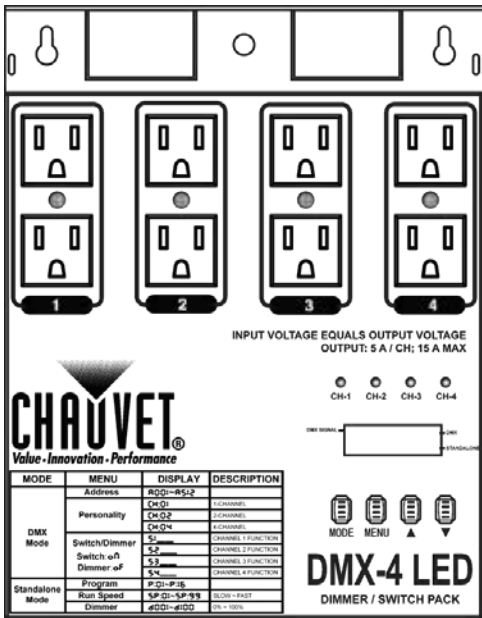

TABLE OF CONTENTS

1. BEFORE YOU BEGIN	3
WHAT IS INCLUDED	3
UNPACKING INSTRUCTIONS	3
MANUAL CONVENTIONS	3
ICONS	3
SAFETY INSTRUCTIONS	4
2. INTRODUCTION	5
PRODUCT OVERVIEW.....	5
3. SETUP	6
AC POWER.....	6
NOTES ON “SWITCH” OPERATION	6
CHANGING BETWEEN “DIMMER” AND “SWITCH”	6
MOUNTING.....	7
<i>Orientation</i>	7
<i>Rigging</i>	7
<i>Rigging</i>	8
4. OPERATING INSTRUCTIONS	9
CONFIGURING THE STARTING ADDRESS	9
DMX MODE.....	9
STANDALONE MODE	9
MENU MAP	9
DMX CHANNEL VALUES	10
<i>4-Channel Personality</i>	10
<i>2-Channel Personality</i>	10
<i>1-Channel Personality</i>	10
5. APPENDIX	11
GENERAL TROUBLESHOOTING	11
DMX PRIMER	12
FIXTURE LINKING (DAISY CHAIN)	12
DATA CABLING.....	12
<i>DMX Data Cable</i>	12
CABLE CONNECTORS	13
SETTING THE STARTING ADDRESS	13
<i>3-Pin to 5-Pin Conversion Chart</i>	14
<i>Setting up a DMX Daisy Chain</i>	14
GENERAL MAINTENANCE.....	15
RETURNS PROCEDURE	15
CLAIMS	15
TECHNICAL SPECIFICATIONS	16
CONTACT US	16

CHAUVET®, 2010, All Rights Reserved

Information and specifications in this User Manual are subject to change without notice.

CHAUVET® assumes no responsibility or liability for any errors or inaccuracies that may appear in this manual.

Author: Anthony Chiappone

Revision: 01

Release Date: 12-10-2010

1. BEFORE YOU BEGIN

What is included

- 1 x DMX-4 LED
- 1 x Power Cord
- 1 x Warranty Card
- 1 x User Manual

Unpacking Instructions

Immediately upon receiving a fixture, carefully unpack the carton, check the contents to ensure that all parts are present, and have been received in good condition. Notify the shipper immediately and retain packing material for inspection if any parts appear damaged from shipping or the carton itself shows signs of mishandling. Save the carton and all packing materials. In the event that a fixture must be returned to the factory, it is important that the fixture be returned in the original factory box and packing.



Manual Conventions

CHAUVET® manuals use the following conventions to differentiate certain types of information from the regular text.

CONVENTION	MEANING
[10]	A DIP switch to be configured
<Menu>	A key to be pressed on the fixture's control panel
1~512	A range of values
50/60	A set of values of which only one can be chosen
Settings	A menu option not to be modified (for example, showing the operating mode/current status)
MENU > Settings	A sequence of menu options to be followed
ON	A value to be entered or selected

Icons

This manual uses the following icons to indicate information that requires special attention on the part of the user.

ICONS	MEANING
	This paragraph contains critical installation, configuration or operation information. Failure to comply with this information may render the fixture partially or completely inoperative, cause damage to the fixture or cause harm to the user.
	This paragraph contains important installation or configuration information. Failure to comply with this information may prevent the fixture from functioning correctly.
	This paragraph reminds you of useful, although not critical, information.

Safety Instructions



Please read these instructions carefully. It includes important information about the installation, usage and maintenance of this product.

- Please keep this User Manual for future consultation. If you sell the unit to another user, be sure that they also receive this instruction booklet.
- Always make sure that you are connecting to the proper voltage, and that the line voltage you are connecting to is not higher than that stated on the decal or rear panel of the fixture.
- This product is intended for indoor use only! To prevent risk of fire or shock, do not expose fixture to rain or moisture.
- Make sure there are no flammable materials close to the unit while operating.
- The unit must be installed in a location with adequate ventilation, at least 20 in (50 cm) from adjacent surfaces. Be sure that no ventilation slots are blocked.
- Always disconnect from power source before servicing or replacing fuse and be sure to replace with same fuse source.
- Secure fixture to fastening device using a safety chain.
- Maximum ambient temperature (Ta) is 104° F (40° C). Do not operate fixture at temperatures higher than this.
- In the event of a serious operating problem, stop using the unit immediately. Never try to repair the unit by yourself. Repairs carried out by unskilled people can lead to damage or malfunction. Please contact the nearest authorized technical assistance center.
- Never connect the device to a dimmer pack.
- Make sure the power cord is never crimped or damaged.
- Never disconnect the power cord by pulling or tugging on the cord.
- Never carry the fixture directly from the cord. Always use the hanging/mounting bracket.
- Avoid direct eye exposure to the light source while it is on.

2. INTRODUCTION

Product Overview

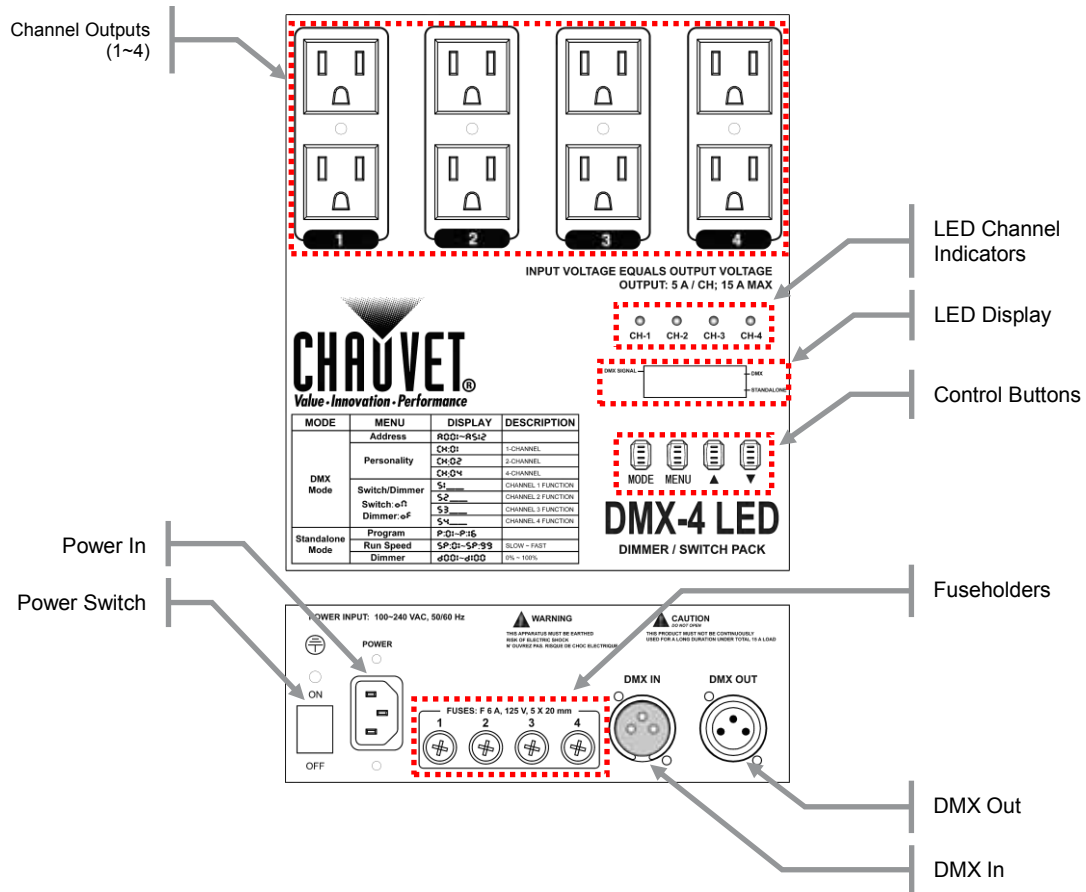

3. SETUP

AC Power

This fixture accepts an input of 100~240 VAC, 50/60 Hz. Before powering on the unit, make sure the line voltage to which you are connecting it is within the range of accepted voltages. Also make sure that the fixtures you are plugging into the DMX-4 LED match the input voltage.

Input voltage equals output voltage.

To determine the power requirements for a particular fixture, see the label affixed to the back plate of the fixture or refer to the fixture's specifications chart. A fixture's listed current rating indicates its average current draw under normal conditions.



Always connect the fixture to a switched circuit. Never connect the fixture to a rheostat (variable resistor) or dimmer circuit, even if the rheostat or dimmer channel is used only as a 0 to 100% switch.



Always connect the fixture to a circuit with a suitable electrical ground.

Notes on “Switch” Operation

Dimmer/switch packs are primarily intended for lamp-based PAR cans. Connecting a fixture equipped with an electronic (switching) power supply to a dimmer/pack switch may damage the fixture or make it work erratically.

The improved DMX-4 LED's design now allows you to switch on and off loads equipped with electronic power supplies, such as LED-based luminaries or laser fixtures. However, the DMX-4 LED must be in “switch” mode before connecting this type of loads to it. Please see the instructions on how to set the DMX-4 LED in switch mode below.



Always make sure that the DMX-4 LED is in switch mode before connecting a load equipped with an electronic power supply to it. Doing otherwise could damage the load.

Changing between “Dimmer” and “Switch”

The DMX-4 LED has two different methods for controlling the output of the four (4) channels. This must be set by the user via the control panel.

Please see the steps below for this procedure.

1. Unplug any units from the four output channels.
2. Plug the DMX-4 LED into power.
3. Press <MODE> until **ADD 1~AS 12** appears on the LED display.
4. Press <MENU> until **5 1**/52**/53**/54**** appears on the LED display. This setting can be set differently for each of the four channels. Navigate to the desired channel.
5. Using <UP> & <DOWN>, select either **on** or **oF**. **on** switches the channel to “switch” method. **oF** sets it into dimmer method.
6. Continue to set this for each of the 4 channels, using the process detailed in the steps above, until complete.

Mounting

Orientation

The DMX-4 LED may be mounted in any position, provided there is adequate room for ventilation.

Rigging

Be sure that the structure can support the weight of the fixture. Please see the "Technical Specifications" section of this manual for a detailed weight listing. Mount the fixture securely. This may be done with a screw, nut and bolt, or a hanging clamp. The hole in each bracket is 13 mm in size. When rigging consider routine maintenance and control panel access. Please see the following notes on installation.

- The back plate may be reversed for an alternate rigging configuration. See the section on the following page for details on how to do this.
- Safety cables must always be used.

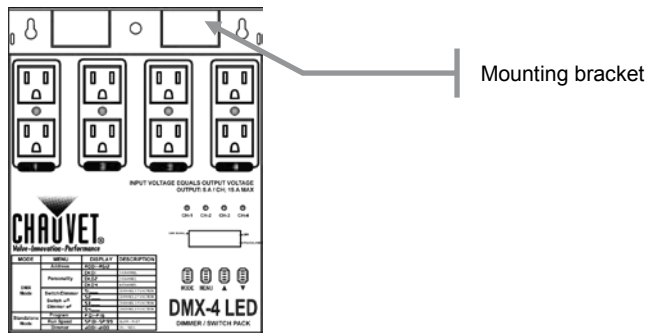

Rigging

The DMX-4 LED ships ready to mount a standard clamp directly to the mounting bracket. However, if you are using this product with truss or a lighting stand, then there is an alternate rigging configuration available. This option is ideal for hanging the product without using a hanging clamp.

Please see the steps below for further details.

1. Unplug power from the product.
2. On the back of the product, locate the six (6) Edison #2 screws.
3. Using a screwdriver, remove these.
4. The mounting bracket will now come off. Be careful not to damage the internal components of the dimmer, as they are exposed during this step!
5. Flip the mounting bracket (back panel) around.
6. Reattach the panel by securely installing the six (6) screws.

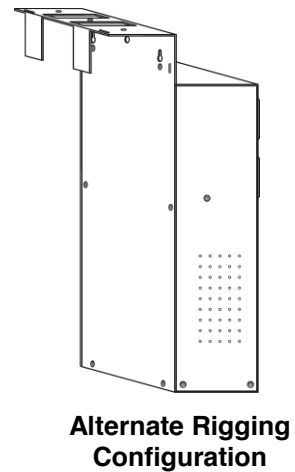
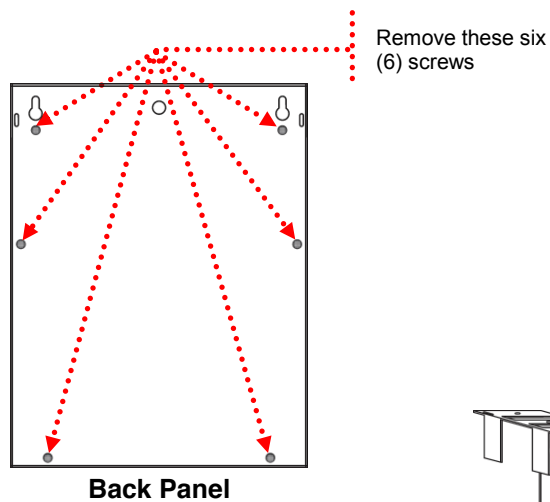

4. OPERATING INSTRUCTIONS

Configuring the Starting Address

The DMX-4 LED fixture uses up to **four** DMX channels. The highest channel that the fixture may be set to in order to function properly is **509**. Any address higher than this will prevent access to all of the channels.

If this is your first time using DMX, we recommend reading the “DMX Primer” section in the “Appendix”.

DMX Mode

This is the operating mode which will allow for control with an external DMX controller. You must set the starting address and personality for this mode.

Please see the instructions below.

1. Press **<MODE>** to switch between “DMX Mode” and “Standalone Mode”. Switch it to “DMX Mode”.
2. Press **<MENU>** until the LED display reads **CH=0 1~04**.
3. Using **<UP>** and **<DOWN>**, select one of the three personalities.
4. Press **<MENU>** until the LED display reads **A=00 1~A=5 12**.
5. Using **<UP>** and **<DOWN>**, select the DMX starting address.

Standalone Mode

This fixture has built-in auto programs with adjustable settings.

Please see the instructions below.

1. Press **<MODE>** to switch between “DMX Mode” and “Standalone Mode”. Switch it to “Standalone Mode”.
2. Press **<MENU>** until the LED display reads **P=0 1~P= 16**.
3. Using **<UP>** and **<DOWN>**, select one of the programs.
4. Press **<MENU>** until the LED display reads **SP=0 1~SP=99**.
5. Using **<UP>** and **<DOWN>**, select the desired run speed.
6. Press **<MENU>** until the LED display reads **d=00 1~d= 100**.
7. Using **<UP>** and **<DOWN>**, select the desired dimmer level for the program currently running.

Menu Map

MODE	MENU	DISPLAY	DESCRIPTION	
DMX Mode	Starting address	A00 1~A5 12		
	Personality	CH=0 1	1-channel mode	
		CH=02	2-channel mode	
		CH=04	4-channel mode	
	Switch/Dimmer	Switch: o n	5 1..	Channel 1 function
			52..	Channel 2 function
		Dimmer: o F	53..	Channel 3 function
54..			Channel 4 function	
Standalone Mode	Program	P=0 1~P= 16		
	Run speed	SP=0 1~SP=99		
	Dimmer	d00 1~d 100	Slow~fast	

DMX Channel Values

4-Channel Personality

In this DMX personality, the four channels will be controlled by separate DMX channels.

CHANNEL	VALUE	FUNCTION
1	000 ⇔ 255	Dimmer 0%~100%
2	000 ⇔ 255	Dimmer 0%~100%
3	000 ⇔ 255	Dimmer 0%~100%
4	000 ⇔ 255	Dimmer 0%~100%

2-Channel Personality

In this DMX personality, the four channels will be grouped into pairs. Channels 1+2 will be controlled by DMX channel 1, while channels 3 + 4 will be controlled by DMX channel 2.

CHANNEL	VALUE	FUNCTION
1	000 ⇔ 255	Dimmer 0%~100%
2	000 ⇔ 255	Dimmer 0%~100%

1-Channel Personality

In this DMX personality, the four channels will be grouped together. Channels 1+2+3+4 will all be controlled by DMX channel 1.

CHANNEL	VALUE	FUNCTION
1	000 ⇔ 255	Dimmer 0%~100%

5. APPENDIX

General Troubleshooting

SYMPTOM	POSSIBLE CAUSE(S)	POSSIBLE ACTION(S)
Breaker/Fuse keeps blowing	<ul style="list-style-type: none"> Excessive circuit load Short circuit along the power wires 	<ul style="list-style-type: none"> Check total load placed on the electrical circuit. Check for a short in the electrical wiring (internal and/or external).
Device does not power up	<ul style="list-style-type: none"> No power Loose power cord 	<ul style="list-style-type: none"> Check for power on Mains. Check power cord
Fixture is not responding to DMX	<ul style="list-style-type: none"> Wrong DMX addressing Damaged DMX cables Wrong polarity settings on the controller Loose DMX cables Faulty DMX interface Faulty Main PCB 	<ul style="list-style-type: none"> Check Control Panel and unit addressing Check DMX cables Check polarity switch settings on the controller Check cable connections Replace DMX input Replace Main PCB
Loss of signal	<ul style="list-style-type: none"> Non DMX cables Bouncing signals Long cable / Low level signal Too many fixtures Interference from AC wires 	<ul style="list-style-type: none"> Use only DMX compatible cables Install terminator as suggested. Install amplifier right after fixture with strong signal. Install an optically coupled DMX splitter after unit #32. Keep DMX cables separated from power cables or black lights.



If you still have a problem after trying the above solutions, please contact CHAUVET® Technical Support.

DMX Primer

There are 512 channels in a DMX connection. A fixture capable of receiving DMX will require one or a number of sequential channels. The user must assign a starting address on the fixture that indicates the first channel reserved in the controller. There are many different types of DMX controllable fixtures and they all may vary in the total number of channels required. Choosing a start address should be planned in advance. Channels should never overlap. If they do, this will result in erratic operation of the fixtures whose starting address is set incorrectly. You can however, control multiple fixtures of the same type using the same starting address as long as the intended result is that of unison movement or operation. In other words, the fixtures will all respond exactly the same.

DMX fixtures are designed to receive data through a daisy chain. A daisy chain connection is where the DATA OUT of one fixture connects to the DATA IN of the next fixture. The order in which the fixtures are connected is not important and has no effect on how a controller communicates to each fixture. Use an order that provides for the easiest and most direct cabling. Connect fixtures using shielded two conductor twisted pair DMX data cable with three pin XLR male to female connectors. The shield connection is pin 1, while pin 2 is Data Negative (S-) and pin 3 is Data positive (S+).

Fixture Linking (Daisy Chain)

You will need a daisy chain to run light shows of one or more fixtures using a DMX controller or to run synchronized shows on two or more fixtures set to a master/slave operating mode. The combined number of channels required by all the fixtures on a daisy chain determines the number of fixtures the data link can support.



To comply with the EIA-485 standard, do not connect more than 32 fixtures on one daisy chain. Connecting more than 32 fixtures on one daisy chain without the use of a DMX optically-isolated splitter may result in deterioration of the digital DMX signal.

*Maximum recommended cable distance: 500 m (1640 ft)
Maximum recommended number of fixtures on a daisy chain: 32*

Data Cabling

To link fixtures together you must obtain data cables. You can purchase CHAUVET® certified DMX cables directly from a dealer/distributor or construct your own cable. If you choose to create your own cable please use data-grade cables that can carry a high quality signal and are less prone to electromagnetic interference.

DMX Data Cable

Use a Belden© 9841 or equivalent cable which meets the specifications for EIA RS-485 applications. Standard microphone cables cannot transmit DMX data reliably over long distances. The cable must have the following characteristics:

Type:	<i>shielded, 2-conductor twisted pair</i>
Maximum capacitance between conductors:	<i>30 pF/ft</i>
Maximum capacitance between conductor and shield:	<i>55 pF/ft</i>
Maximum resistance:	<i>20 ohms/1000 ft</i>
Nominal impedance:	<i>100 ~ 140 ohms</i>

Cable Connectors

Cabling must have a male XLR connector on one end and a female XLR connector on the other end.

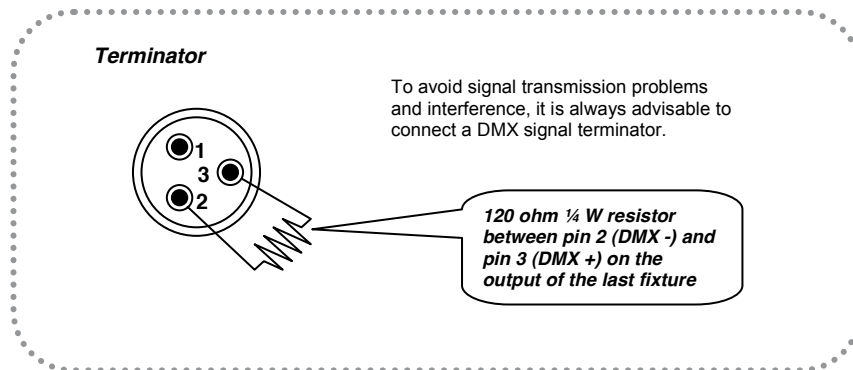
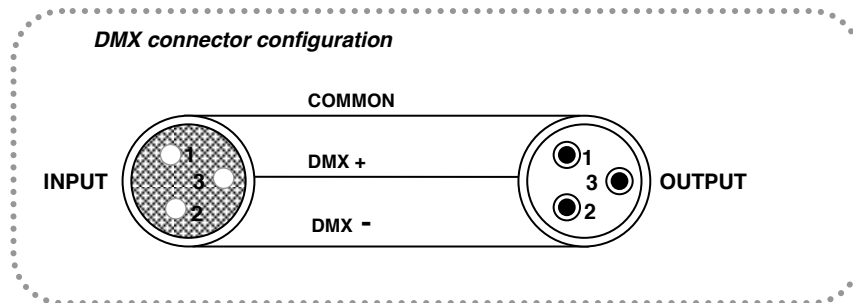

Do not allow contact between the common and the fixture's chassis ground. Grounding the common can cause a ground loop, and your fixture may perform erratically. Test cables with an ohm meter to verify correct polarity and to make sure the pins are not grounded or shorted to the shield or each other.

Setting the Starting Address

This DMX mode enables the use of a universal DMX controller device. Each fixture requires a start address from 1~512. A fixture requiring one or more channels for control begins to read the data on the channel indicated by the start address. For example, a fixture that uses six DMX channels and was addressed to start on DMX channel 100, would read data from channels: 100, 101, 102, 103, 104, and 105. Choose start addresses so that the channels used do not overlap, and note the start address selected for future reference.

If this is your first time addressing a fixture using the DMX control protocol, we suggest jumping to the "Appendix" section and reading the heading "DMX Primer". It contains very useful information that will help you understand its use.

3-Pin to 5-Pin Conversion Chart



If you use a controller with a 5-pin DMX output connector, you will need to use a 5-pin to 3-pin adapter. The chart below details a proper cable conversion:

3-PIN TO 5-PIN CONVERSION CHART

Conductor	3-Pin Female (Output)	5-Pin Male (Input)
Ground/Shield	Pin 1	Pin 1
Data (-) signal	Pin 2	Pin 2
Data (+) signal	Pin 3	Pin 3
Not used		Pin 4
Not used		Pin 5

Setting up a DMX Daisy Chain

1. Connect the (male) 3-pin connector side of the DMX cable to the output (female) 3-pin connector of the controller.
2. Connect the end of the cable coming from the controller which will have a (female) 3-pin connector to the input connector of the next fixture consisting of a (male) 3-pin connector.
3. Then, proceed to connect from the output as stated above to the input of the following fixture and so on.

Universal DMX Controller

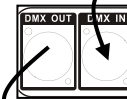
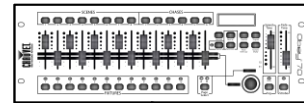

This drawing provides a general illustration of the DMX input/output panel of a lighting fixture.

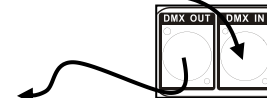

Continue the link

General Maintenance

To maintain optimum performance and minimize wear, fixtures should be cleaned frequently. Usage and environment are contributing factors in determining frequency. As a general rule, fixtures should be cleaned at least twice a month. Dust build up reduces light output performance and can cause overheating. This can lead to reduced lamp life and increased mechanical wear. Be sure to power off fixture before conducting maintenance.

- Unplug fixture from power.
- Use a vacuum or air compressor and a soft brush to remove dust collected on external vents.
- Clean all lenses when the fixture is cool with a mild solution of glass cleaner or Isopropyl Alcohol and a soft lint free cotton cloth or lens tissue.
- Apply solution to the cloth or tissue and drag dirt and grime to the outside of the lens.
- Gently polish optical surfaces until they are free of haze and lint.



Always dry the parts carefully after cleaning them.



Never spin a fan using compressed air.

Returns Procedure

Returned merchandise must be sent prepaid and in the original packing; call tags will not be issued. Package must be clearly labeled with a Return Merchandize Authorization Number (RMA #). Products returned without the RMA # will be refused. Call CHAUVET® and request an RMA # prior to shipping the fixture. Be prepared to provide the model number, serial number and a brief description of the cause for the return. Be sure to pack fixture properly; any shipping damage resulting from inadequate packaging is the customer's responsibility. As a suggestion, proper UPS packing or double-boxing is always a safe method to use. CHAUVET® reserves the right to use its own discretion to repair or replace product(s).



If you are given an RMA #, please include the following information on a piece of paper inside the box:

- 1) ***Your name***
- 2) ***Your address***
- 3) ***Your phone number***
- 4) ***The RMA #***
- 5) ***A brief description of the symptoms***

Claims

Damage incurred in shipping is the responsibility of the shipper; therefore, the damage must be reported to the carrier upon receipt of merchandise. It is the customer's responsibility to notify and submit claims with the shipper in the event that a fixture is damaged due to shipping. Any other claim for items such as missing component/part, damage not related to shipping, and concealed damage, must be made within seven (7) days of receiving merchandise.

TECHNICAL SPECIFICATIONS

WEIGHT & DIMENSIONS

Length..... 8.3 in (210 mm)
Width..... 7.7 in (194 mm)
Height..... 2.8 in (70 mm)
Weight..... 5 lbs (2.2 kg)

POWER

Input power..... 100~240 VAC, 50/60 Hz
Output voltage to fixtures..... Input voltage equals output voltage
Output current (max per channel)..... 5 A
Output current (max total)..... 15 A
Fuse size..... F 6 A, 250 V

INDOOR/OUTDOOR

Rating..... For indoor use only

THERMAL

Maximum ambient temperature..... 104° F (40° C)

CONTROL & PROGRAMMING

Data input..... locking 3-pin XLR female socket
Data output..... locking 3-pin XLR male socket
Data pin configuration..... pin 1 shield, pin 2 (-), pin 3 (+)
Protocol..... DMX-512 USITT
DMX Channels (user-configurable)..... 1, 2, 4

ORDERING INFORMATION

DMX-4 LED..... DMX4LED

WARRANTY INFORMATION

Warranty..... 2-year limited warranty

CONTACT US

WORLD WIDE

General Information..... CHAUVET®
5200 NW 108th Ave
Sunrise, FL 33351
voice: 954-929-1115
fax: 954-929-5560
toll free: 800-762-1084

Technical Support..... CHAUVET®
5200 NW 108th Ave
Sunrise, FL 33351
voice: 954-929-1115 (Press 4)
fax: 954-929-5560 (Attention: Service)

World Wide Web..... <http://www.chauvetlighting.com>

Appendix V – Images

preferred light bulb:

Produktkataloge / Philips Lighting / Lampen / Allgemeinleuchtlampen / Standardlampen (T/A/E-Form) / Standard A-shape klar



Standard 300W E27 230V A88 CL 1CT
Artikelnummer: 09979205
EAN: 8711500099792

Lampe:

- Konventionelle, birnenförmige Glühlampen

Eigenschaften:

- Klare Glühlampen setzen brillante Effekte

Anwendungen:

- Ein umfangreiches Anwendungsgebiet zeichnet diese Lampen der Standardreihe aus

Eigenschaften	
Lampenleistung	300
Farbwiedergabeindex	100
Sockel	E27
Kolbenform	A88
Spannung ?	230
Kolbenausführung	Klar
Brennstellung	Beliebig
Lichtstrom ?	4850

Preis auf Anfrage

Downloads
▶ Allgemeines



ordering code: 099792 05

PHILIPS

Standard 300W E27 230V
A88 CL 1CT

300W

SKU 9201 405 44208

20 Lamps
1 CT/20

9201 405 44208

EAN1 8711500099792

CE

E27

MADE IN POLAND

Barcode: 0 87 11500 10931 1

ID 0450



installation shots:
http://lozano-hemmer.com/pulse_room.php

